



# CLASSIC



10704



Warning! Choking hazard. Small parts.  
Achtung! Erstickungsgefahr. Kleine Teile.  
Attention ! Danger d'étouffement. Petits éléments.  
Avvertenza! Rischio di soffocamento. Piccole parti.  
Waarschuwing! Verstikkingsgevaar. Kleine onderdelen.  
¡Advertencia! Peligro de atragantamiento. Partes pequeñas.  
Advarsel! Kvælningsfare. Små dele.  
Viðvörðun! Kófnunarhætta. Litlir hlutir.  
Varoitus! Tukehtumisvaara. Pieniä osia.  
Varning! Kvävningrisk. Små delar.  
Advarsel! Kvelningsfare. Små deler.  
Atenção! Risco de asfixia. Pequenas partes.  
Προειδοποίηση! Κίνδυνος πνιγμού. Μικρά μέρη.  
警告! 窒息の危険性。小さな部品。  
警告! 小心窒息。当心小物件。  
경고! 질식 위험. 작은 부품 포함.  
Внимание! Риск удушения. Мелкие детали.  
Ostrzeżenie! Niebezpieczeństwo udławienia się. Małe części.  
Upozornění! Nebezpečí zalknutí. Malé části.  
Upozornenie! Nebezpečenstvo dusenia. Malé časti.  
Figyelmeztetés! Fulladásveszély. Kis alkatrészek.  
Обережно! Ризик задухи. Дрібні деталі.  
Urozorenje! Opasnost od gušenja. Mali dijelovi.  
Упозорење! Опасност од гушења. Мали делови.  
Предупредување! Опасност од задушвање. Мали делови.  
Oporozorilo! Nevarnost zadušitve zaradi tujka. Majhni deli.  
Avertisment! Pericol de sufocare internă. Părți mici.  
Внимание! Опасност от задавяне. Малки части.  
Brīdinājums! Aizrīšanās risks. Sīkas detaļas.  
Hoiatus! Kägistamisoho. Väikesed osad.  
İspējimas! Pavojus užspringti. Smulkios detalės.  
Uyarı! Boğulma Tehlikesi (Havasızlıktan). Küçük Parçalar.  
تحذیر! خطر الاختناق. أجزاء صغيرة.  
Peringatan! Bahaya tersedak. Bagian kecil.  
Amaran! Bahaya tercekik. Bahagian kecil.



**WARNING: CHOKING HAZARD.**  
Small parts. Not for children under 3 years.



**AVERTISSEMENT : RISQUE D'ÉTOUFFEMENT.**  
Contient des petites pièces. Ne convient pas aux enfants de moins de 3 ans.



**ADVERTENCIA: PELIGRO DE ASFIXIA.**  
No recomendado para niños menores de 3 años. Contiene piezas pequeñas.

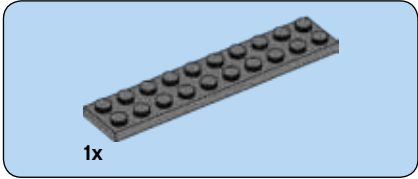

1

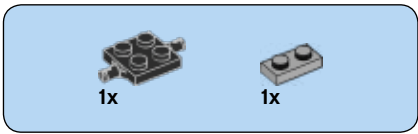
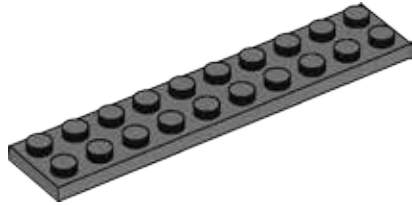

2

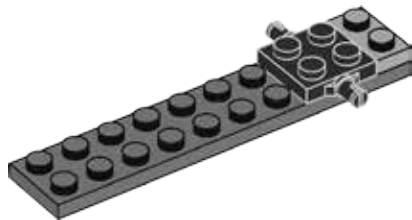

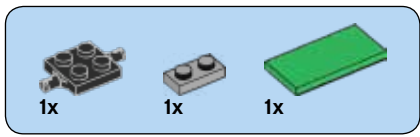

3

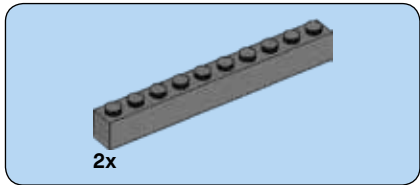
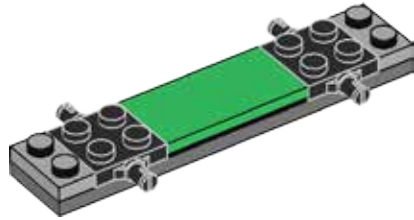

4

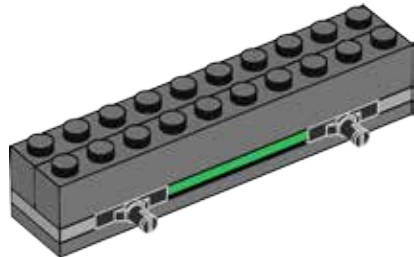

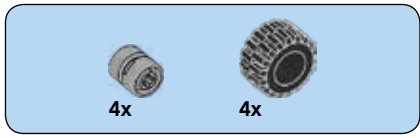

5

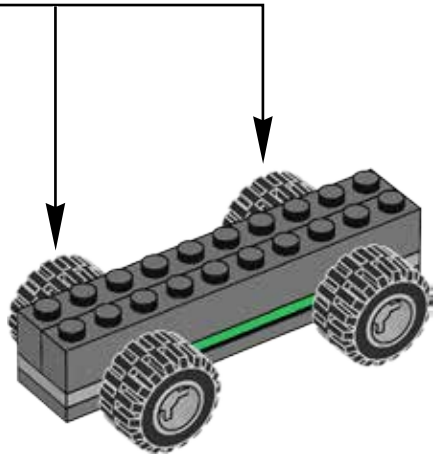
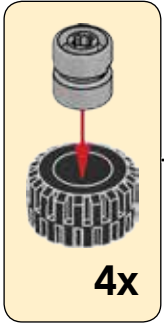

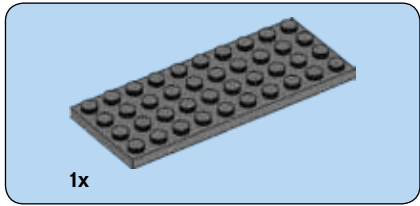

6



7

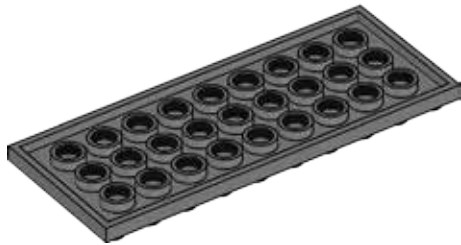

2x

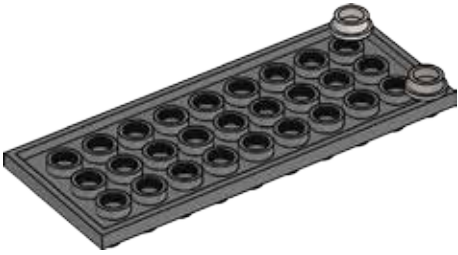

8

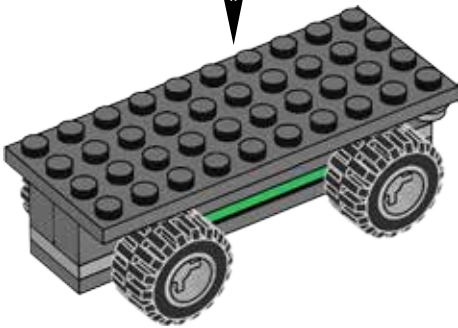

9



2x

10

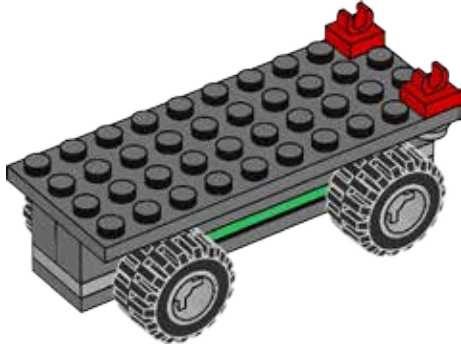

3x

11

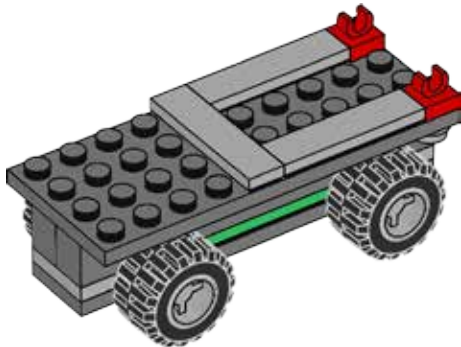



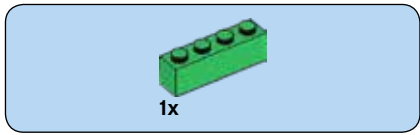

12

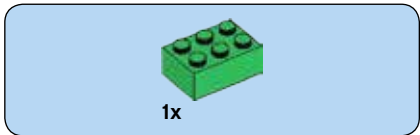
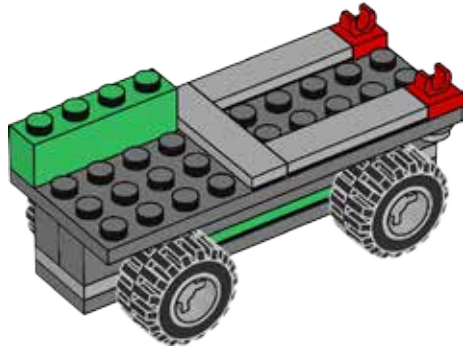

13

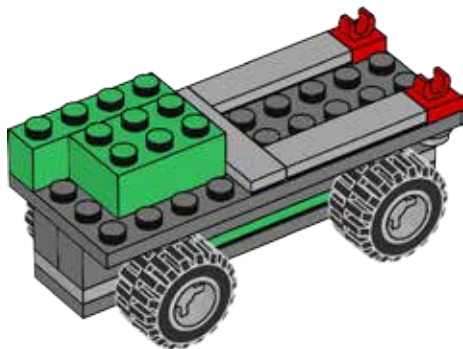



# 14

1



2



3



4



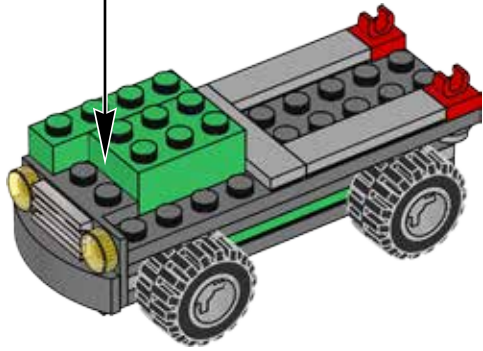



15

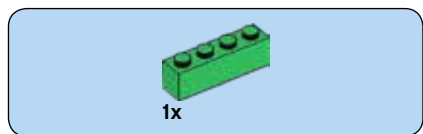
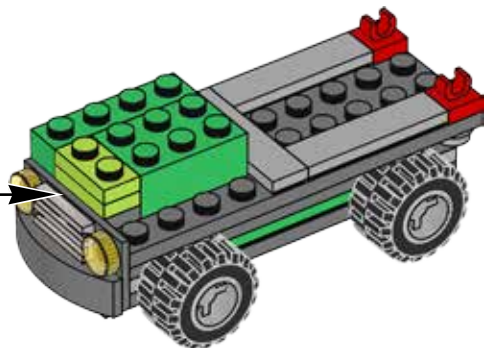
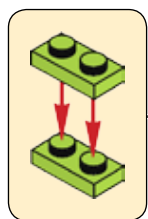

16

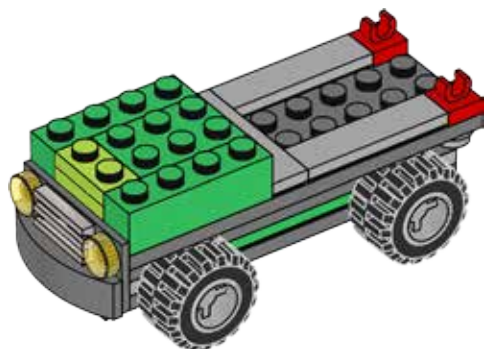

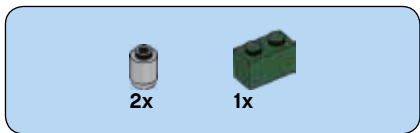

17

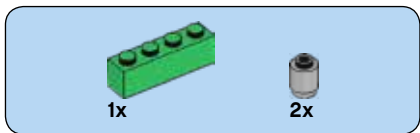
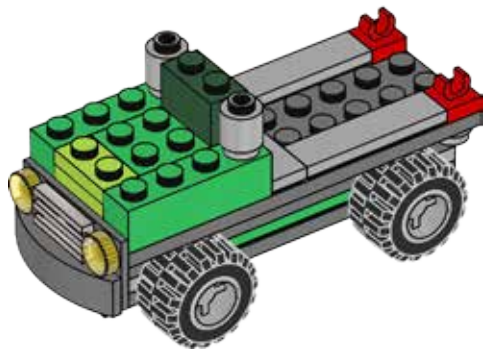

18

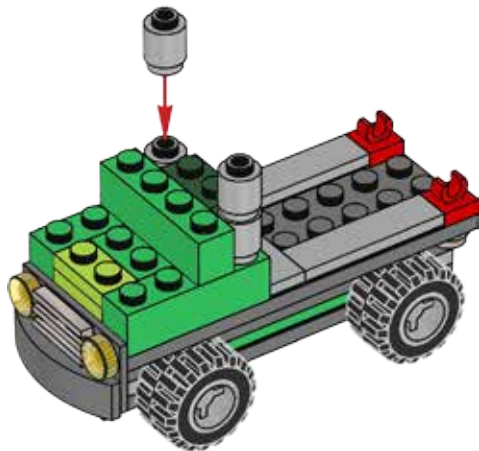

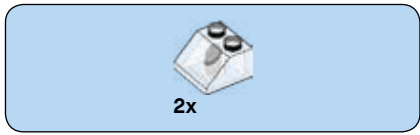

19

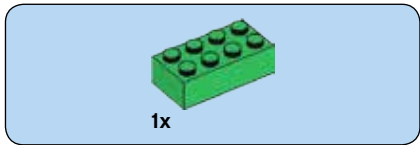
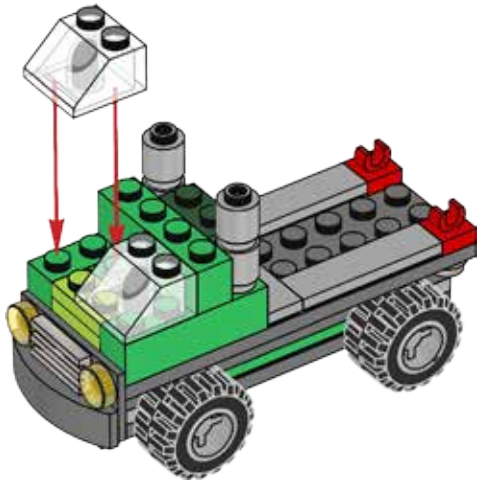

20

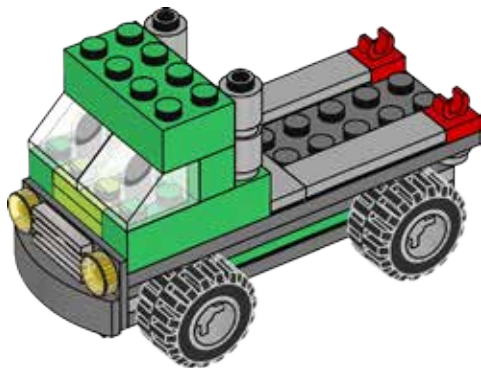

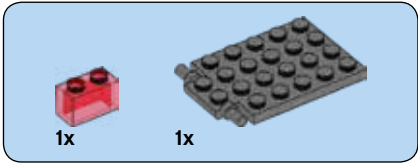
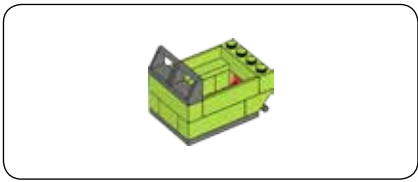

21

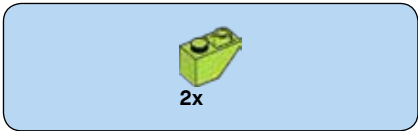

22

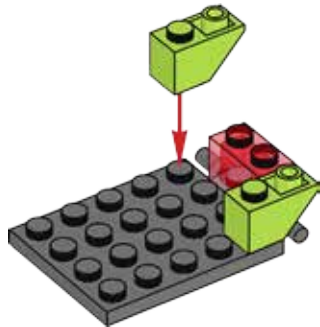

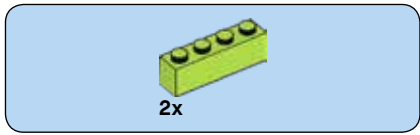

23

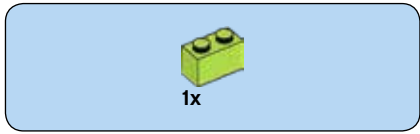
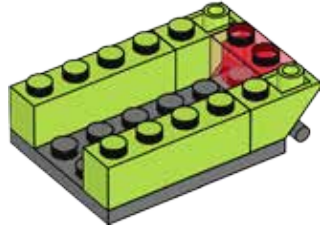

24

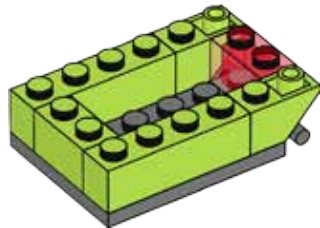



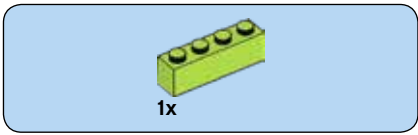

25

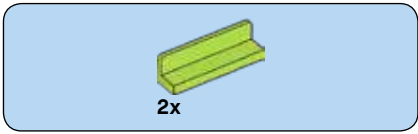
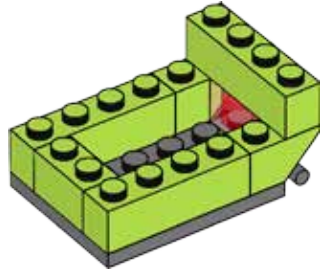

26

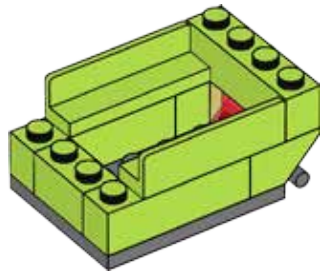

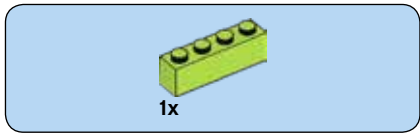

27

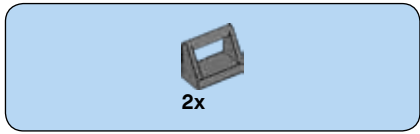
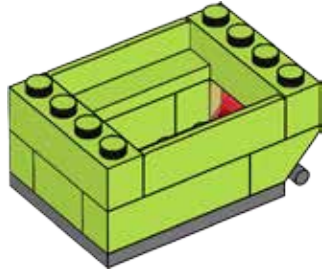

28

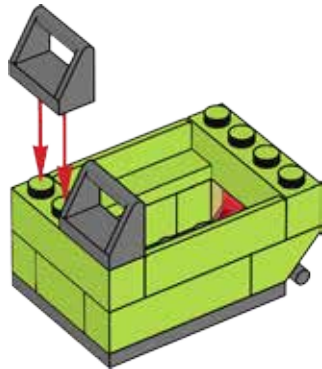

29

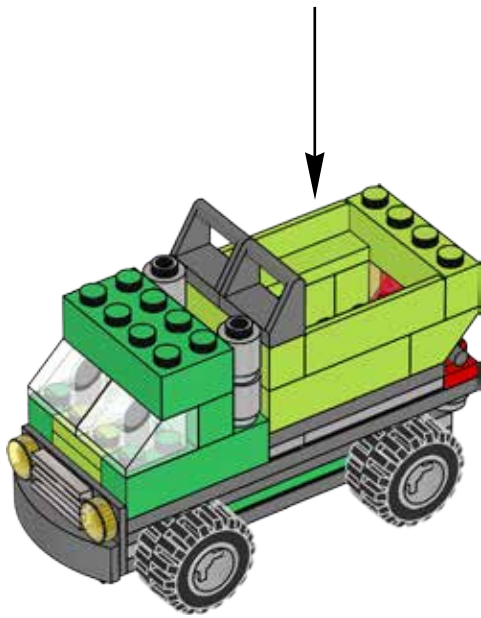

30

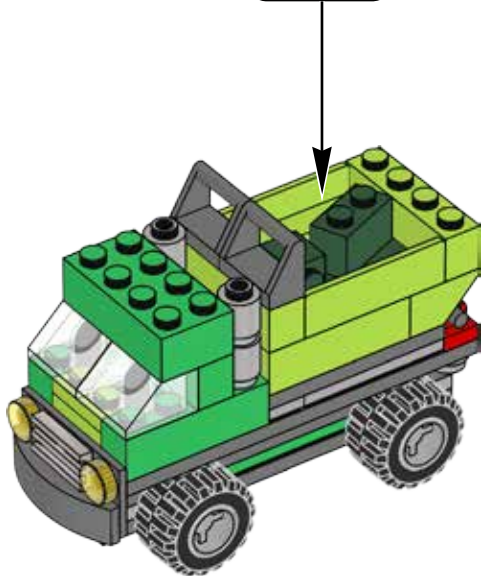
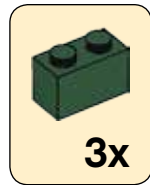



LEGO and the LEGO logo are trademarks of the/sont des marques de commerce du/son marcas registradas de LEGO Group. ©2017 The LEGO Group.