

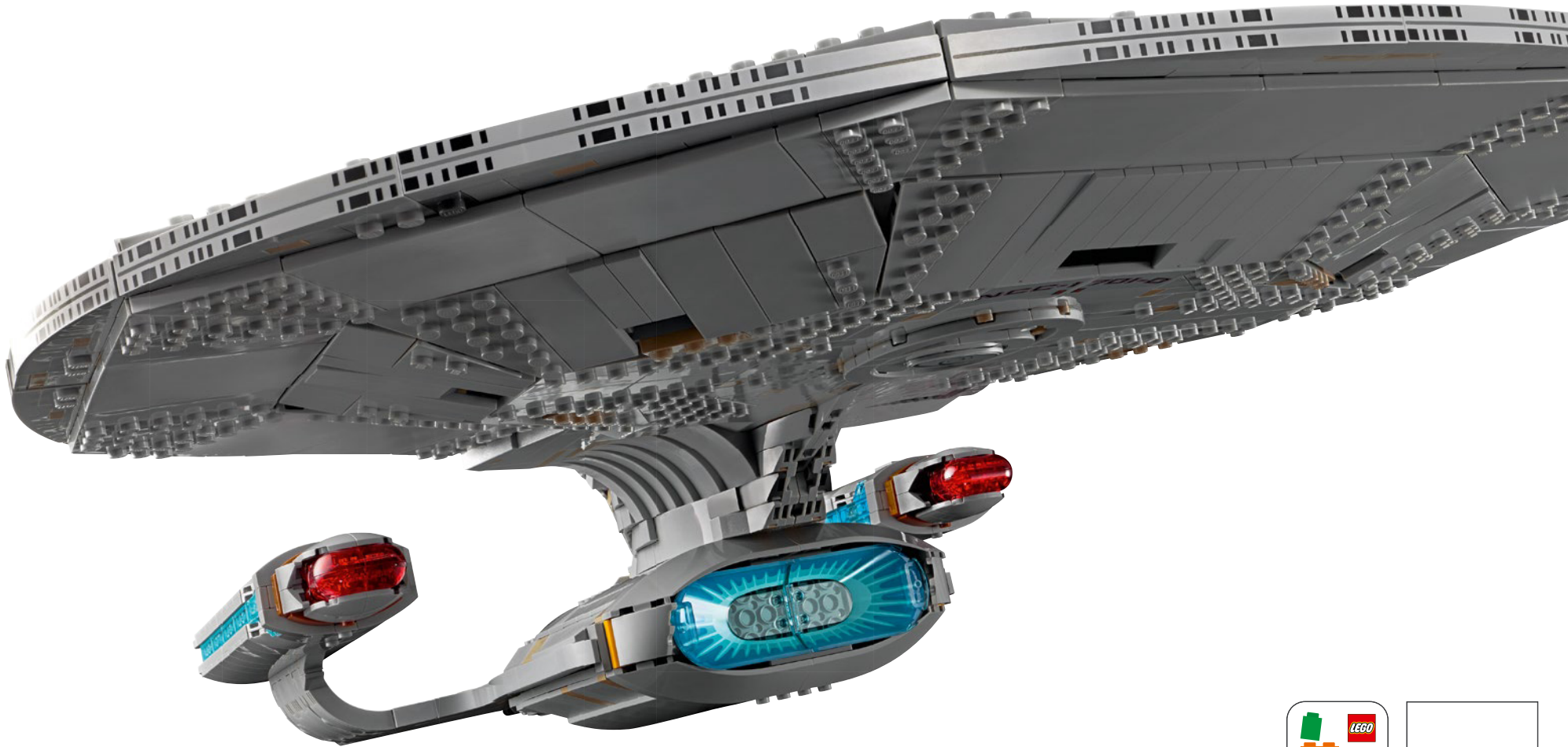

10356 | 1

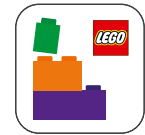

Booklet available in English
Heft in deutscher Sprache erhältlich
Livret disponible en français
Libretto disponibile in italiano
Folleto disponible en español
如需中文版手册



LEGO® Builder

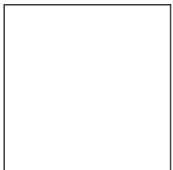



LEGO.com/sustainable-packaging



FR
**DONNEZ
OU
RECYCLEZ**



OU



OU



ASSOCIATION MAGASIN DÉCHÈTERIE

Adresses sur quefairedemesdechets.fr



BUILDER



Apple and the Apple logo are trademarks of Apple Inc., registered in the U.S. and other countries and regions. App Store is a service mark of Apple Inc. Google Play and the Google Play logo are trademarks of Google LLC. Tencent and the Tencent logo are trademarks of Tencent Inc.

LEGO.com/devicecheck



LEGO® Builder

// Space: the final frontier. These are the voyages of the Starship Enterprise.
Its continuing mission: to explore strange new worlds; to seek out new life
and new civilisations; to boldly go where no one has gone before. //

YOU HAVE THE BRIDGE

■ Set in the 24th century, *Star Trek: The Next Generation* (1987-1994) charted a bold new course in the *Star Trek* universe – all in the spirit of the original series. With Captain Jean-Luc Picard at the helm, the diverse crew aboard the *U.S.S. Enterprise NCC-1701-D™* discovers extraordinary new worlds and faces legendary foes. As representatives for the United Federation of Planets, their goal is to promote and evolve peaceful, diplomatic coexistence with civilisations everywhere. Through their hopeful vision of the future, and innovative technology, the show, the starship and its crew have inspired generations of *Star Trek* fans.

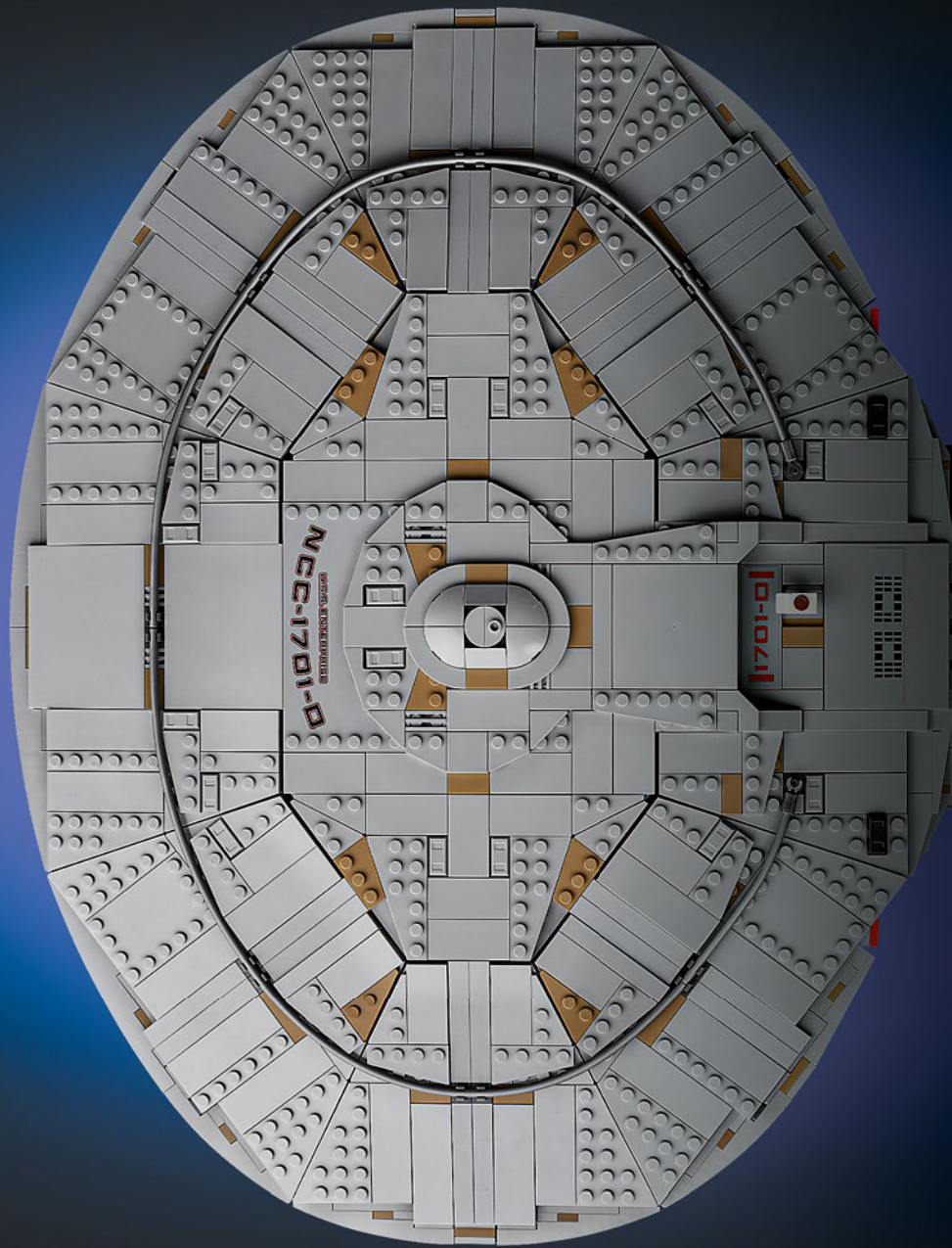

THE FIRST-EVER LEGO® STAR TREK MODEL

■ As one of the longest-running sci-fi franchises on TV and in movies, *Star Trek* has earned its iconic status in the genre. *Starship Enterprise* models have always been fan-favourite collectables, and we are beyond excited to welcome this version, for the first time ever, to the LEGO® Icons collection. Without further ado, BOLDLY GO! as we present the *U.S.S. Enterprise NCC-1701-D™*.



A STAR IN *STAR TREK* HISTORY

■ The *U.S.S. Enterprise NCC-1701-D™*, Starfleet's *Galaxy*-class flagship, carries a legacy that spans centuries. In *Star Trek* history, it has always been a beacon of exploration and diplomacy. It is the sixth starship to bear the legendary name *Enterprise* on its hull, honouring a tradition dating back to old naval ships, and even the first space shuttle. Launched from Mars in 2363, it was fine-tuned at Earth Station McKinley before Captain Jean-Luc Picard took command.



FAMOUS MISSIONS

■ Encounter at Farpoint, Parts I & II

Its inaugural mission led the Enterprise-D to the mysterious Farpoint Station and the crew's first contact with the Q Continuum.

■ The Inner Light

Rendered unconscious by an alien probe, Picard 'lives out' a lifetime as Kamin, a native of the long-destroyed world of Kataan.

■ Unification, Parts I & II

Suspecting that Ambassador Spock has gone rogue and defected to the Romulan Empire, Picard and Data go undercover on Romulus

■ All Good Things...

In the series finale, the crew travels through time to prevent a cosmic anomaly, reflecting on past and future events to save humanity.

BEHIND THE SCENES

■ The TV series' Senior Consulting Illustrator, talented artist Andrew Probert, crafted the look of the *U.S.S. Enterprise-D*. His futuristic vision reflected the imagined advancements in space travel a century after the events of the original series. Probert's sleek design featured a larger saucer section, and repositioned warp nacelles closer to the ship's centre of mass for balance. Series creator Gene Roddenberry tweaked the design slightly, including extending the nacelles and placing the bridge on top of the saucer for scale.

SPECS	
CONSTRUCTION: Utopia Planitia Fleet Yards
LENGTH: 641 m (2,103 ft.)
DECKS: 42
CREW COMPLEMENT:	.. 1,014 (typical)
MAXIMUM WARP: 9.9
ARMAMENTS: Phasers and photon torpedoes



ENGAGE!

■ Aboard the *U.S.S. Enterprise-D*, the crew – human as well as other species, both organic and mechanical – is united in the pursuit of knowledge, justice and peace. Their unique backgrounds, passions, wit and perspectives contribute to an environment where collaboration, curiosity and respect can bridge any divide. The *Next Generation* envisions a future where equality and reason triumph, inspiring us to embrace differences and learn from one another for the good of all.

"Let's make sure history never forgets the name... Enterprise."



Captain Jean-Luc Picard

"I am superior, sir, in many ways, but I would gladly give it up to be human."



Lieutenant Commander Data

"I am Klingon! If you doubt it, a demonstration can be arranged."



Lieutenant Worf

"The unexpected is our normal routine."



Commander William Riker

"Would you like to talk about what's bothering you, or would you like to break some more furniture?"



Counsellor Deanna Troi

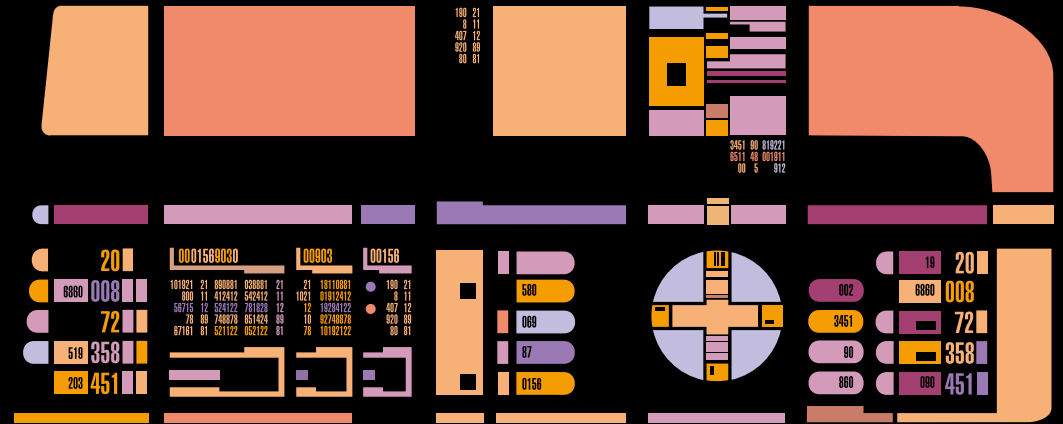

"... it's the struggle that is important. That's what helps us define our place in the universe."



Dr. Beverly Crusher

"There's theory and then there's application. They don't always jibe."



Lieutenant Commander Geordi La Forge

"My name is Guinan. I tend bar and I listen."



Guinan

"This is all just beginning; We've only charted 19% of our galaxy. The rest is out there just waiting."



Wesley Crusher



FROM THE LEGO® ICONS DESIGN TEAM

■ We wanted a model of substantial size that could balance on a single display stand arm. The shape of the primary hull (the 'saucer section') was designed with angled panels that add density to the disc; and to get its oval shape right, we developed two new LEGO® bow elements. The two warp engines, connected to thin, curved pylons, and the attachment of the detachable saucer disc was another challenge in terms of model stability. But the saucer separation function,

although rarely used in the series, is such a key feature. We applied sideways building with plates, especially in the 'neck' area, to achieve the right sturdiness. The original filming model is covered with windows – even on the underside! Here, they are printed on the saucer section's rim. And as a finishing touch, we paid special attention to the ship's navigational deflector to find the best look for the windscreen element's geometry.

"Recreating a starship that means so much to generations of *Star Trek* fans in LEGO® form was an exciting technical design challenge!"

The LEGO® Icons Design Team

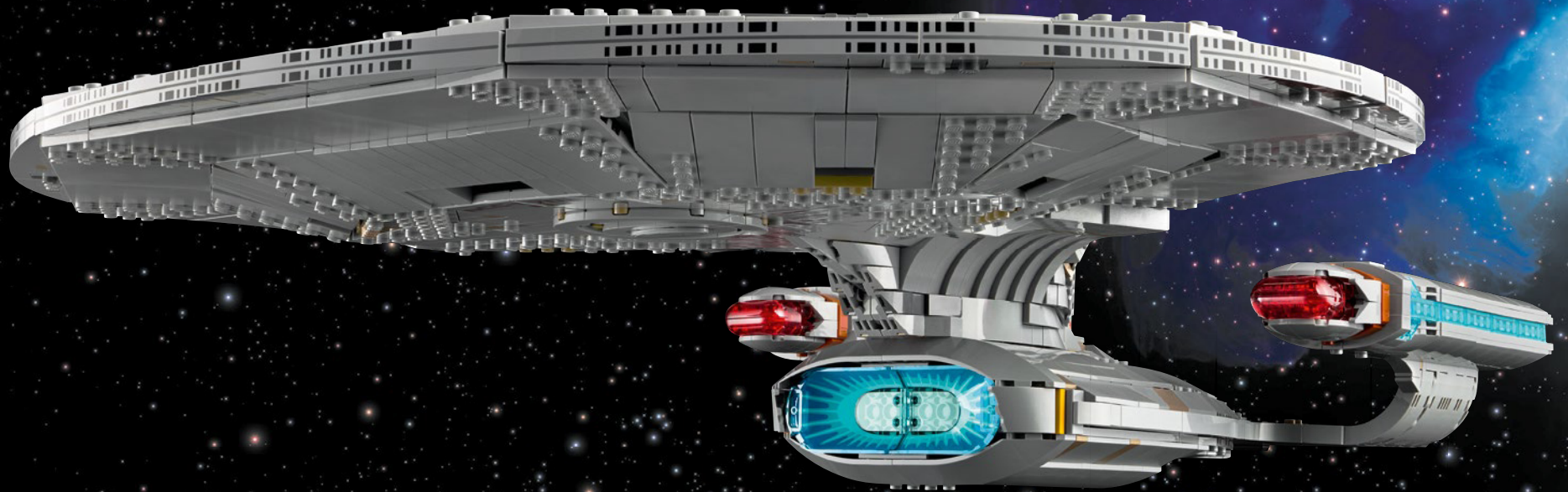

HOW TO HOLD THE MODEL

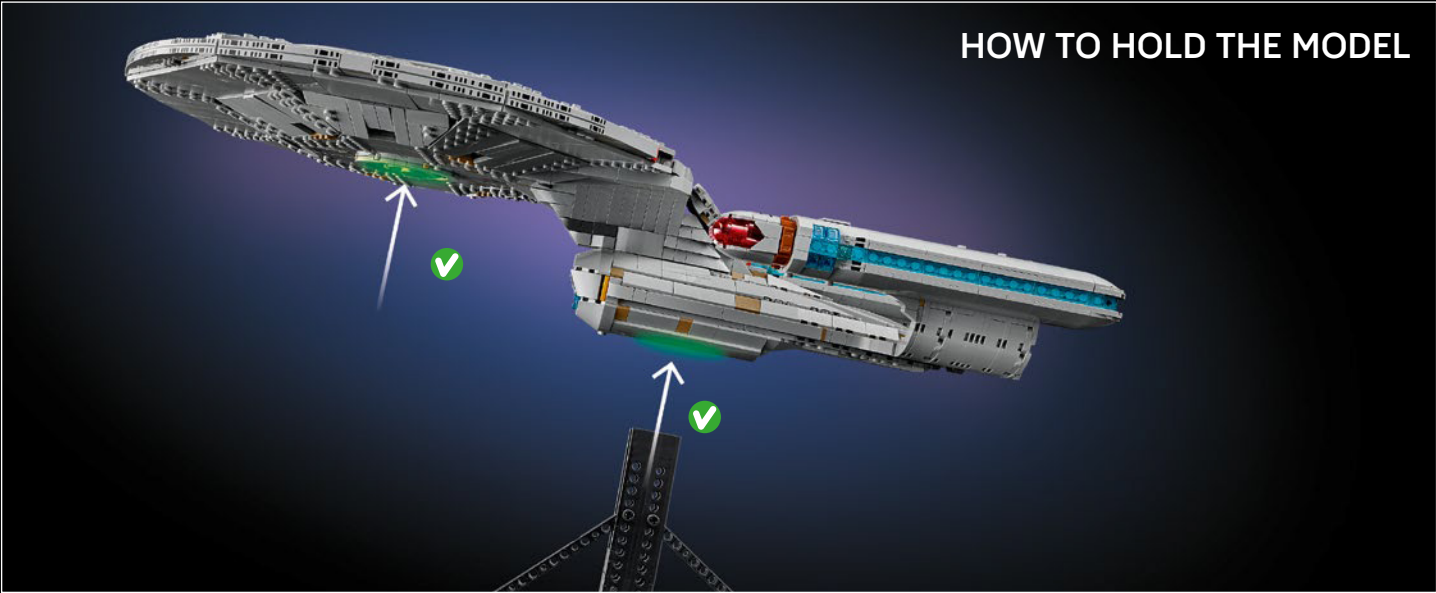

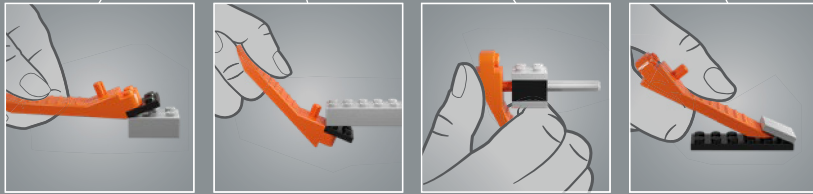
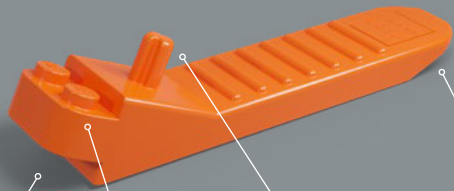

As the *Enterprise's* chief medical officer, Doctor Beverly Crusher always carries her Medical Tricorder with her.

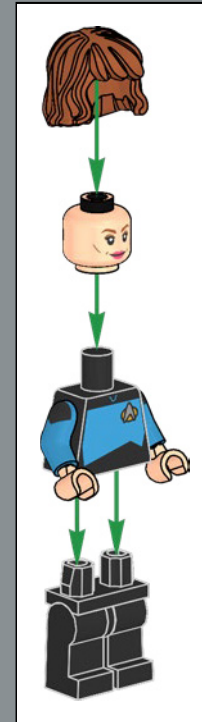

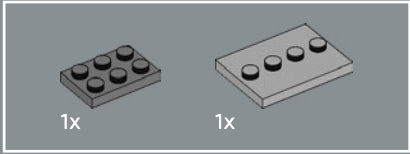
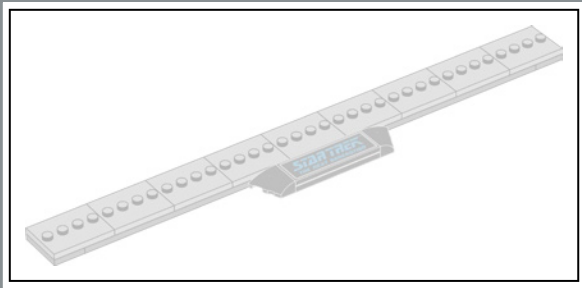

1

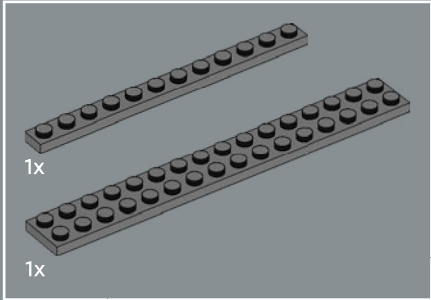
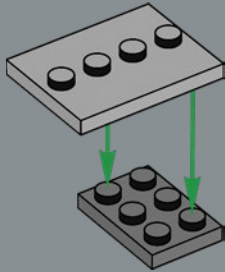

2

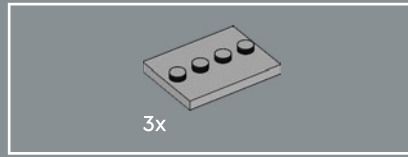
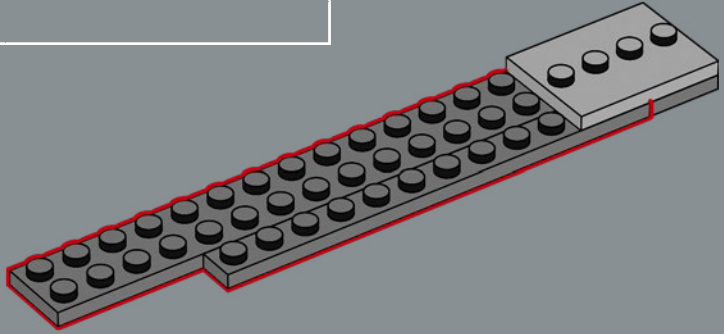

3

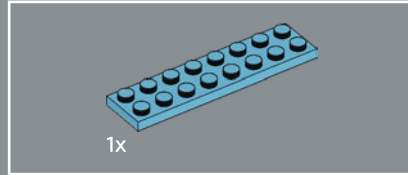
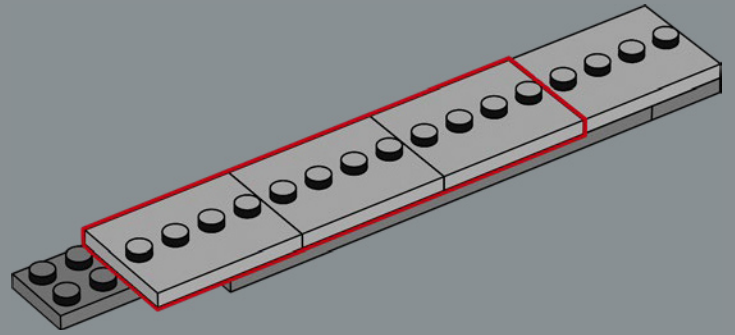

4

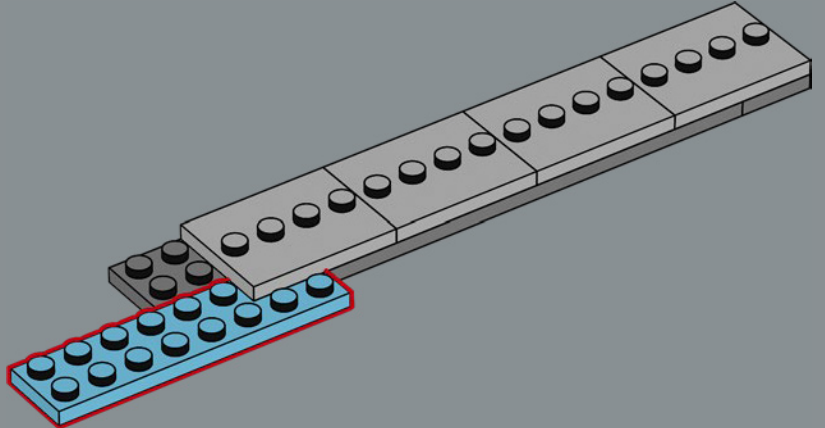

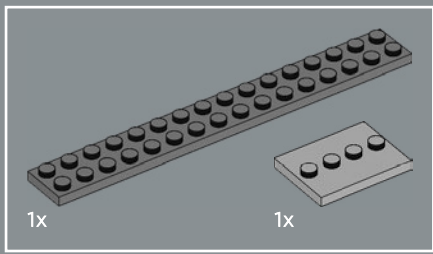

5

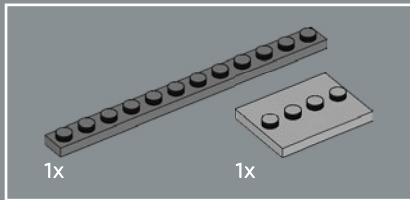
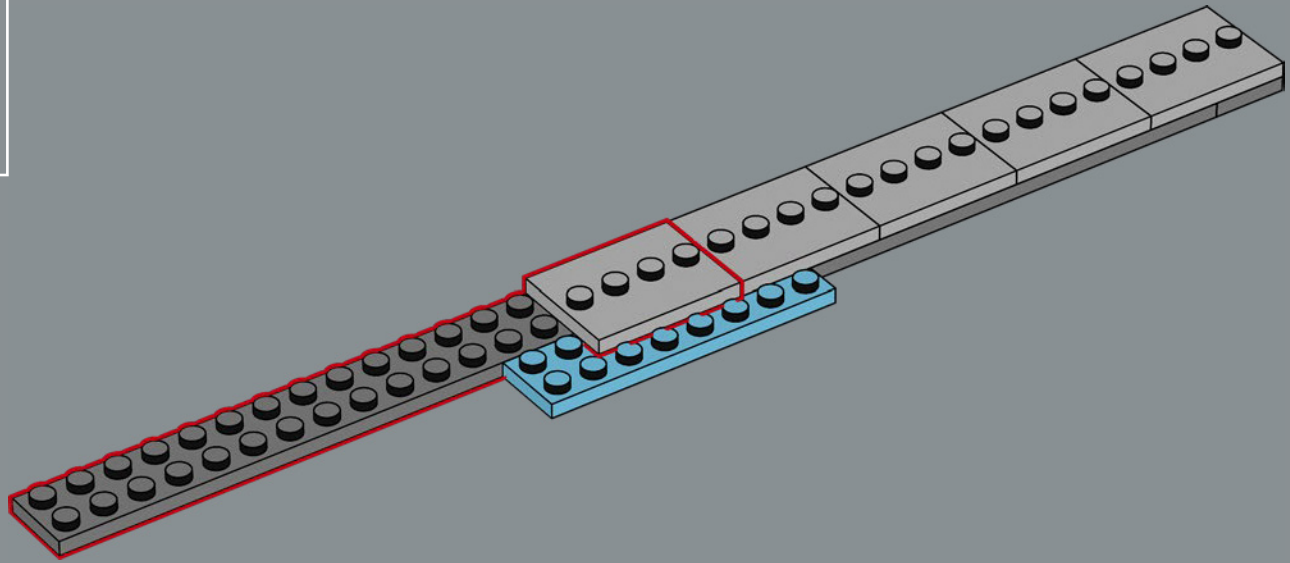

6

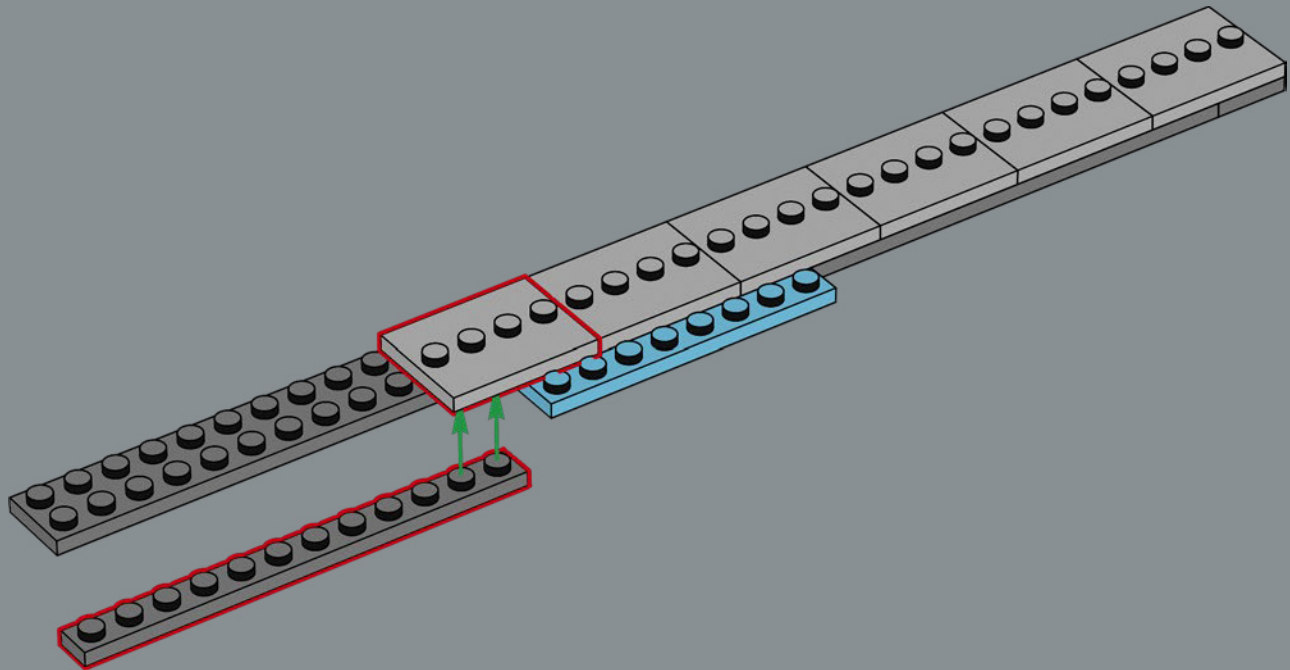

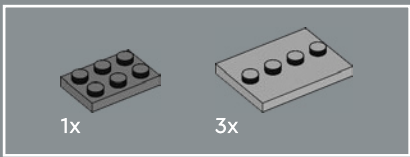

7

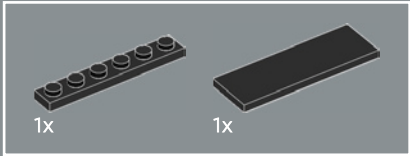
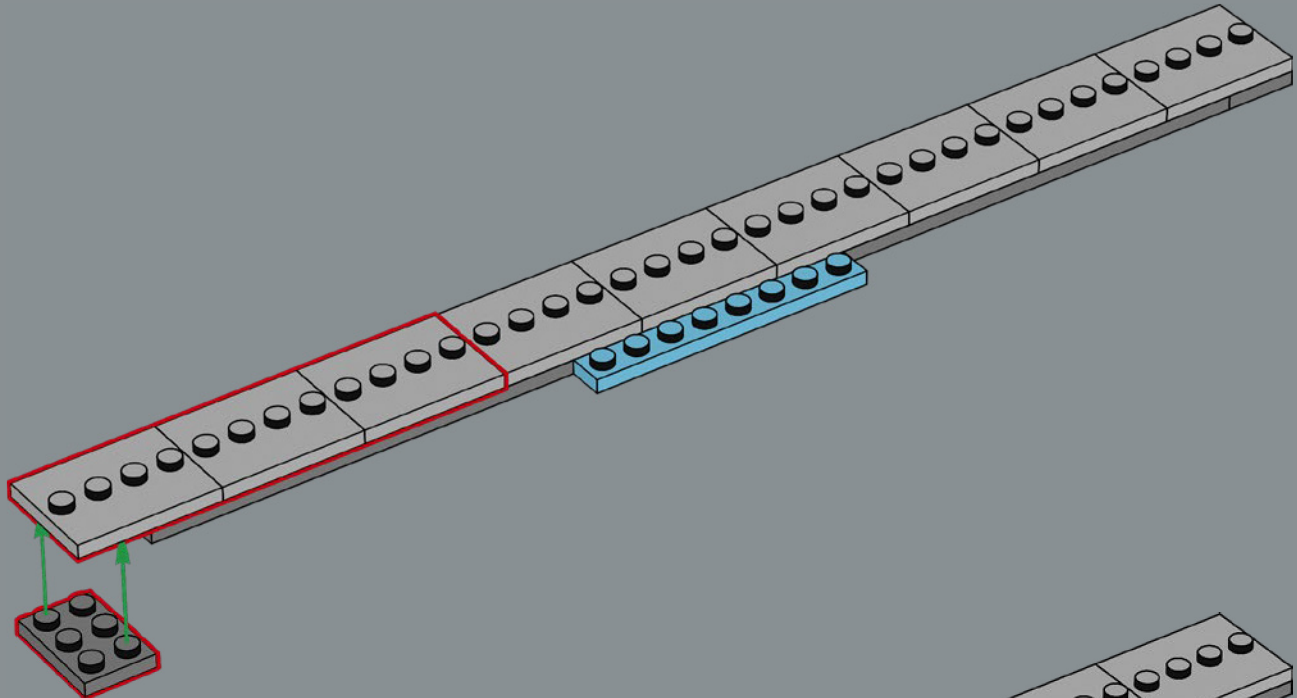

8

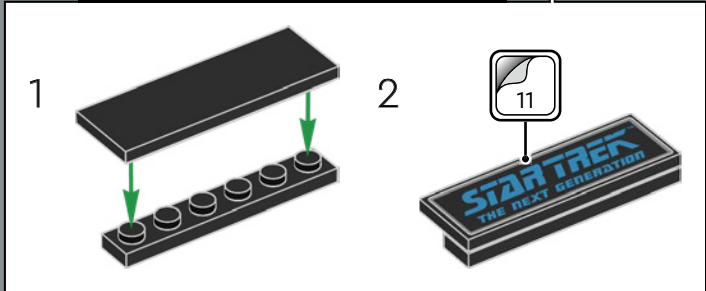
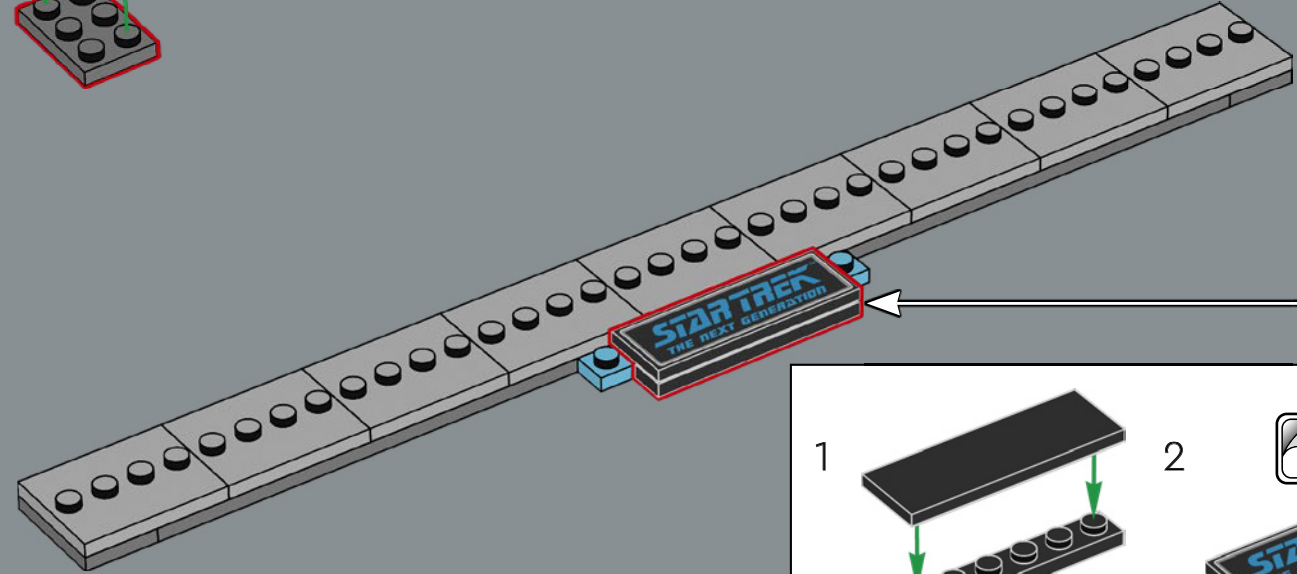



9

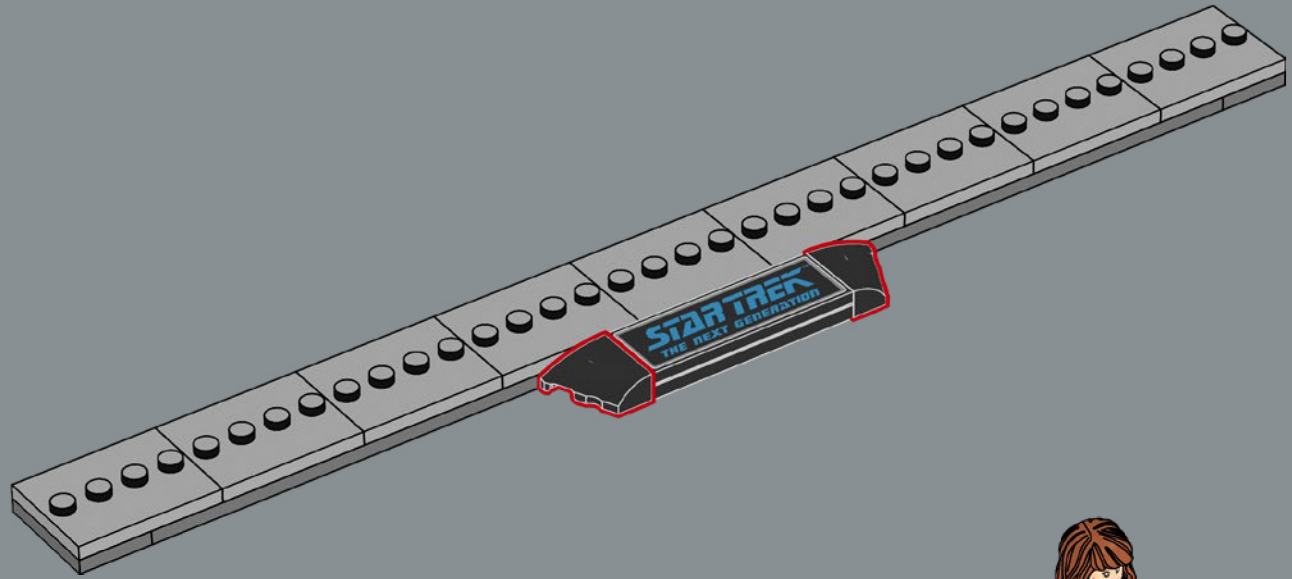

10

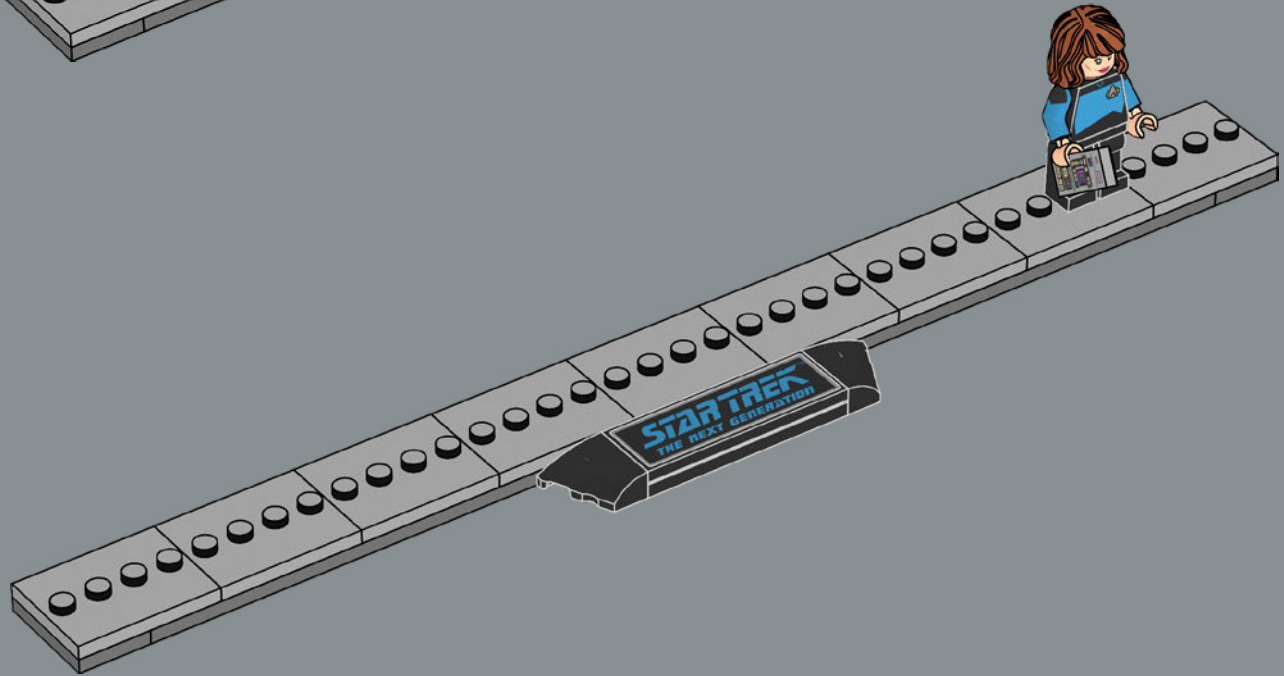

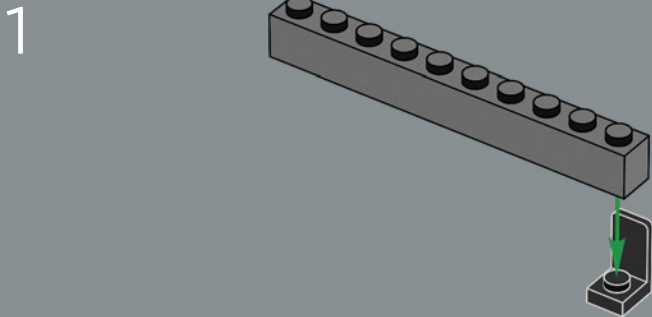
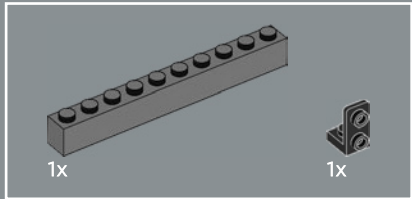
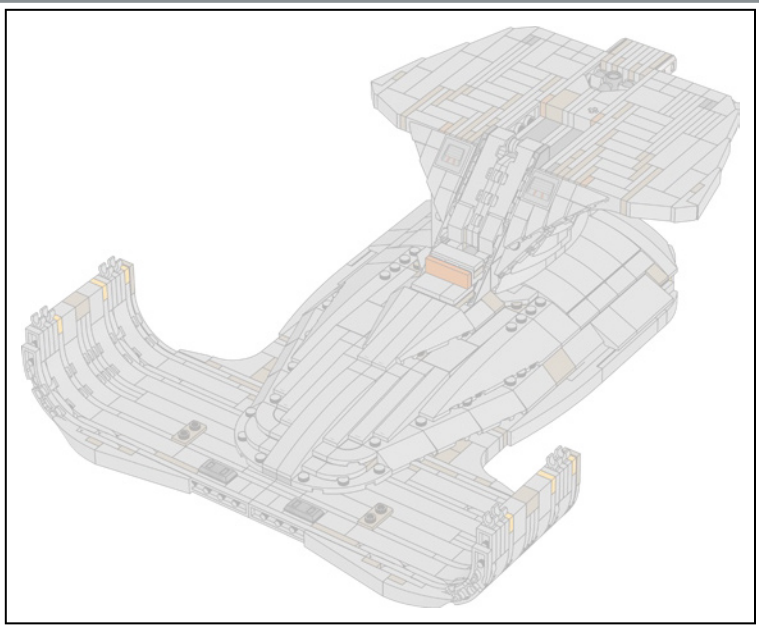

2

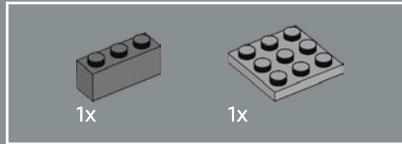
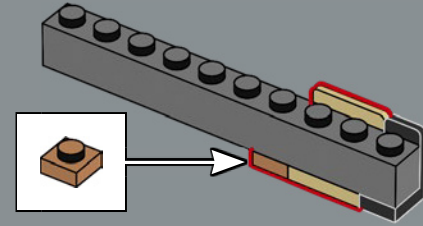

3

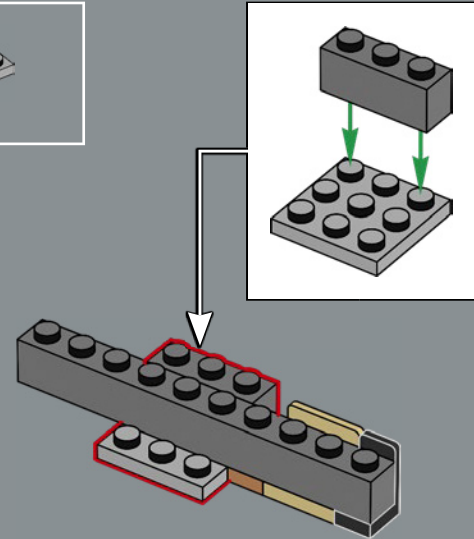

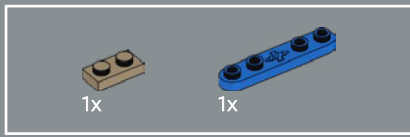

4

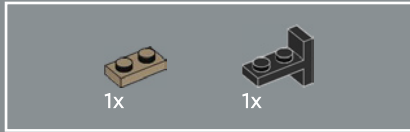
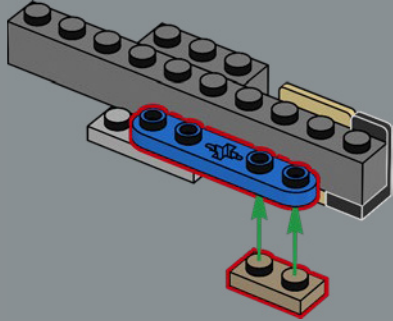

5

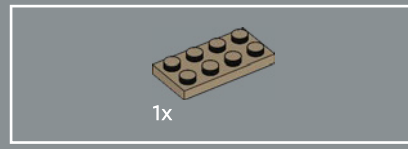
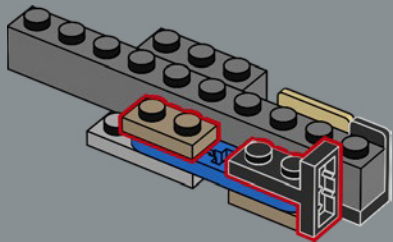

6

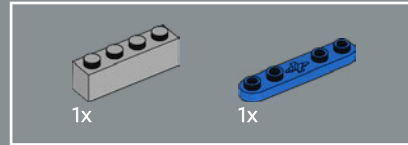
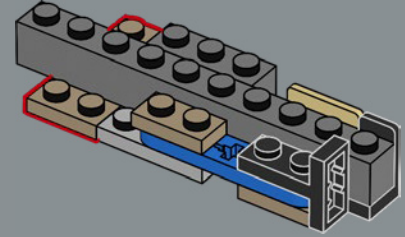

7

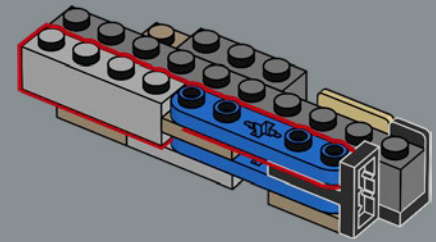

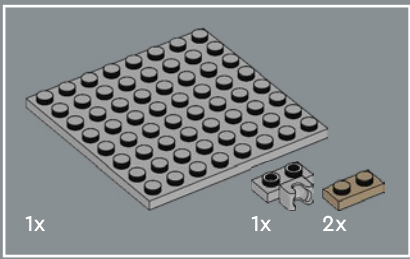

8

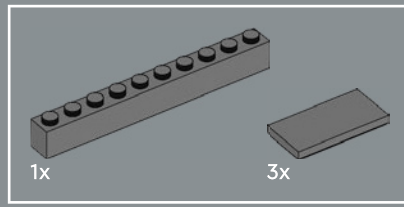
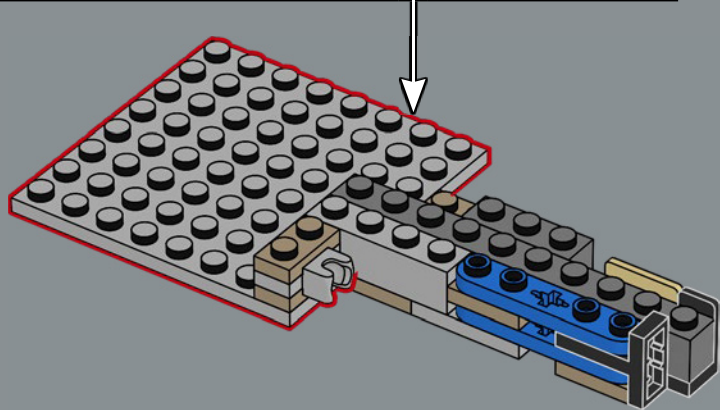
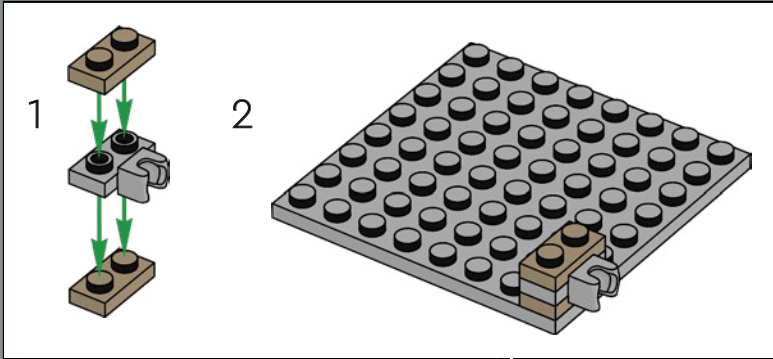

9

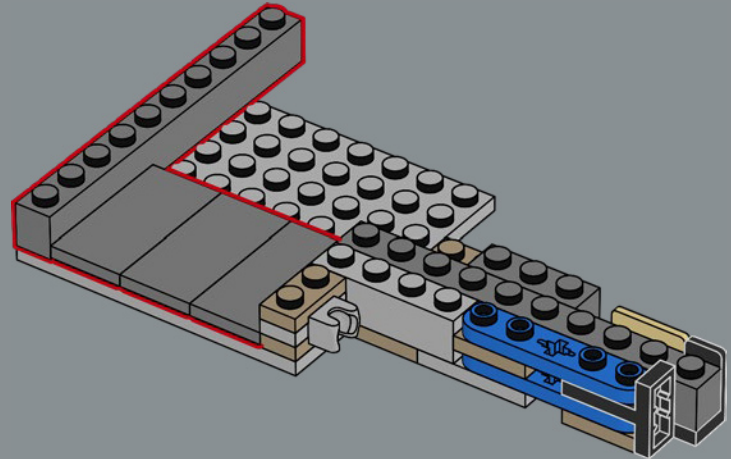

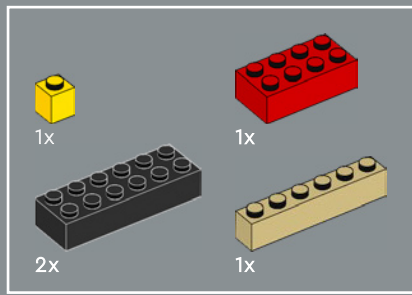

10

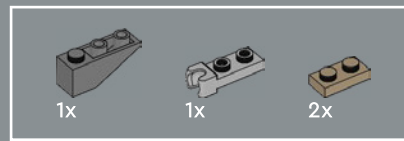
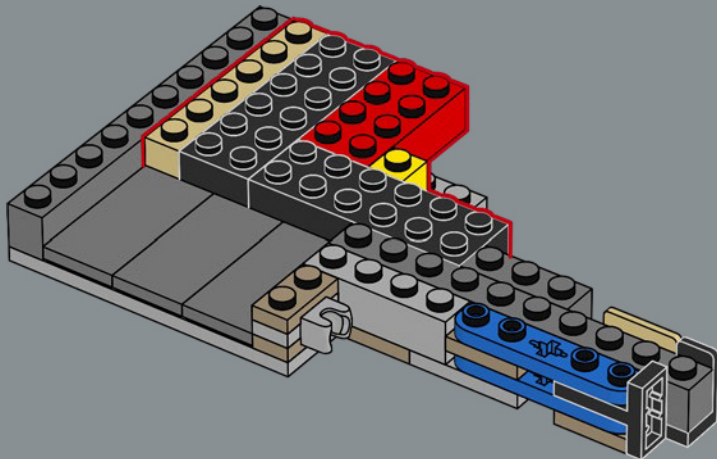

11

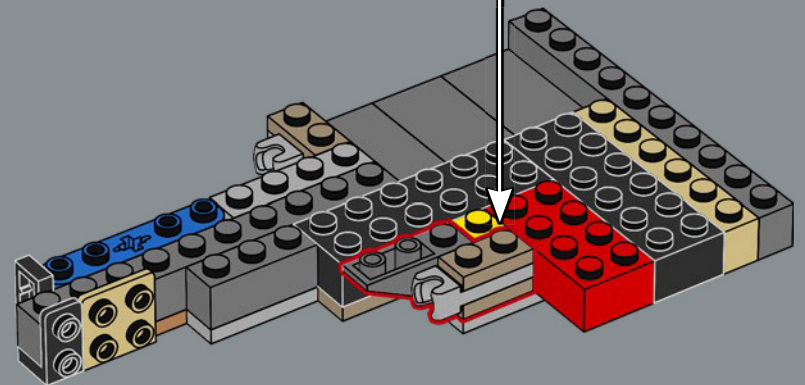
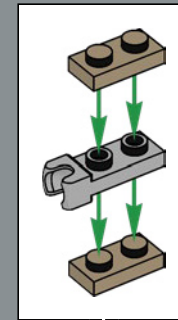

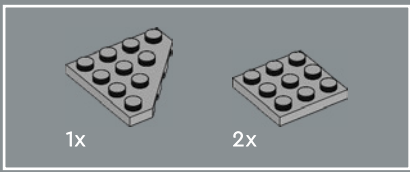

12

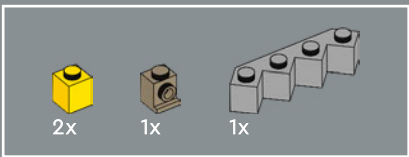
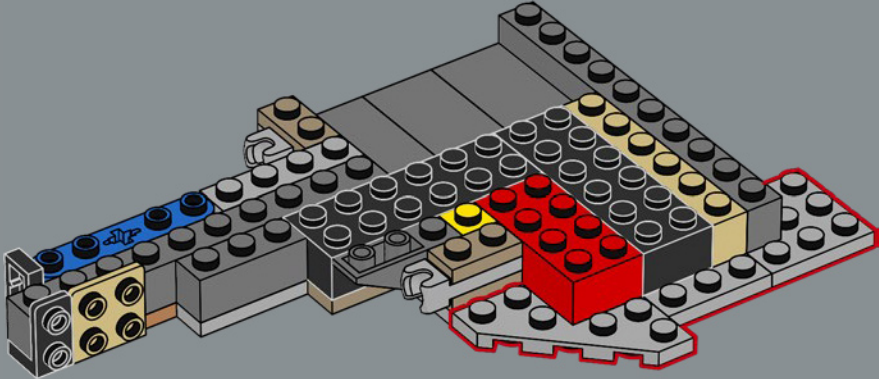

13

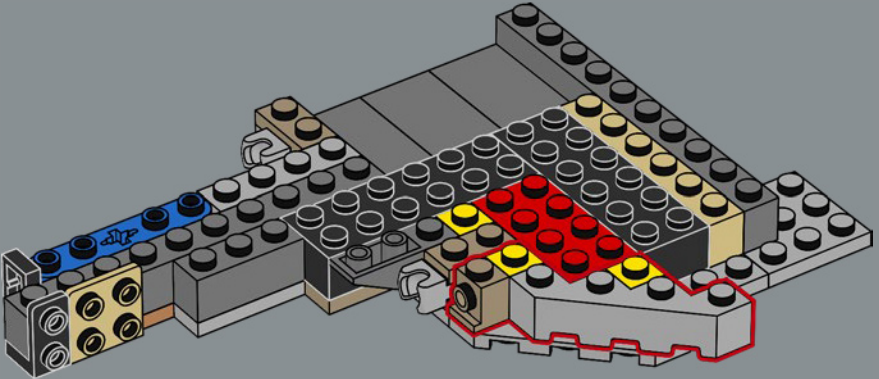

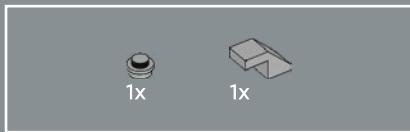

14

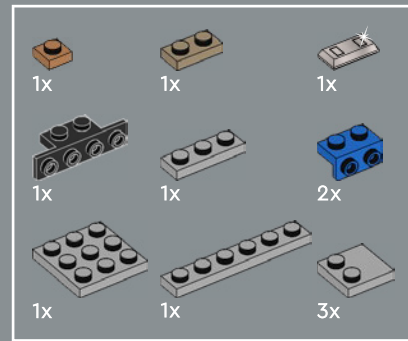
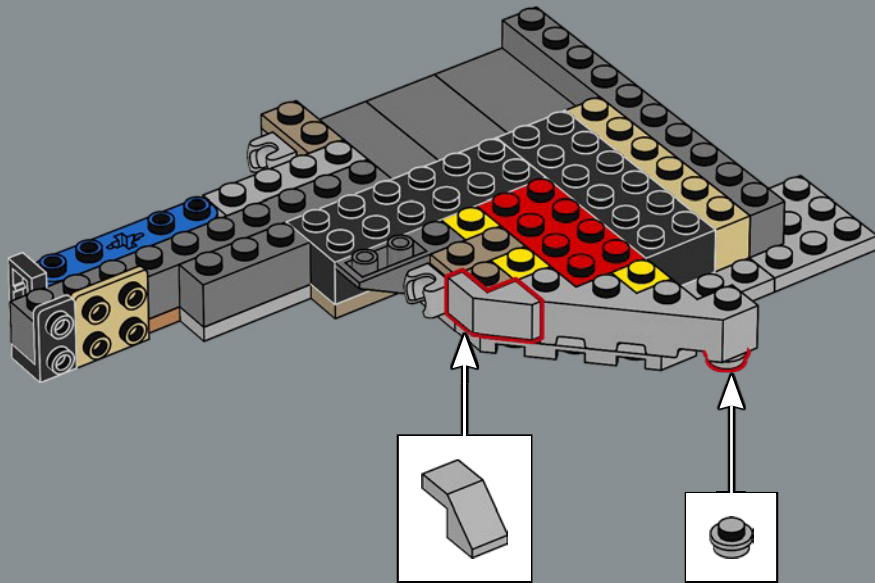

15

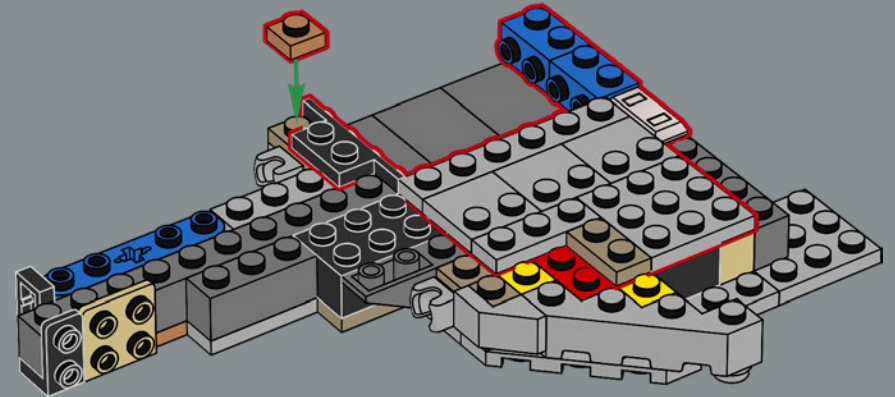

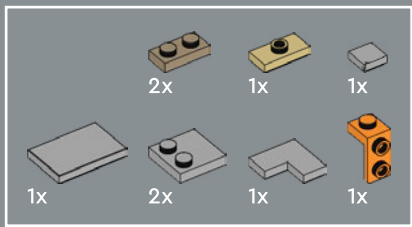

16

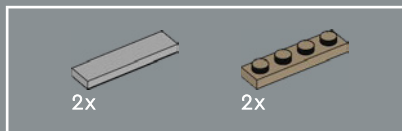
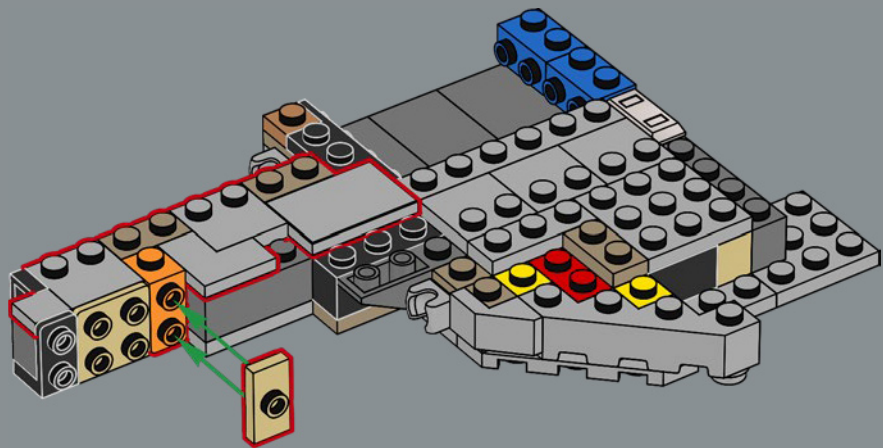

17

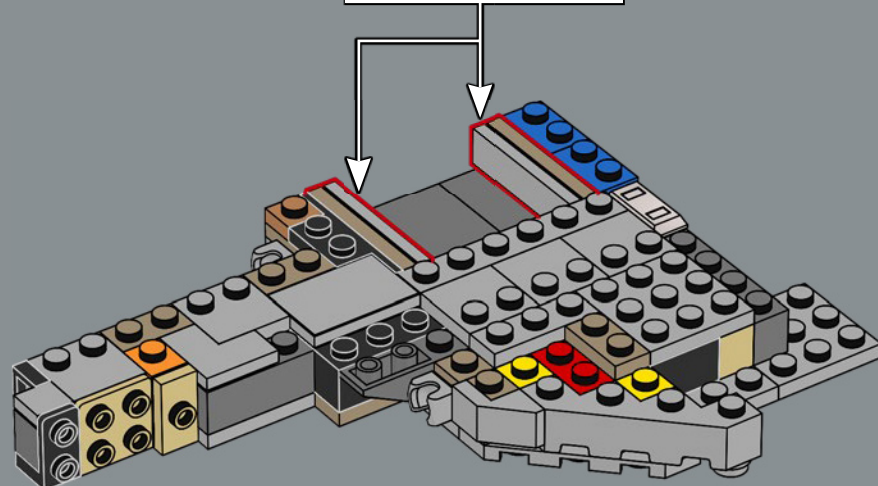
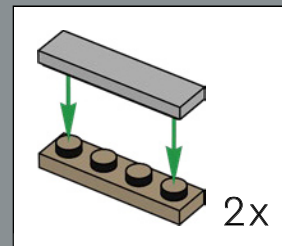

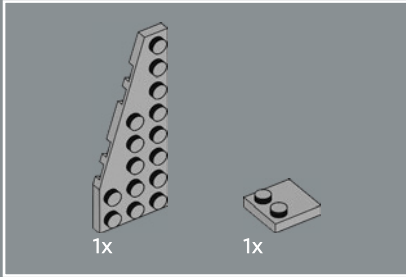
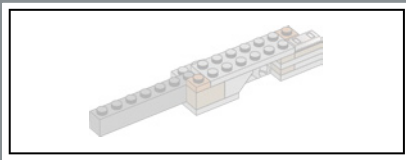

18

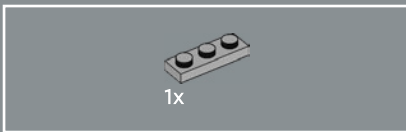
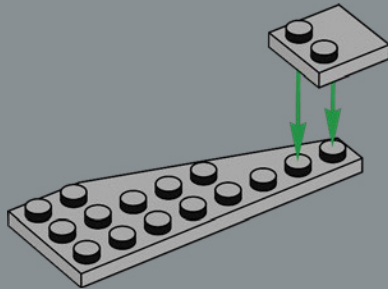

19

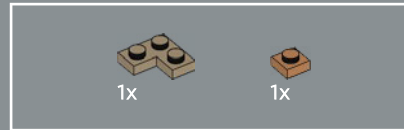
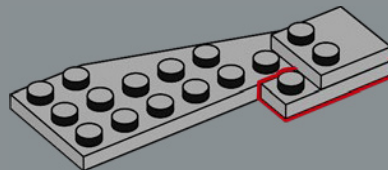

20

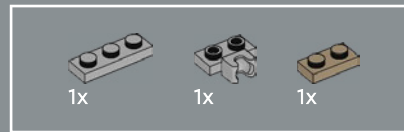
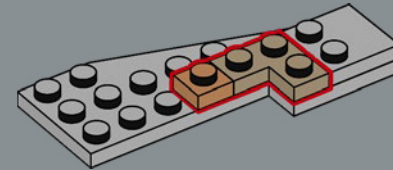

21

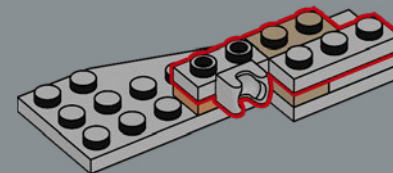

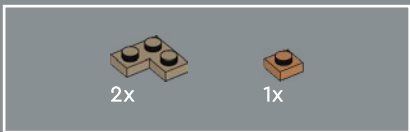

22

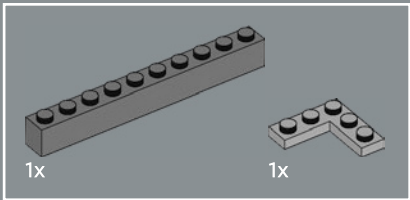
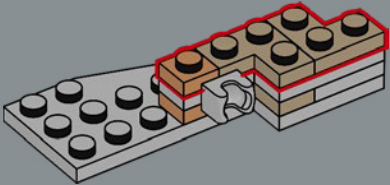

23

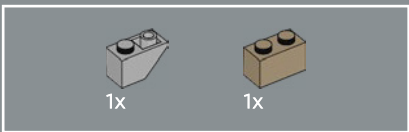
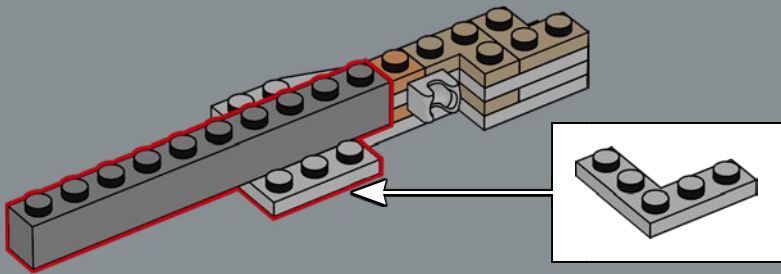

24

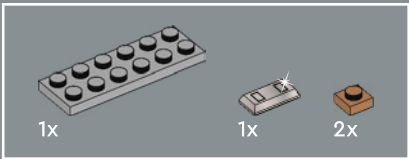
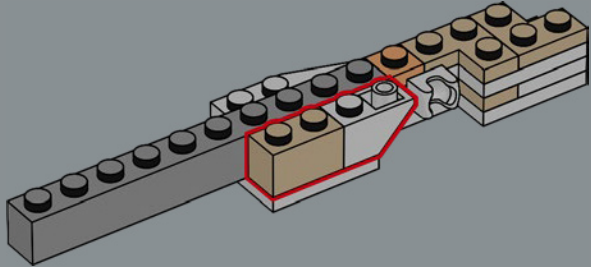

25

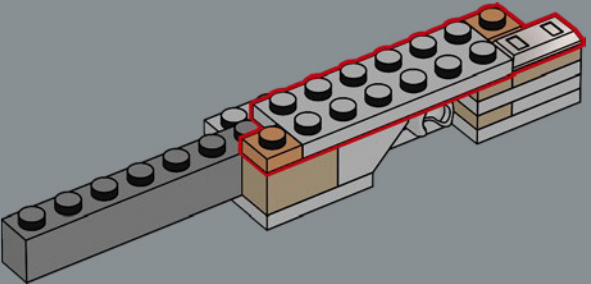

26

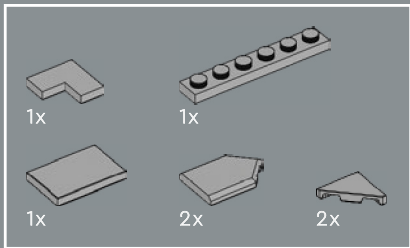
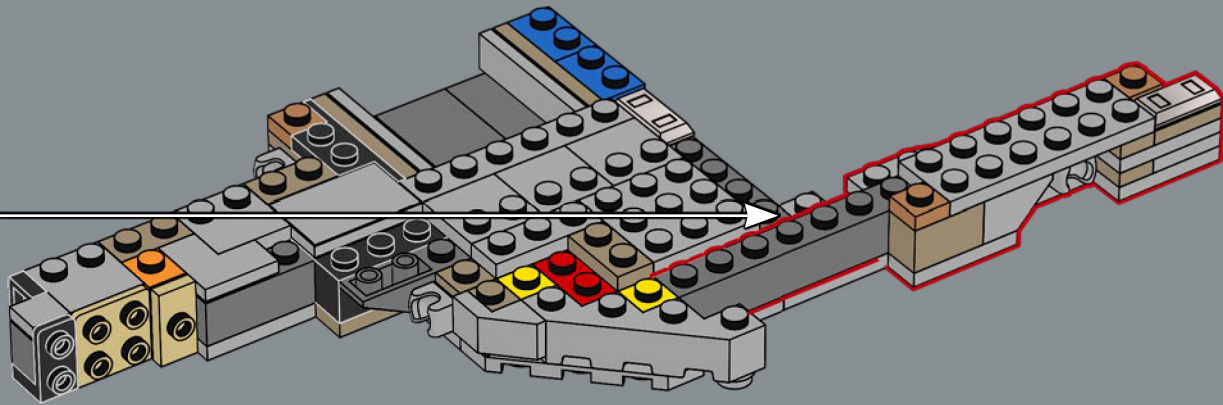

27

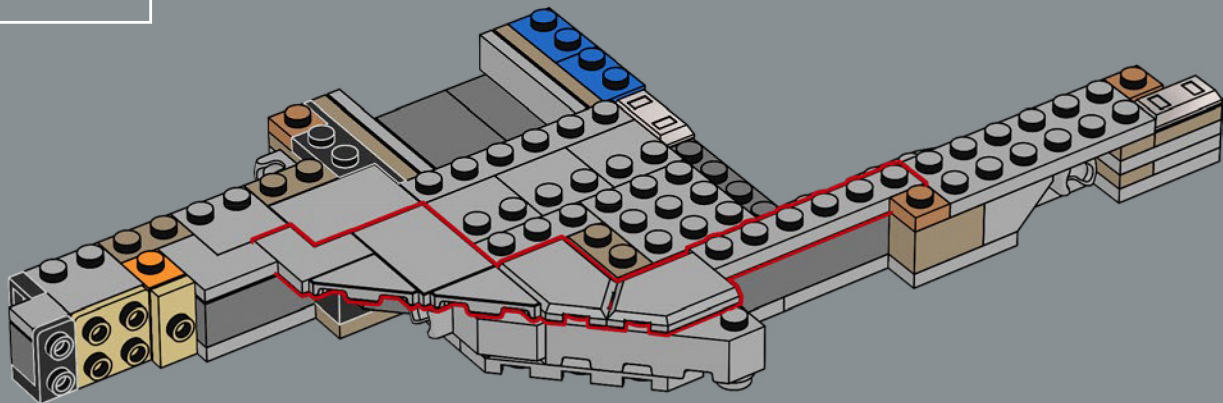

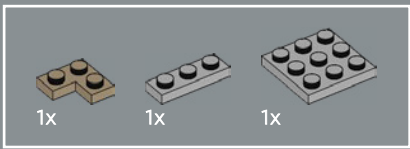

28

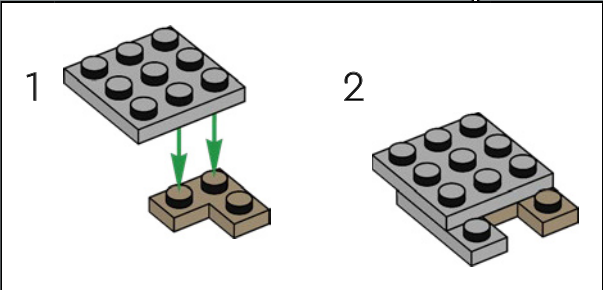
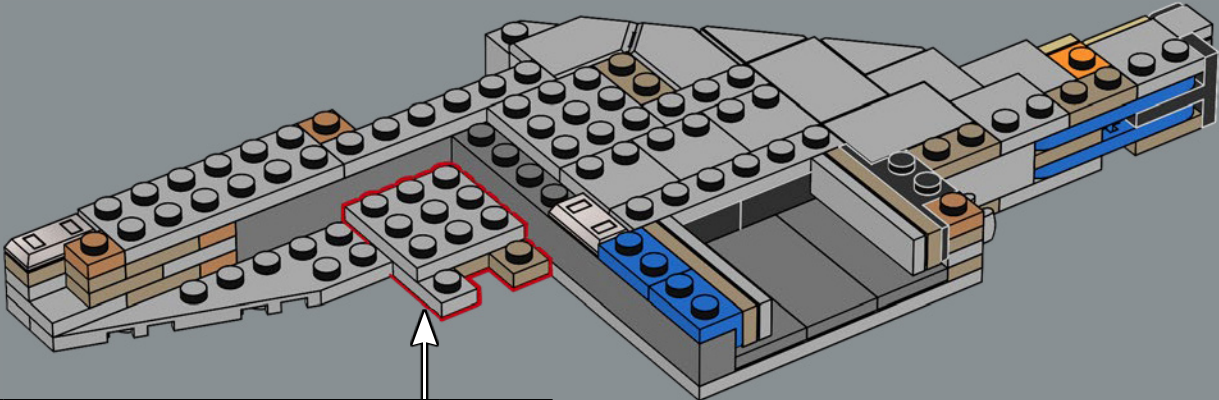

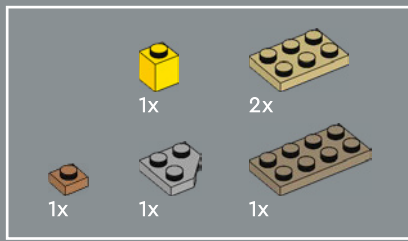

29

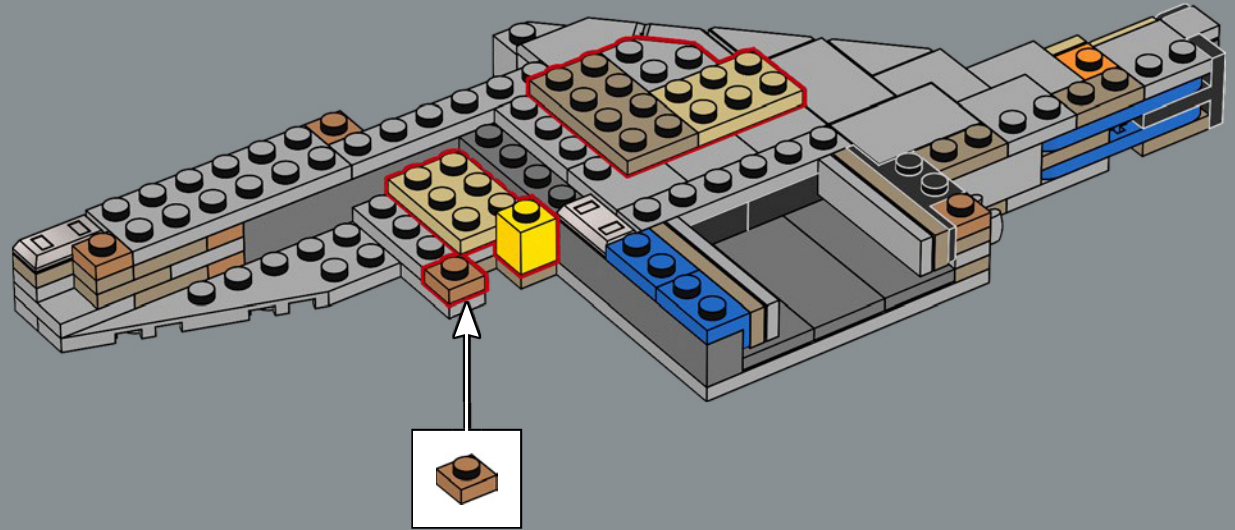

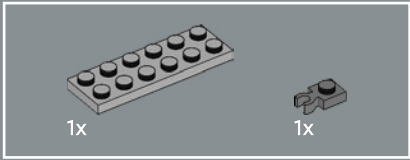
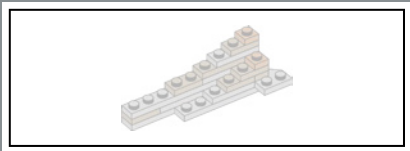

30

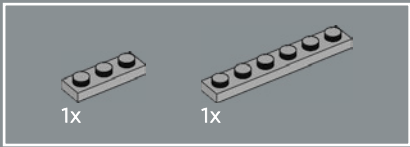
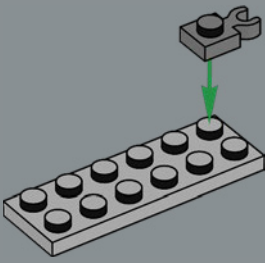

31

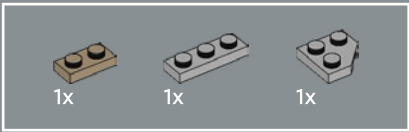
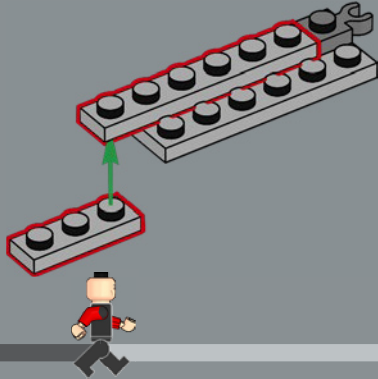

32

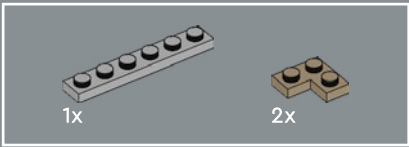
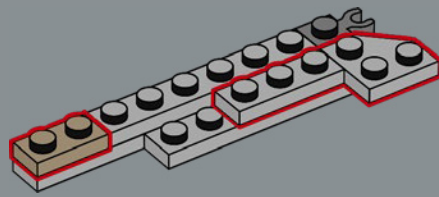

33

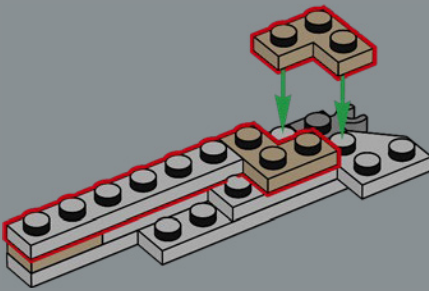

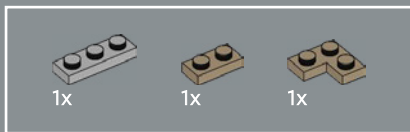

34

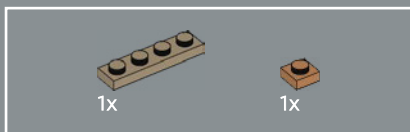
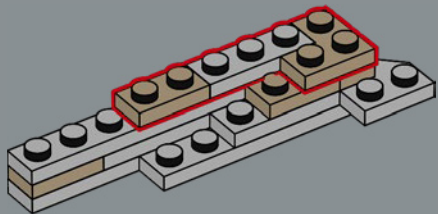

35

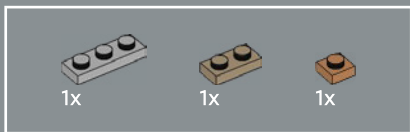
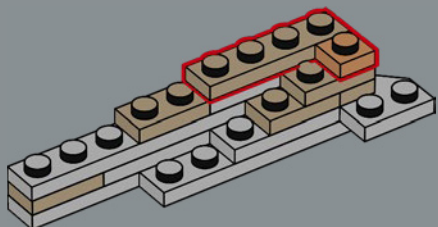

36

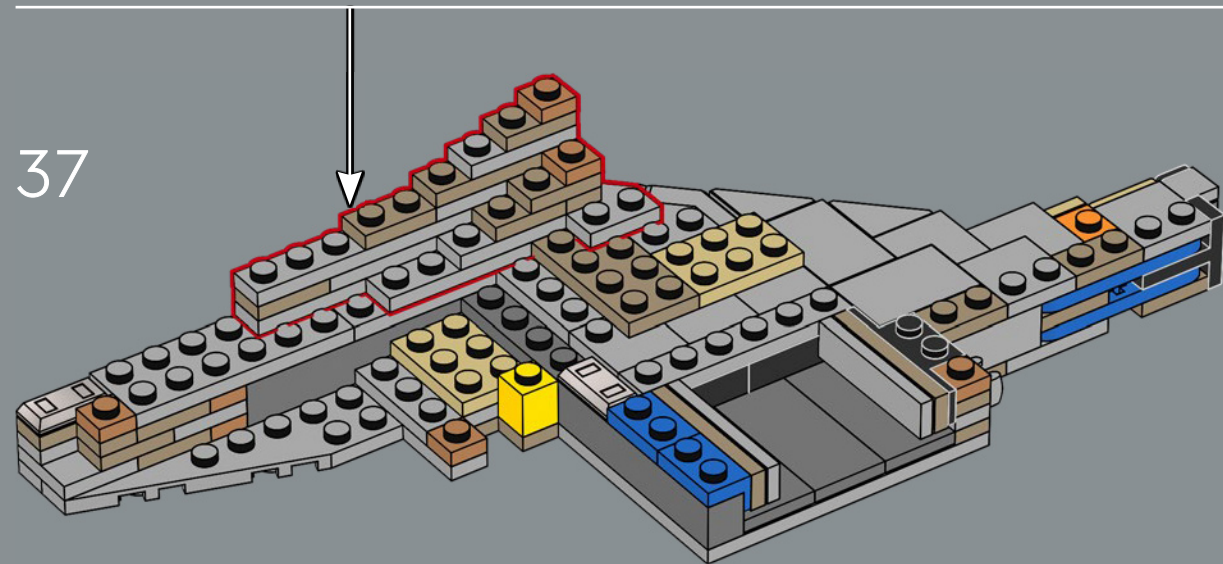
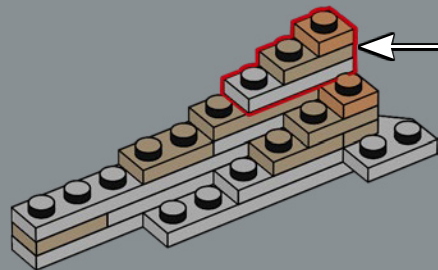

37

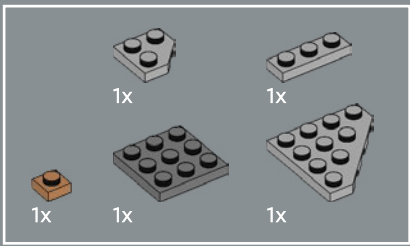

38

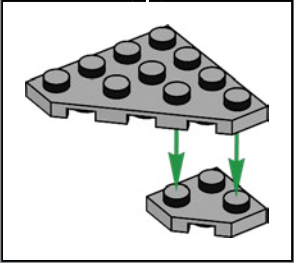
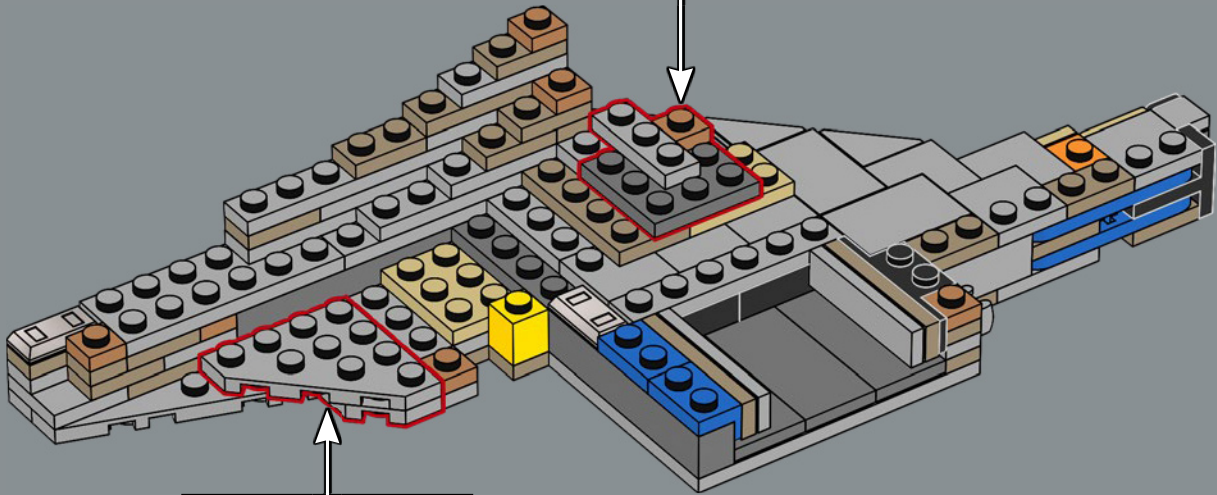
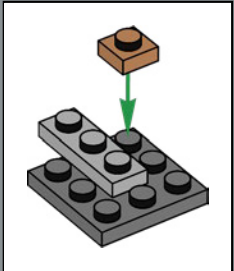

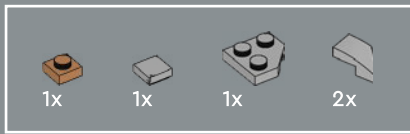

39

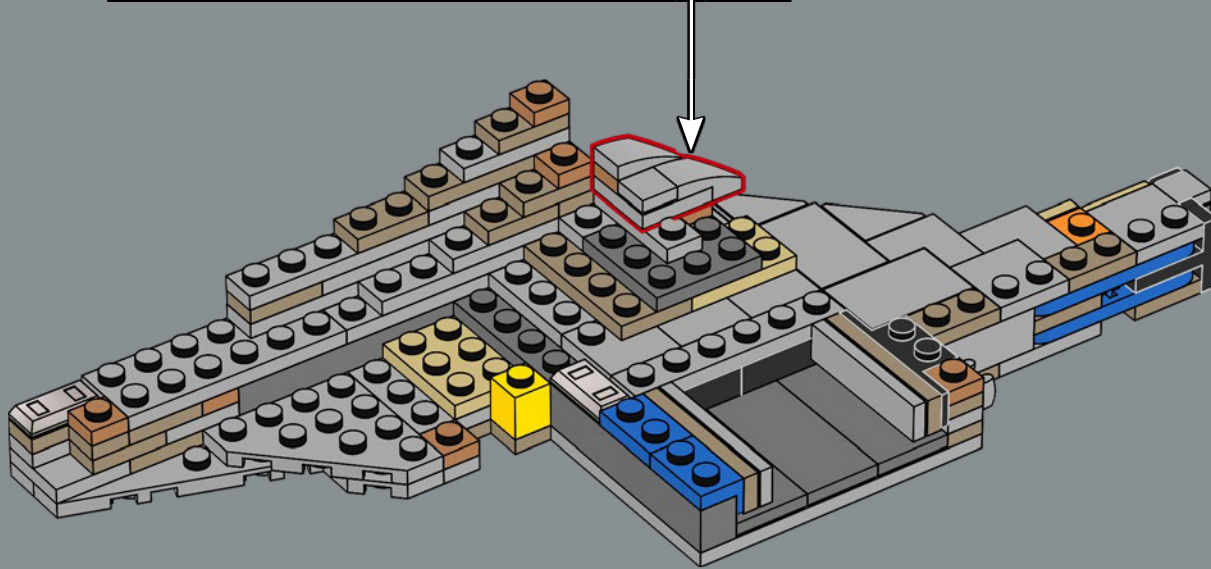
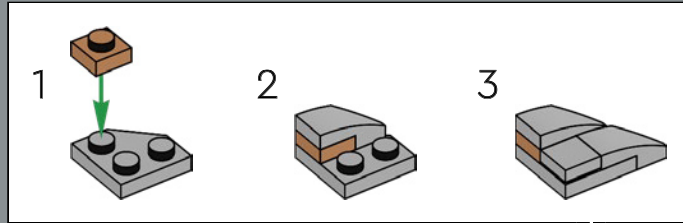

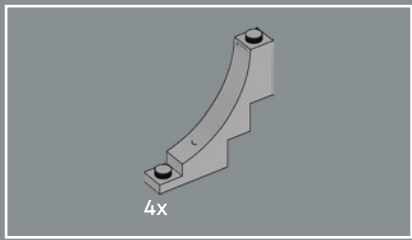

40

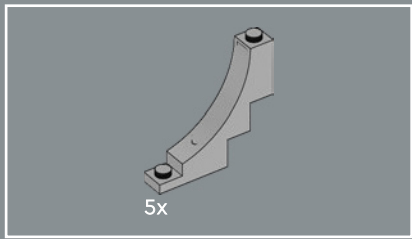
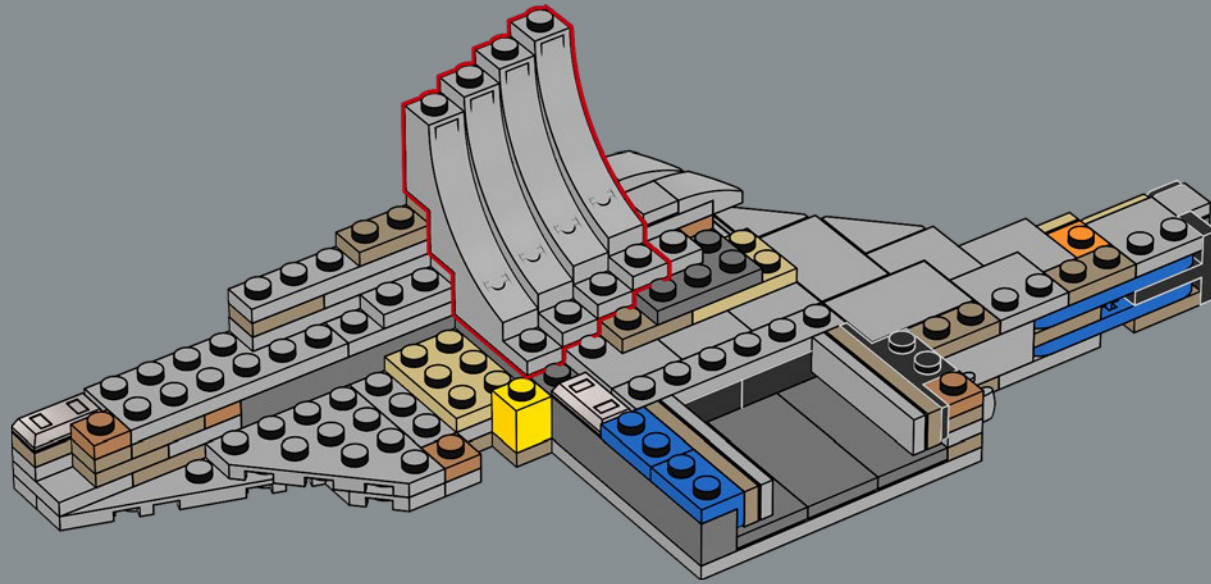

41

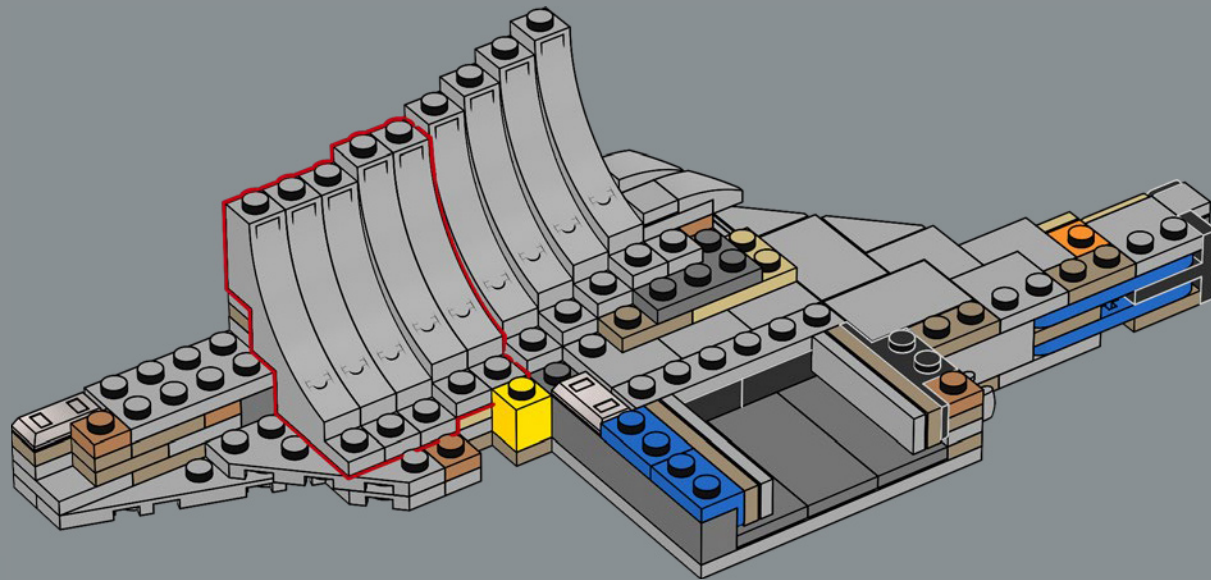

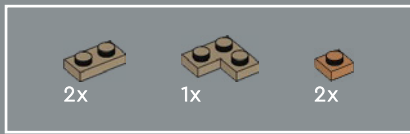

42

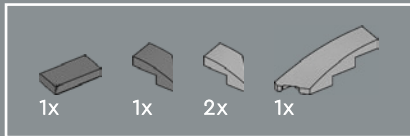
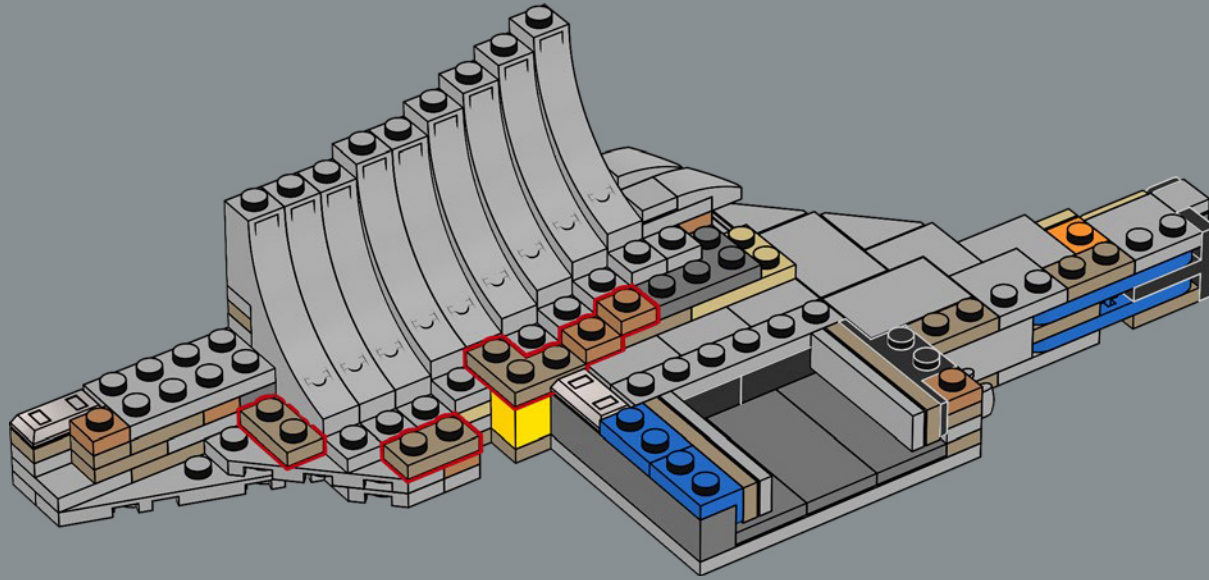

43

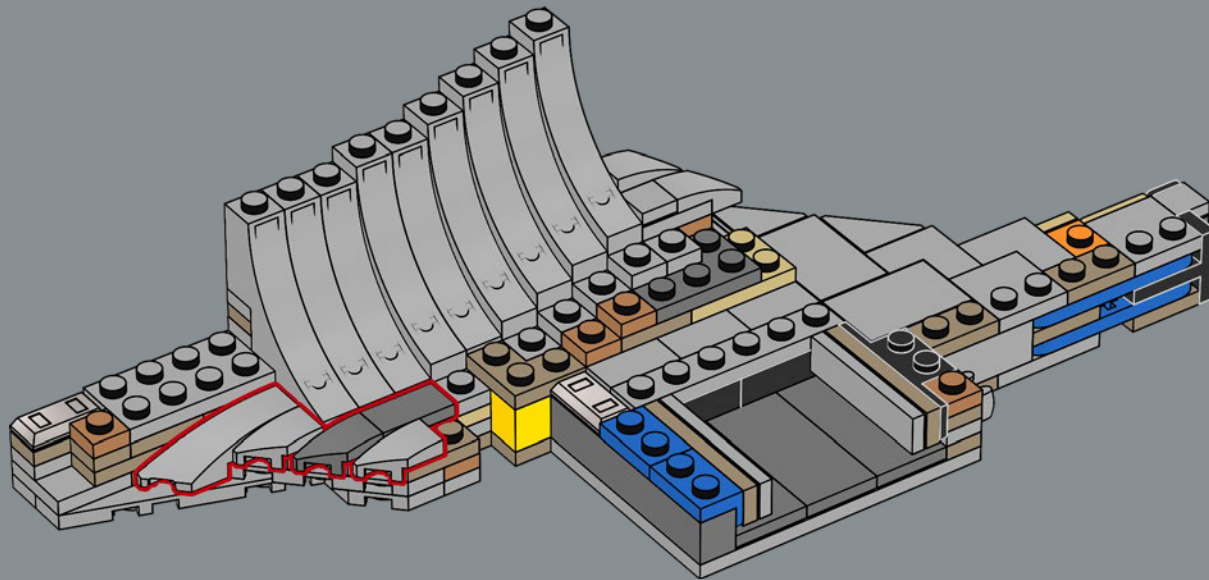

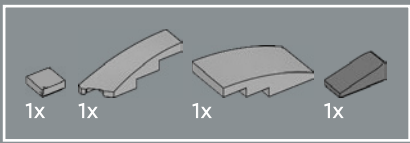

44

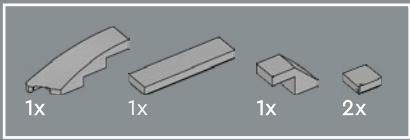
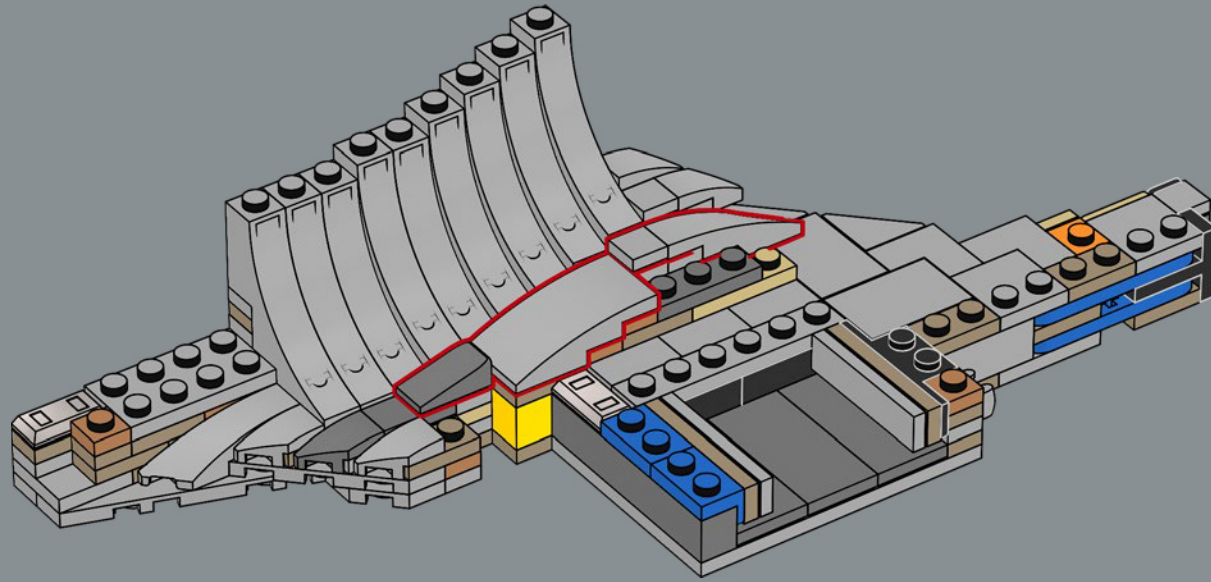

45

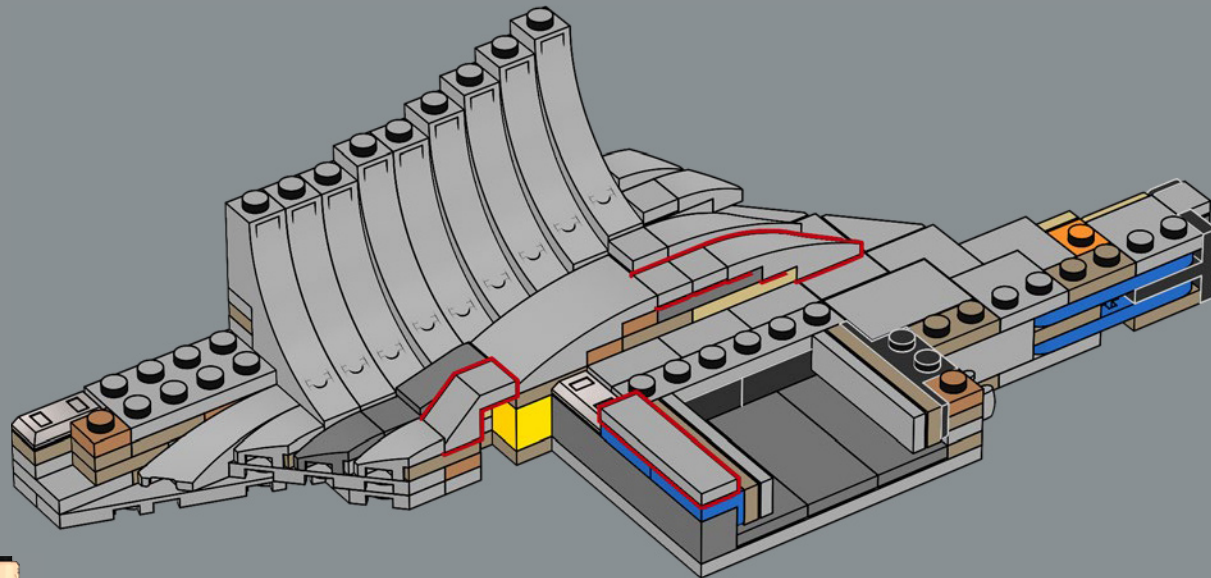

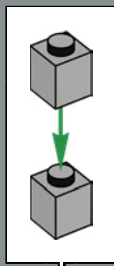
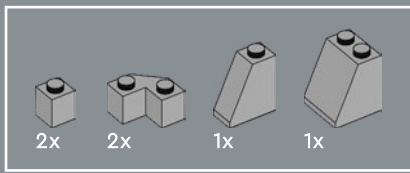

46

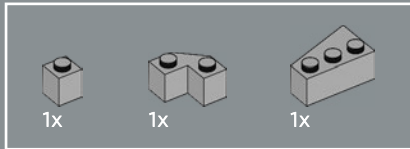
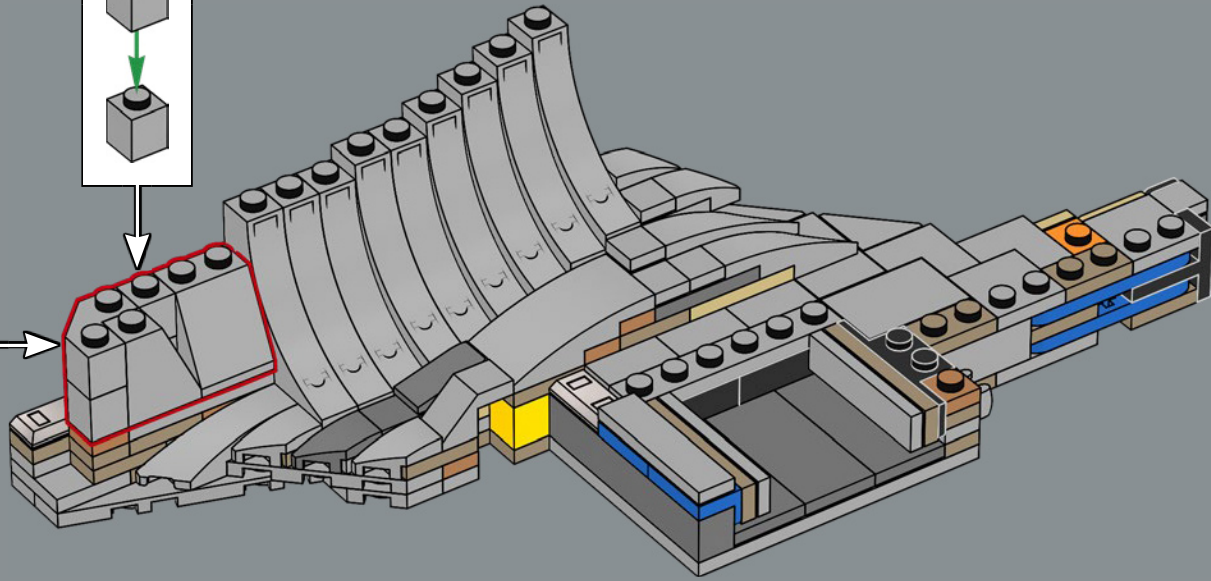
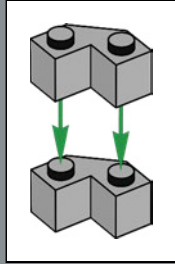

47

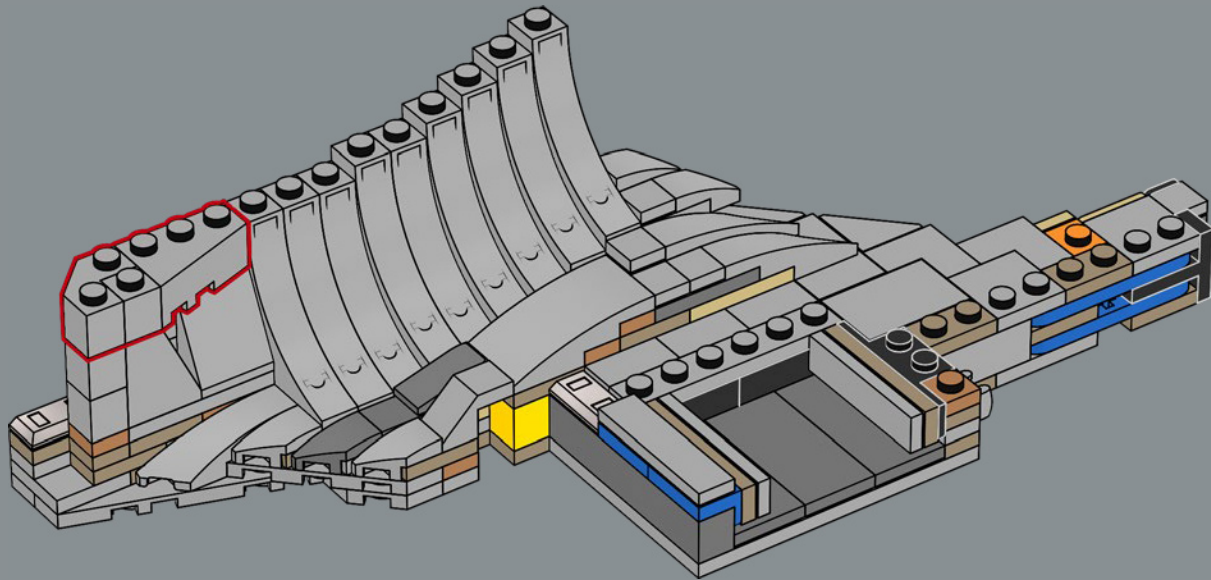

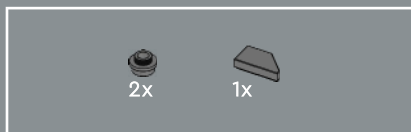

48

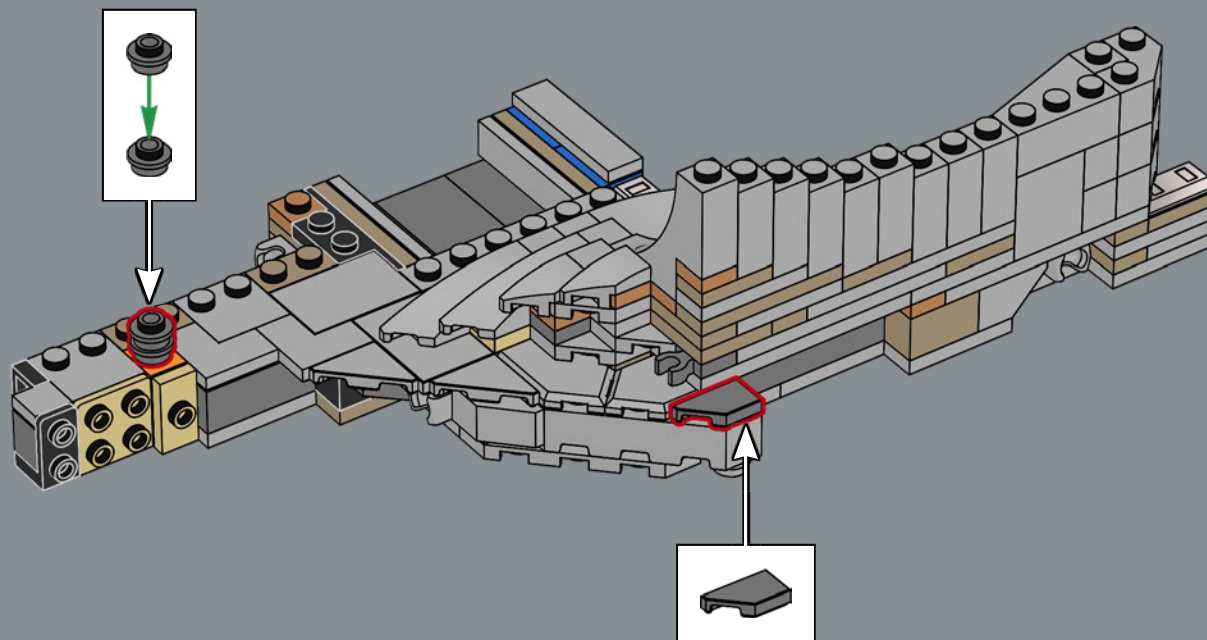

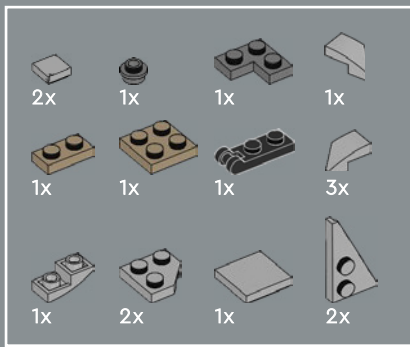

Two secondary shuttle bays are located in the ship's 'neck', which is part of the secondary hull. The starboard bay is larger.

49

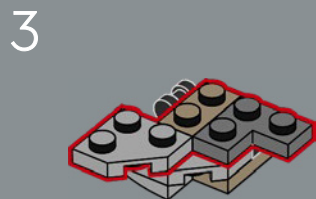
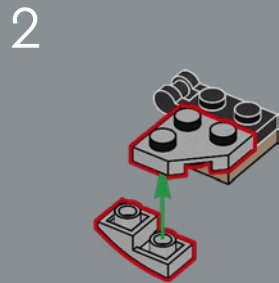
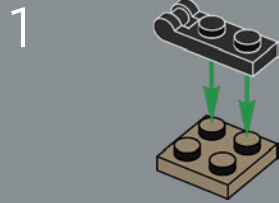

4

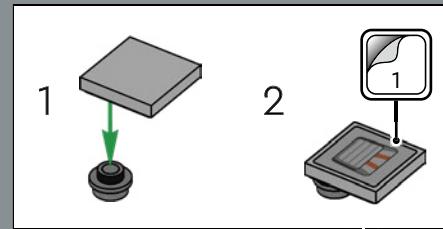
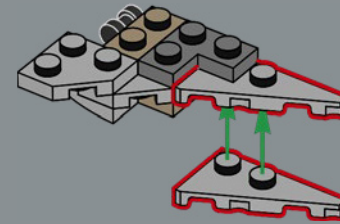

5

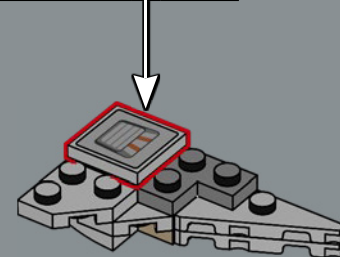

6

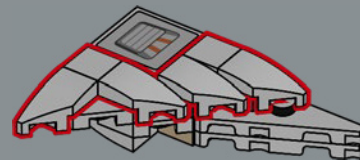

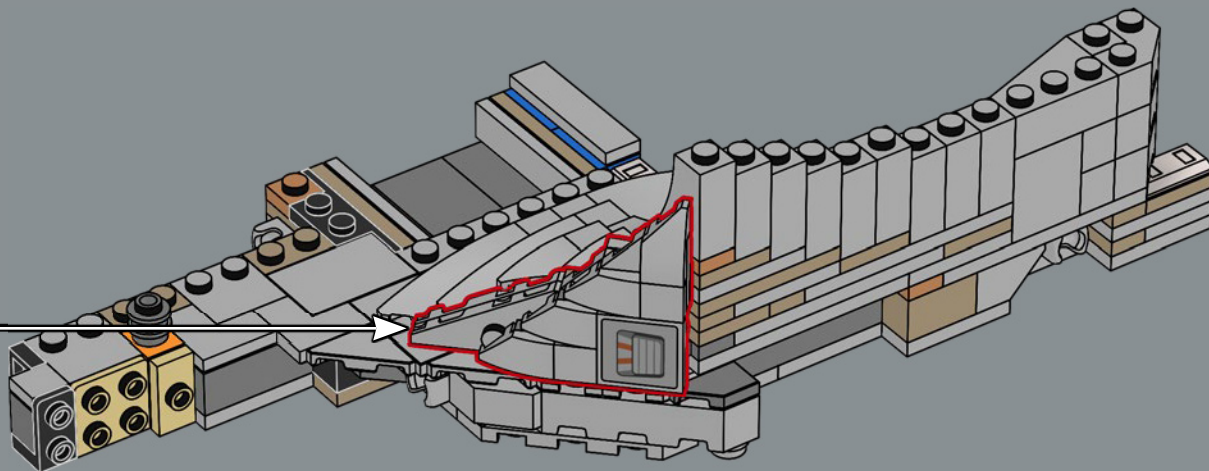

50

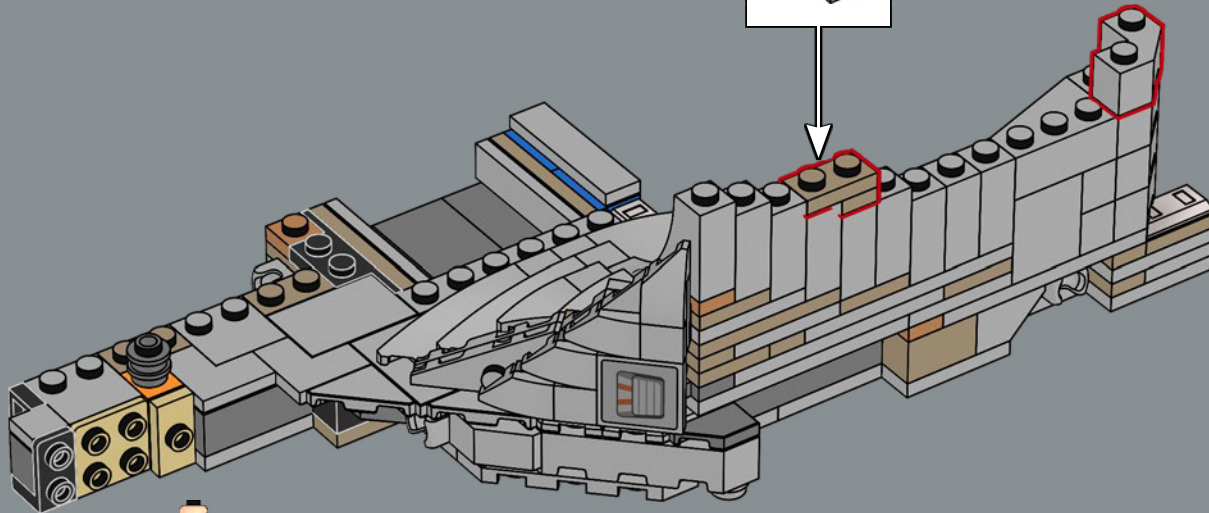
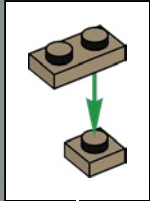

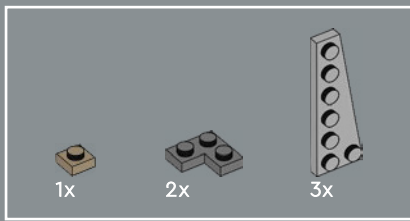

51

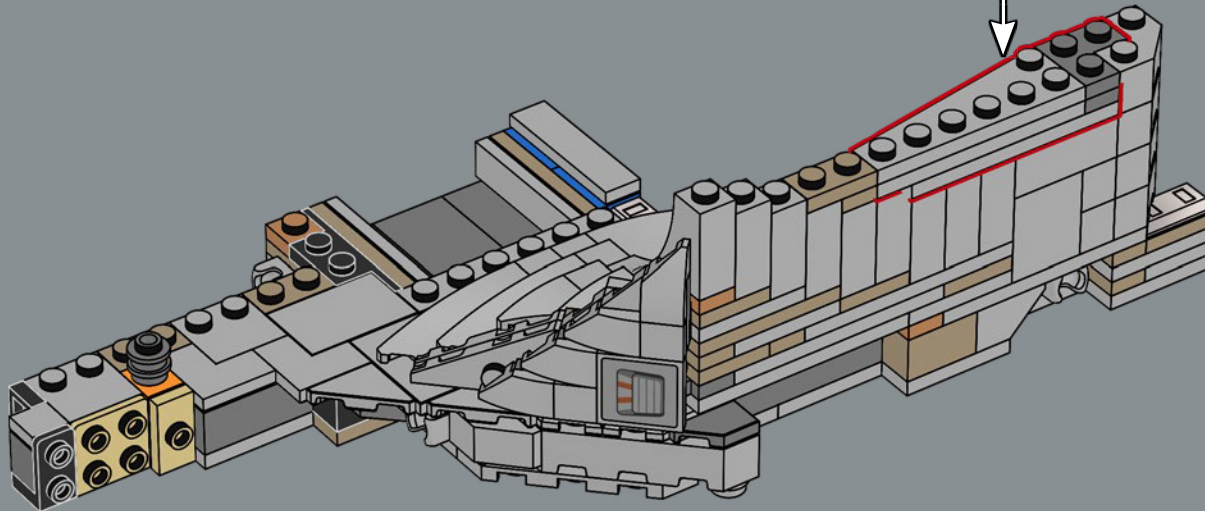
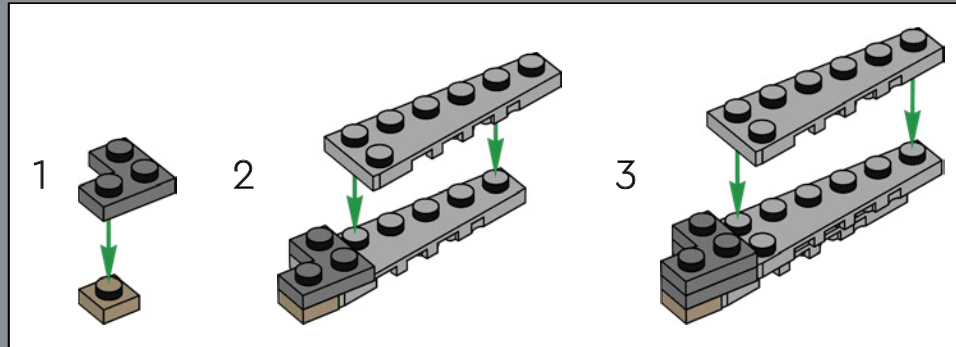

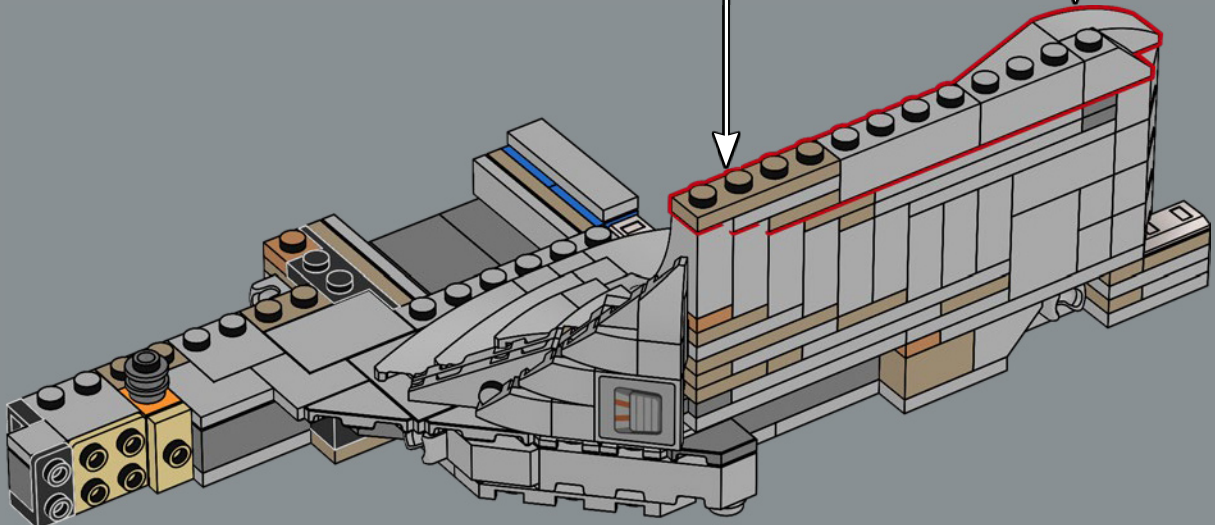
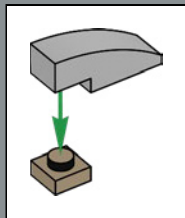
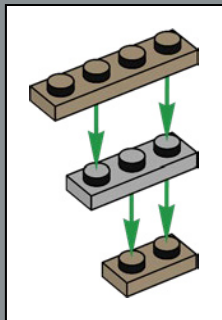
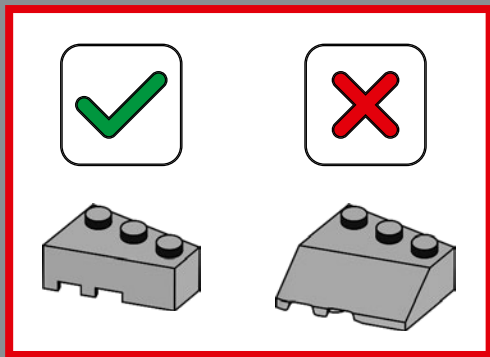
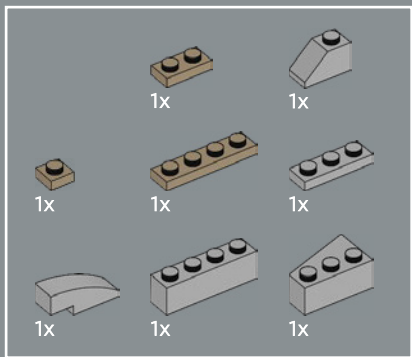

52



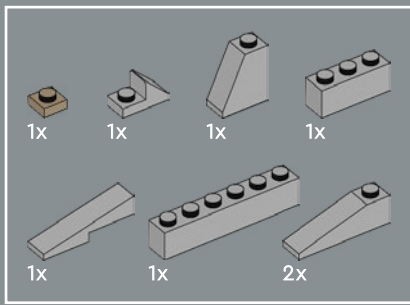

53

1

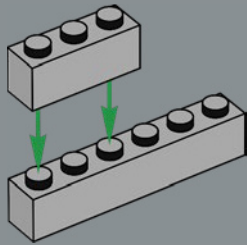

2

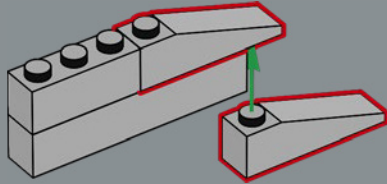

3

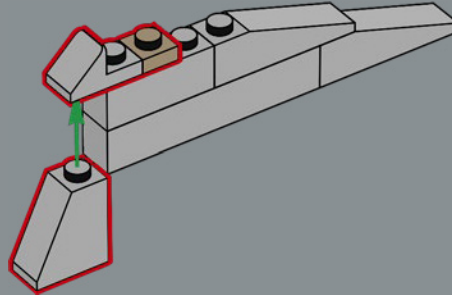

4

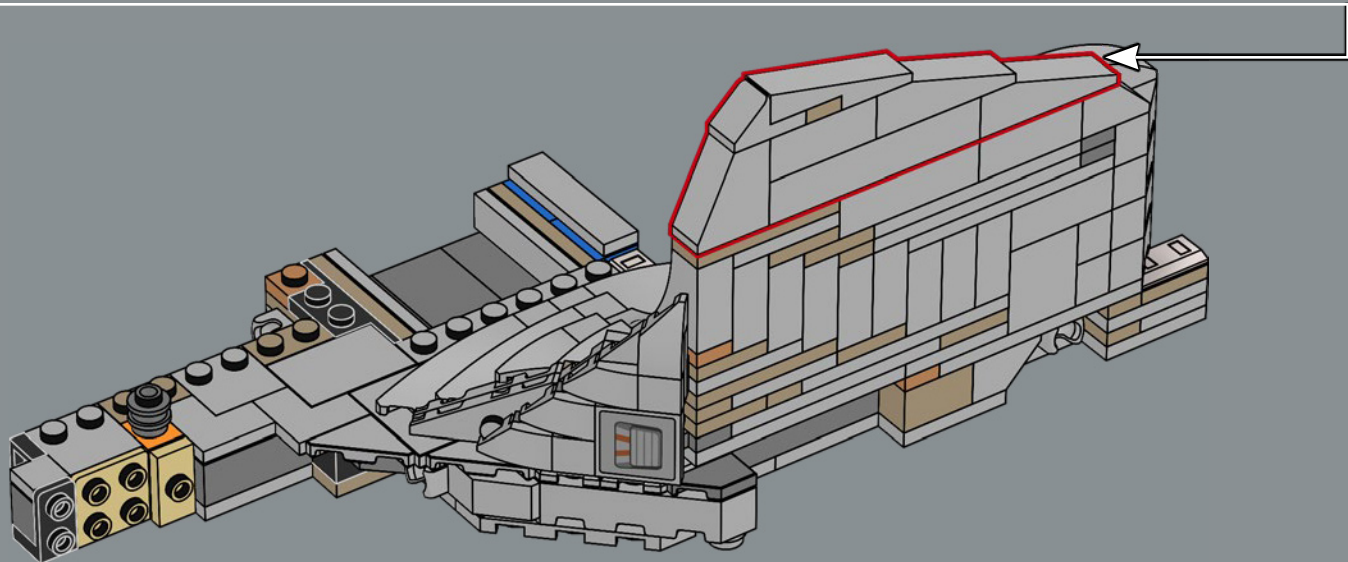
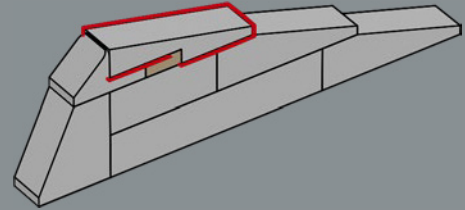

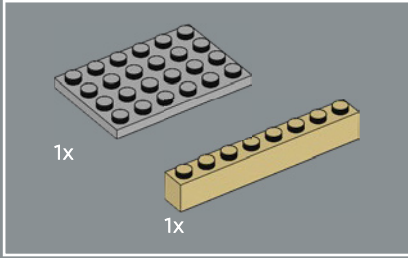
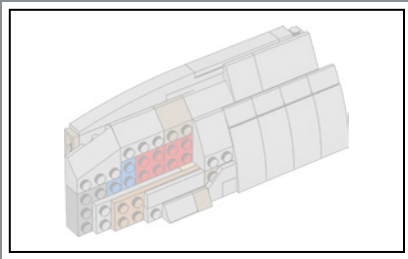

54

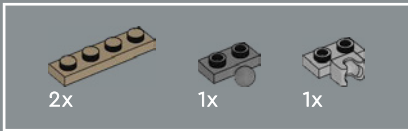
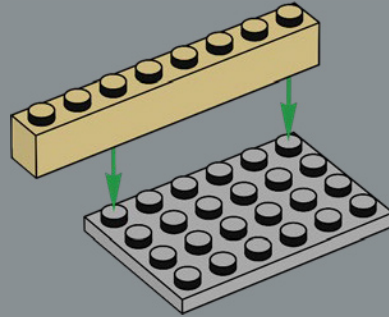

55

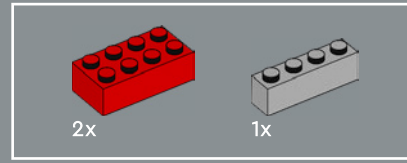
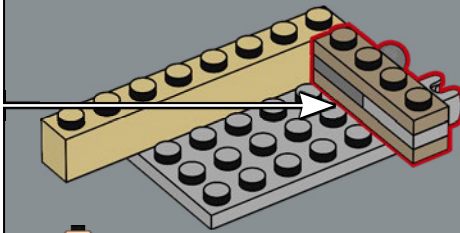
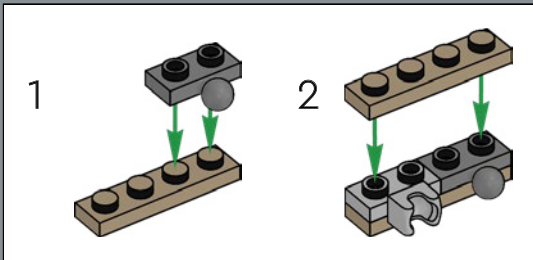

56

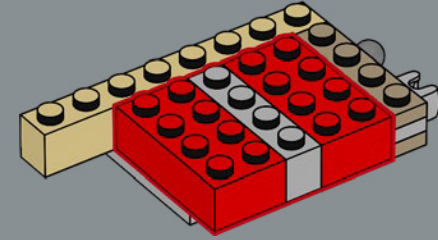

57

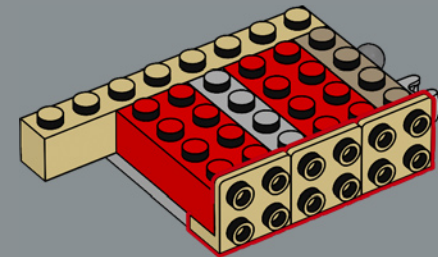

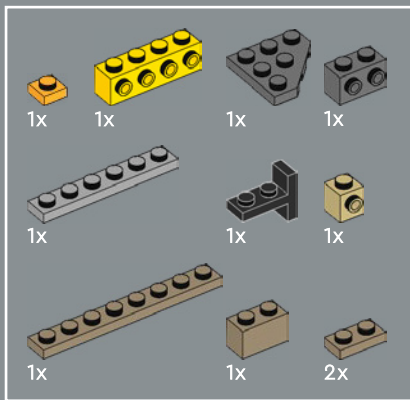

58

1

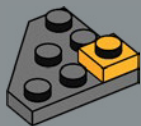

2

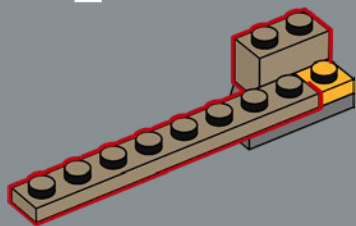

3

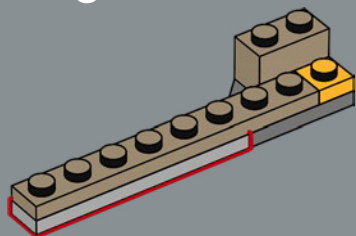

4

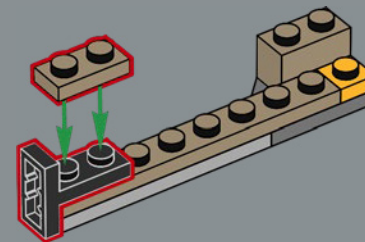

5

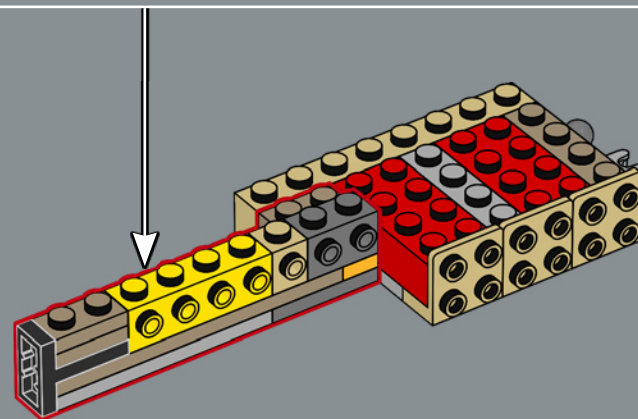
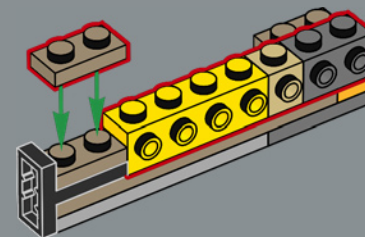

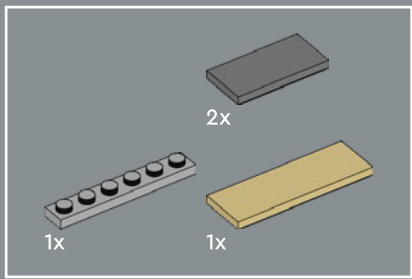

59

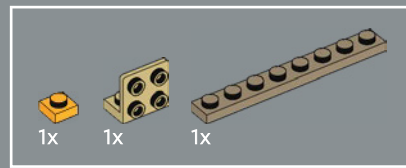
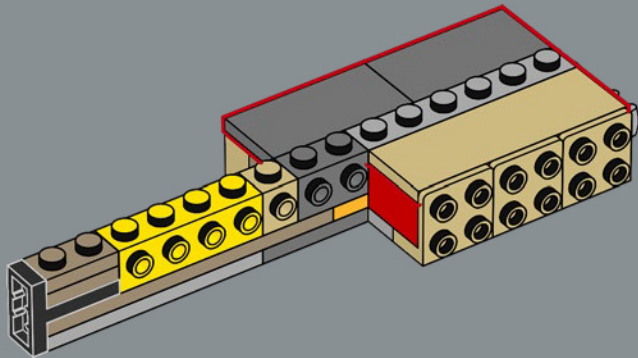

60

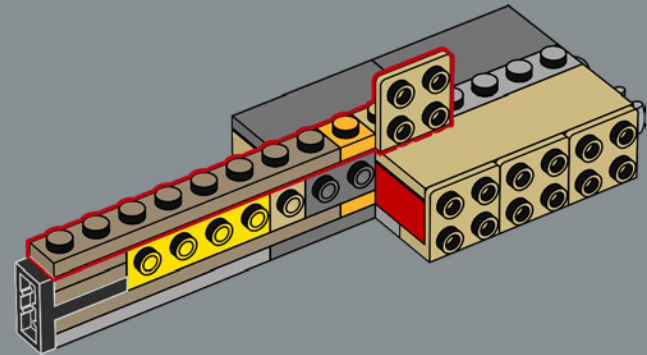

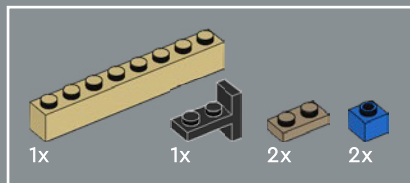

61

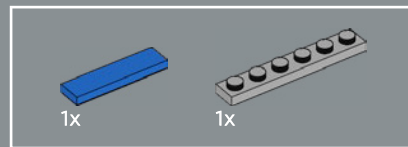
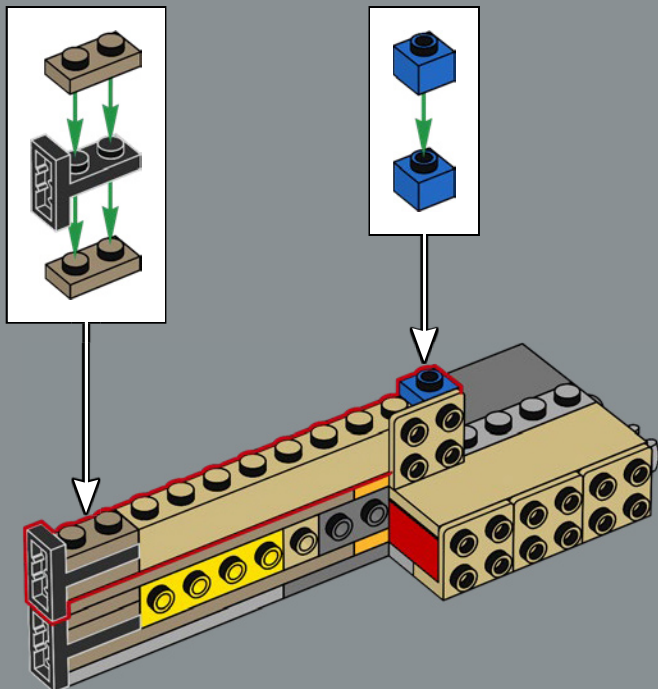

62

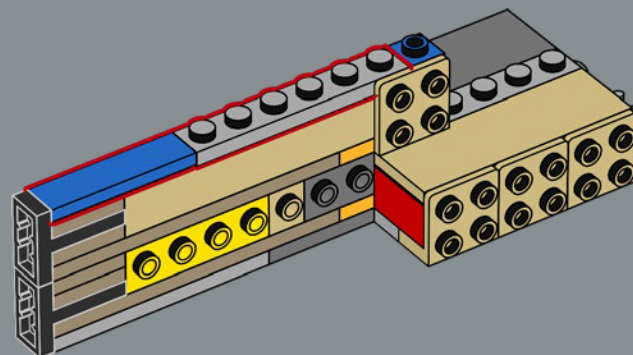

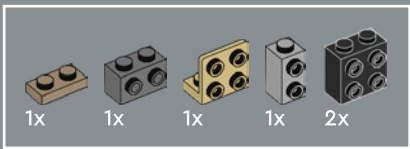

63

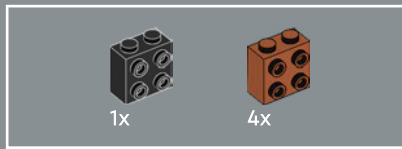
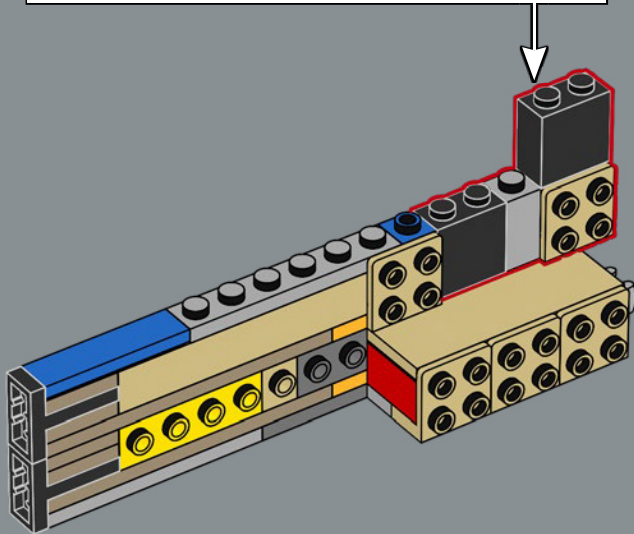
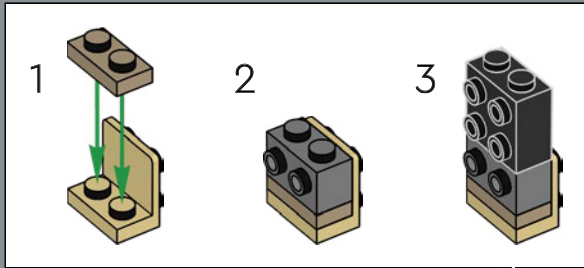

64

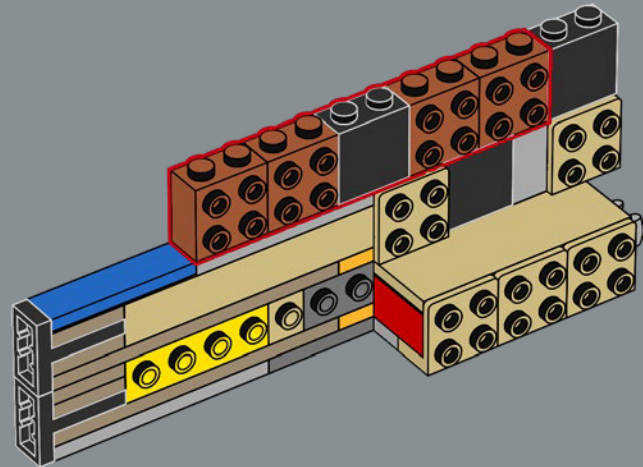

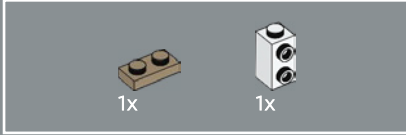
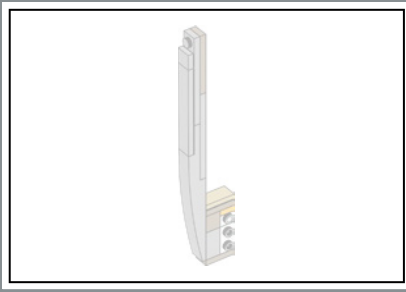

65

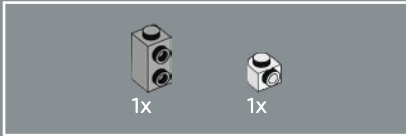
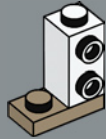

66

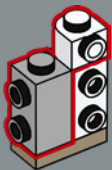

67

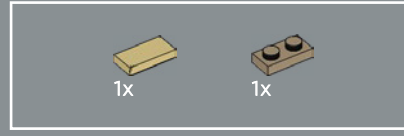

68

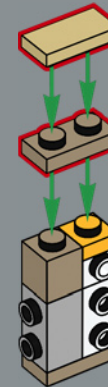

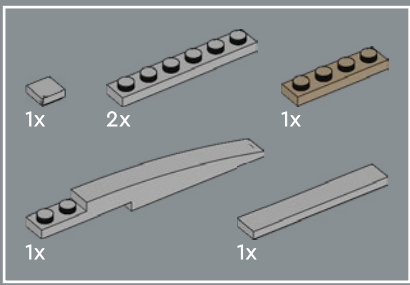

69

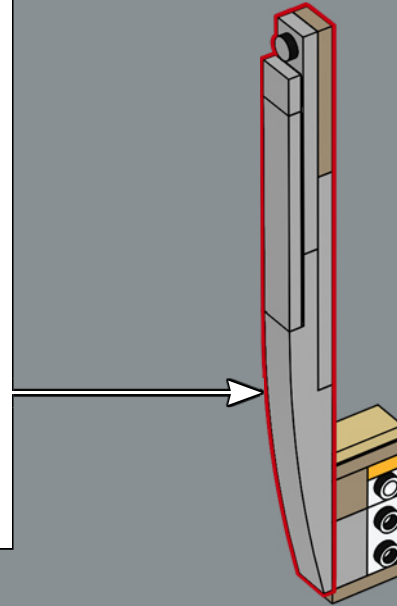
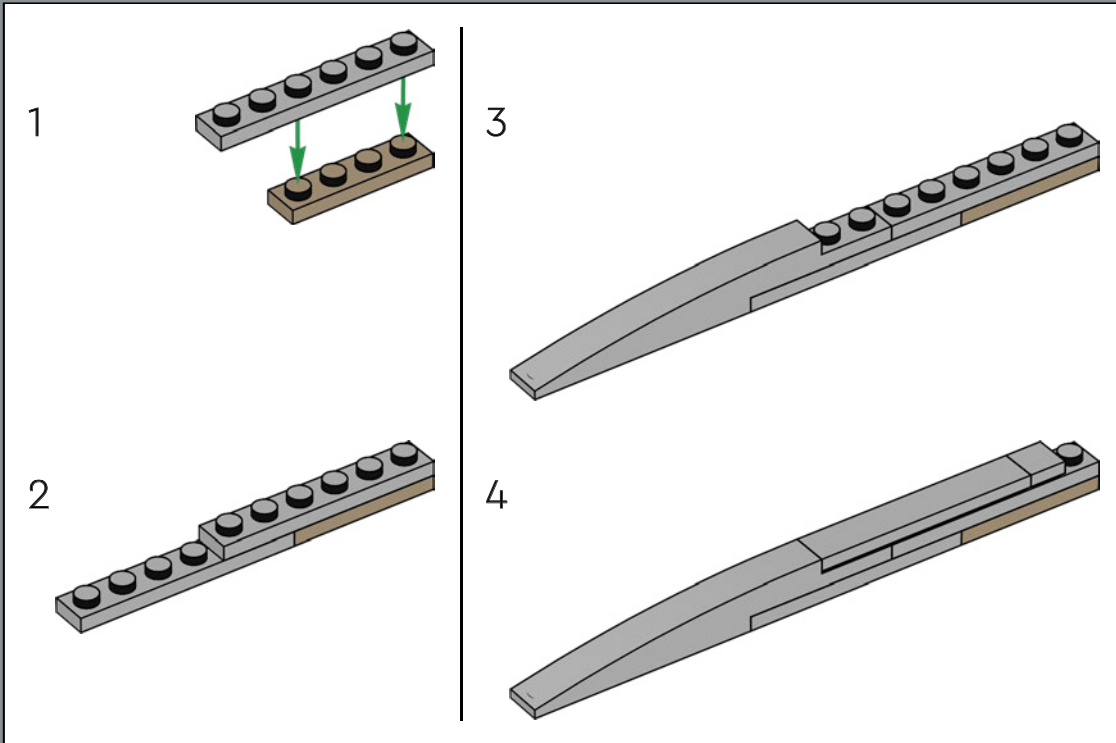

70

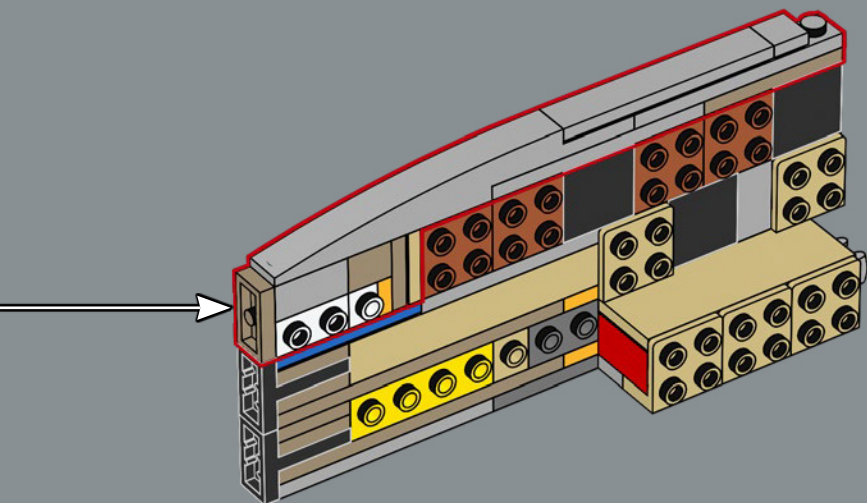

71

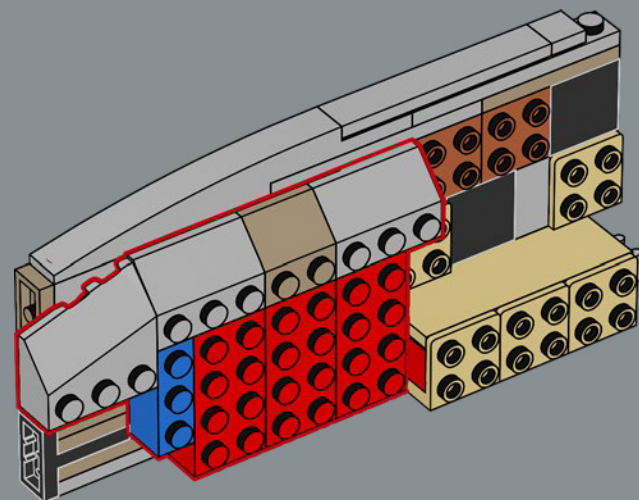
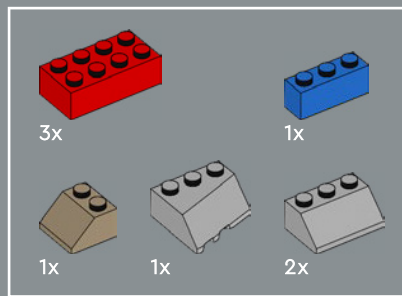

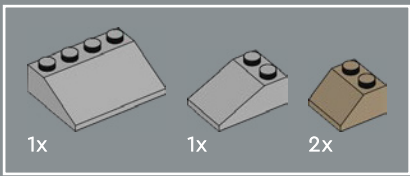

72

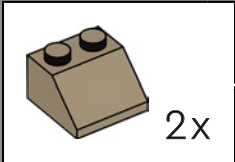
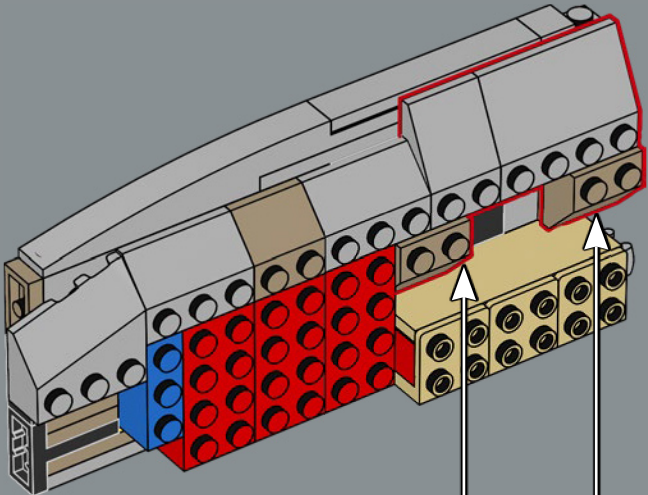

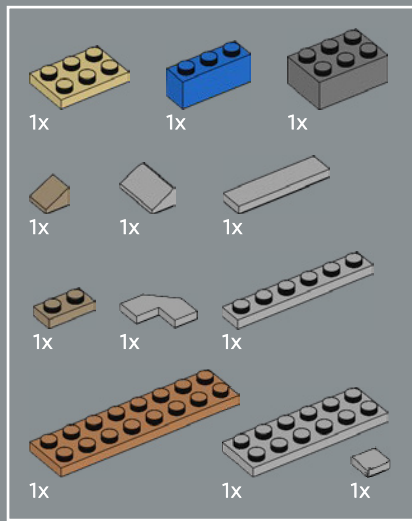

73

1

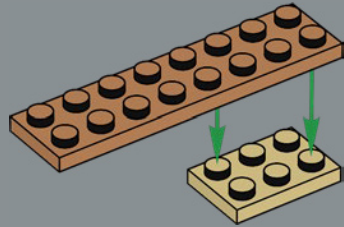

2

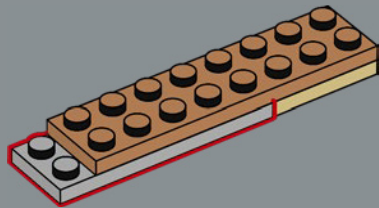

3

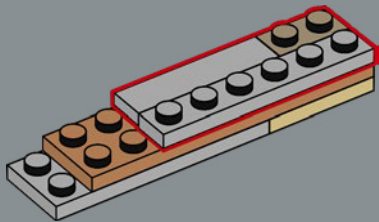

4

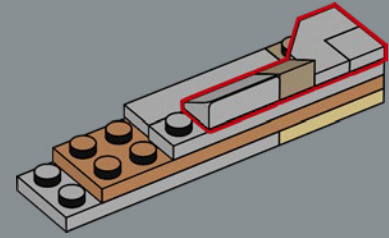

5

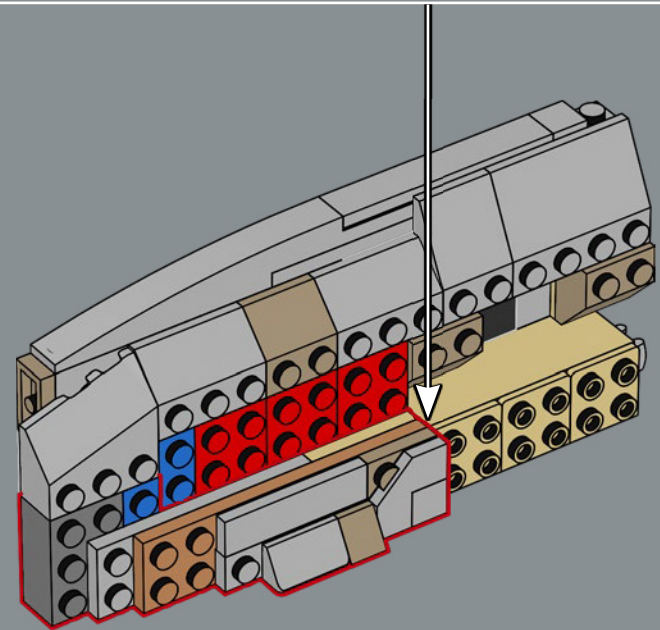
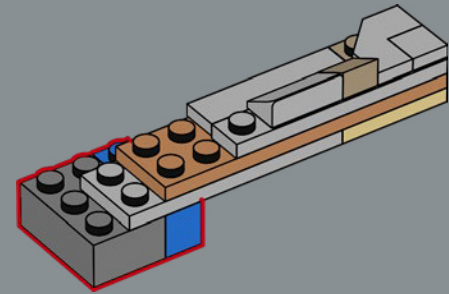

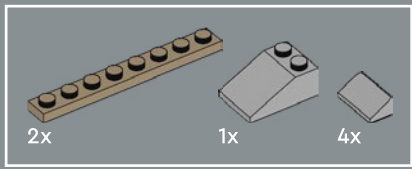

74

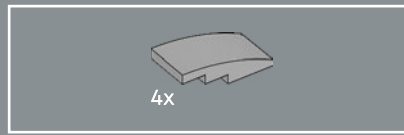
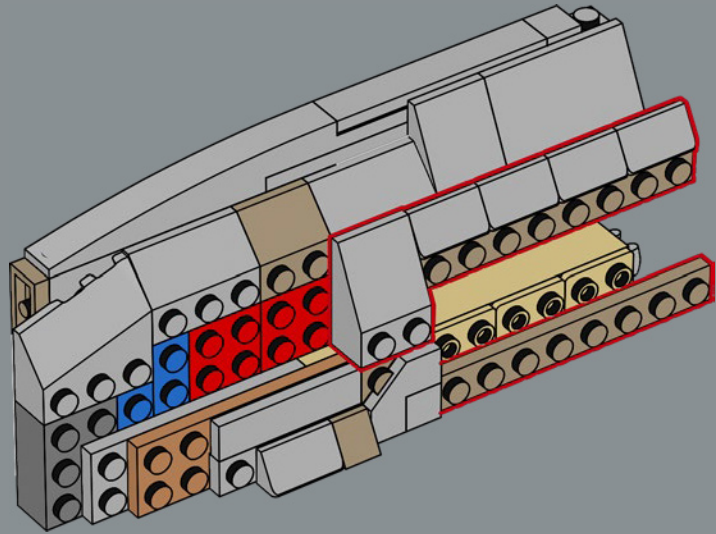

75

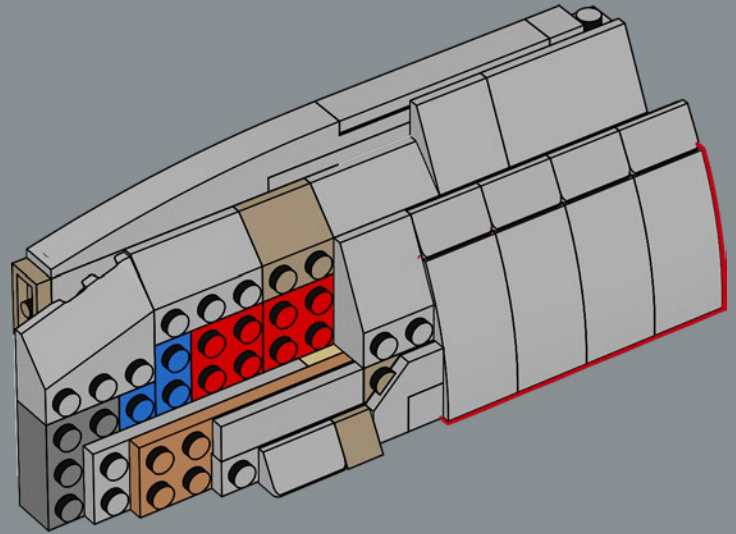

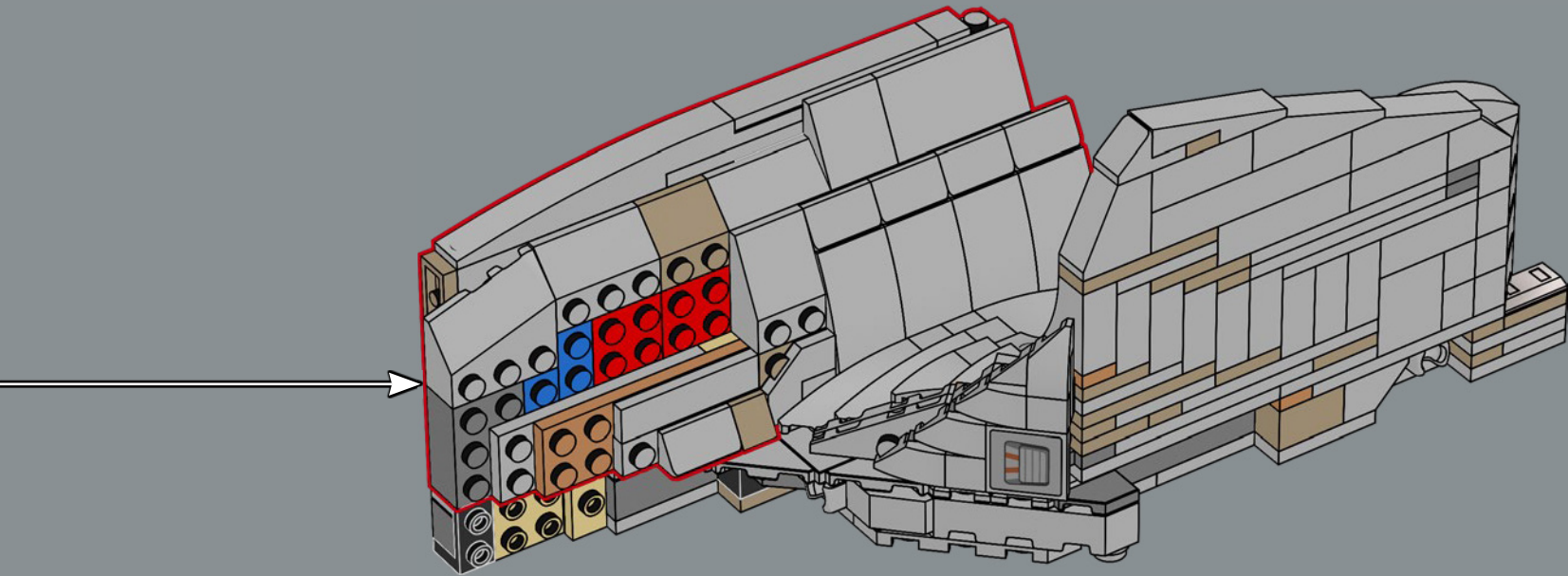

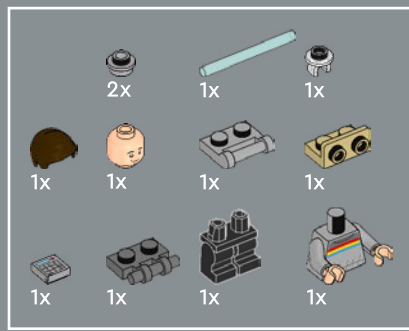

Wesley Crusher, an avid young science prodigy, created the portable tractor-beam generator as a science project.

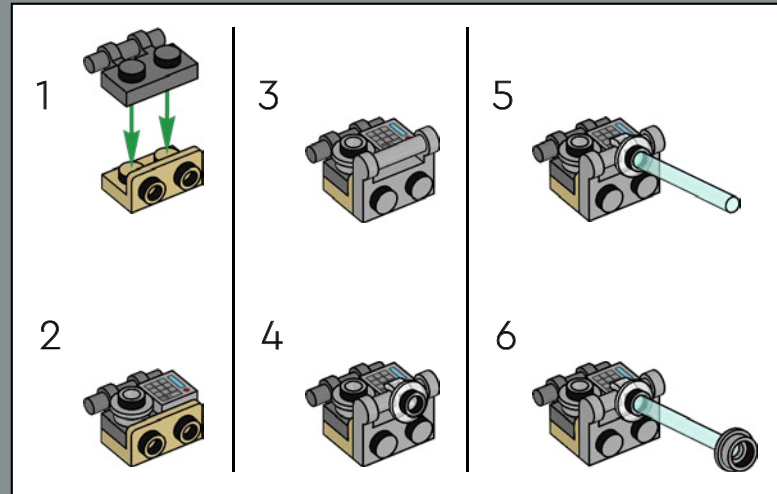
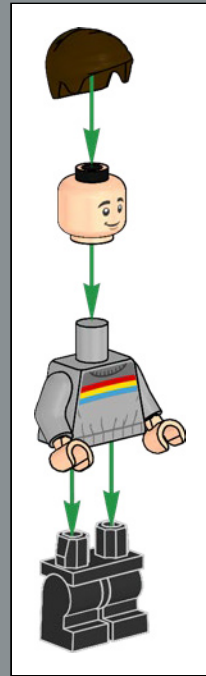

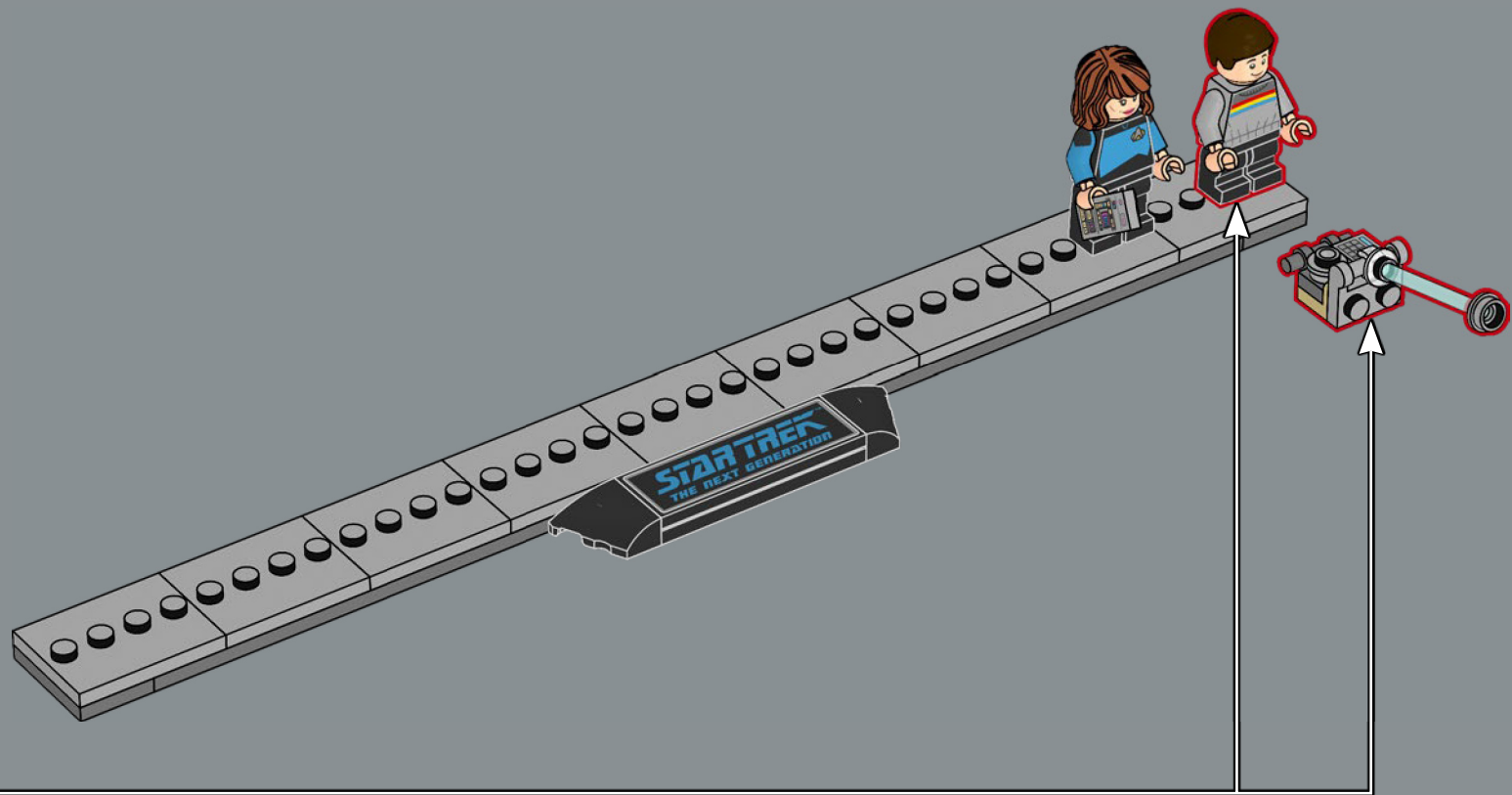

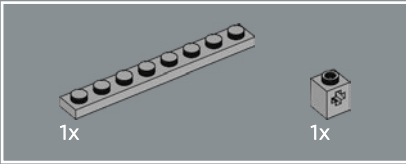
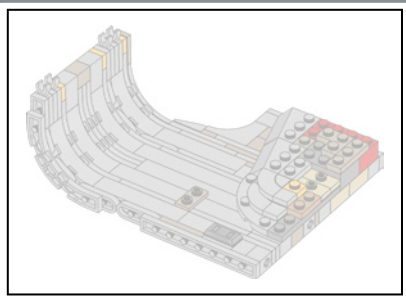

77

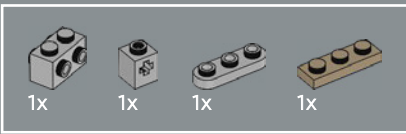
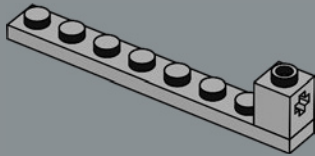

78

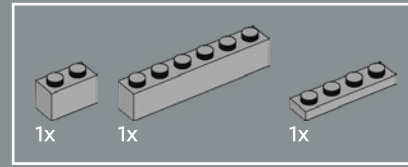
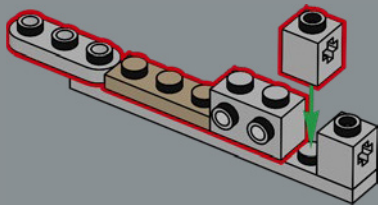

79

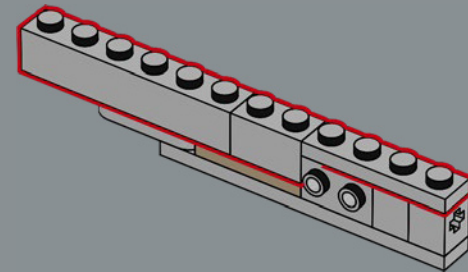

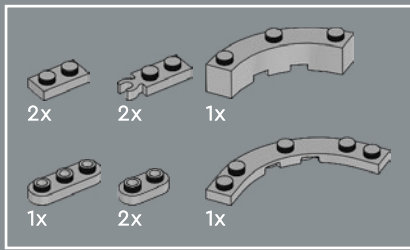

80

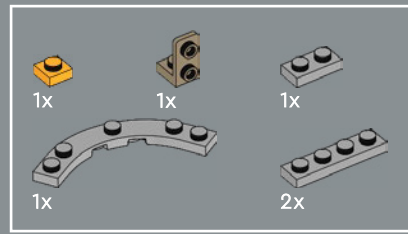
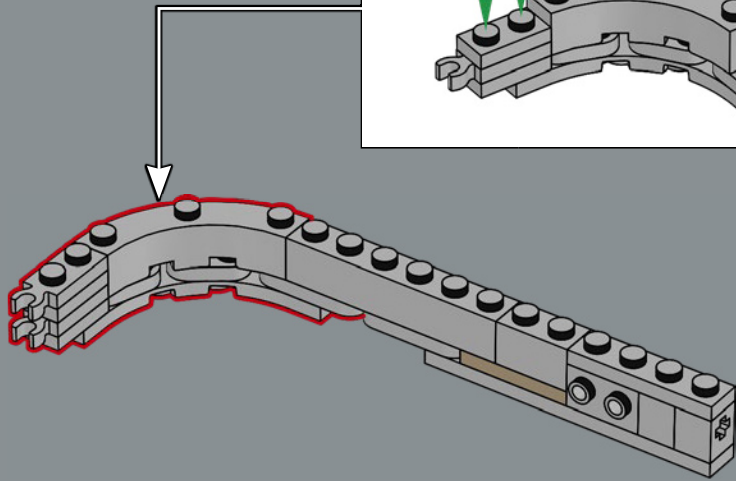
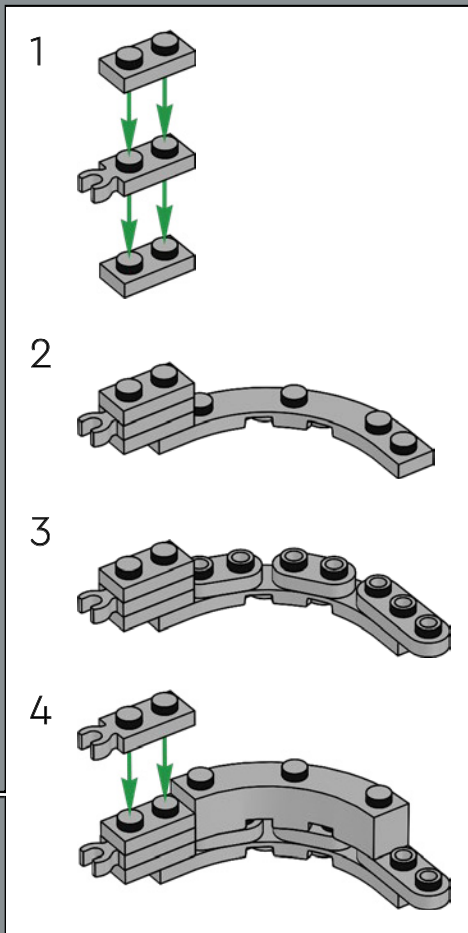

81

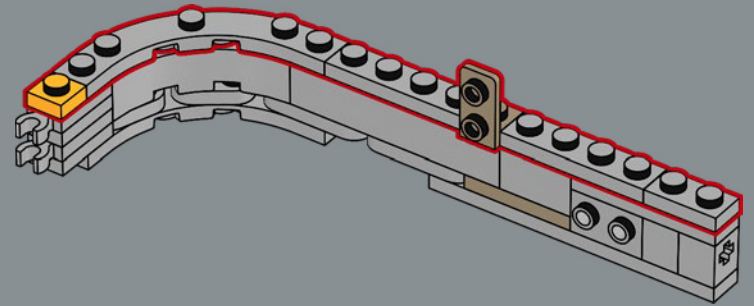

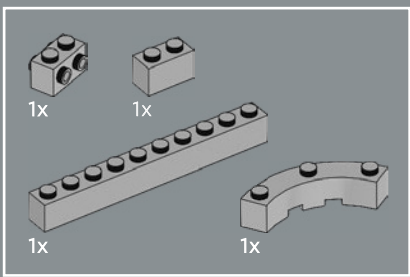

82

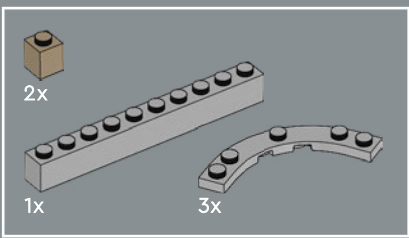
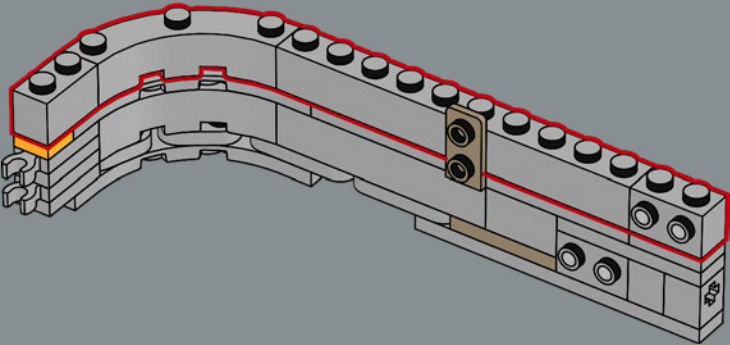

83

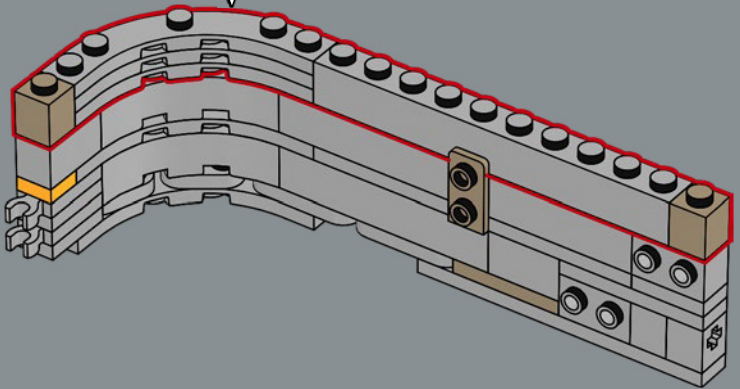
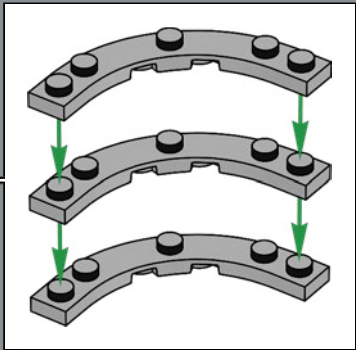

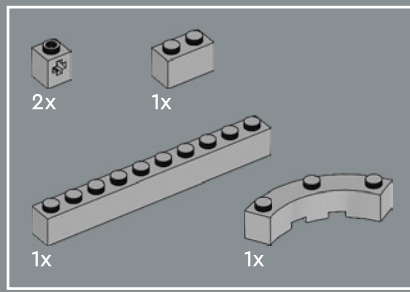

84

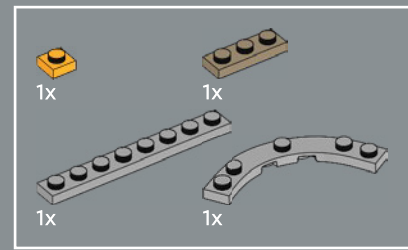
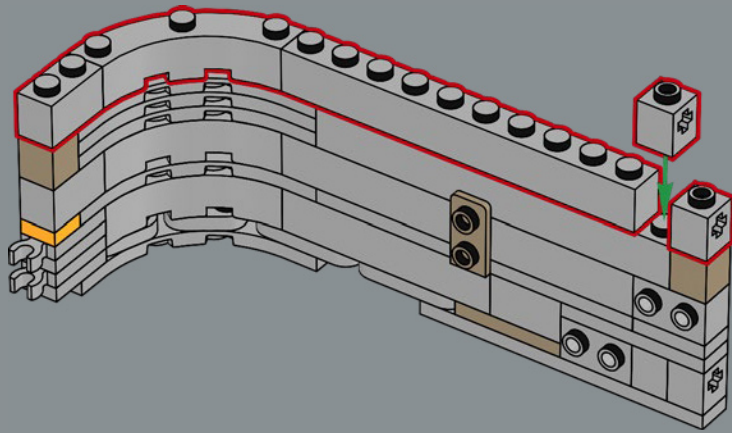

85

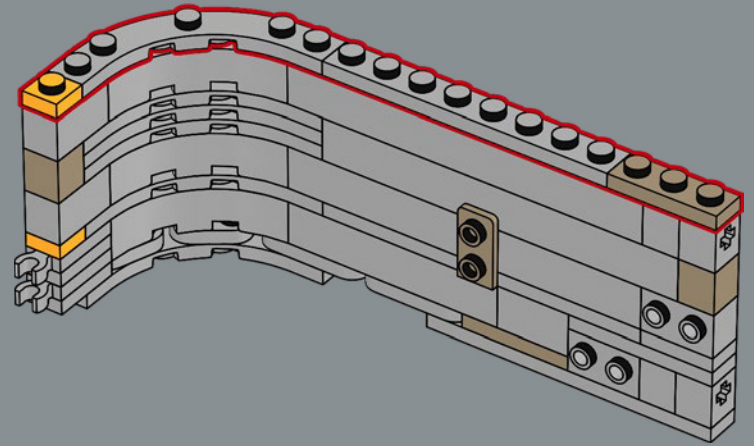

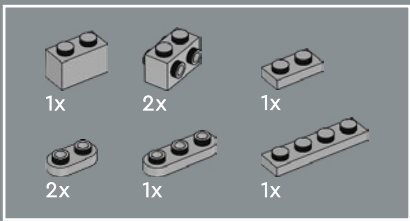

86

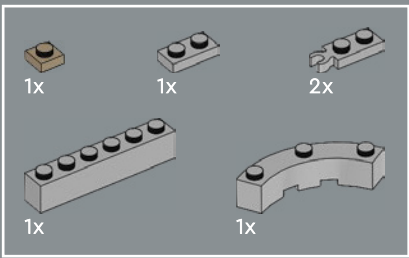
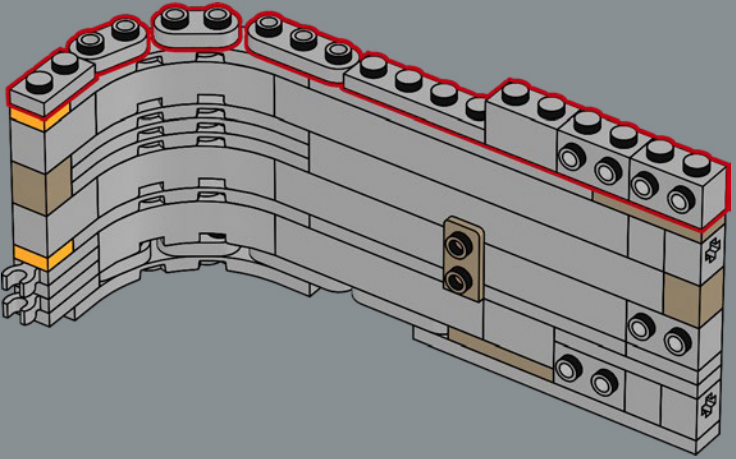

87

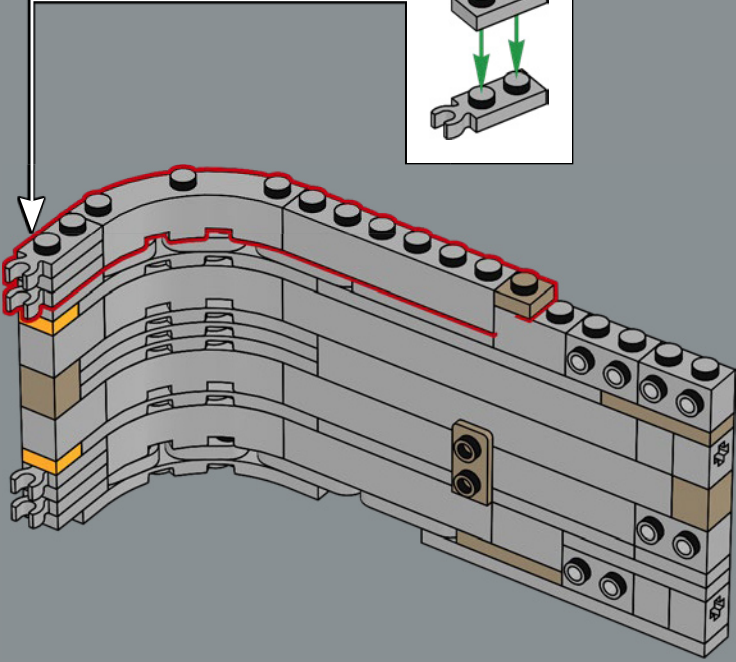
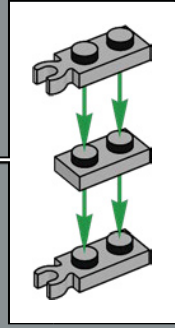

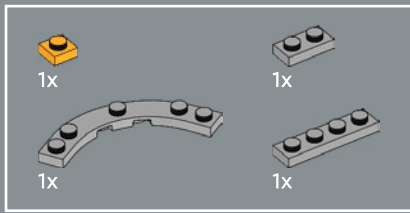

88

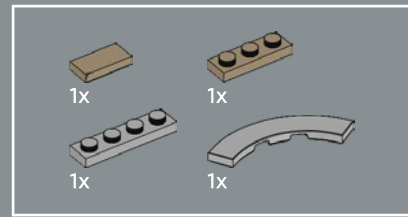
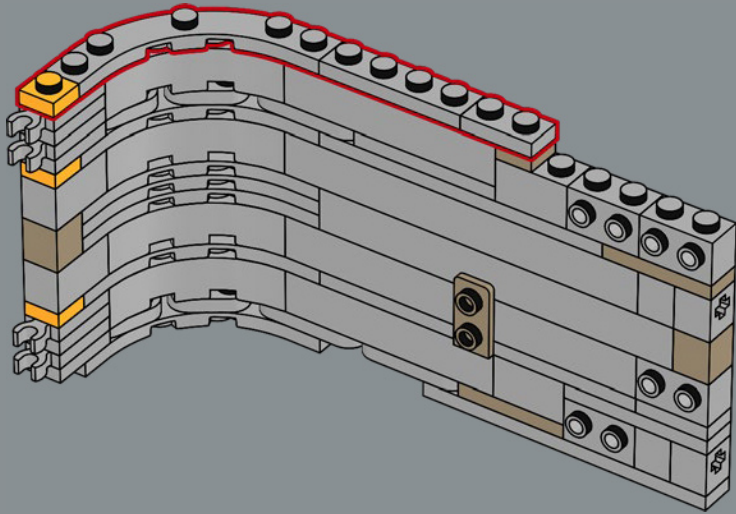

89

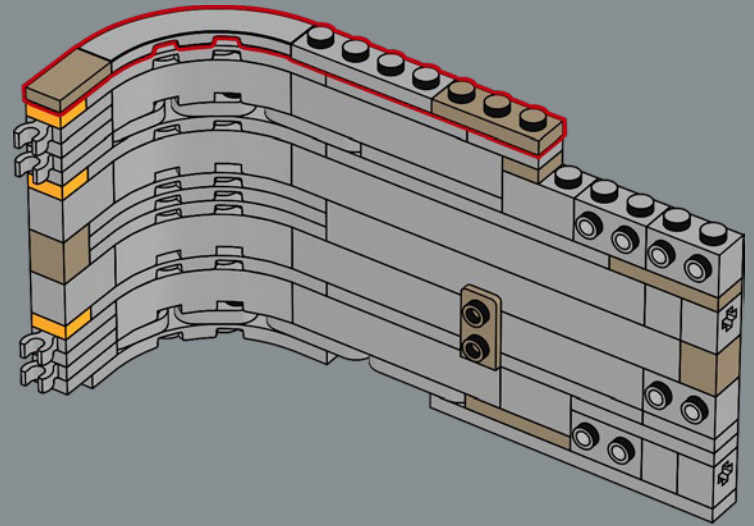

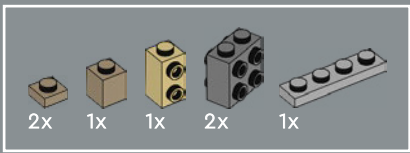

90

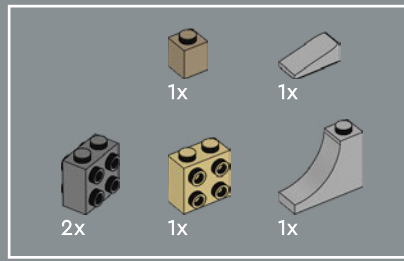
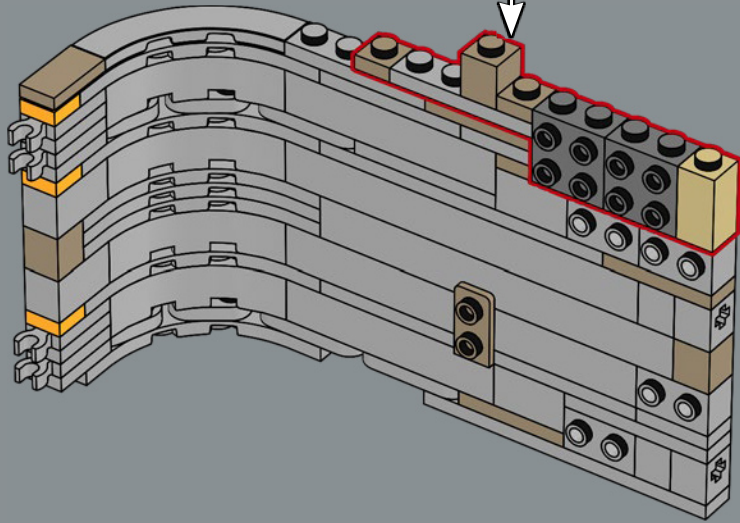
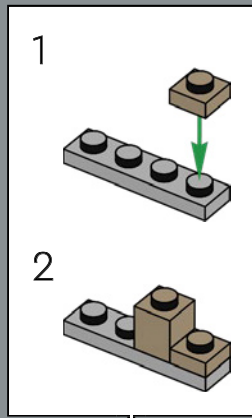

91

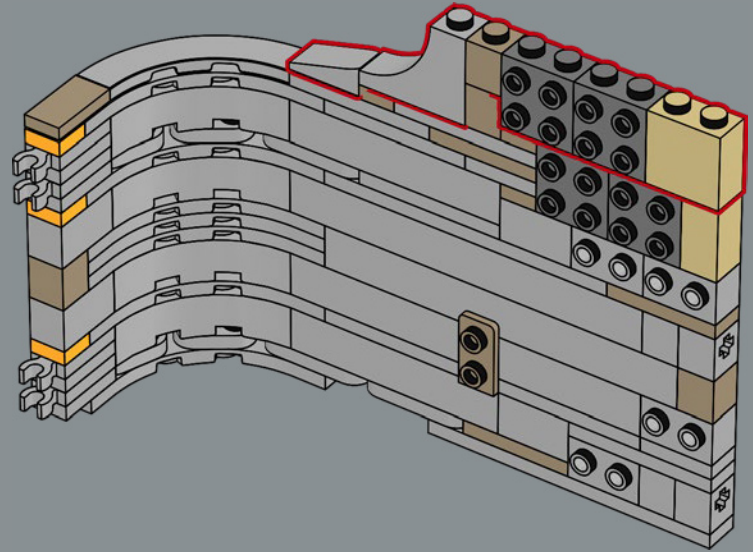

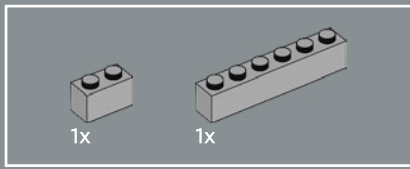

92

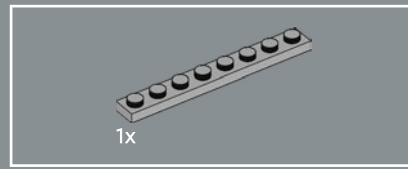
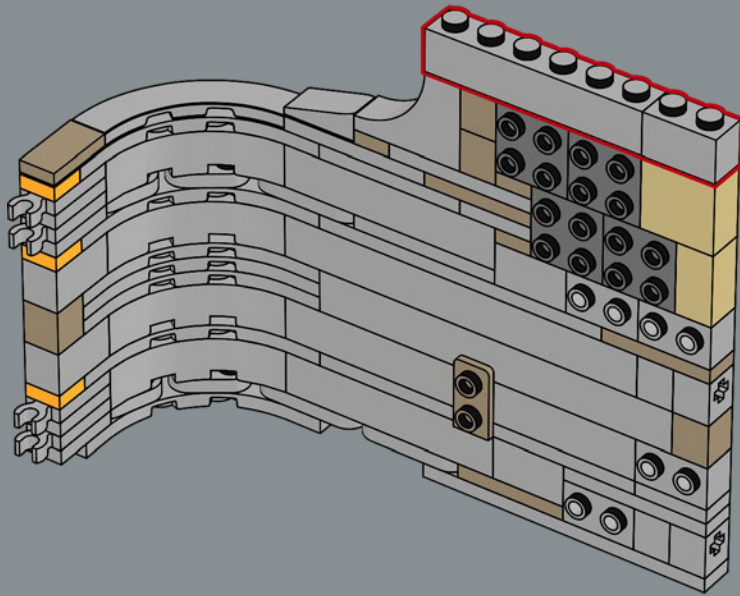

93

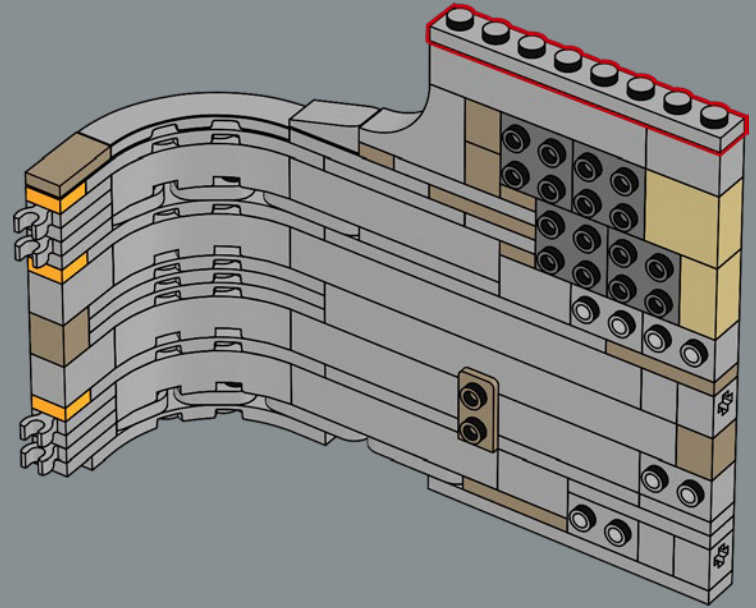

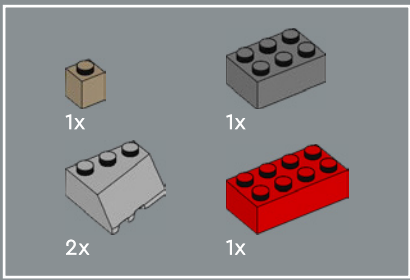

94

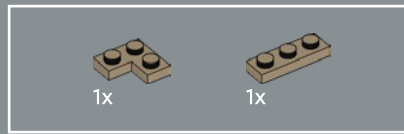
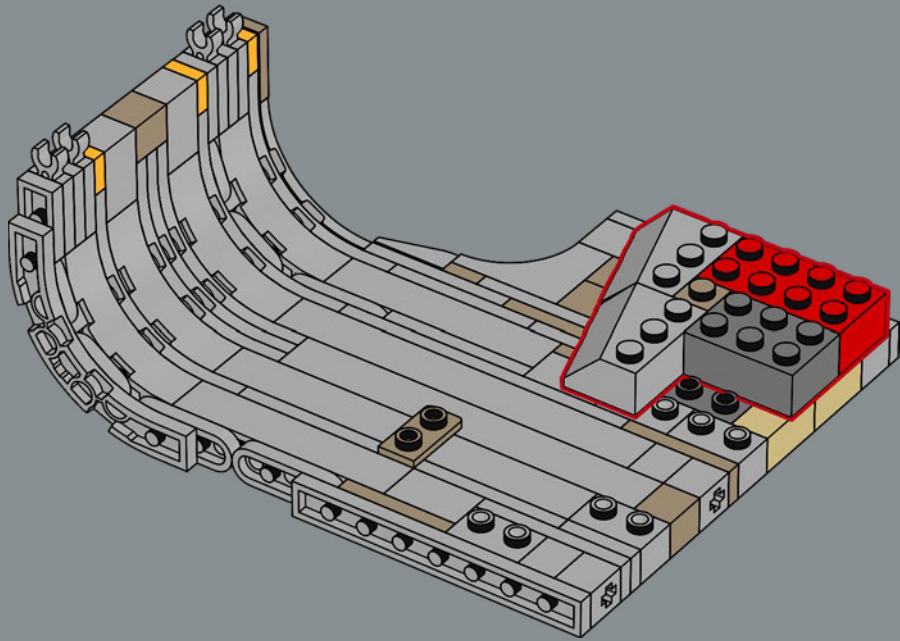

95

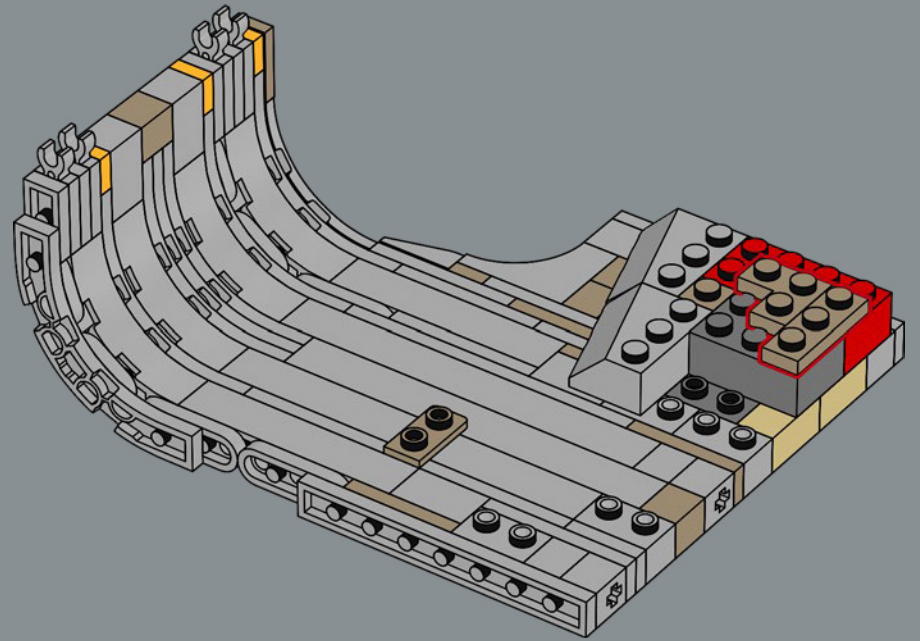

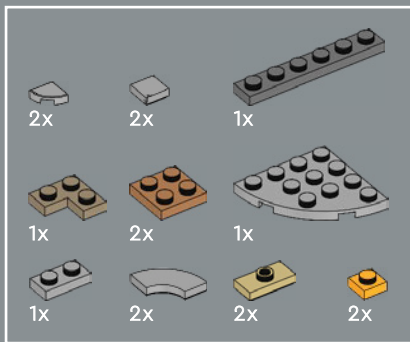

96

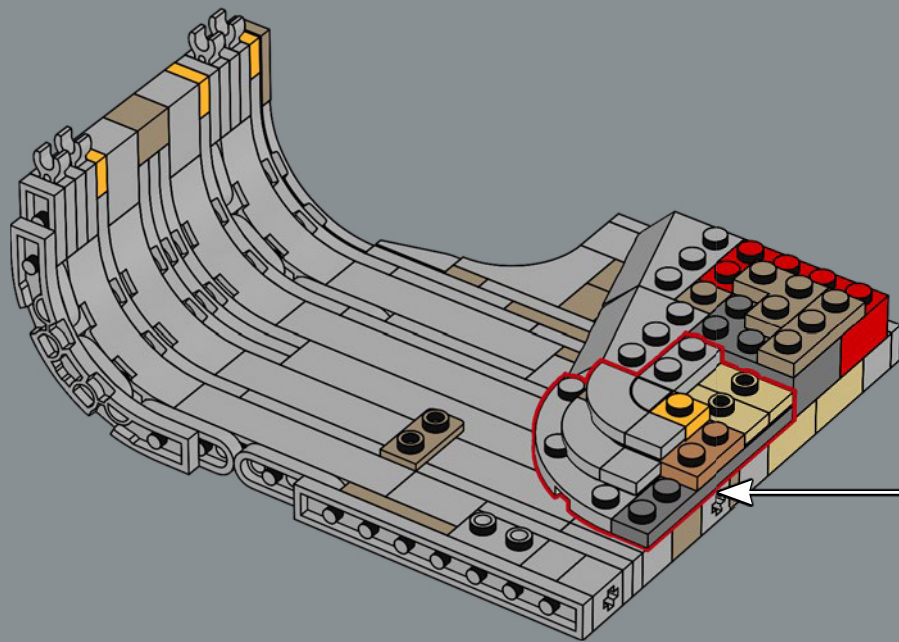
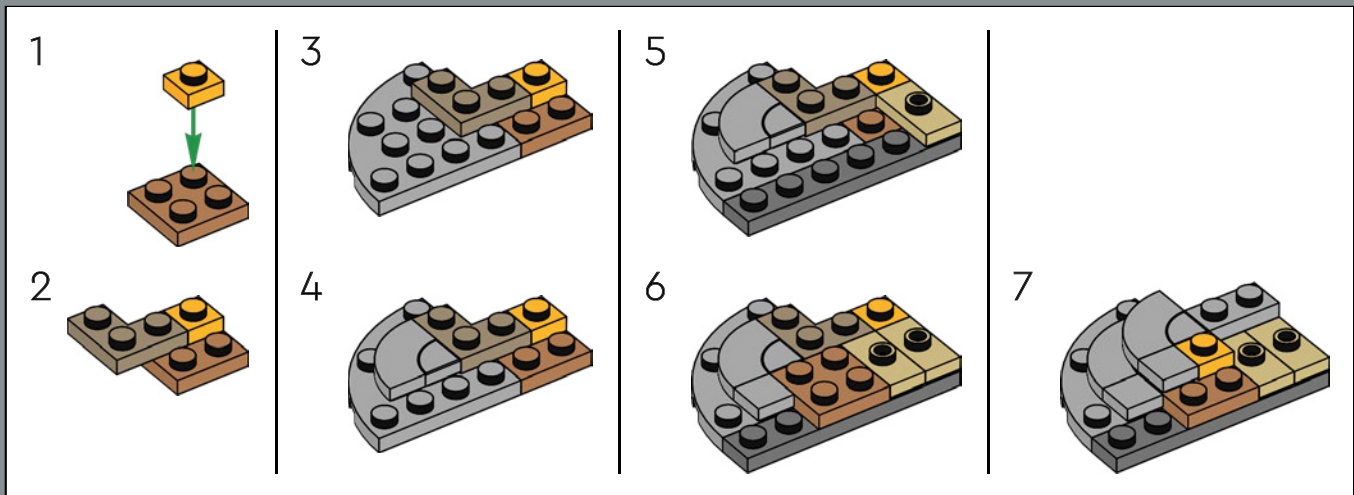



2x

97

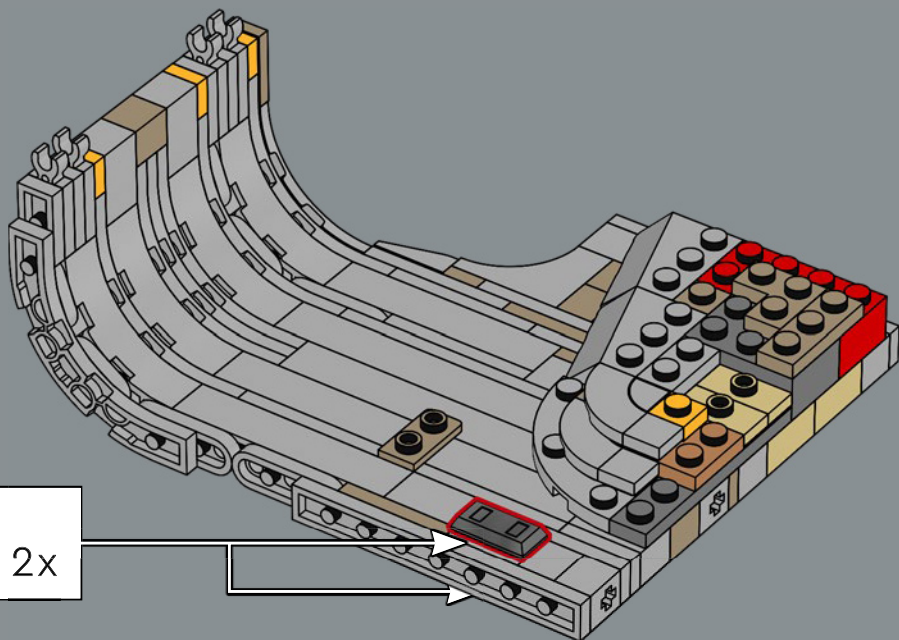

2x



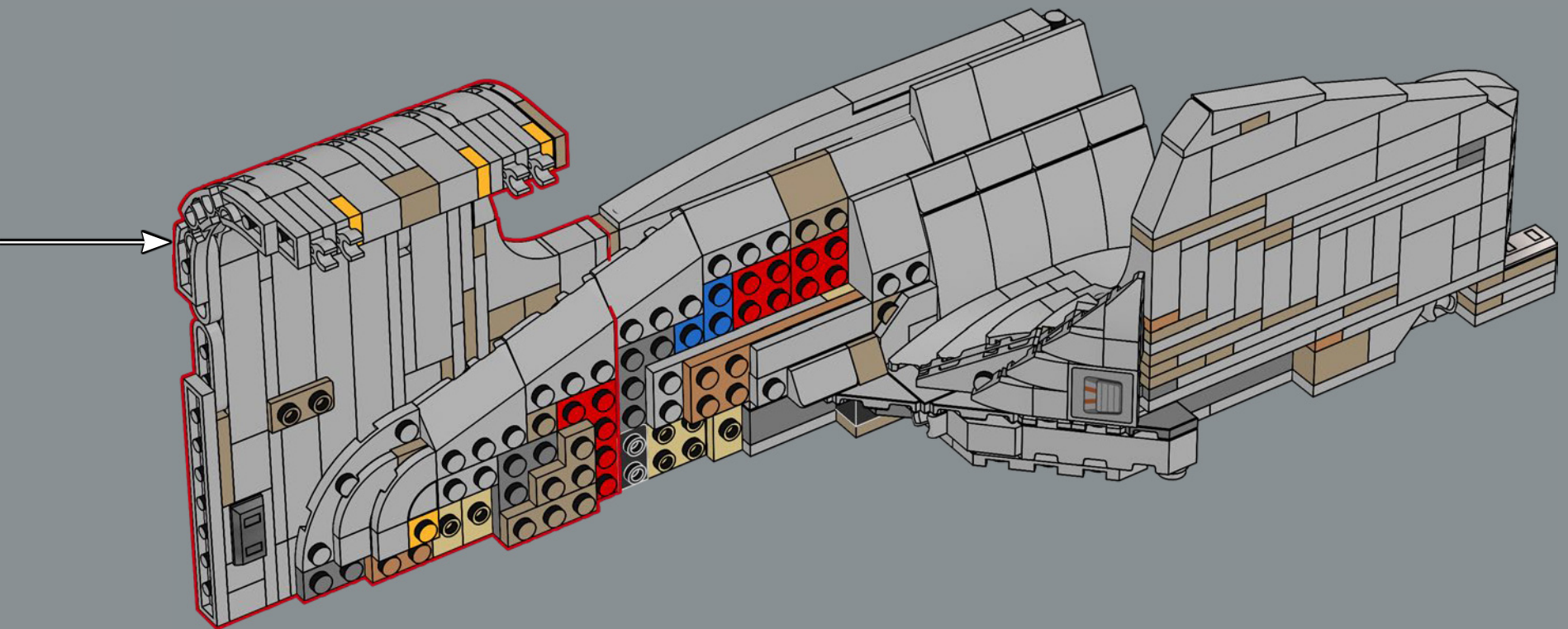

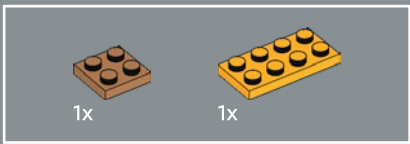

99

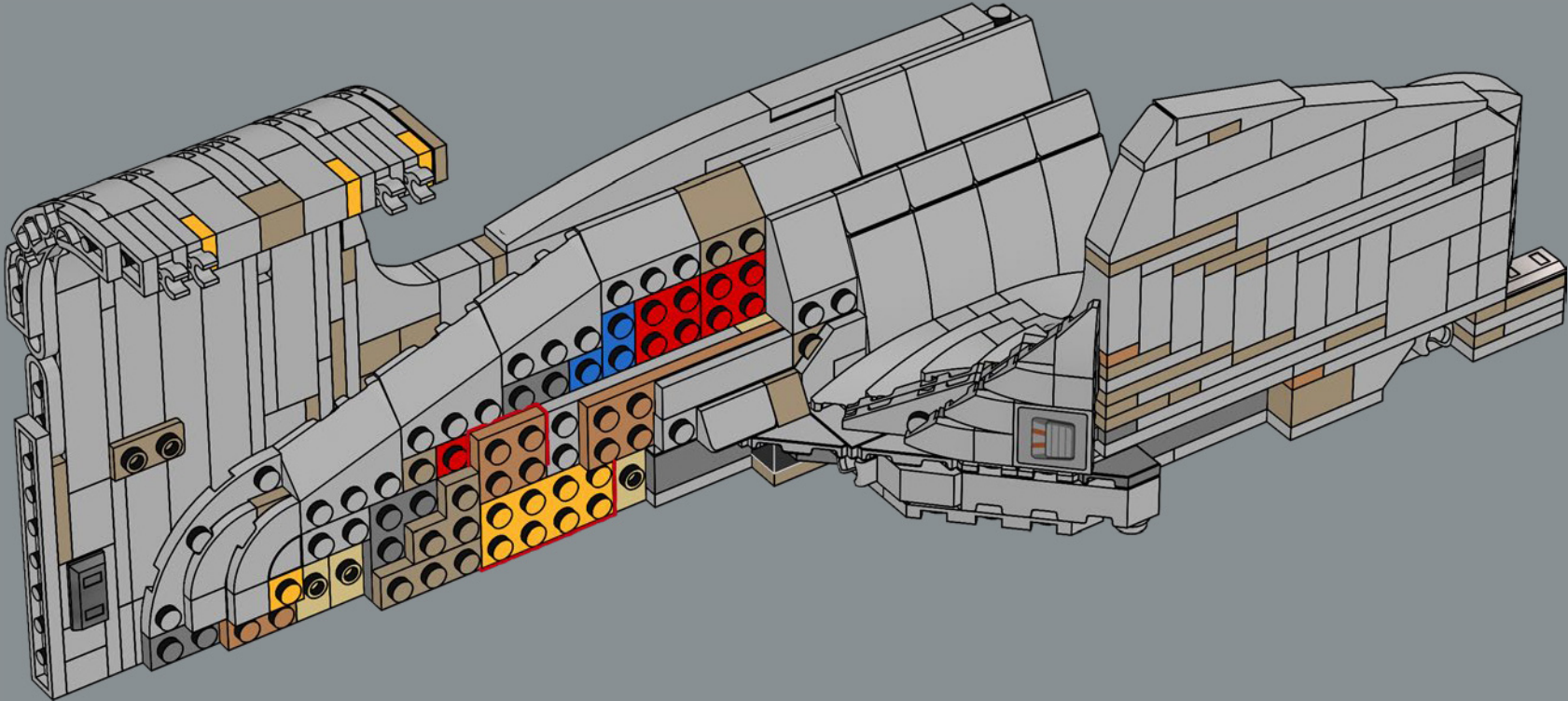

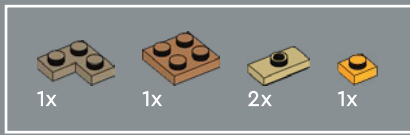

100

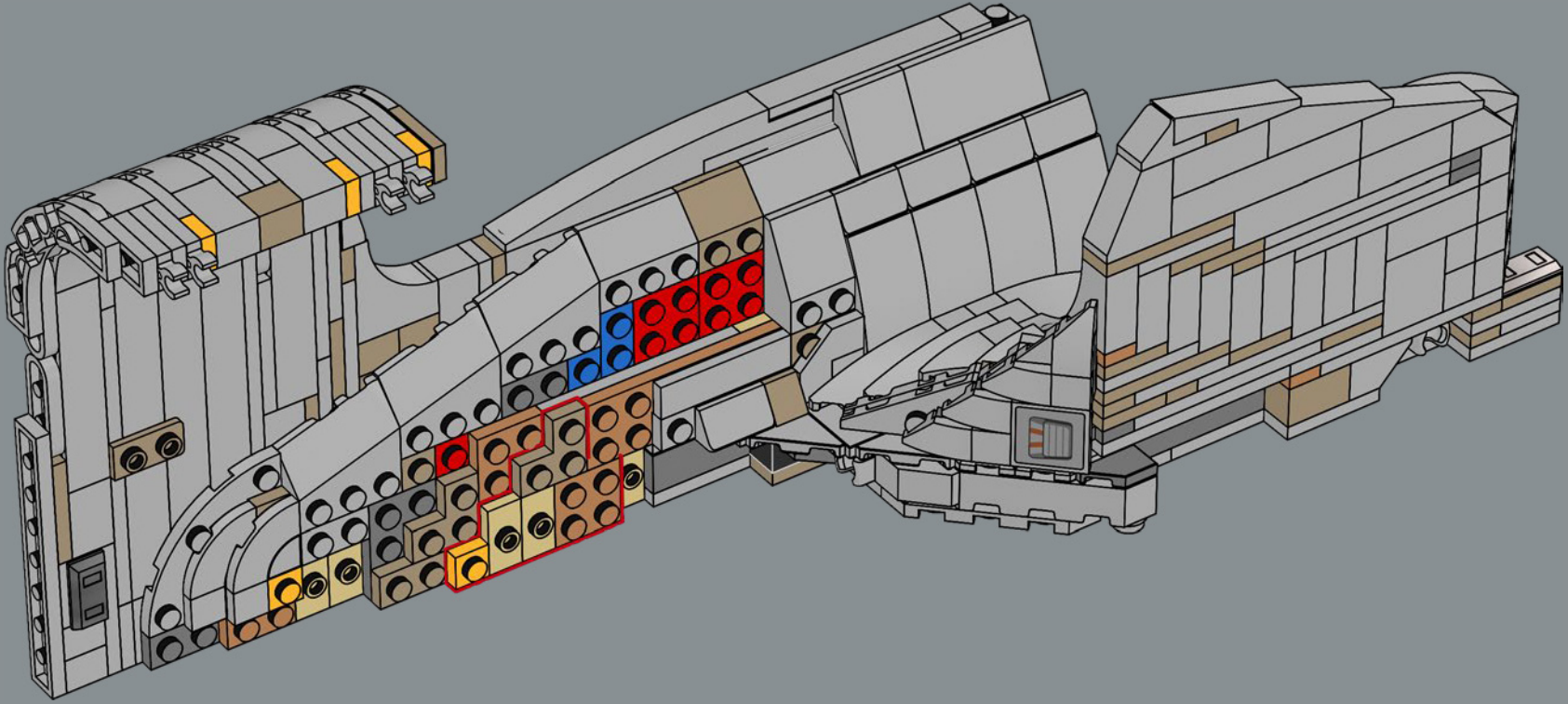

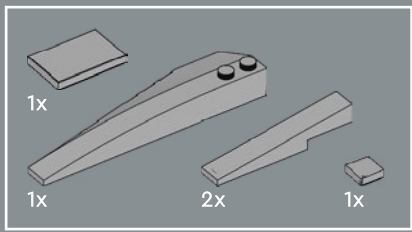

101

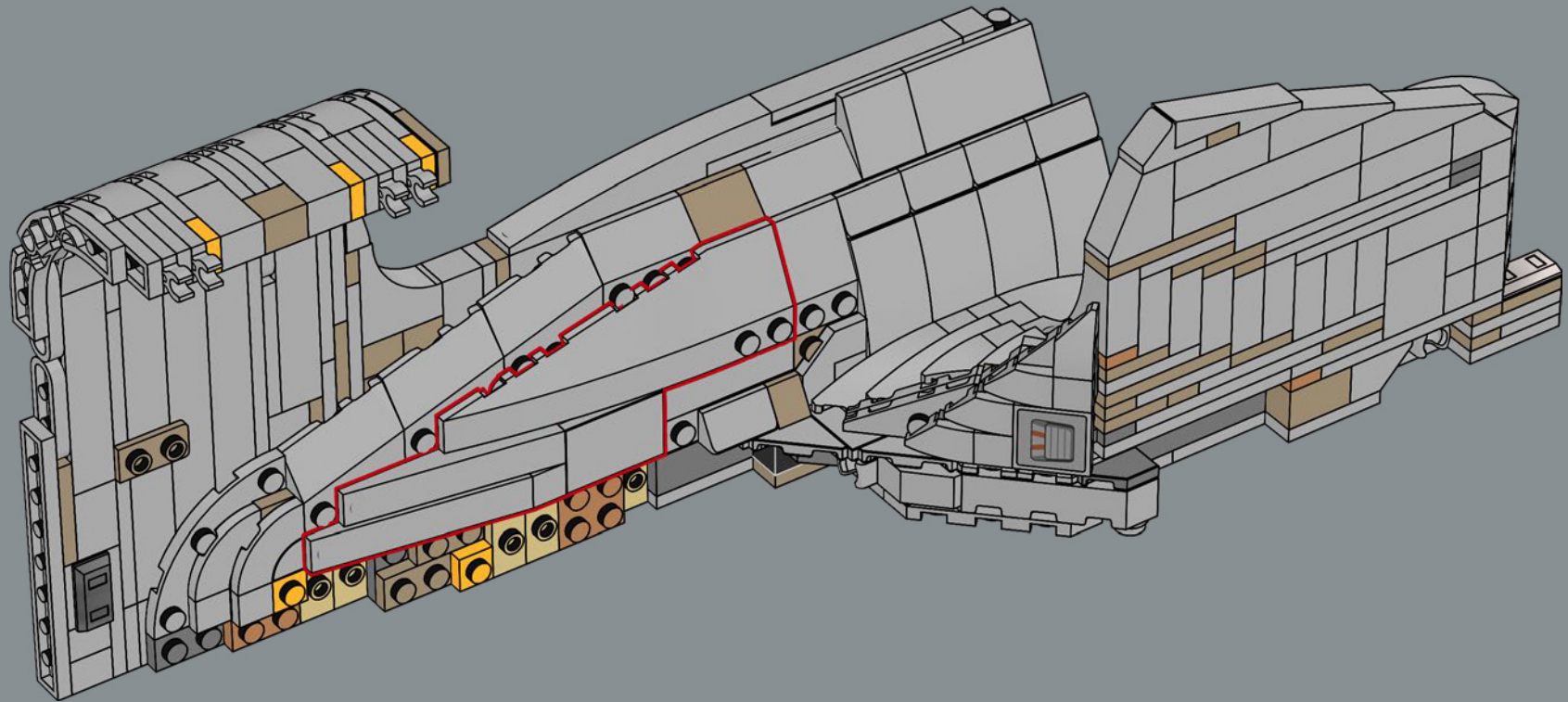

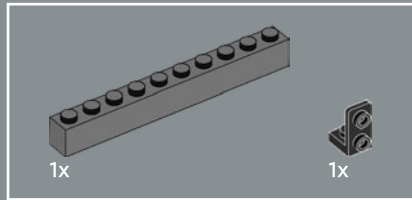

102

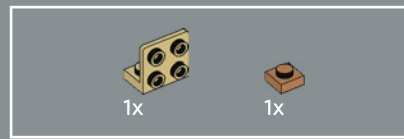
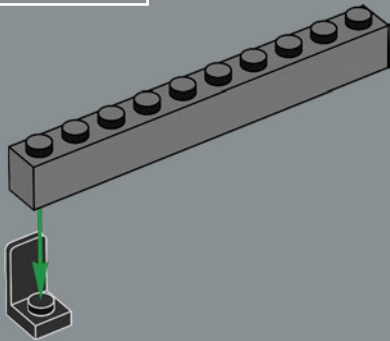

103

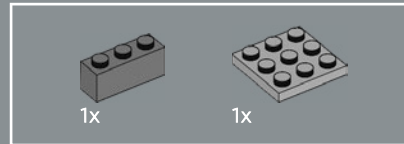
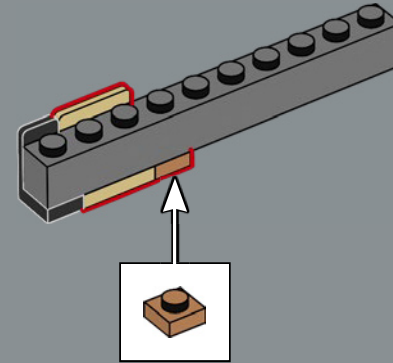

104

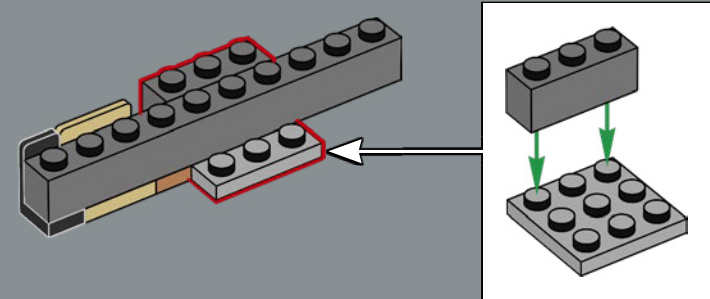

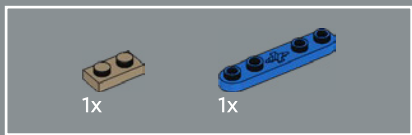

105

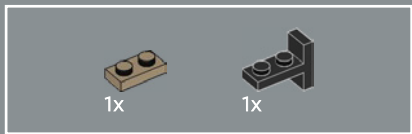
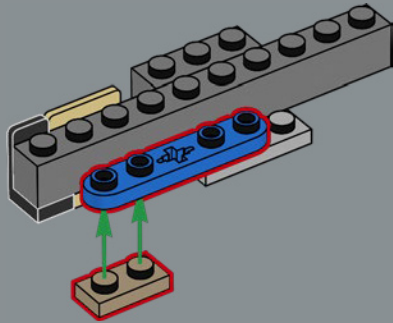

106

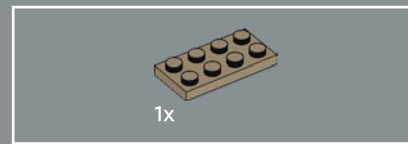
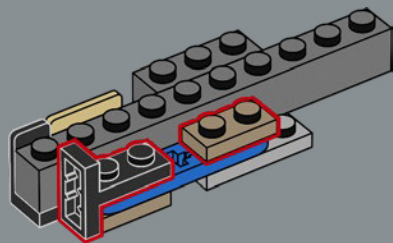

107

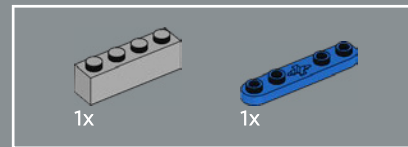
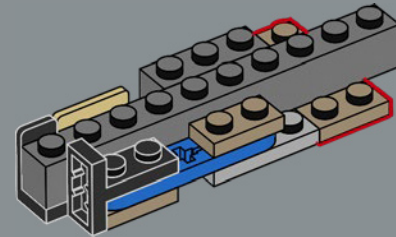

108

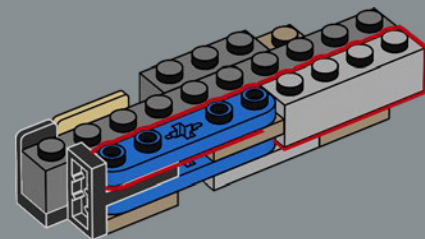

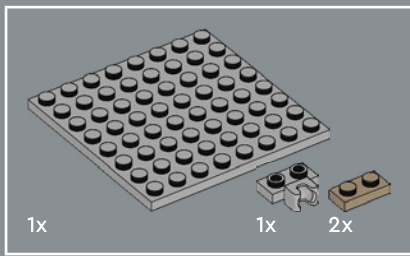

109

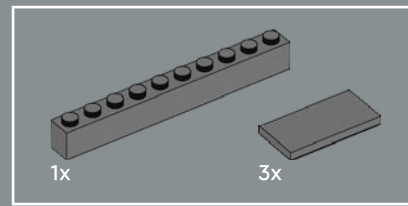
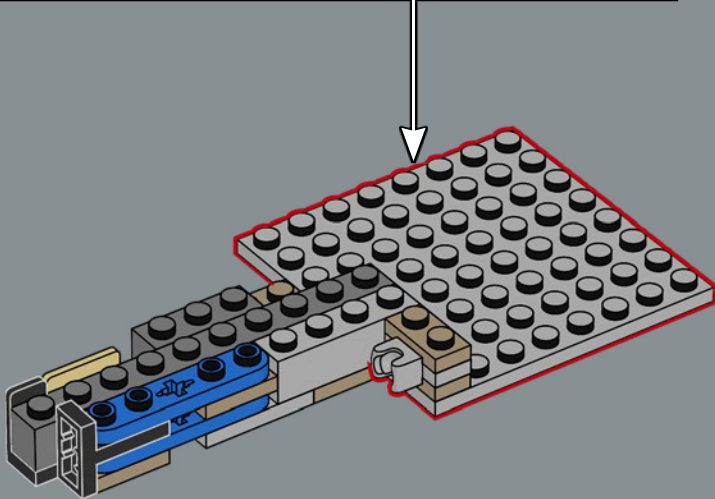
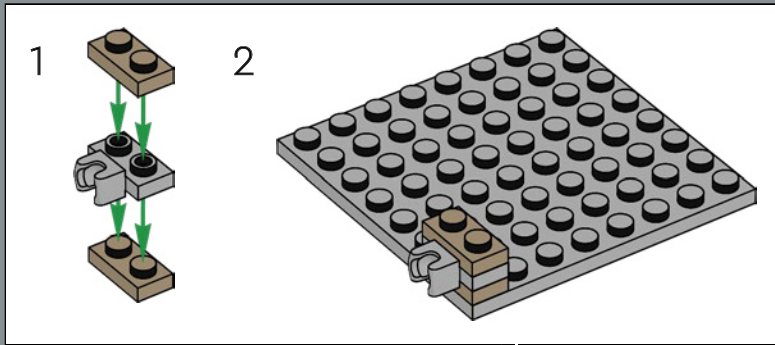

110

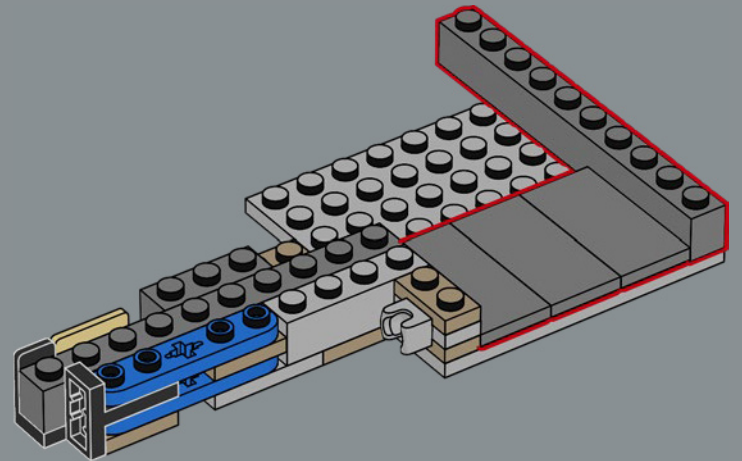

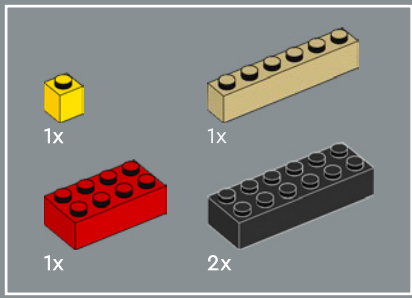

111

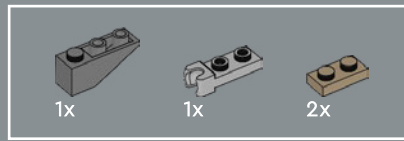
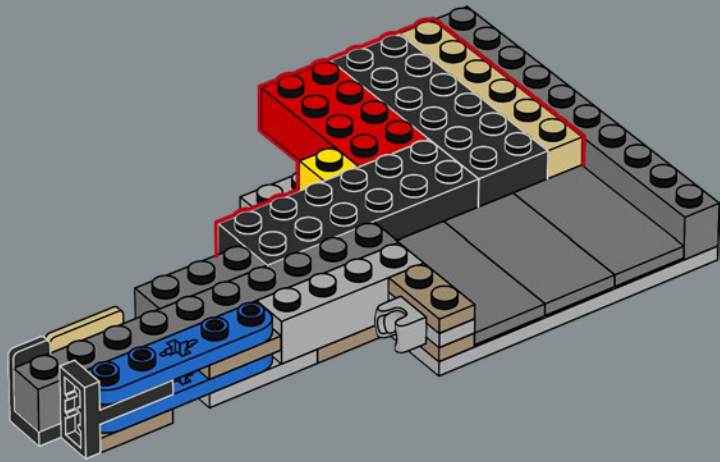

112

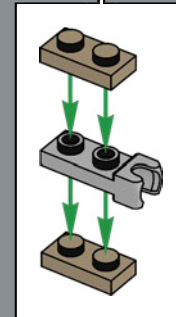
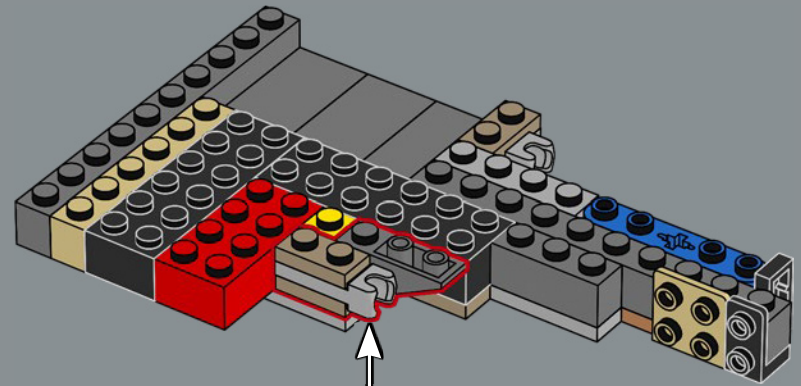

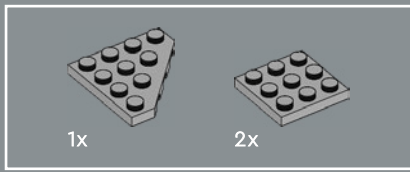

113

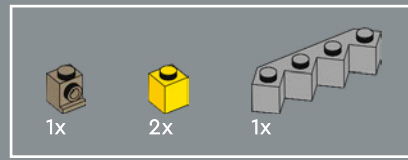
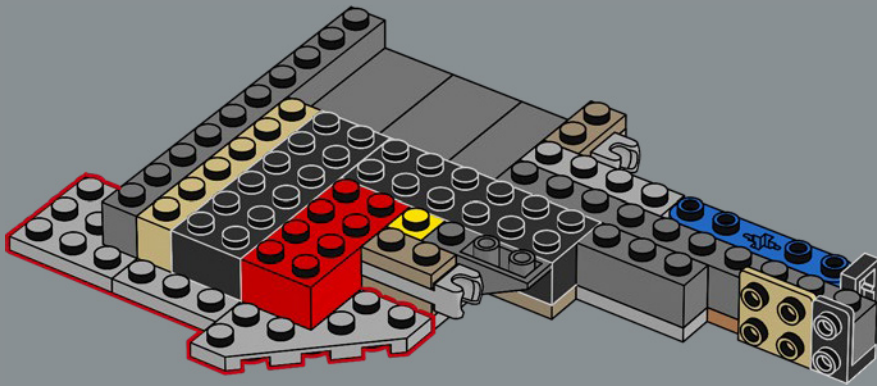

114

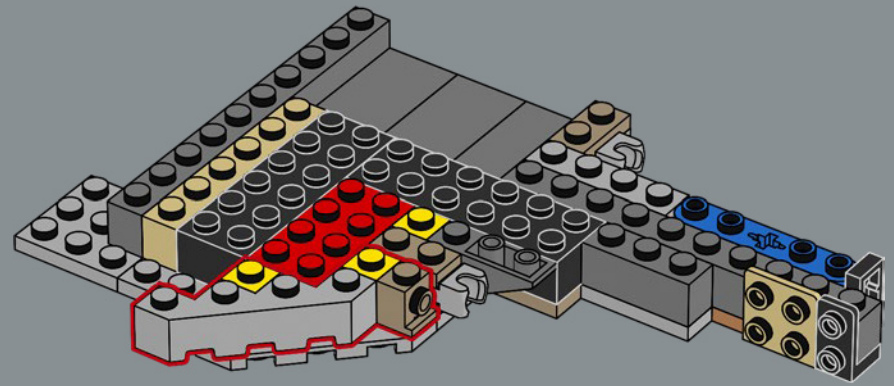

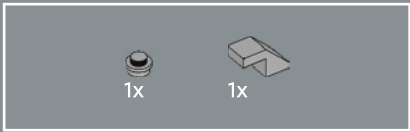

115

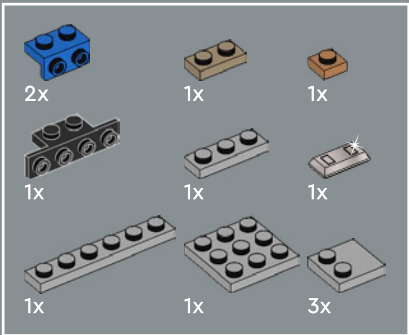
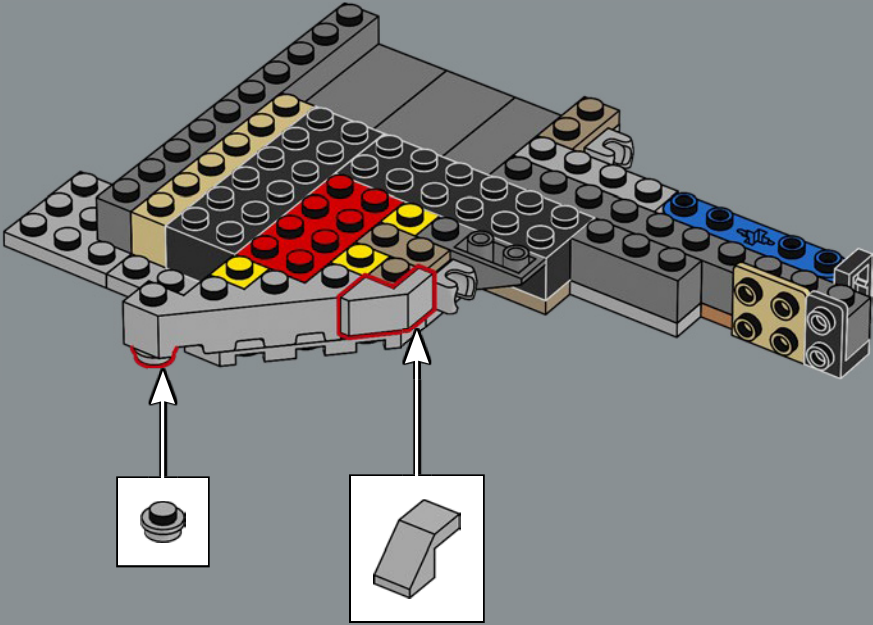

116

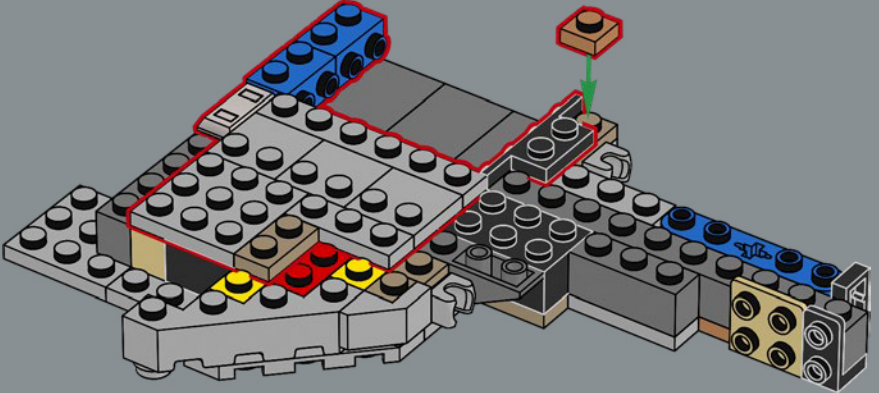

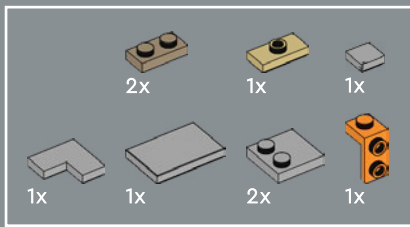

117

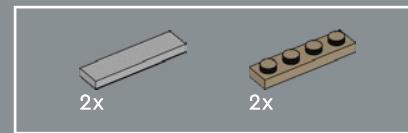
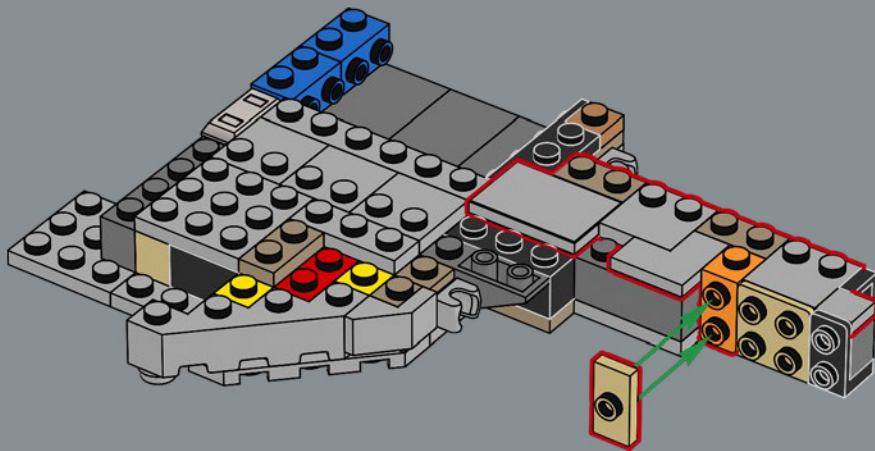

118

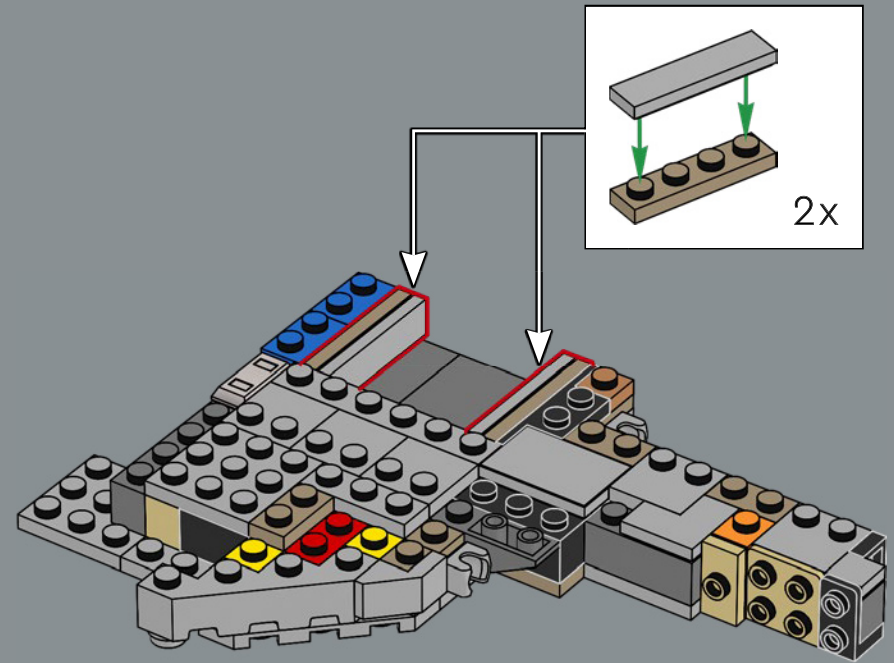

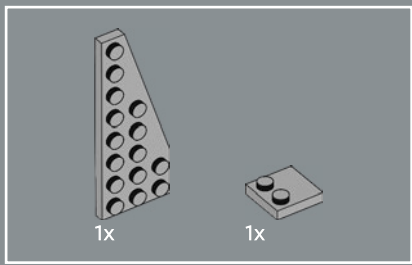

119

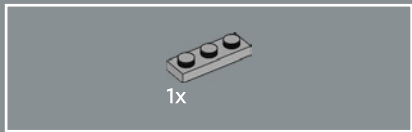
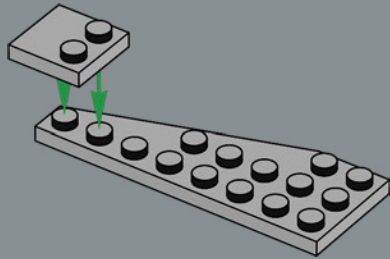

120

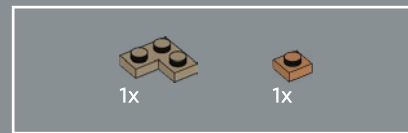
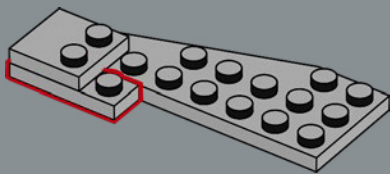

121

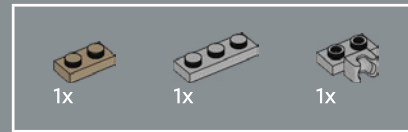
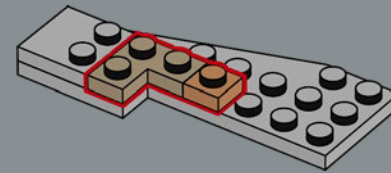

122

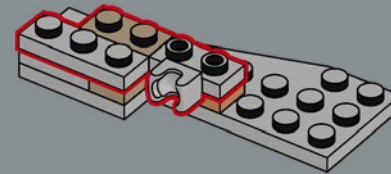

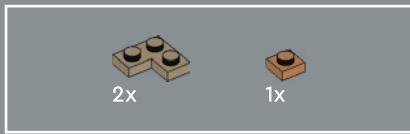

123

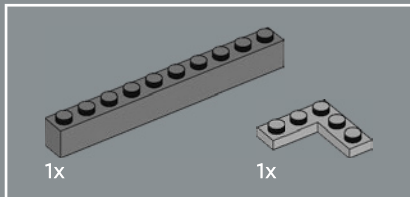
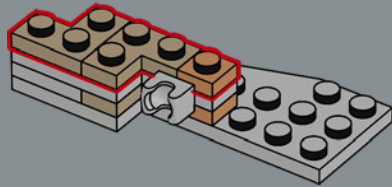

124

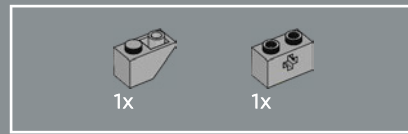
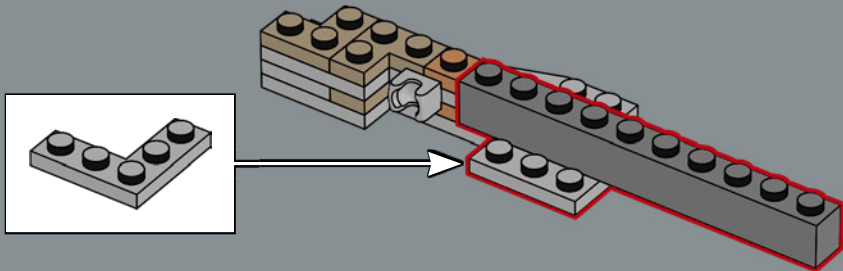

125

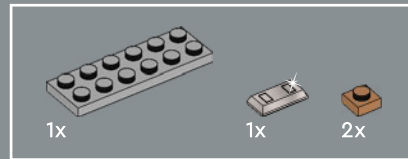
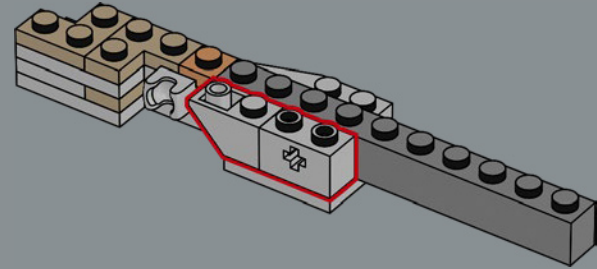

126

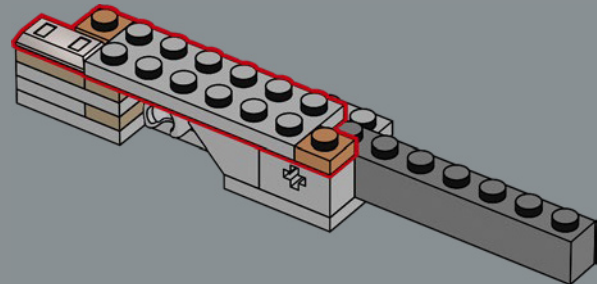

127

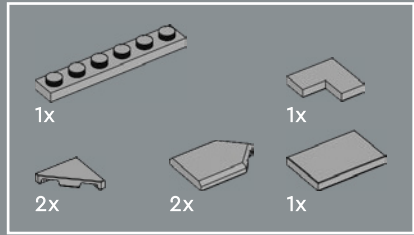
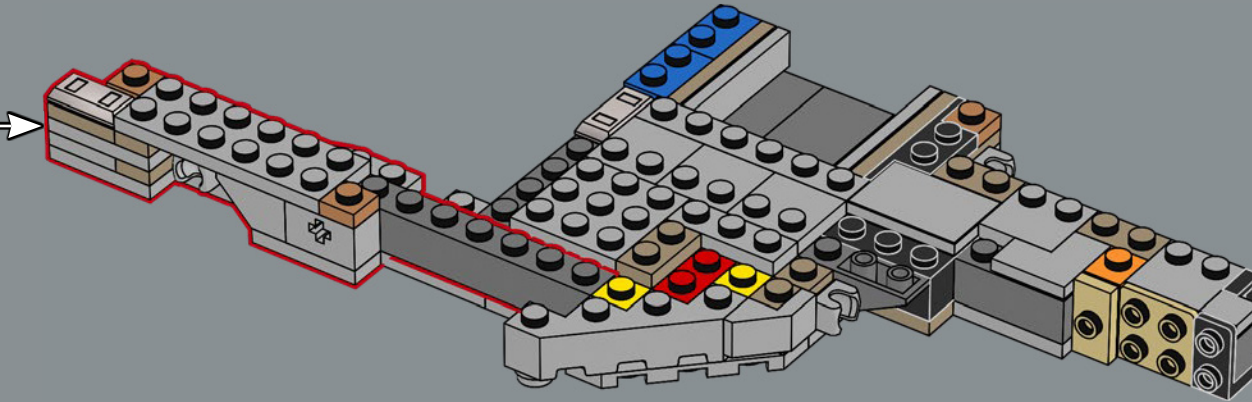

128

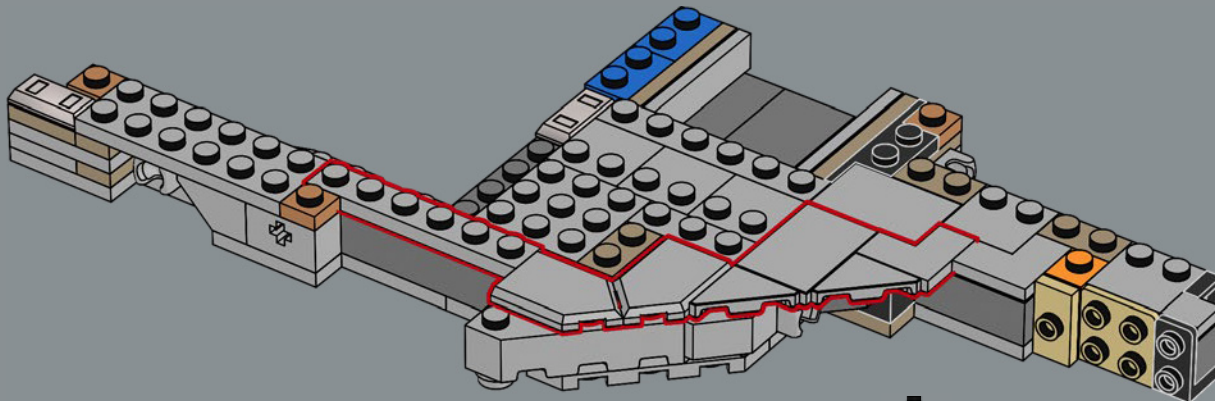

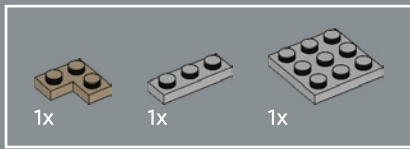

129

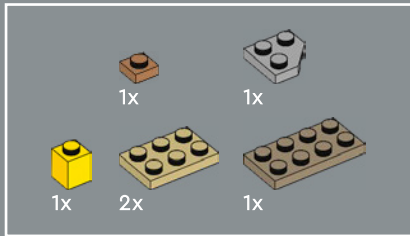
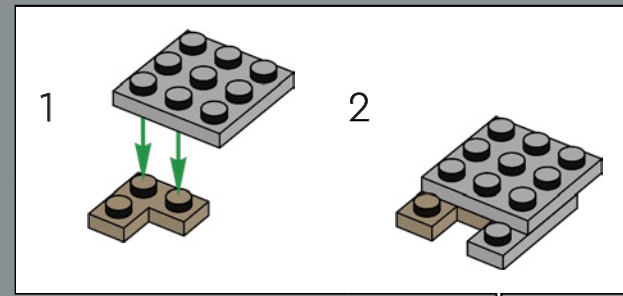
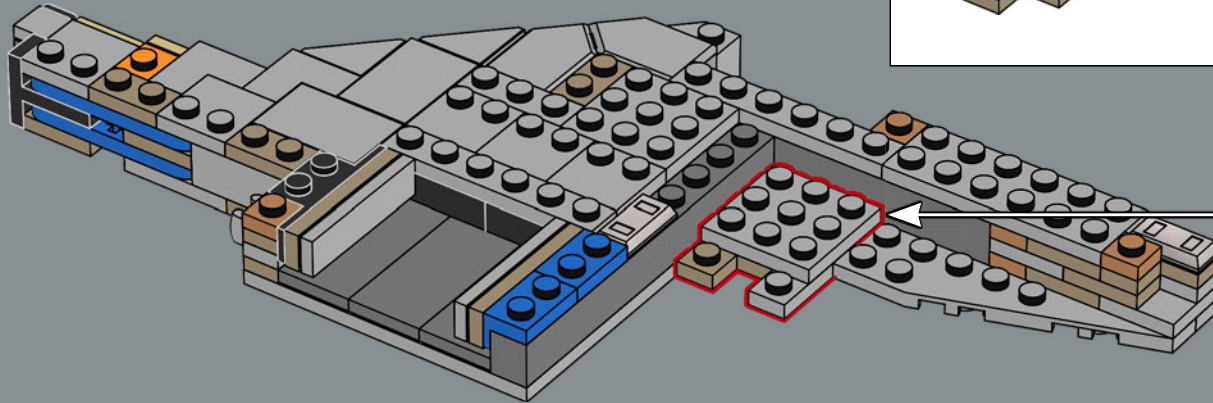

130

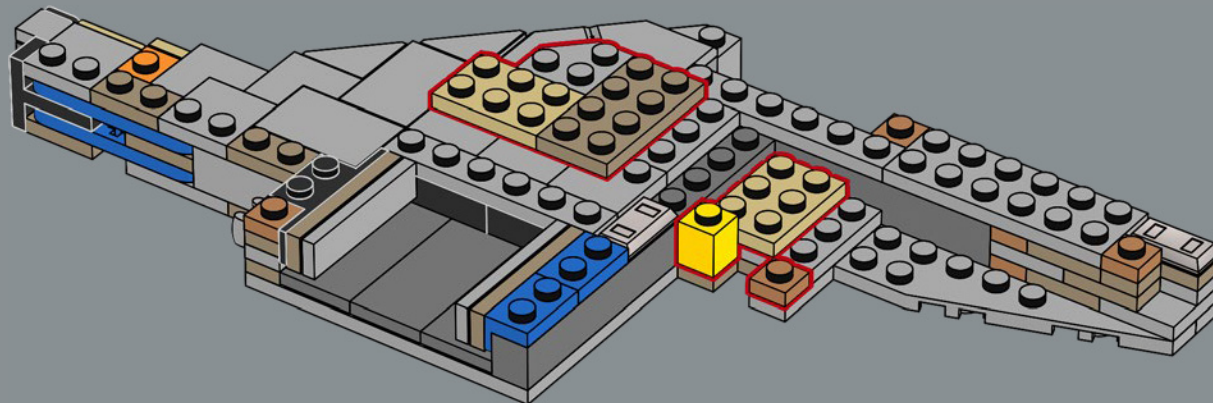

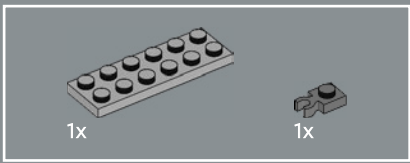

131

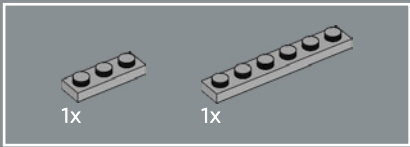
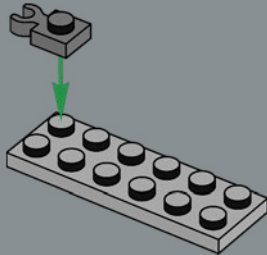

132

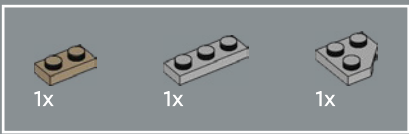
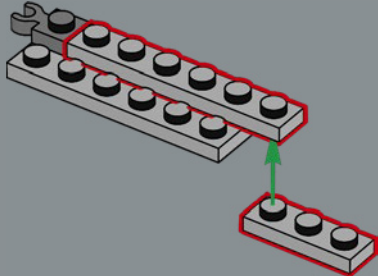

133

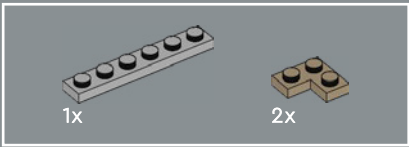
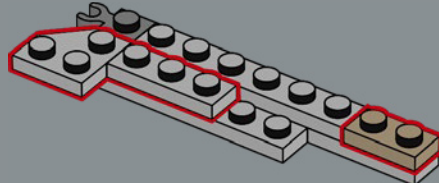

134

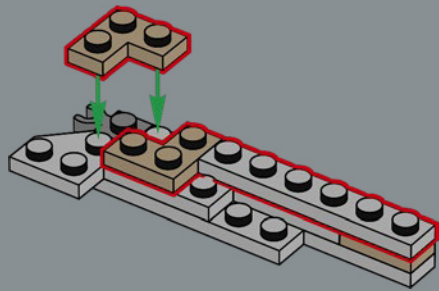



135

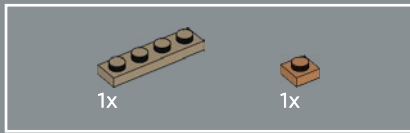
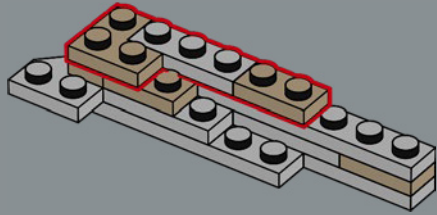

136

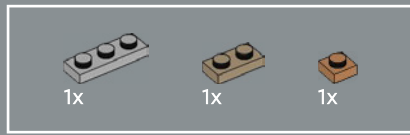
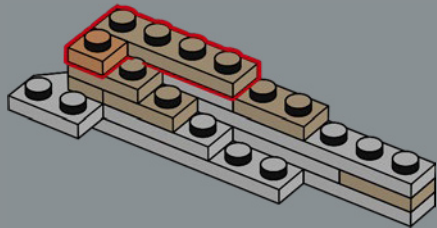

137

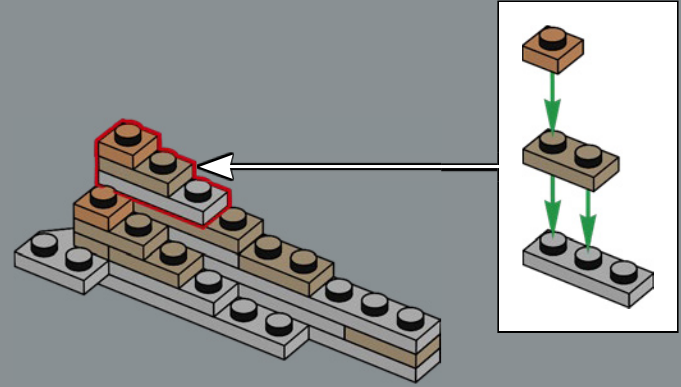

138

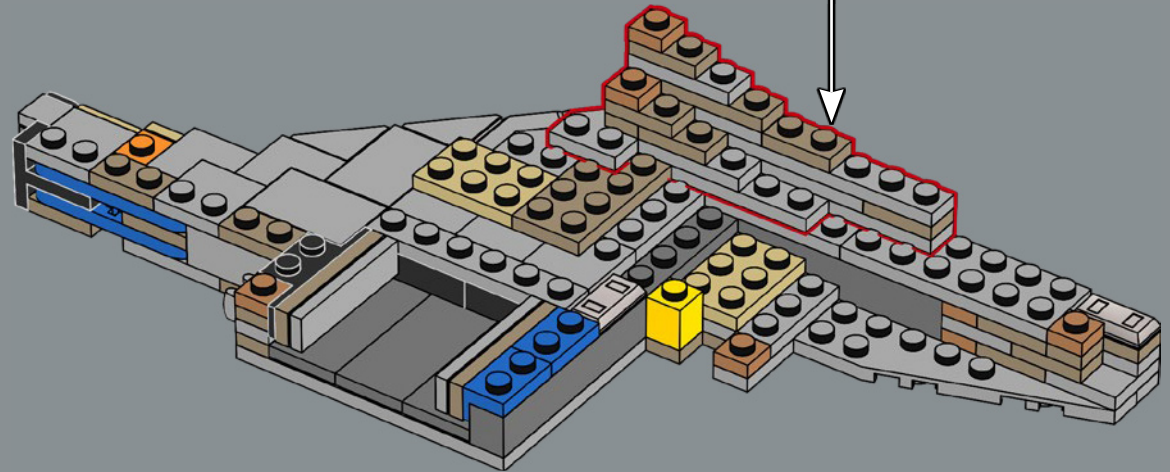

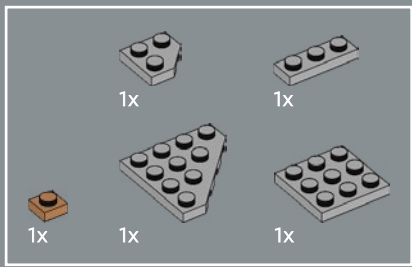

139

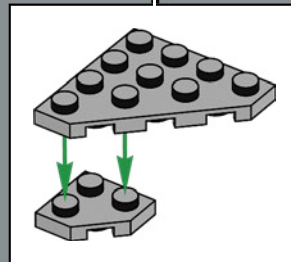
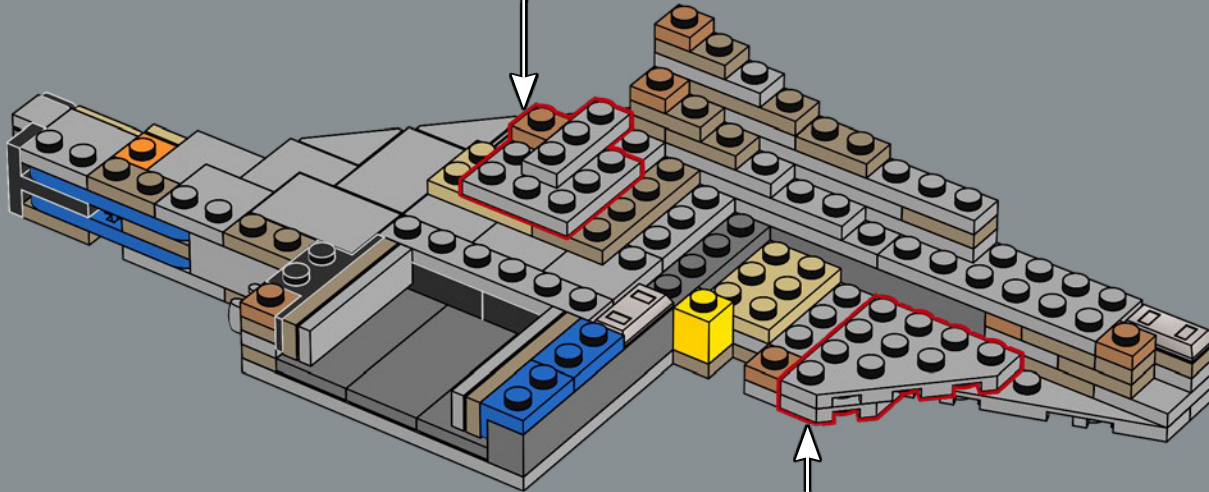
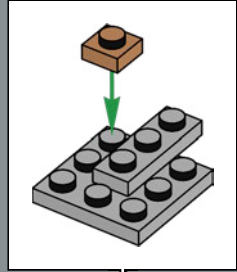

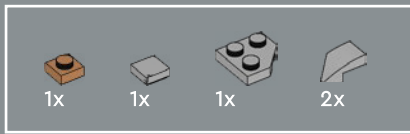

140

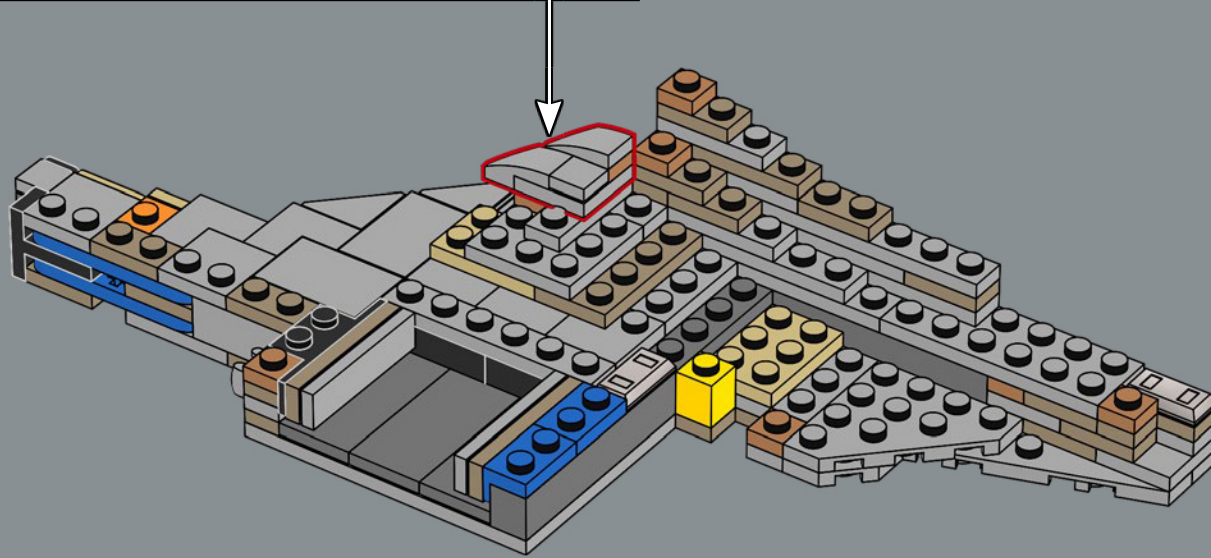
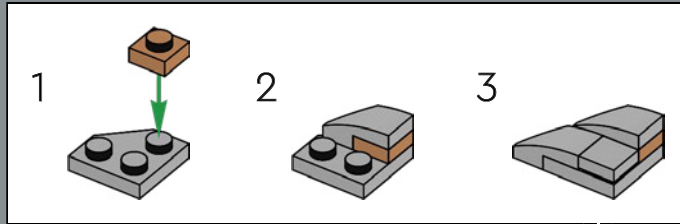

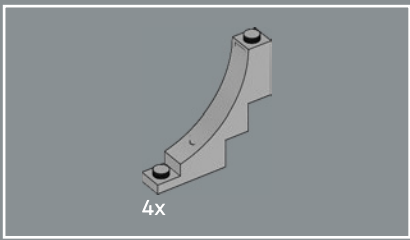

141

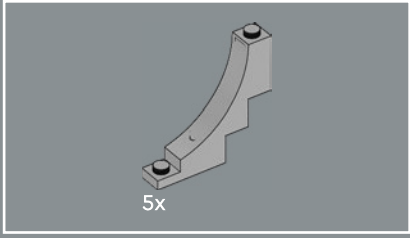
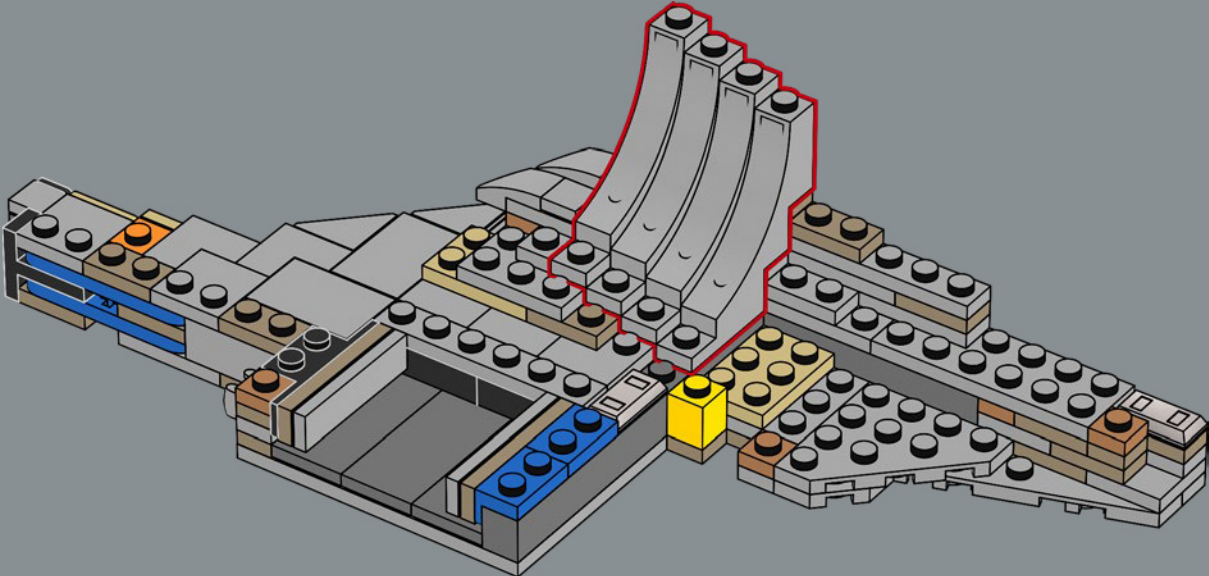

142

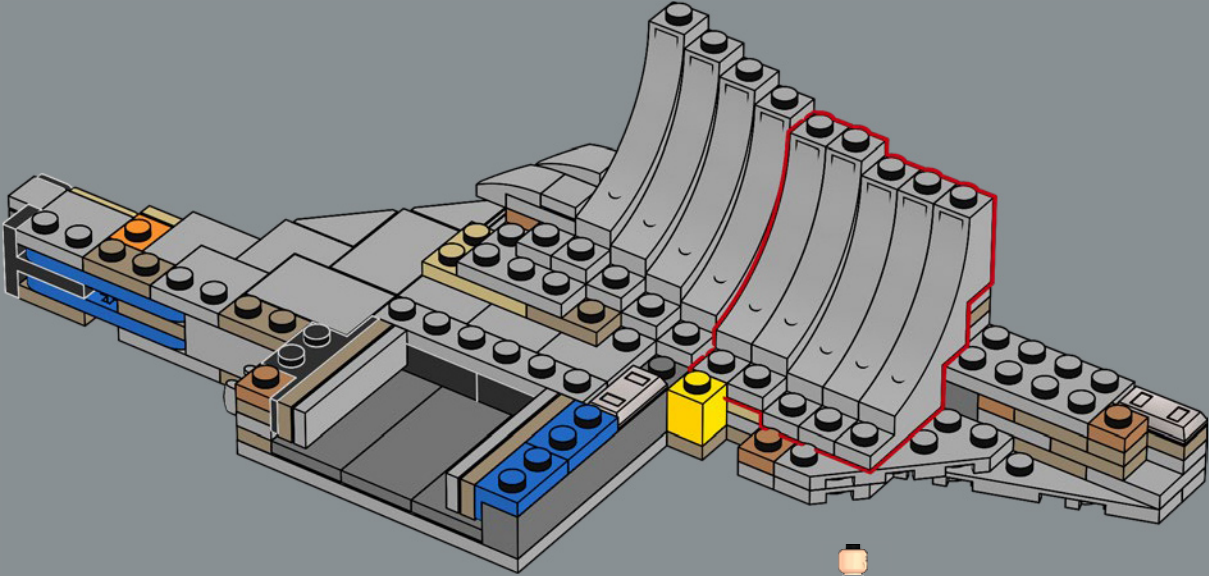

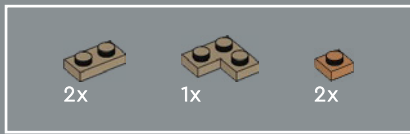

143

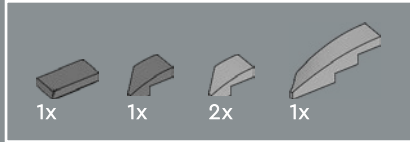
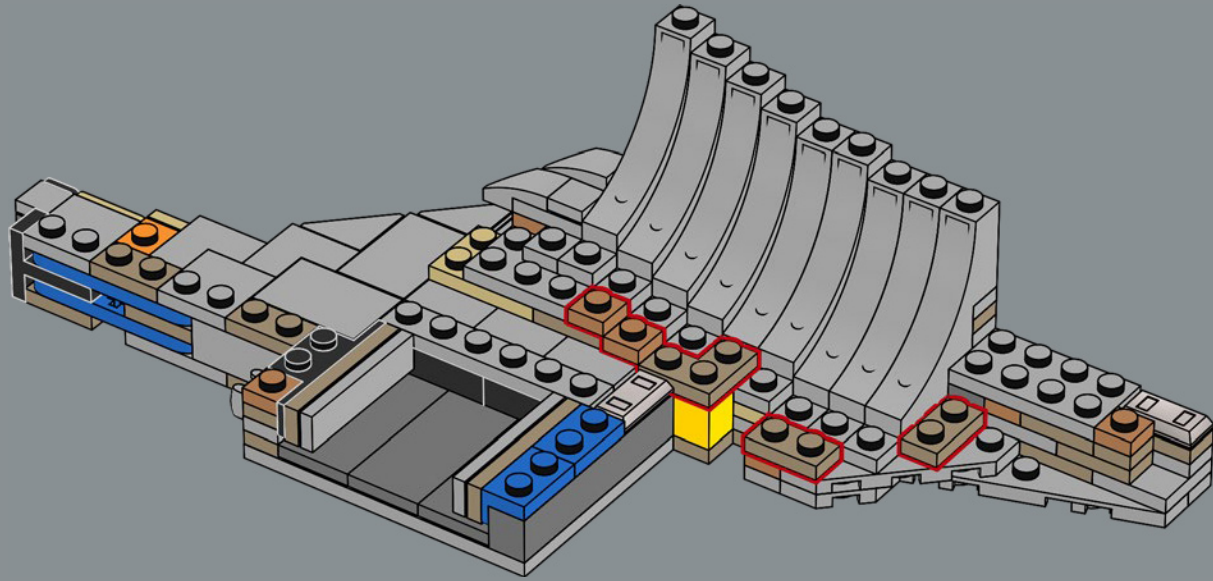

144

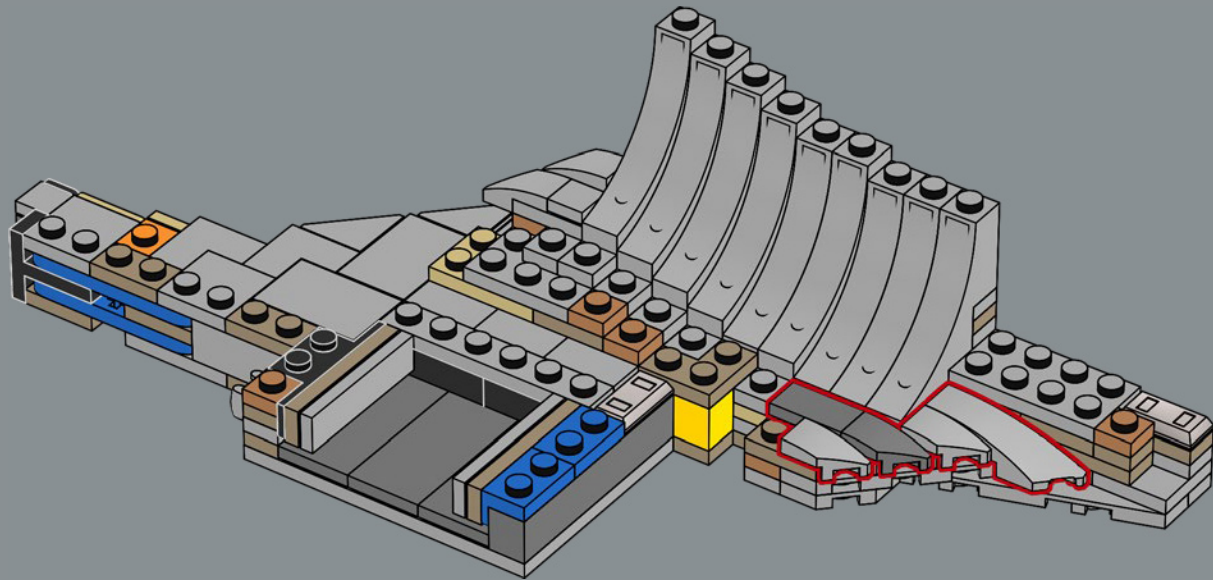

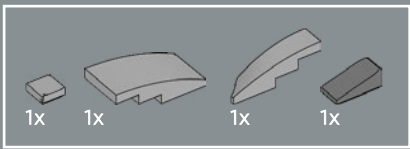

145

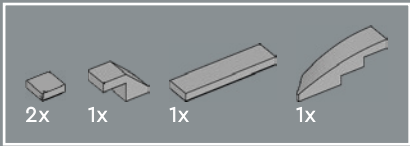
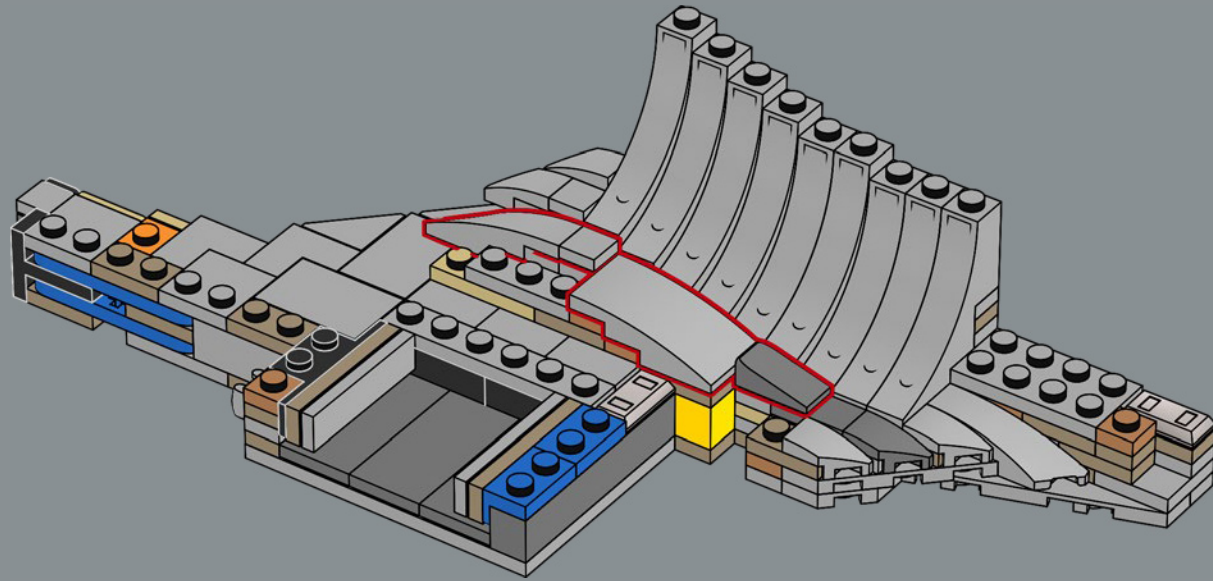

146

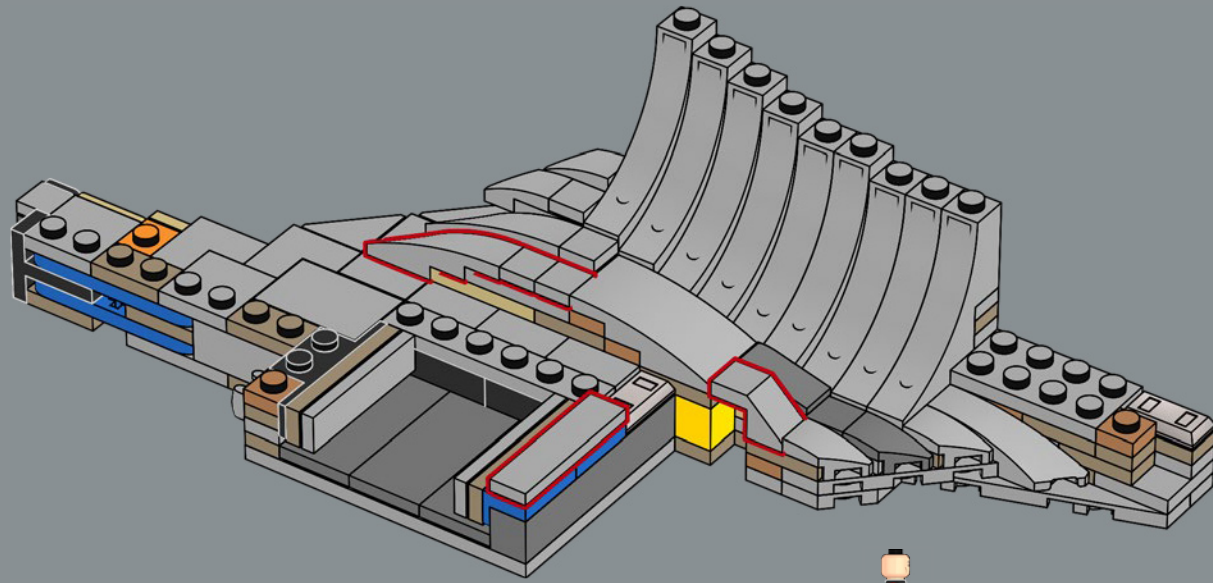

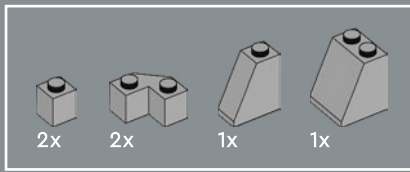

147

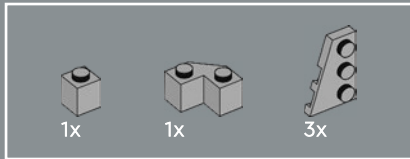
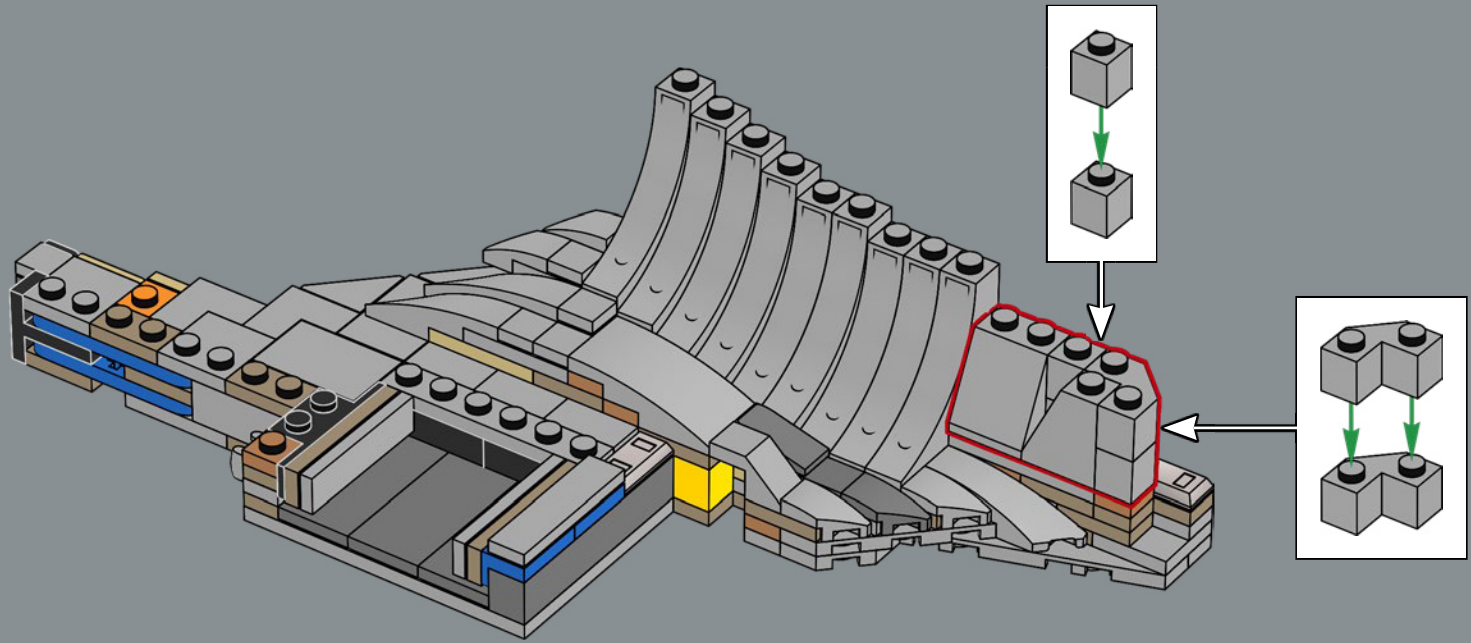

148

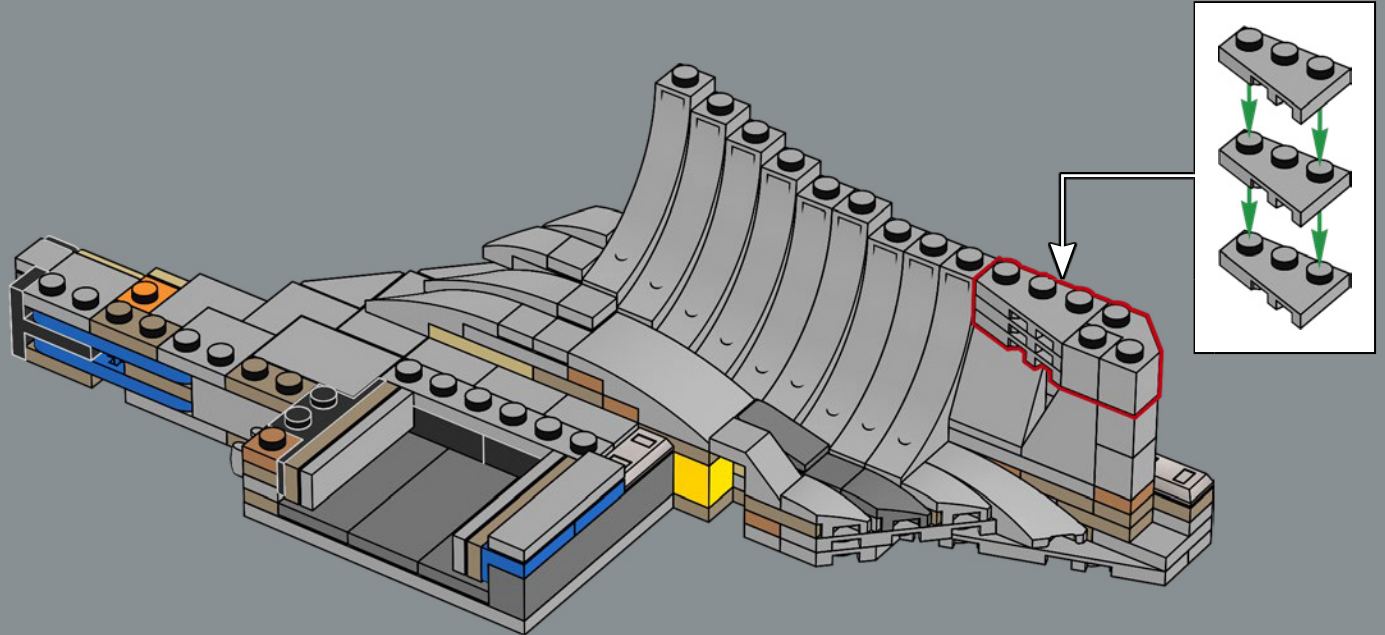

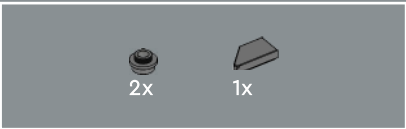

149

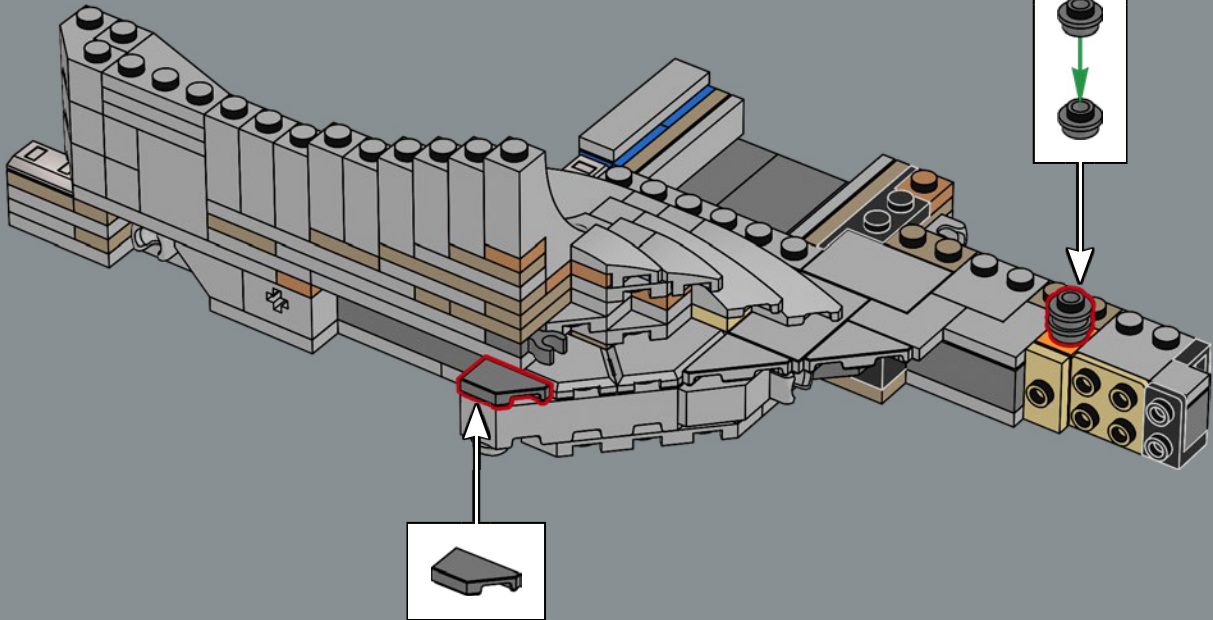

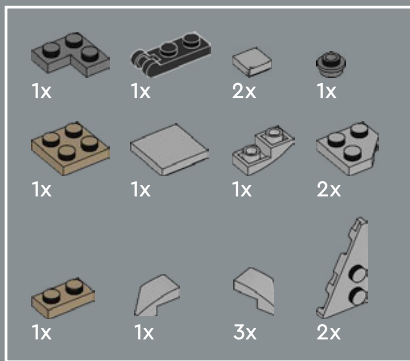

150

1

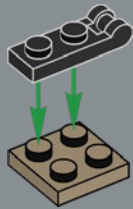

2

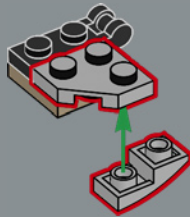

3

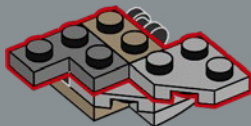

5

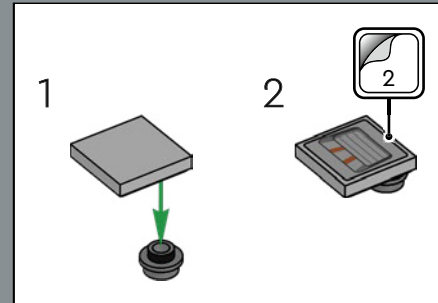
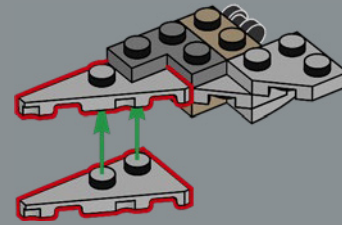

4

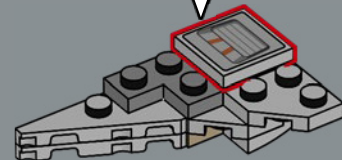

6

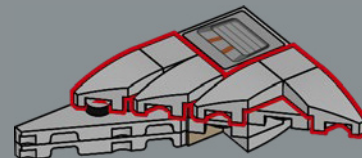

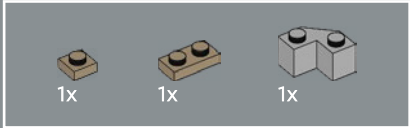
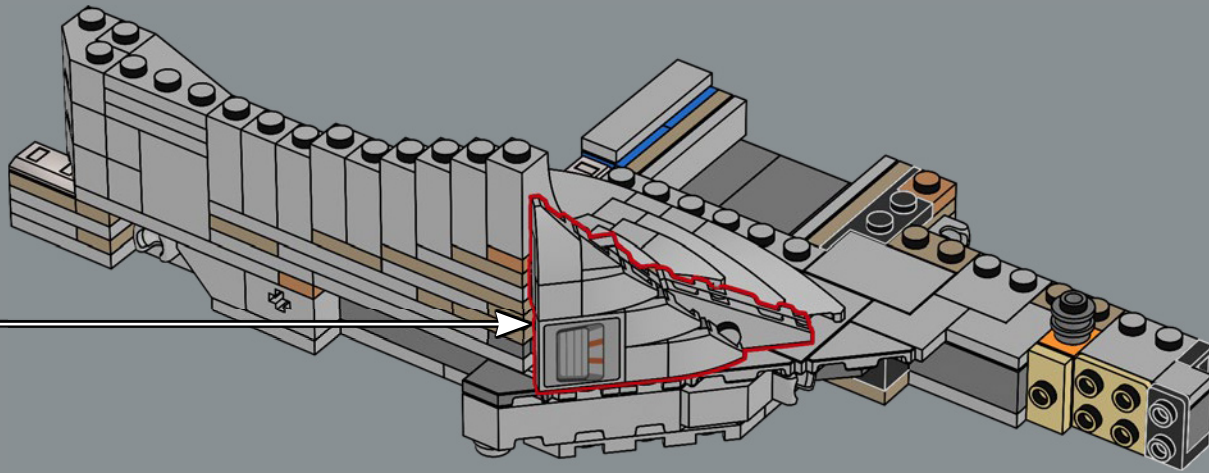

151

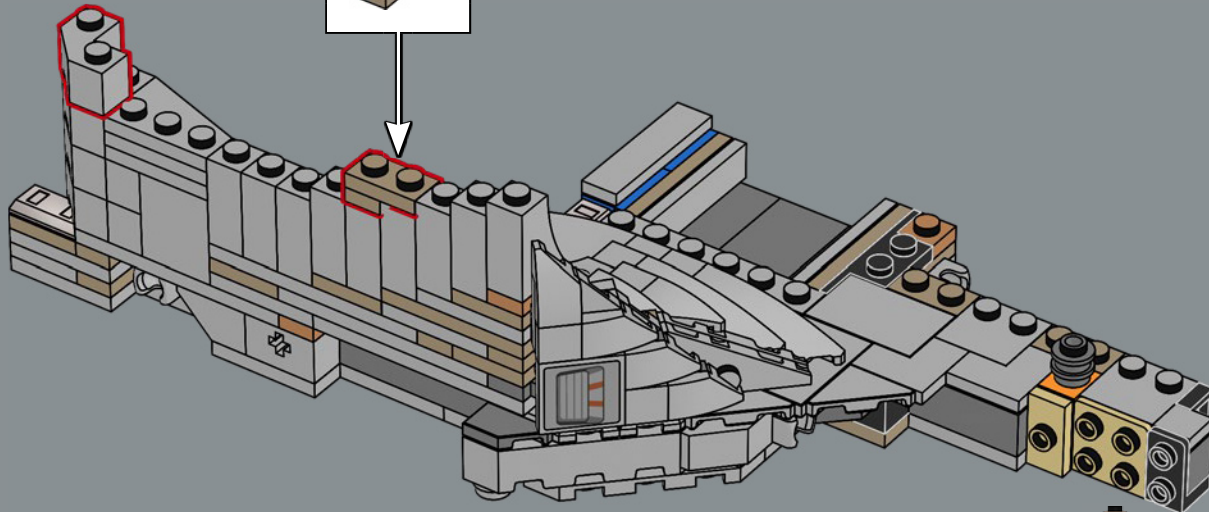
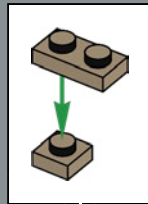

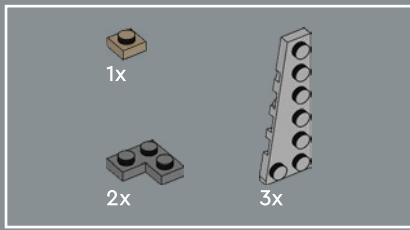

152

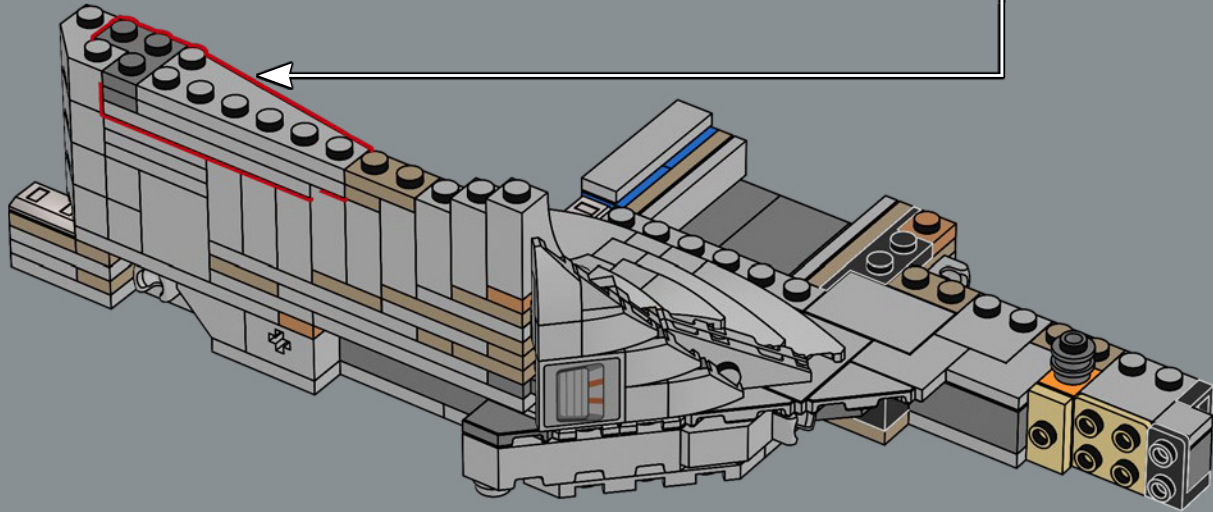
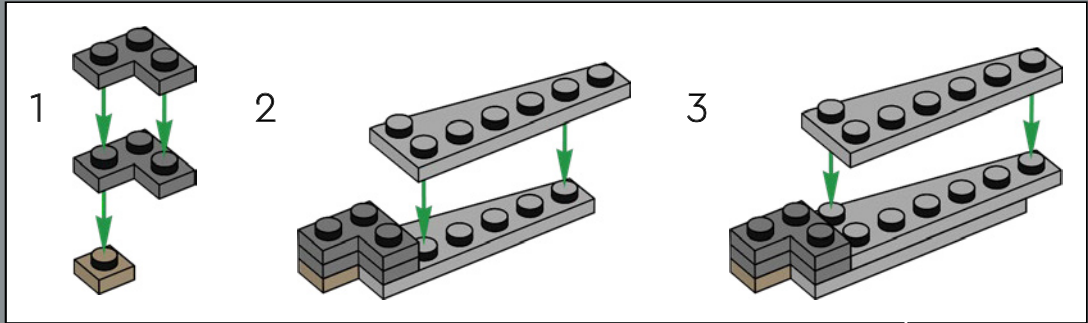

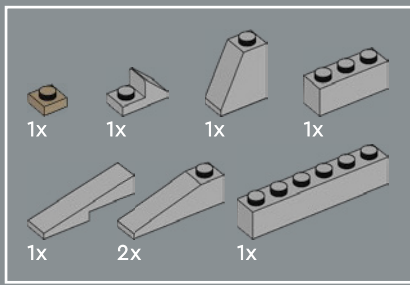

154 1

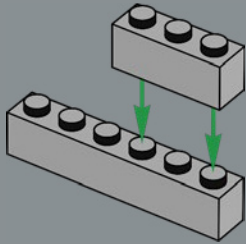

2

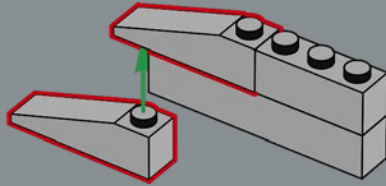

3

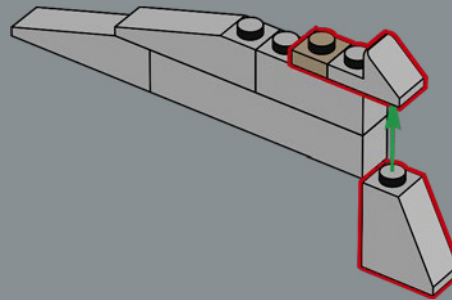

4

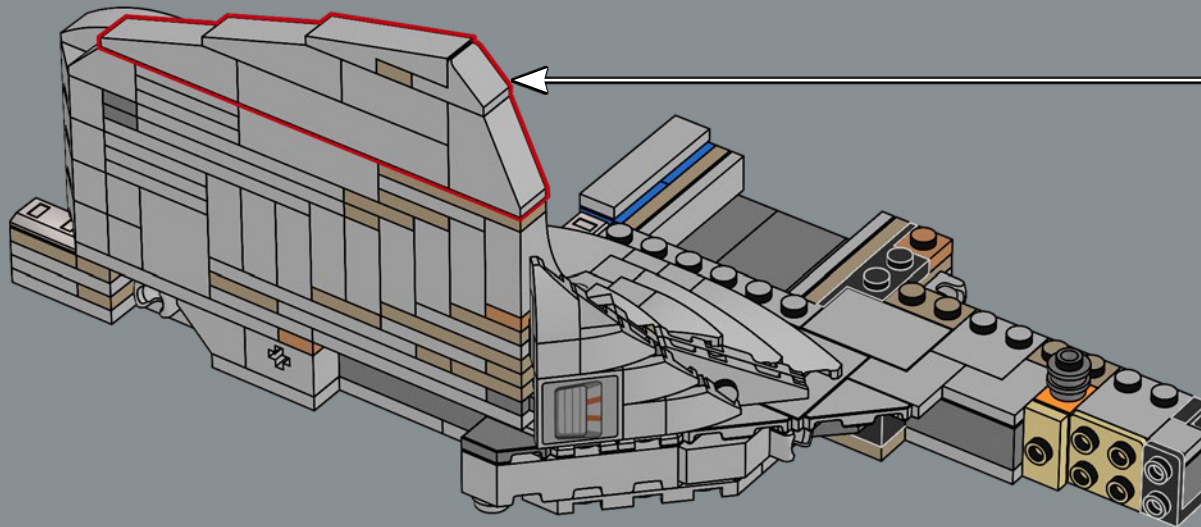
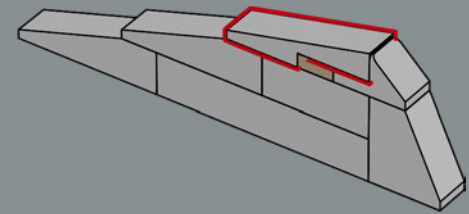

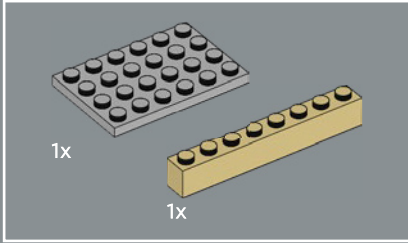
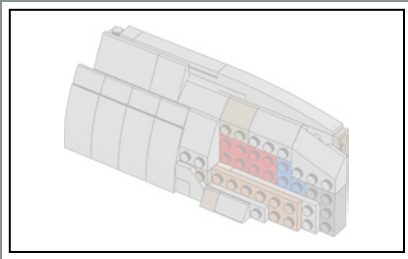

155

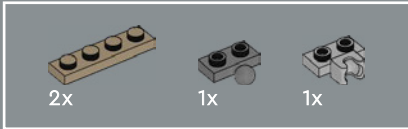
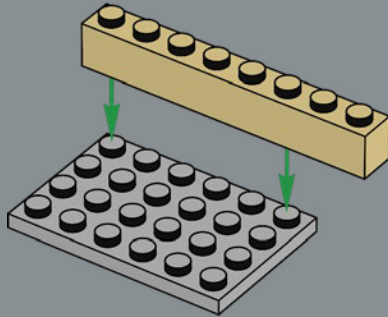

156

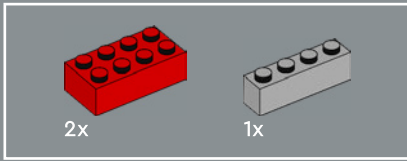
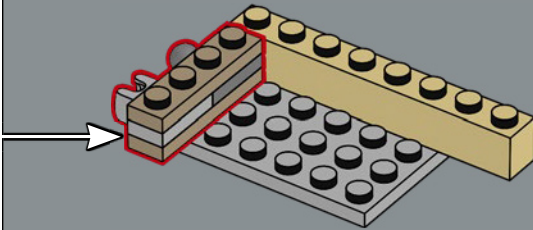
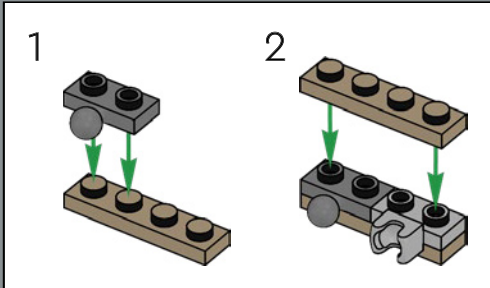

157

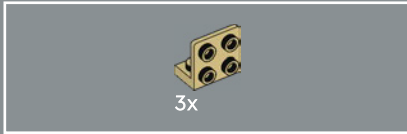
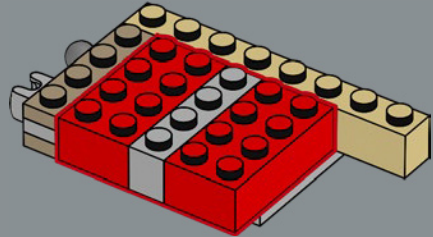

158

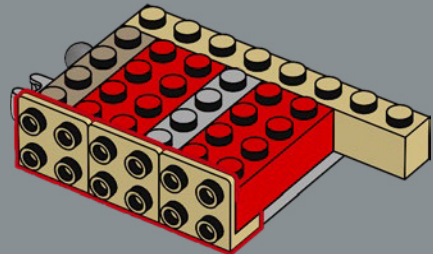

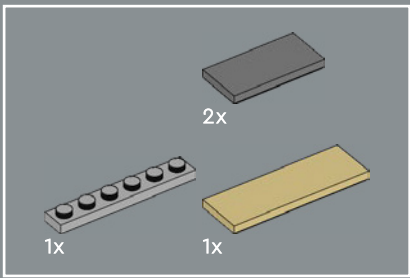

160

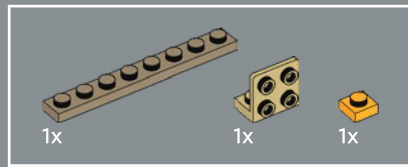
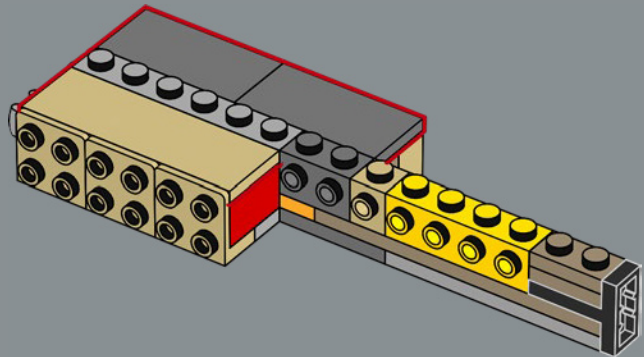

161

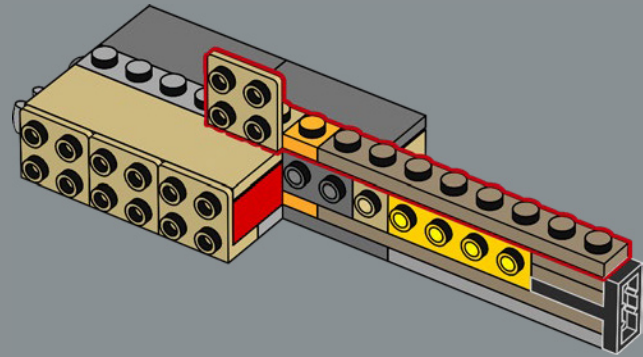

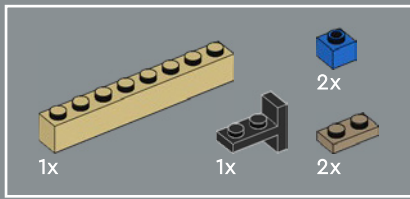

162

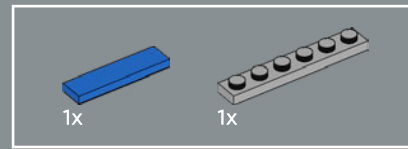
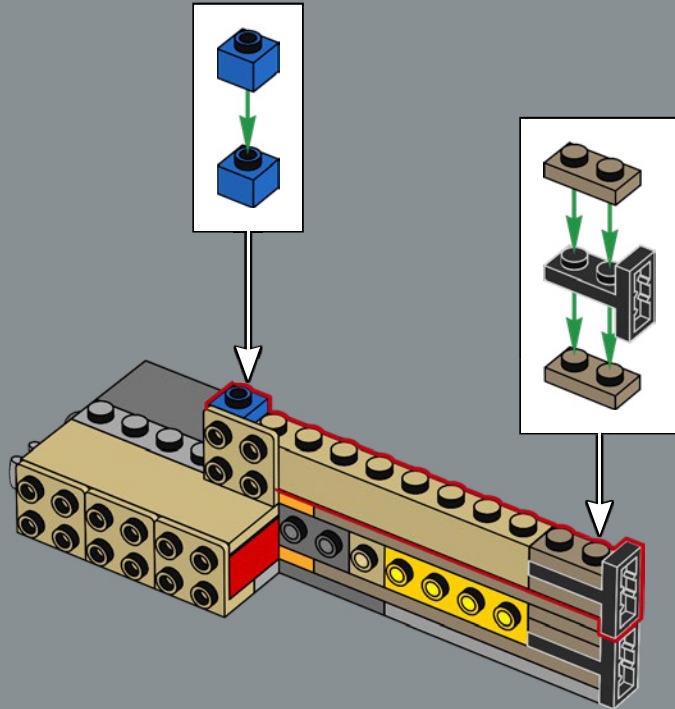

163

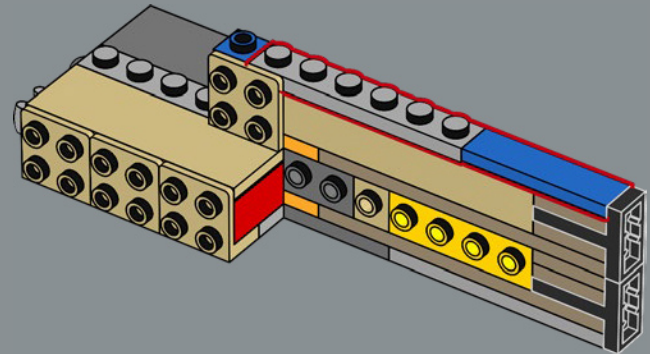

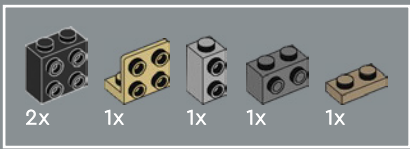

164

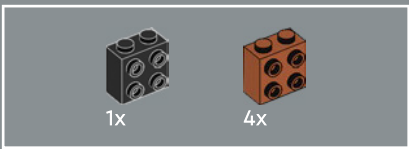
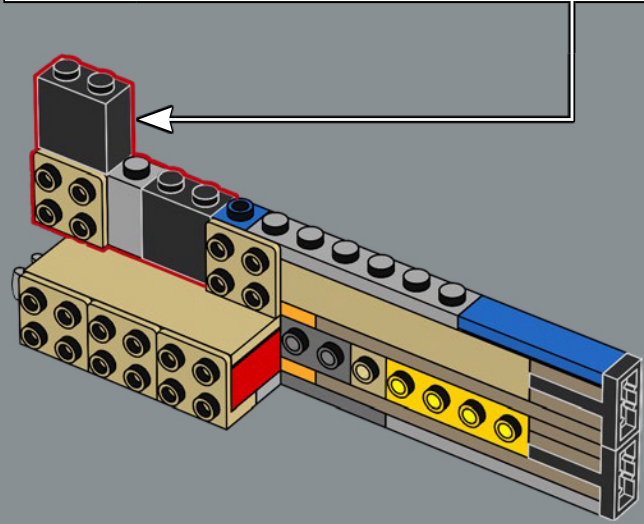
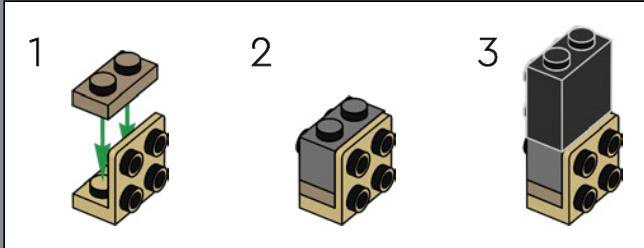

165

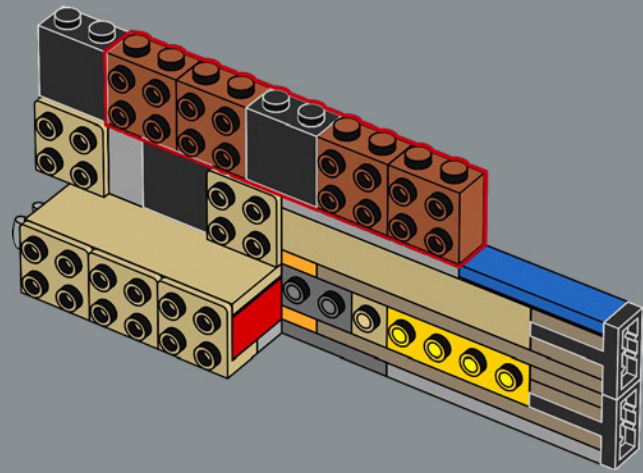

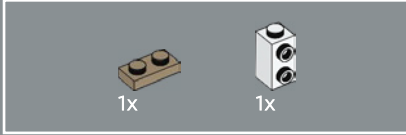
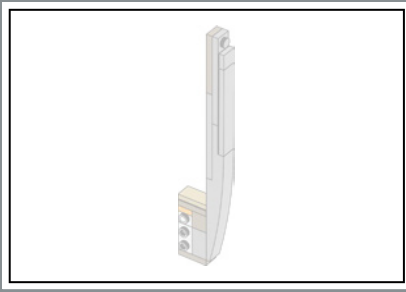

166

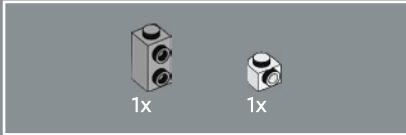
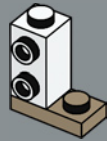

167

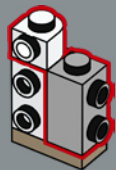

168

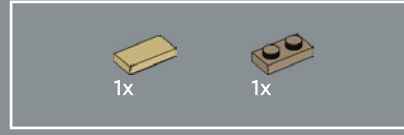

169

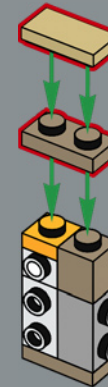

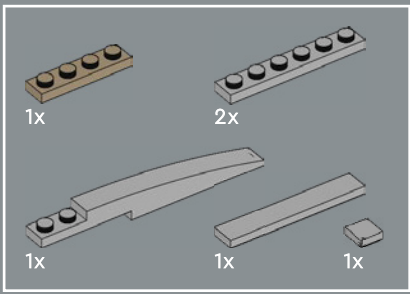

170

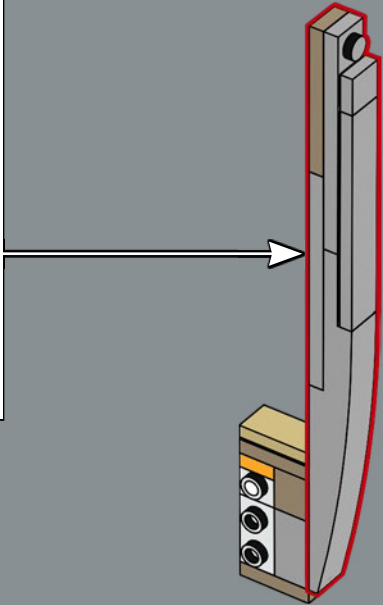
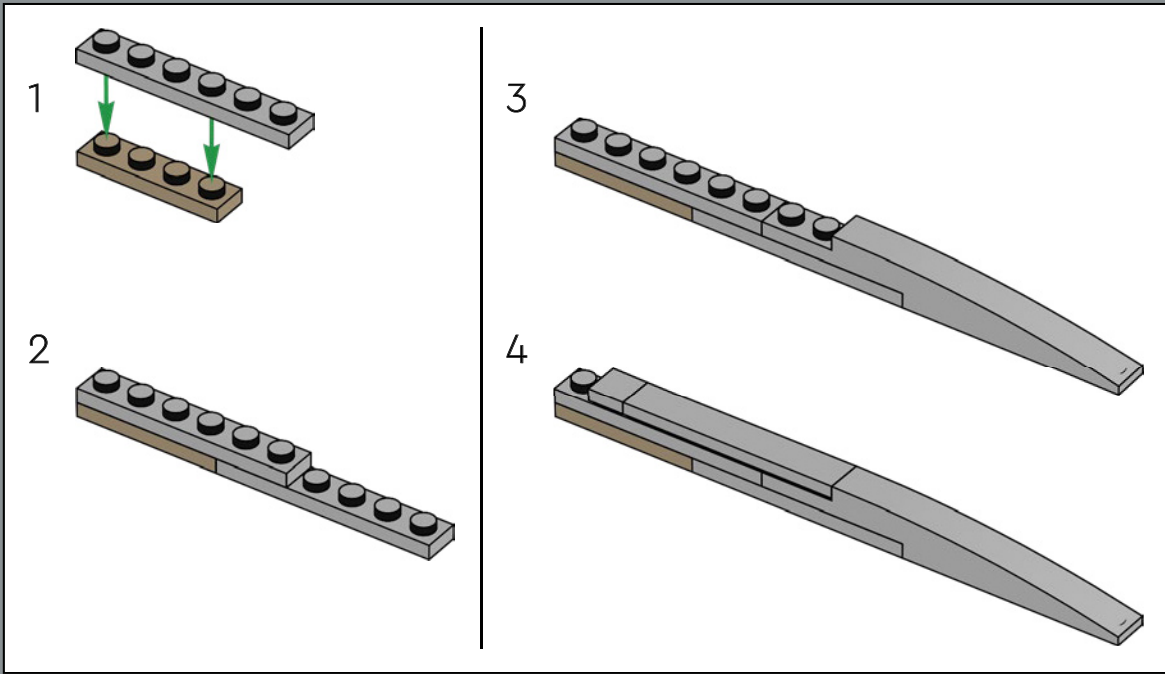

171

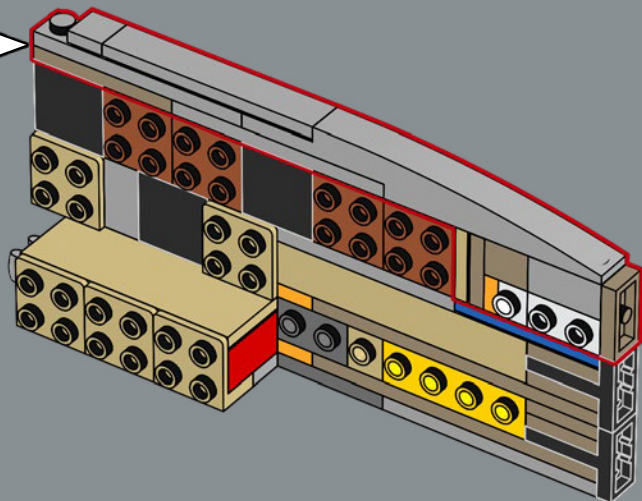

172

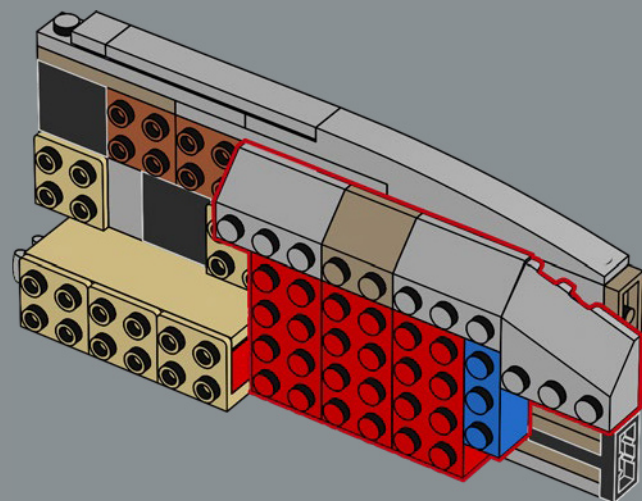
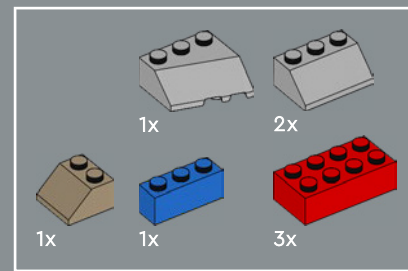

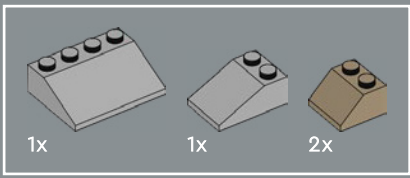

173

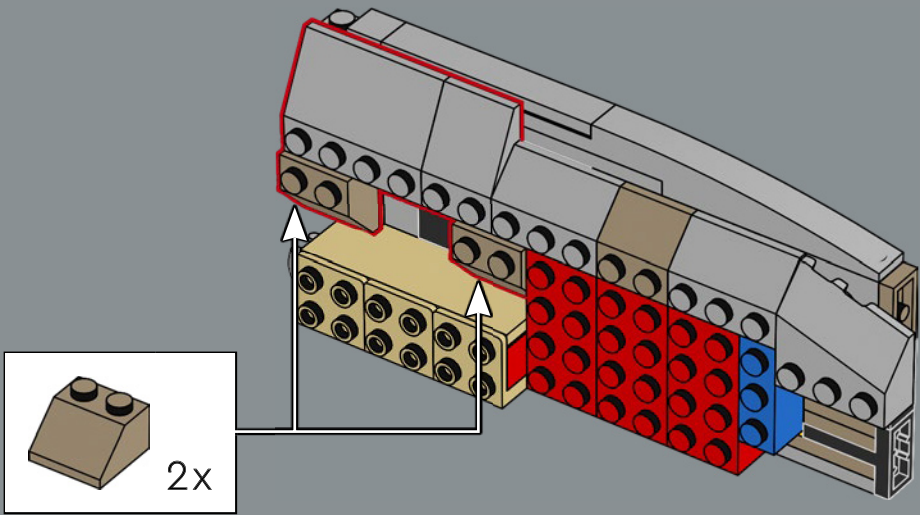

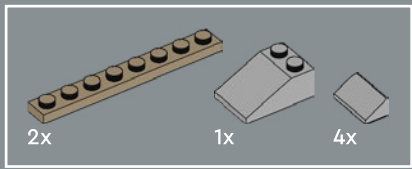

175

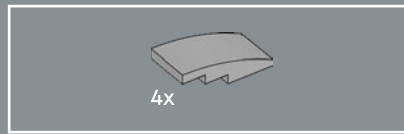
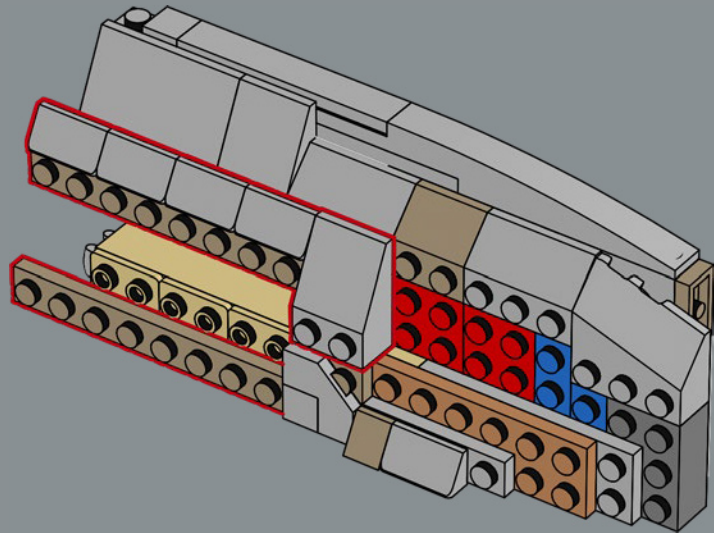

176

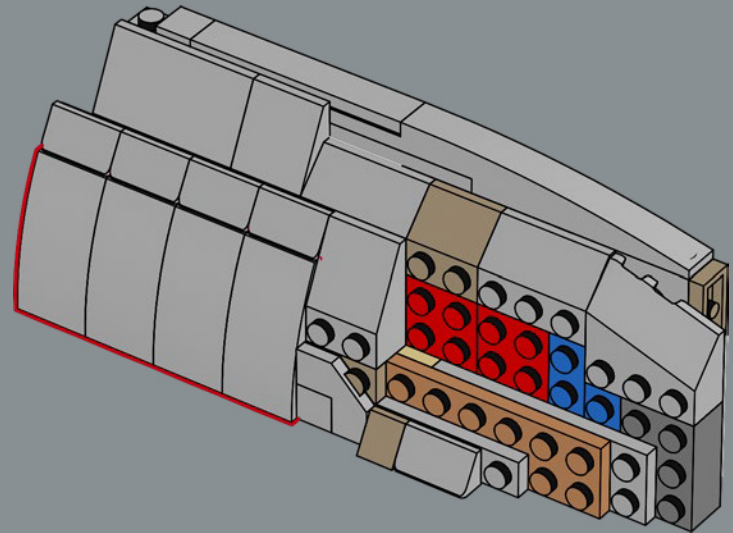

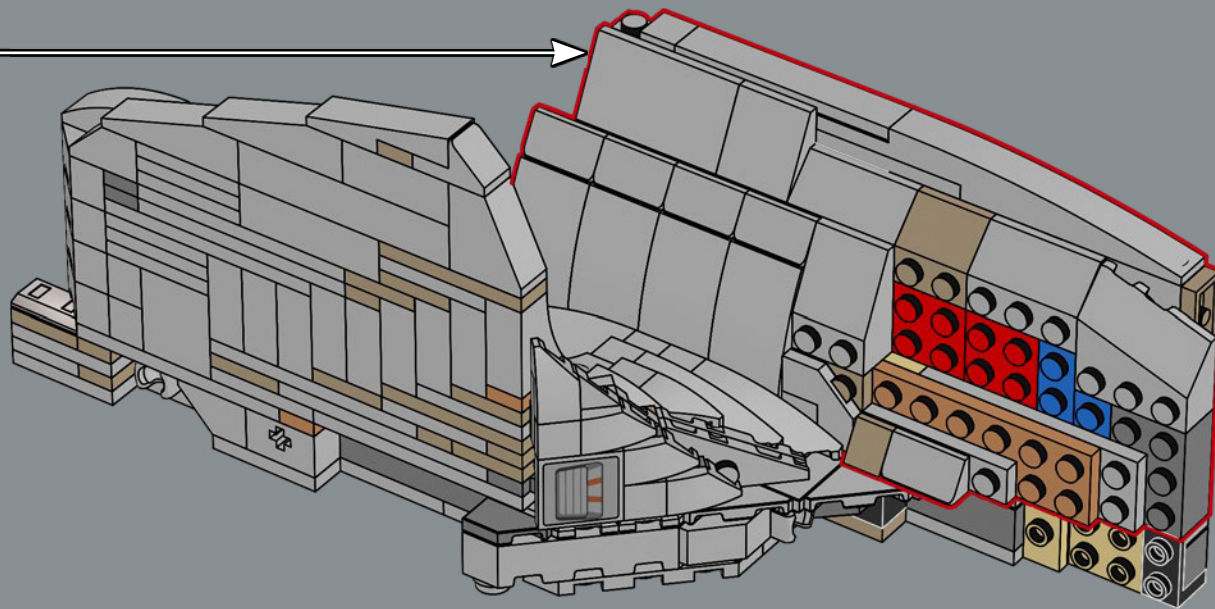

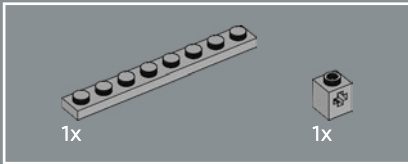
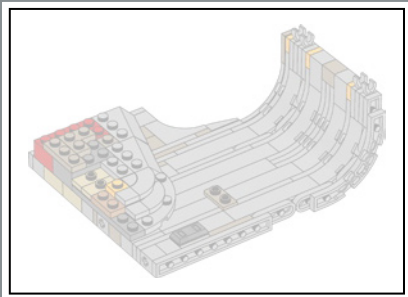

178

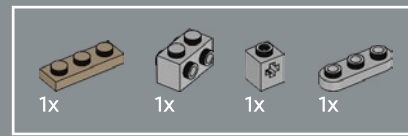
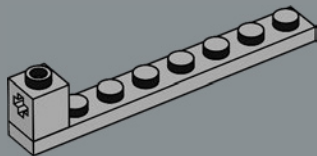

179

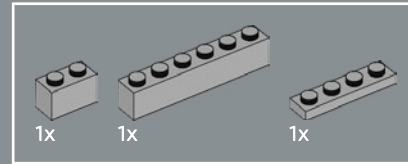
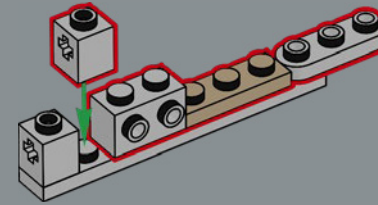

180

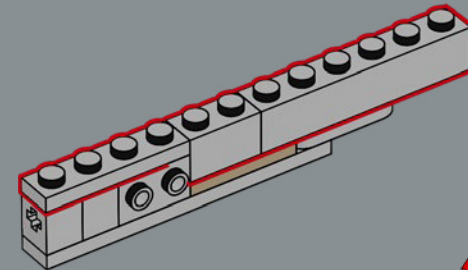

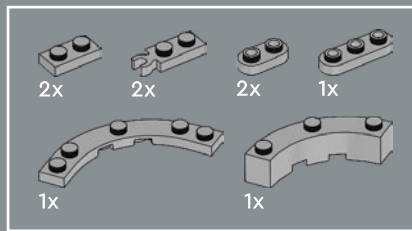

181

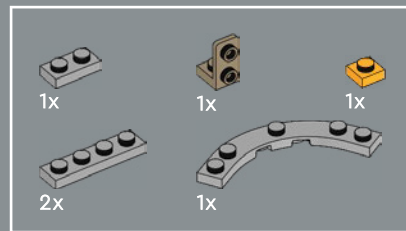
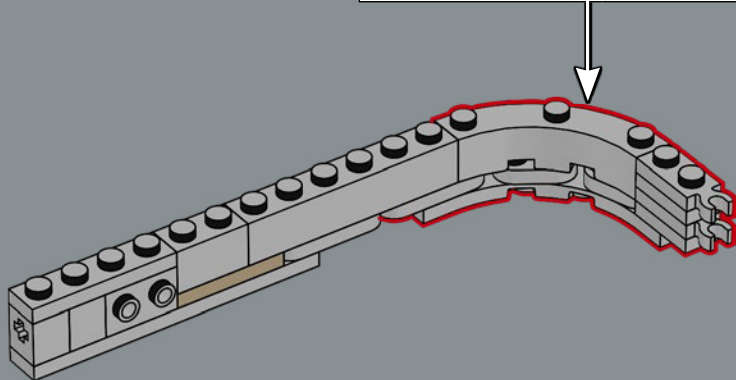
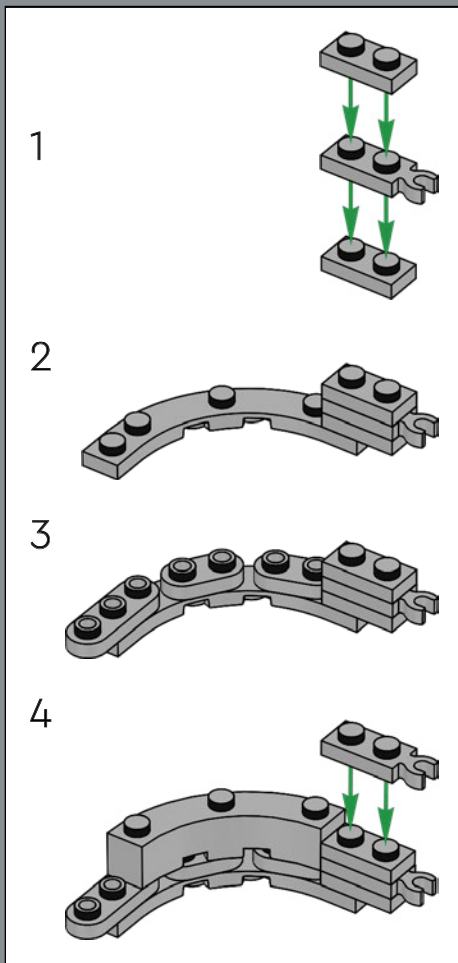

182

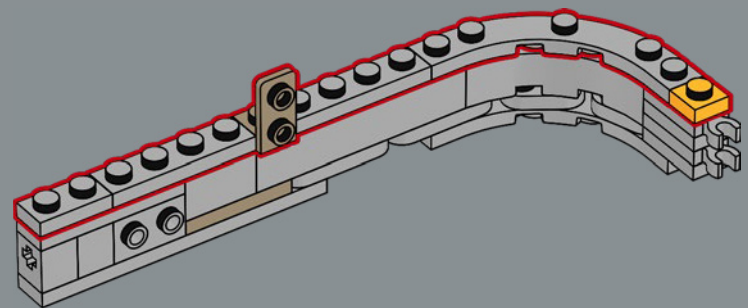

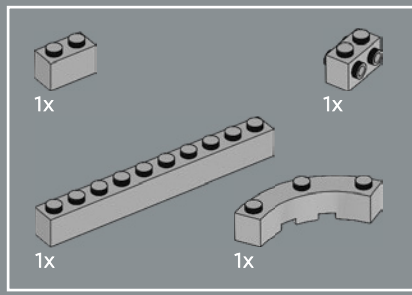

183

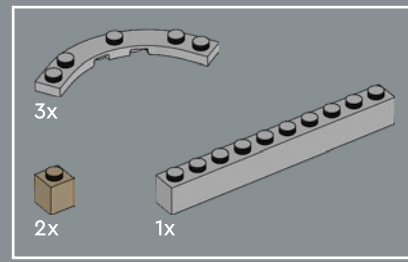
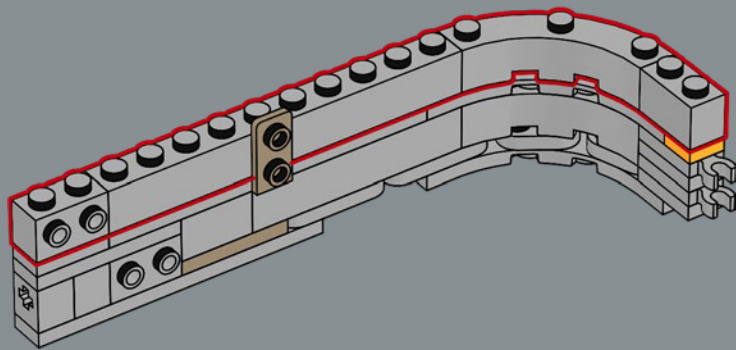

184

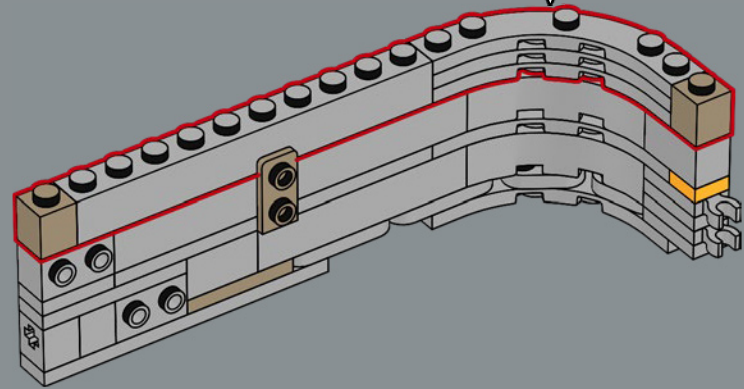
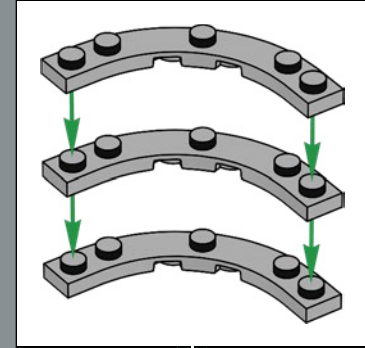

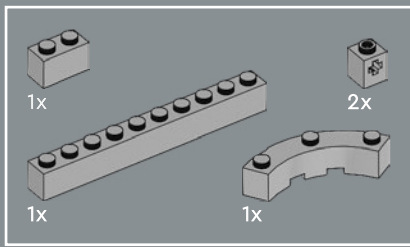

185

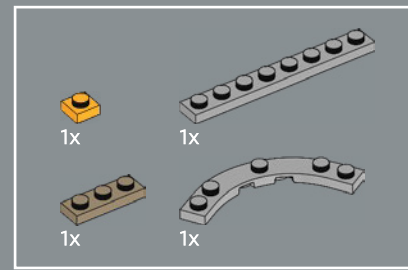
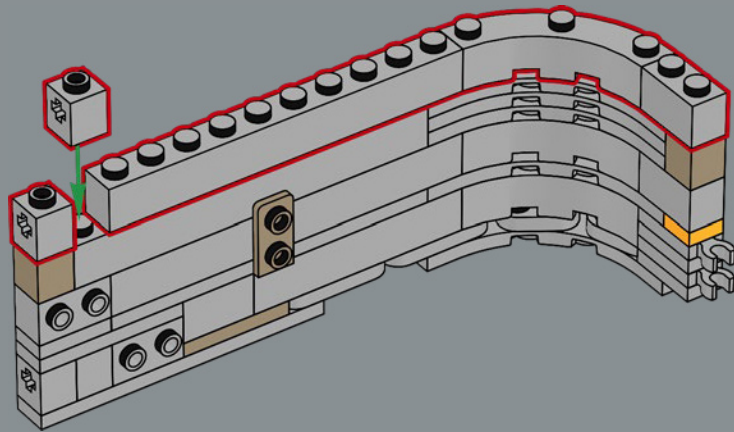

186

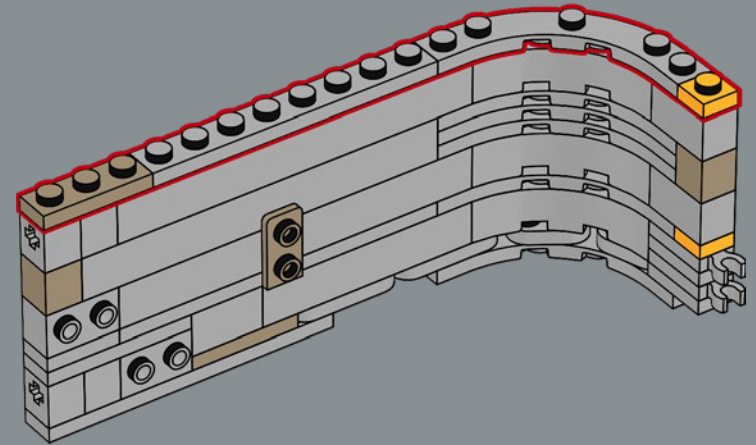

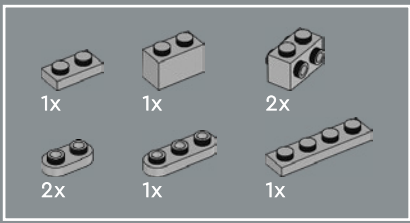

187

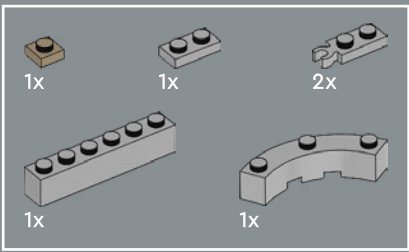
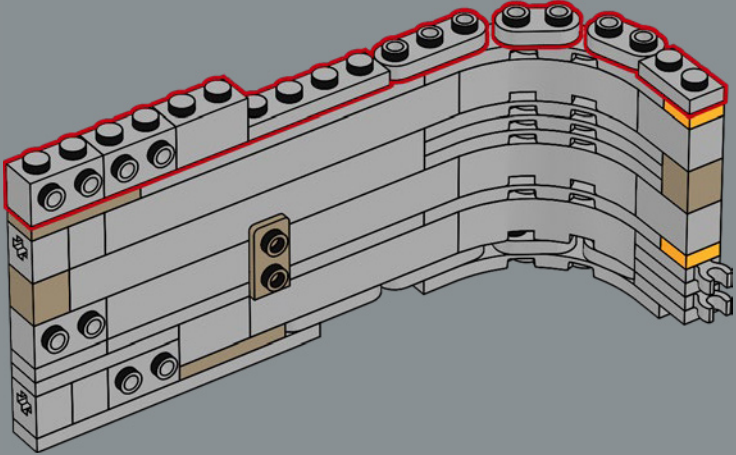

188

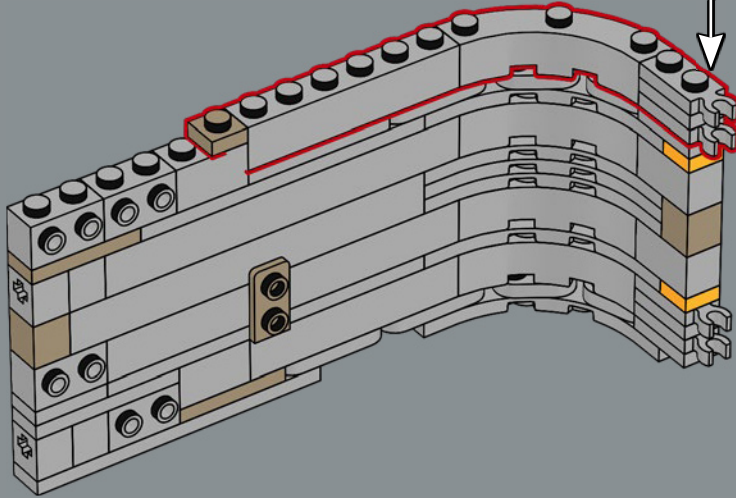

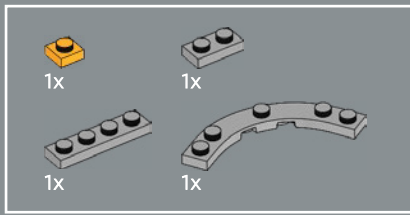

189

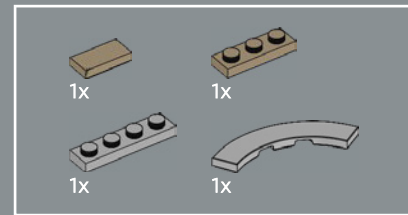
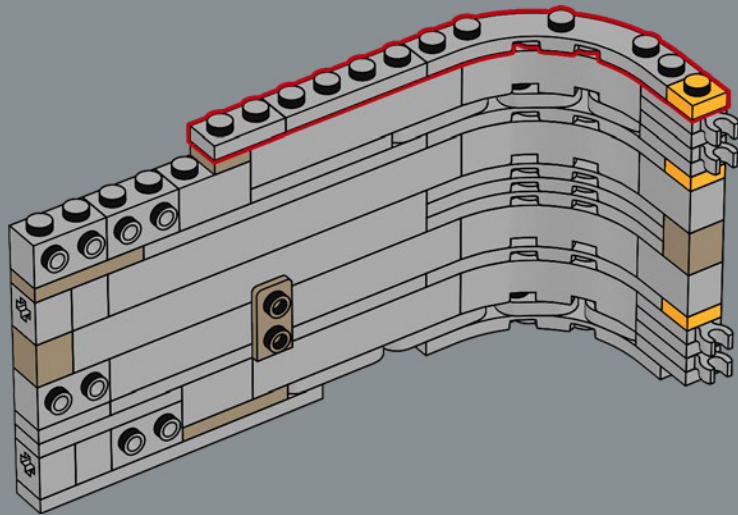

190

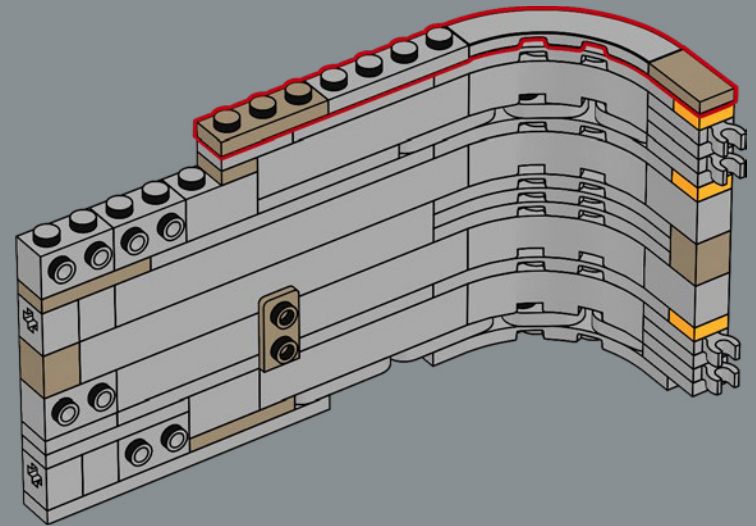

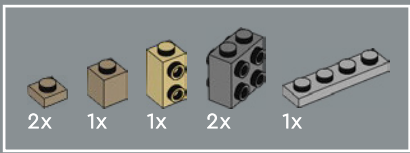

191

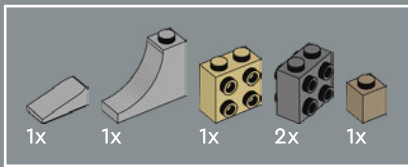
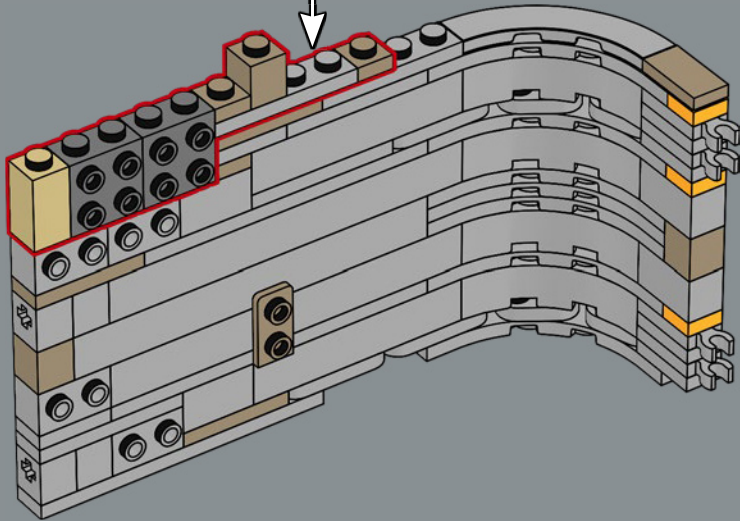
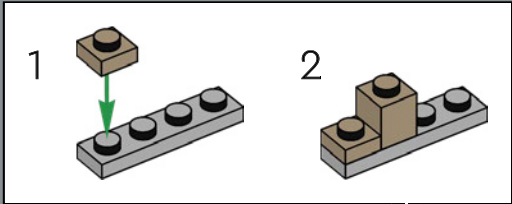

192

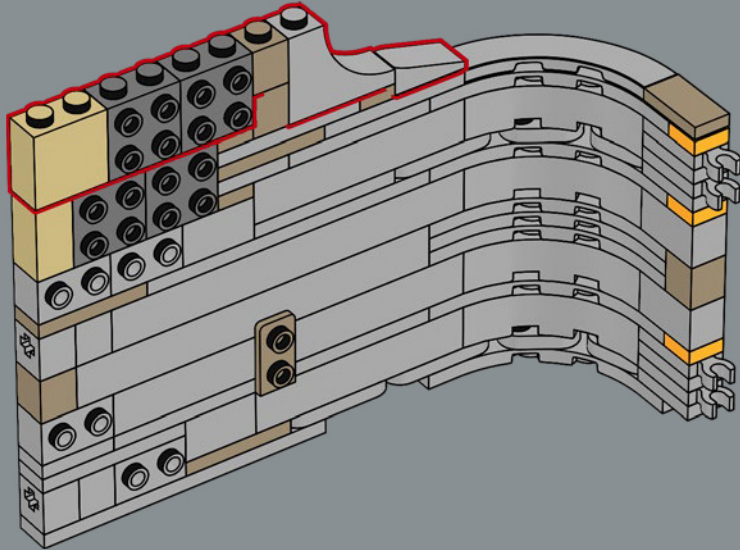

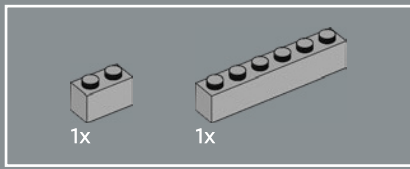

193

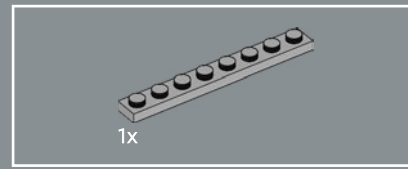
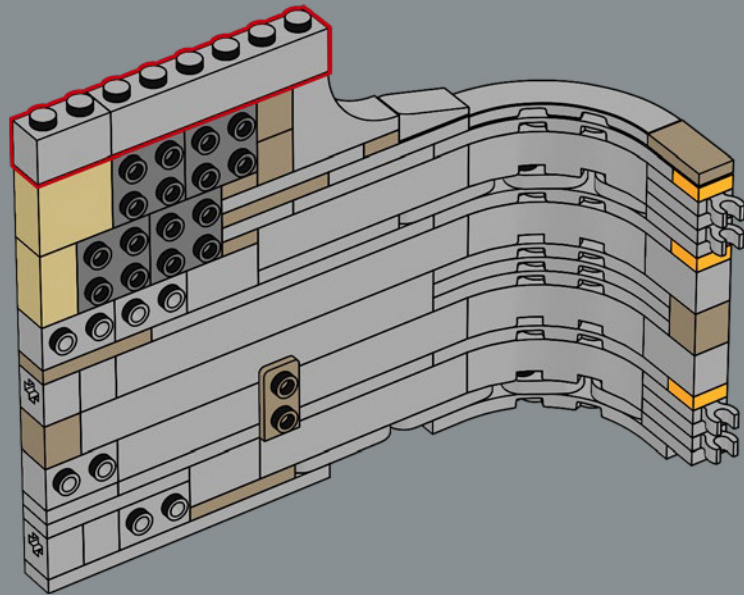

194

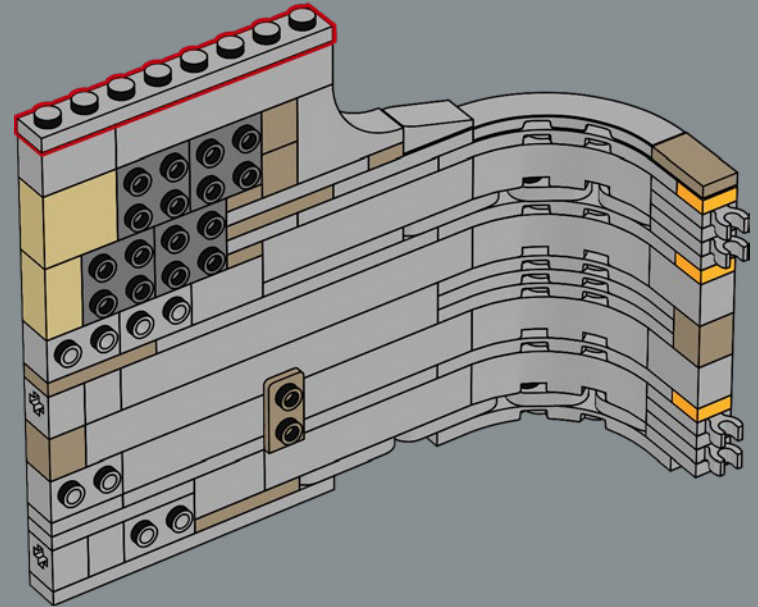

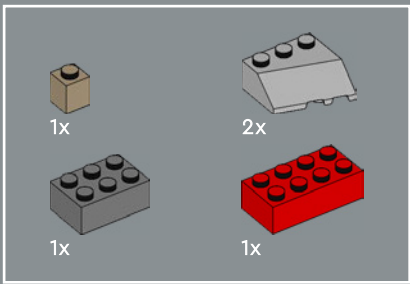

195

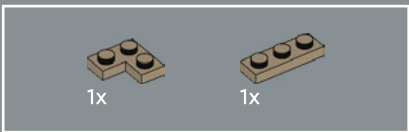
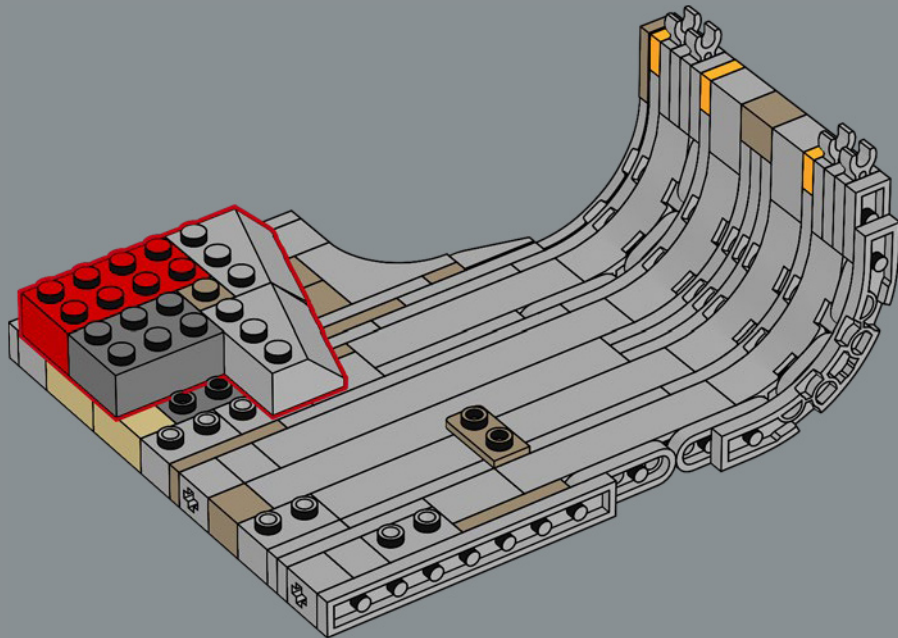

196

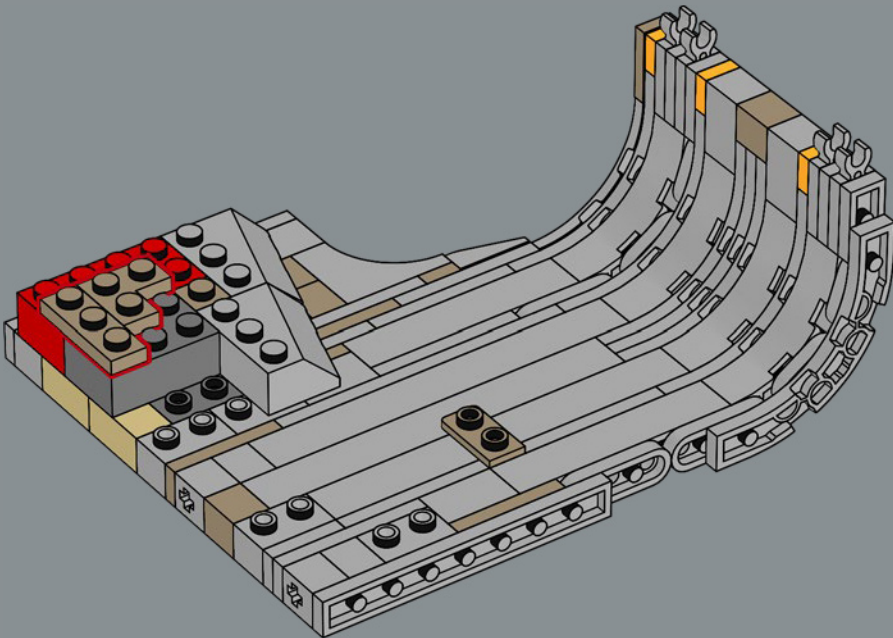



2x

198

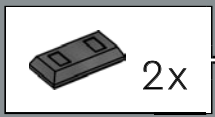
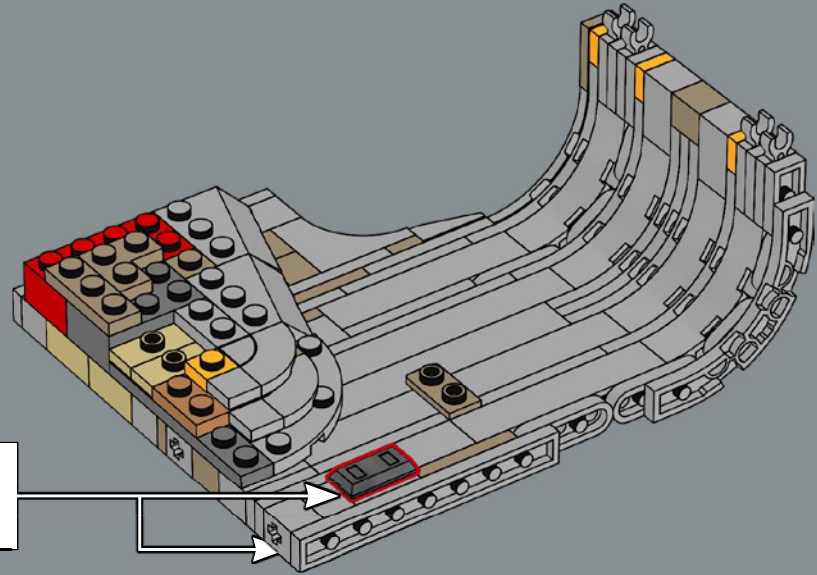

2x

199

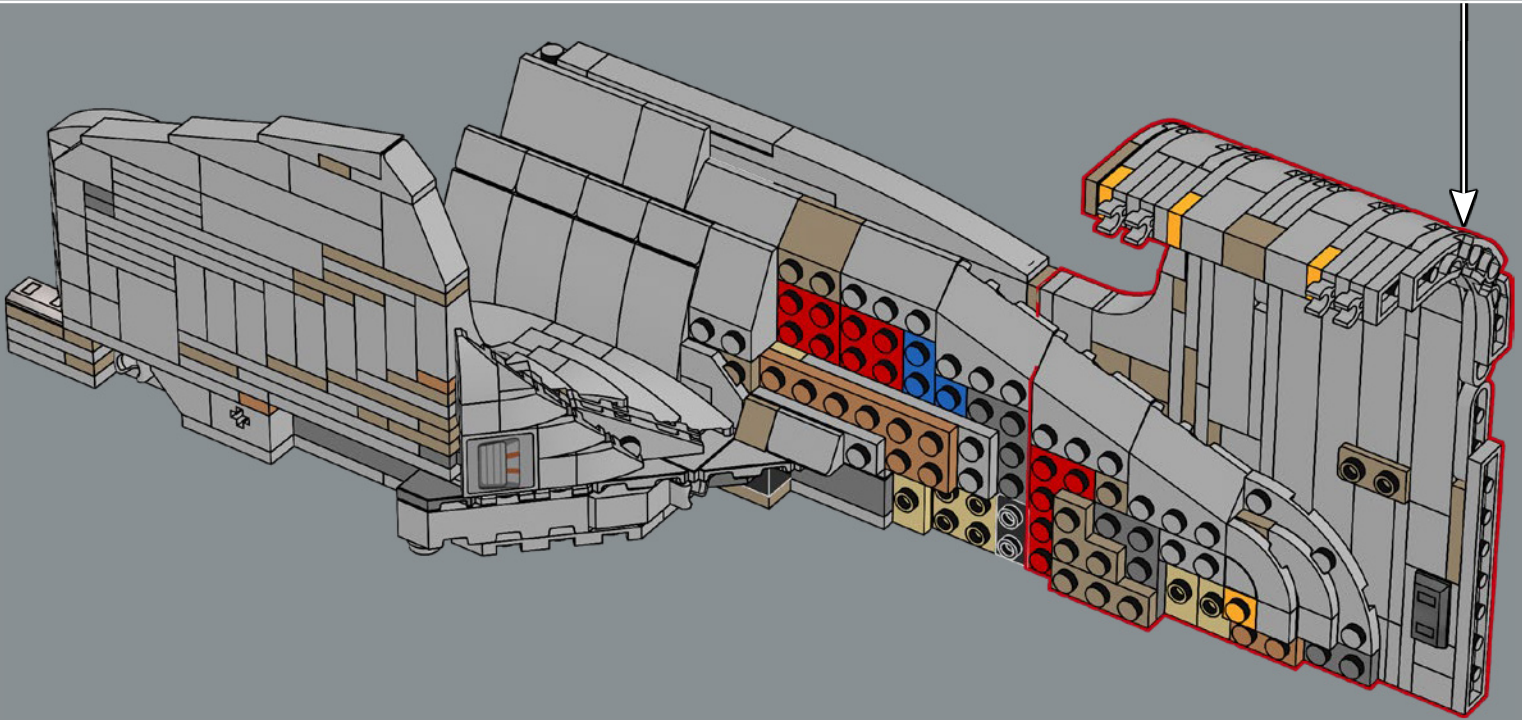

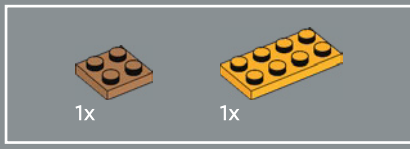

200

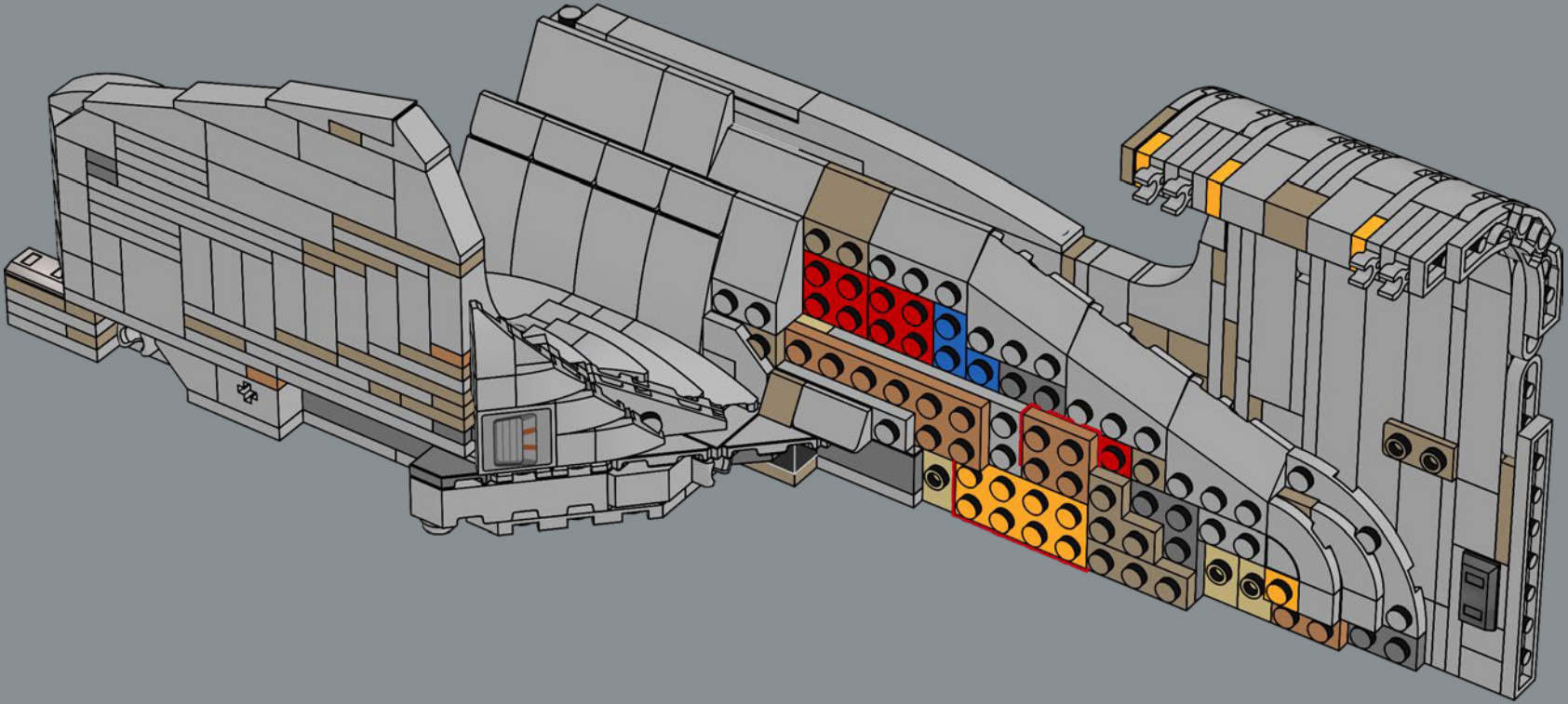

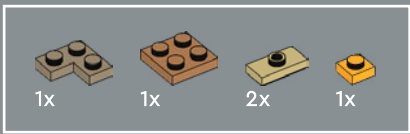

201

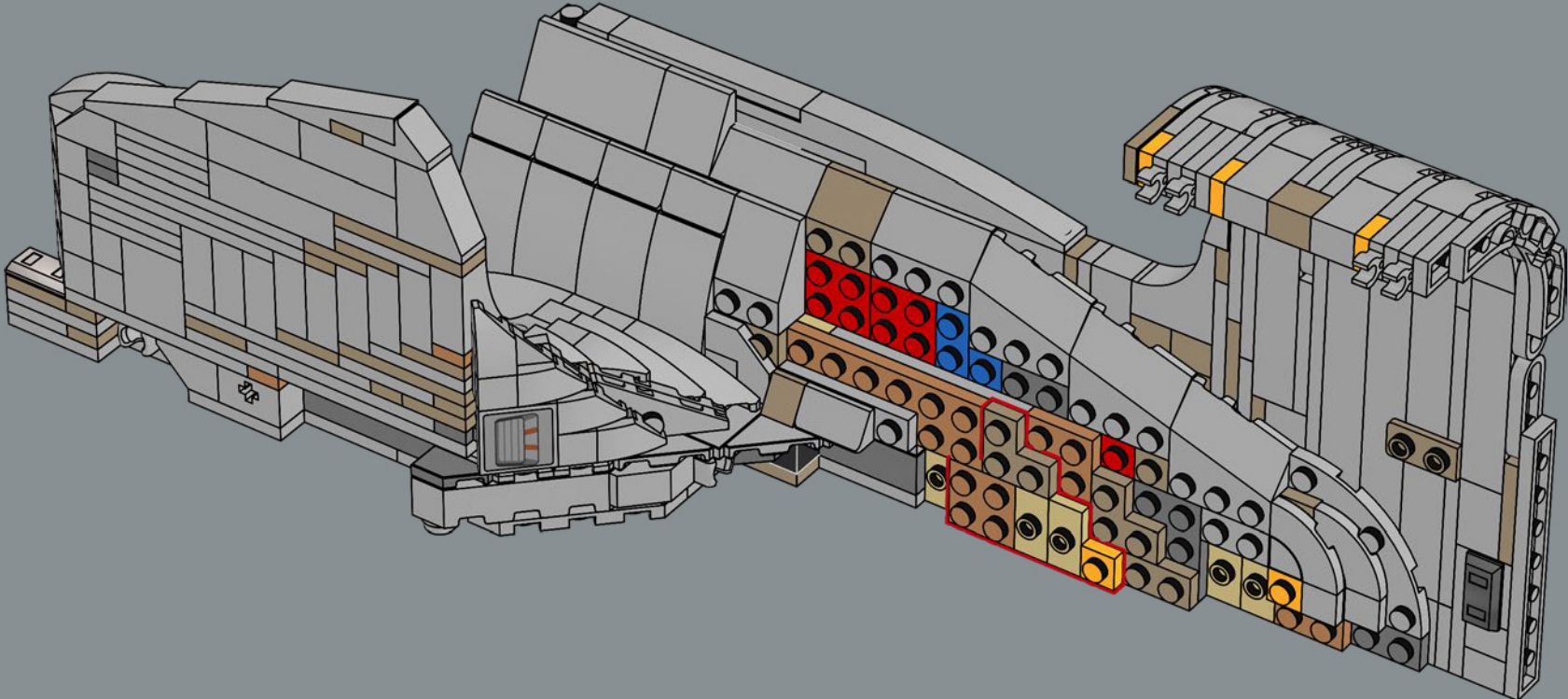

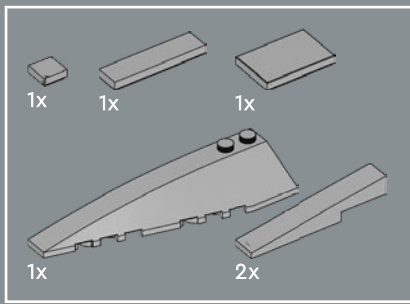

202

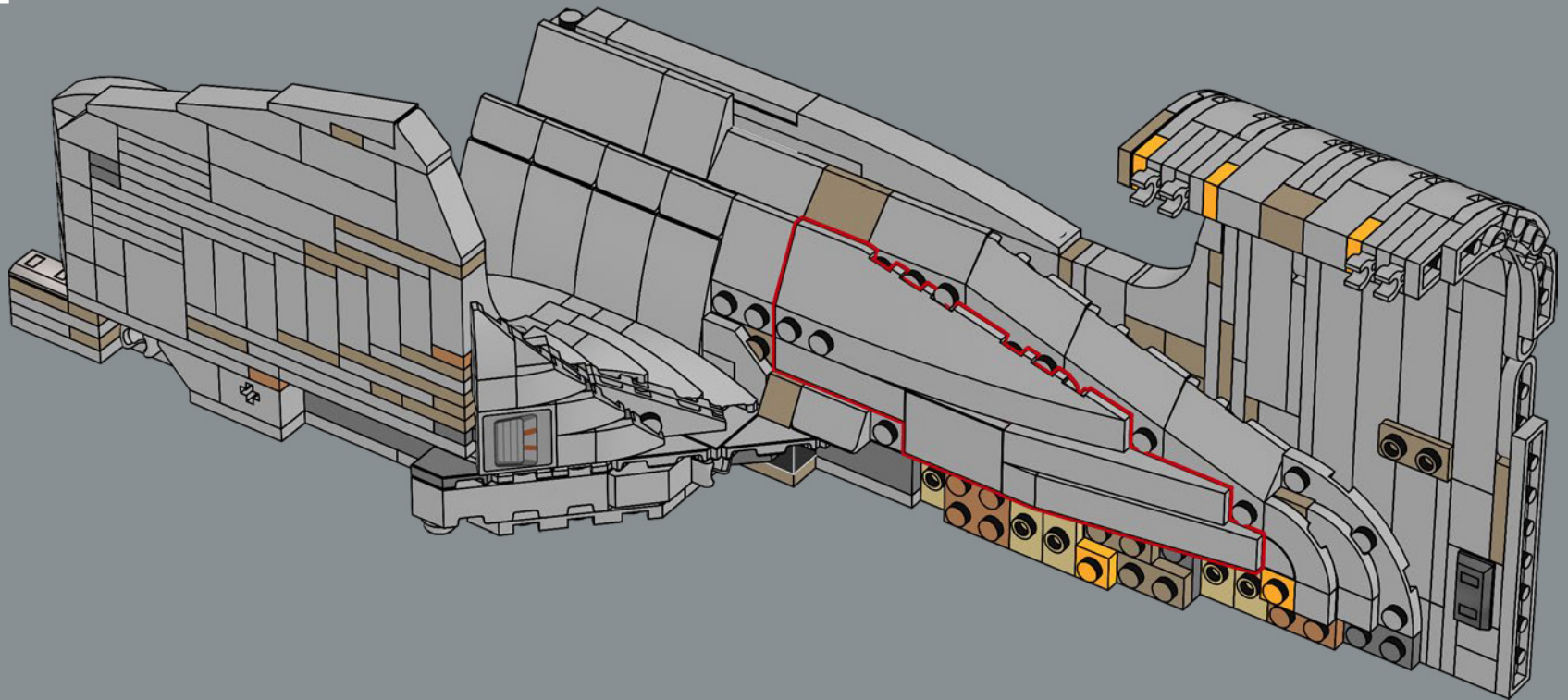

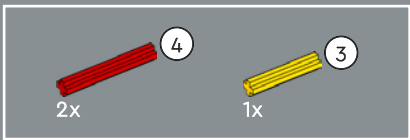

203

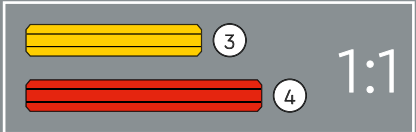
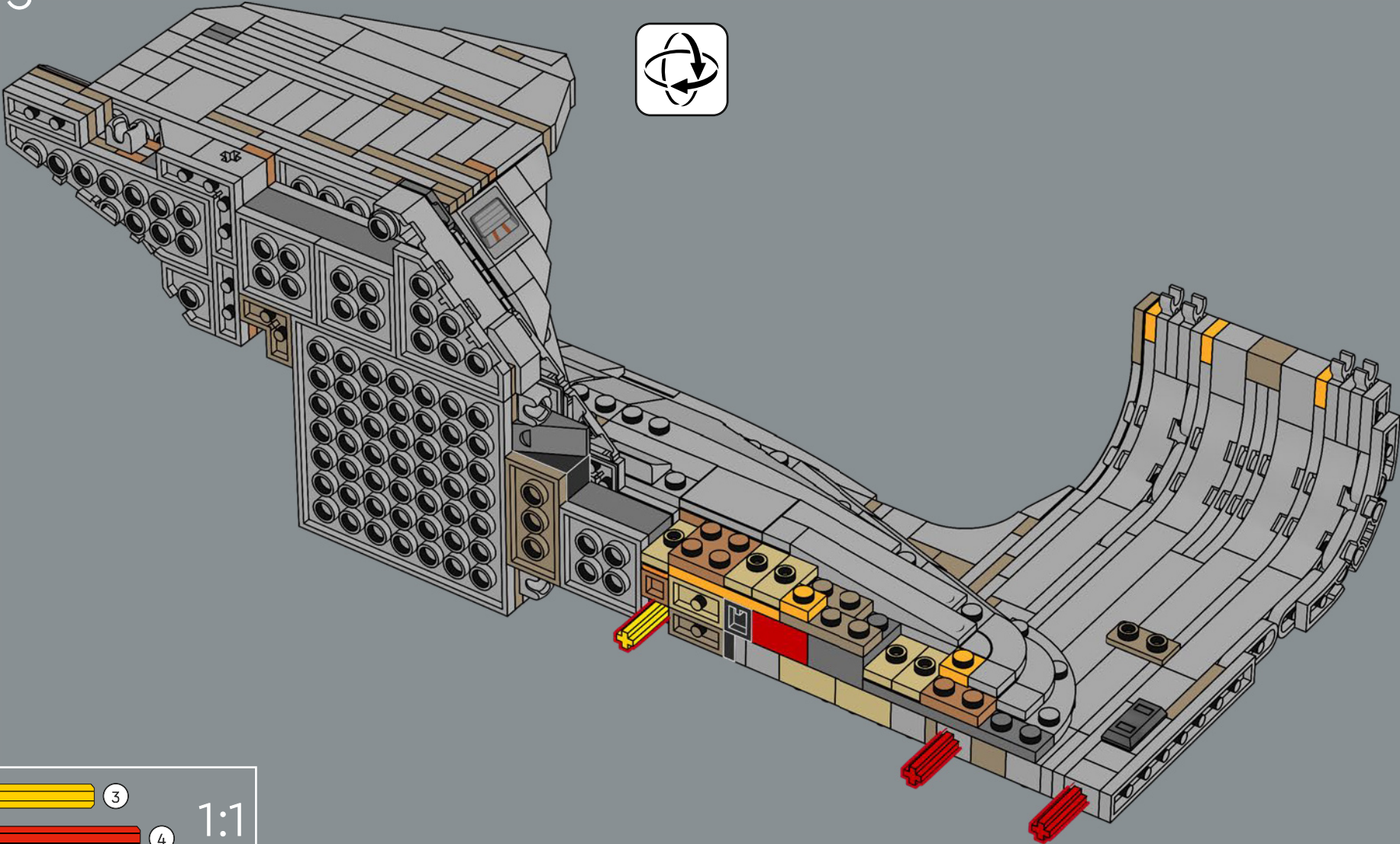

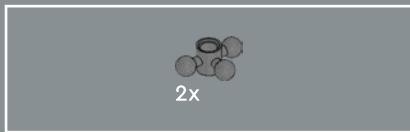

204

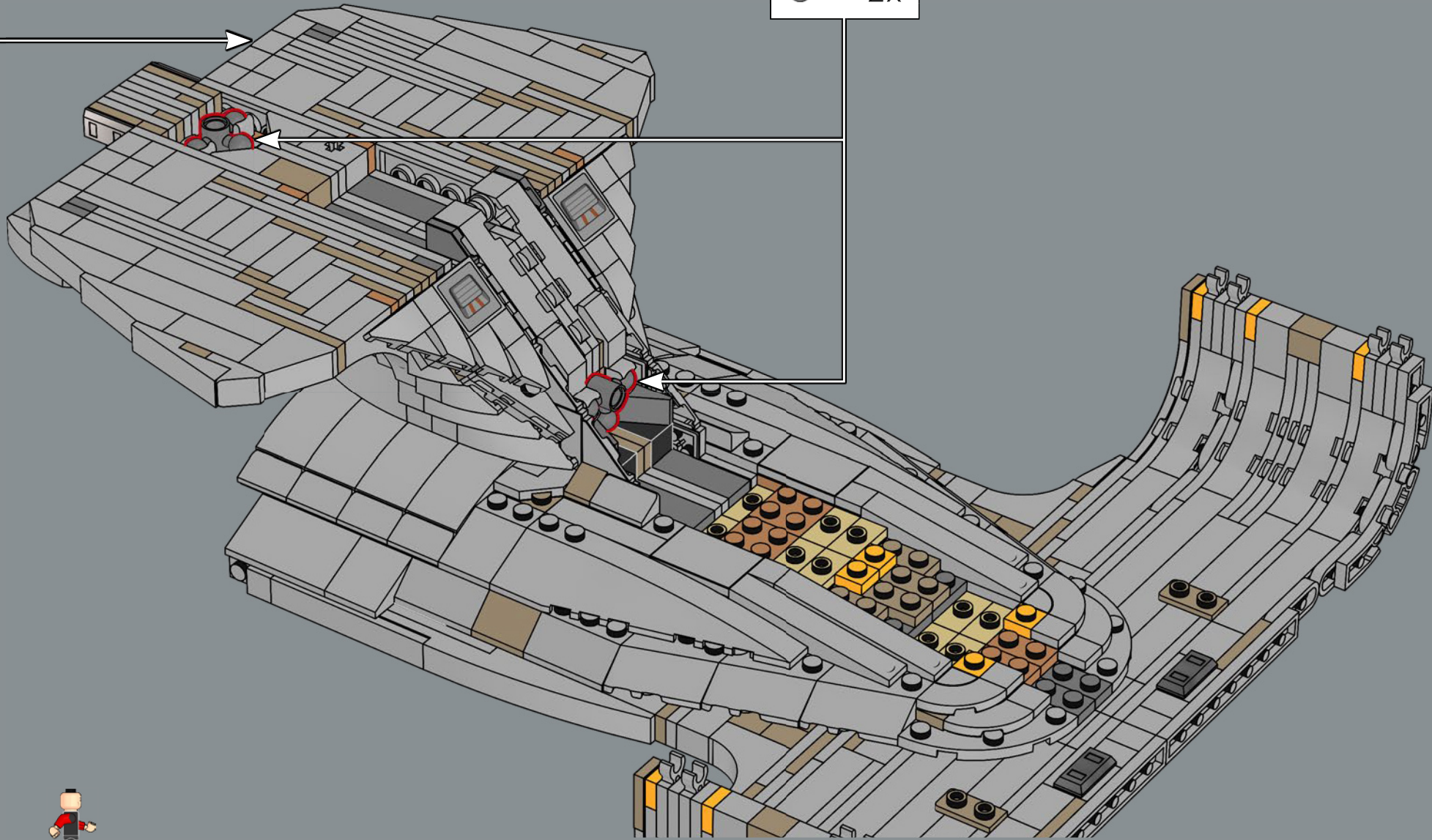



1x

205

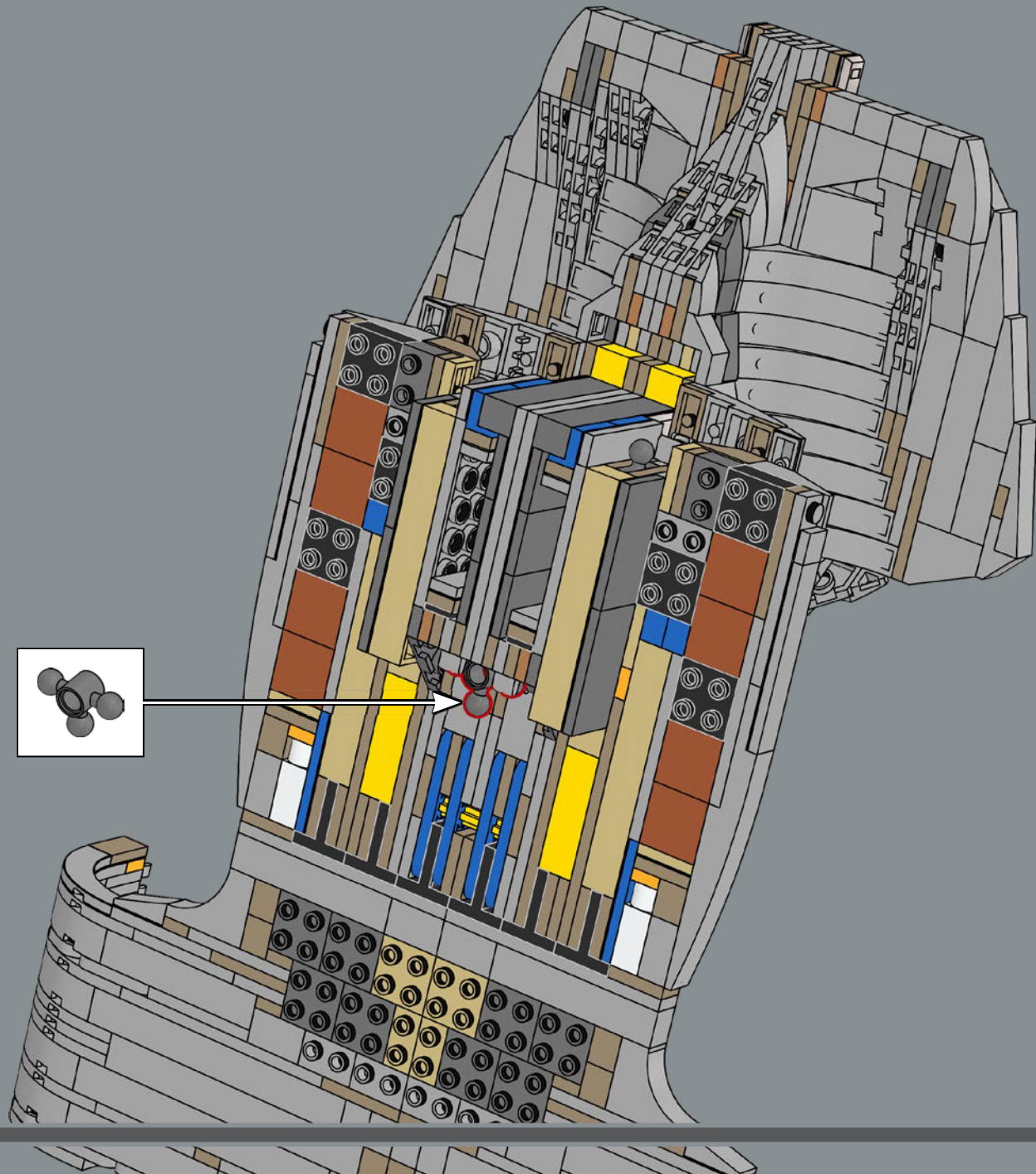
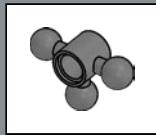

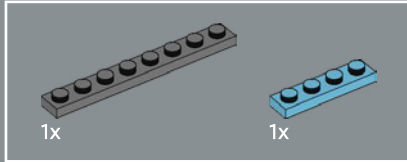
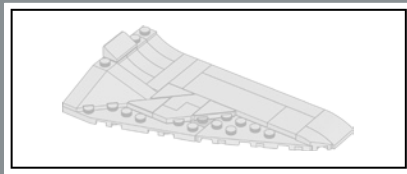

206

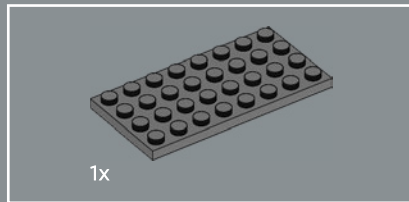
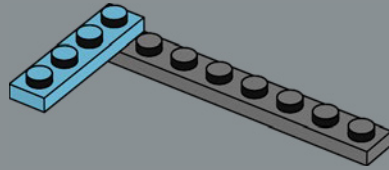

207

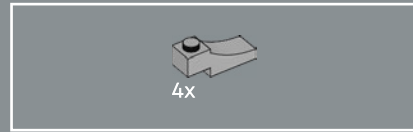
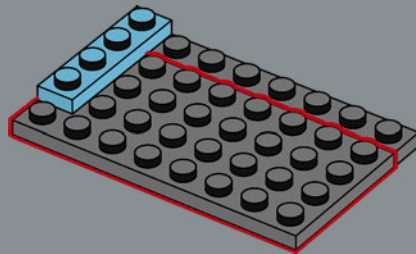

208

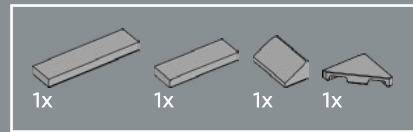
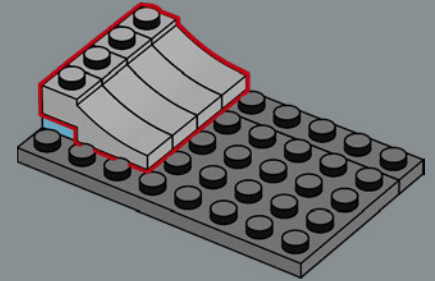

209

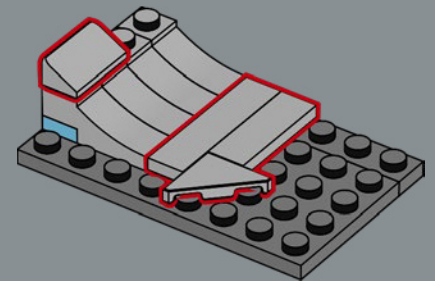

214

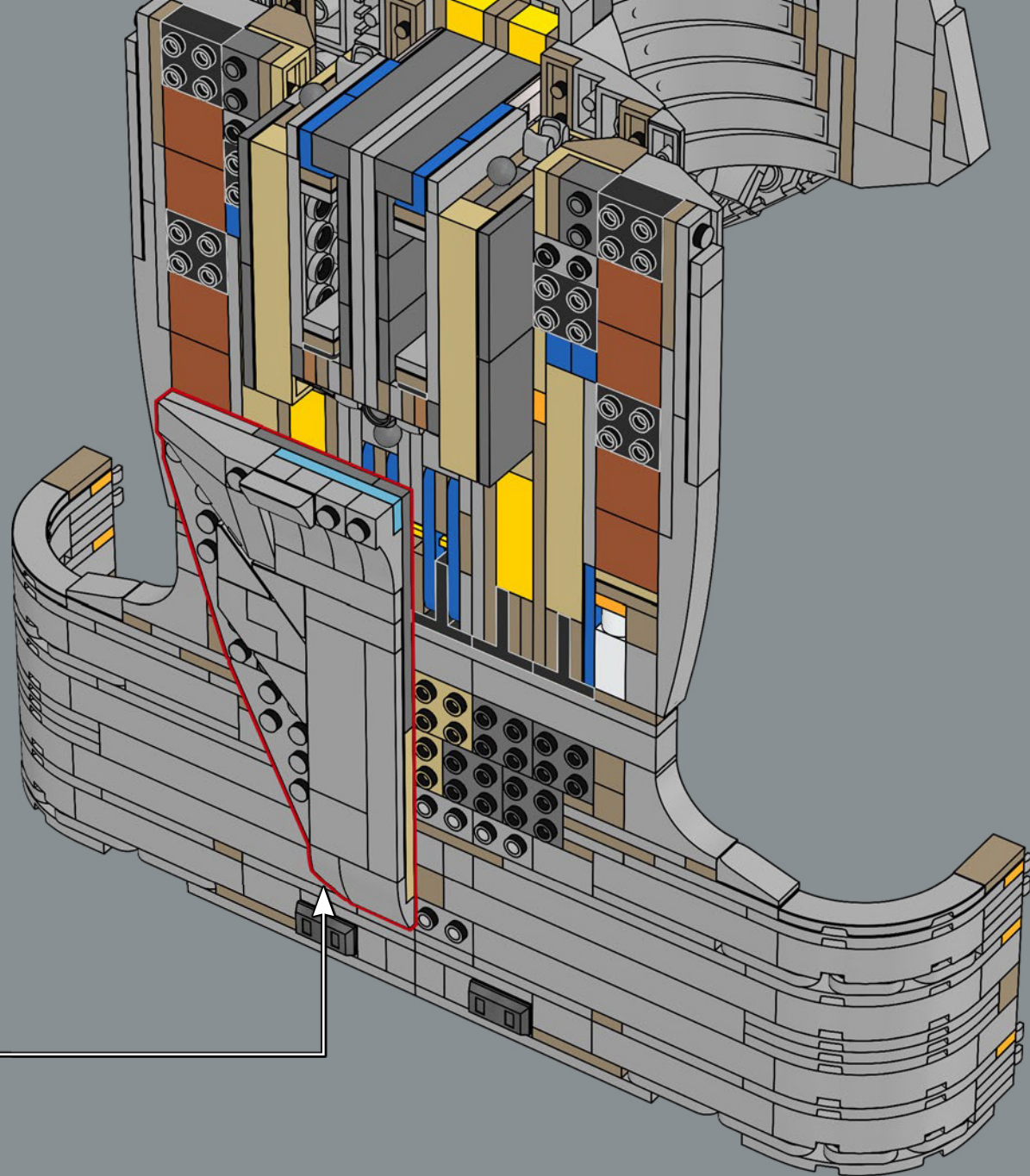

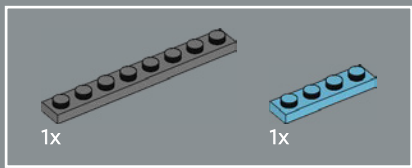

215

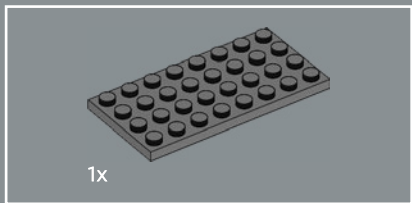
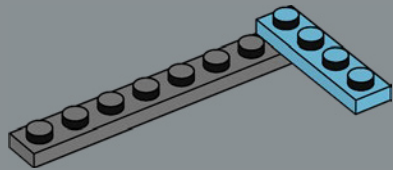

216

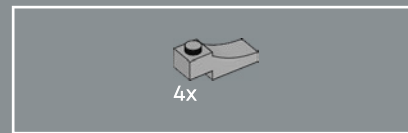
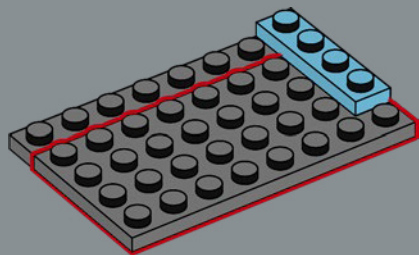

217

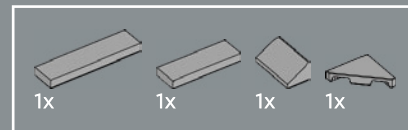
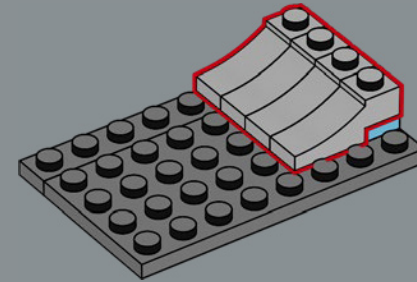

218

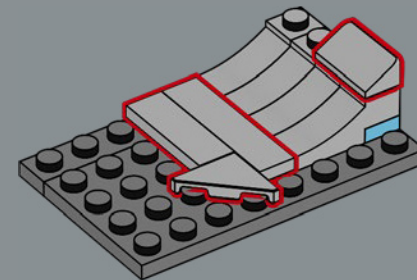

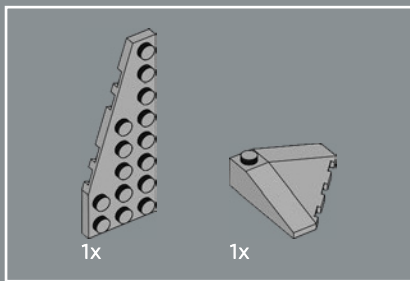

219

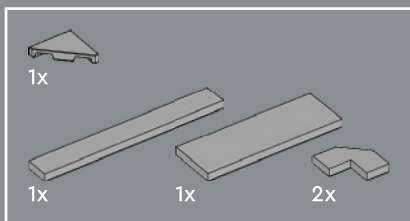
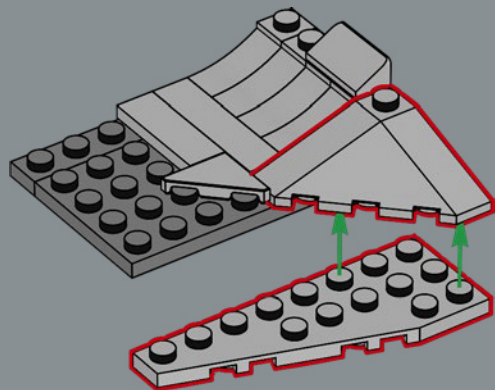

220

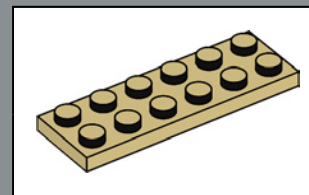
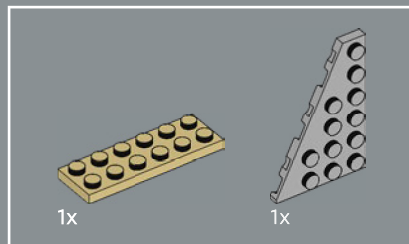
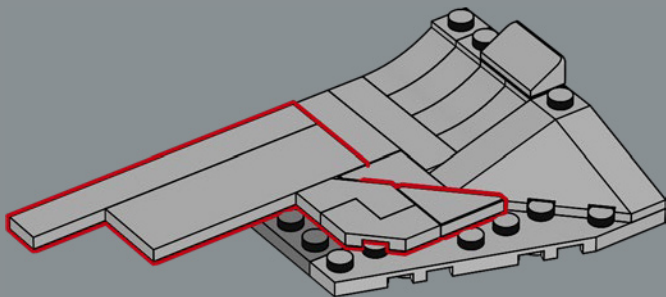

221

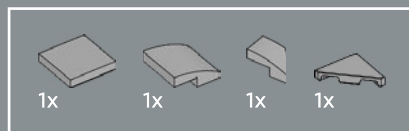
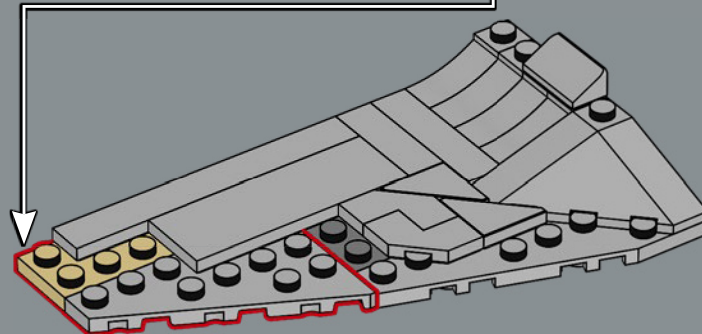

222

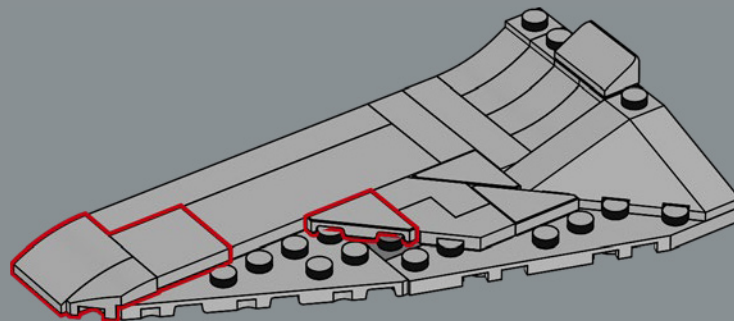

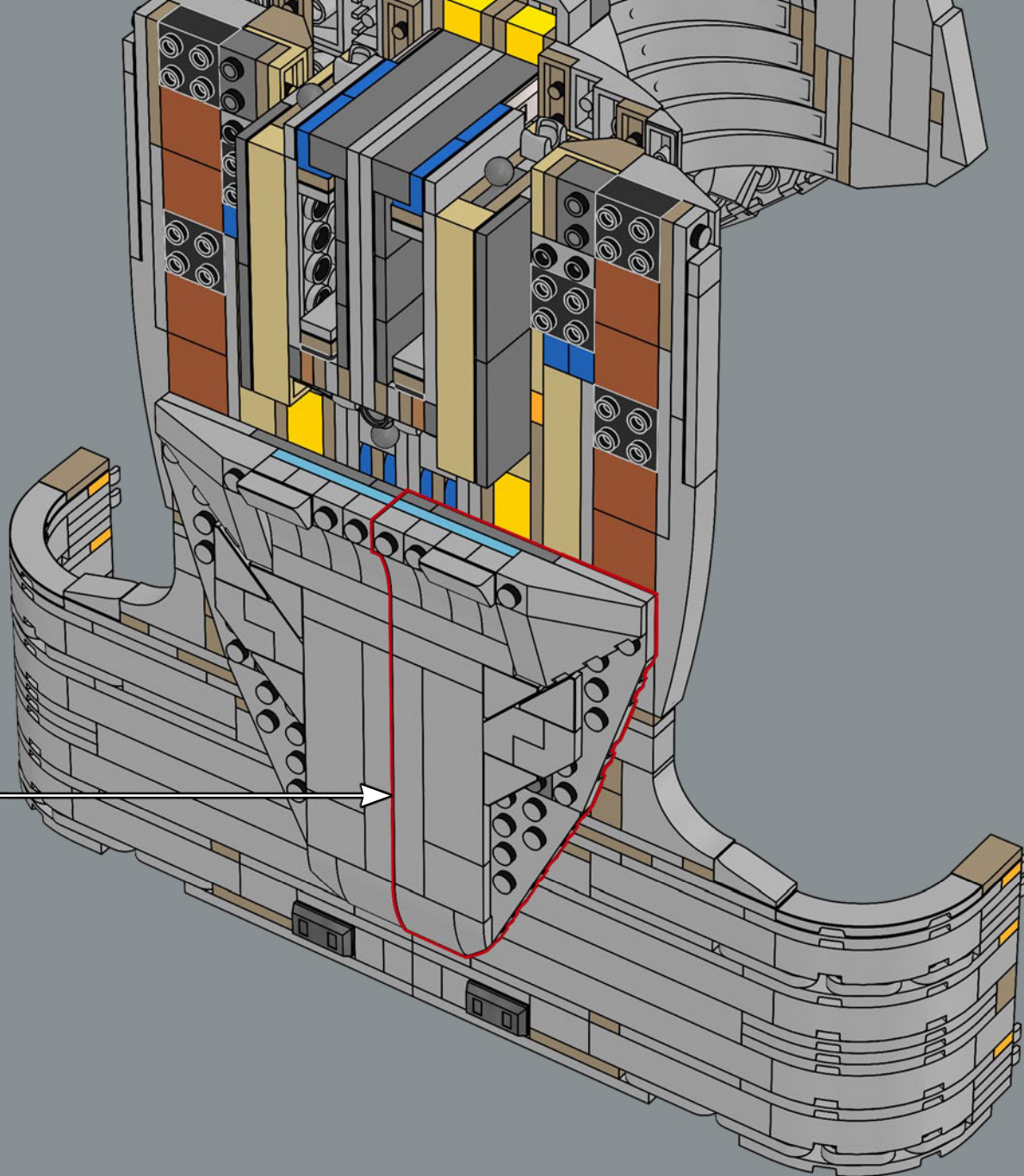

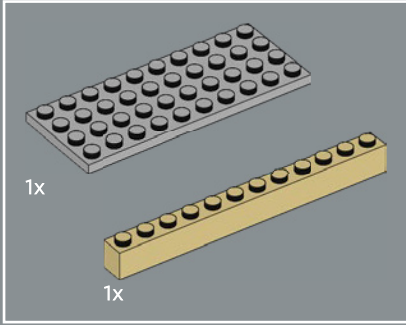
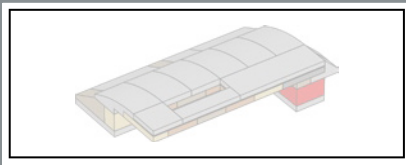

224

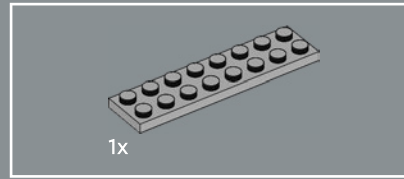
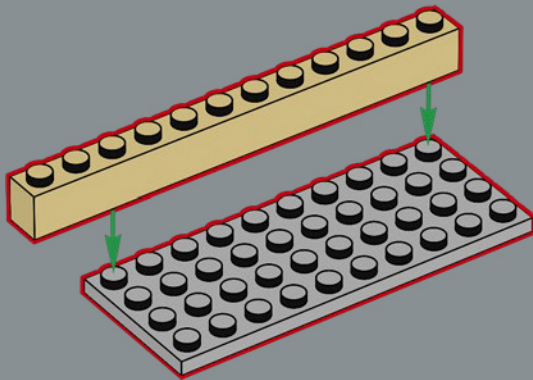

225

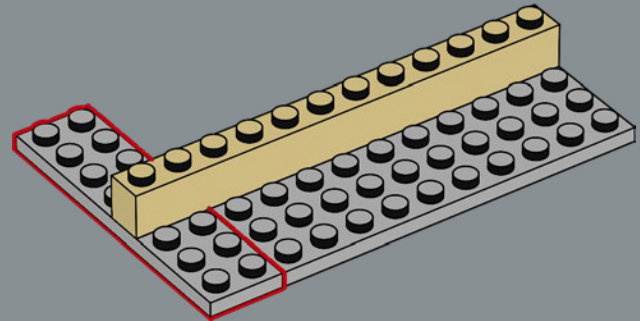

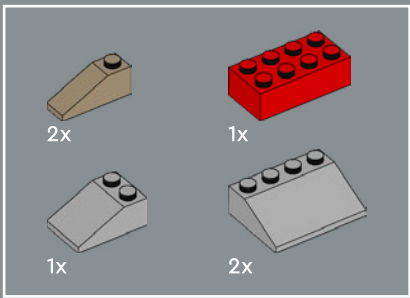

226

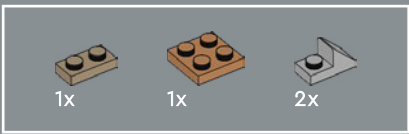
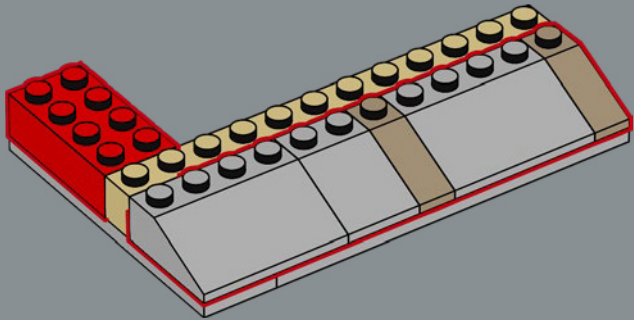

227

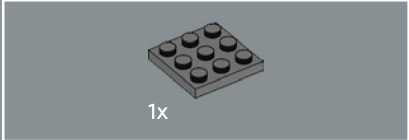
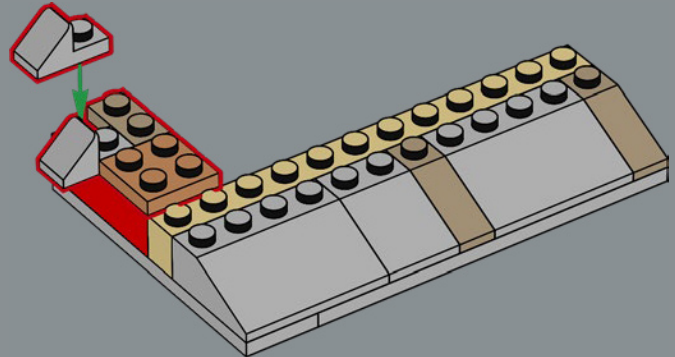

228

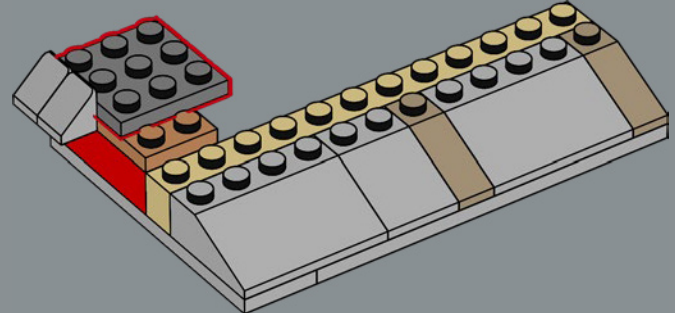

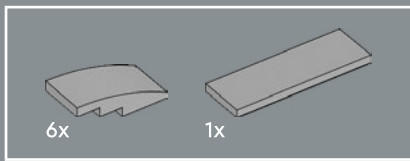

229

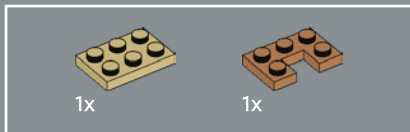
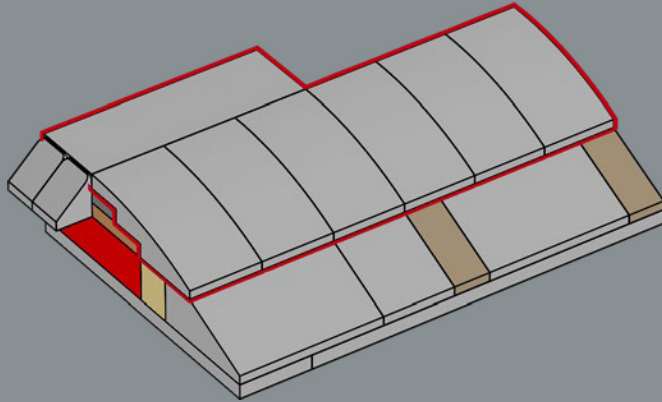

230

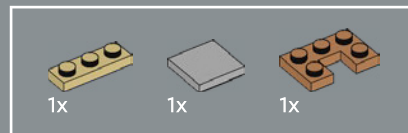
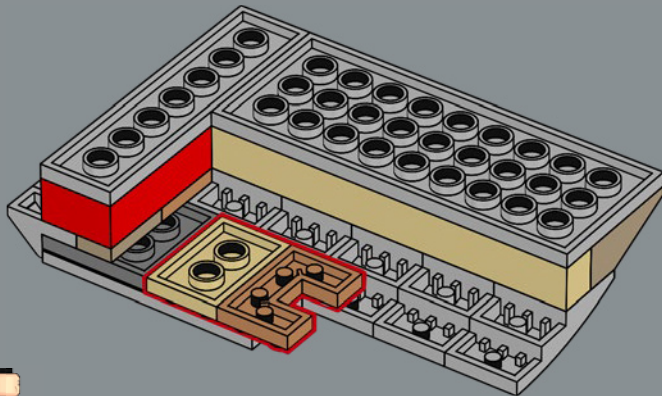

231

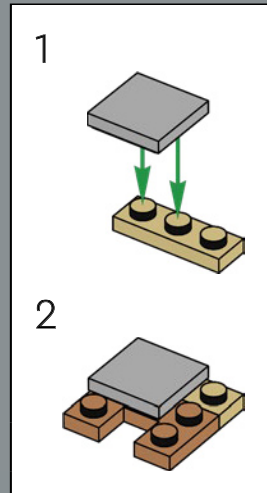
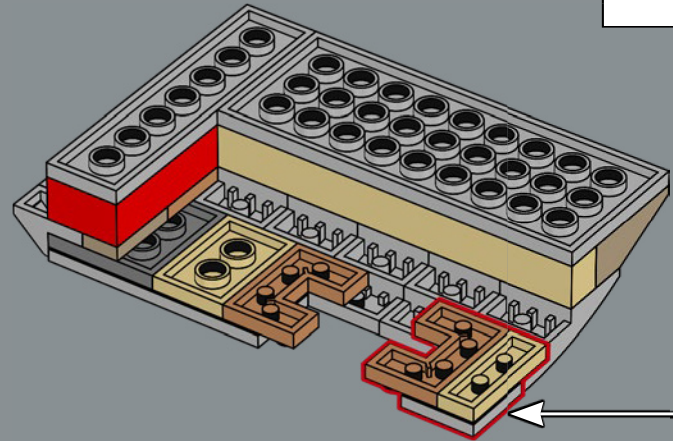

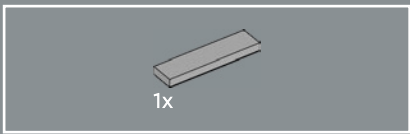

232

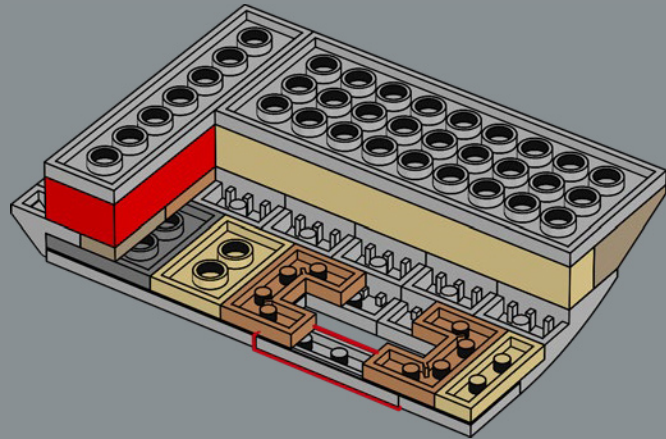

233

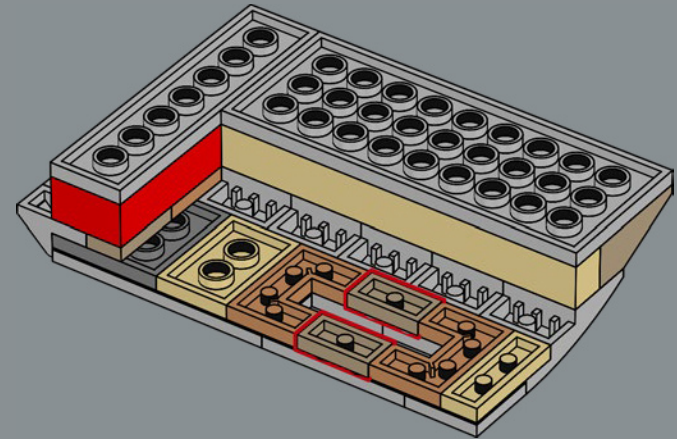

234

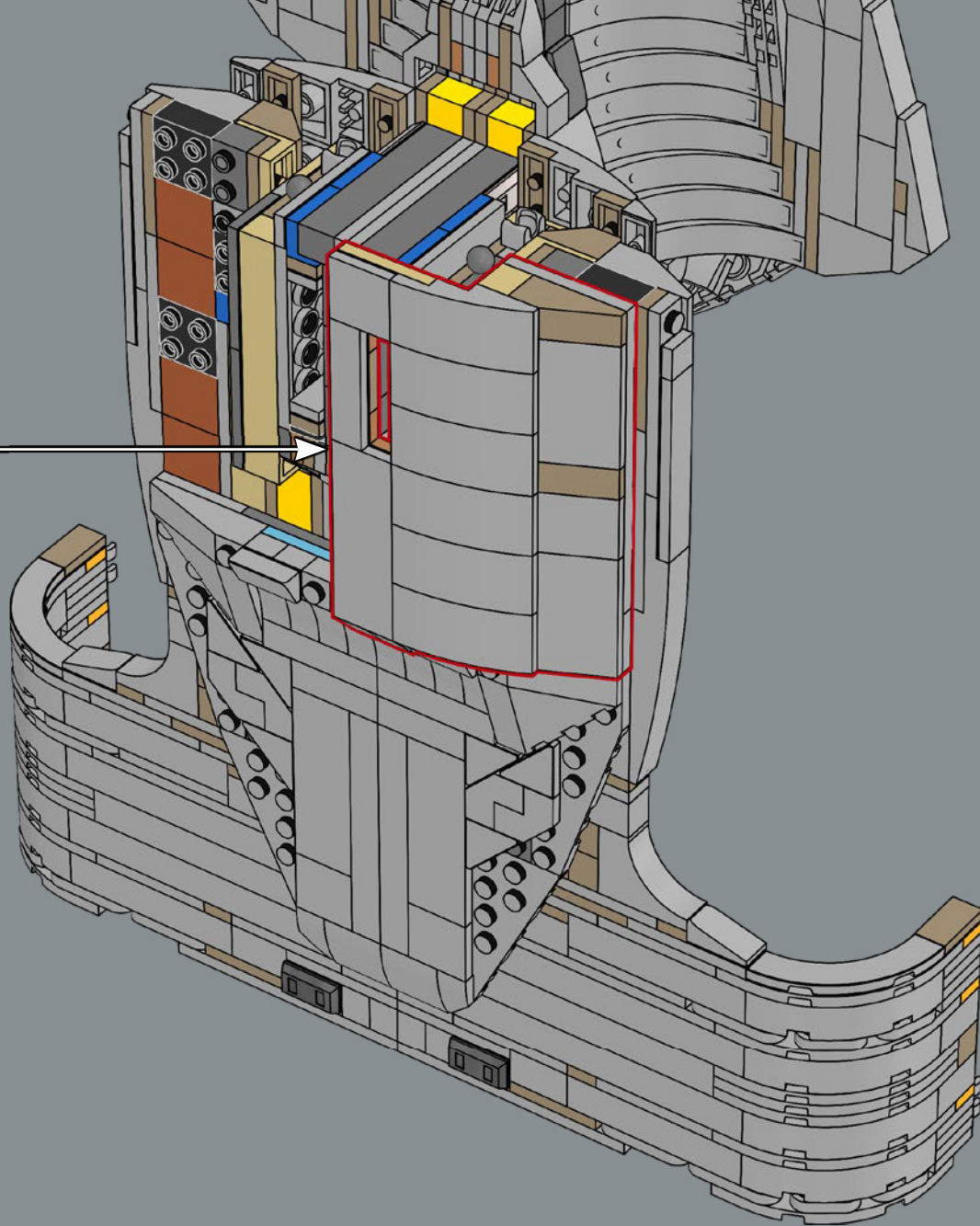

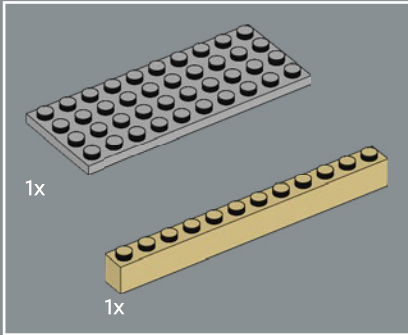
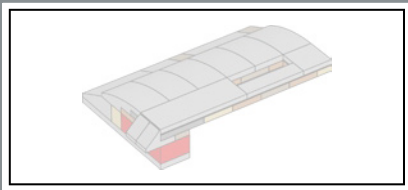

235

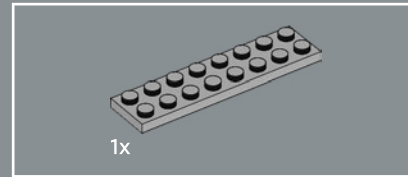
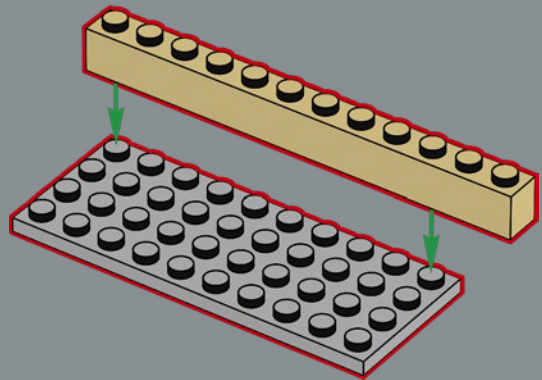

236

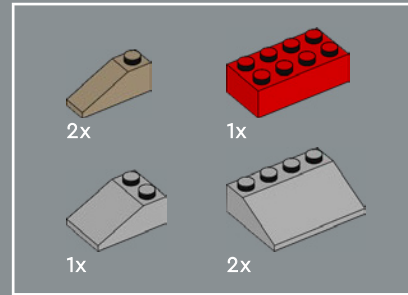
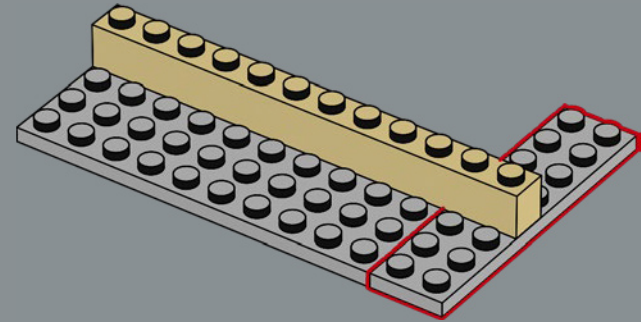

237

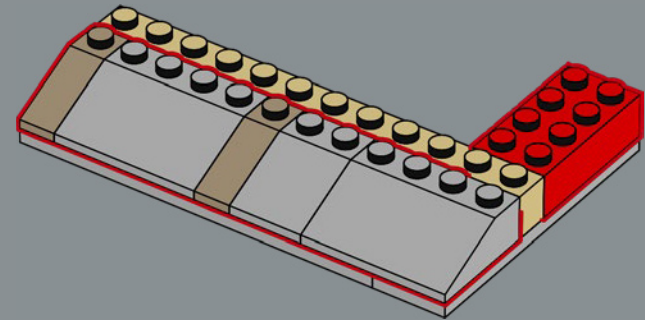

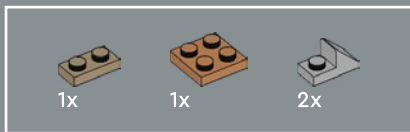

238

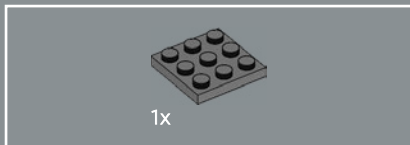
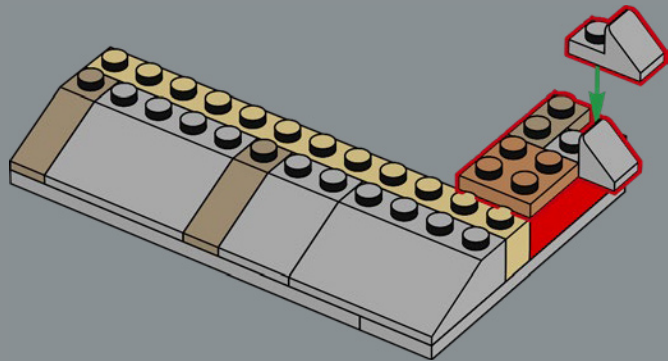

239

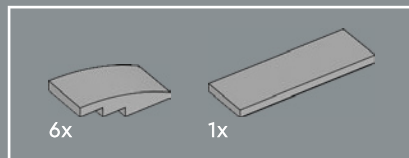
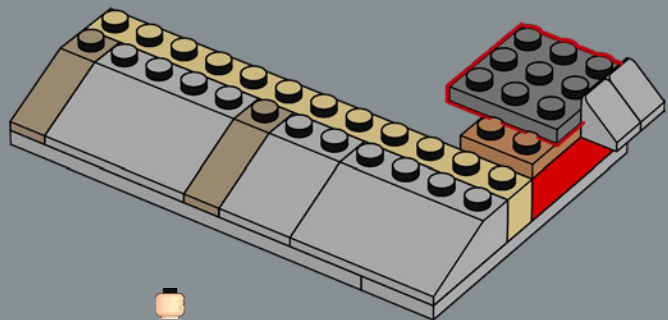

240

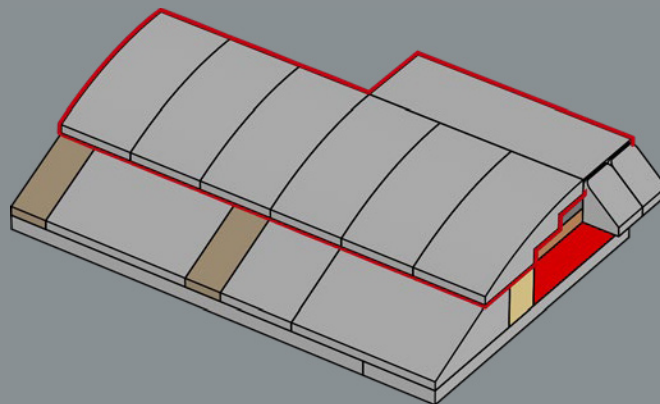

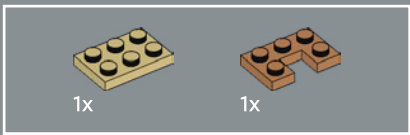

241

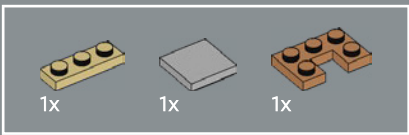
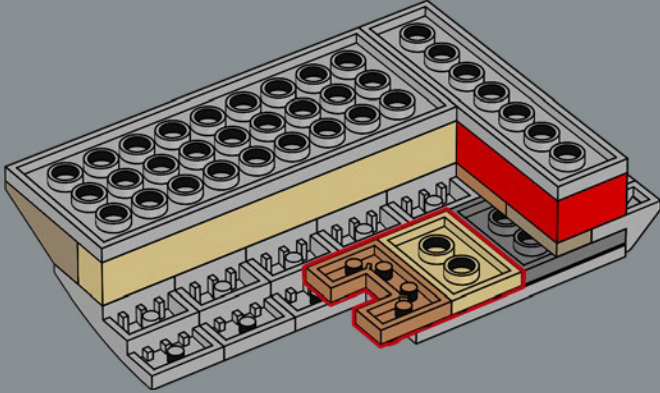

242

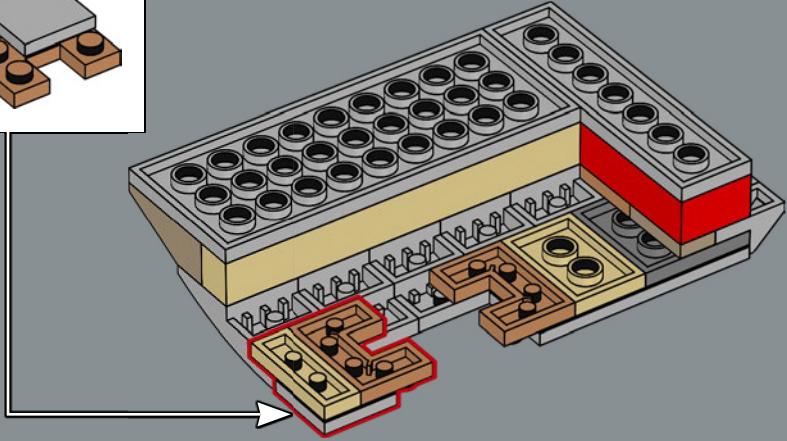
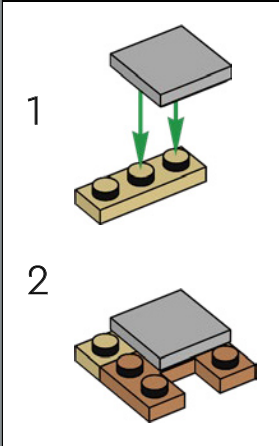

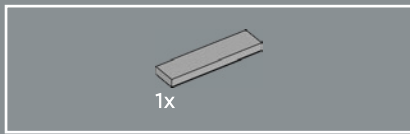

243

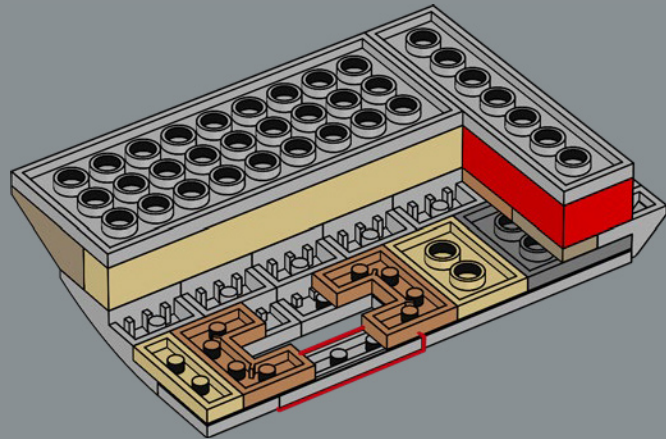

244

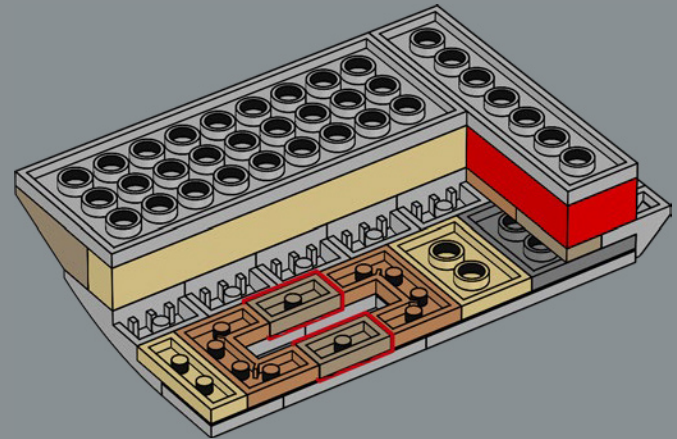

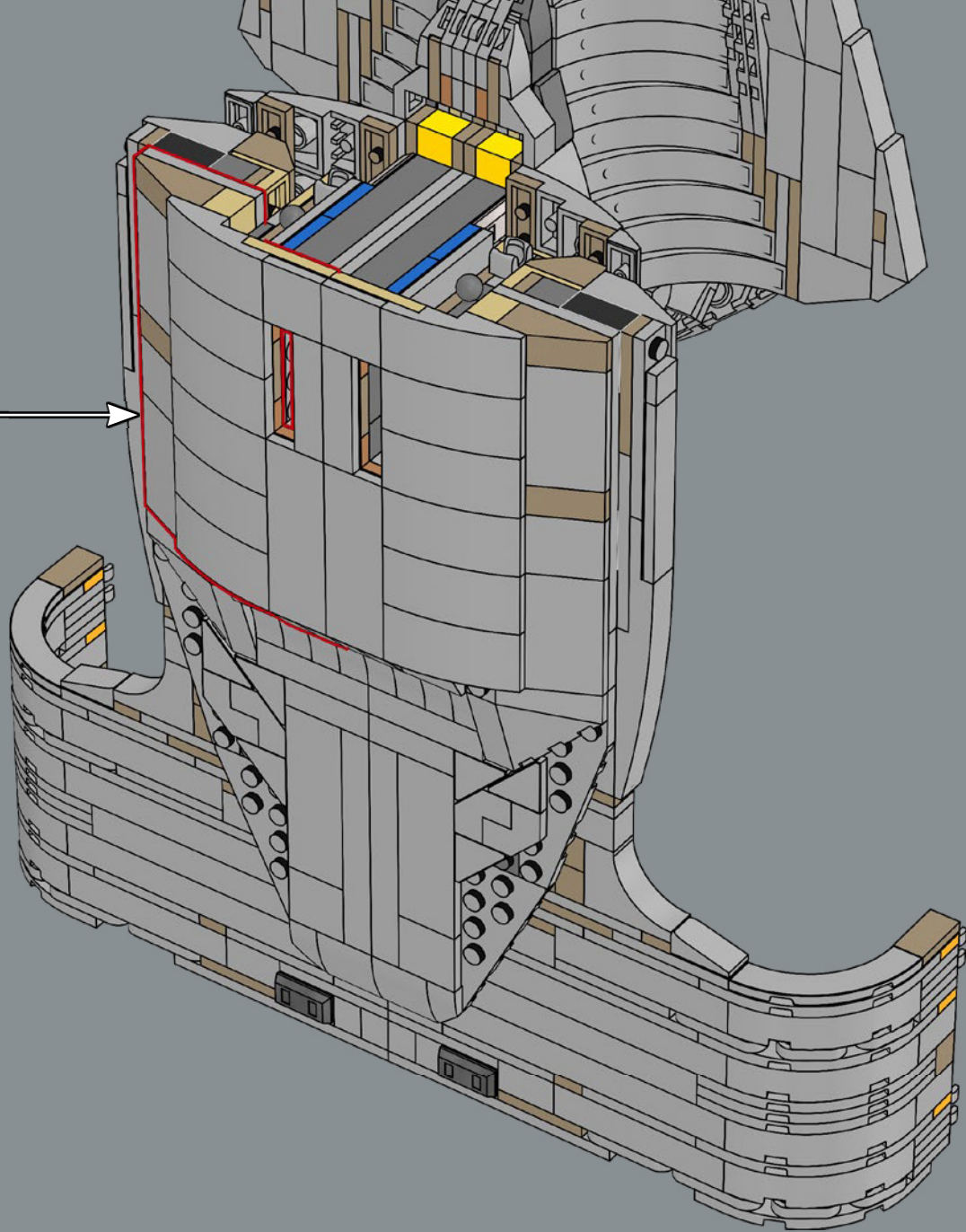



Commander William Riker plays the jazz trombone as a hobby. The instrument can be placed on its stand when not in use. This is the first LEGO® set ever to feature this instrument.

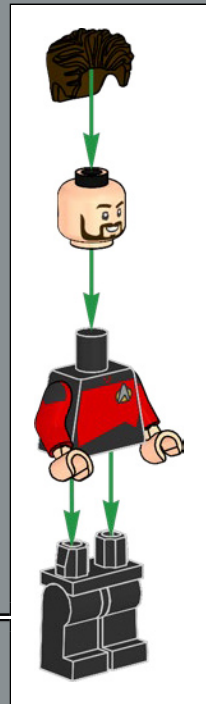
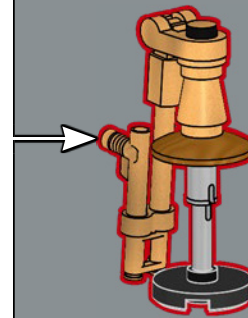
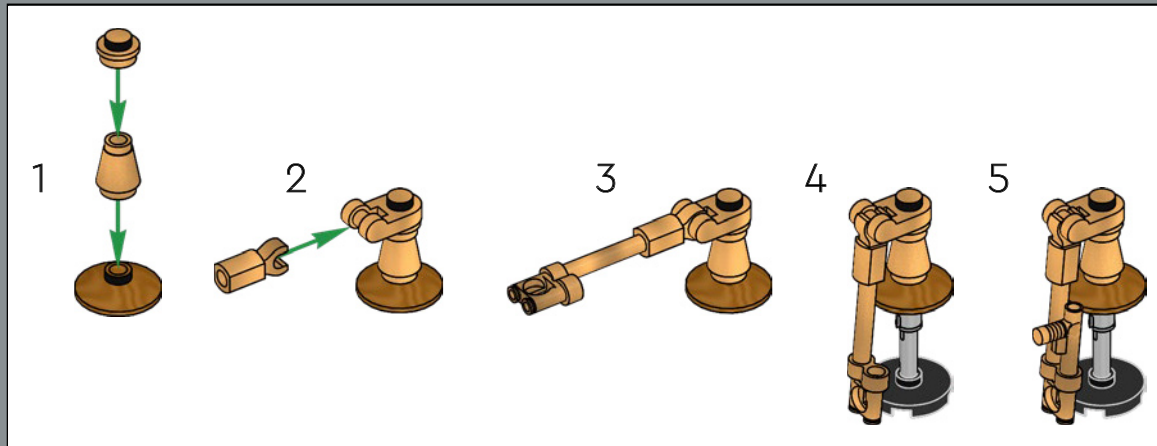
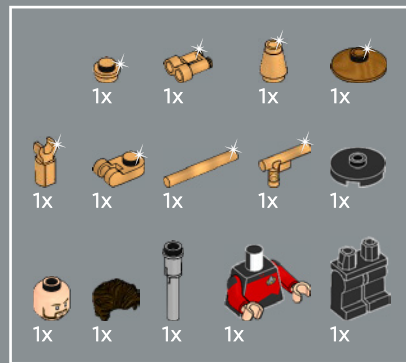

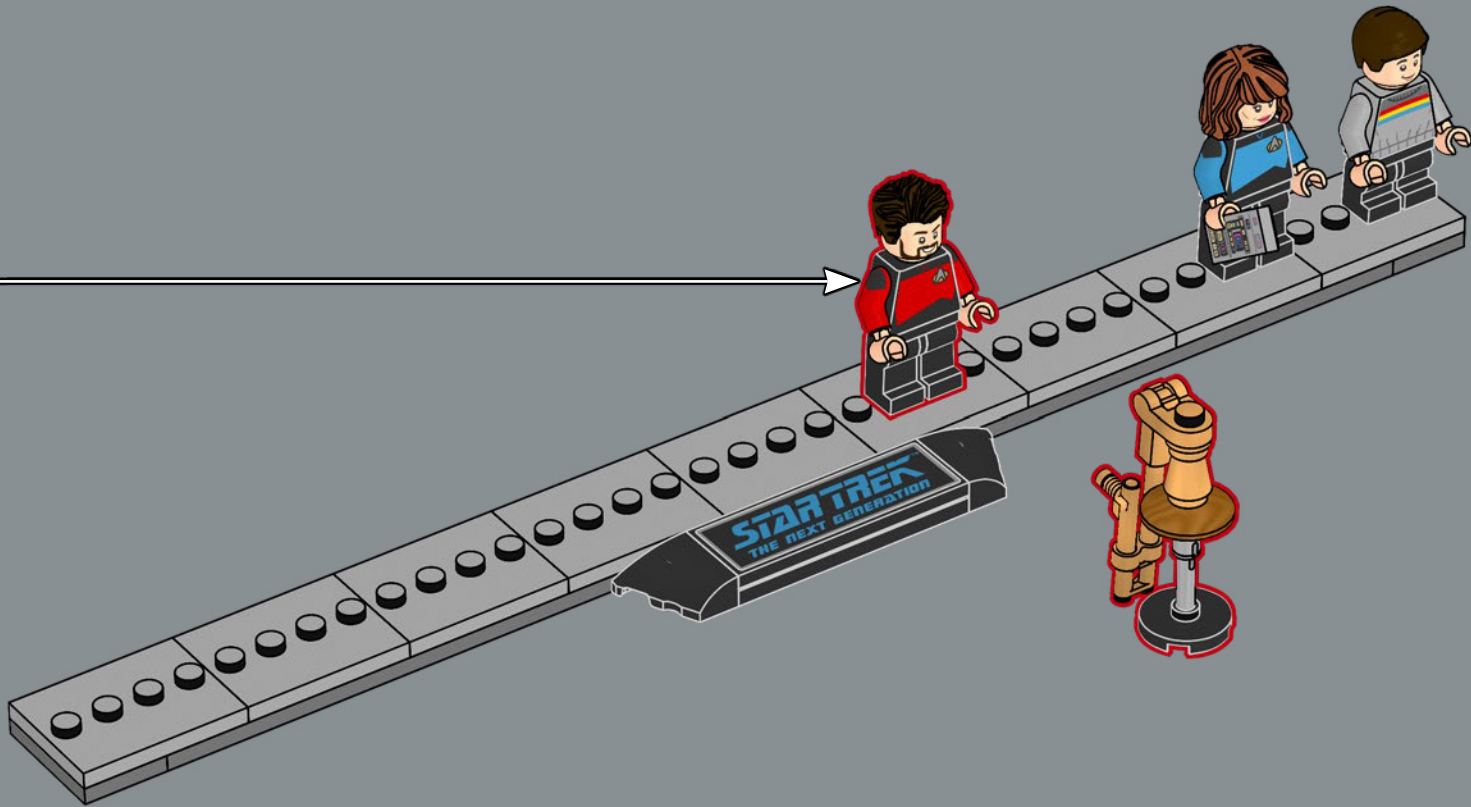

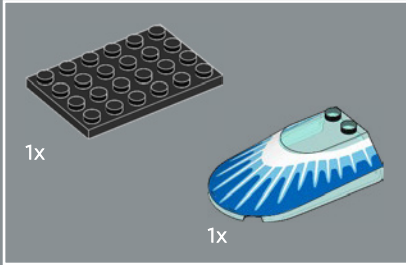
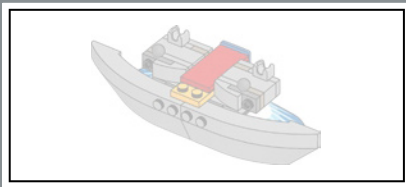

246

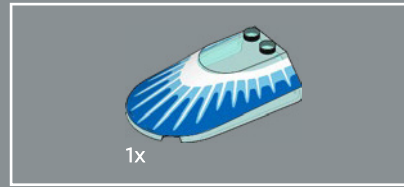
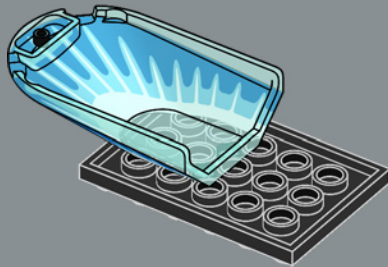

247

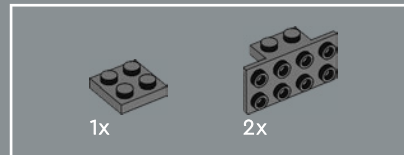
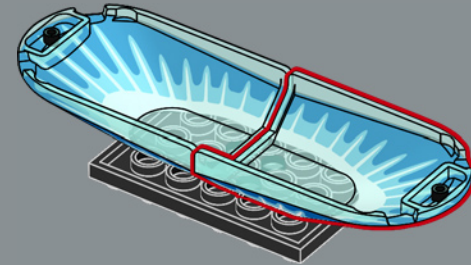

248

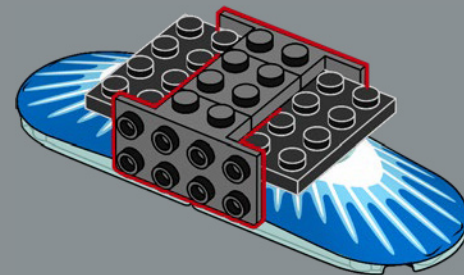

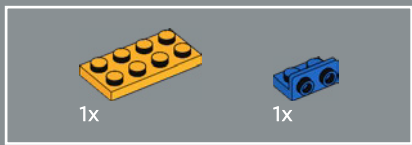

249

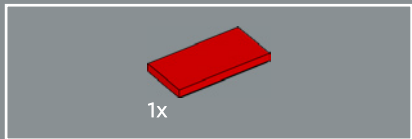
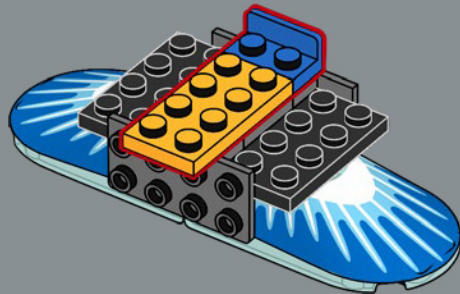

250

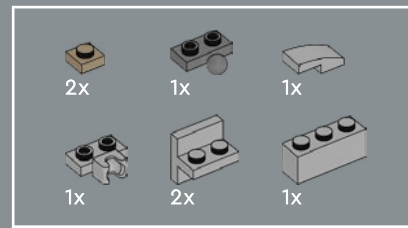
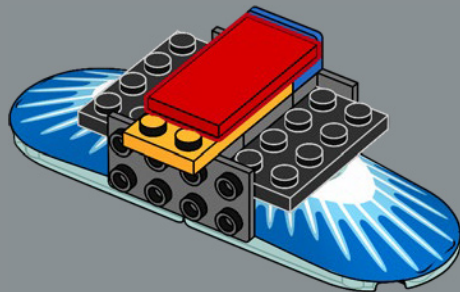

251

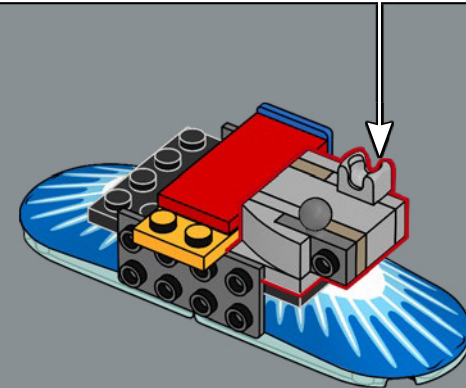
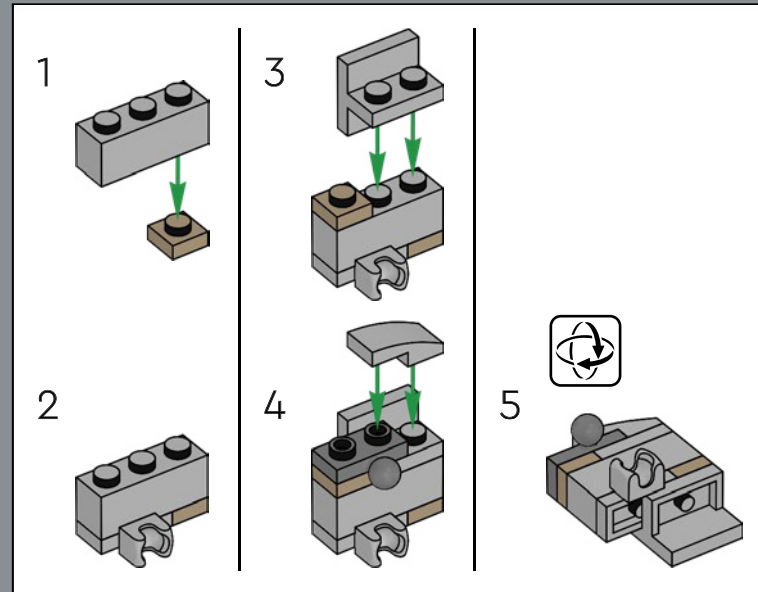

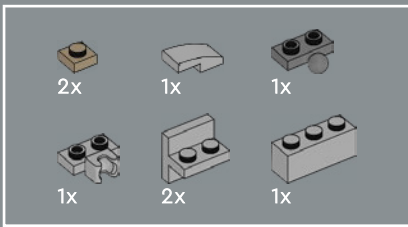

252

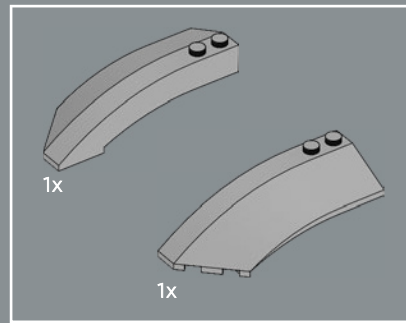
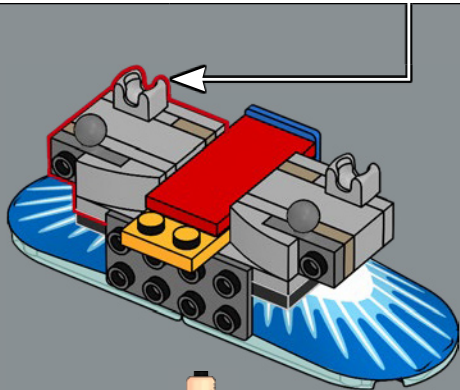
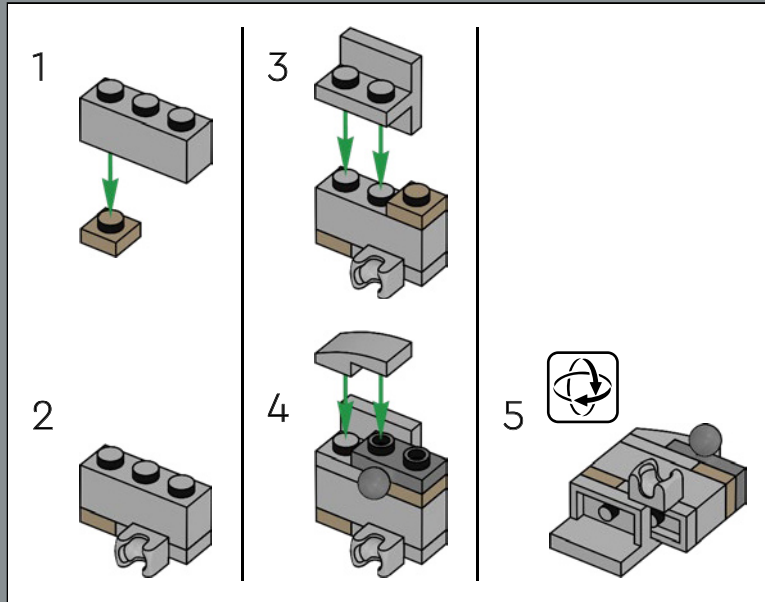

253

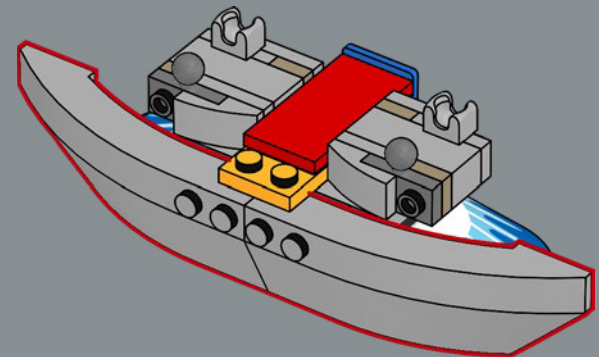

254

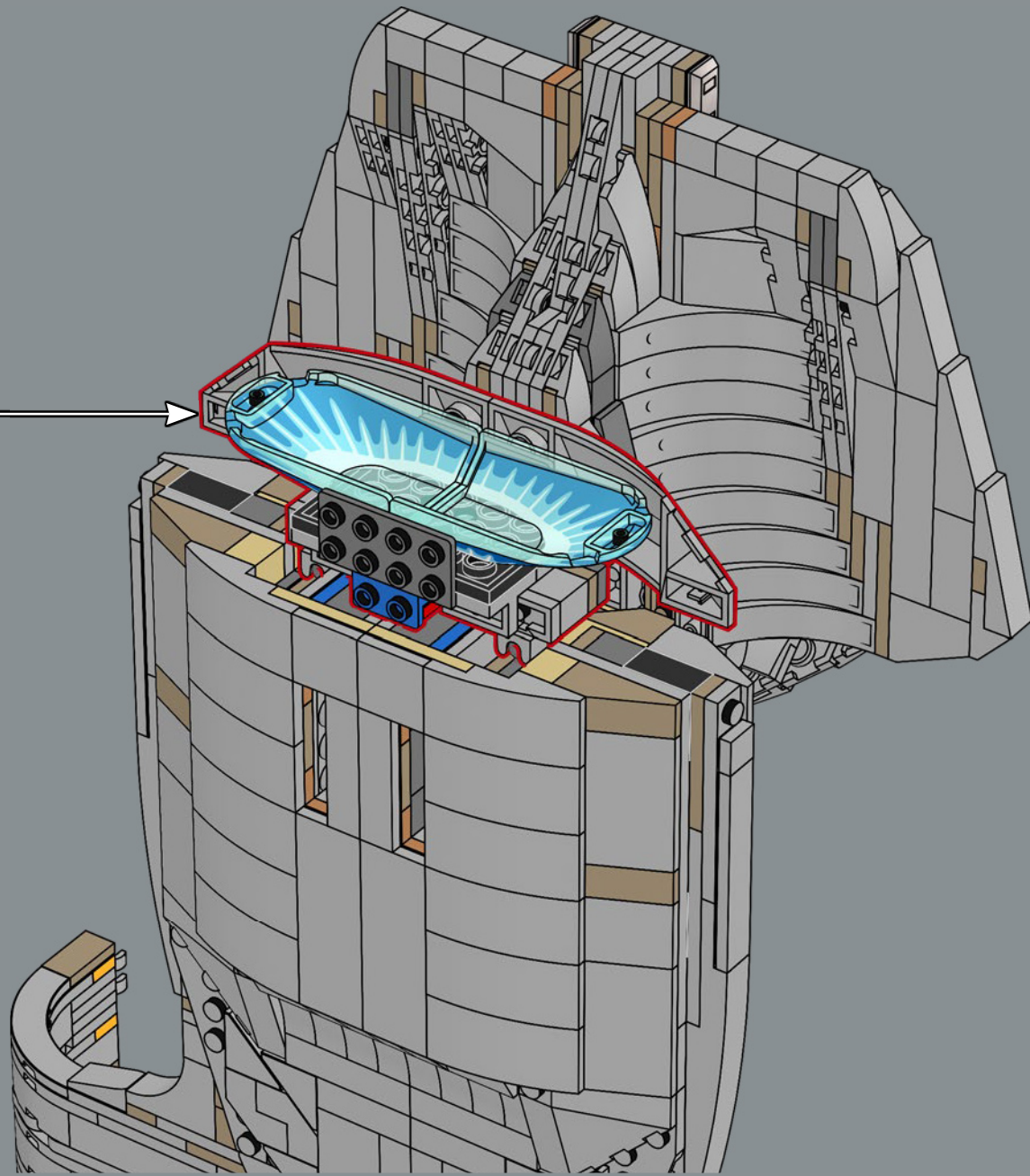

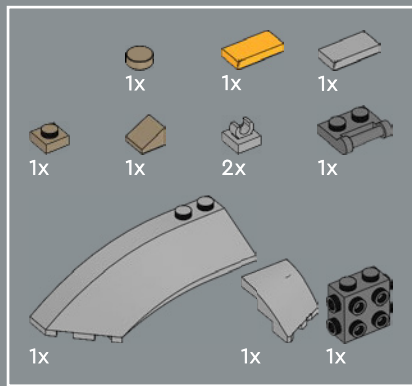

255

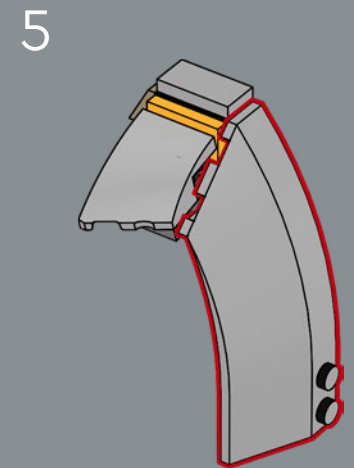
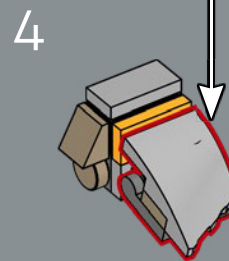
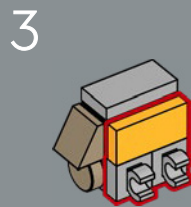
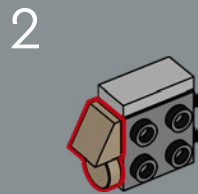
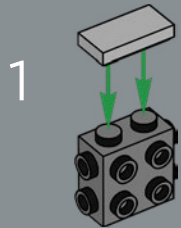
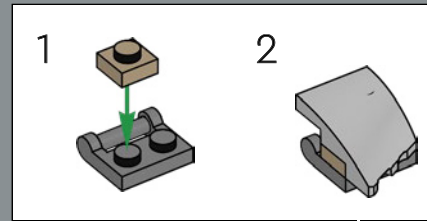

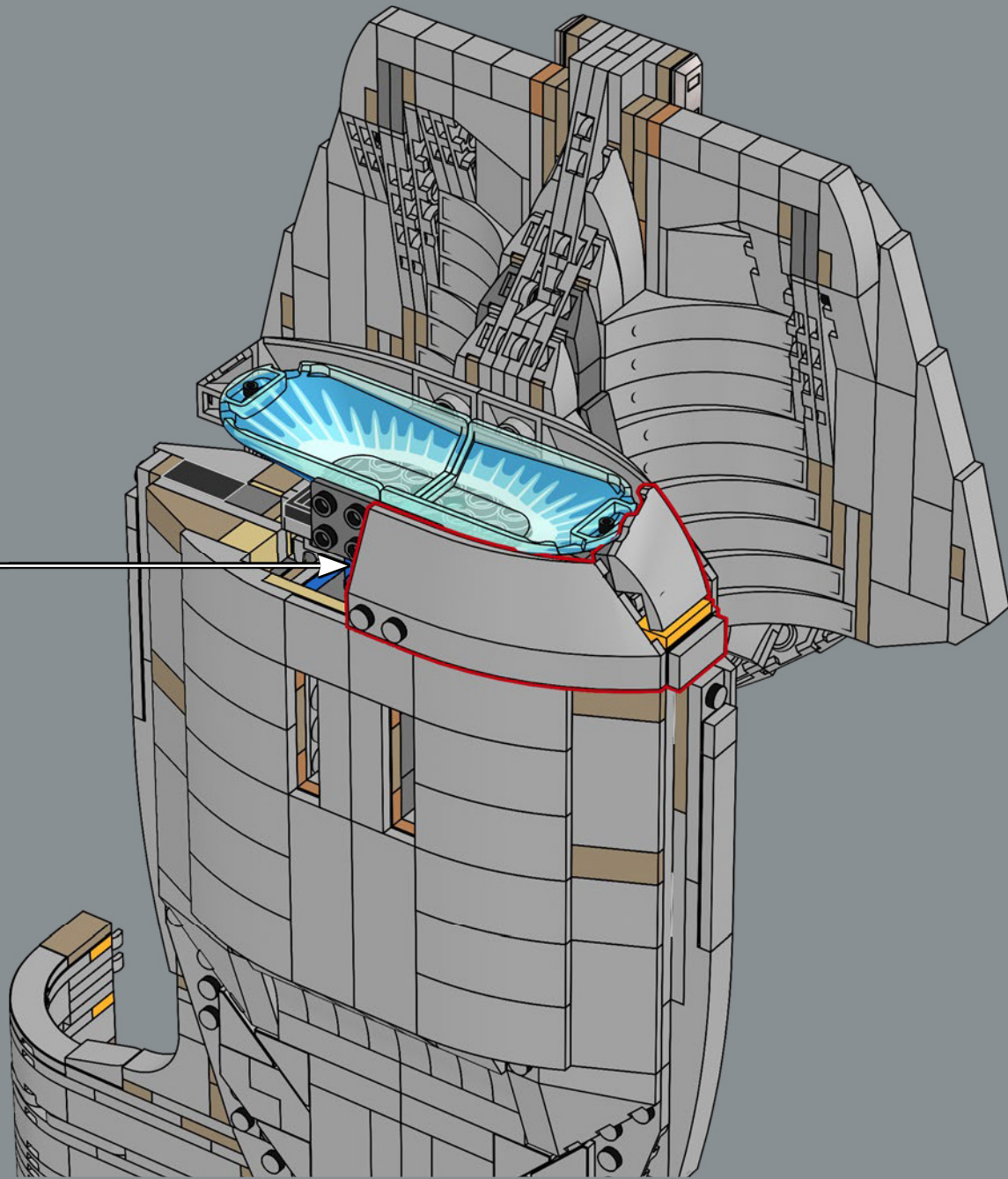

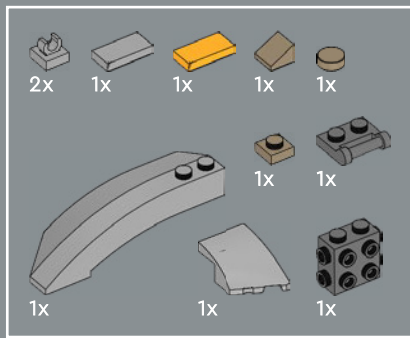

256

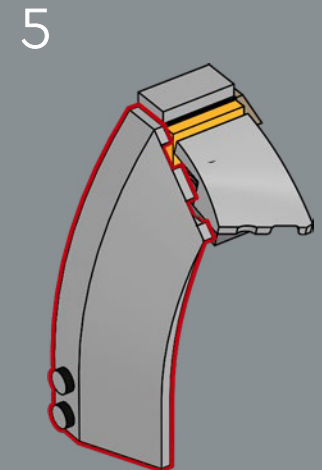
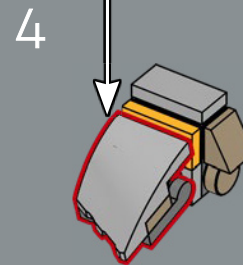
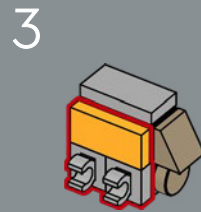
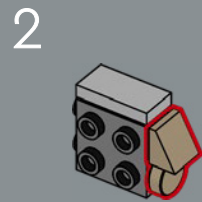
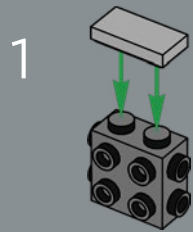
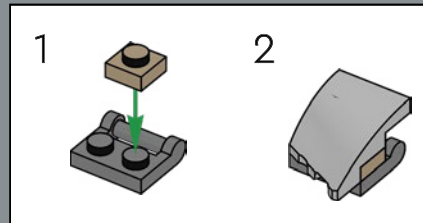

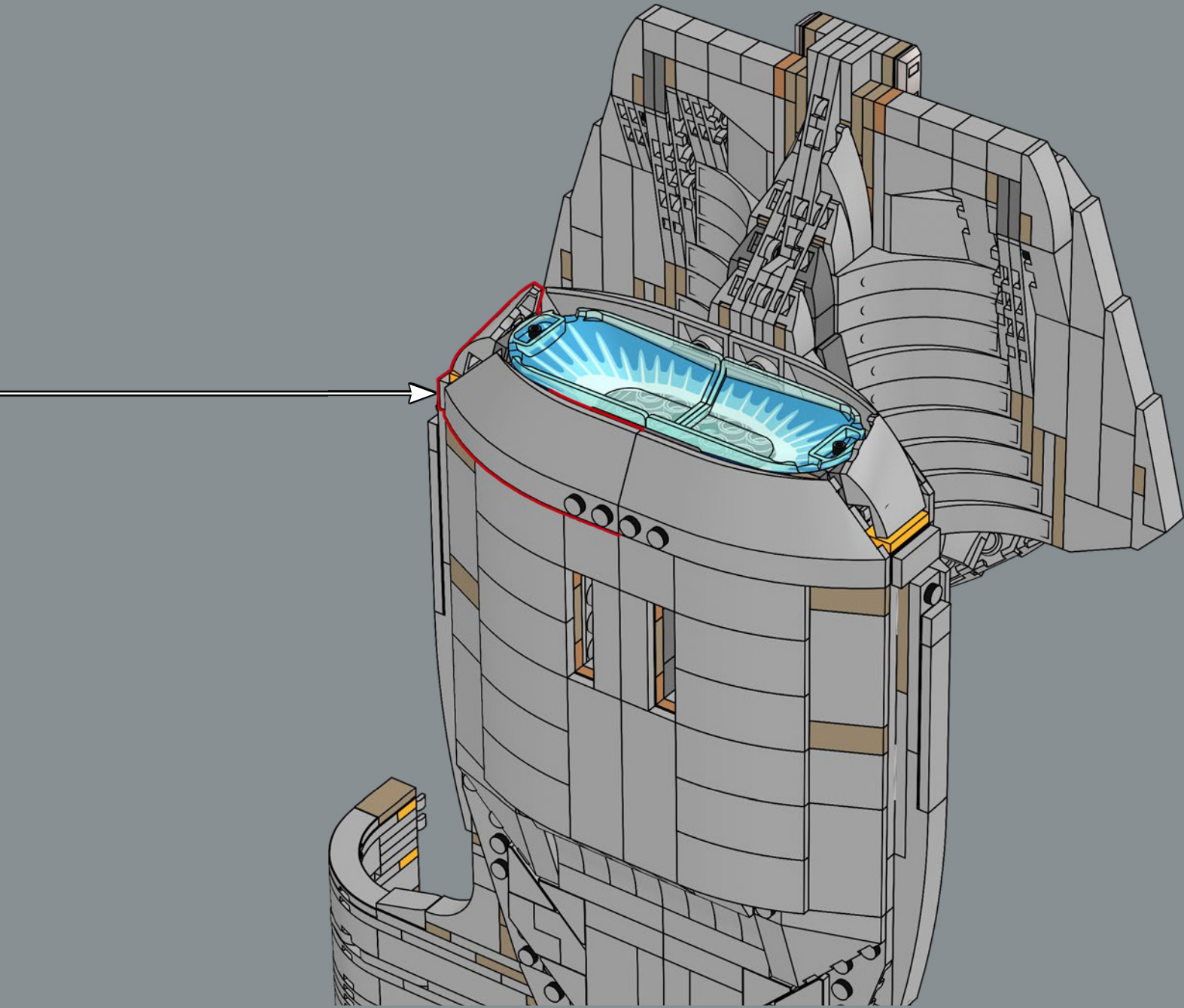

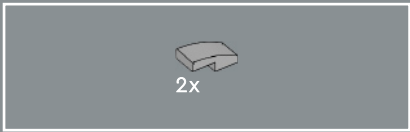

257

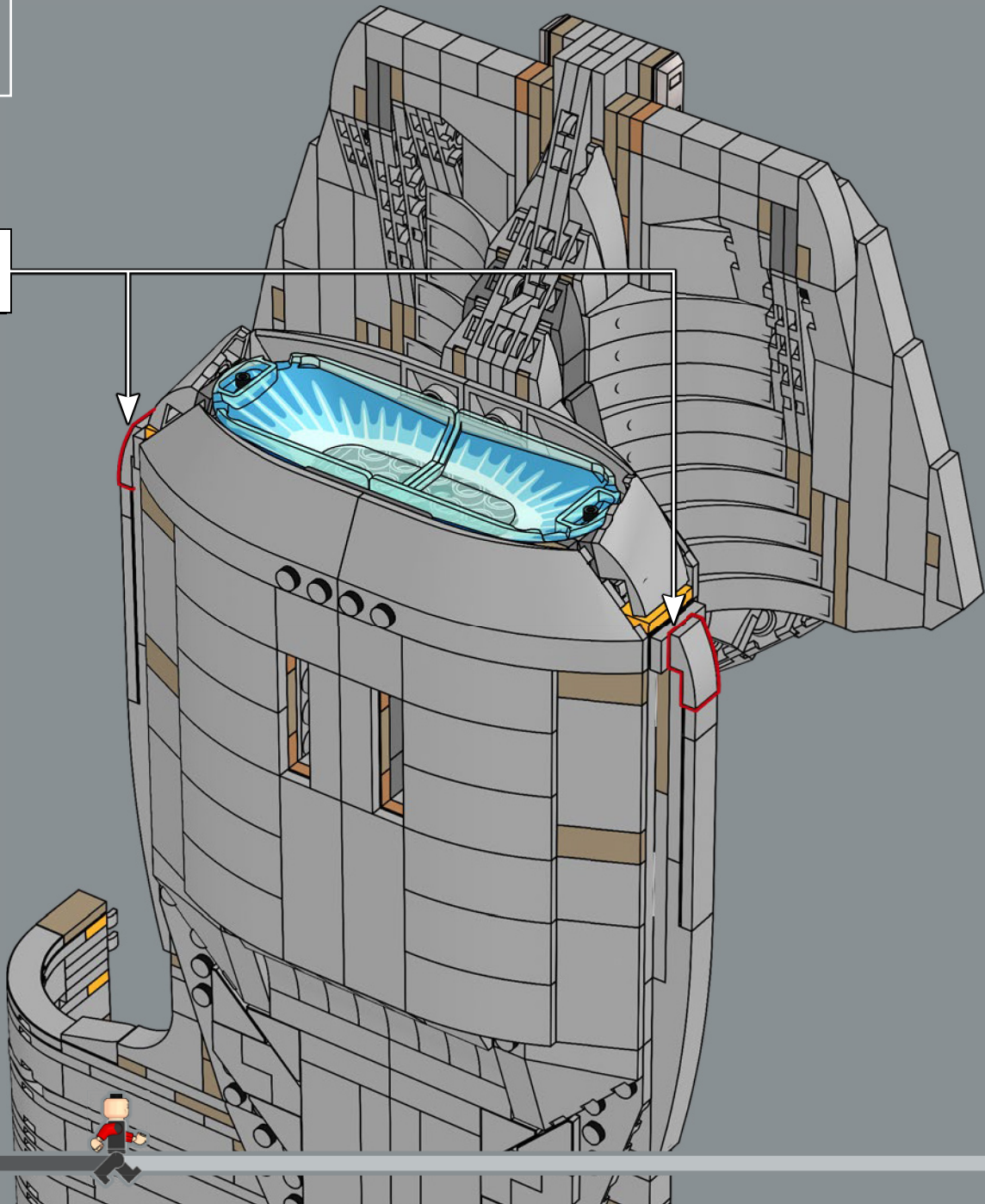
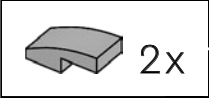

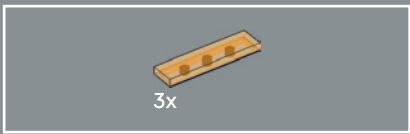

258

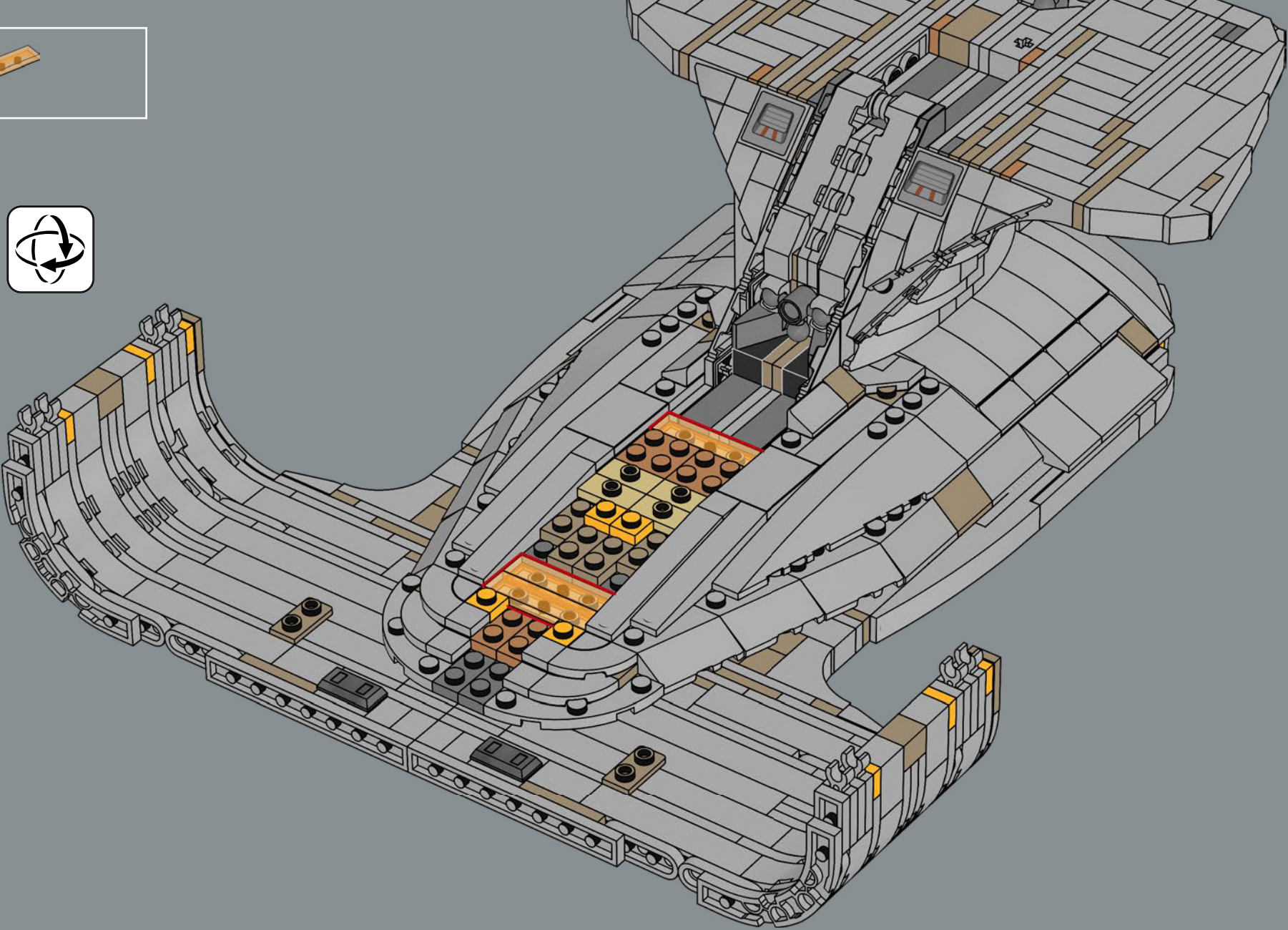

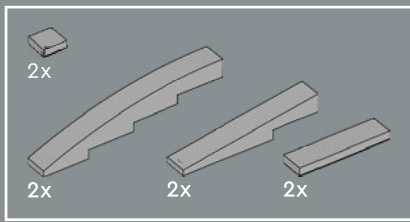

259

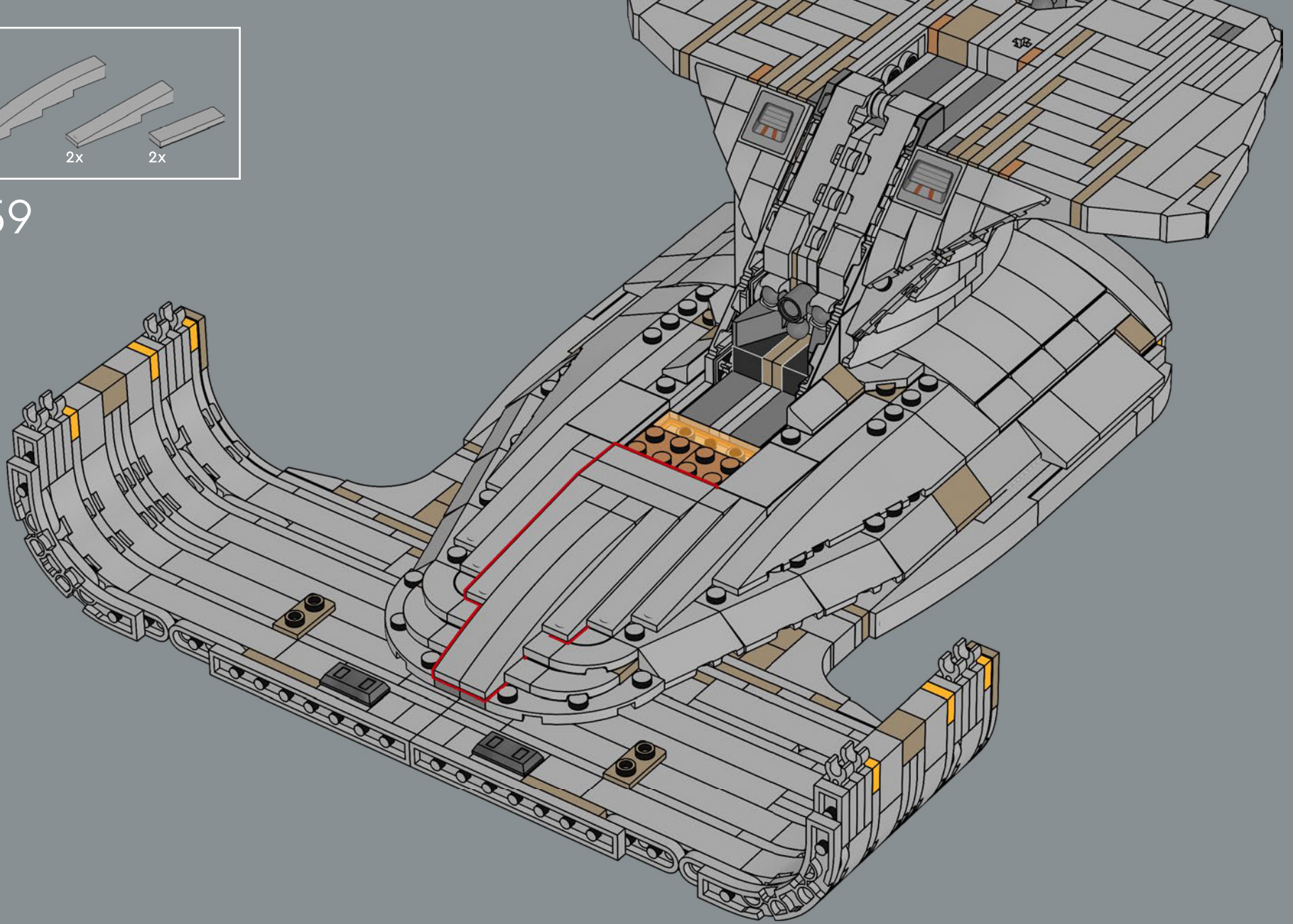

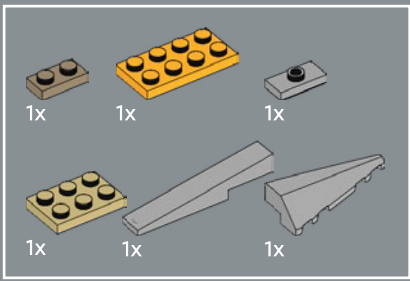

260

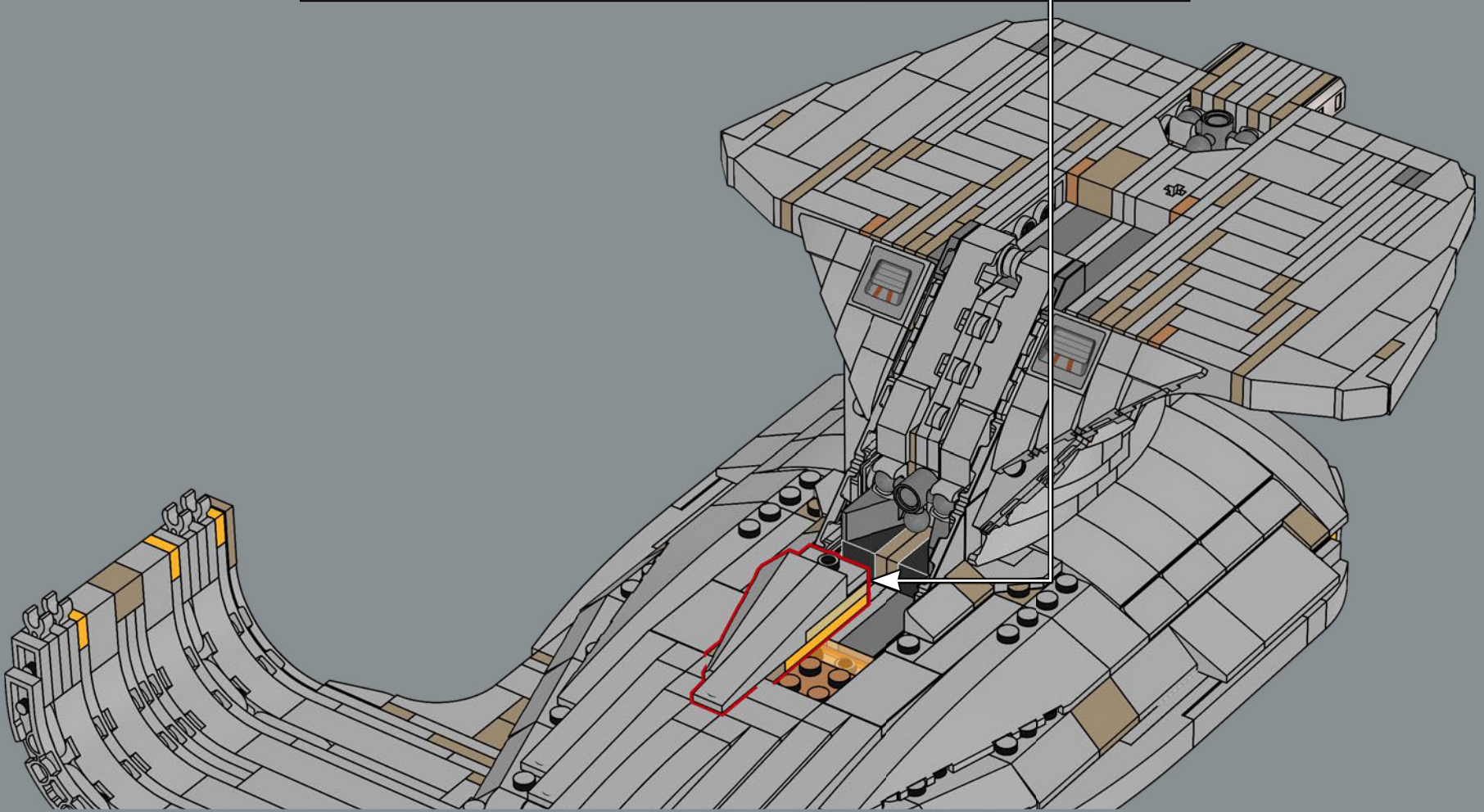
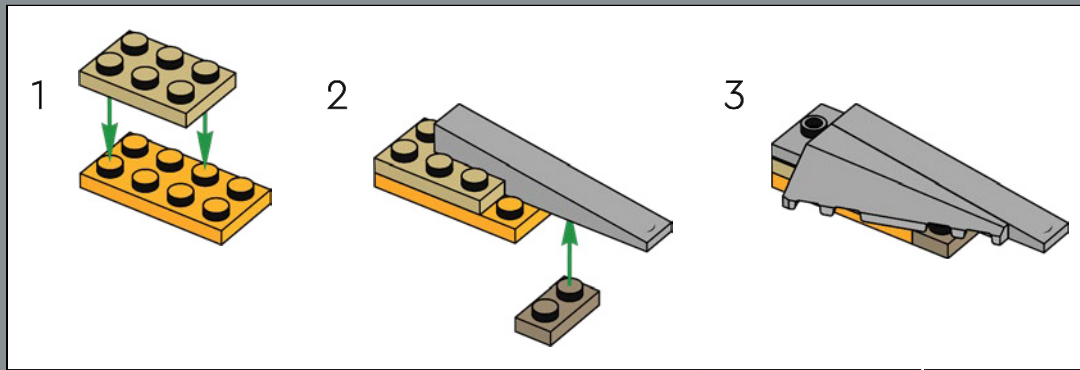

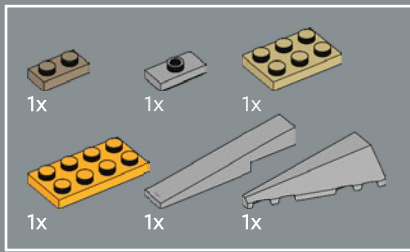

261

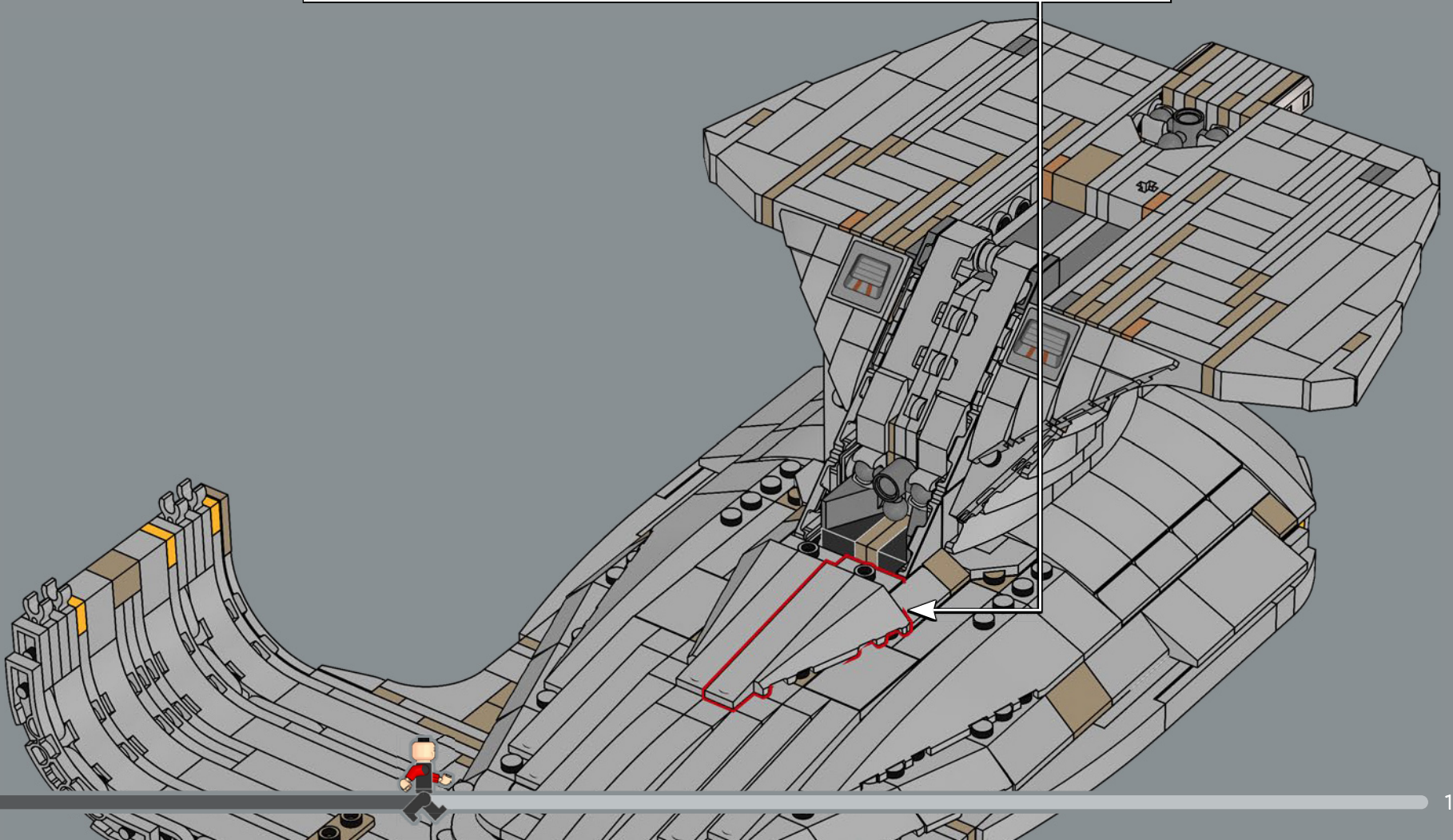
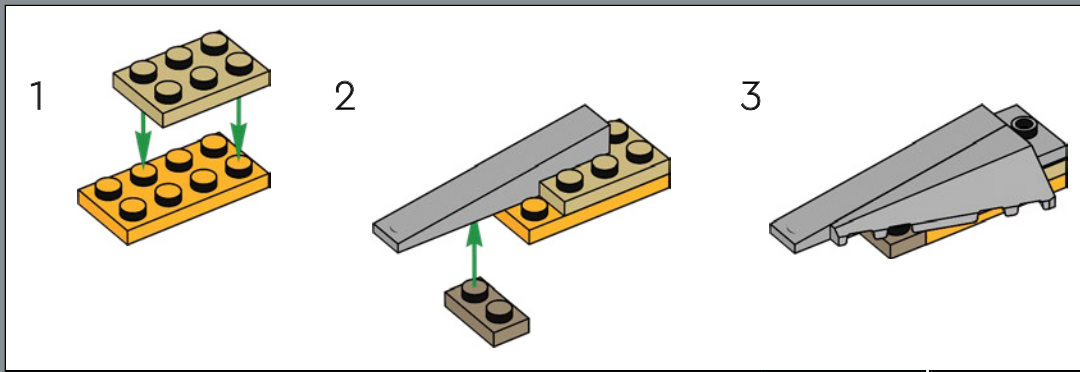

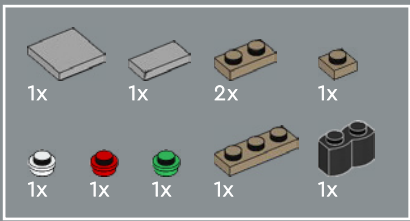

262

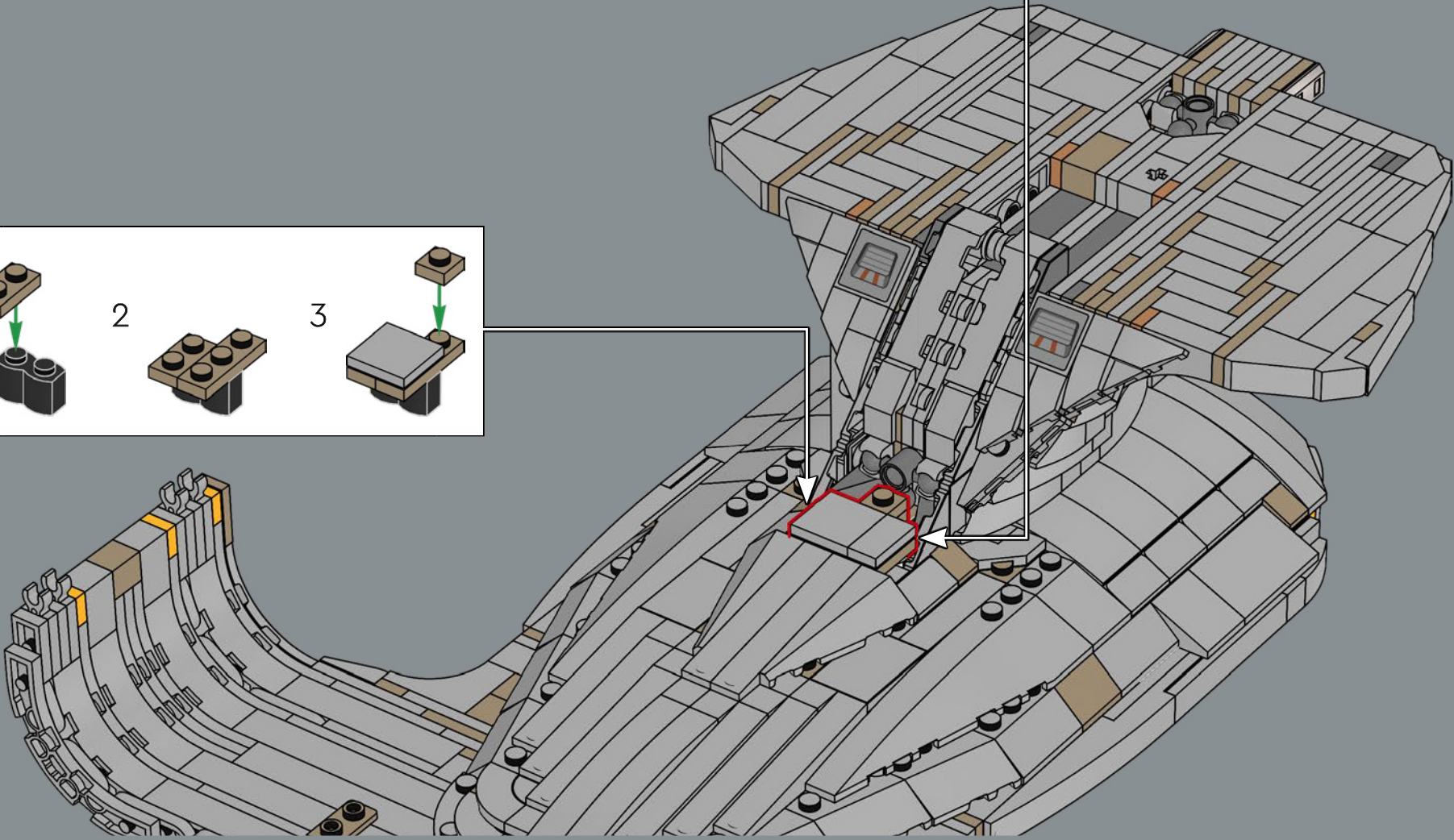
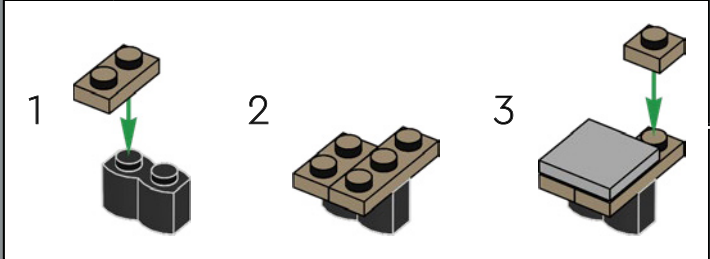
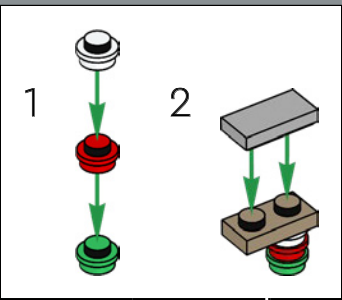

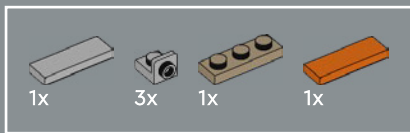

263

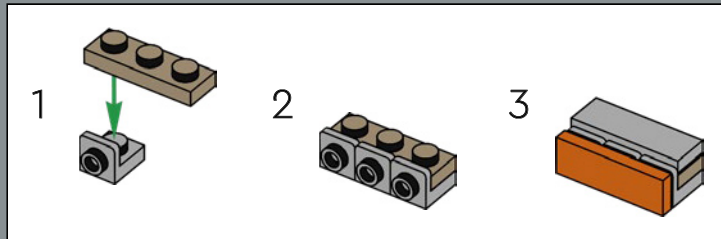
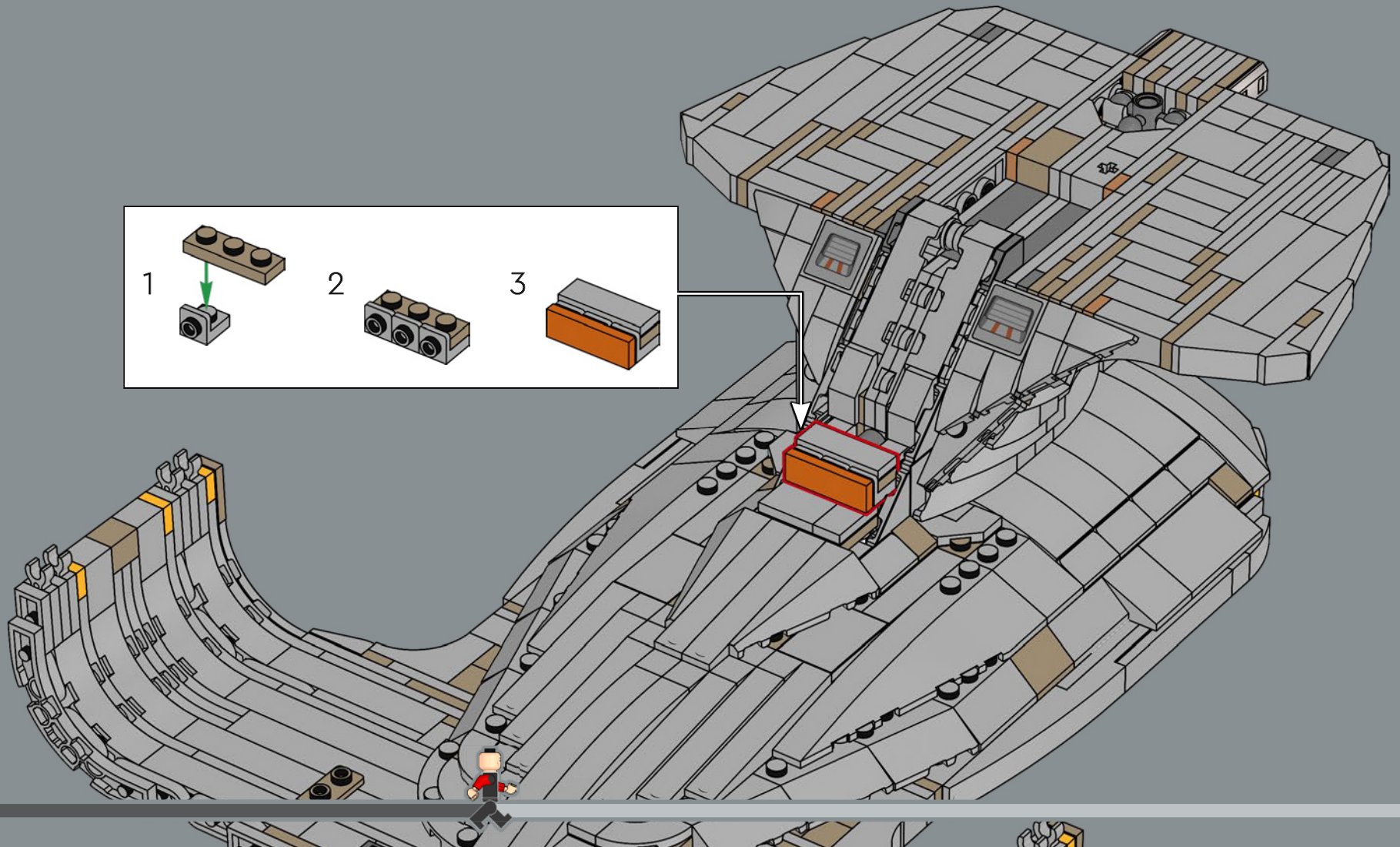

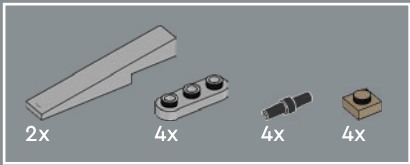

264

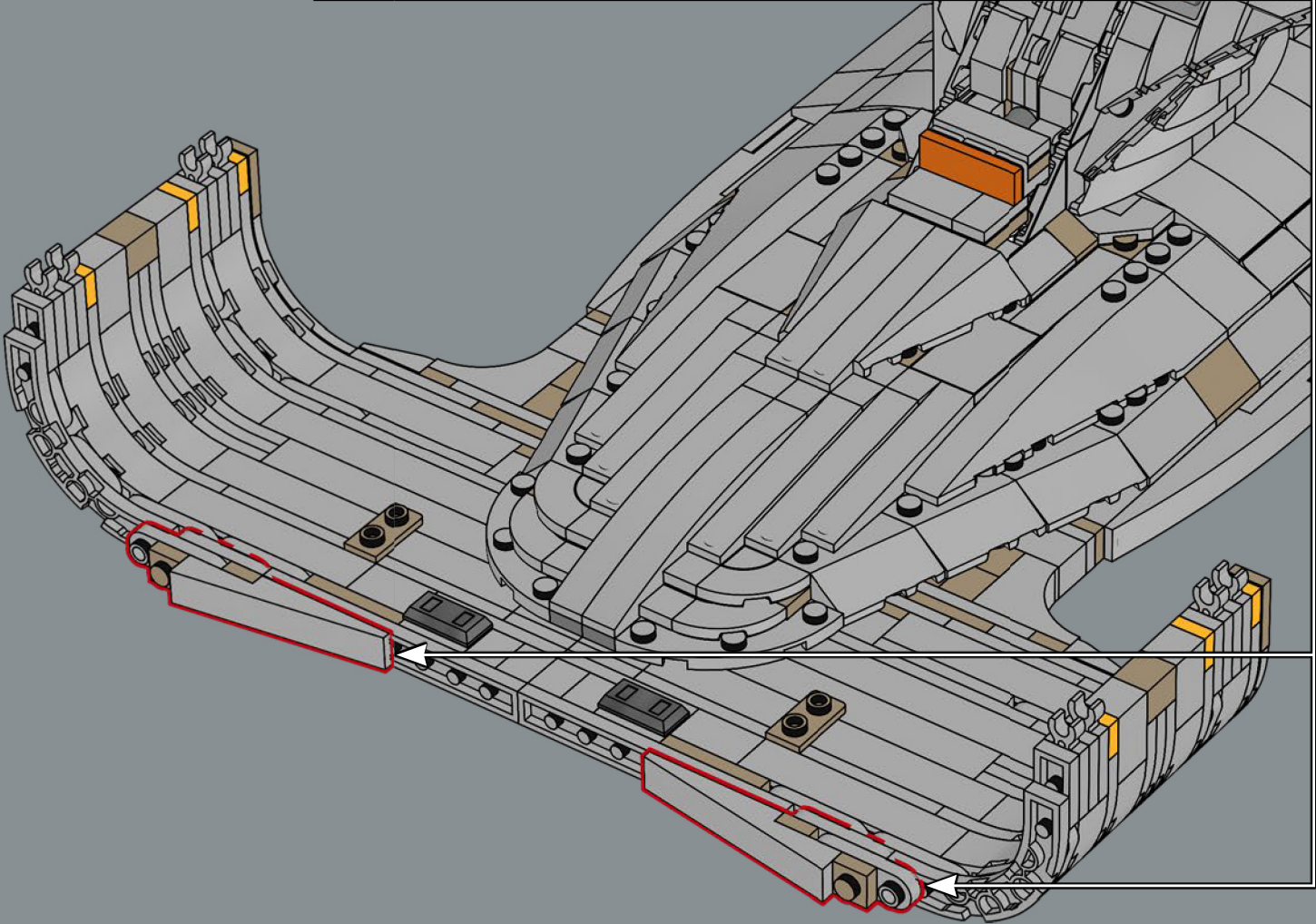
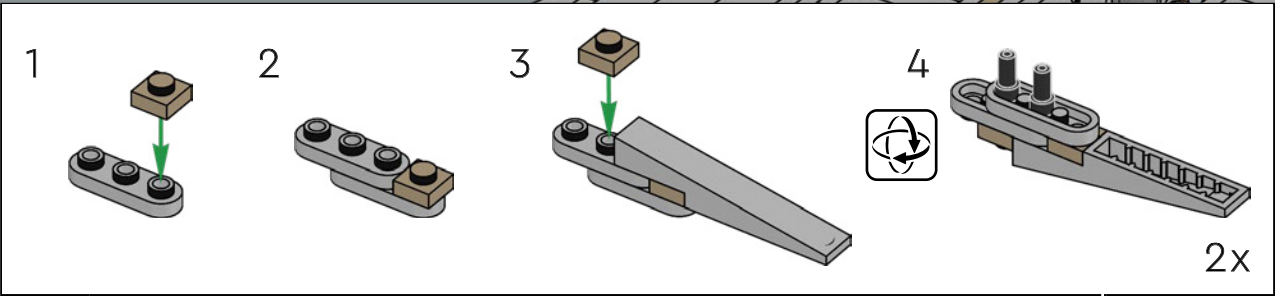

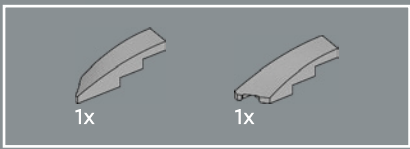

265

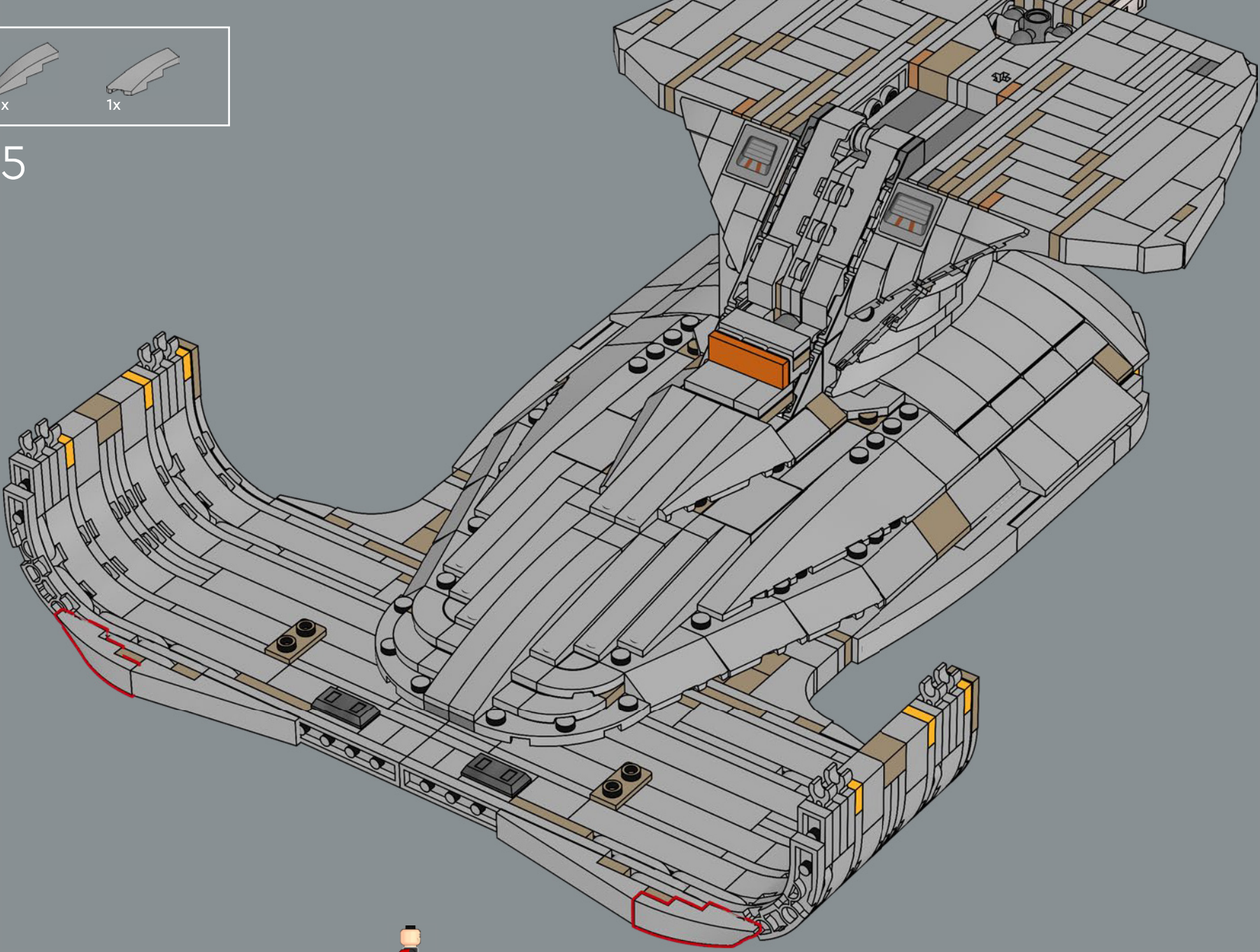

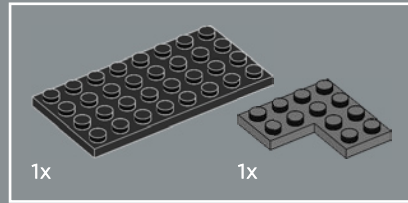
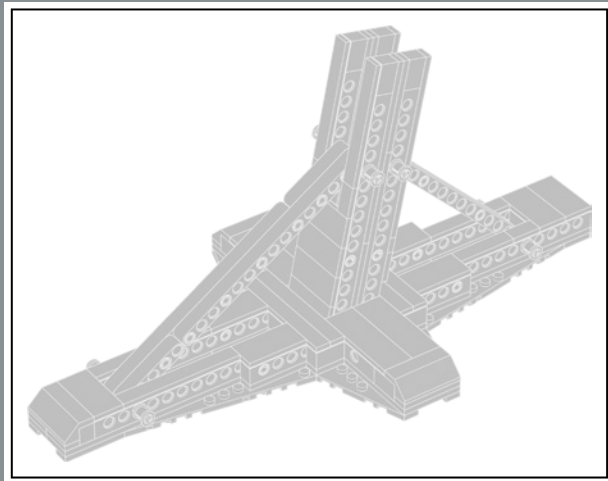
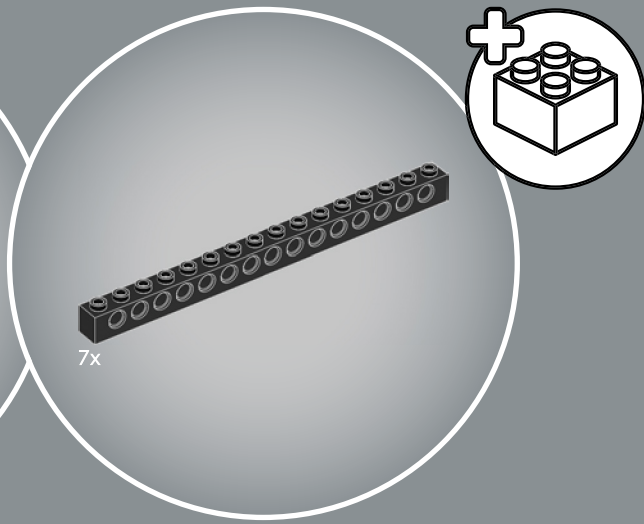

266

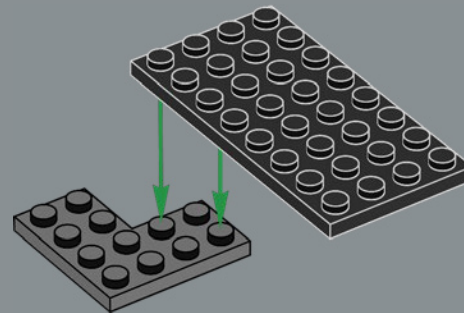

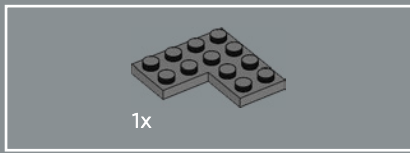

267

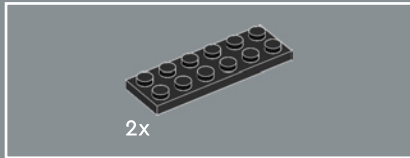
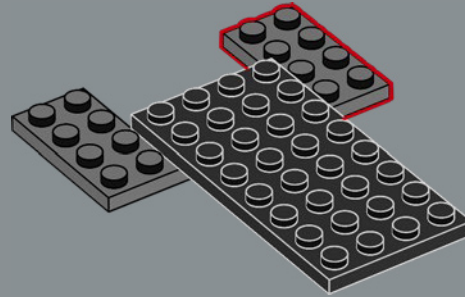

268

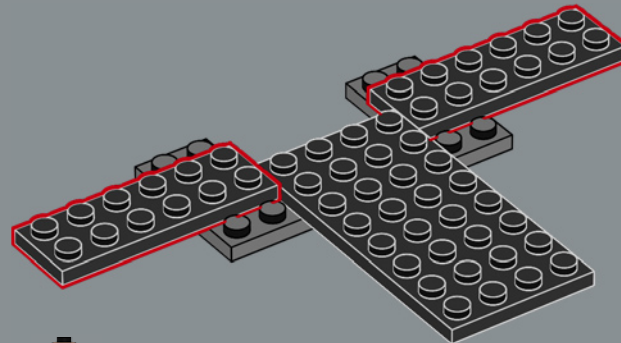

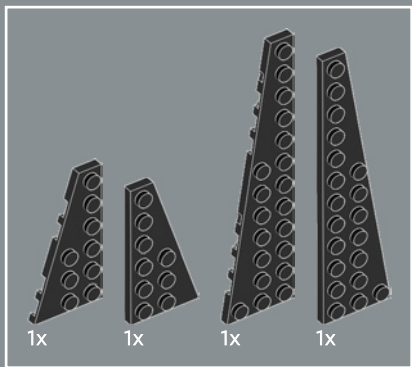

269

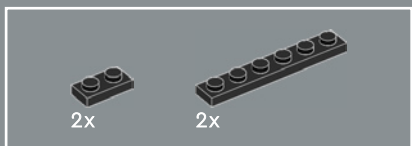
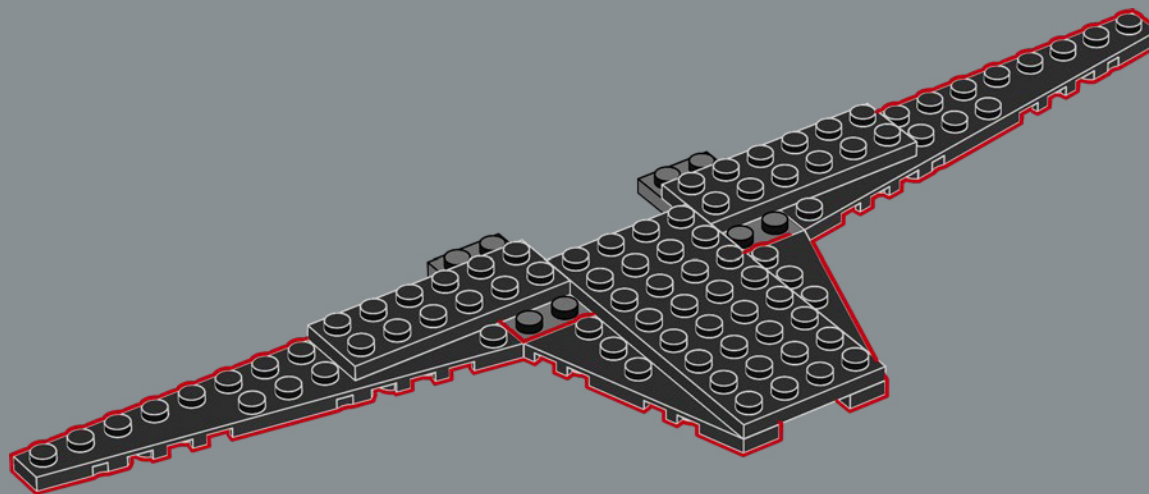

270

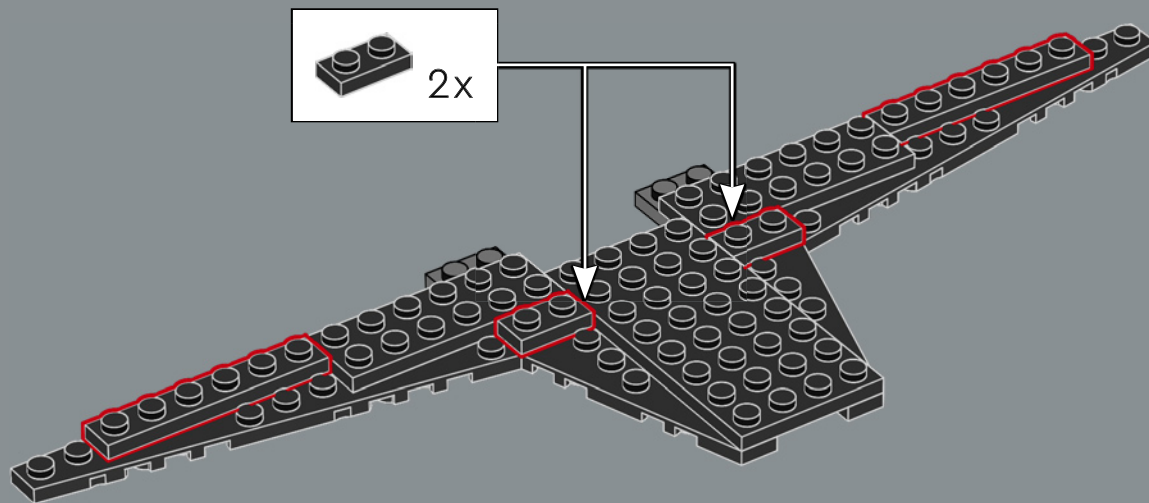

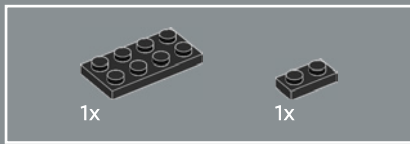

271

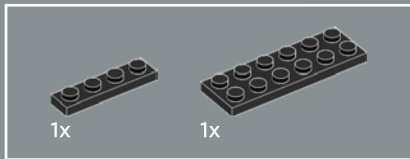
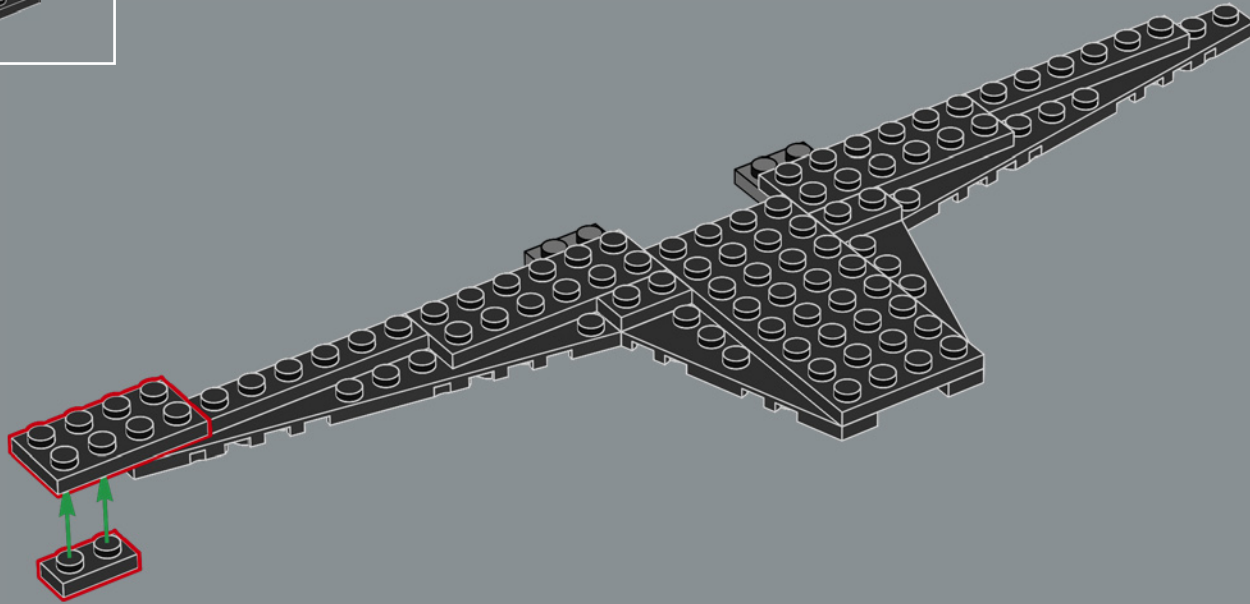

272

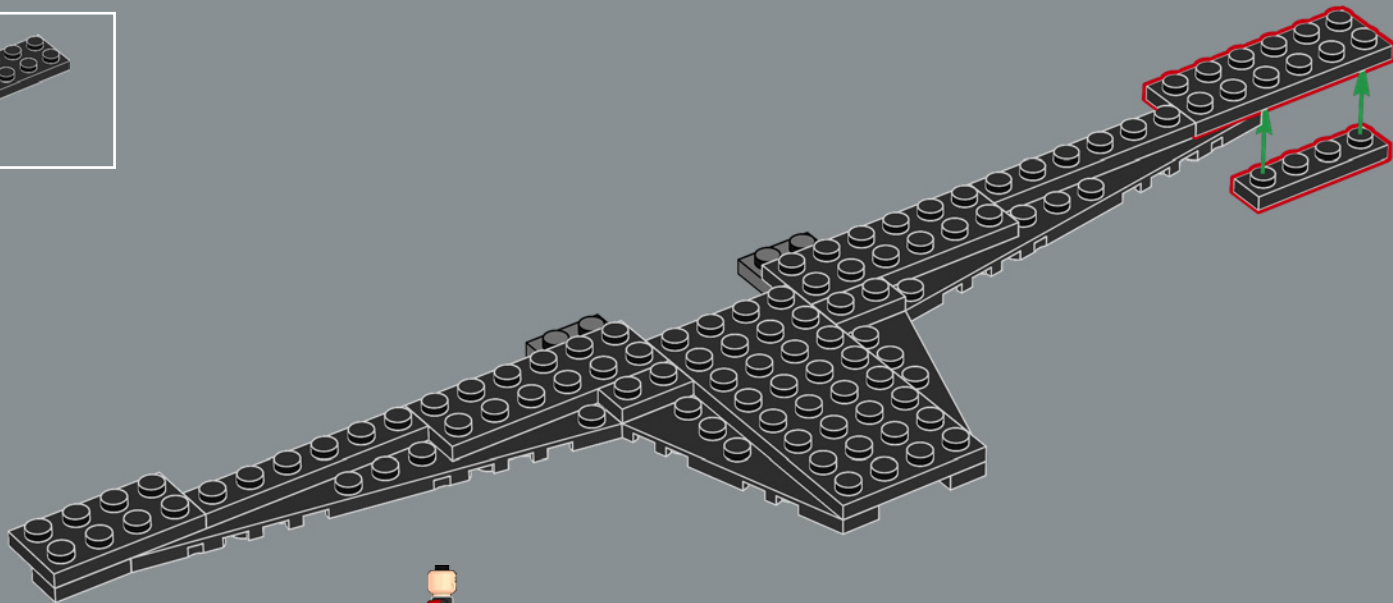

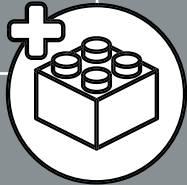
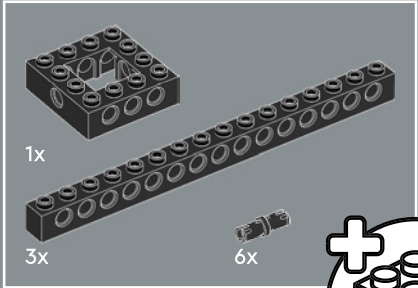
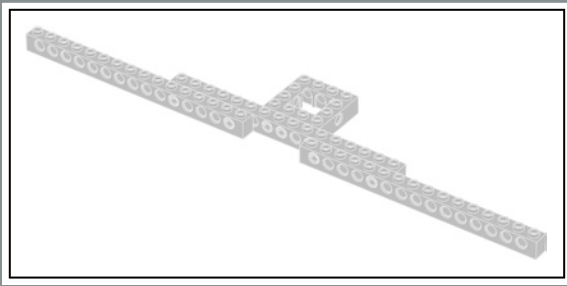

273

1

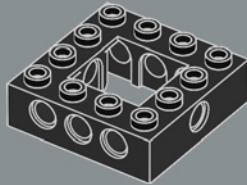

2

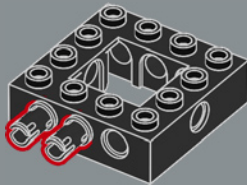

3

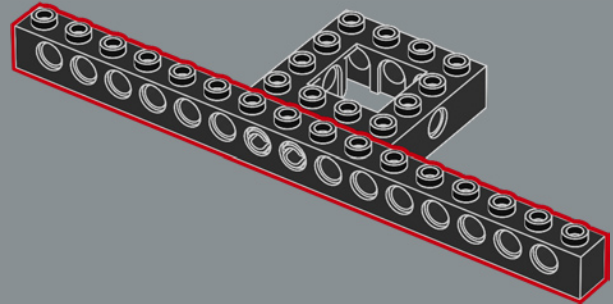

4

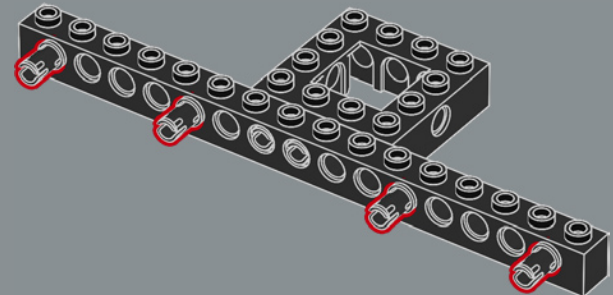

5

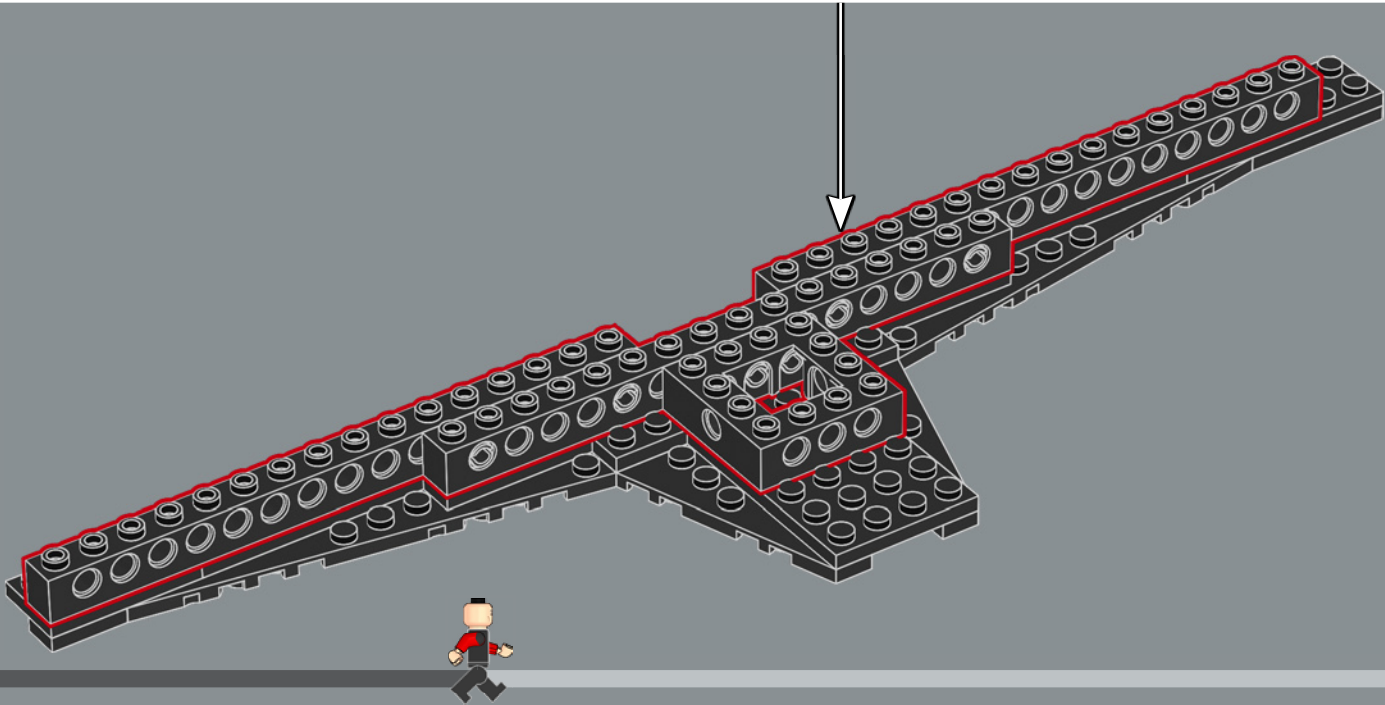
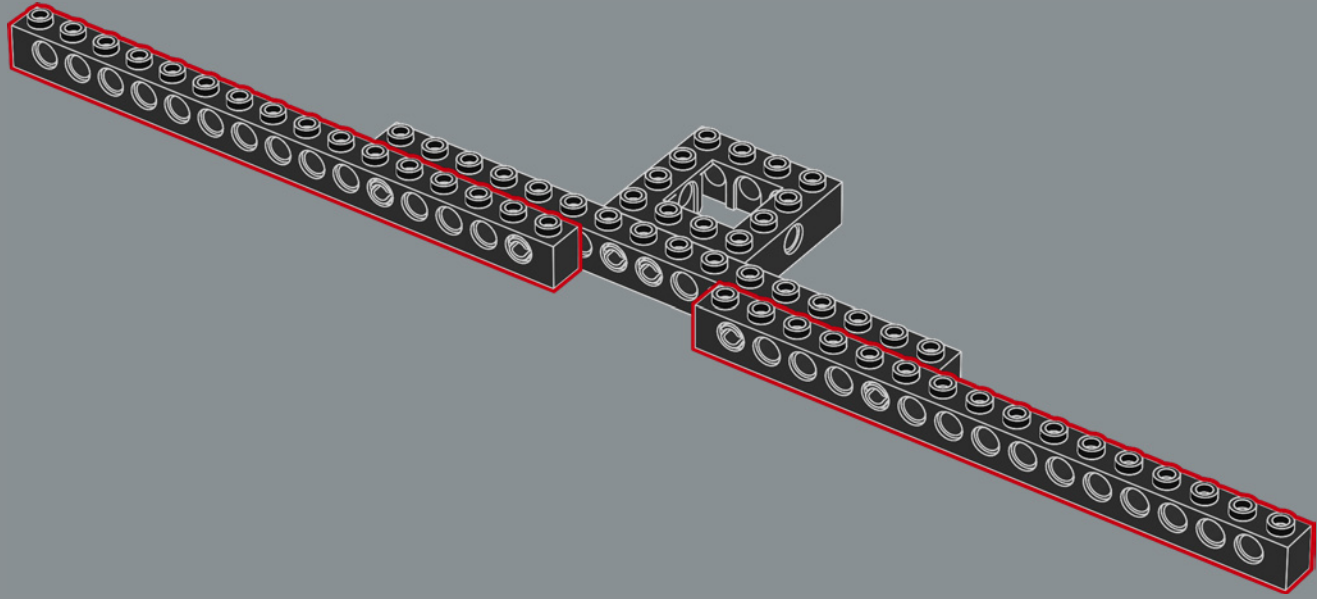

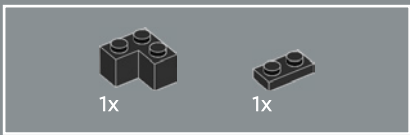

274

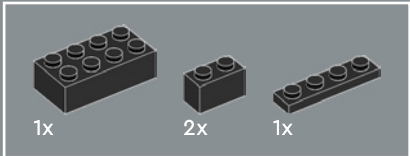
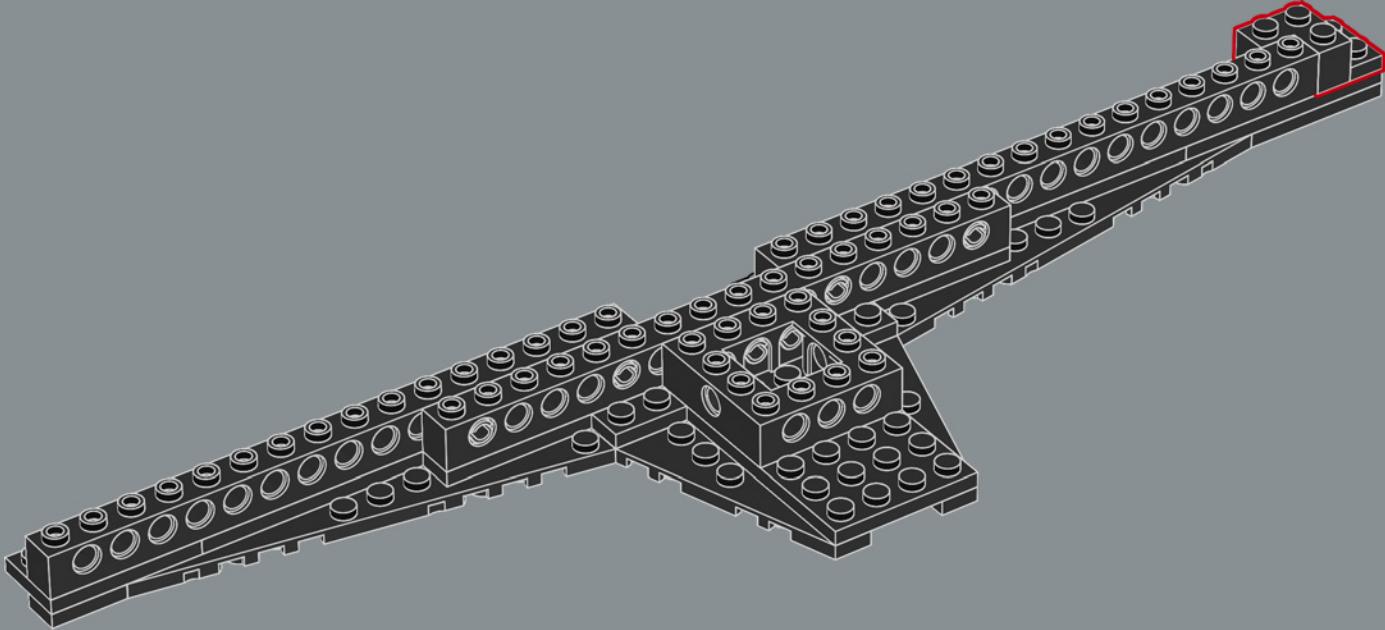

275

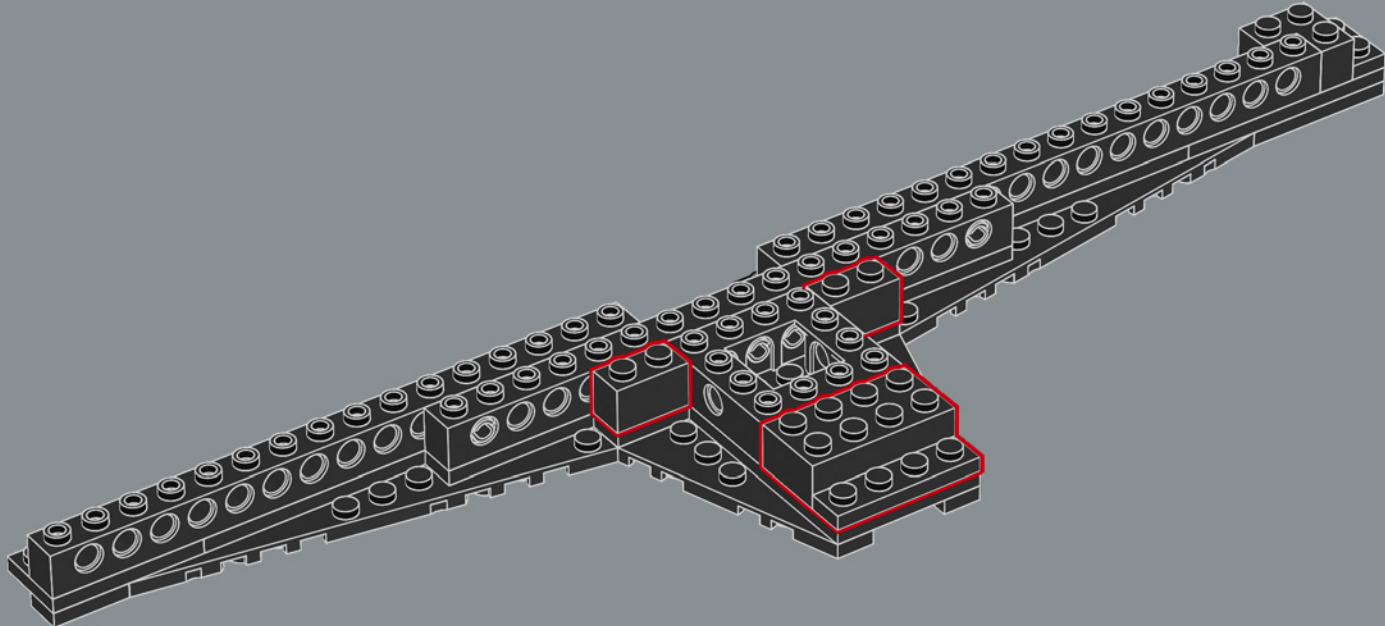

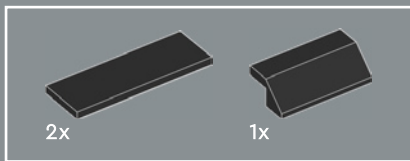

276

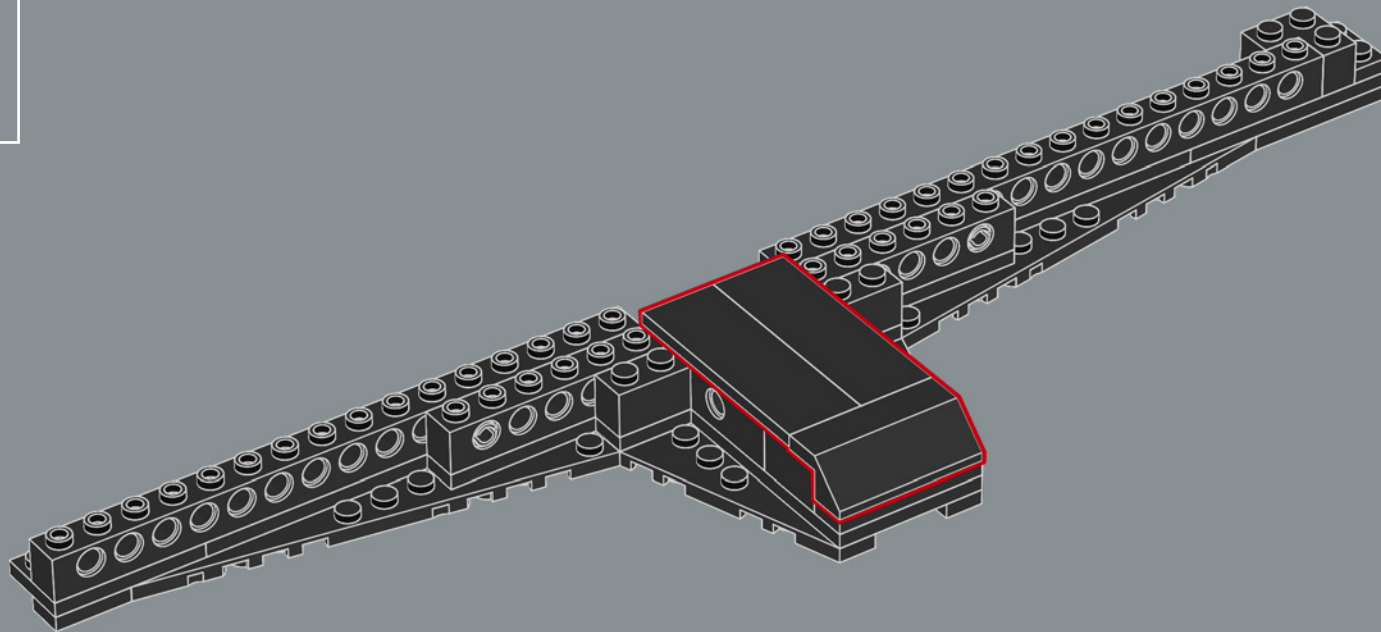

277

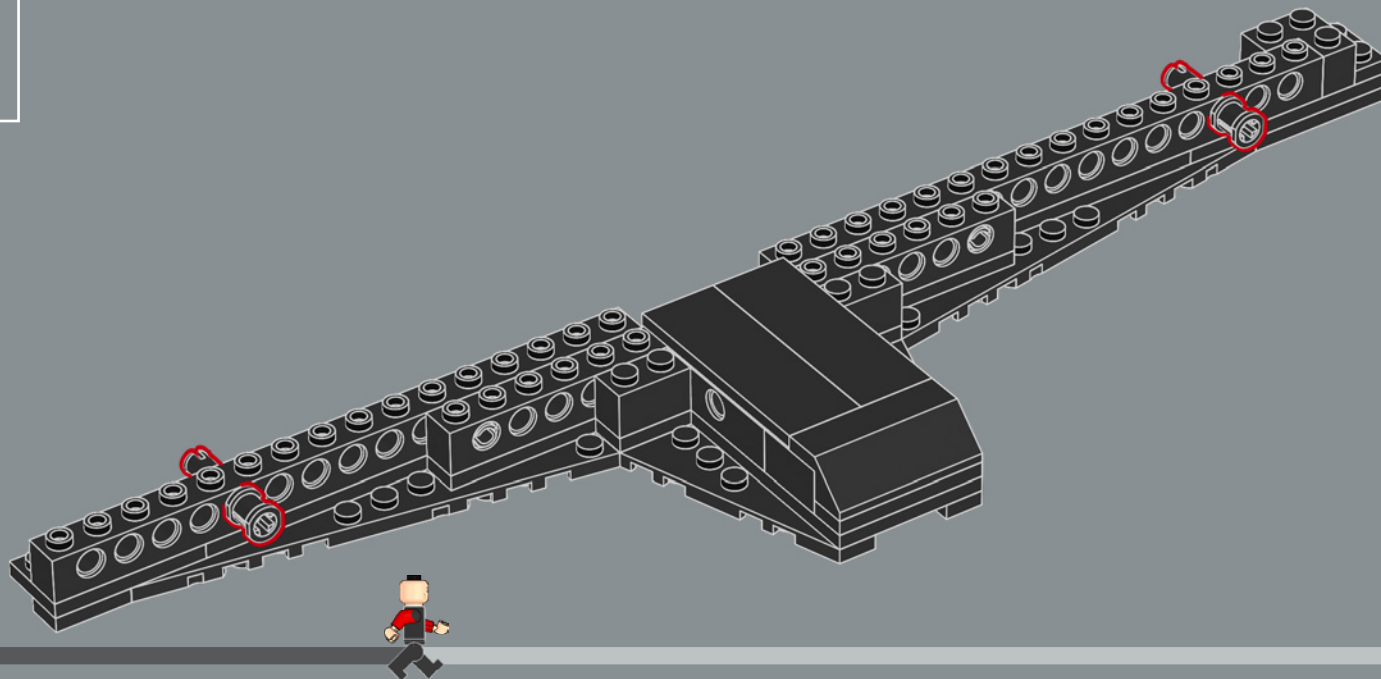

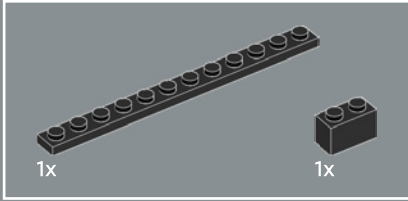
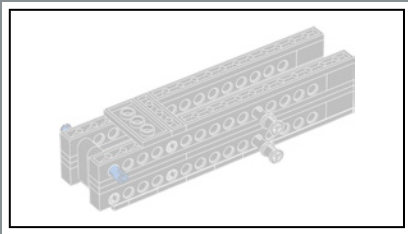

278

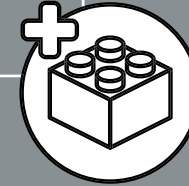
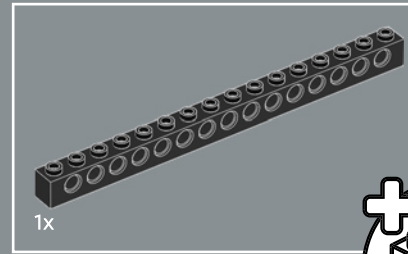
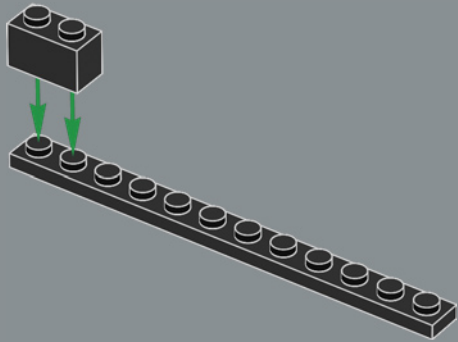

279

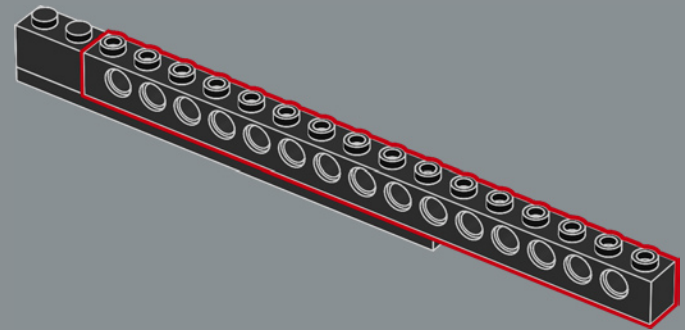

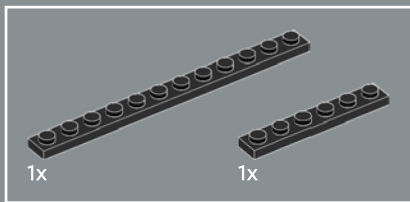

280

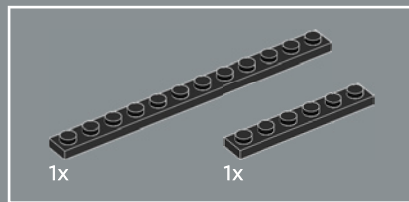
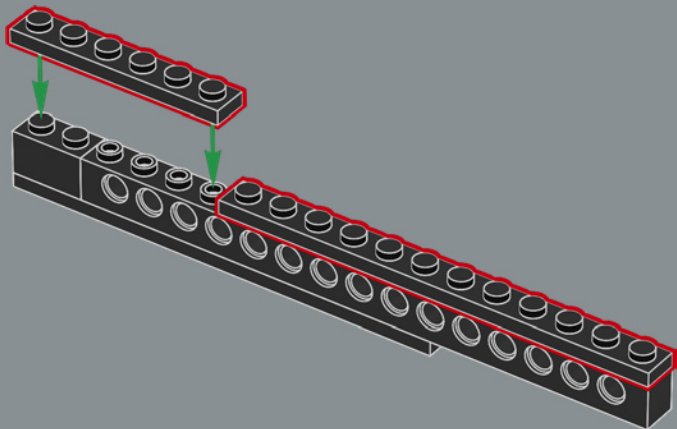

281

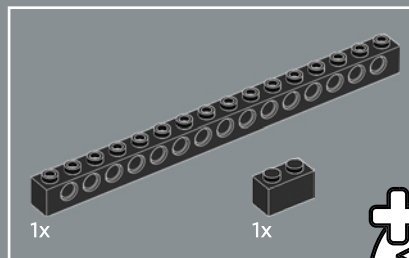
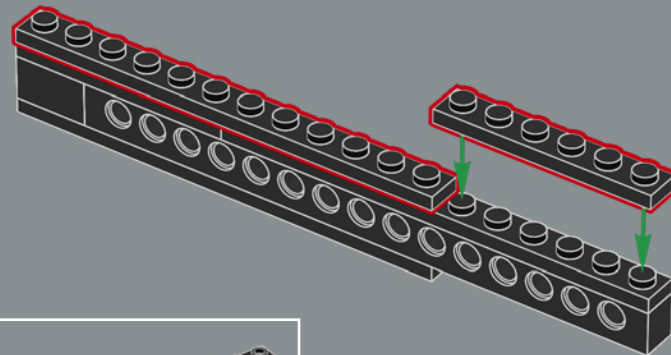

282

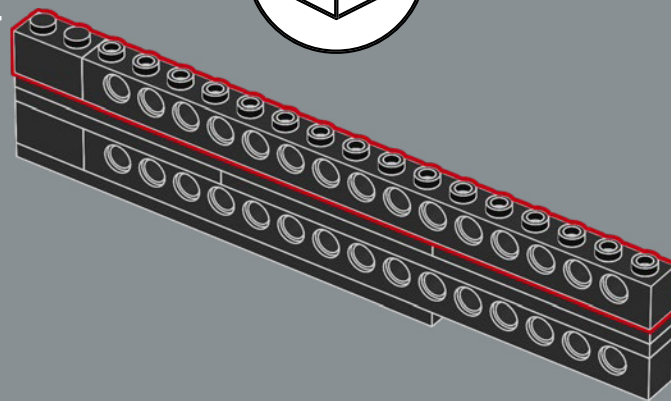
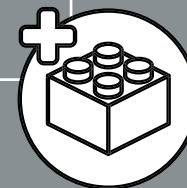



283

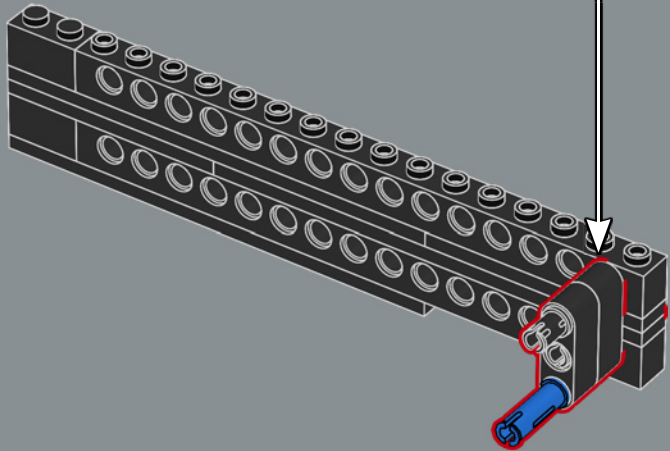
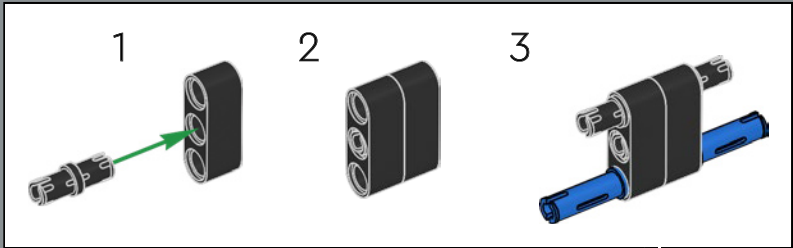

284

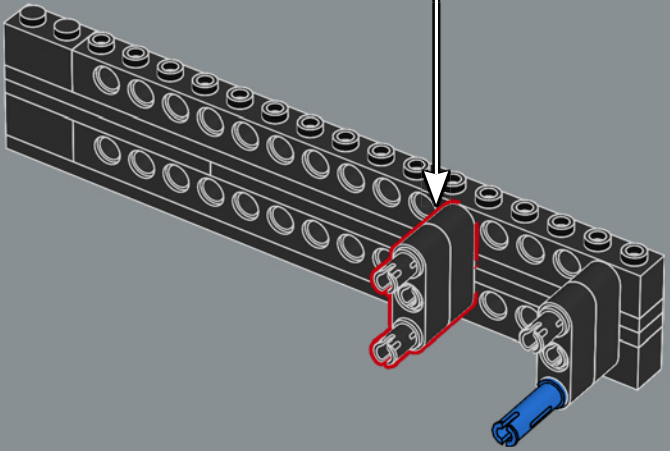
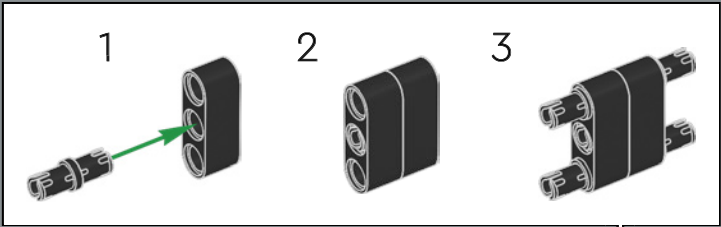

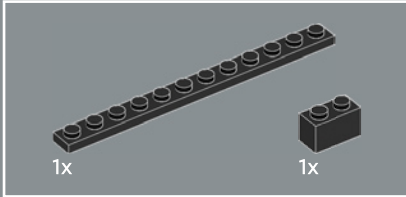
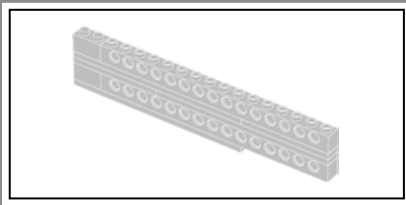

285

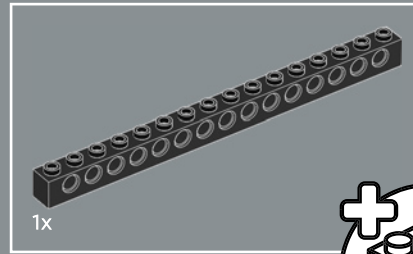
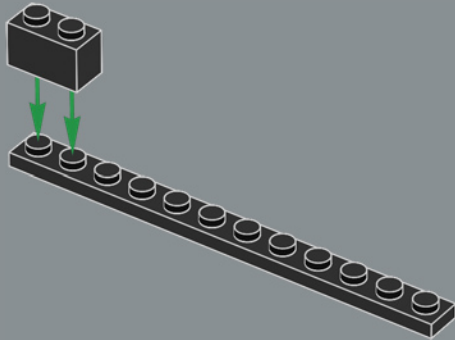

286

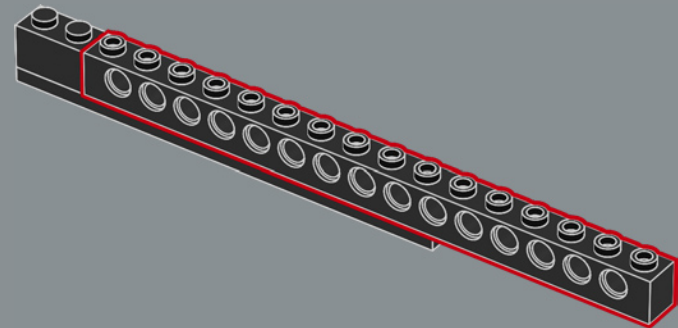
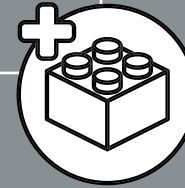

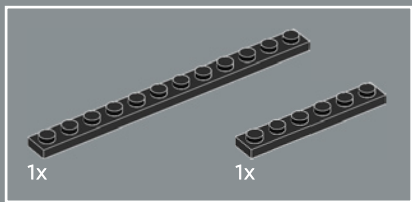

287

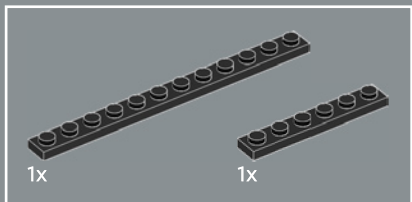
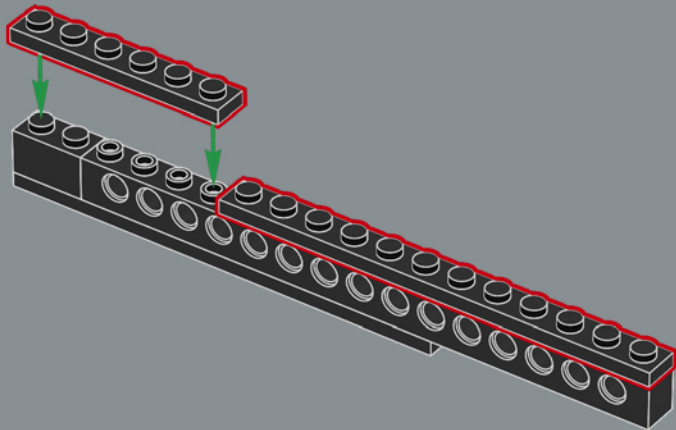

288

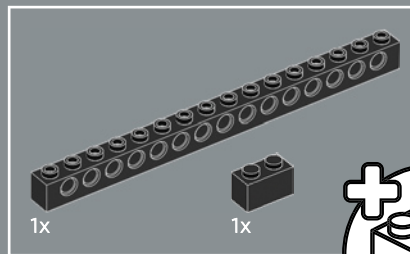
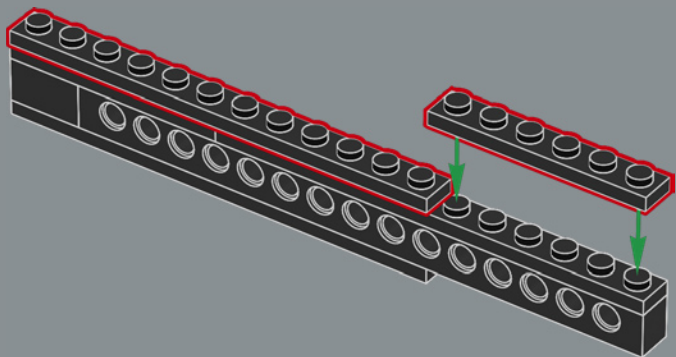

289

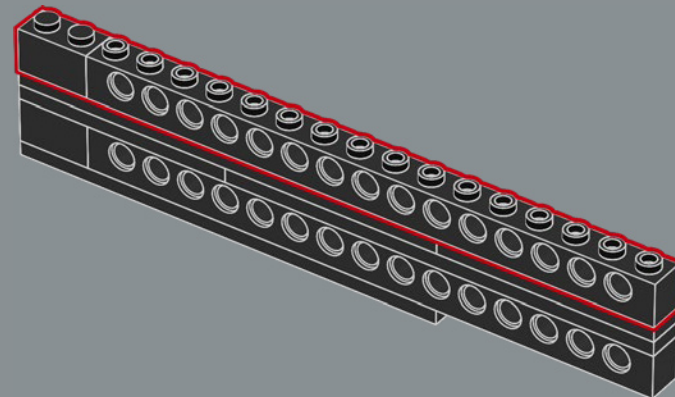
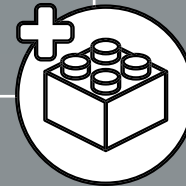

290

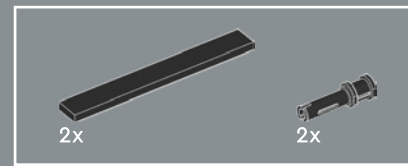
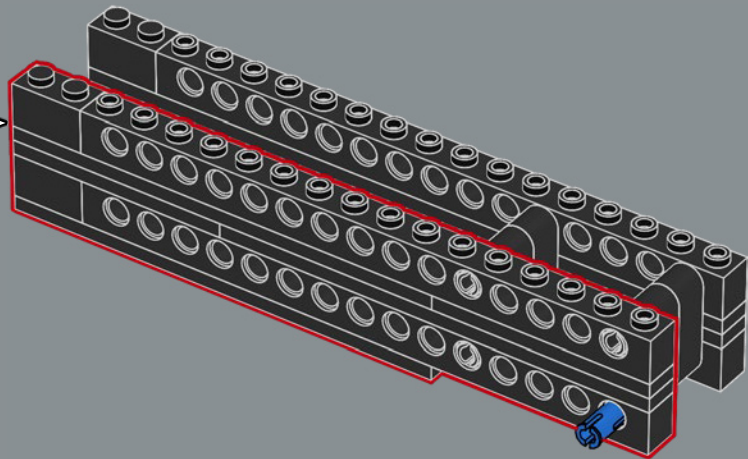

291

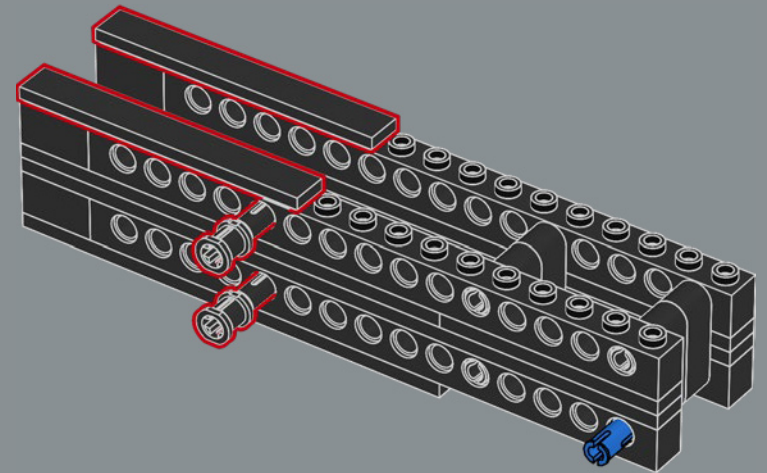

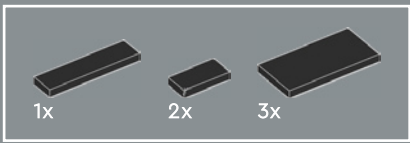

292

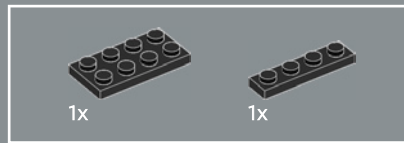
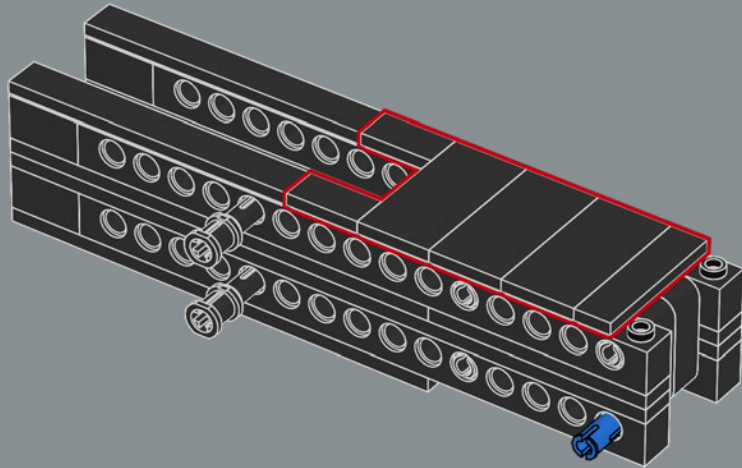

293

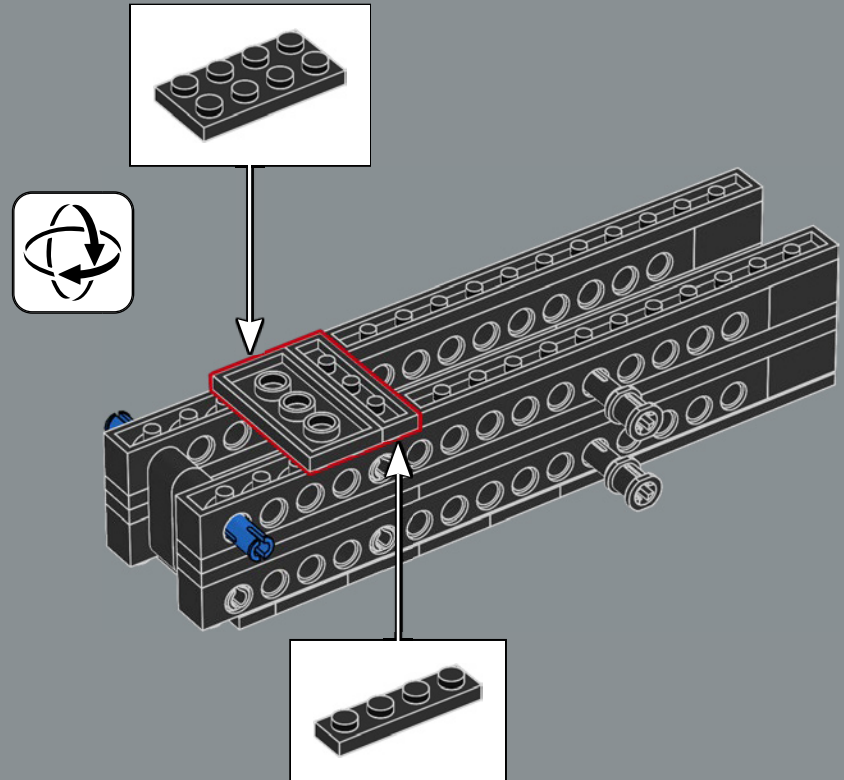

294

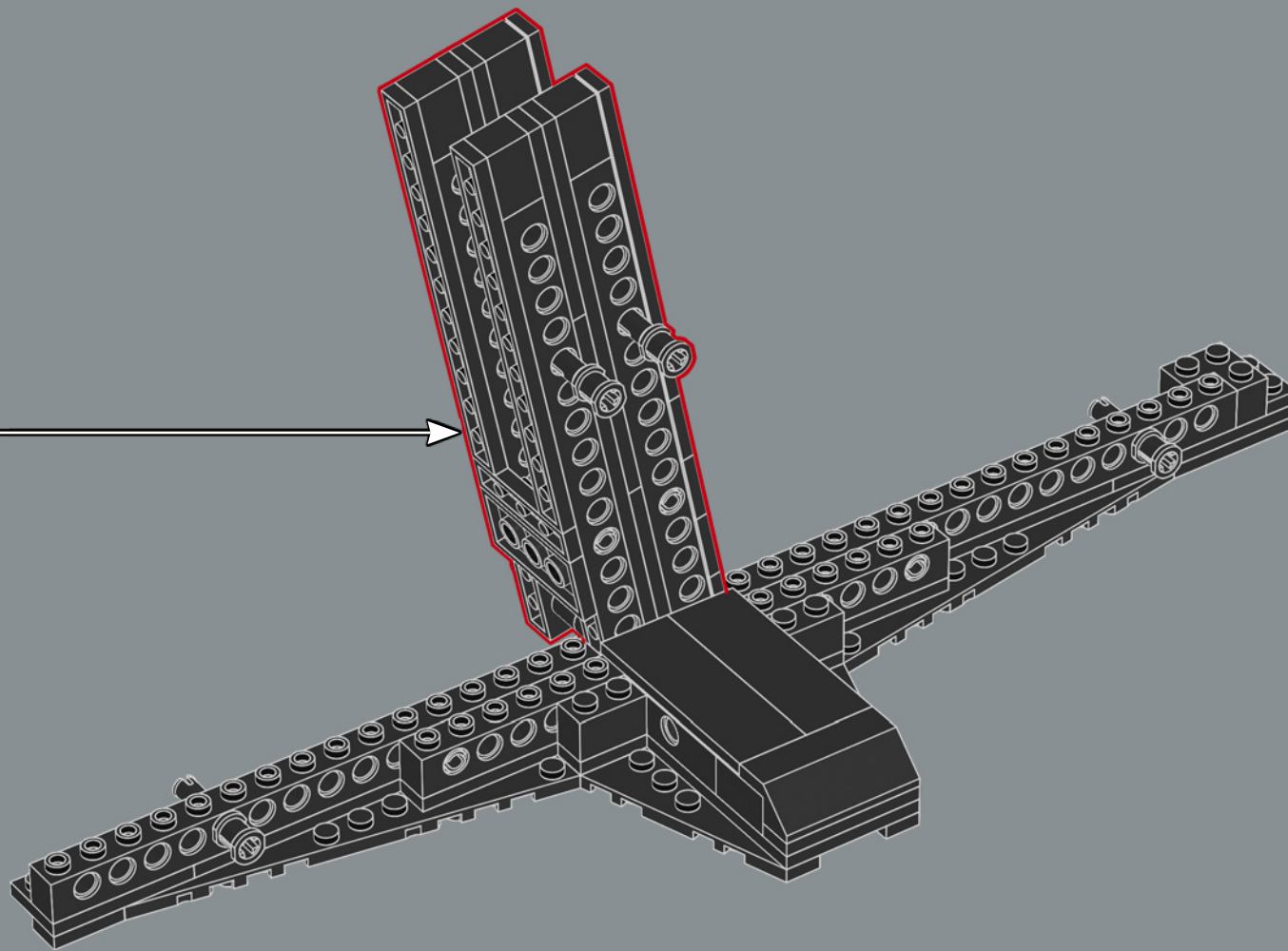

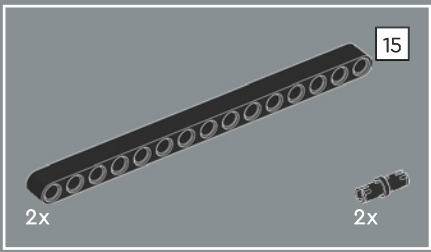

295

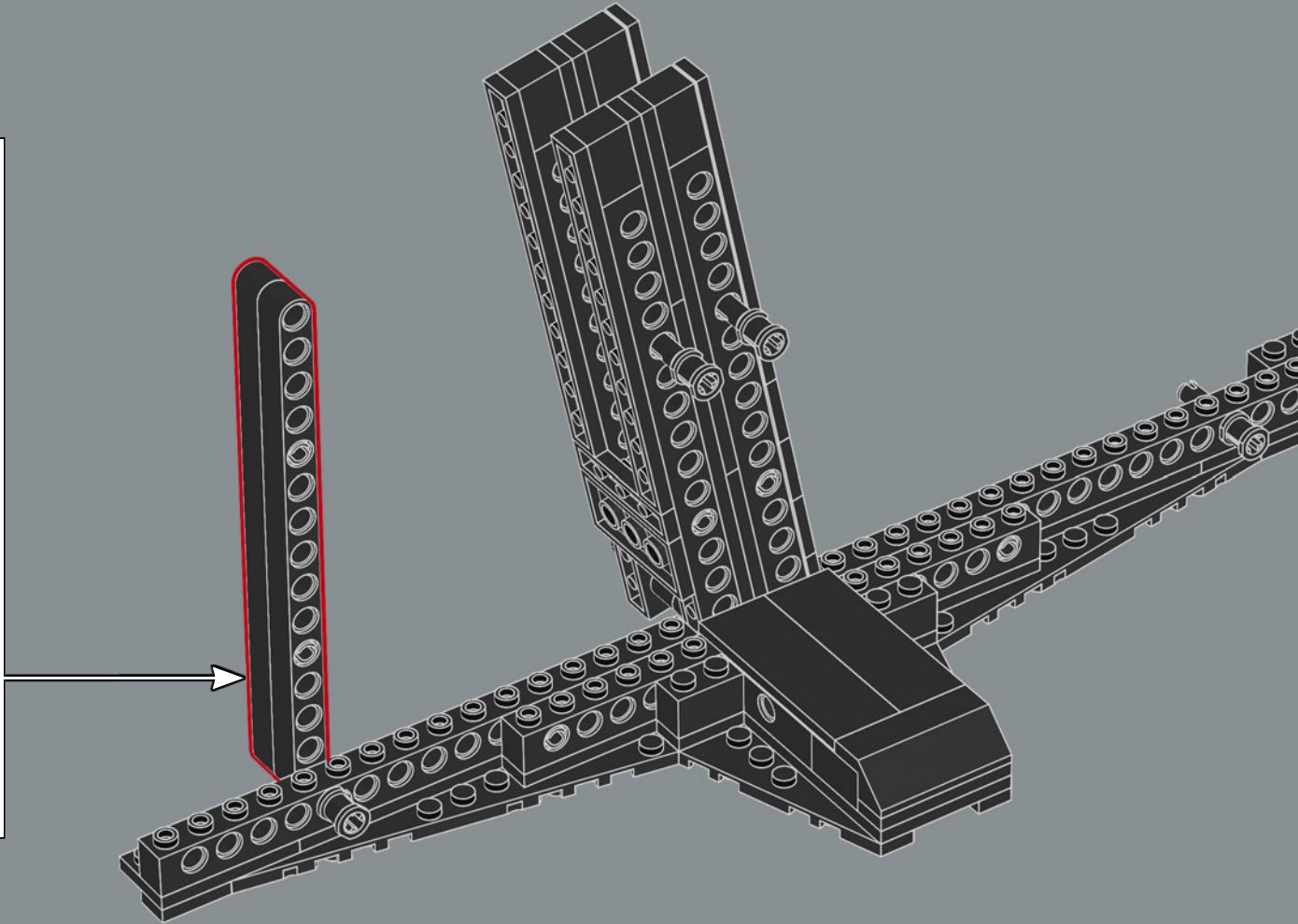
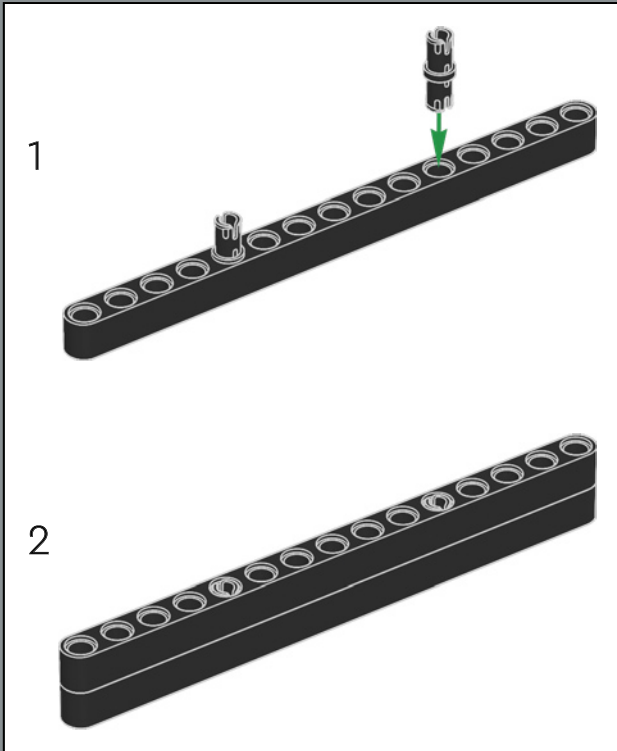

296

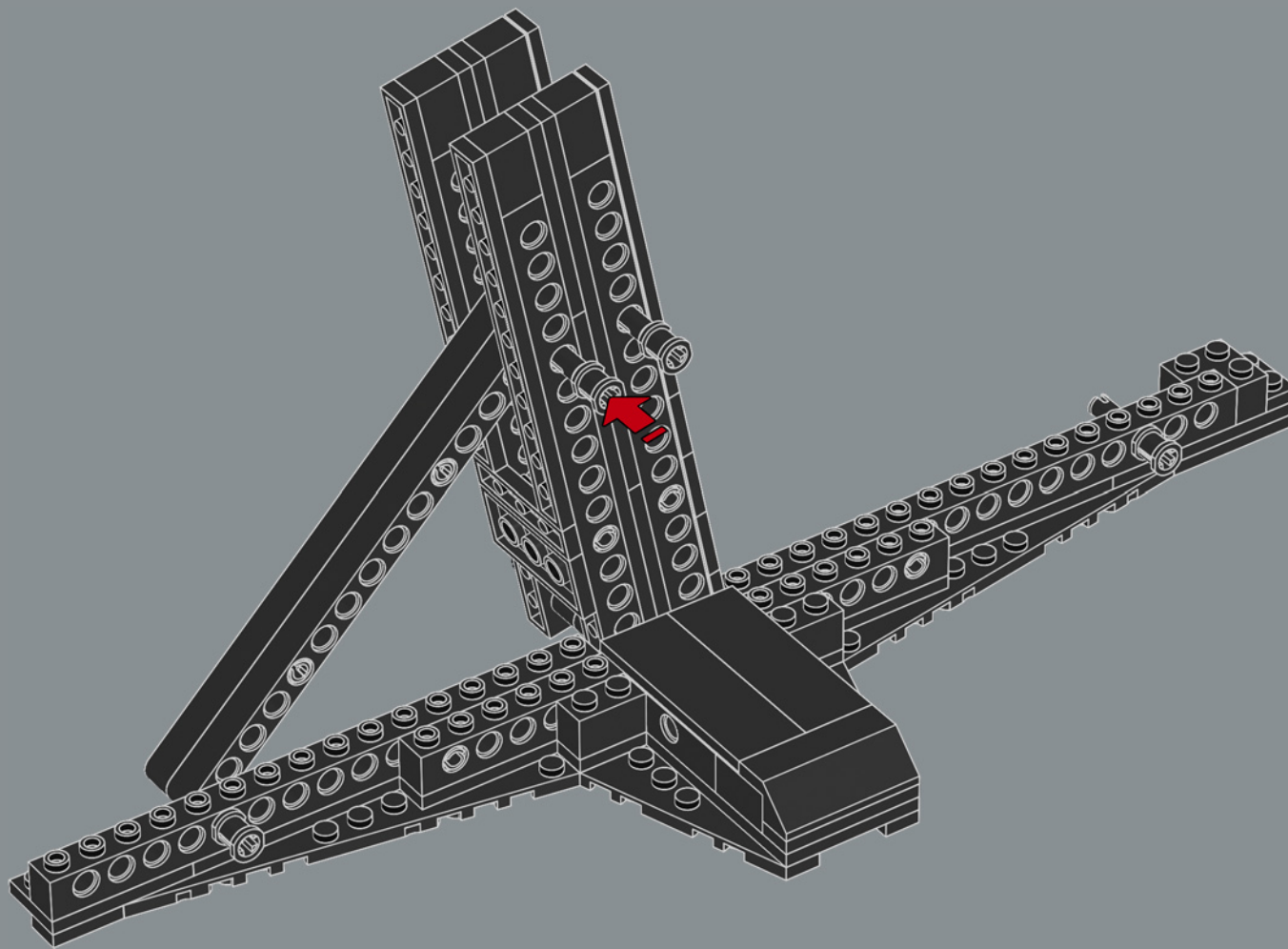

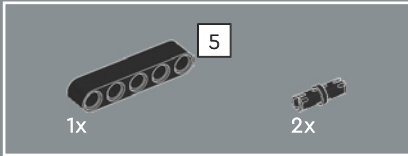
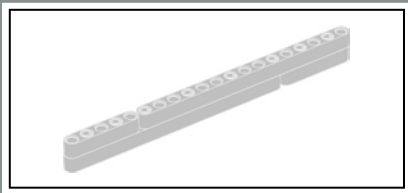

297

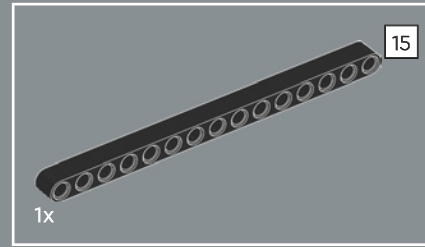
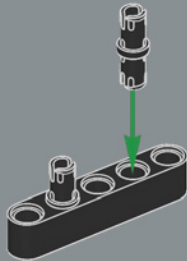

298

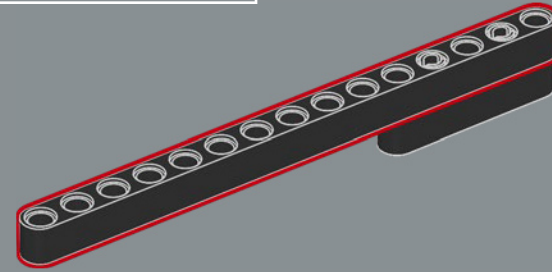

299

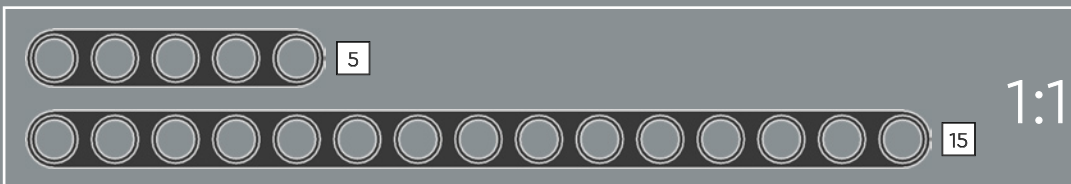
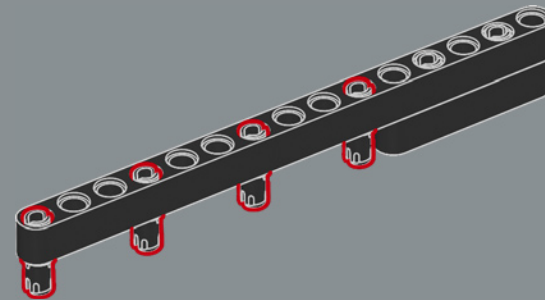

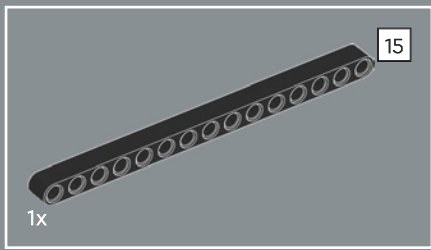

300

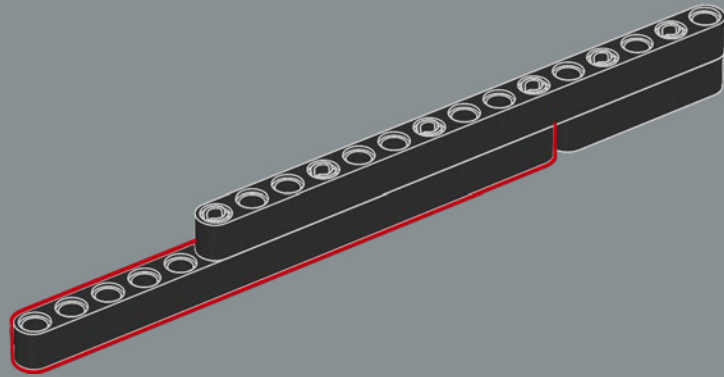

301

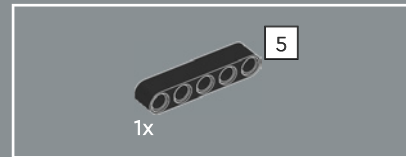
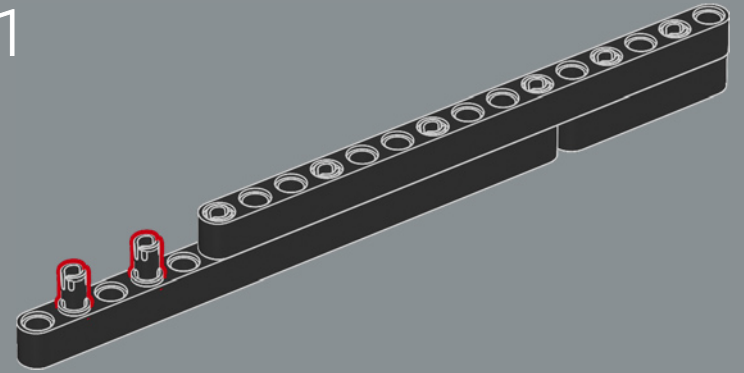

302

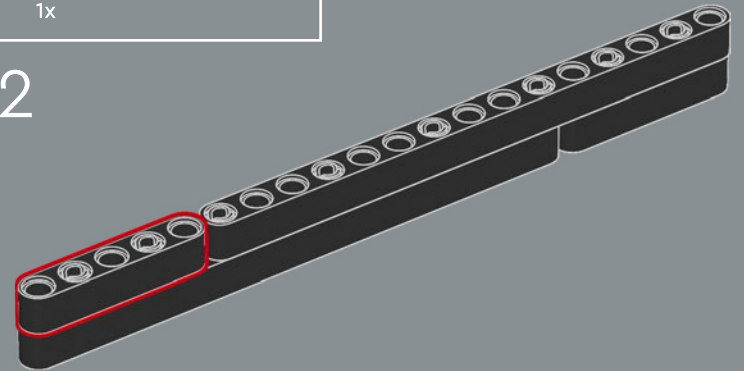

303

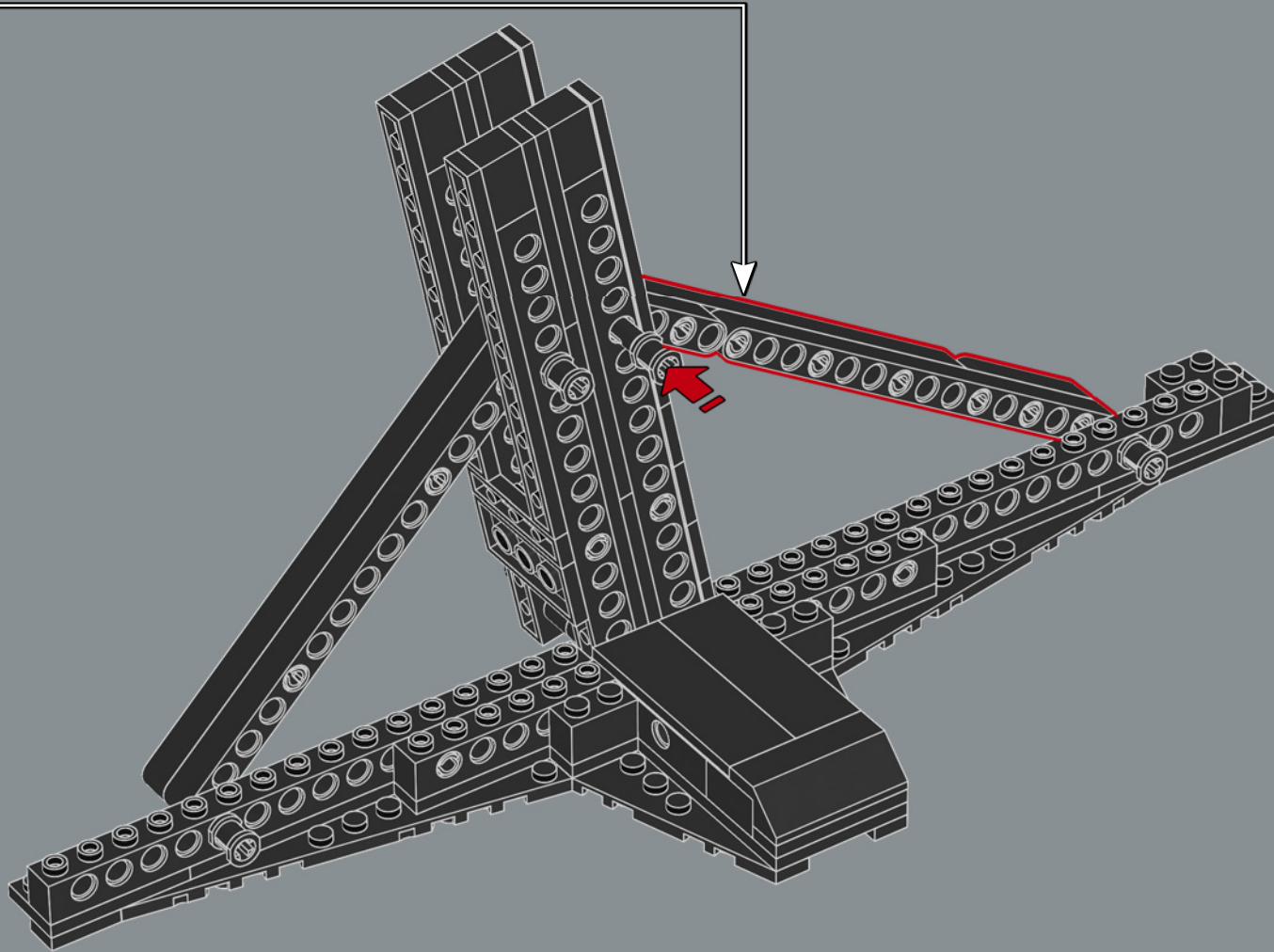



304

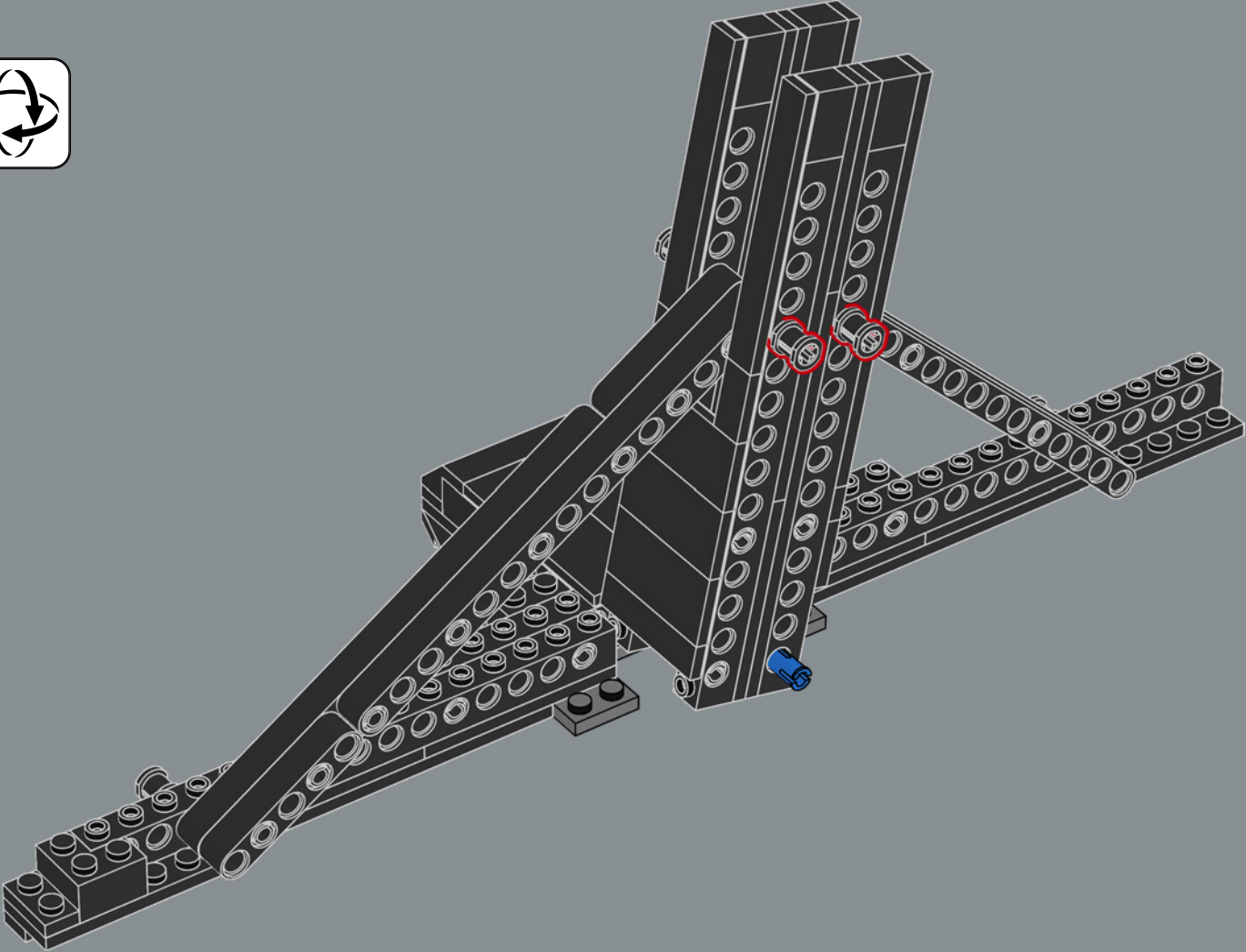

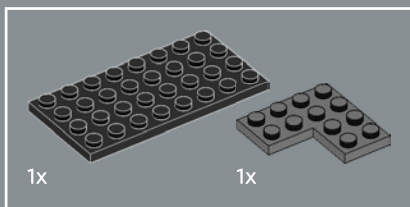
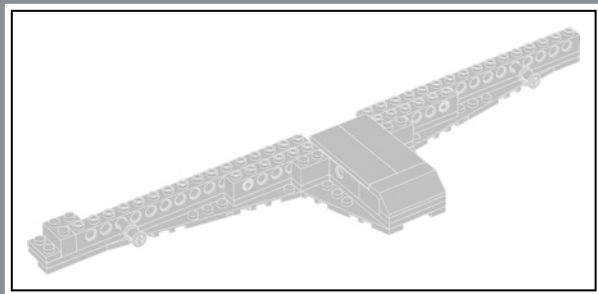

305

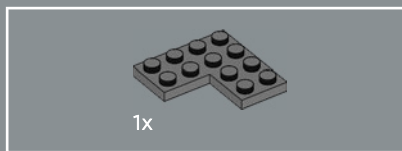
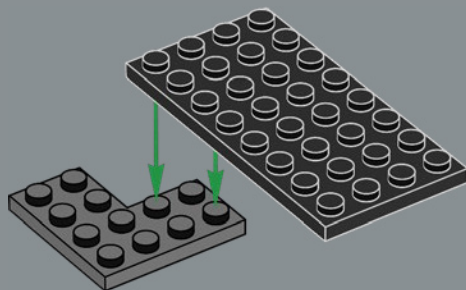

306

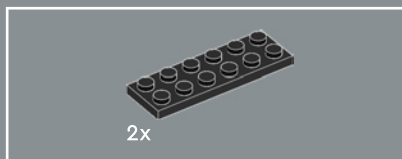
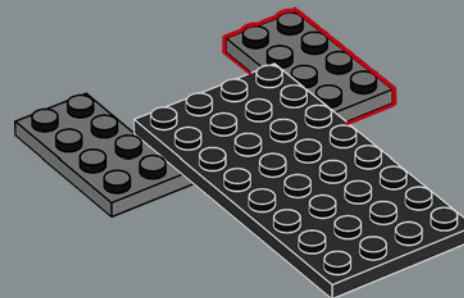

307

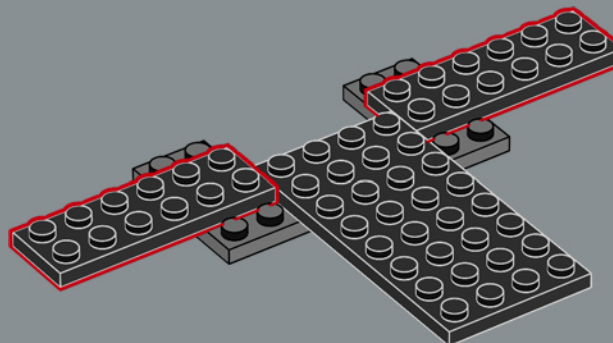

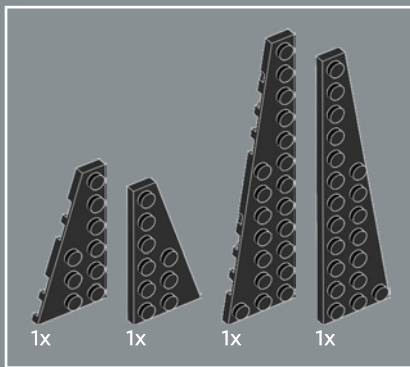

308

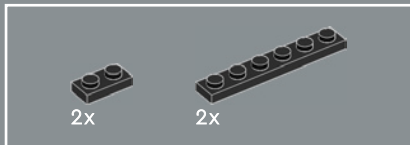
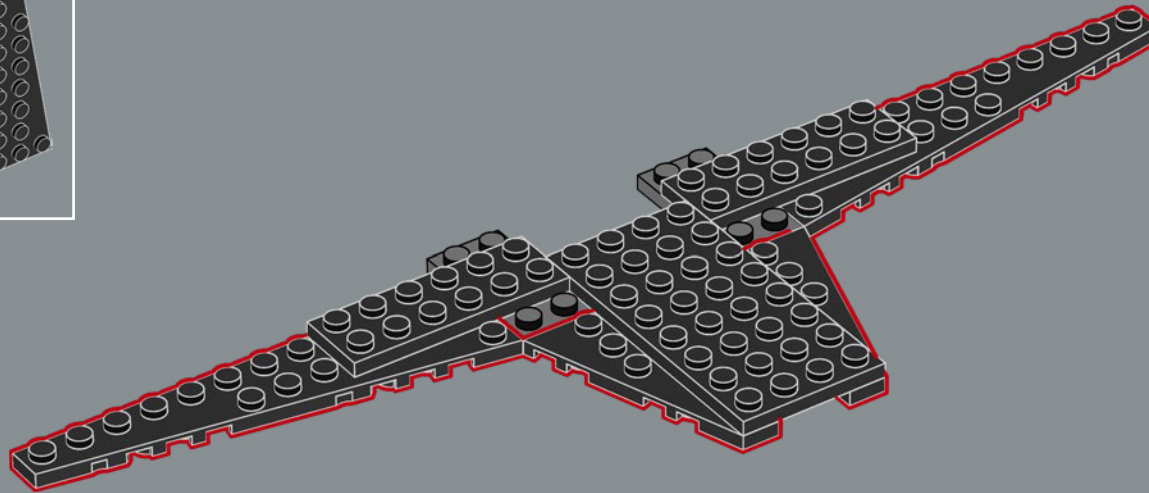

309

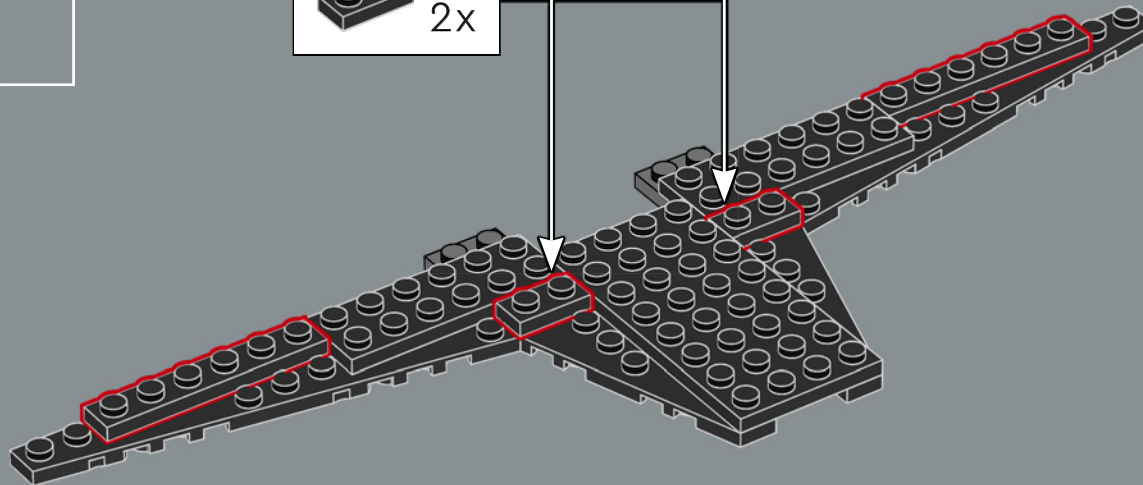

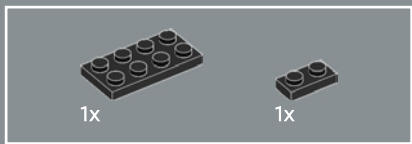

310

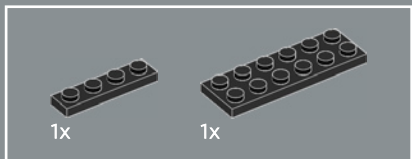
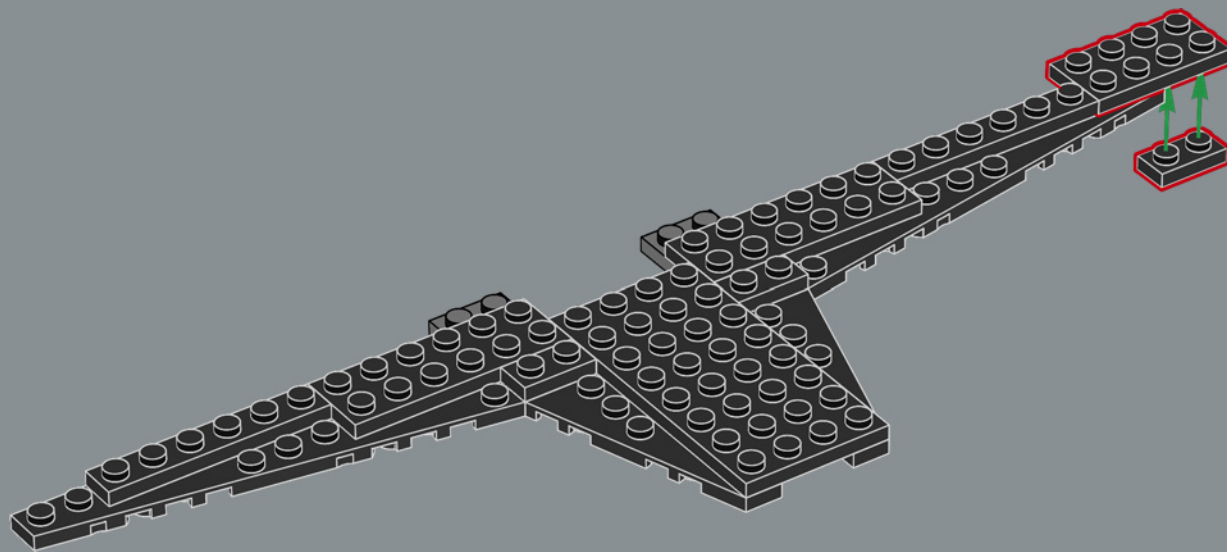

311

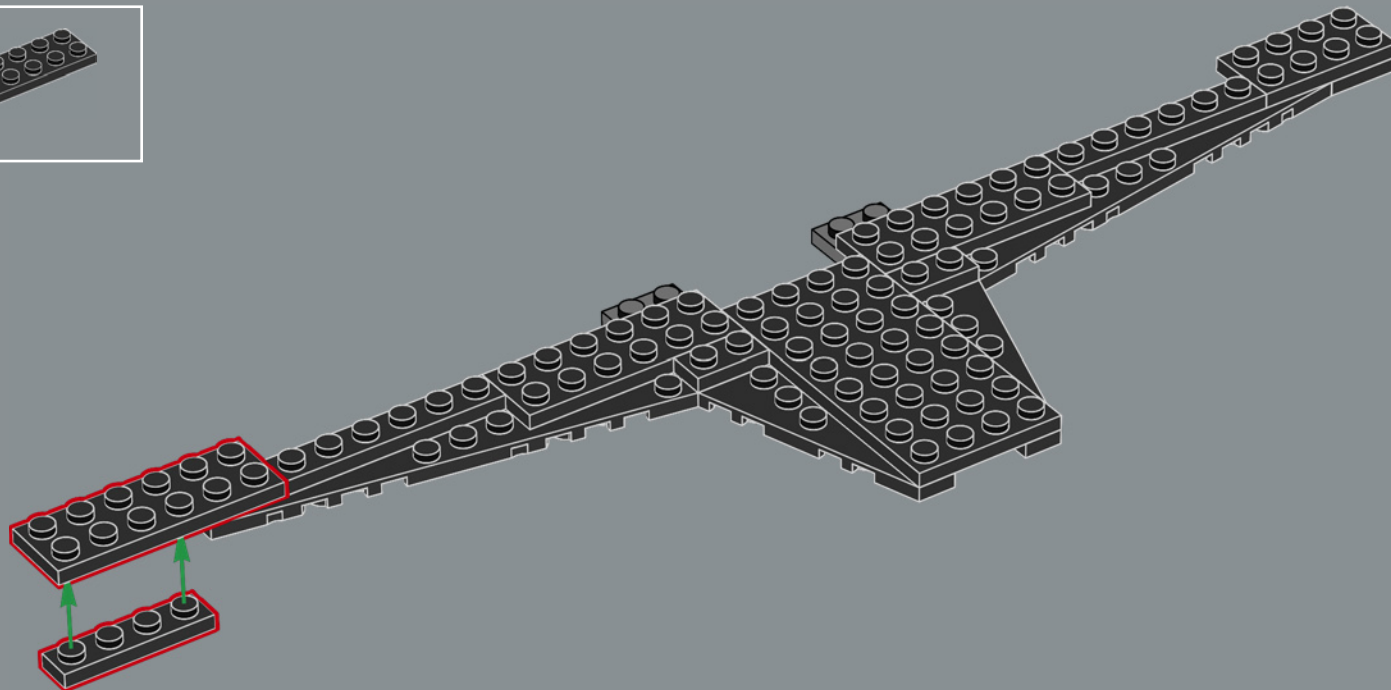

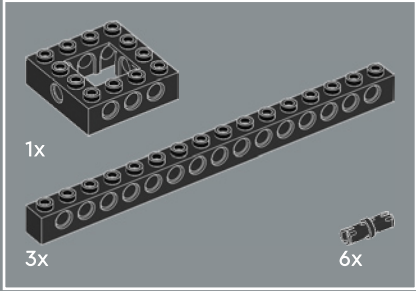
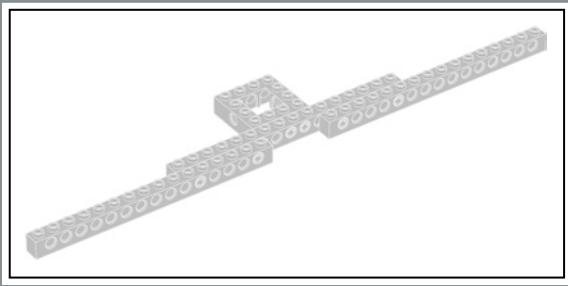

312

1

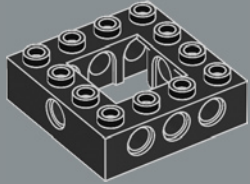

2

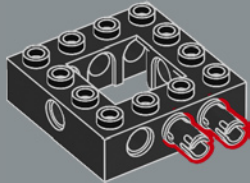

3

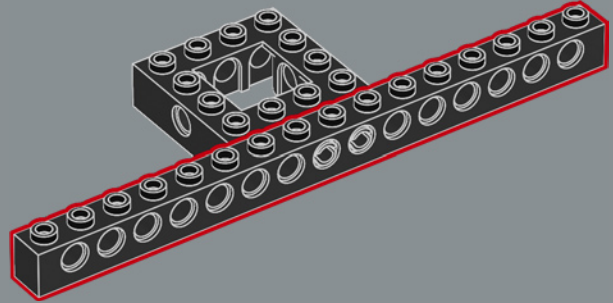

4

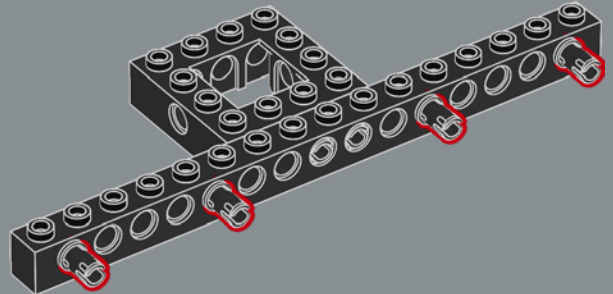

5

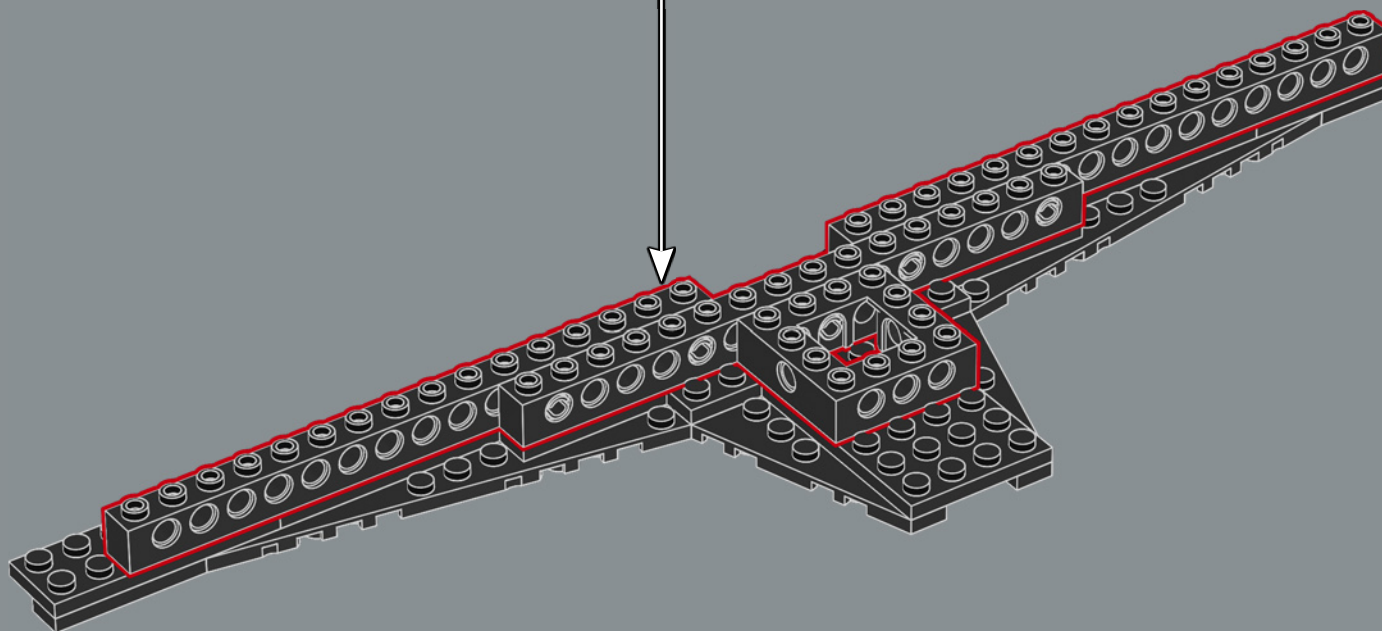
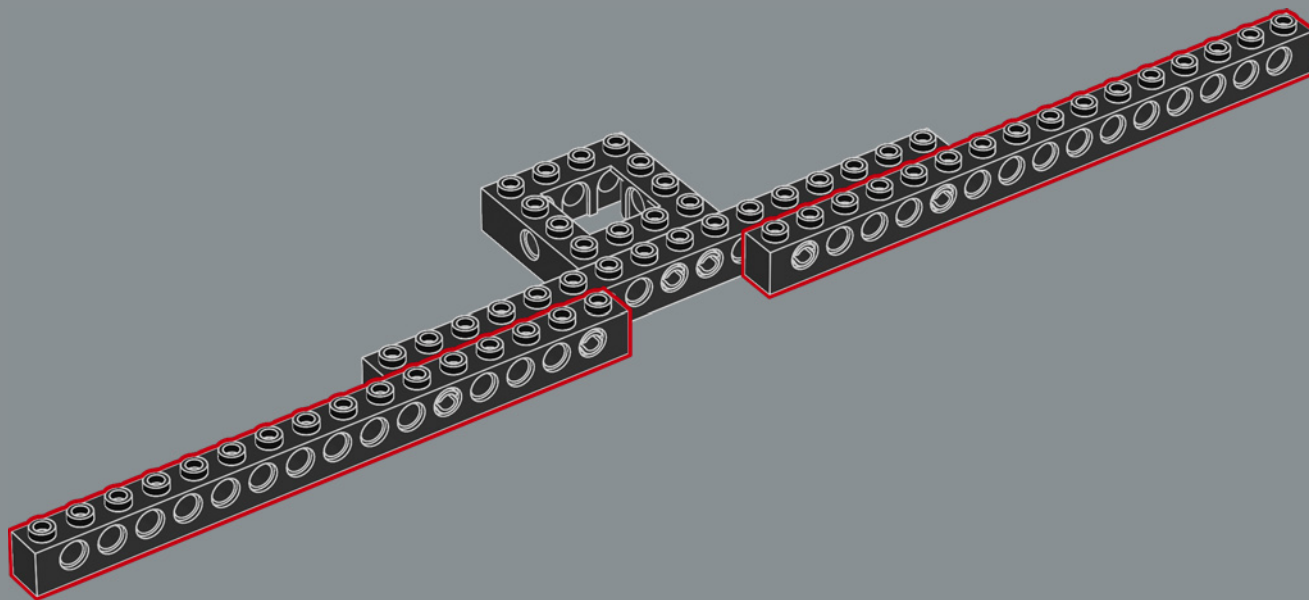

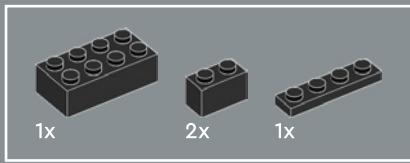

313

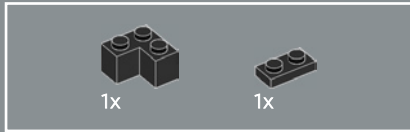
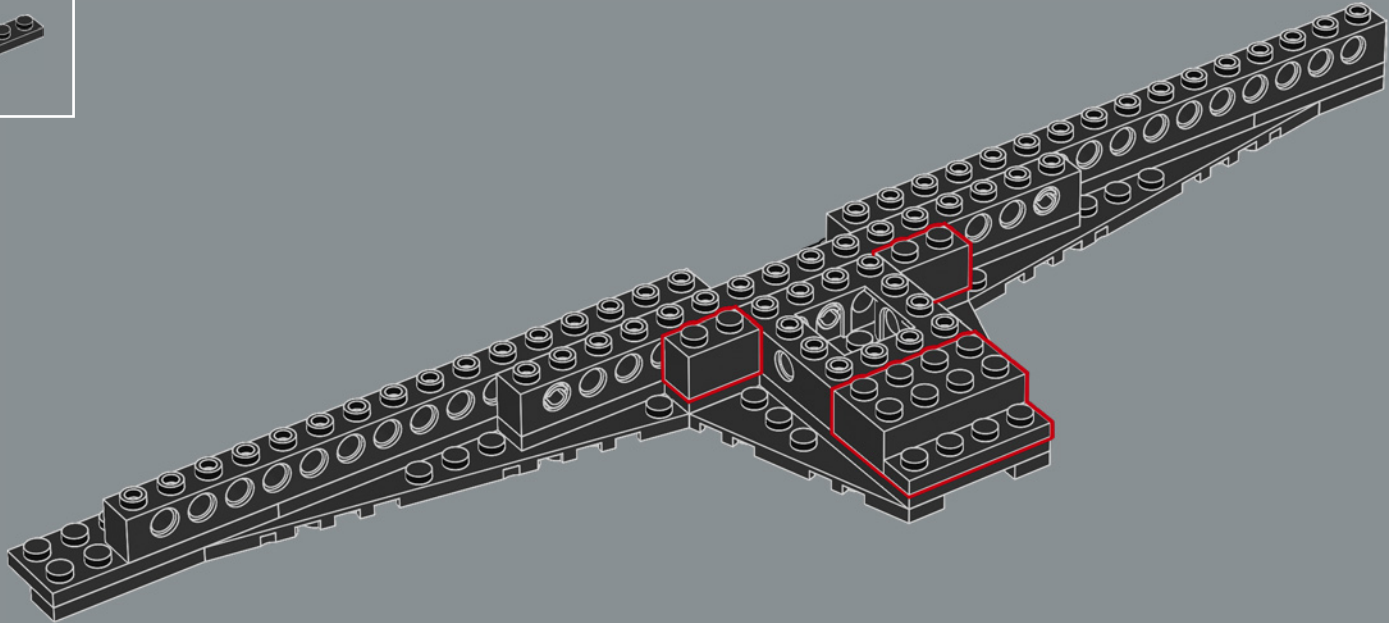

314

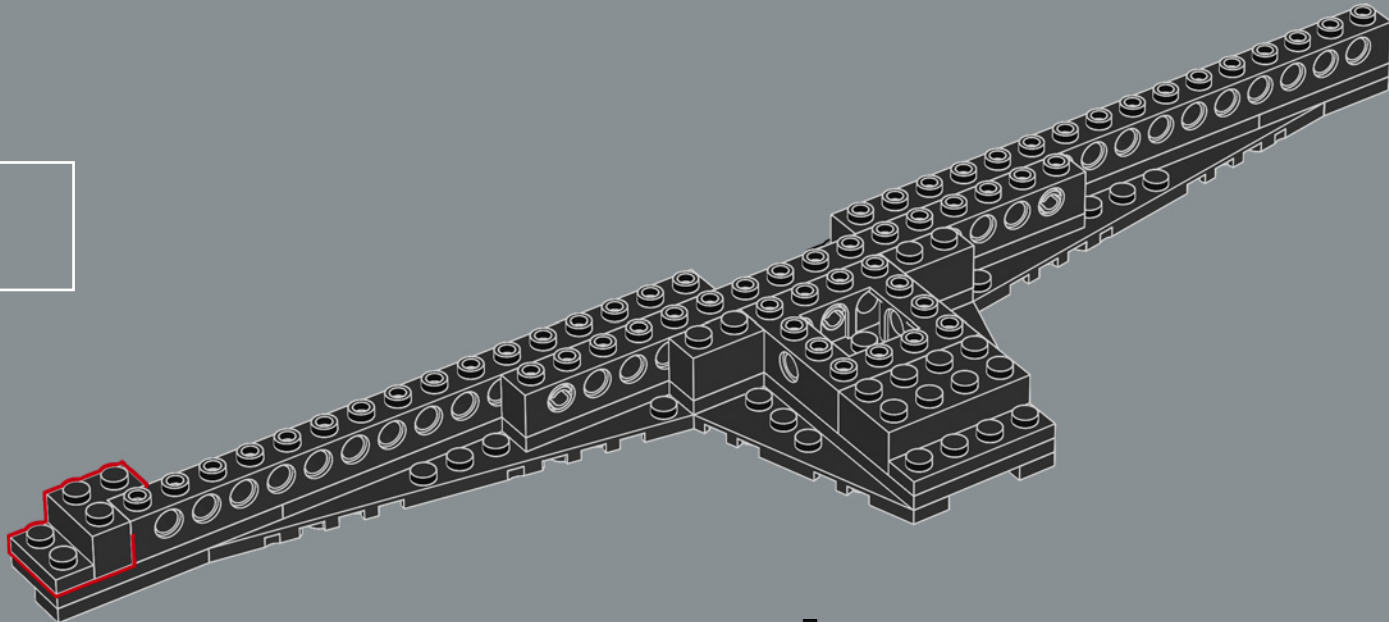

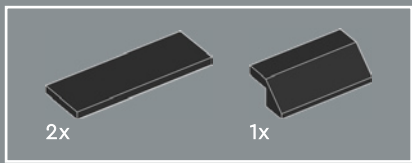

315

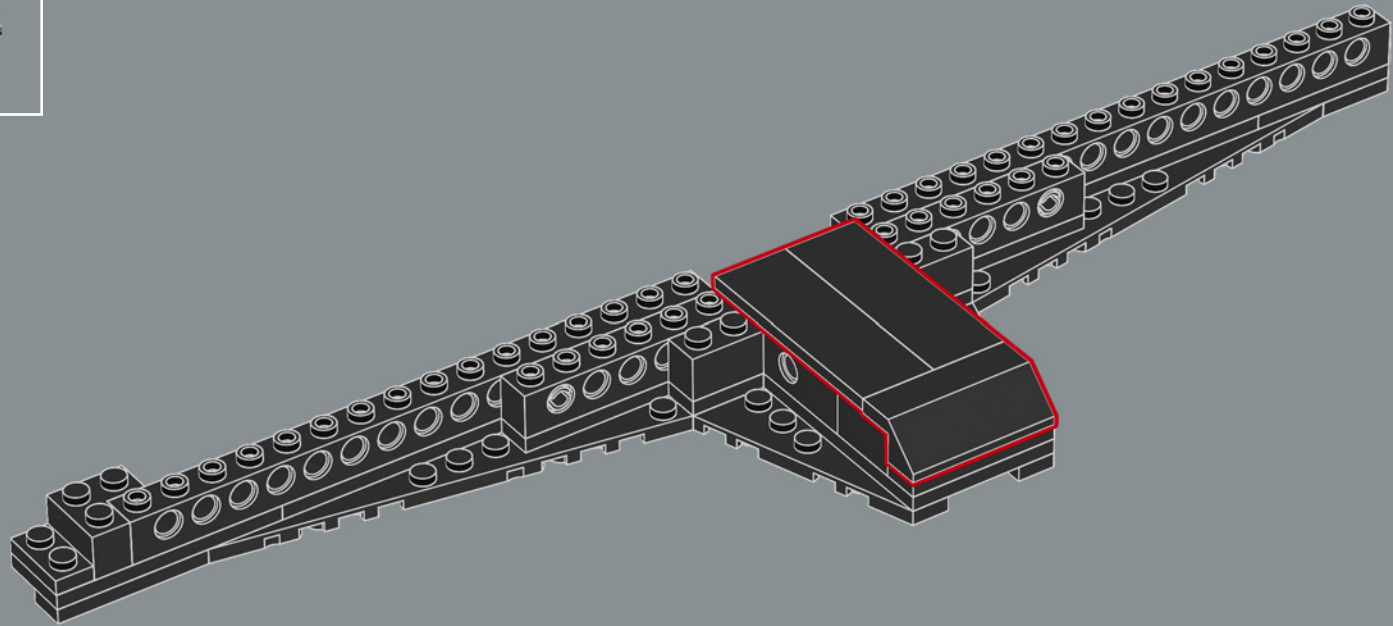

316

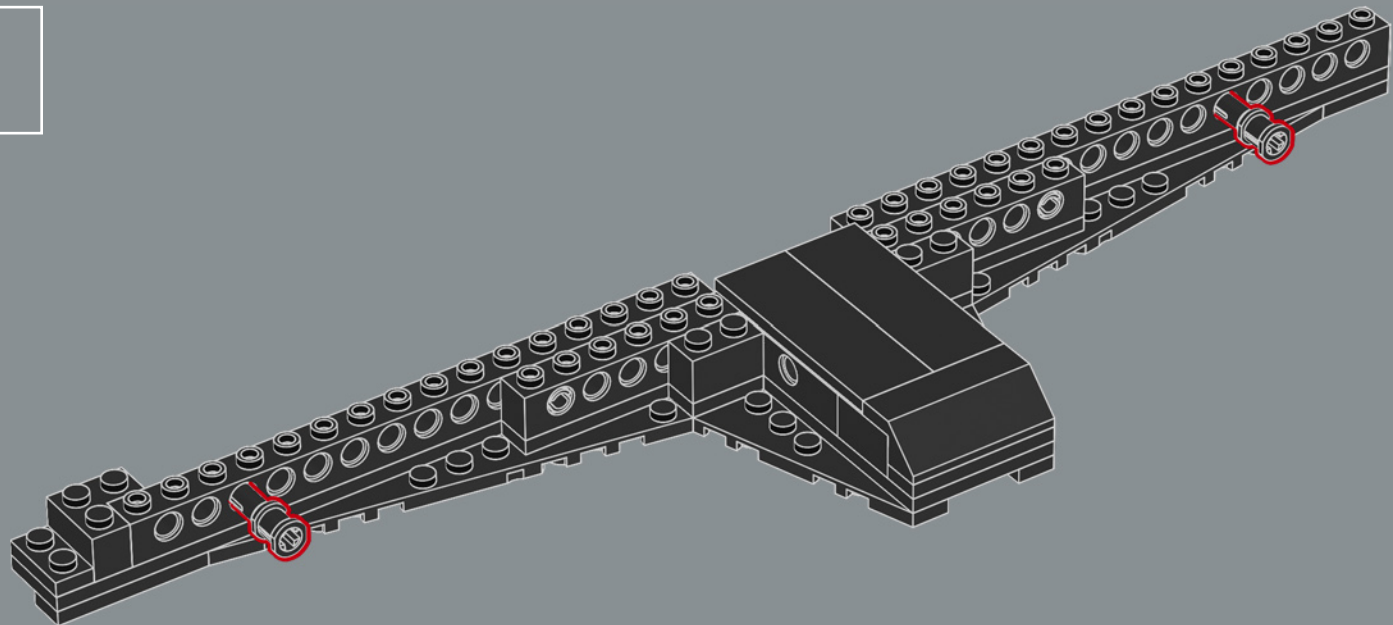

317

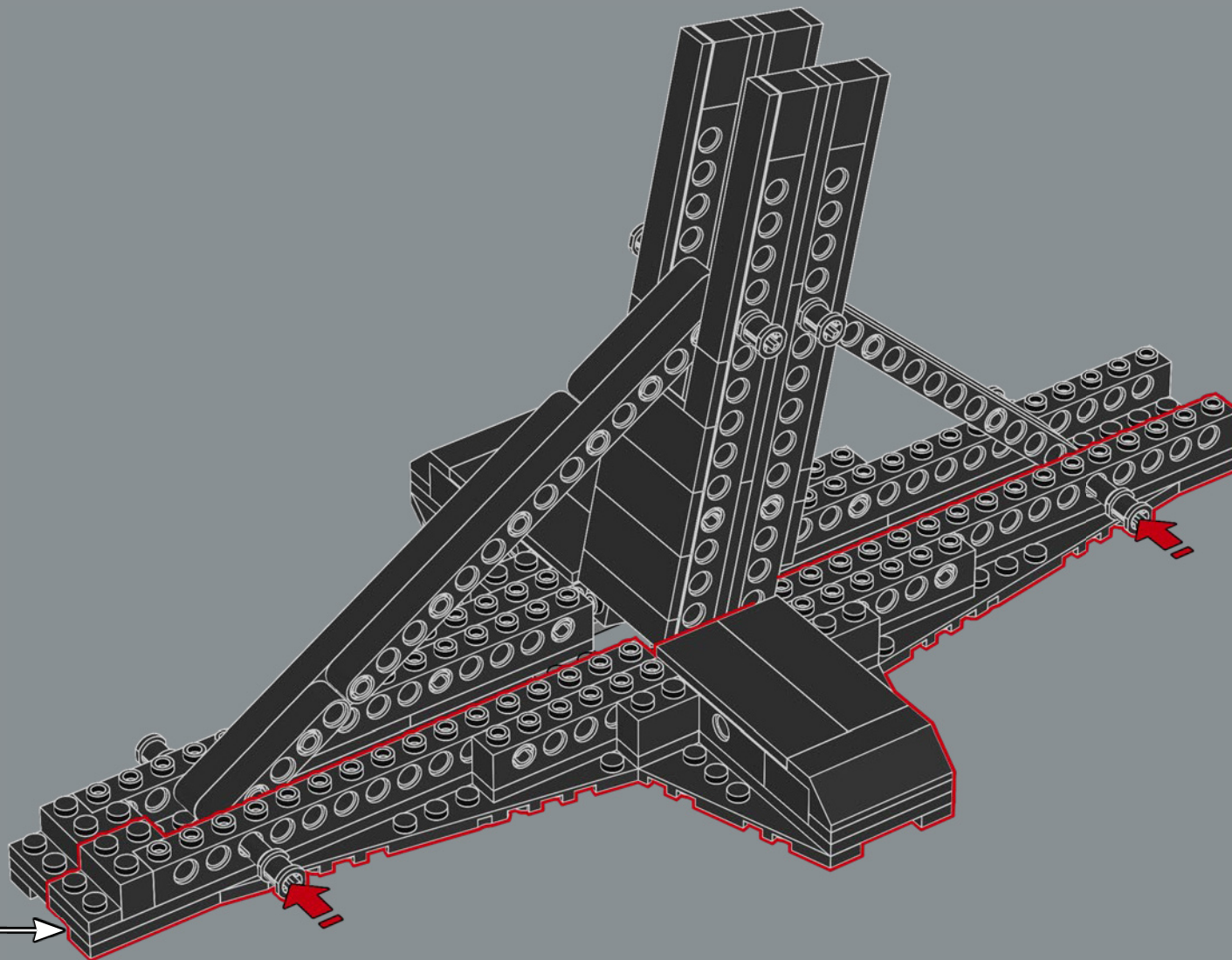

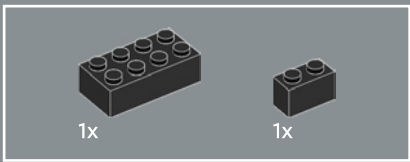

318

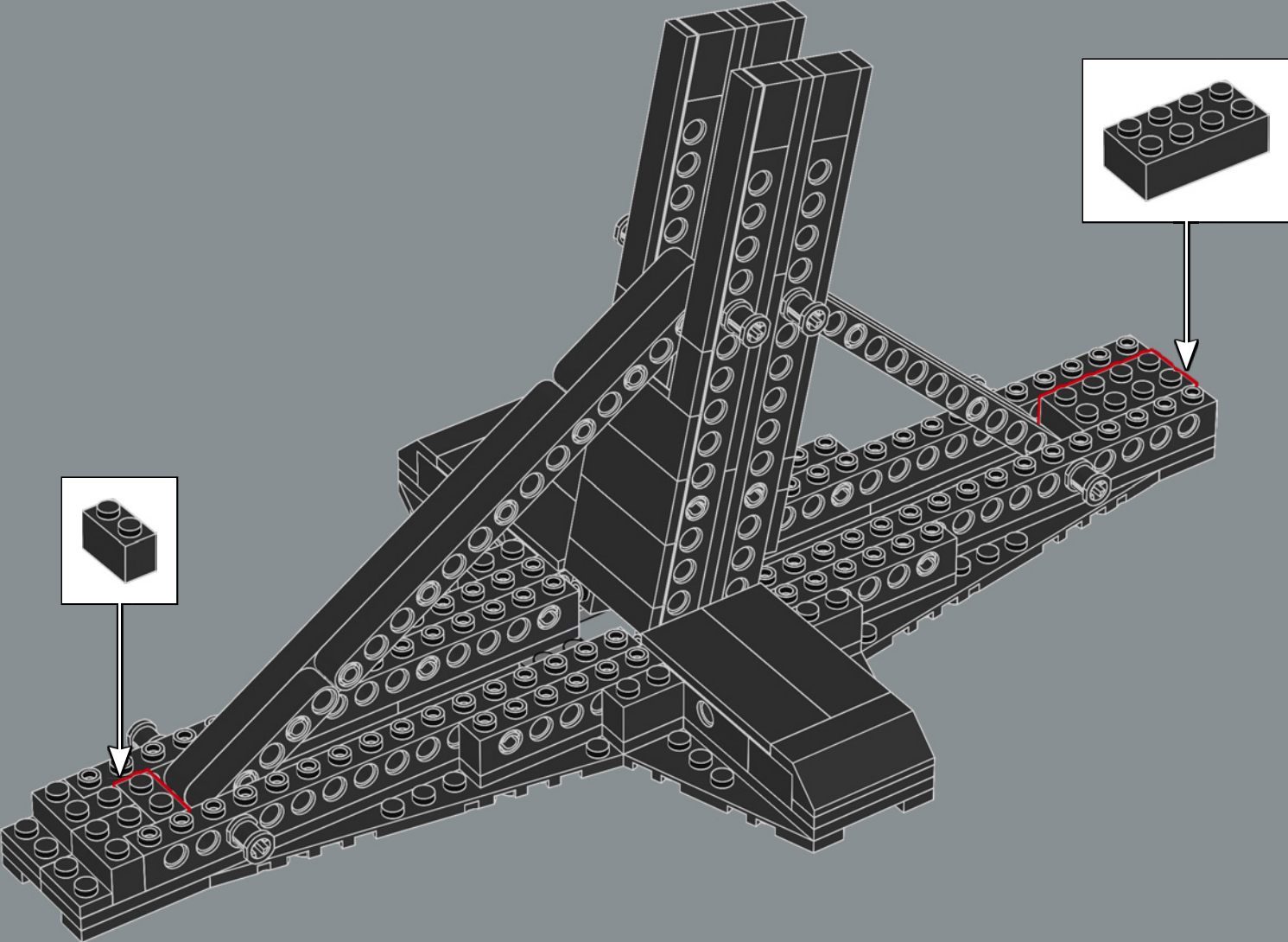

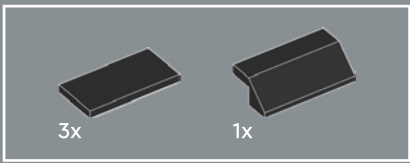

319

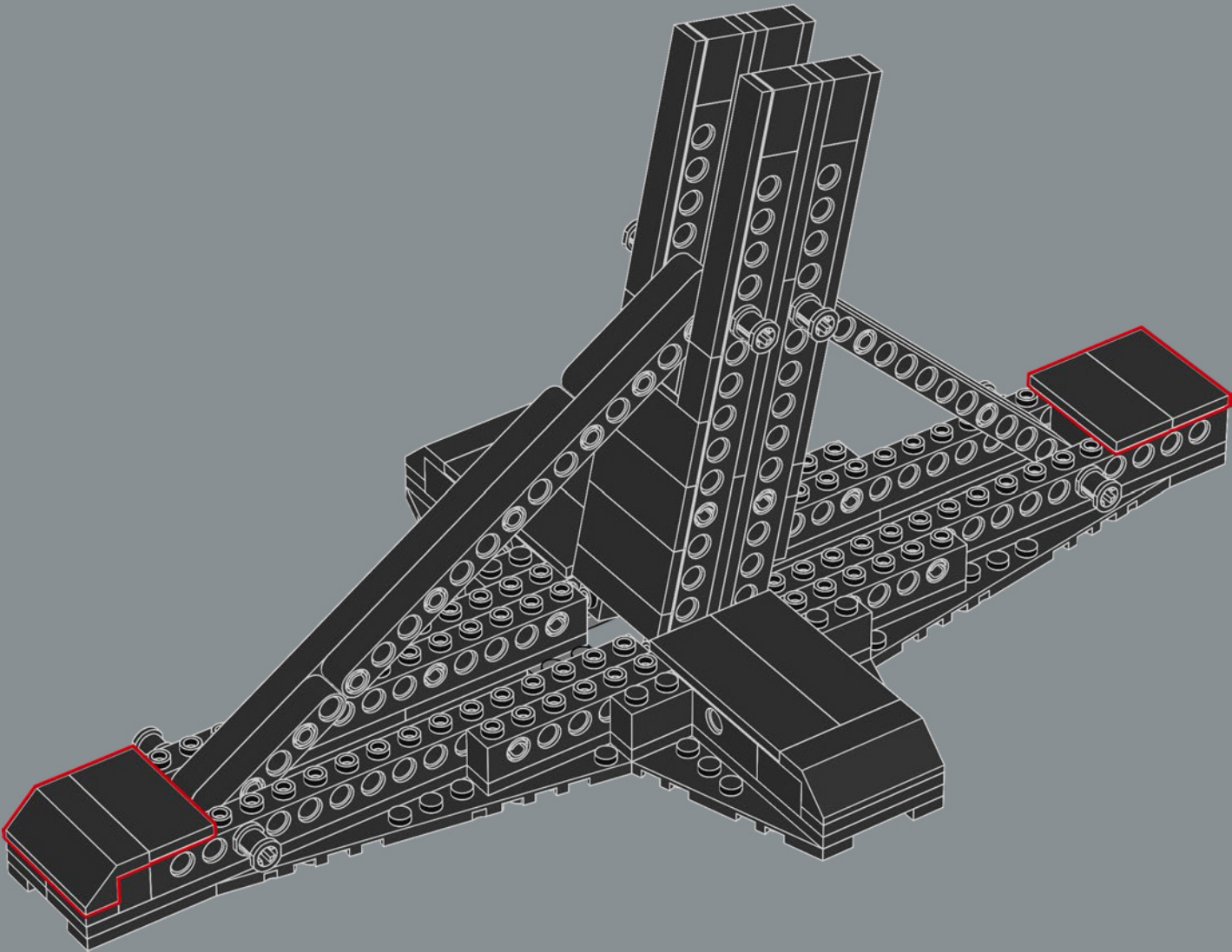

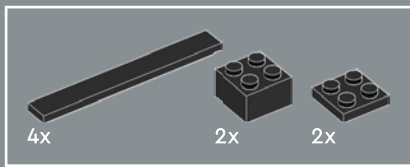

320

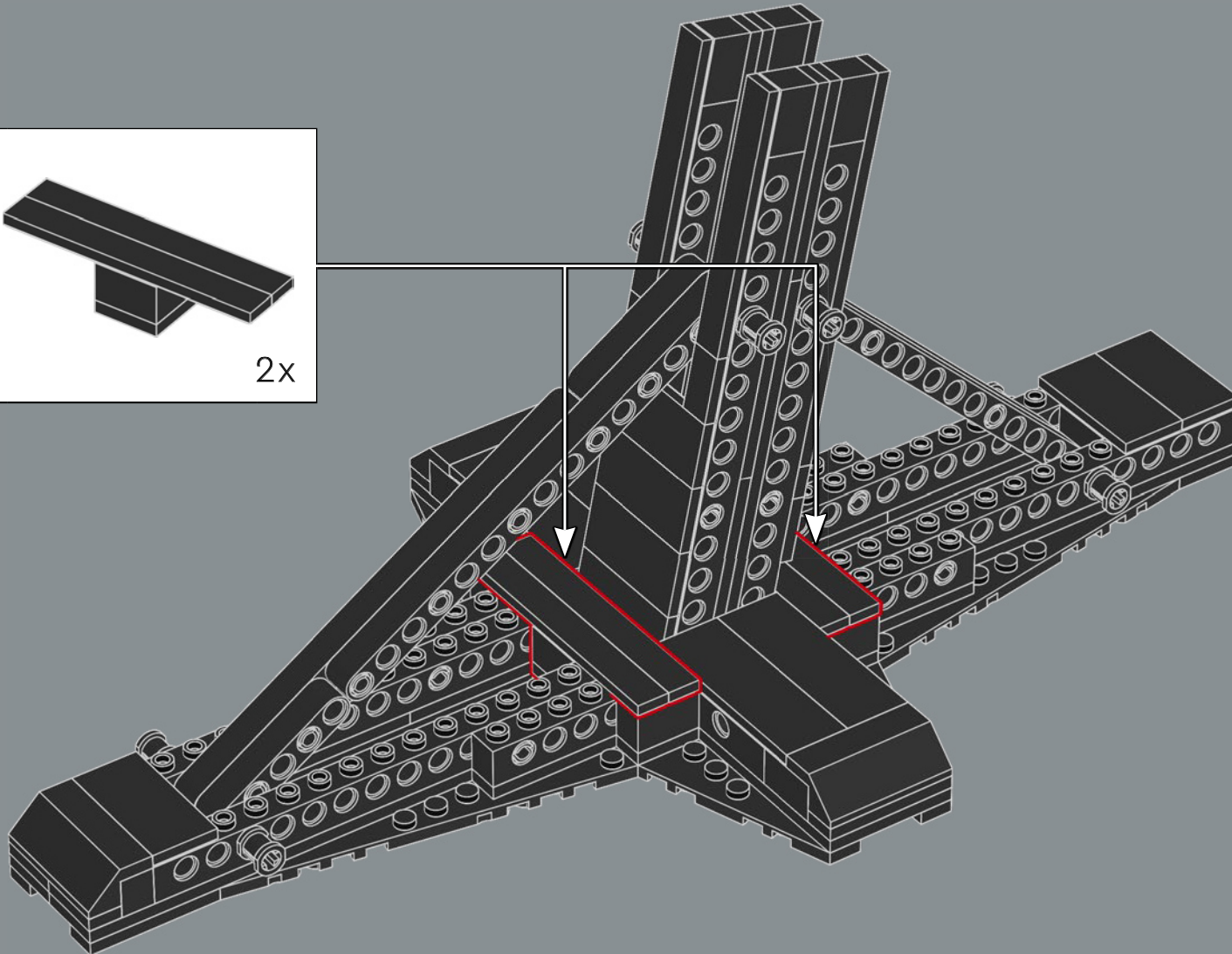
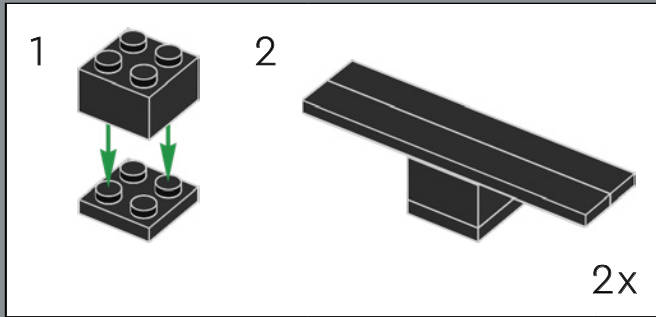

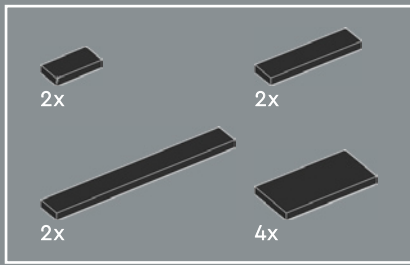

321

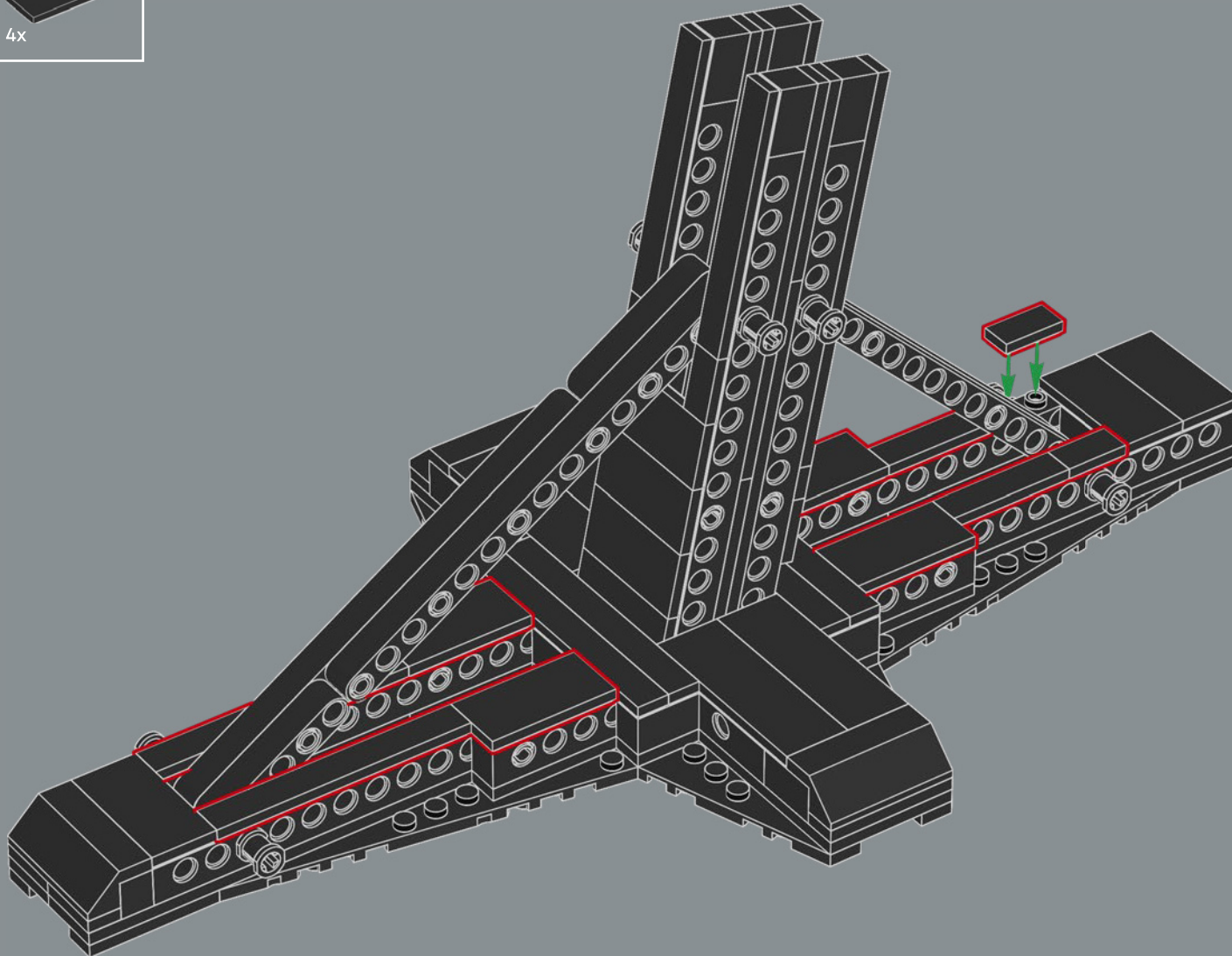

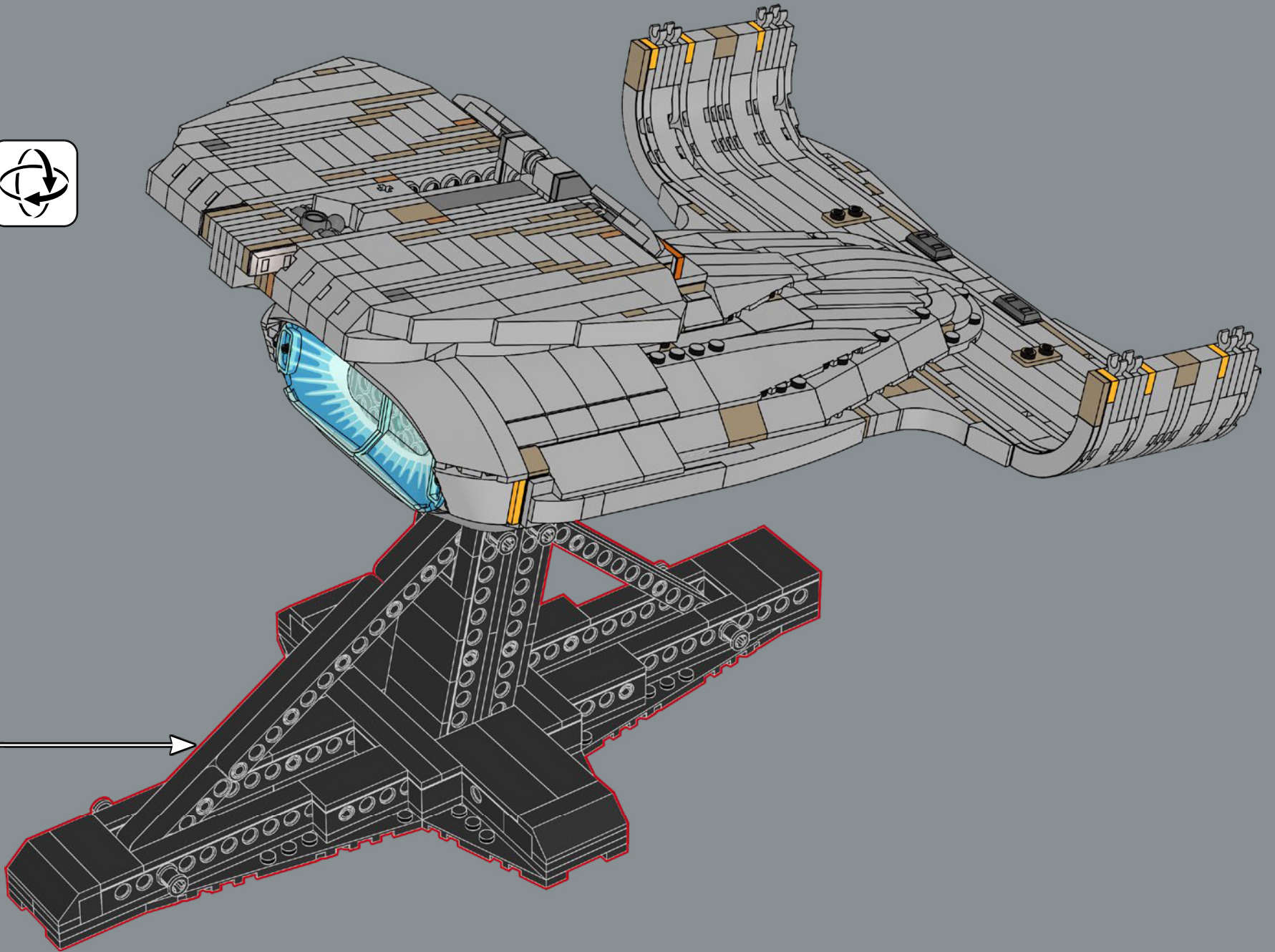



Once Geordi La Forge became the *Enterprise's* chief engineer, he always kept his Starfleet engineering case handy.

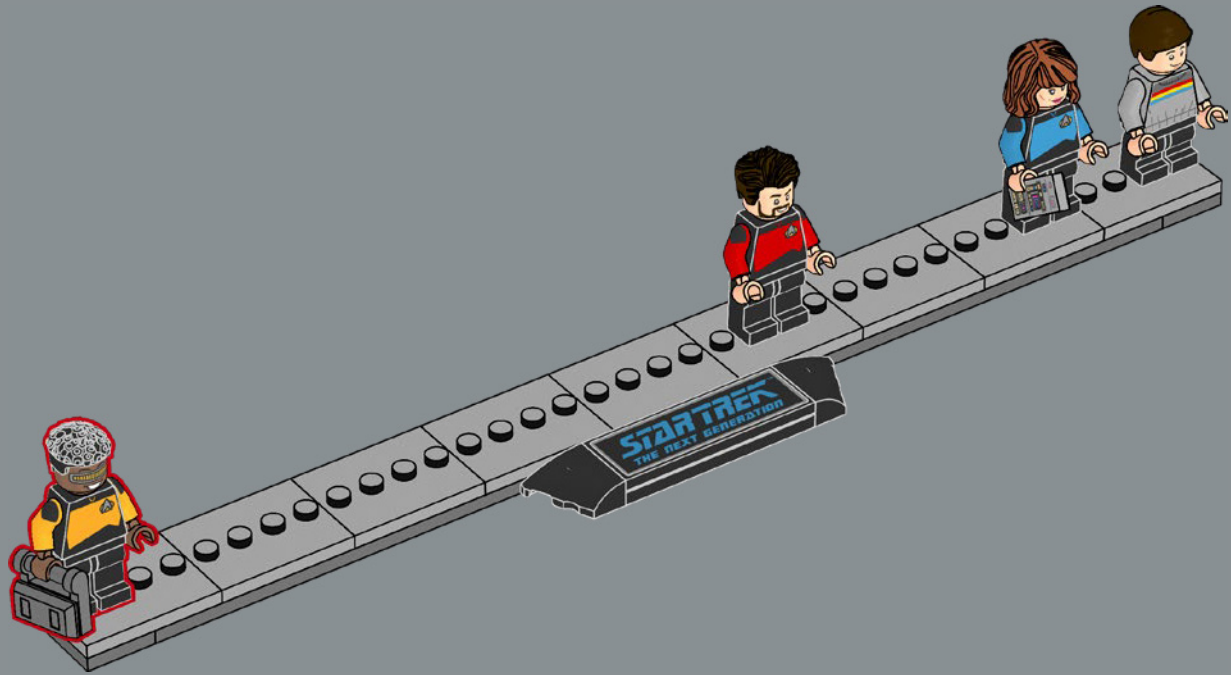
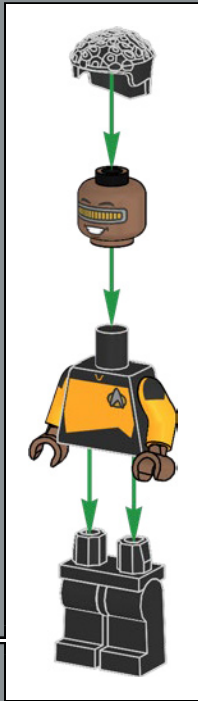
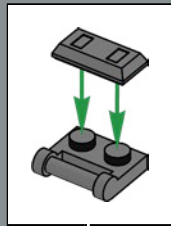

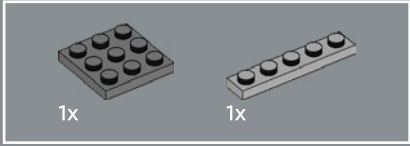
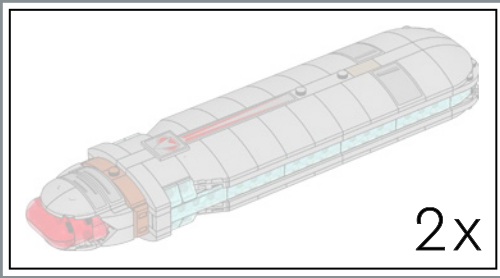

323

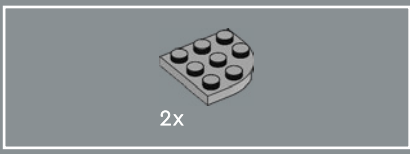
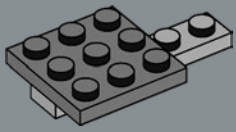

324

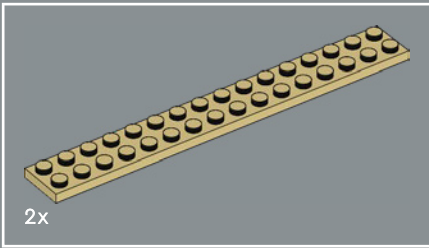
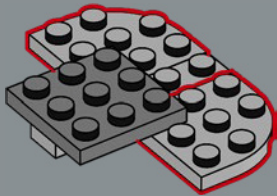

325

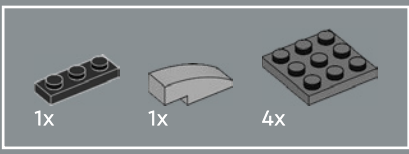
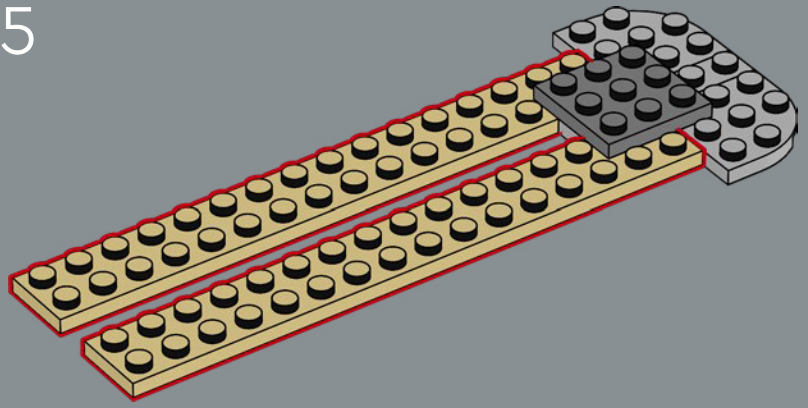

326

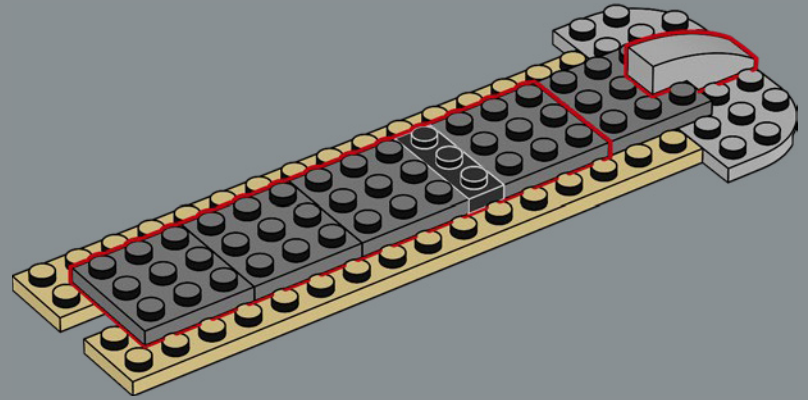

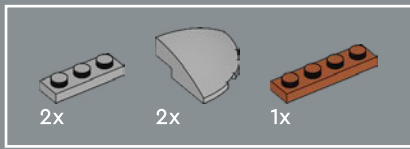

327

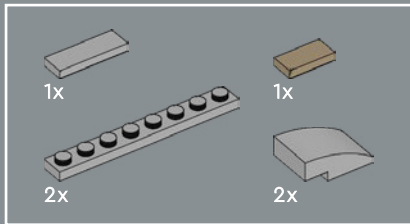
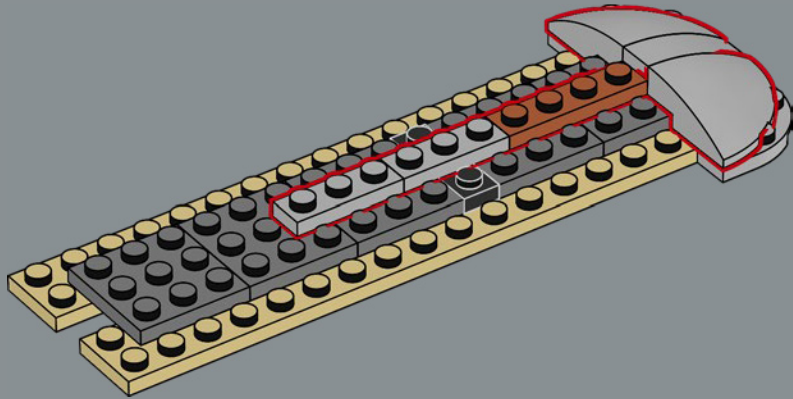

328

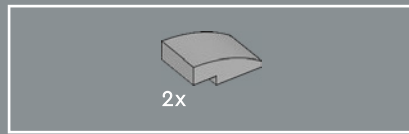
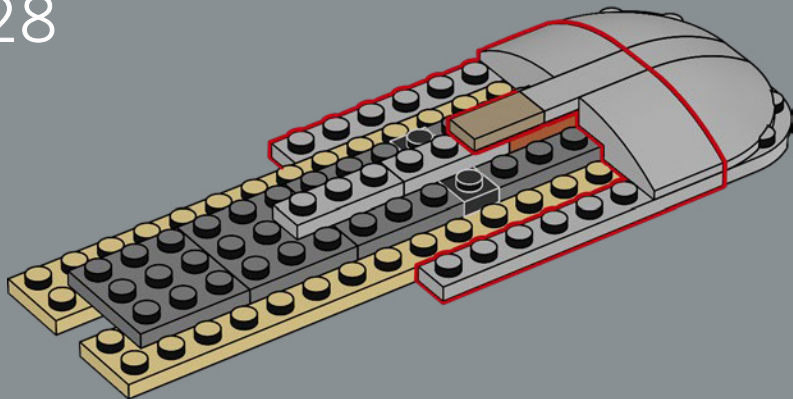

329

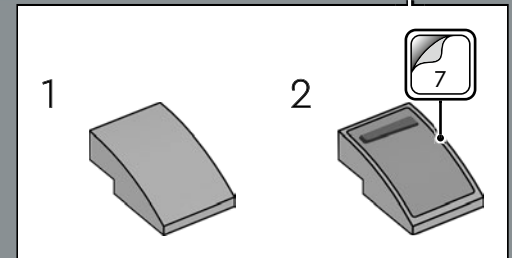
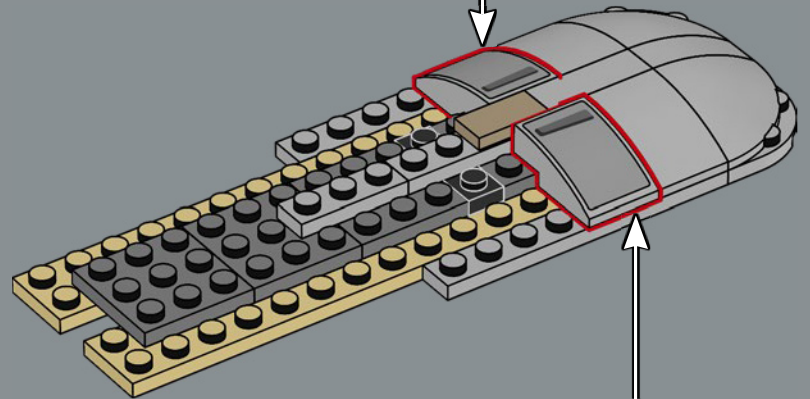
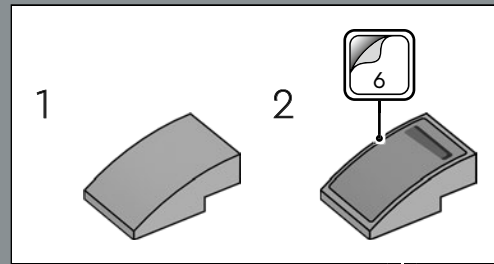

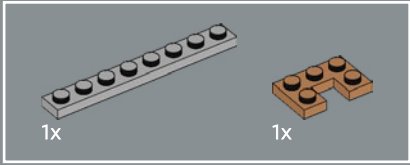
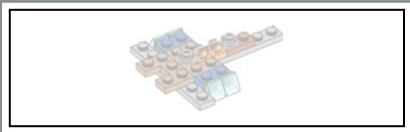

330

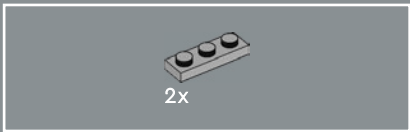
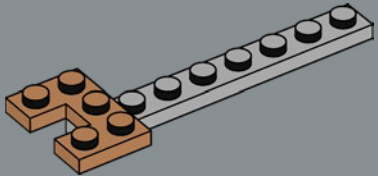

331

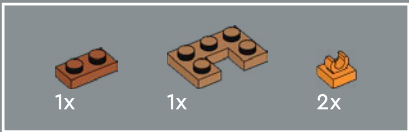
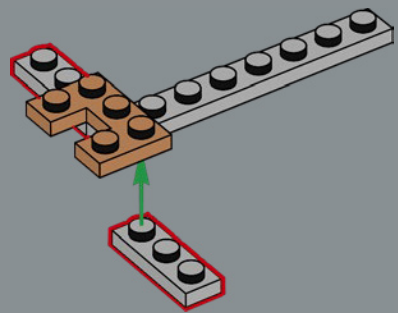

332

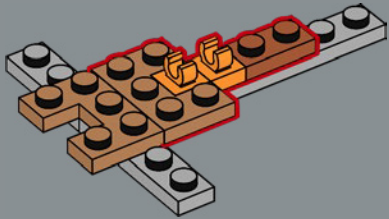

333

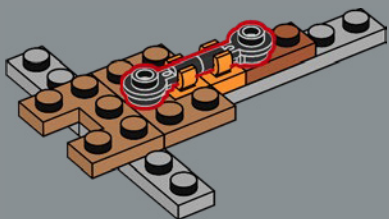



334

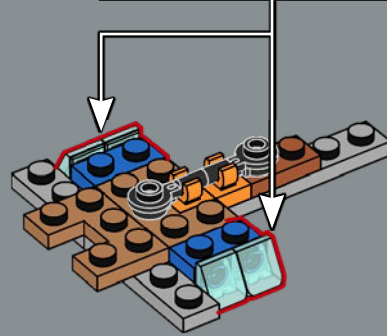
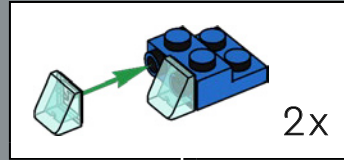

335

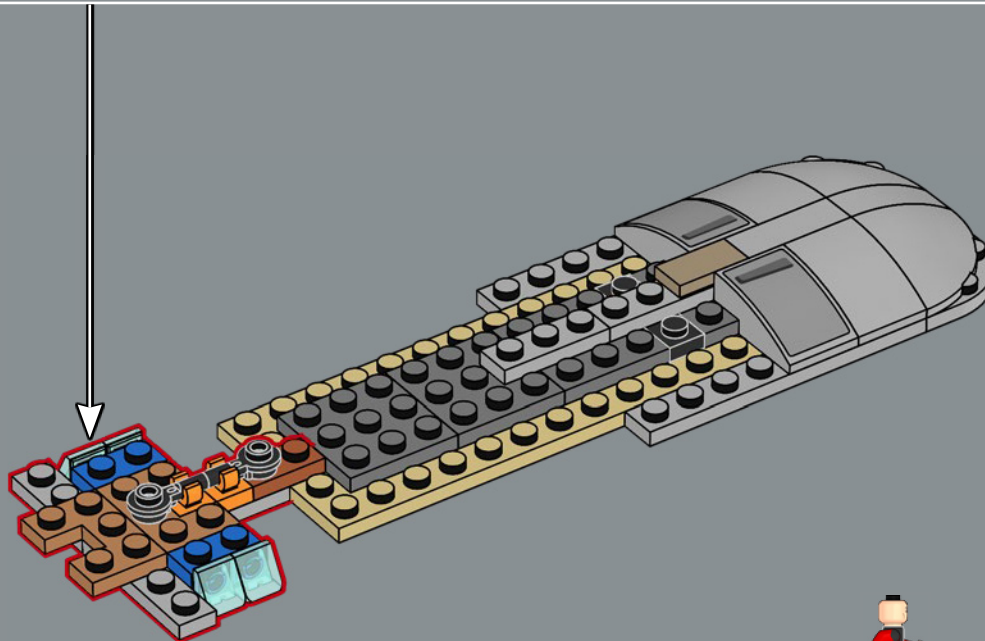

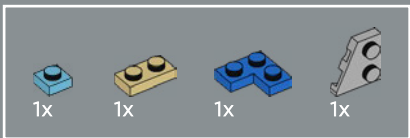

336

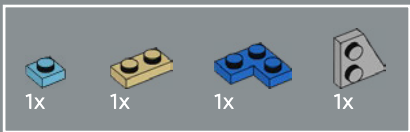
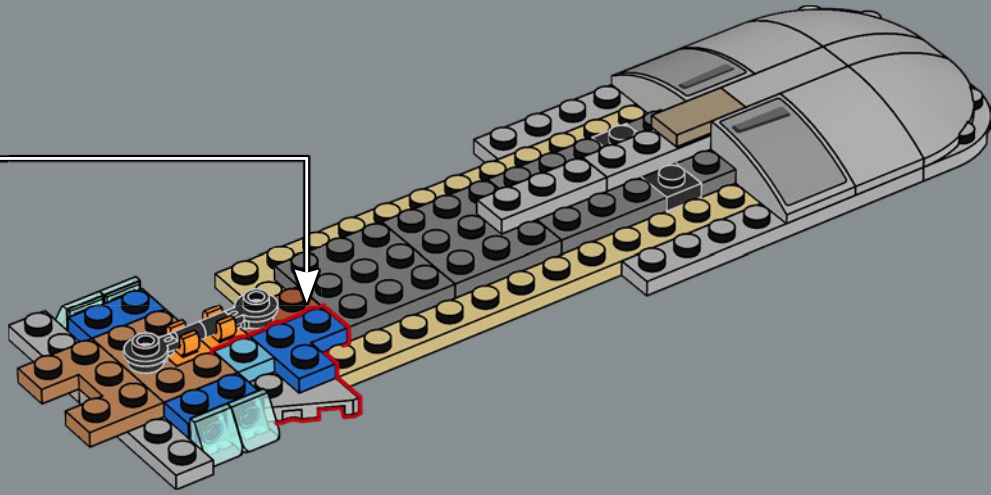
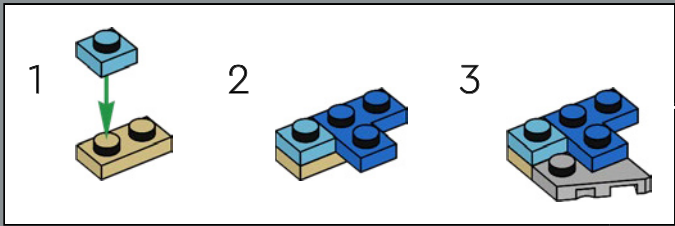

337

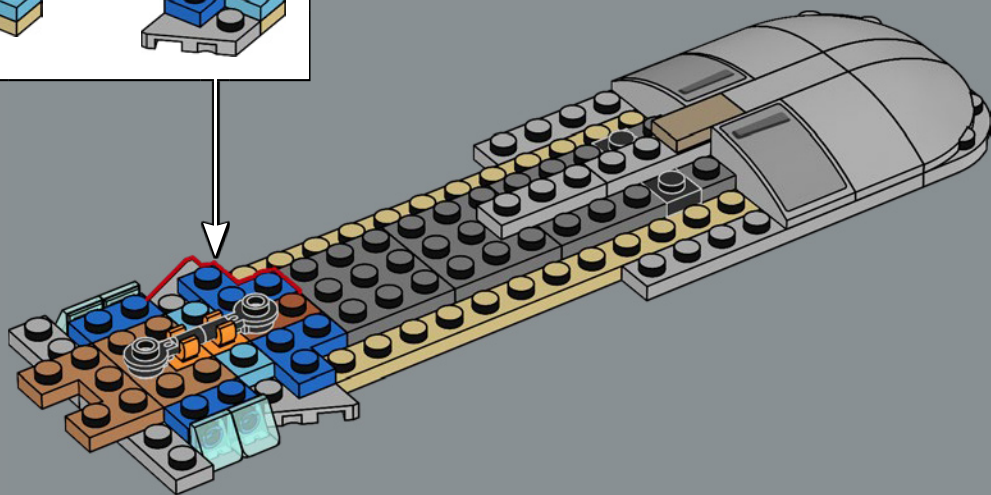
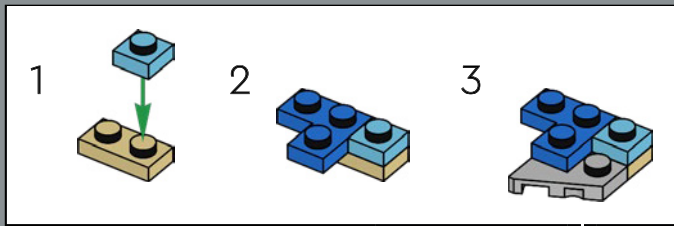

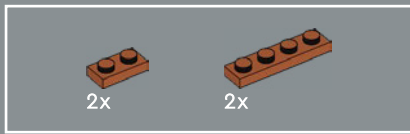

338

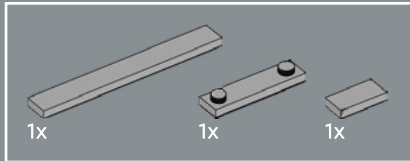
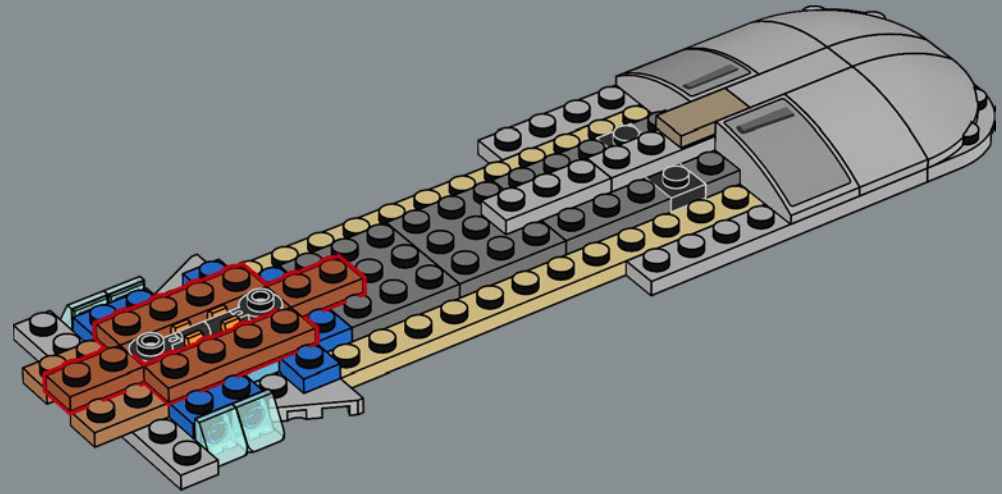

339

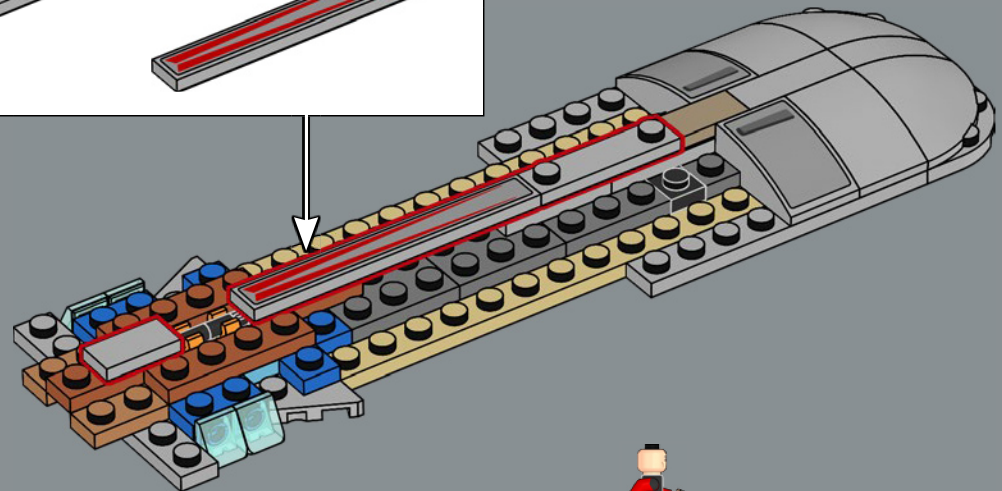
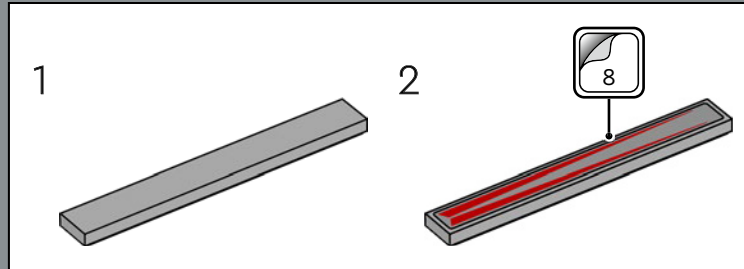

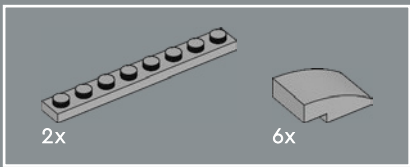

340

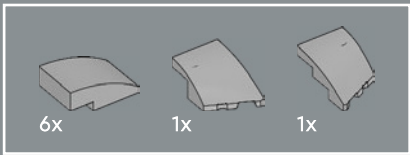
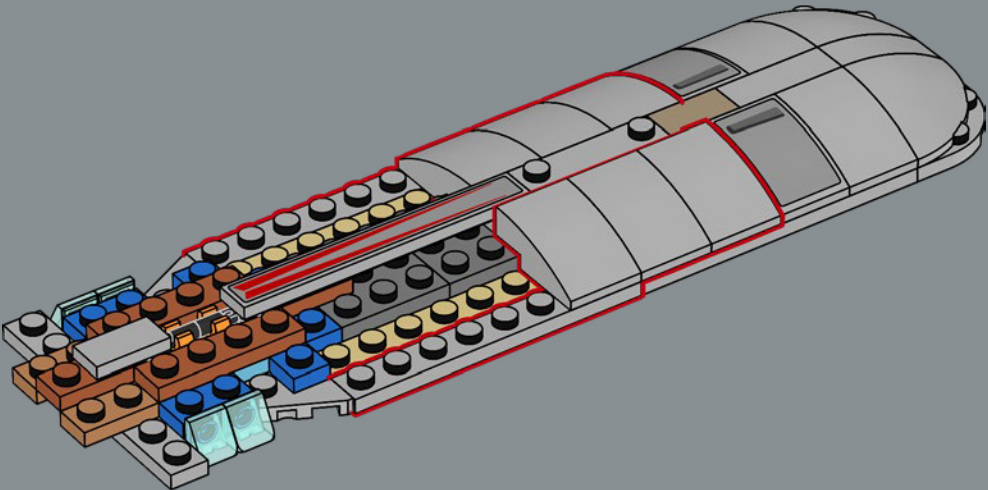

341

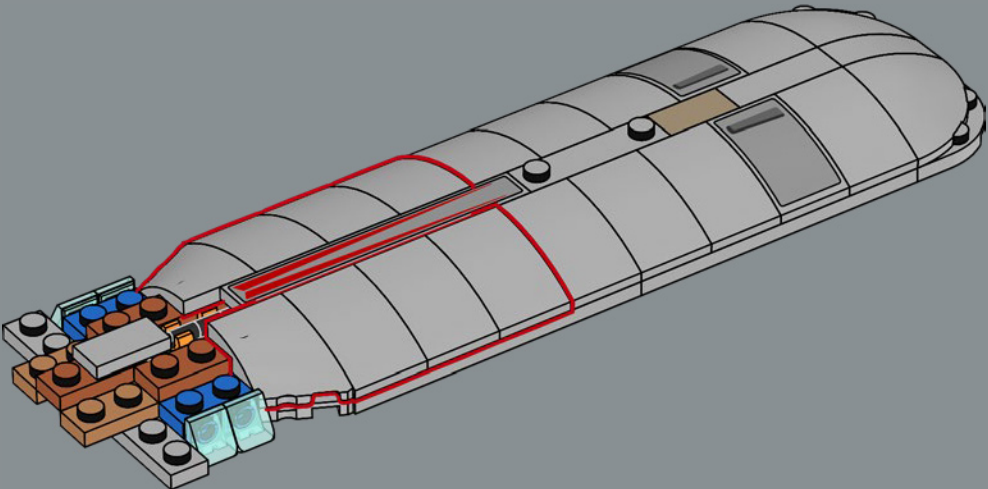

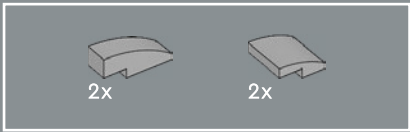

342

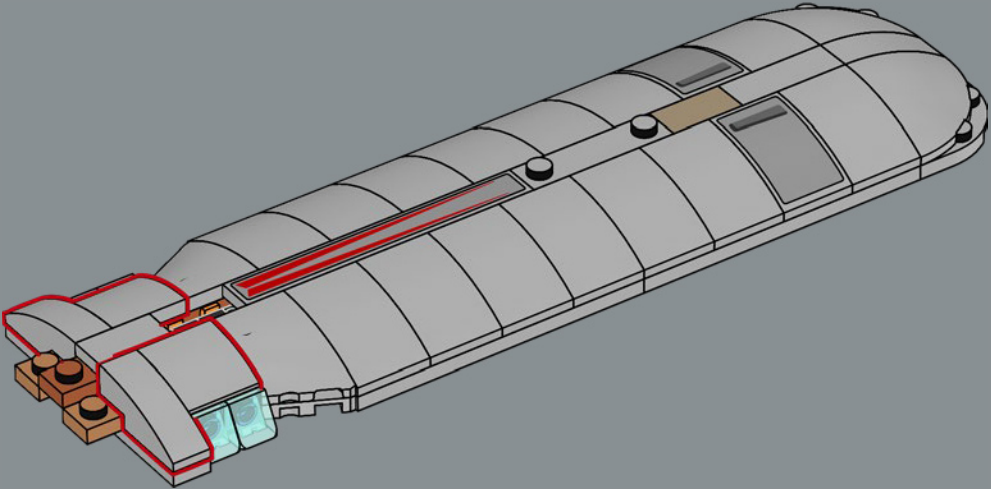

2x



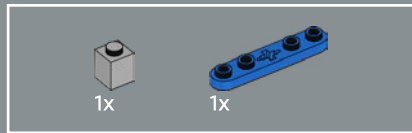
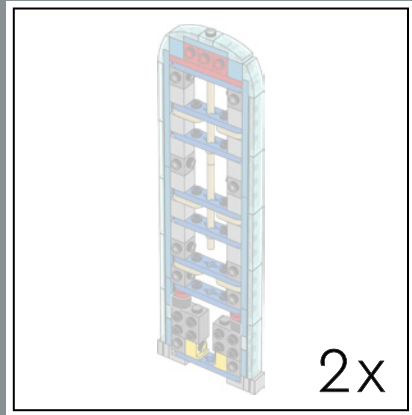

343

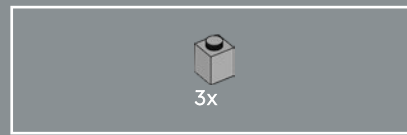
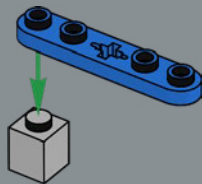

344

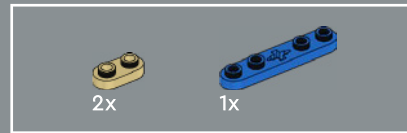
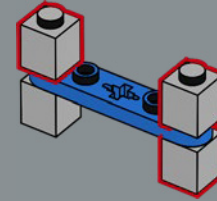

345

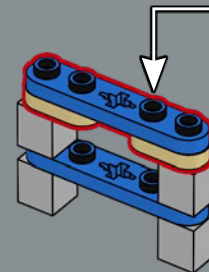
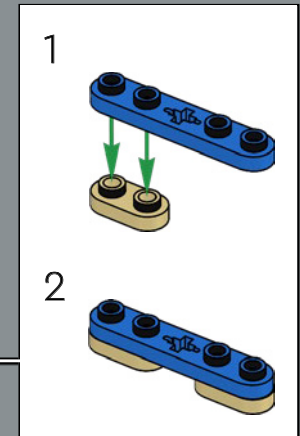



346

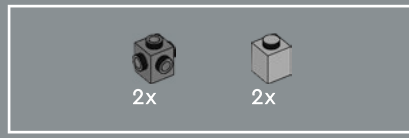
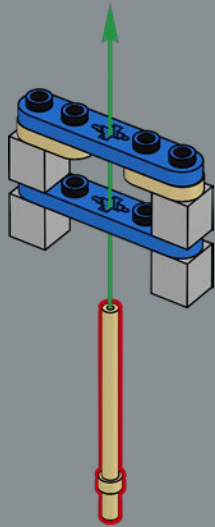

347

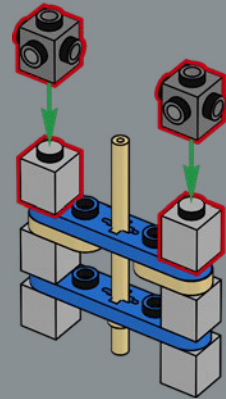



348

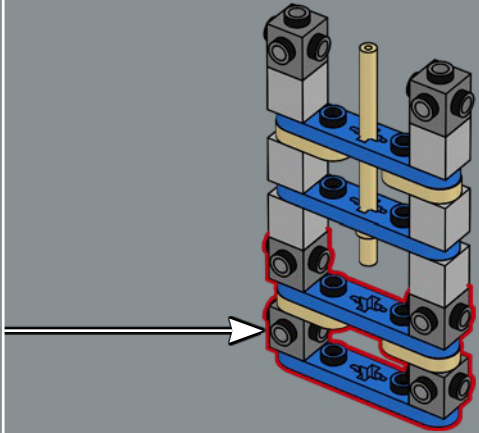
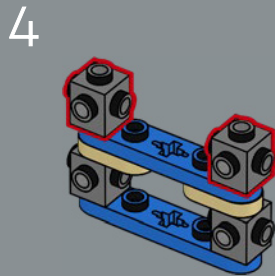
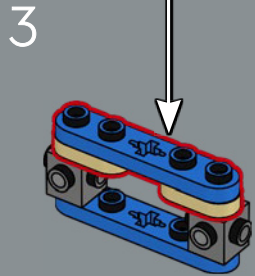
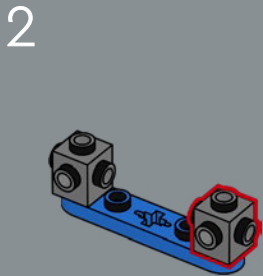
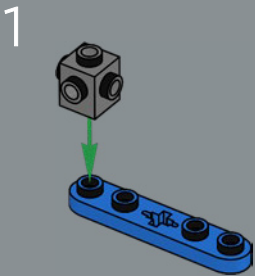
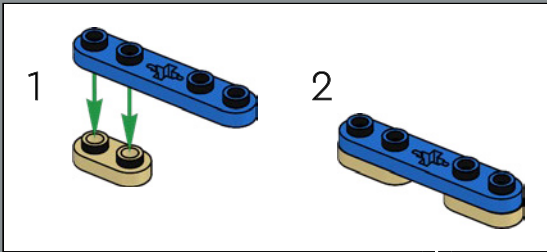

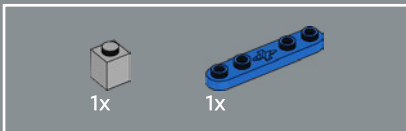
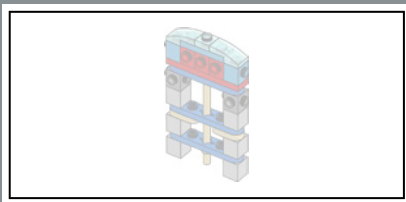

349

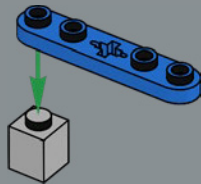

350

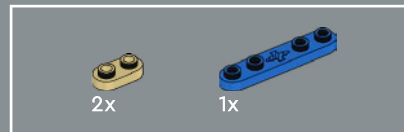
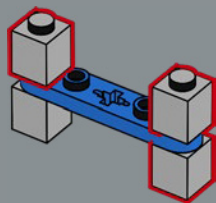

351

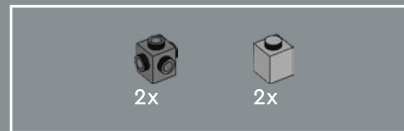
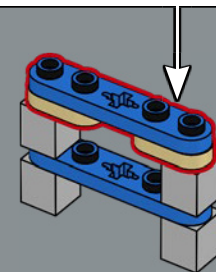
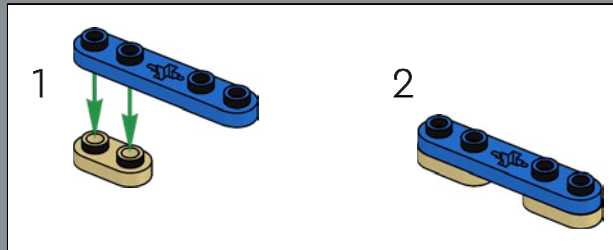

352

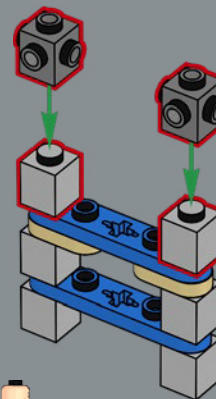

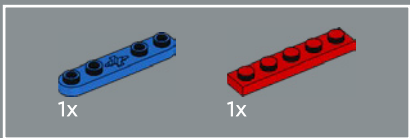

353

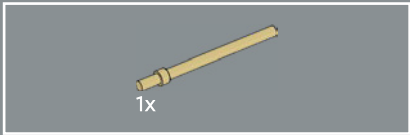
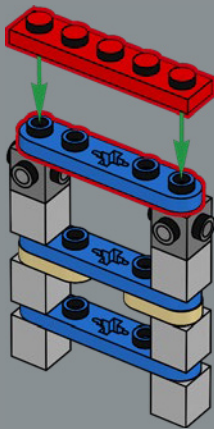

354

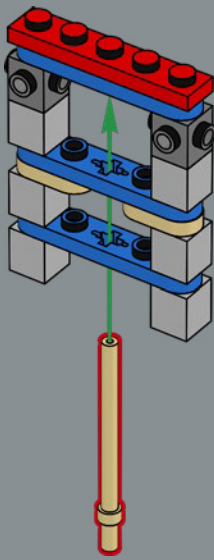

355

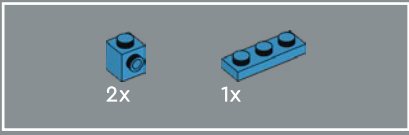
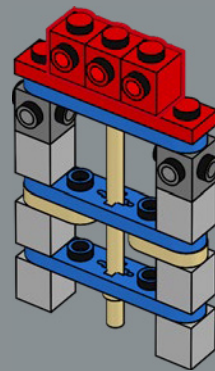

356

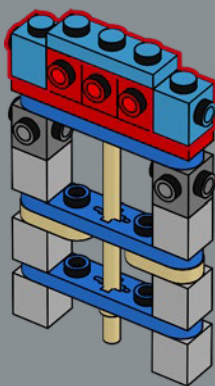

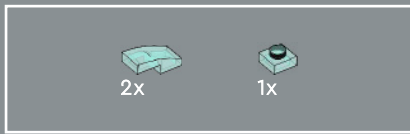

357

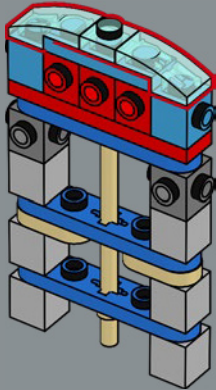

358

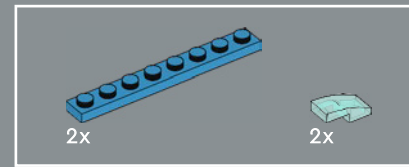
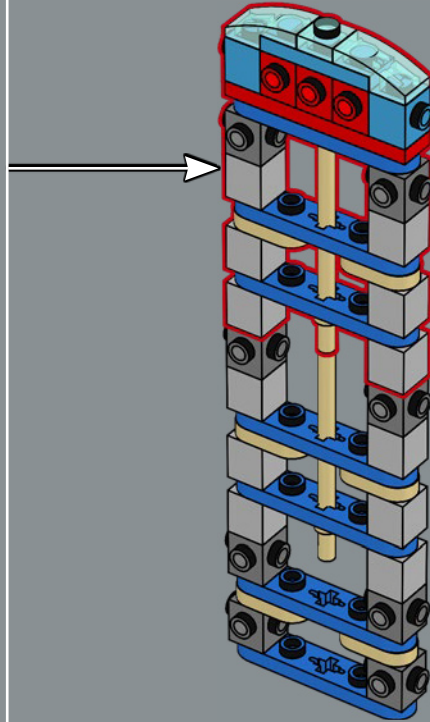

359

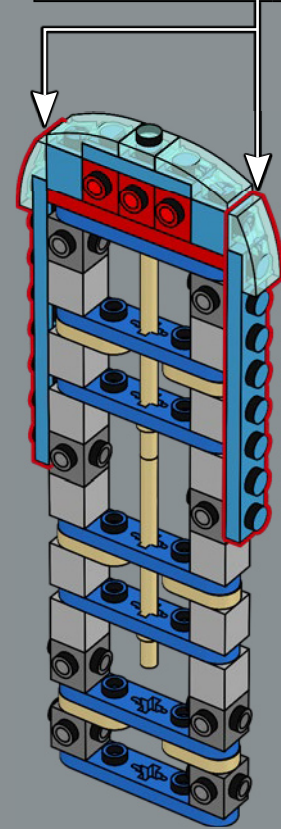
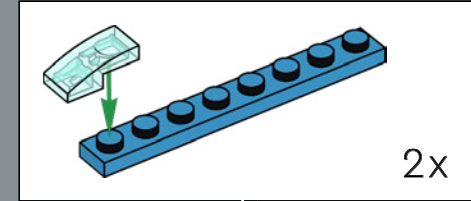

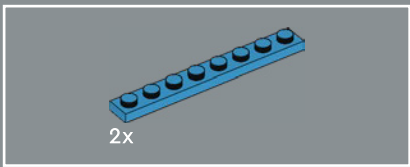

2x

360

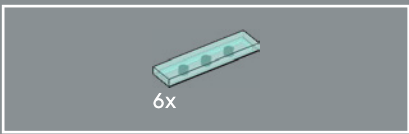
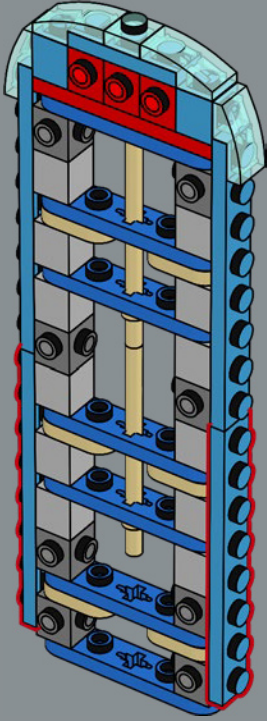

6x

361

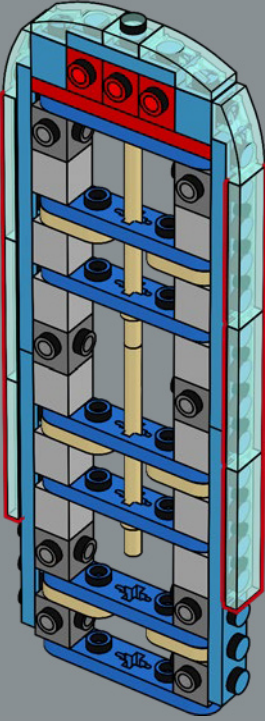

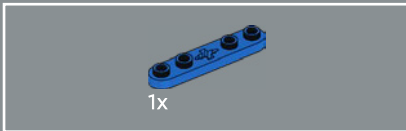
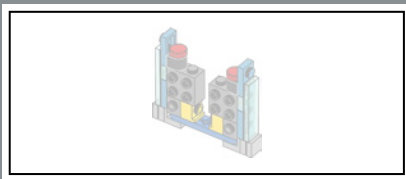

1x

362

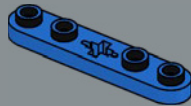

2x

2x

363

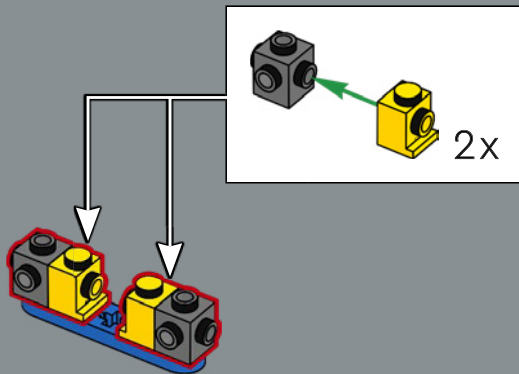

2x



2x

364

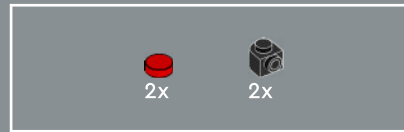
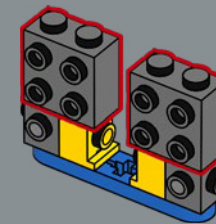

2x

2x

365

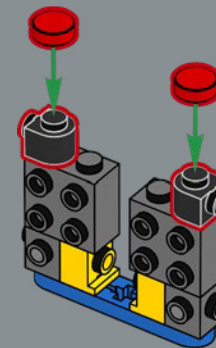

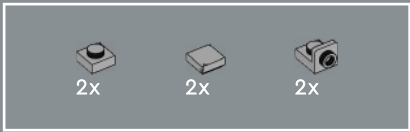

366

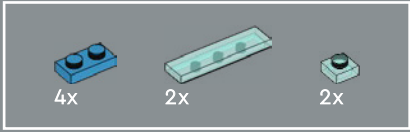
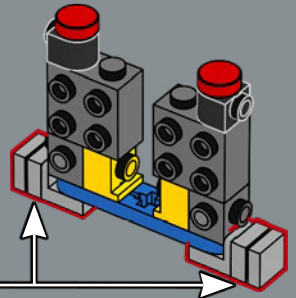
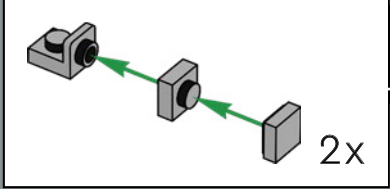

367

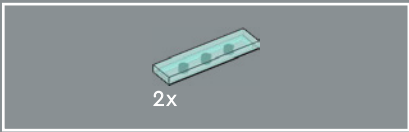
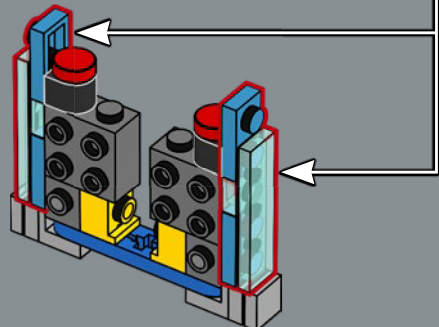
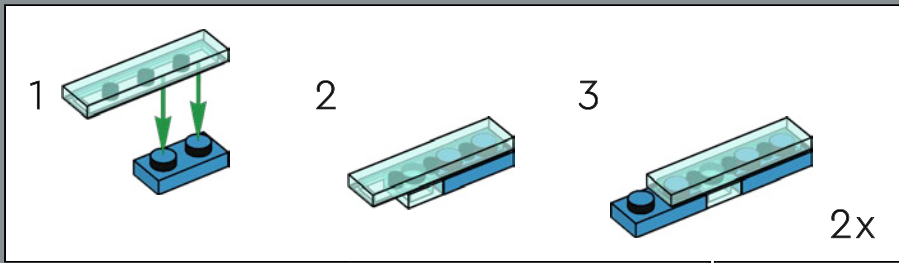

368

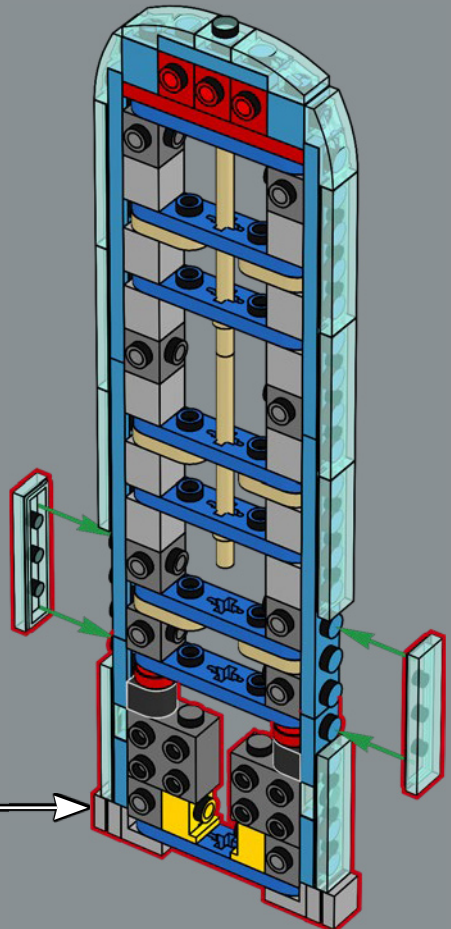

369

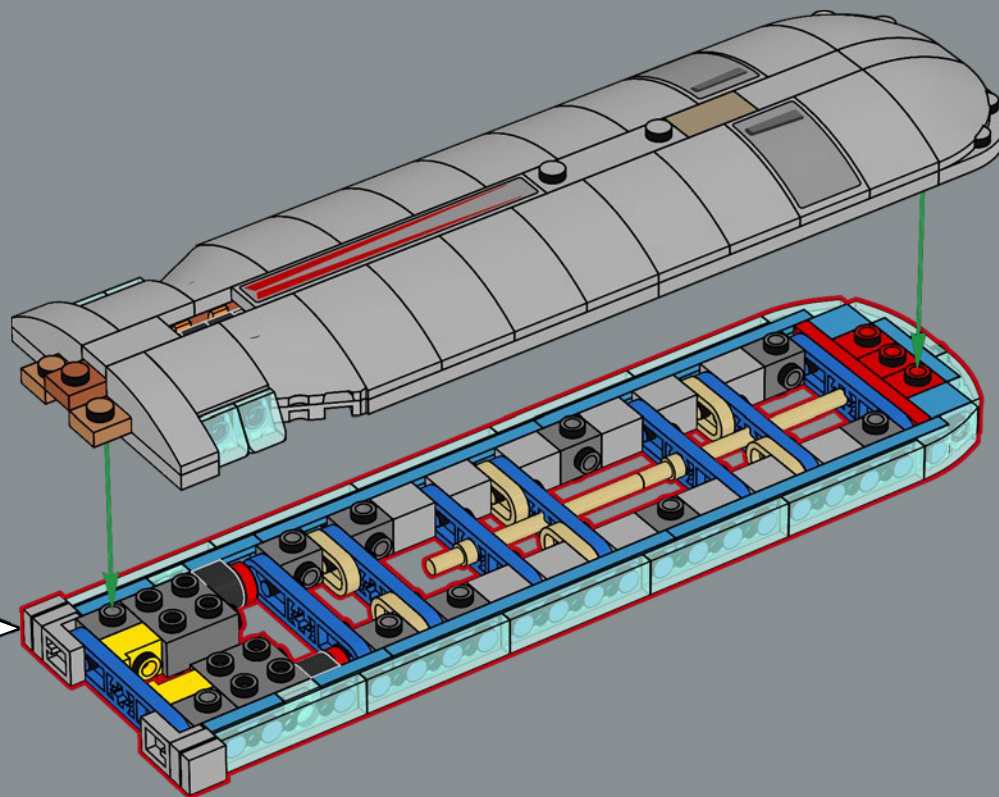

2x



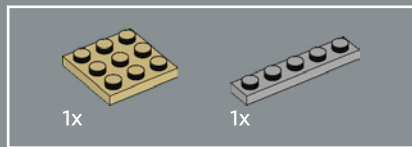
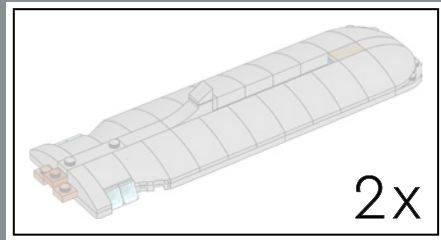

370

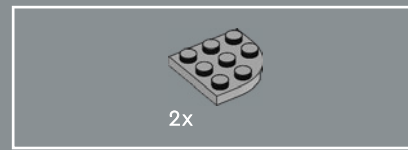
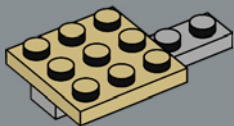

371

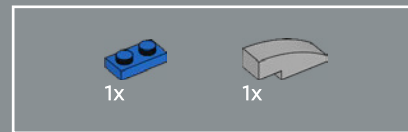
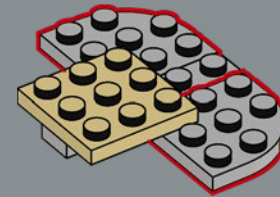

372

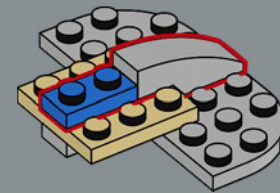

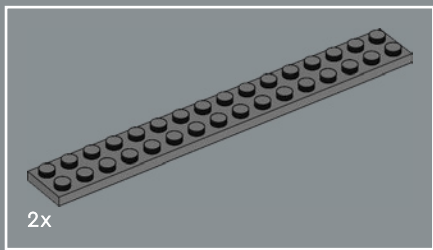

373

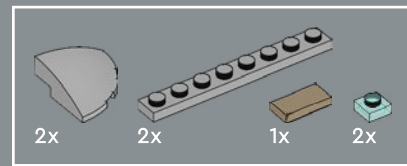
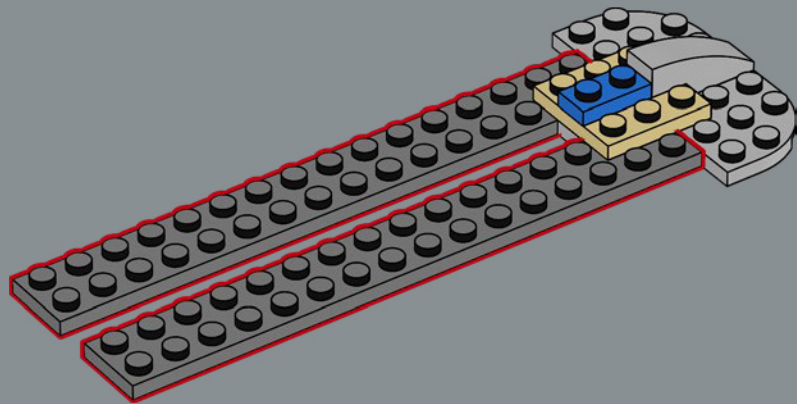

374

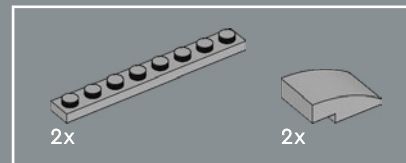
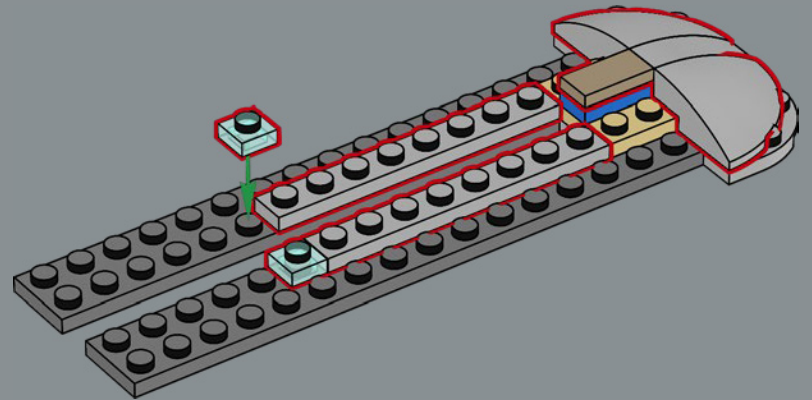

375

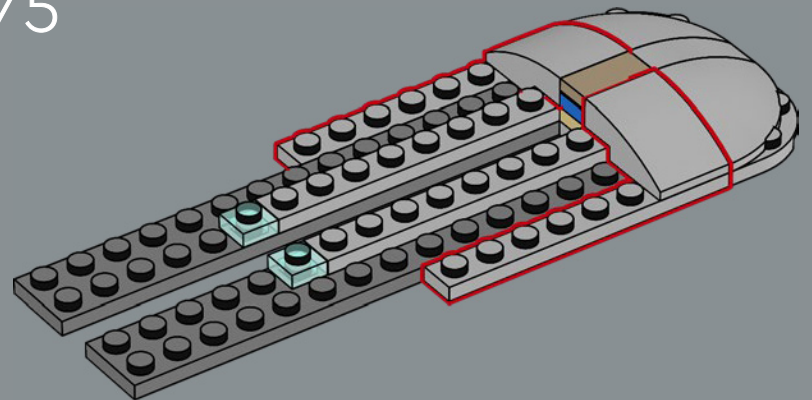

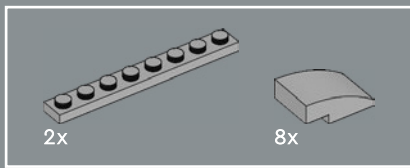

376

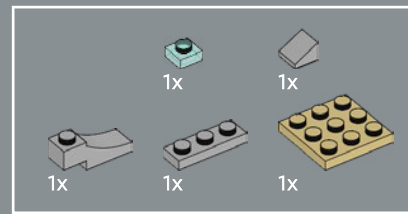
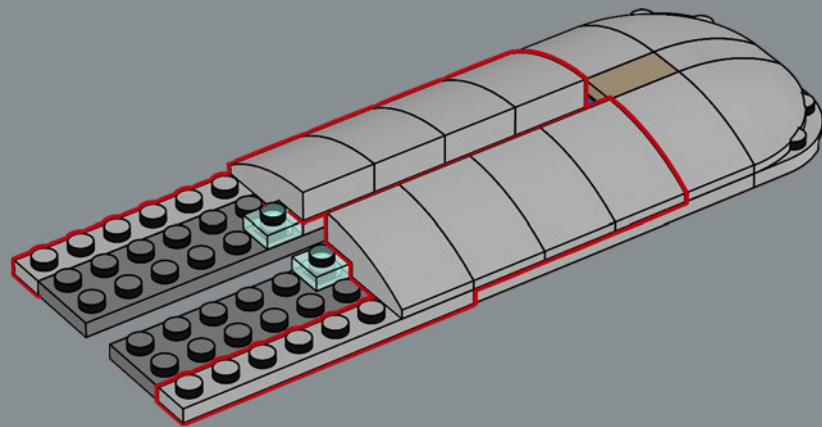

377

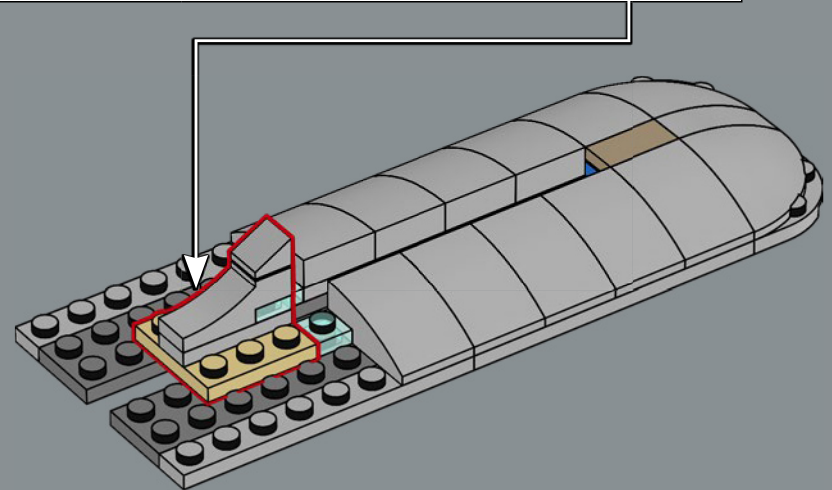
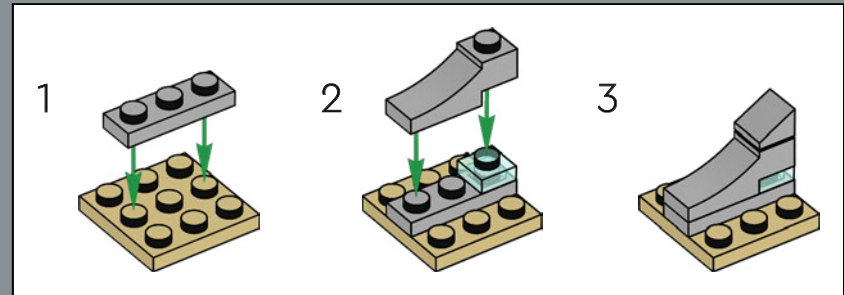

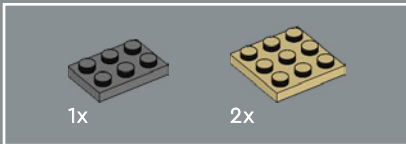
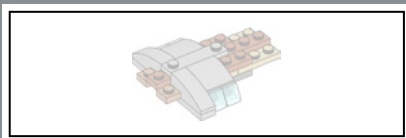

378

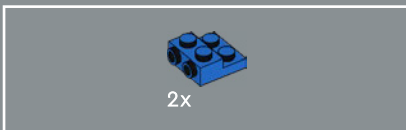
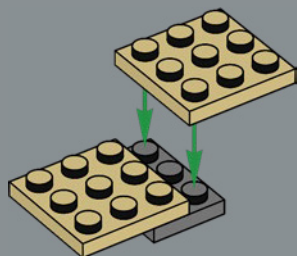

379

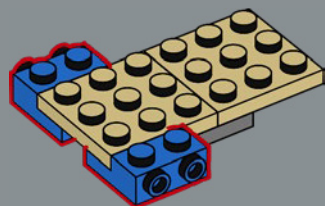

380

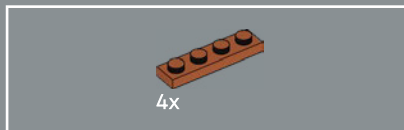
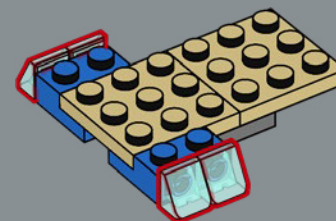

381

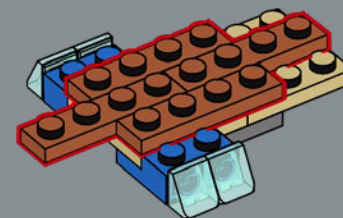

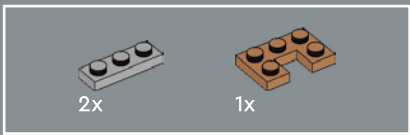

382

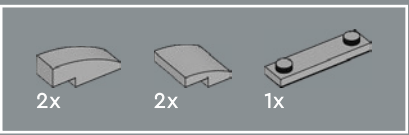
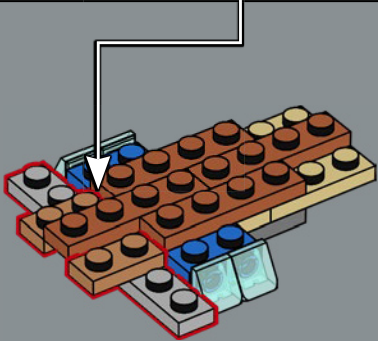
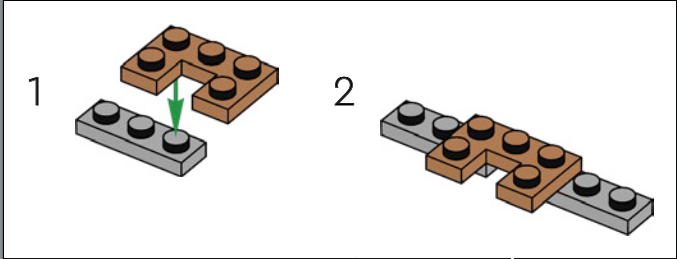

383

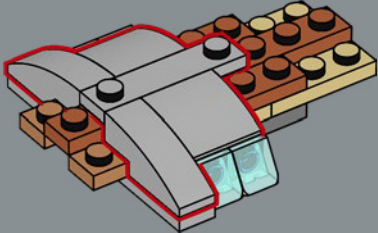

384

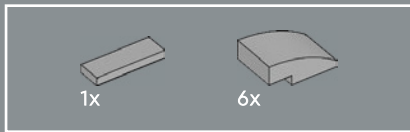
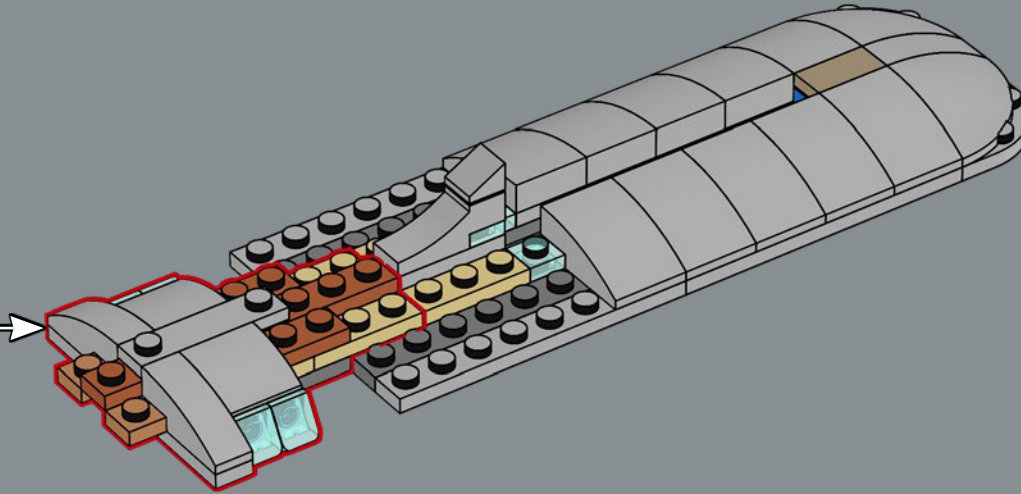

385

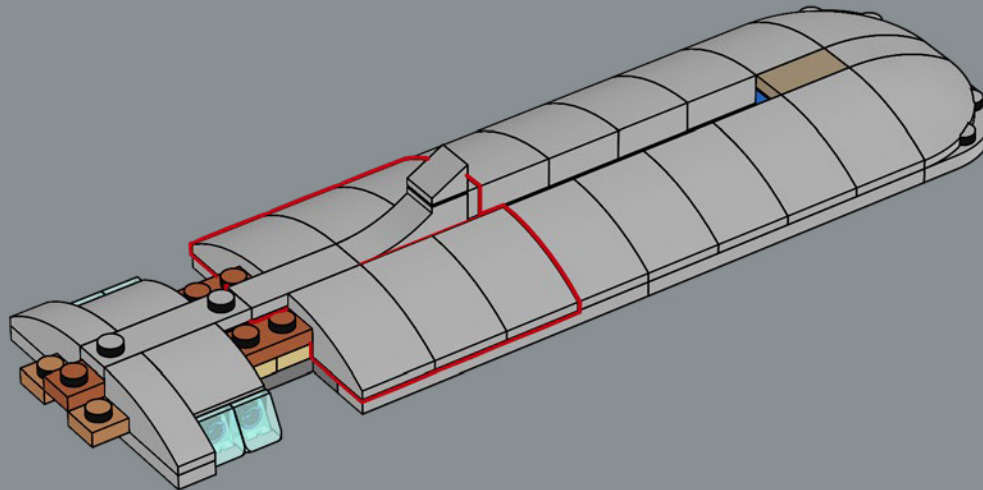

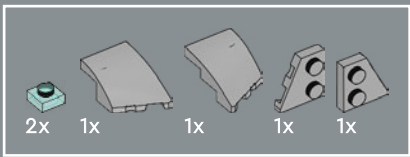

386

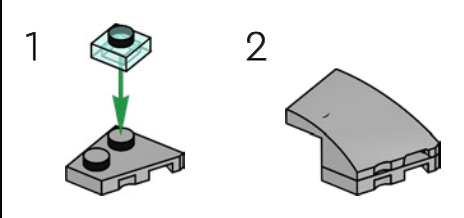
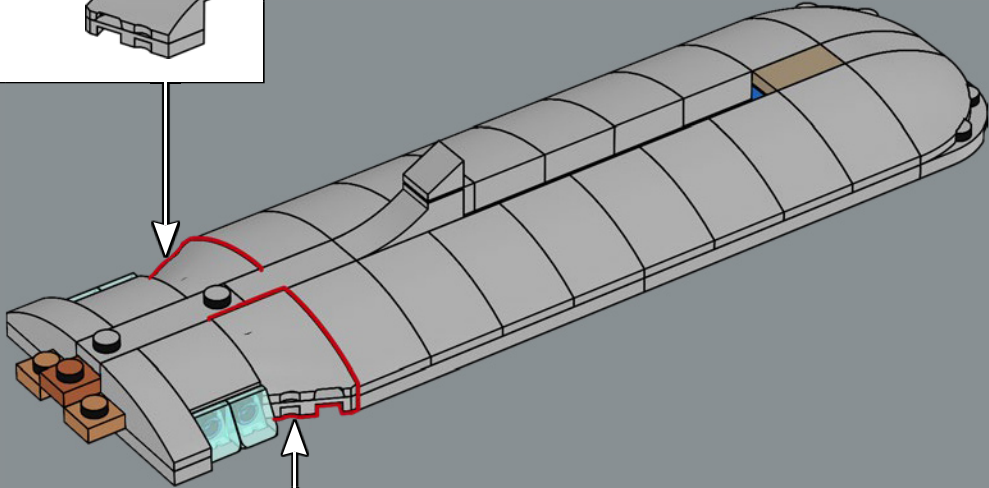
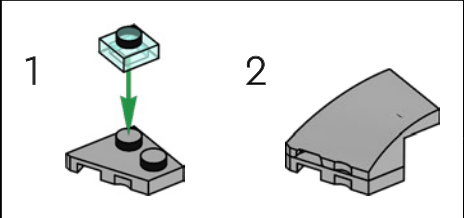

387

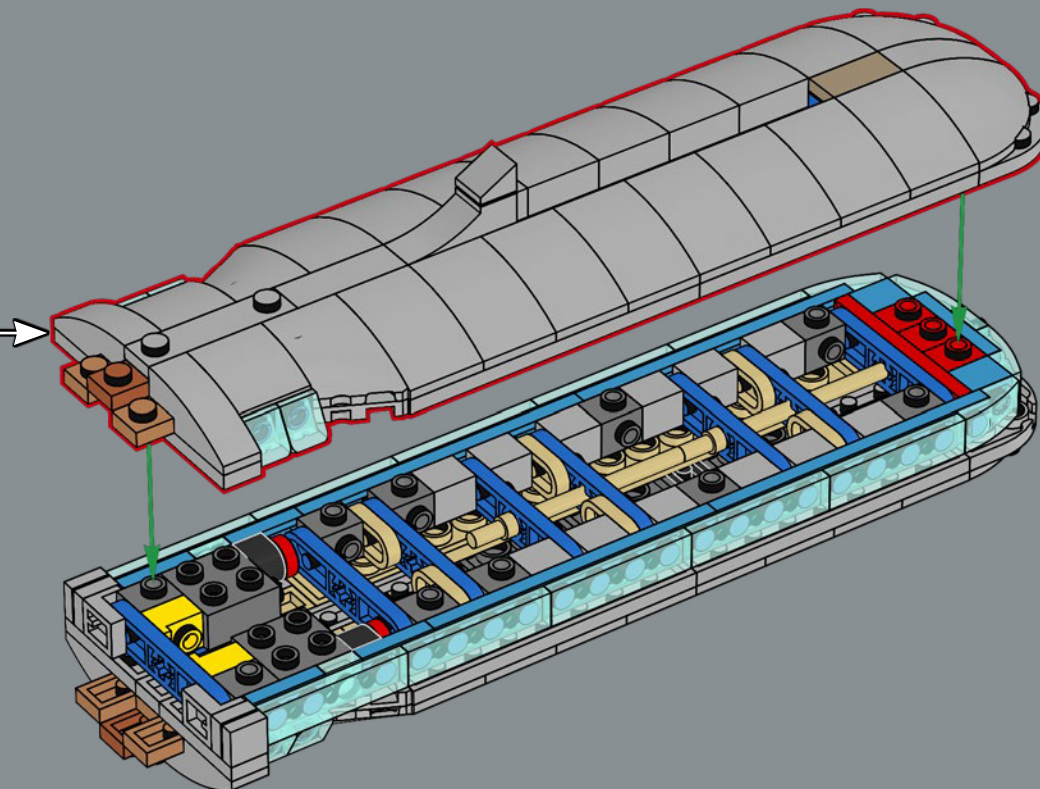

2x



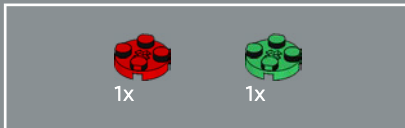
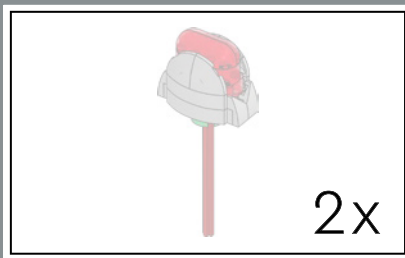

388

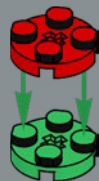

389

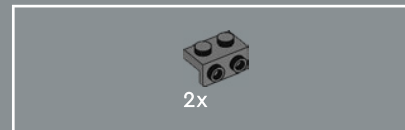

390

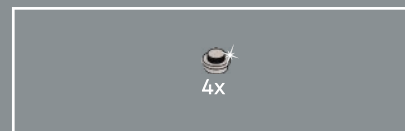
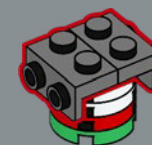

391

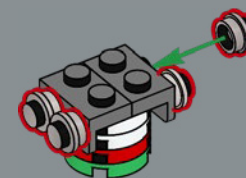



392

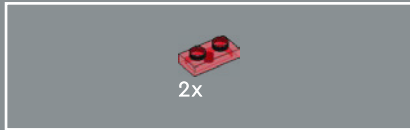
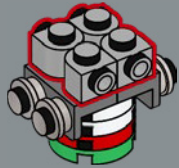

393

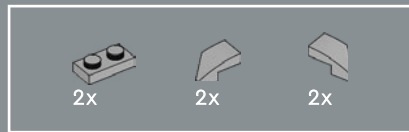
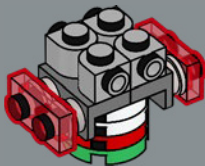

394

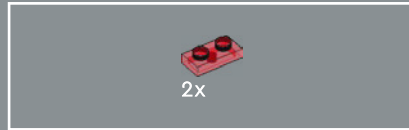
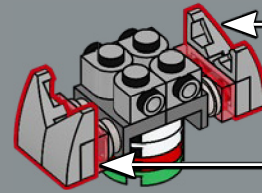
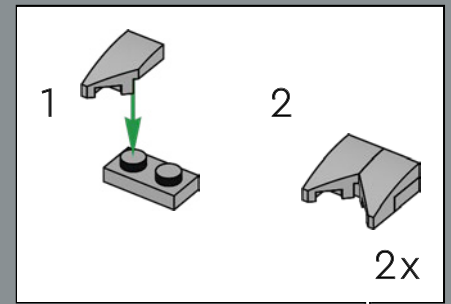

395

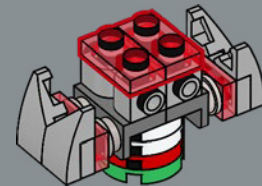



396

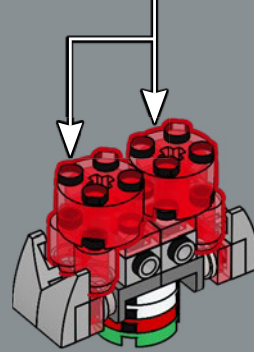
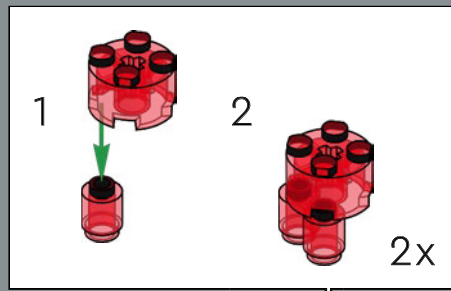

397

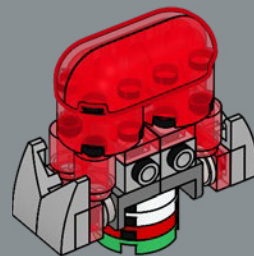

This is the first time that these rounded LEGO® elements have appeared in transparent red, as part of the warp engines' 'glowing' red Bussard collectors.

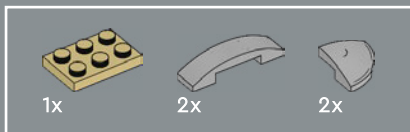

398

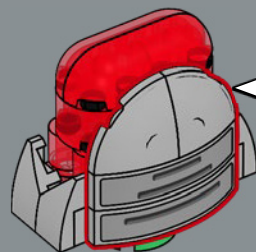
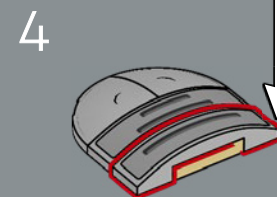
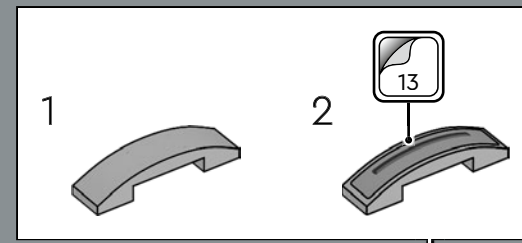
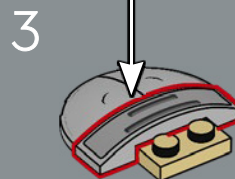
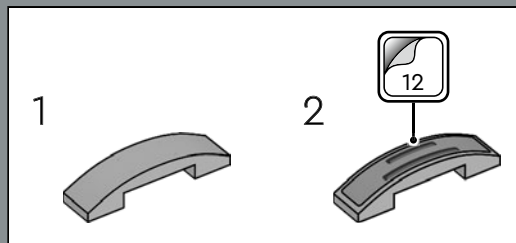
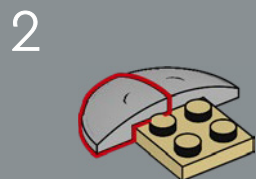
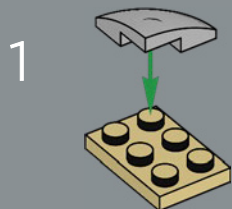

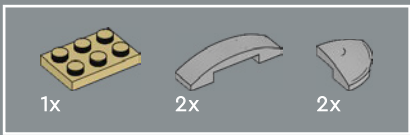

399

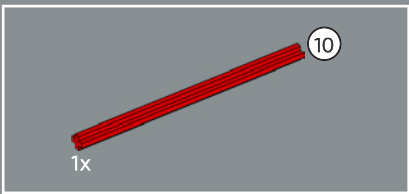
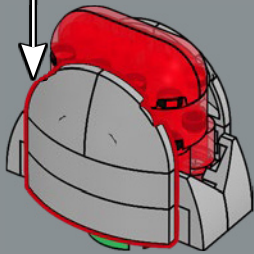
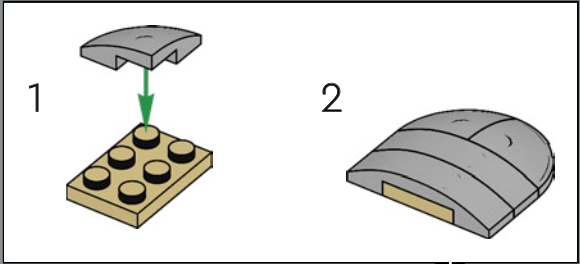

400

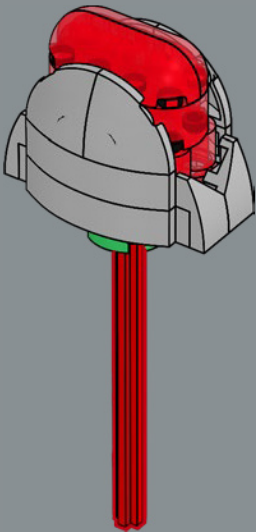

401

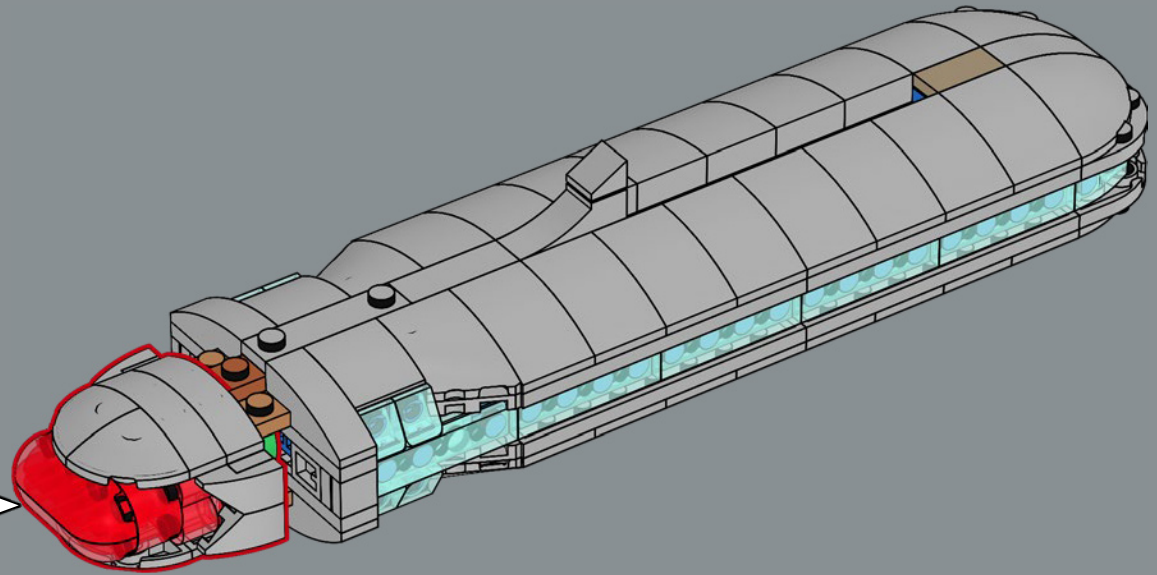

402

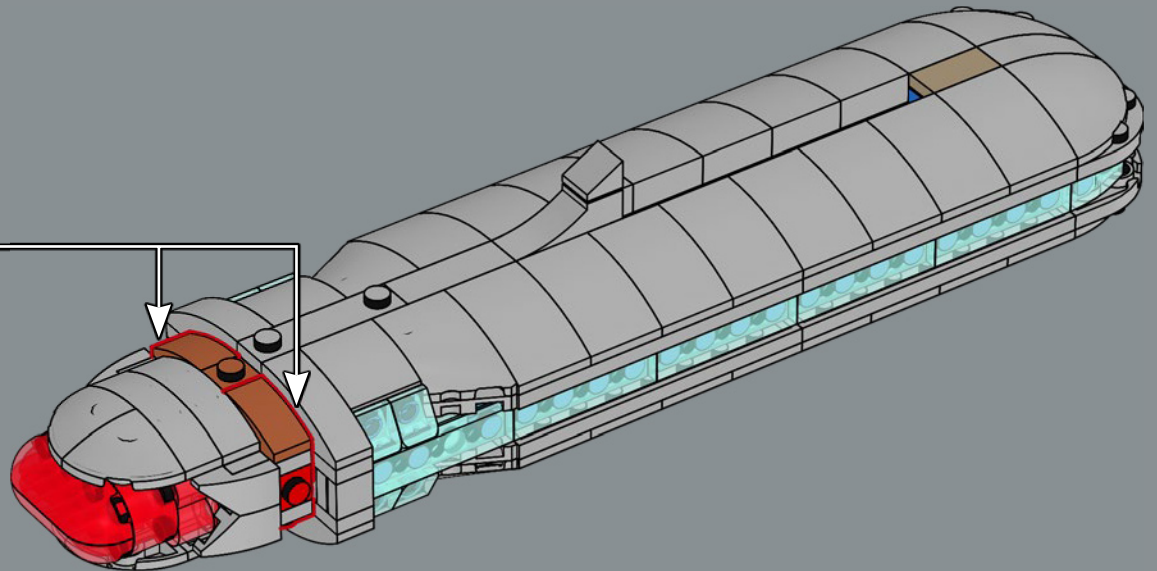
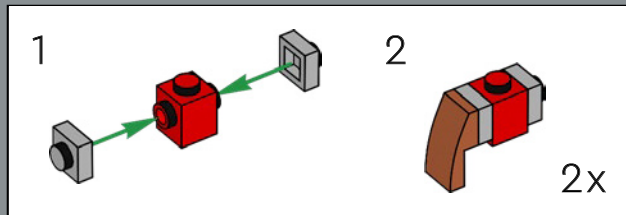

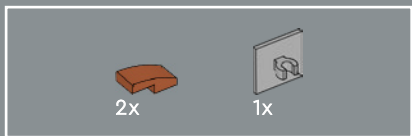

403

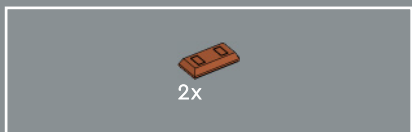
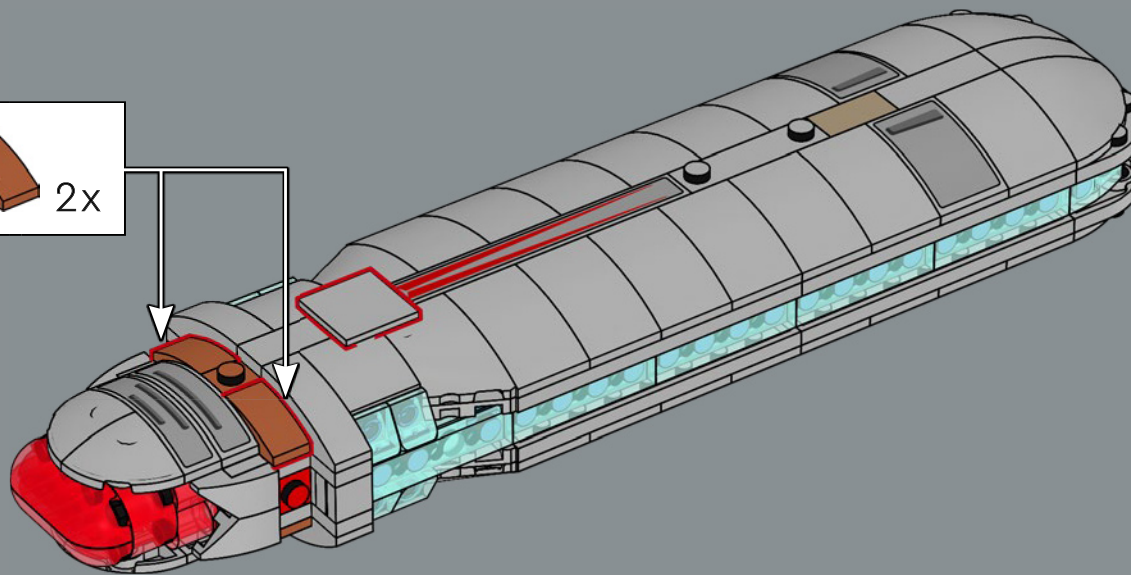

404

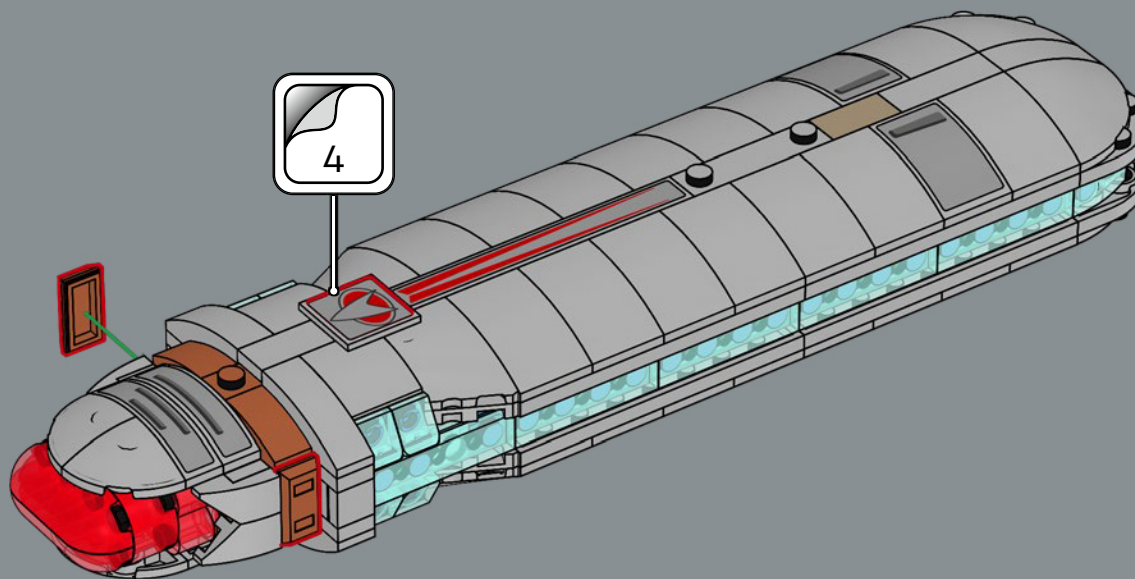

2x

405

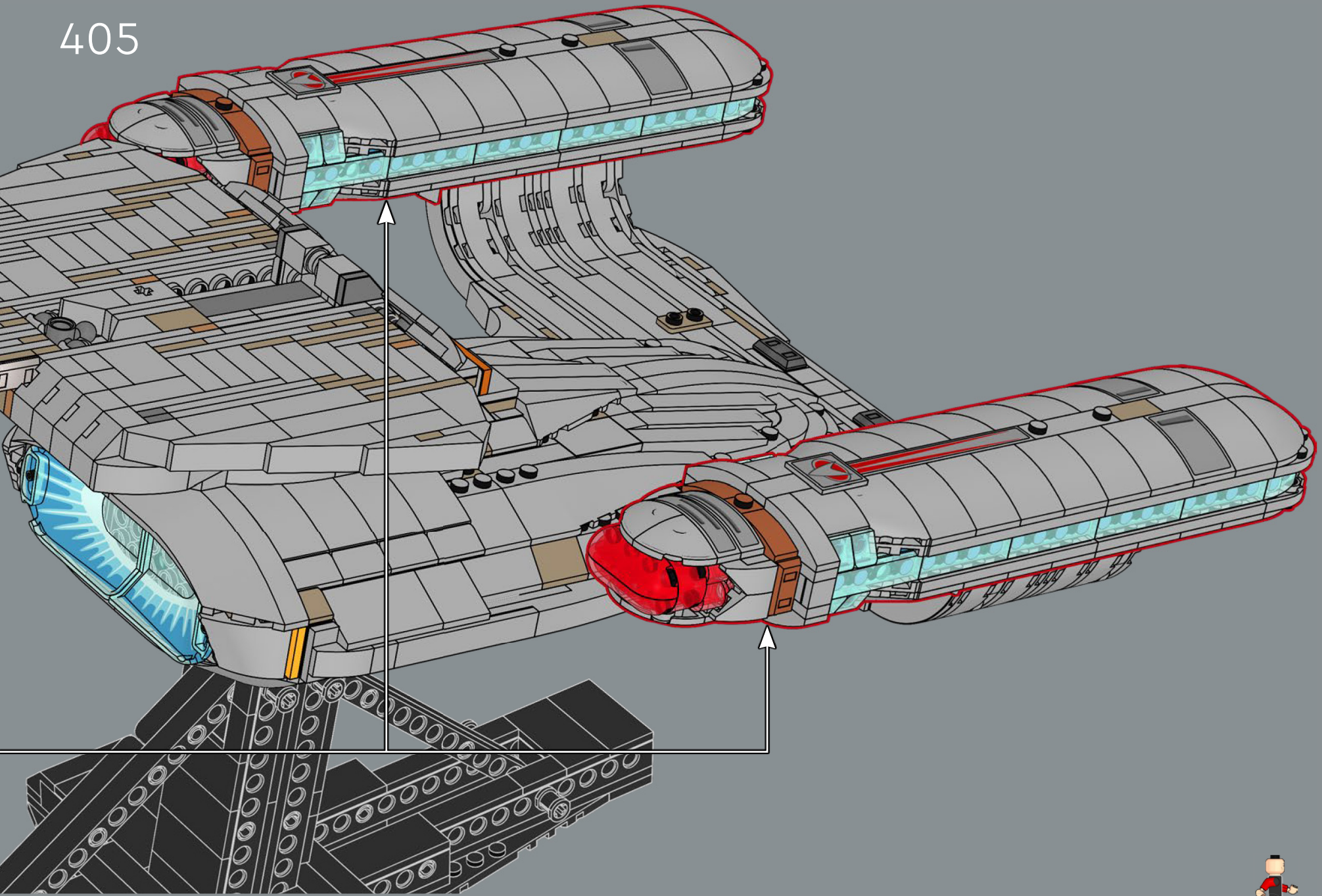

♣ **PROPERTY OF** ♣

U.S.S. ENTERPRISE
NCC-1701-D

LEGO and the LEGO logo are trademarks of the LEGO Group. ©2025 The LEGO Group.
TM & © 2025 CBS Studios Inc. STAR TREK, related marks, logos and designs are trademarks of CBS Studios Inc.
Used under license. All Rights Reserved.