

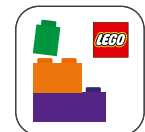

21358



Booklet available in English
Livret disponible en français
Folleto disponible en español



LEGO® Builder

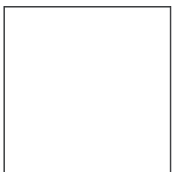



WE'RE MAKING OUR PACKAGING MORE SUSTAINABLE

We're transitioning from single-use plastic to paper-based packaging. As we progress, you may find a mix of paper and plastic in our boxes.

NOUS RENDONS NOS EMBALLAGES PLUS DURABLES

Nous passons des emballages en plastique à usage unique aux emballages à base de papier. Durant la transition, vous pourriez trouver un mélange de papier et de plastique dans nos boîtes.

QUEREMOS HACER MÁS SUSTENTABLES NUESTROS MATERIALES DE EMBALAJE

Estamos cambiando las bolsas de plástico desechables por bolsas con base de papel. Conforme avanzamos en este propósito, puedes encontrar una mezcla de papel y de plástico en nuestras cajas.

LEGO.com/sustainable-packaging



BUILDER



Apple and the Apple logo are trademarks of Apple Inc., registered in the U.S. and other countries and regions. App Store is a service mark of Apple Inc. Google Play and the Google Play logo are trademarks of Google LLC. Tencent and the Tencent logo are trademarks of Tencent Inc.

LEGO.com/devicecheck



LEGO® Builder

MEET THE FAN DESIGNER

Rob Vangansewinkel (LEGO® Ideas name Goosestore) from Belgium is a schoolteacher, a children's book author, and when those careers aren't keeping him on his toes, he makes time for playing basketball games and building LEGO sets:

"As a child, I used to play with LEGO bricks a lot – my favorite theme was Space. After visiting LEGOLAND® in Billund, Denmark, with my son a few years ago, I rediscovered my love of building. To me, it's the perfect way to be creative. And I really like the LEGO Ideas concept that anyone can become a designer. When I was young, I had a small vending machine I enjoyed playing with, and a few years ago, I thought it would be cool to create a LEGO version that dispenses minifigures. At first, my original Minifigure Prize Machine submission gained a lot of support. I had designed it digitally, but I wasn't sure if the dispensing mechanism would work. I decided to build the machine with real bricks. As I suspected, it didn't work properly. So, back to the drawing board I went. Building the final version involved a lot of tinkering and tweaking. In the process, I even dismantled my old vending machine to study the dispensing mechanism. I think I must have tried at least 20 different versions before I got it right! It took almost two years and a lot of promotion on social media before the idea reached 10,000 votes. It was a long journey, and when it became clear that I was going to reach the goal, I was so happy. Then to see it become an actual set for everyone to enjoy, is fantastic. As a fan, it's the closest you can get to your favorite brand! Thanks to everyone who supported the idea!"

Fan designer Rob with his brick-built vending machine.

Rob, le concepteur amateur, avec son distributeur automatique en briques.

El fan diseñador Rob con su máquina expendedora construida con bricks.



RENCONTRE AVEC LE CONCEPTEUR AMATEUR

Rob Vangansewinkel (pseudonyme LEGO® Ideas Goosestore) vit en Belgique. Il est enseignant, auteur de livres pour enfants, et lorsque ces carrières ne le tiennent pas en haleine, il trouve le temps d'aller jouer au basket et de construire des ensembles LEGO :

« Enfant, je jouais beaucoup avec les briques LEGO : mon thème préféré était l'espace. Il y a quelques années, j'ai visité LEGOLAND® à Billund, au Danemark, avec mon fils et j'ai redécouvert ma passion pour la construction. Pour moi, c'est le moyen idéal pour exprimer sa créativité. J'aime beaucoup le concept de LEGO Ideas qui permet à tout le monde de devenir concepteur. Quand j'étais jeune, j'avais un petit distributeur automatique avec lequel j'aimais jouer. Il y a quelques années, je me suis dit que ce serait amusant de créer la version LEGO d'un distributeur à figurines. Au début, mon projet original de distributeur de figurines a reçu beaucoup de soutien. Je l'avais modélisé numériquement, mais n'étais pas certain que son mécanisme fonctionnerait. J'ai alors décidé de construire la machine avec de vraies briques. Comme je le craignais, il ne fonctionnait pas correctement. J'ai donc tout repris du début. Il a fallu beaucoup de bricolage et d'ajustements pour parvenir à la version finale. J'ai même démonté mon vieux distributeur automatique pour étudier son mécanisme de distribution. J'ai dû essayer au moins 20 versions différentes avant d'arriver à un résultat fonctionnel! Il a fallu près de deux ans et beaucoup de promotion sur les réseaux sociaux pour que l'idée atteigne les 10 000 votes. Le parcours a été long, mais j'ai été incroyablement heureux quand j'ai compris que j'allais atteindre l'objectif. Le voir ensuite devenir un véritable ensemble que tout le monde pourrait apprécier a été une expérience fantastique. En tant que passionné, c'est comme cela que l'on peut approcher au plus près notre marque préférée! Merci à tous ceux qui ont soutenu l'idée! »



CONOCE AL FAN DISEÑADOR

Rob Vangansewinkel (conocido en LEGO® Ideas como Goosestore), originario de Bélgica, es maestro de escuela y autor de libros infantiles. Además, cuando esas ocupaciones se lo permiten, se da tiempo para jugar al basquetbol y construir sets LEGO.

"De niño, solía jugar mucho con bricks LEGO. Recuerdo que mi tema favorito era Space. Y después de visitar el Parque LEGOLAND® de Billund (Dinamarca) con mi hijo hace algunos años, redescubrí mi amor por la construcción. Para mí, esta actividad representa la mejor forma de canalizar mi creatividad. También me parece fascinante que cualquiera pueda convertirse en diseñador gracias a LEGO Ideas. Cuando era más joven, tenía una pequeña máquina expendedora con la que me gustaba jugar, y hace unos años se me ocurrió que sería genial crear una versión LEGO que dispensara minifiguras. Lo hice. Mi propuesta original recibió mucho apoyo al principio. Como la había diseñado digitalmente, no estaba muy seguro de si el mecanismo dispensador funcionaría. Por este motivo, decidí construir la máquina con bricks de verdad. Y, como sospechaba, esta no funcionó como debería, así que volví a la mesa de dibujo. La construcción de la versión final requirió innumerables retoques y ajustes. En cierto momento del proceso, incluso desarmé mi antigua máquina expendedora para estudiar el mecanismo dispensador. ¡Diría que probé al menos 20 versiones distintas antes de hacerla funcionar correctamente! Después de casi dos años de promoción constante en redes sociales, la idea alcanzó los esperados 10.000 votos. El viaje fue largo y, cuando se hizo evidente que llegaría al objetivo, me sentí muy feliz. Es fantástico ver tu creación convertirse en un set de verdad que todo el mundo puede disfrutar. Y, como fan, ¡creo que es lo más cerca que puedes estar de tu marca favorita! Agradezco infinitamente a todos los que apoyaron la idea".

Fan-designer Rob created himself as a minifigure and is also represented as a minifigure in the final model.

Le concepteur amateur Rob a créé une figurine à son image et est également représenté sous la forme d'une figurine dans le modèle final.

El fan diseñador Rob creó una minifigura de sí mismo; el modelo final también incluye una representación similar de él.

SMALL MOMENTS OF JOY

The classic, red, round-topped vending machine is a nostalgic fixture that reminds us of carefree moments and simpler times. First invented in the early 1900s, these colorful little machines charmed their way into corner shops, amusement parks, malls and movie theaters worldwide. They offer affordable little knick-knacks and

memorabilia, and you might even have spent your first allowance on a collectable trinket from one of these gleaming globes. There is a tangible simplicity to them. They instantly awaken a playful urge to drop a coin in the slot and turn the crank, as you cross your fingers, wishing for that coveted prize to drop with a satisfying clink! So, what might be the perfect prize to include in a LEGO® vending machine?

PETITS MOMENTS DE JOIE

Le distributeur automatique classique rouge, aux formes rondes, est un appareil empreint de nostalgie qui nous rappelle des moments d'insouciance et une époque où tout semblait plus simple. Inventés au début des années 1900, ces irrésistibles petits appareils colorés ont trouvé leur place dans les boutiques de quartier, les parcs d'attractions, les centres commerciaux et les cinémas du monde entier. Ils proposent des petits bibelots et des souvenirs à petit prix, et vous avez peut-être même dépensé votre premier argent de poche pour acheter une babiole à collectionner dans l'une de ces grosses boules rutilantes. Ils sont d'une simplicité palpable. Ils déclenchent instantanément l'envie, doublée d'une joyeuse impatience, de glisser une pièce dans la fente et de tourner la poignée. On croise alors les doigts, en espérant que l'objet convoité tombe en émettant un tintement réjouissant! Quel pourrait donc être l'objet convoité idéal à glisser dans un distributeur automatique LEGO®?

PEQUEÑOS MOMENTOS DE ALEGRÍA

La clásica máquina expendedora roja con tapa redonda es un nostálgico elemento que nos recuerda momentos libres de preocupaciones y tiempos más sencillos. El encanto de estos coloridos artefactos inventados a principios del siglo XX les abrió espacio en tiendas de barrio, parques de diversiones, centros comerciales y cines de todo el mundo. Ofrecen pequeñas golosinas y recuerdos a precios accesibles, y puede que incluso hayas gastado tu primera mesada en algún objeto coleccionable proveniente de una de estas relucientes esferas. Hay algo inherentemente simple en ellas. Al instante, despiertan el impulso juguetón de dejar caer una moneda por la ranura y girar la palanca, ¡para después esperar con impaciencia a que el deseado premio caiga haciendo un satisfactorio tintineo! ¿Cuál crees que sería el premio ideal para incluir en una máquina expendedora LEGO®?



COLLECT ALL 16

LEGO® minifigures have long delighted and surprised fans of all ages. With help from fans, we designed a unique new selection as prizes in this model. Each has its own story and a matching buddy – including the one of fan designer Rob, whose brick alter ego has teamed up with a creative representation of a LEGO designer. Others are new interpretations of fan favorites from different eras in LEGO history, from LEGO Space, Castle and Pirates, to Paradisa and FABULAND® (meet Bernard Bear and Ernie Elephant). We invited fans to vote for their favorite Space and Castle minifigure designs on the LEGO Ideas platform, and the poll became so popular that we decided to make both the winner and the runner-up for each!

COLLECTIONNEZ LES 16 FIGURINES

Depuis longtemps, les figurines LEGO® ravissent et surprennent les passionnés de tous âges. Avec l'aide d'amateurs, nous avons conçu une nouvelle sélection unique à intégrer dans ce modèle. Chacune a sa propre histoire et un copain assorti, même celle de Rob, le concepteur amateur, dont l'alter ego en brique s'est associé à la représentation créative d'un concepteur LEGO. Les autres figurines sont de nouvelles interprétations des personnages que les amateurs ont préférés au fil des différentes époques de l'histoire LEGO, de LEGO Space, Castle et Pirates, à Paradisa et FABULAND® (faites connaissance avec l'ours Bernard et l'éléphant Ernie). Nous avons invité les amateurs à voter pour leurs figurines Space and Castle préférées sur la plateforme LEGO Ideas, et le sondage est devenu si populaire que nous avons décidé de créer le gagnant et la deuxième place pour chacune des thématiques!

COLECCIONA LAS 16

Por un largo tiempo, las minifiguras LEGO® han sorprendido y deleitado a fans de todas las edades. Con ayuda de los fans, diseñamos una nueva y exclusiva selección de ellas como premios para este modelo. Cada una tiene su propia historia y un compañero que la complementa, incluida la del fan diseñador Rob, cuya versión de bricks hace equipo con una representación creativa de un diseñador de LEGO. El resto son nuevas interpretaciones de personajes que se ganaron el corazón de los fans en el apogeo de distintos temas de la historia de LEGO como LEGO Space, Castle, Pirates o Paradisa, e incluso FABULAND® (¿conocías a Bernard Bear y Ernie Elephant?). Lanzamos una invitación a los fans para que votaran por sus diseños de minifiguras favoritos inspirados en los temas Space y Castle a través de la plataforma LEGO Ideas y, debido a la impresionante popularidad que adquirió la encuesta, ¡decidimos producir tanto al ganador como al segundo lugar de cada categoría!



FROM THE LEGO® IDEAS TEAM

Rob's model was straightforward; turn the dial, and a capsule would move through the machine and slide out of the front gate. We wanted to see if we could add a coin slot – a standard vending machine feature. Complex functions are tricky, but the team took on the challenge! We created a prototype mechanism that required the insertion of a 'coin' (a 2x2 round tile stack). Then we streamlined the mechanism and developed the model around it. The final model works similarly to real vending machines. When the dial is turned, a platter with a triangular opening (think of it as a pie with a missing piece) rotates. A capsule then drops into that opening and is pushed to a slide that leads to the front of the machine.

One of the biggest challenges was developing a system that allowed the capsules to drop reliably and move through the machine without getting stuck. Capsules would get caught pressing against each other and preventing them from traveling through the machine. We tested solutions with half-sphere elements for the capsules, but the indents and outdents on these elements would get locked together. So, we ended up designing new elements to help the capsules move smoothly through the machine. Finally, we reduced the height of the chamber ramp to bring the model closer to Rob's original vision and maintain the authentic proportions of a classic vending machine. We hope you enjoy the result!

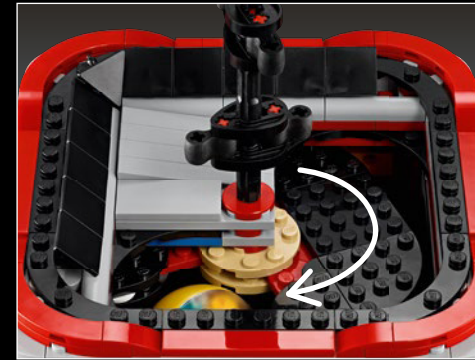
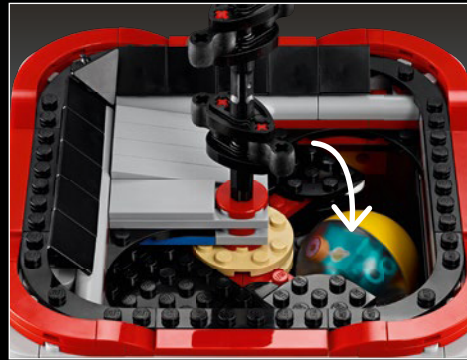
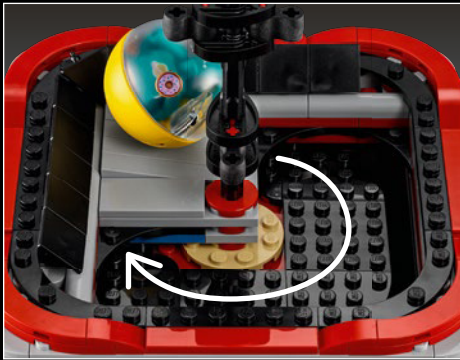

UN MOT DE L'ÉQUIPE LEGO® IDEAS

Le modèle de Rob était simple : il suffisait de tourner la poignée pour qu'une capsule se déplace dans la machine et glisse dans l'ouverture. Nous voulions voir si nous pouvions ajouter une fente pour glisser une pièce, une fonctionnalité standard sur les distributeurs automatiques. Les fonctions complexes sont délicates, mais l'équipe a relevé le défi! Nous avons créé le prototype d'un mécanisme qui nécessitait l'insertion d'une « pièce de monnaie » (une pile de tuiles rondes de 2x2). Nous avons ensuite perfectionné le mécanisme et développé le modèle autour de celui-ci. Le modèle final fonctionne comme un véritable distributeur automatique. En faisant tourner la poignée, vous faites tourner un plateau présentant une ouverture triangulaire (imaginez une tarte, dont il manque une part). Une capsule tombe ensuite dans cette ouverture, puis elle est poussée vers un glissoire qui l'emmène sur le devant de la machine.

L'un des plus grands défis a été de mettre au point un système qui permette aux capsules de tomber de façon fiable et de se déplacer dans la machine sans se coincer. Les capsules se coinçaient en se poussant les unes les autres, ce qui les empêchait de suivre leur circuit dans la machine. Nous avons testé des solutions en utilisant des éléments en demi-sphère pour les capsules, mais les creux et les tenons de ces éléments s'accrochaient les uns aux autres. Nous avons donc fini par concevoir de nouveaux éléments pour aider les capsules à se déplacer sans problème dans la machine. Pour terminer, nous avons réduit la hauteur de la rampe pour que le modèle ressemble plus à la vision originale de Rob et conservé les proportions authentiques d'un distributeur automatique classique. Nous espérons que vous apprécierez le résultat!

IMPRESIONES DEL EQUIPO DE LEGO® IDEAS

La idea de la propuesta de Rob era bastante directa: girar la palanca para hacer que una cápsula cayera por la máquina hasta llegar al compartimiento de entrega, protegido por una tapa abatible. Decidimos explorar la posibilidad de agregarle un monedero, que es una función esencial de las máquinas expendedoras de verdad. Y aunque nunca es fácil recrear funciones complejas, ¡el equipo aceptó el desafío de inmediato! Creamos el prototipo de un mecanismo que requería la inserción de una "moneda" (un conjunto de cubiertas redondas 2x2 apiladas). Luego de perfeccionarlo, diseñamos el resto del modelo en torno a él. La versión final funciona de forma muy parecida a las máquinas expendedoras del mundo real. La palanca hace girar una bandeja con una abertura triangular (puedes imaginarla como un pastel al que le falta una rebanada). Una cápsula cae cuando la abertura pasa por debajo de ella, y luego esta la empuja hacia un conducto que la lleva al frente de la máquina por acción de la gravedad.

Uno de los mayores desafíos fue desarrollar un sistema confiable que permitiera caer y avanzar por la máquina a las cápsulas, porque estas tendían a presionarse unas contra otras y quedarse atrapadas. Probamos soluciones con elementos semiesféricos para las cápsulas, pero estos presentaban irregularidades en la superficie que se enganchaban entre sí. Por este motivo, terminamos por diseñar nuevos elementos que permitieran a las cápsulas avanzar sin problemas por la máquina. Por último, redujimos la altura de la rampa de la cámara para acercar el modelo a la visión original de Rob y mantener las proporciones fieles a las de una máquina expendedora clásica. ¡Esperamos que disfrutes del resultado!



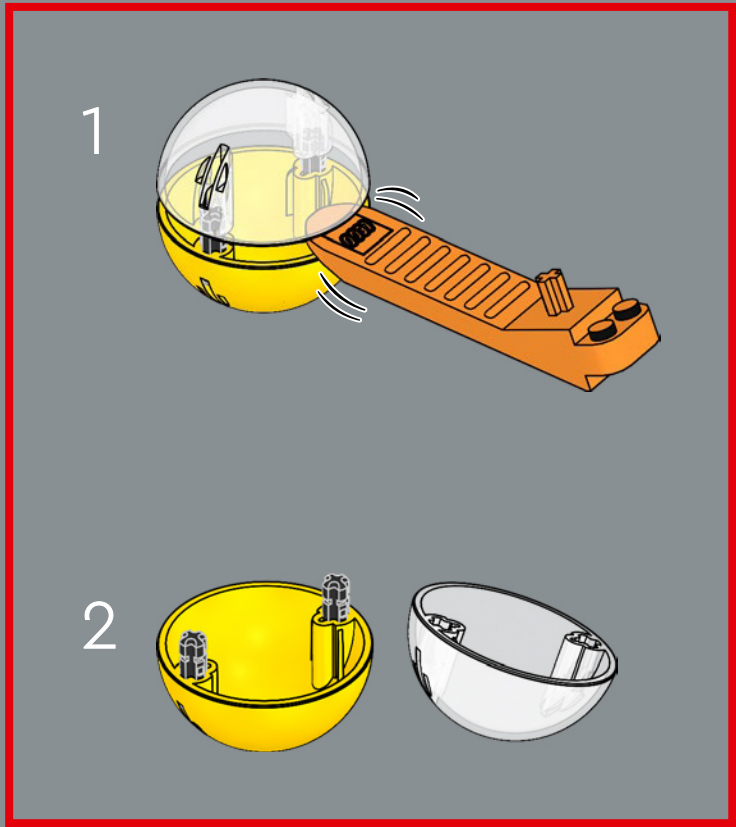
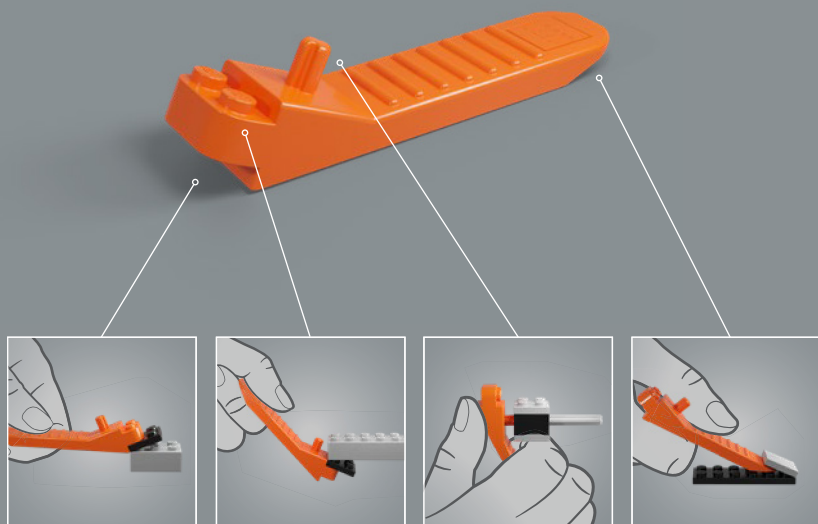

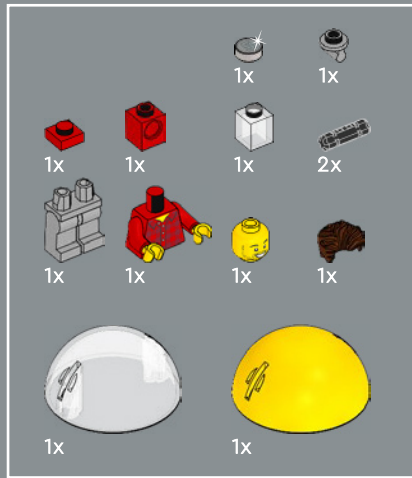
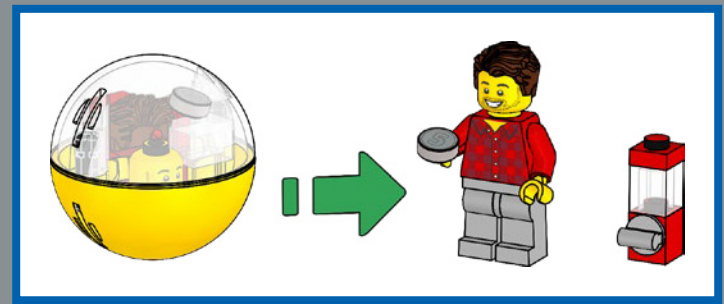

1

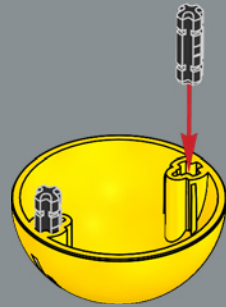

2



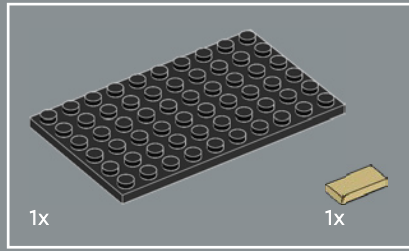
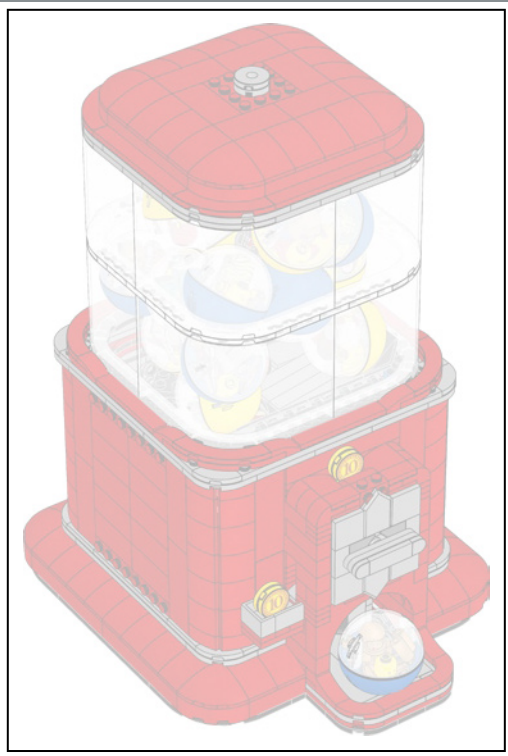

1

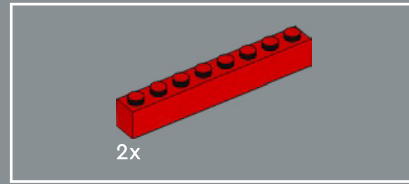
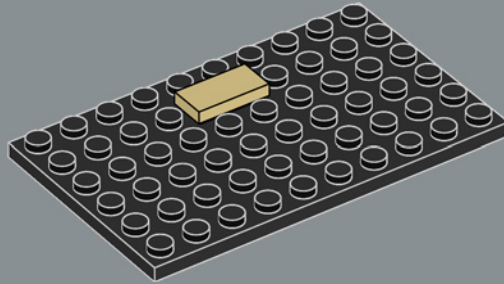

2

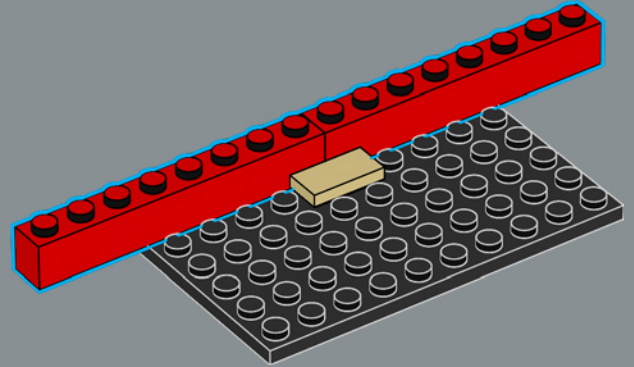

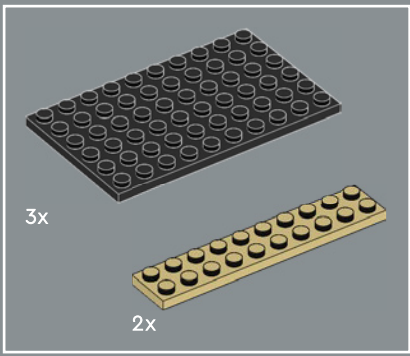

5

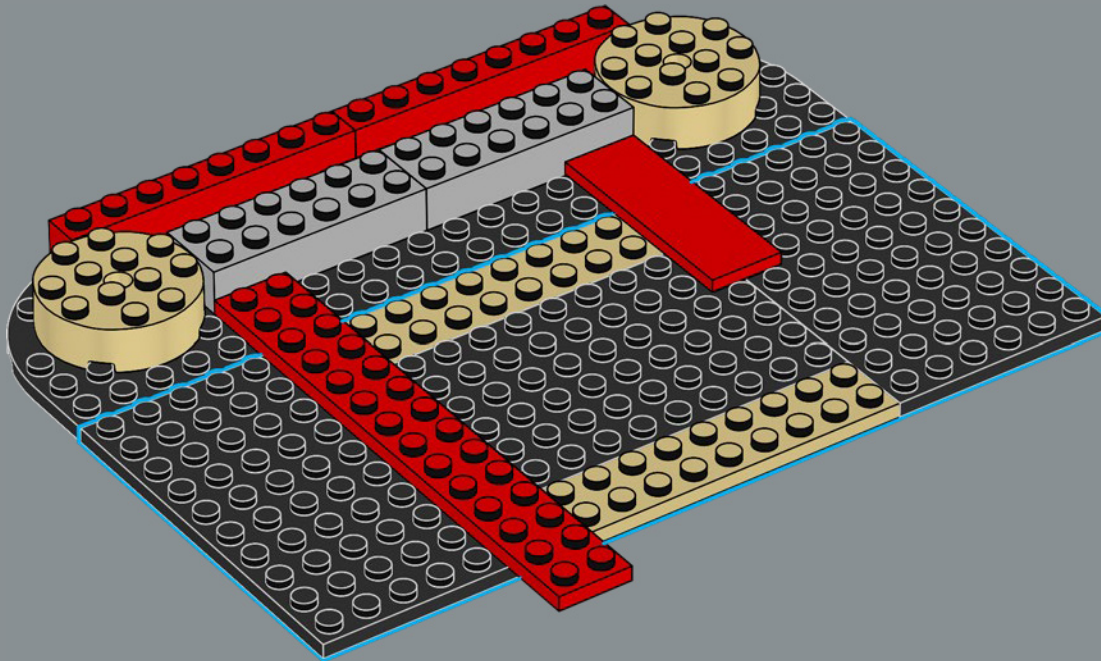

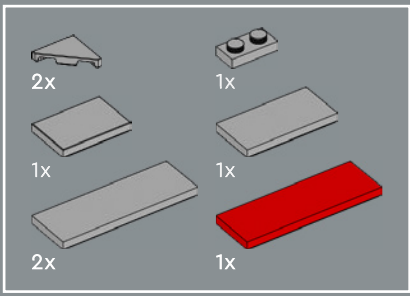

7

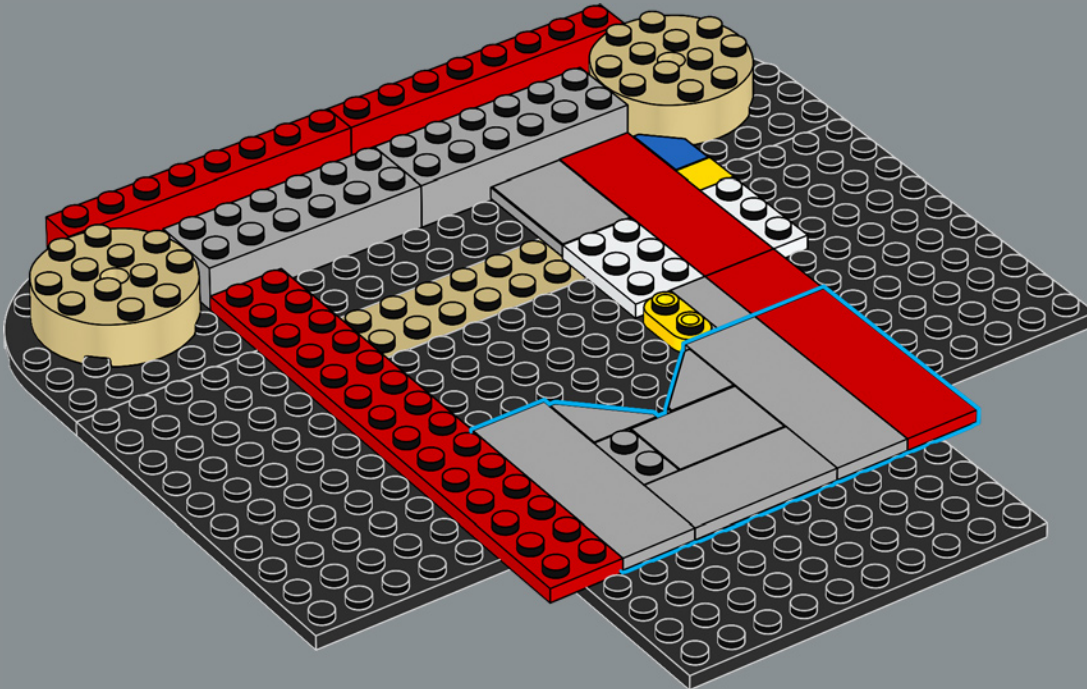

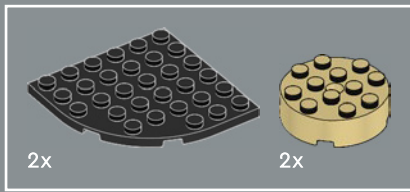

8

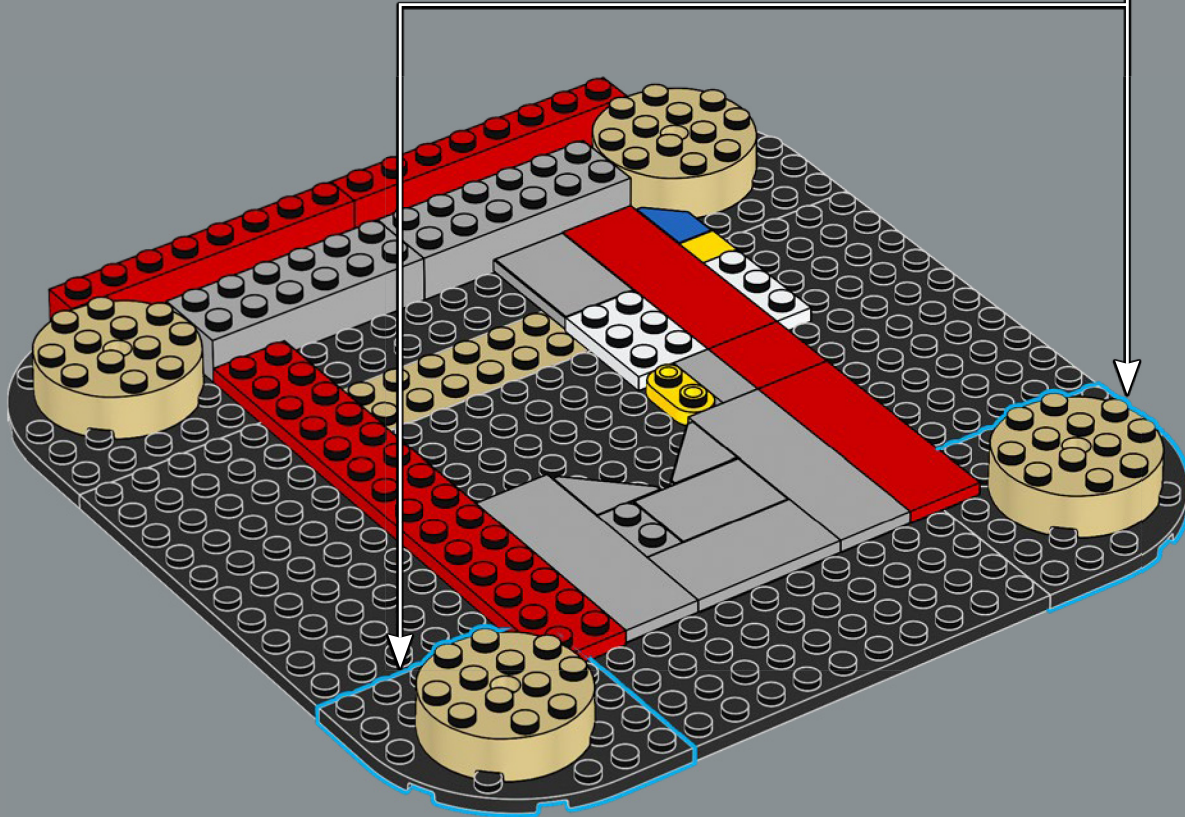
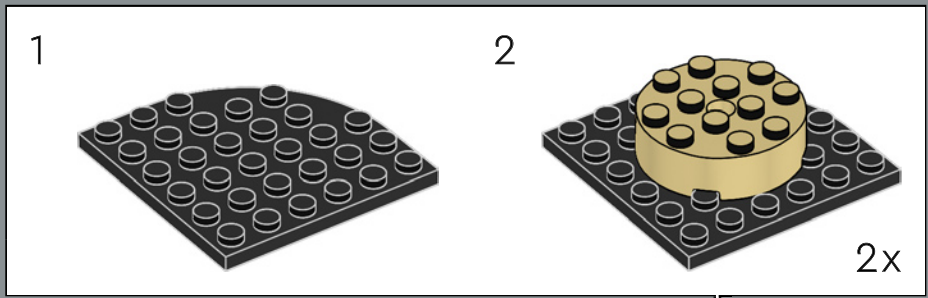

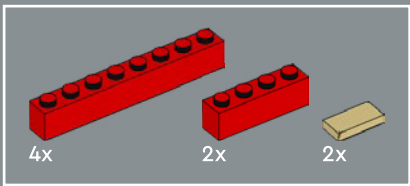

9

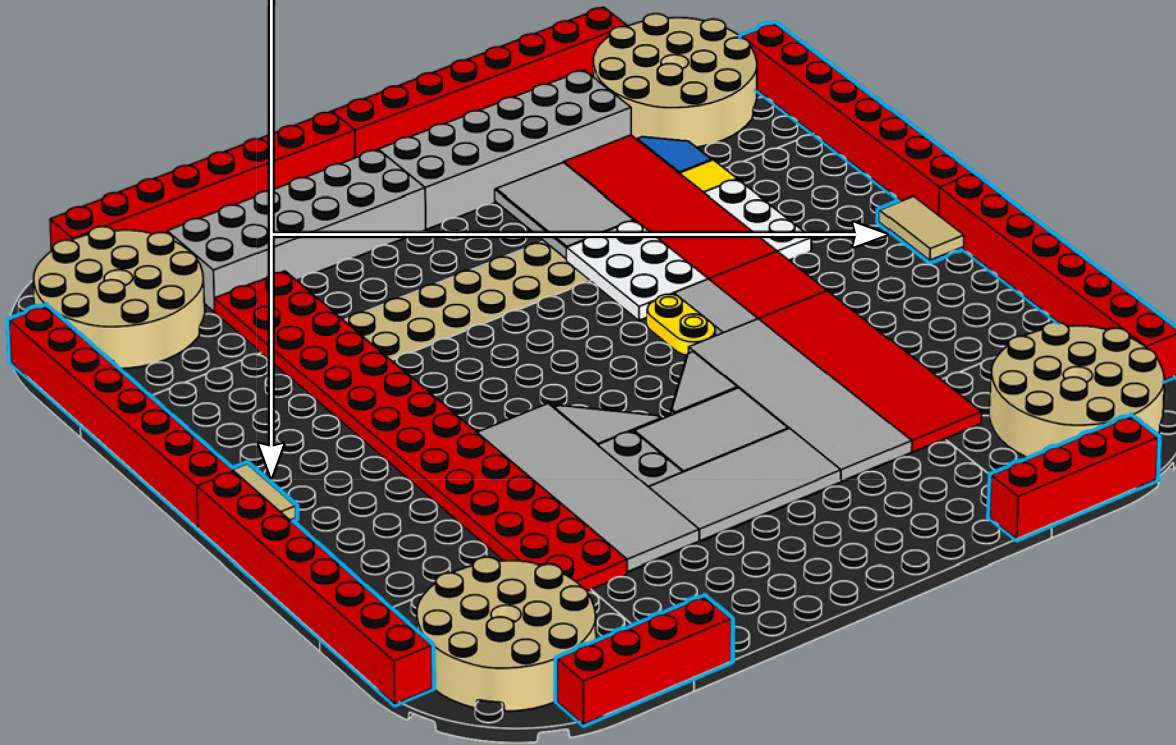
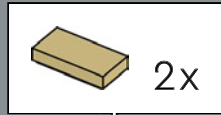

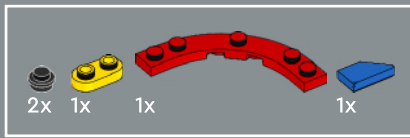

10

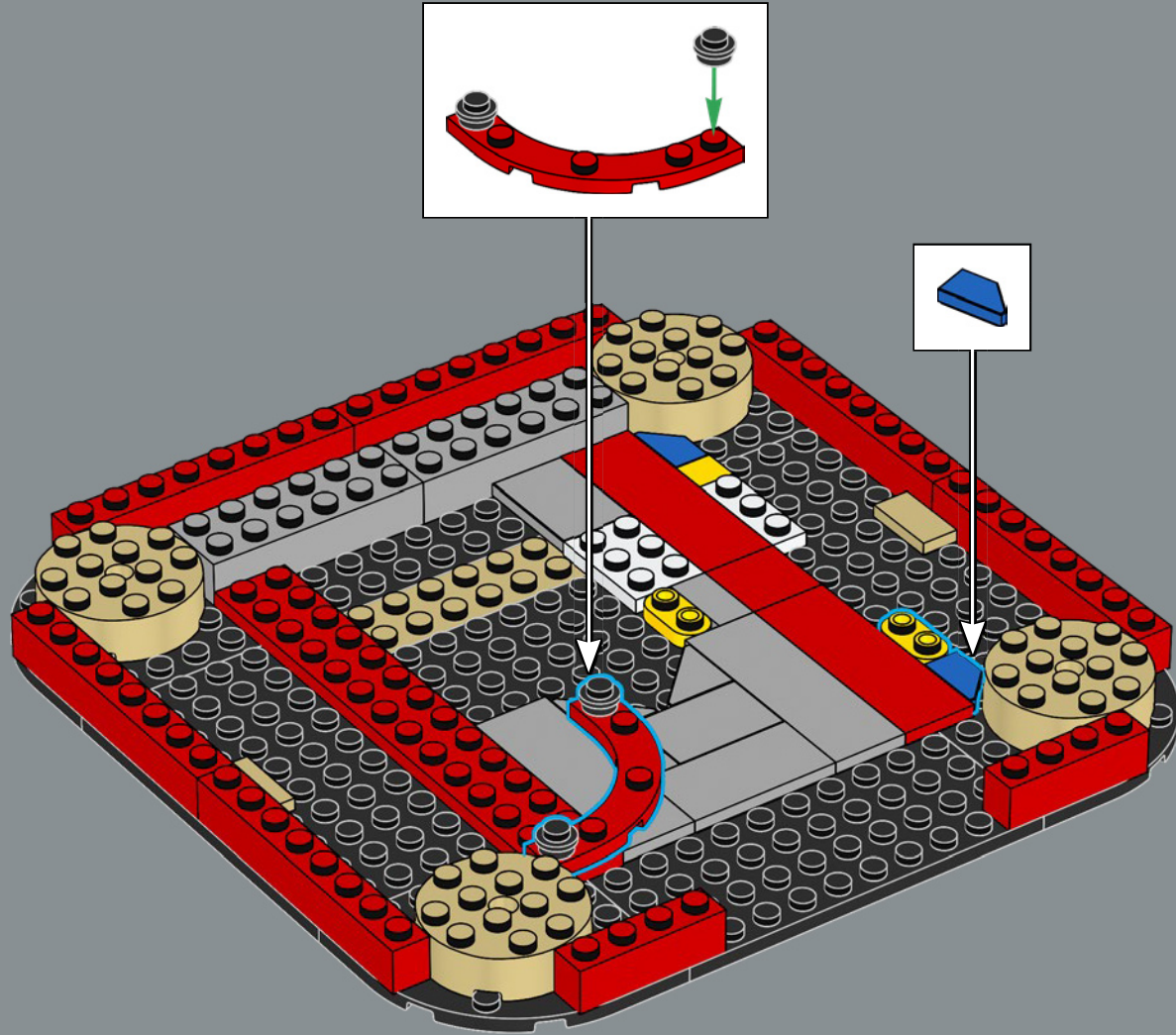

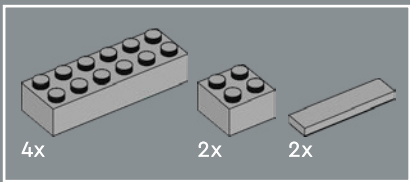

11

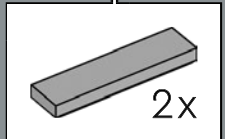
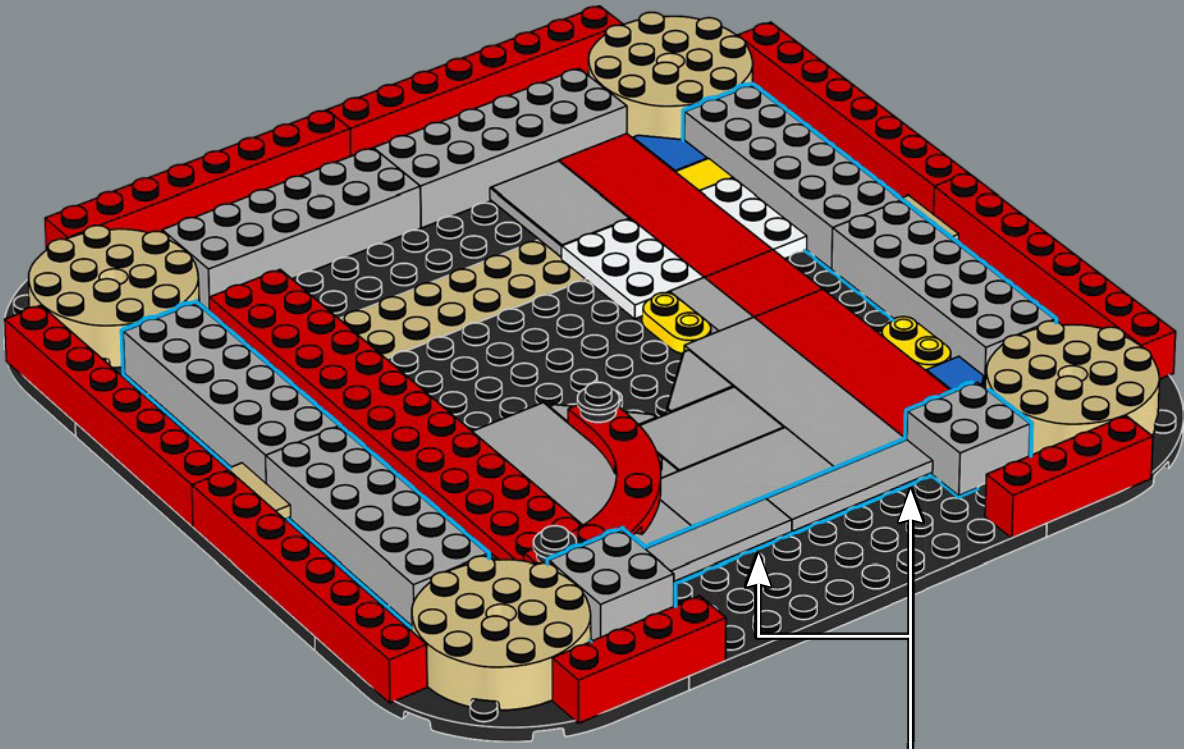

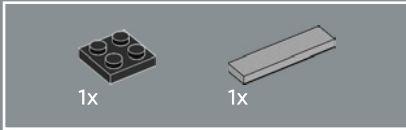
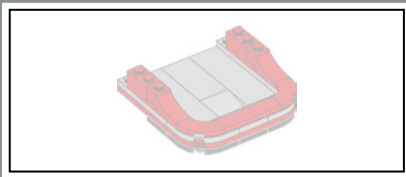

12

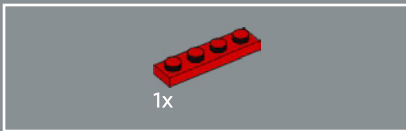
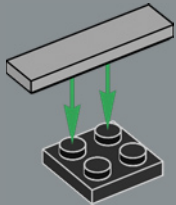

13

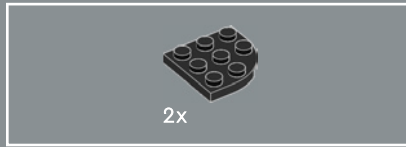
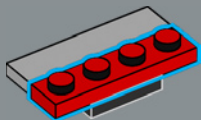

14

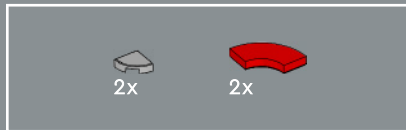
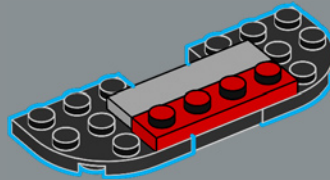

15

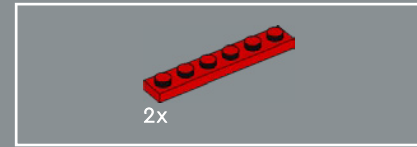
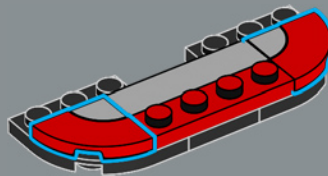

16

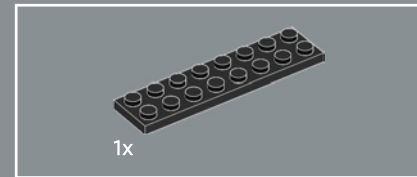
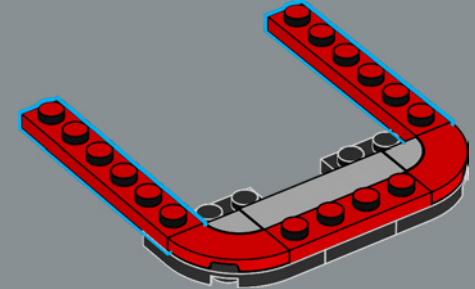

17

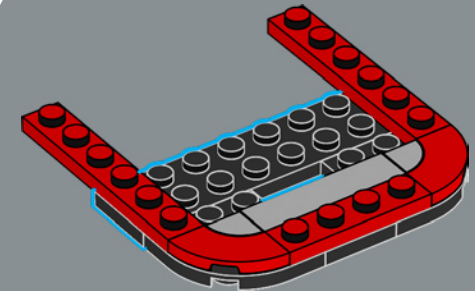

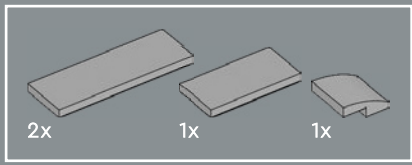

18

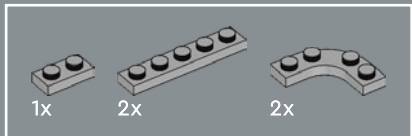
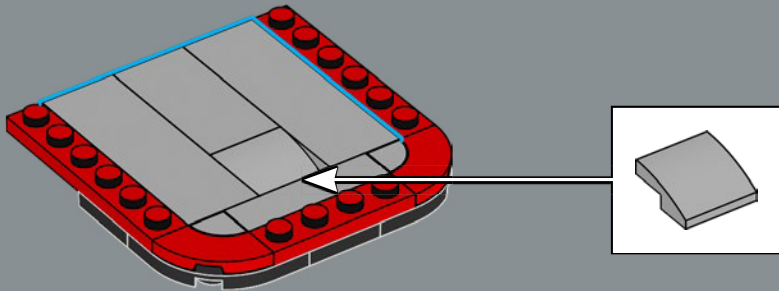

19

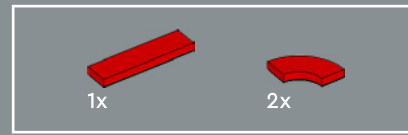
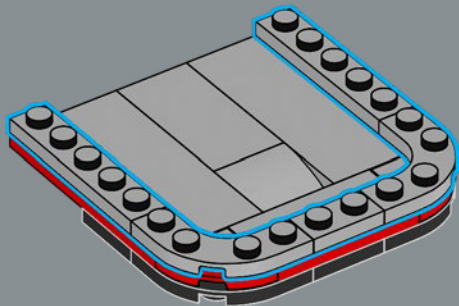

20

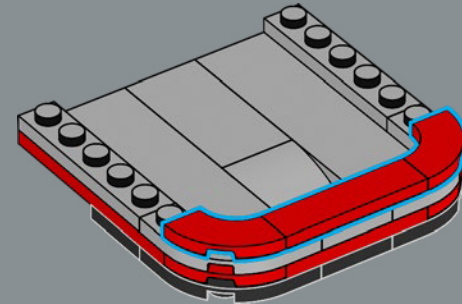

21

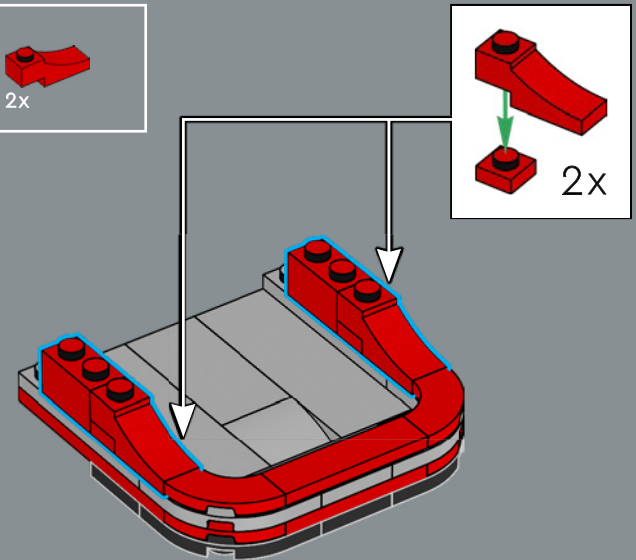

22

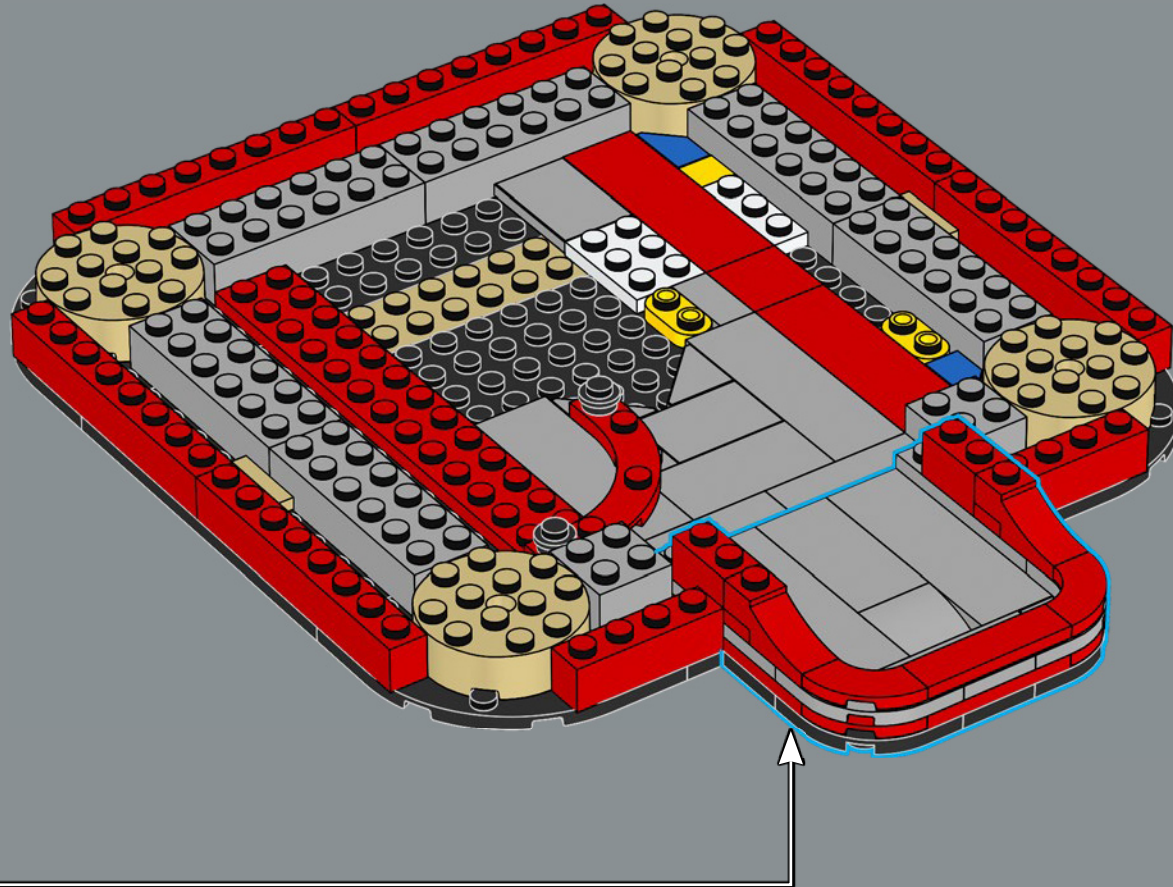

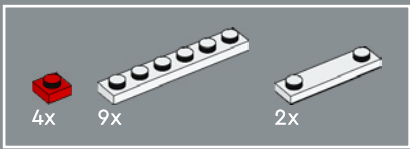

23

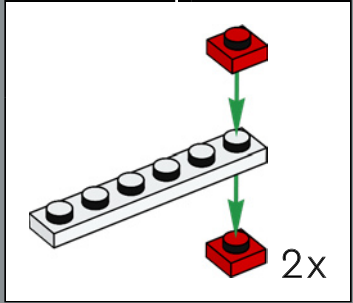
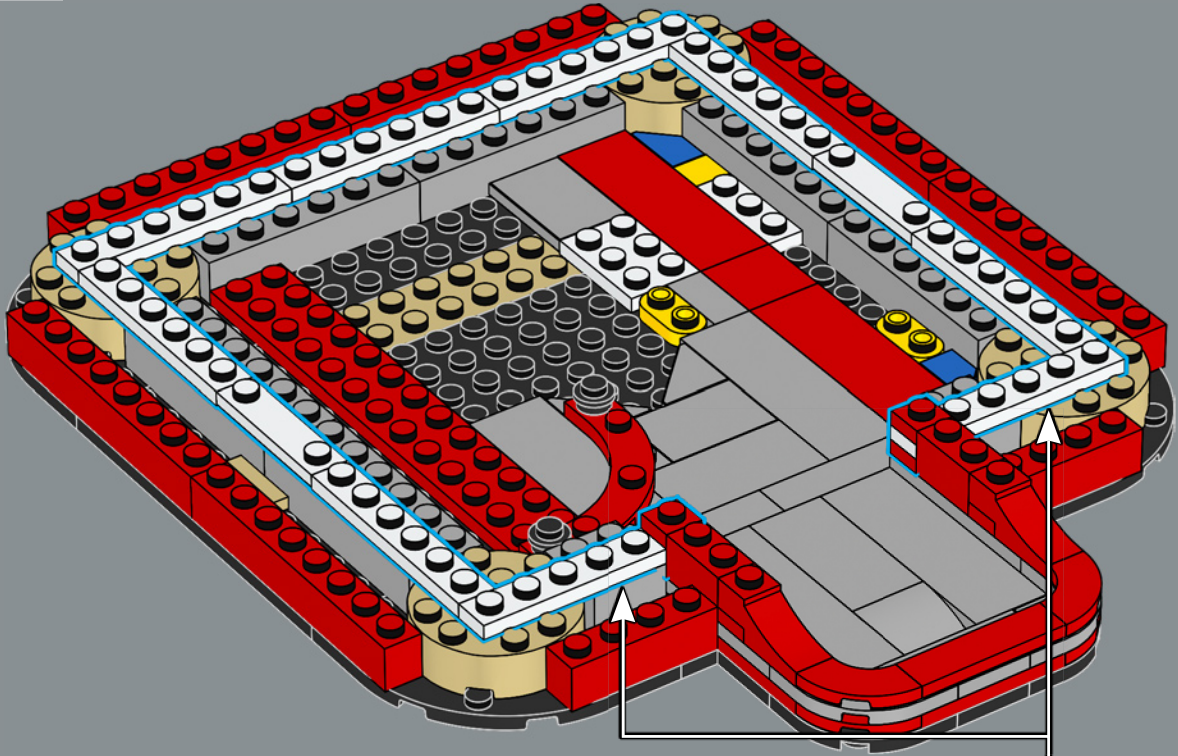

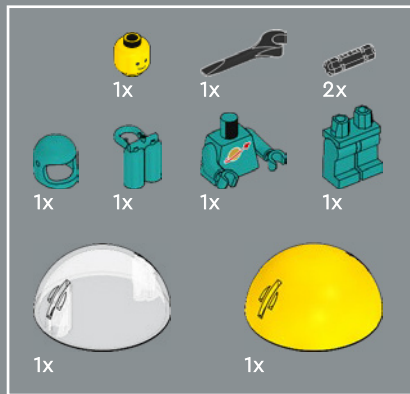
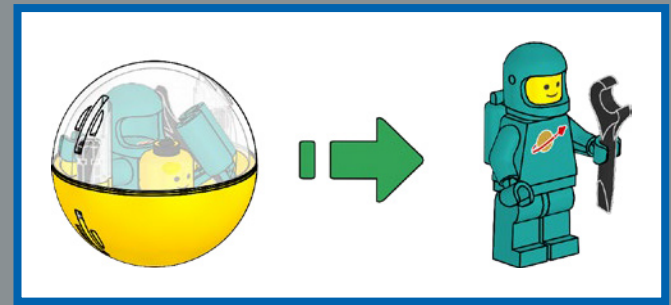

1

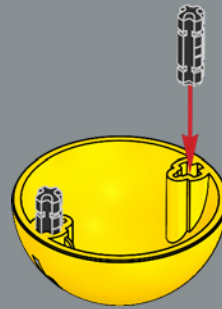

2

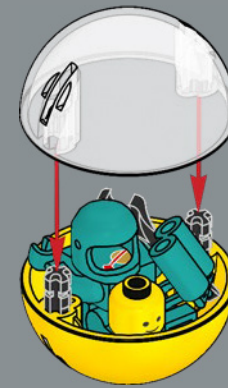

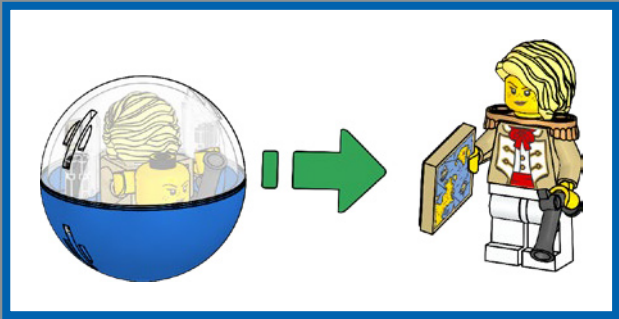
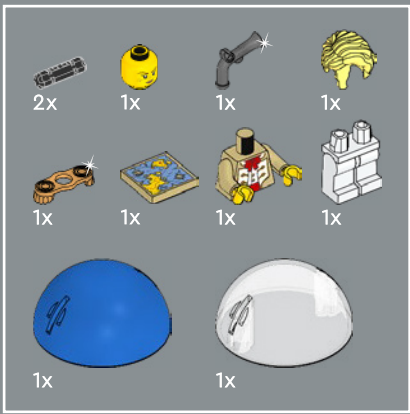

1

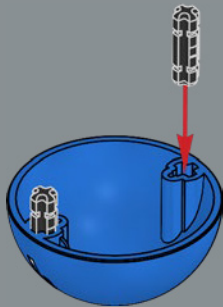

2

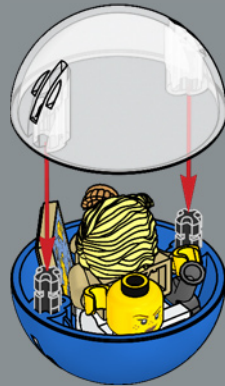

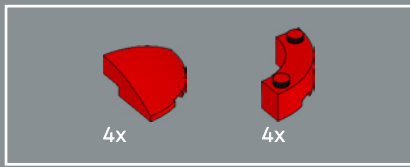

24

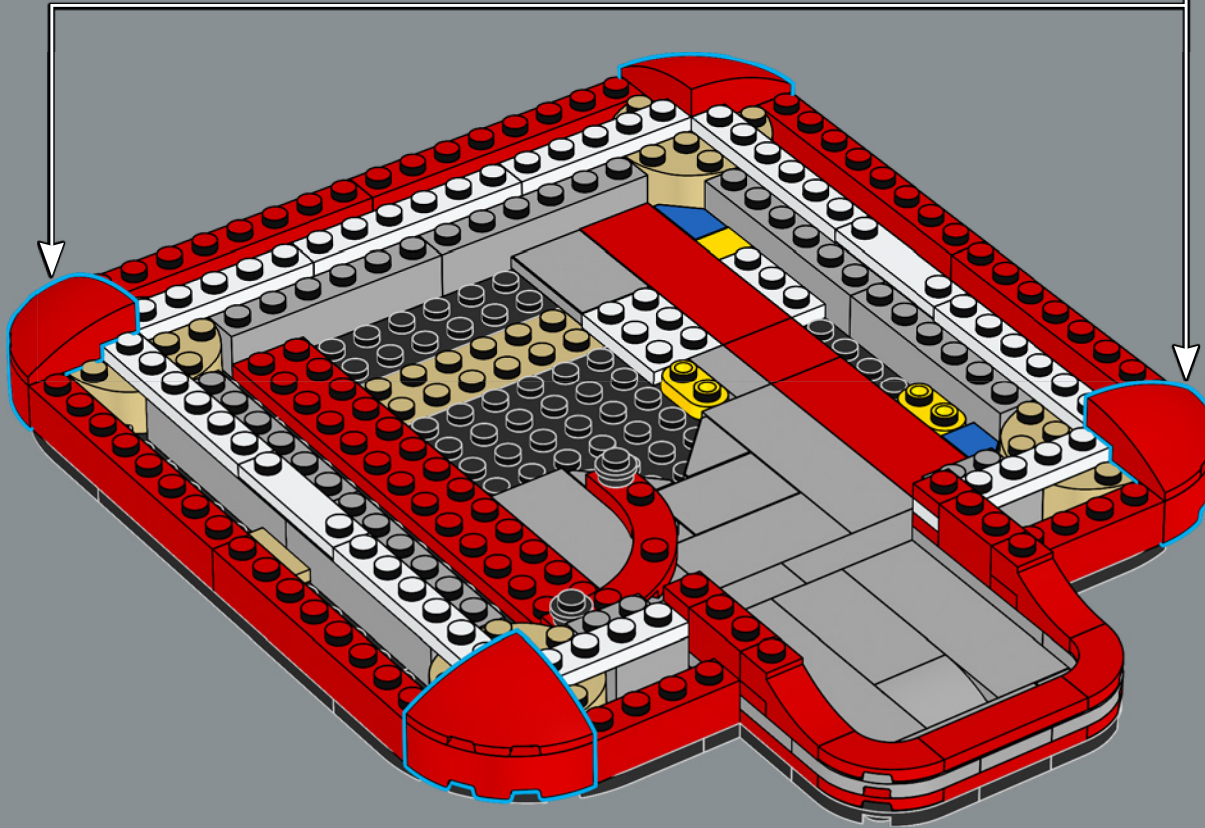
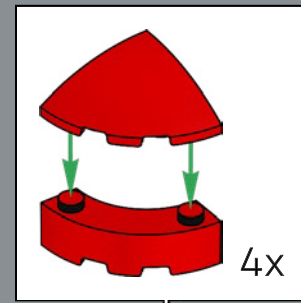



25

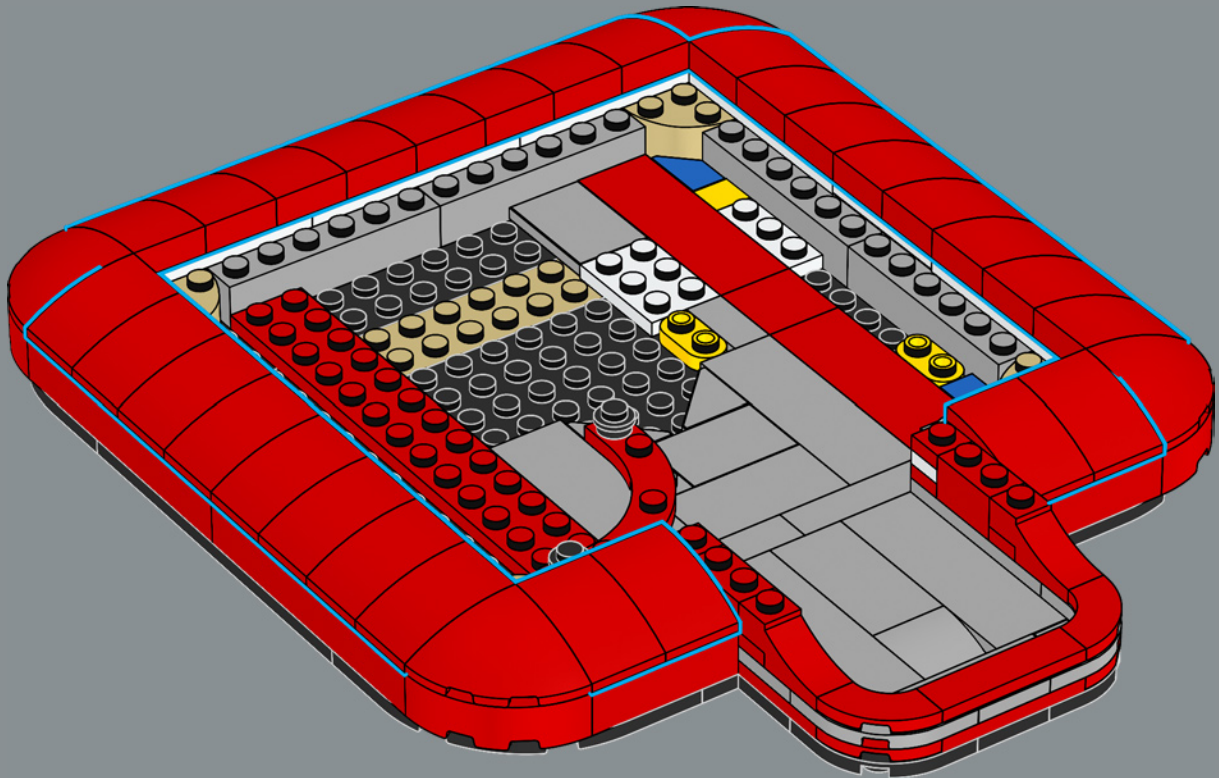

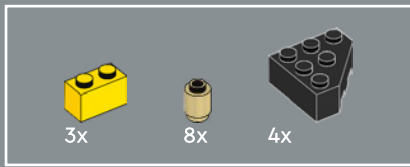

26

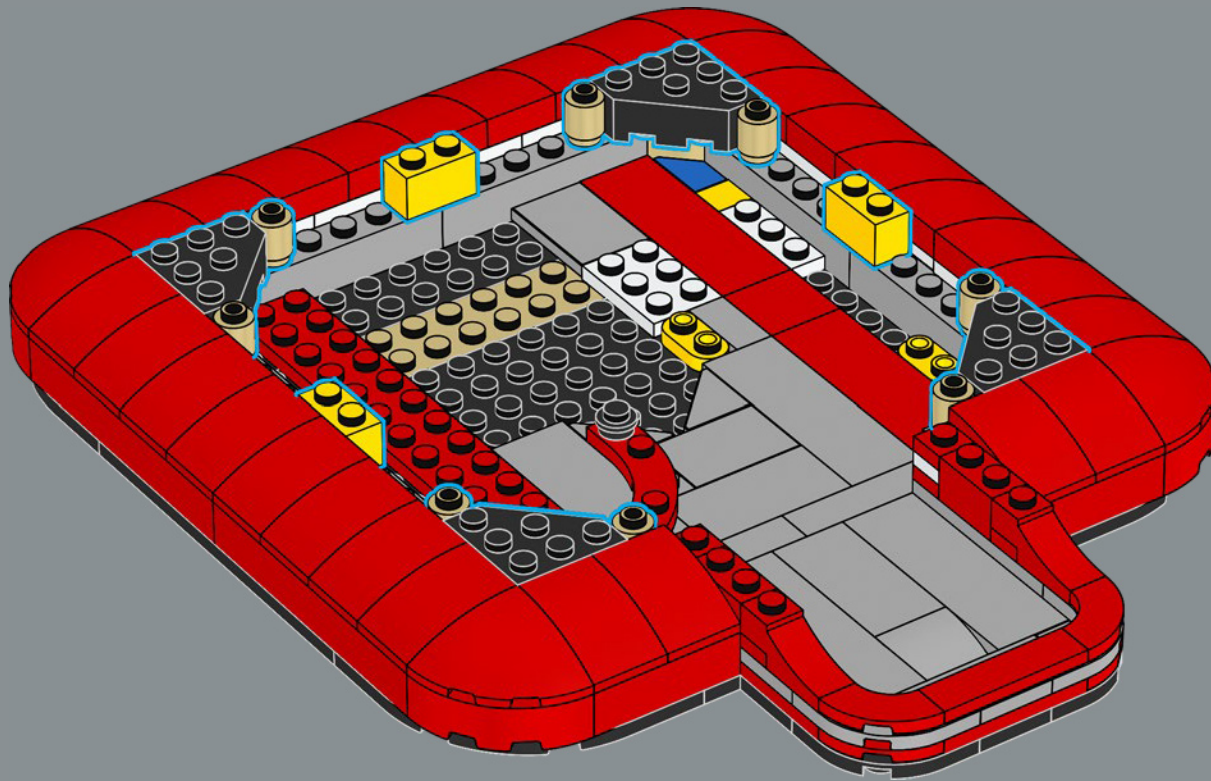

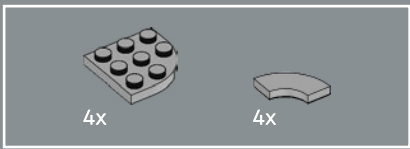

27

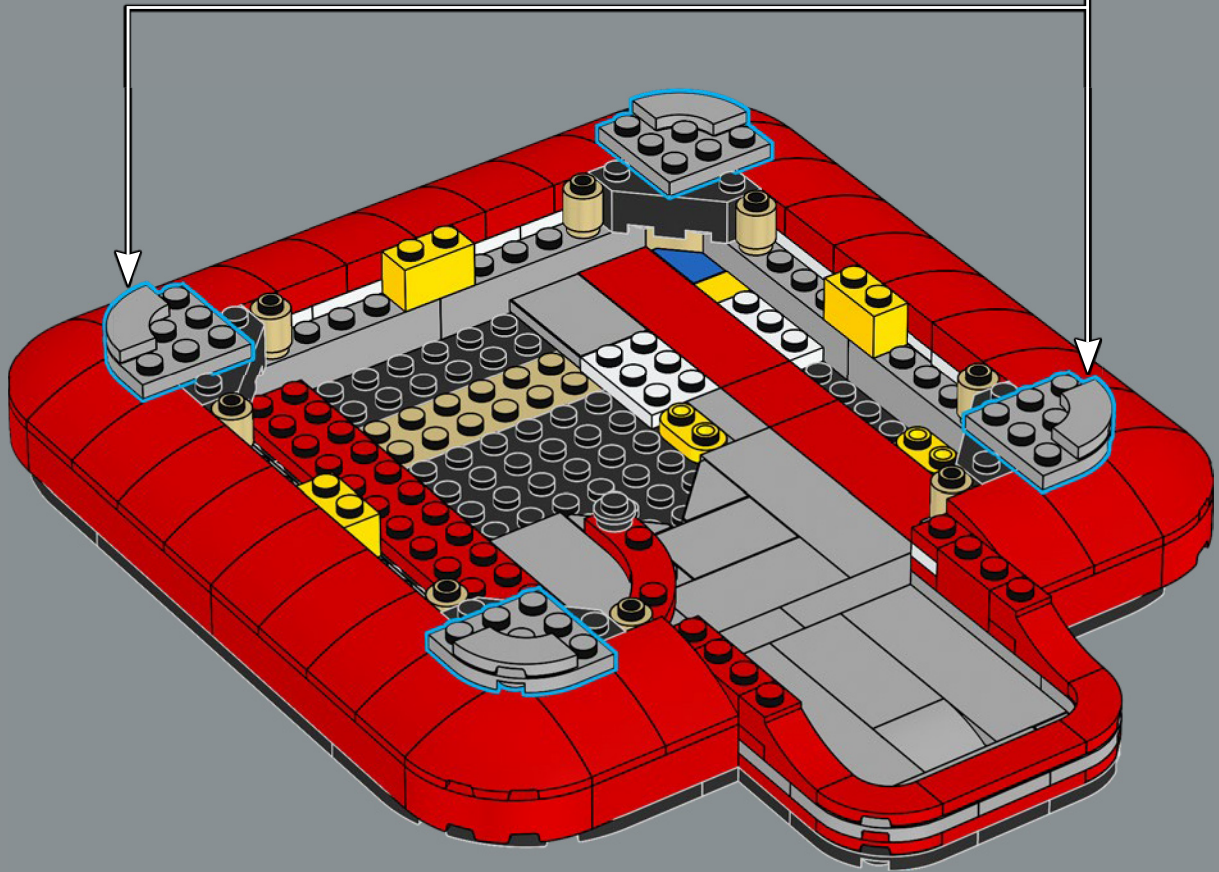
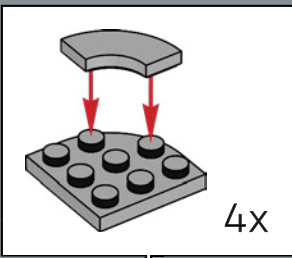

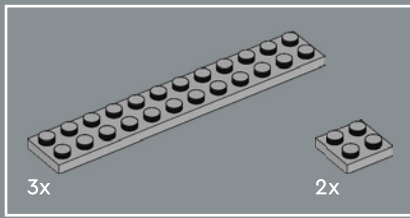

28

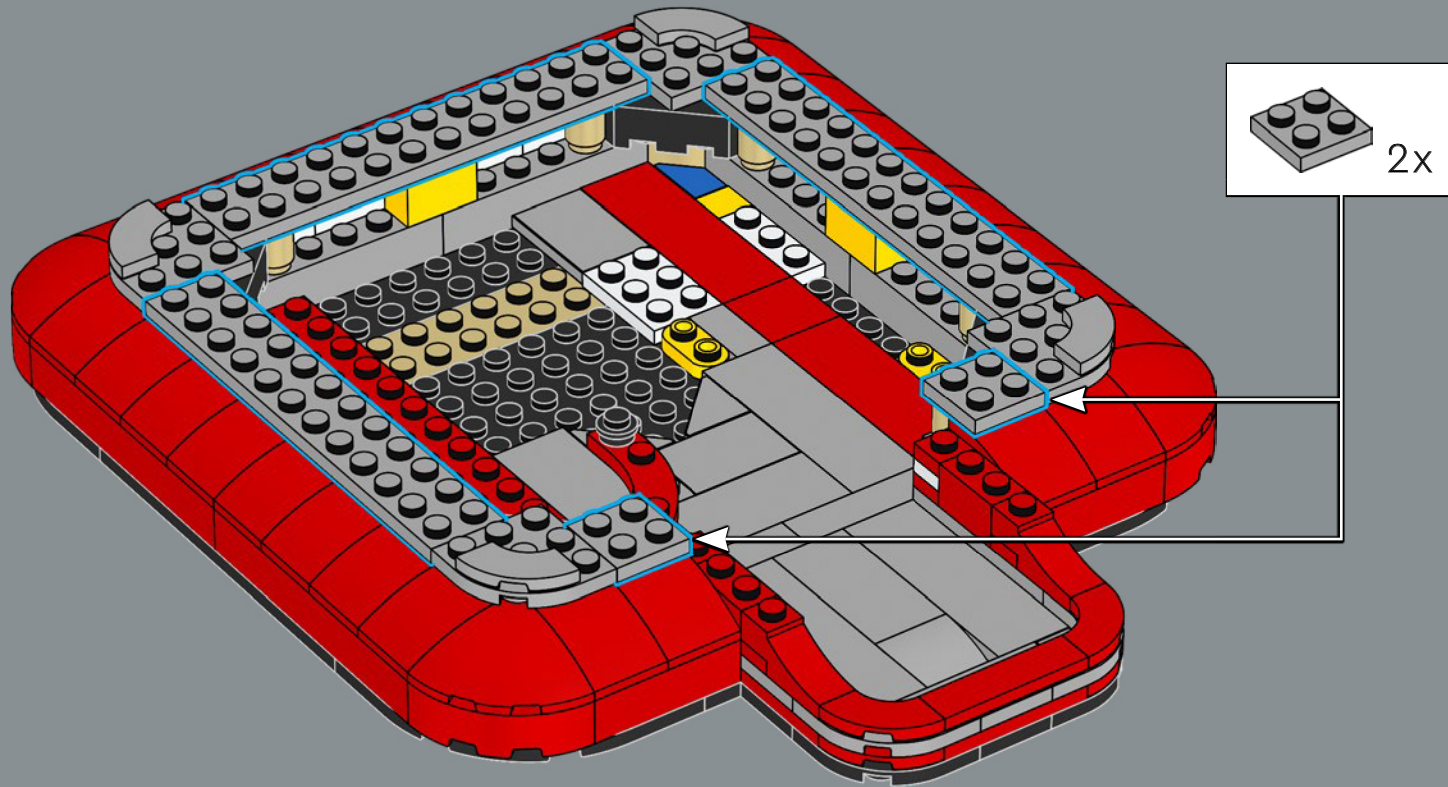

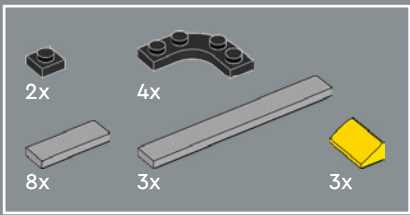

29

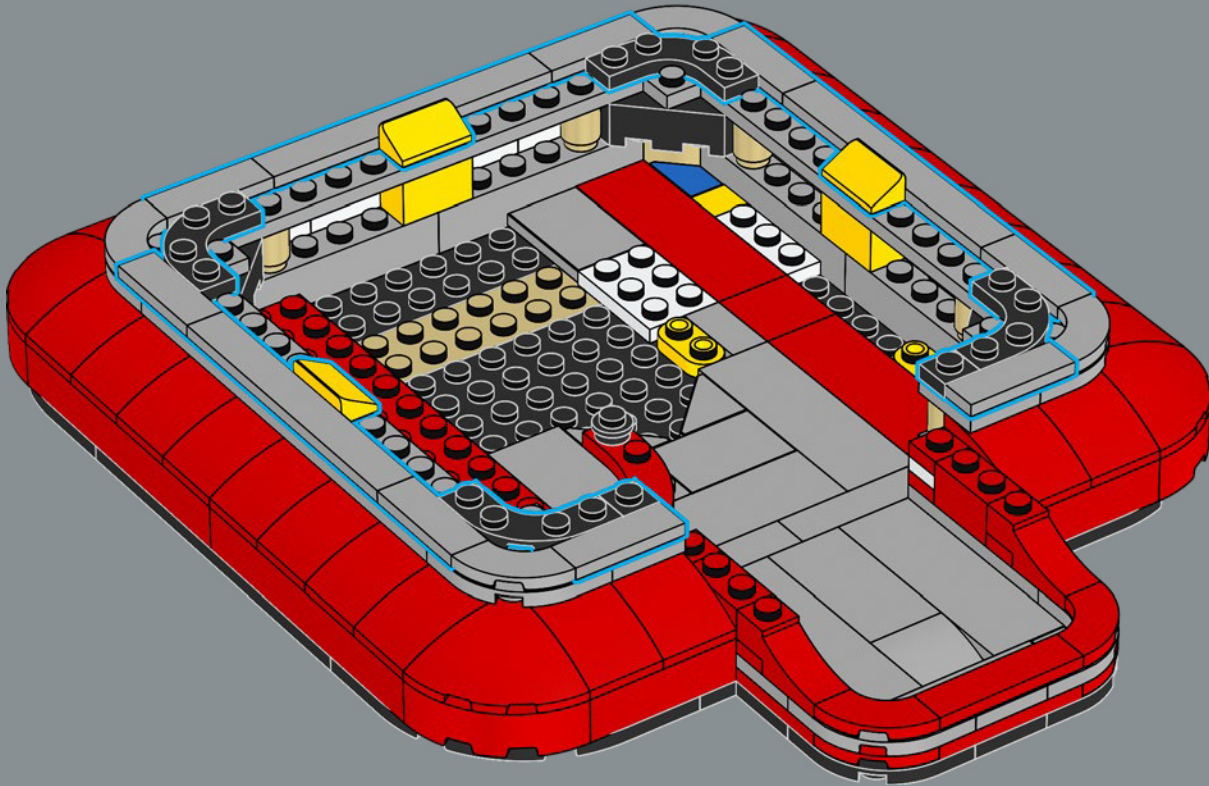

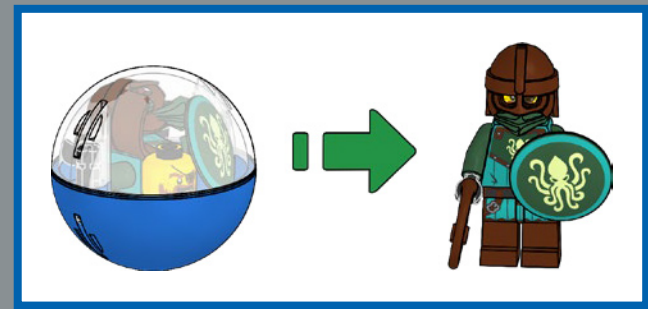

1

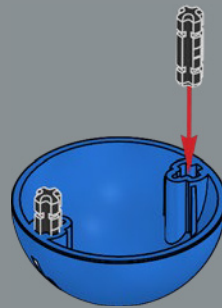

2

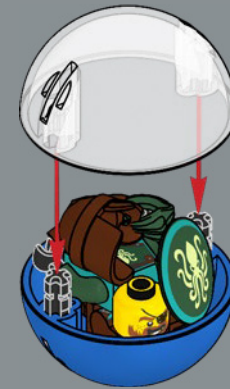

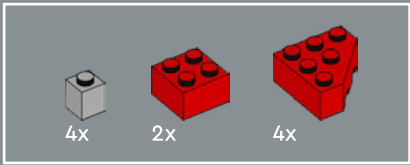

30

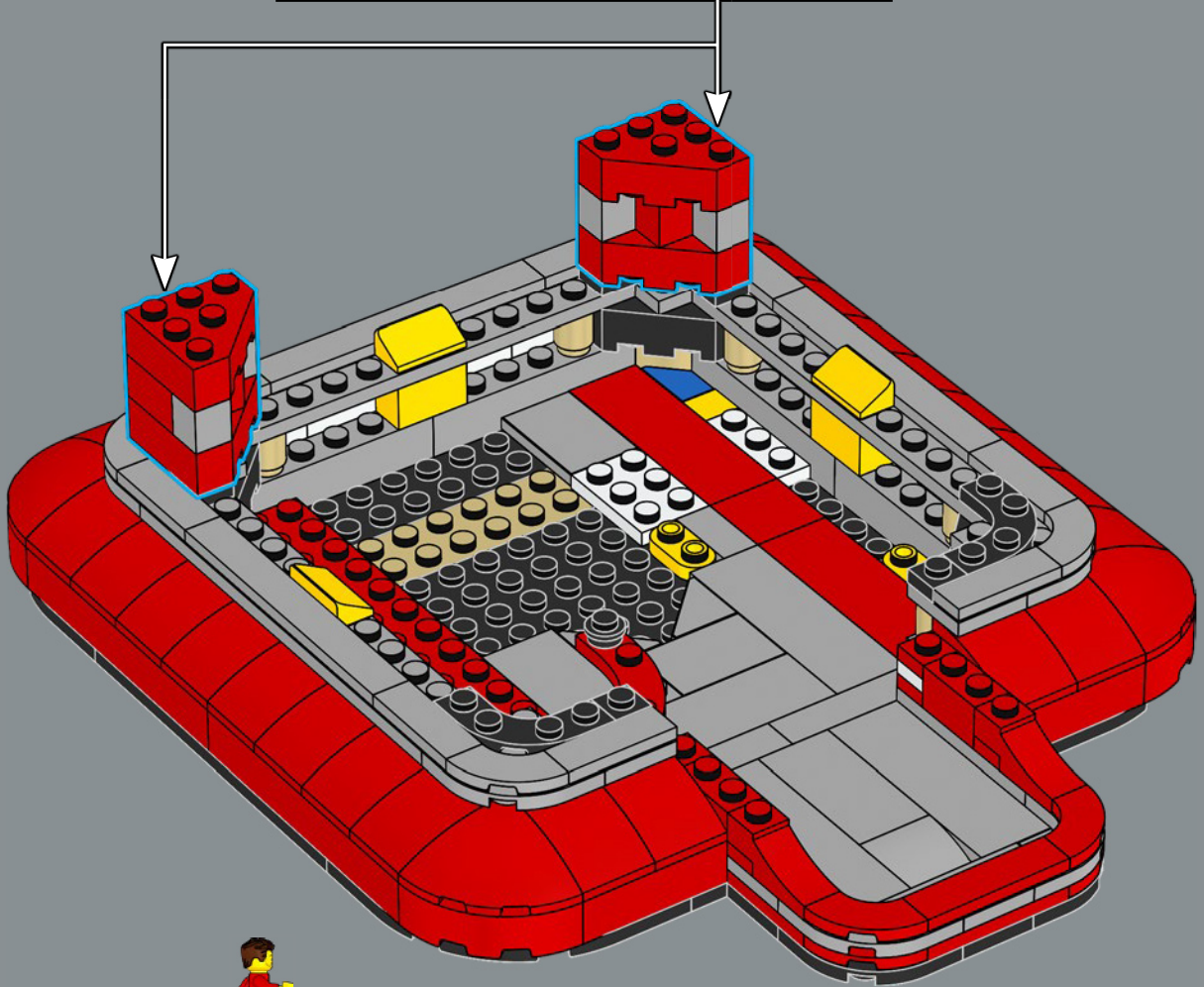
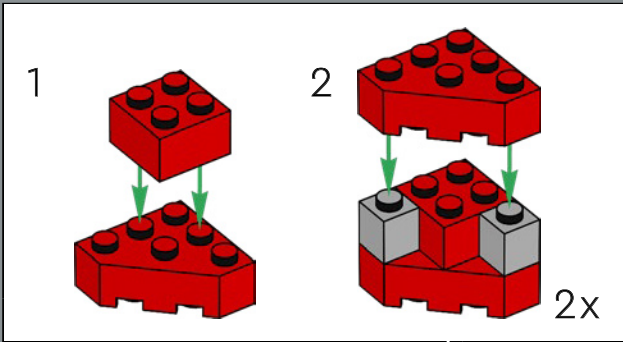

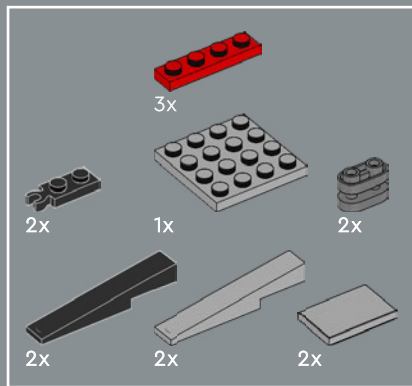

31

1

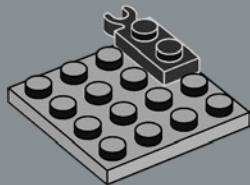

2

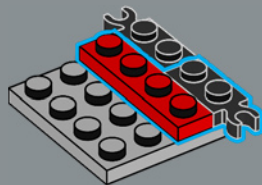

3

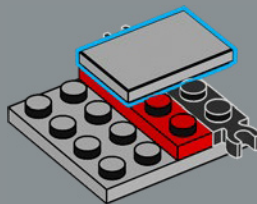

4

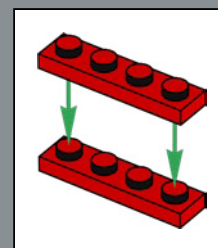
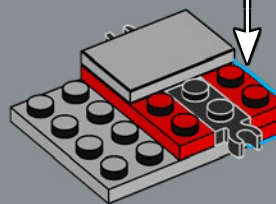

5

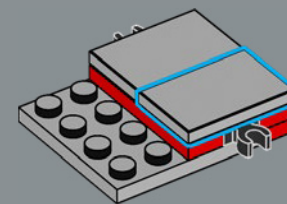

6

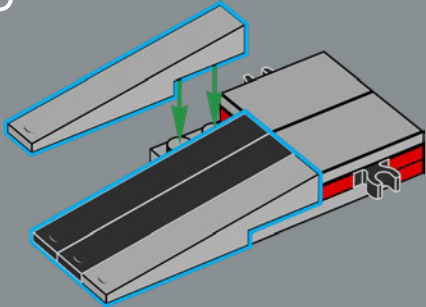

7

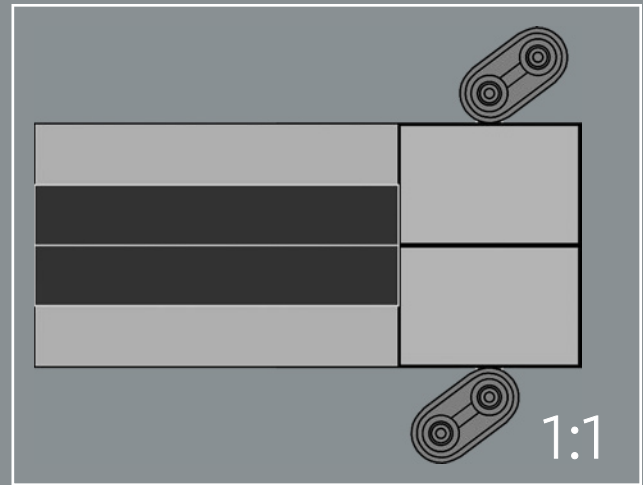
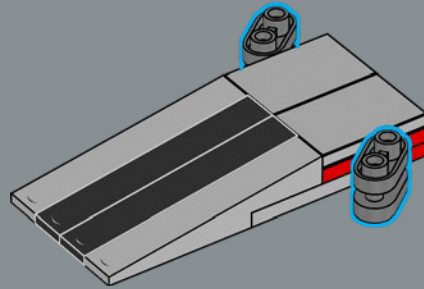

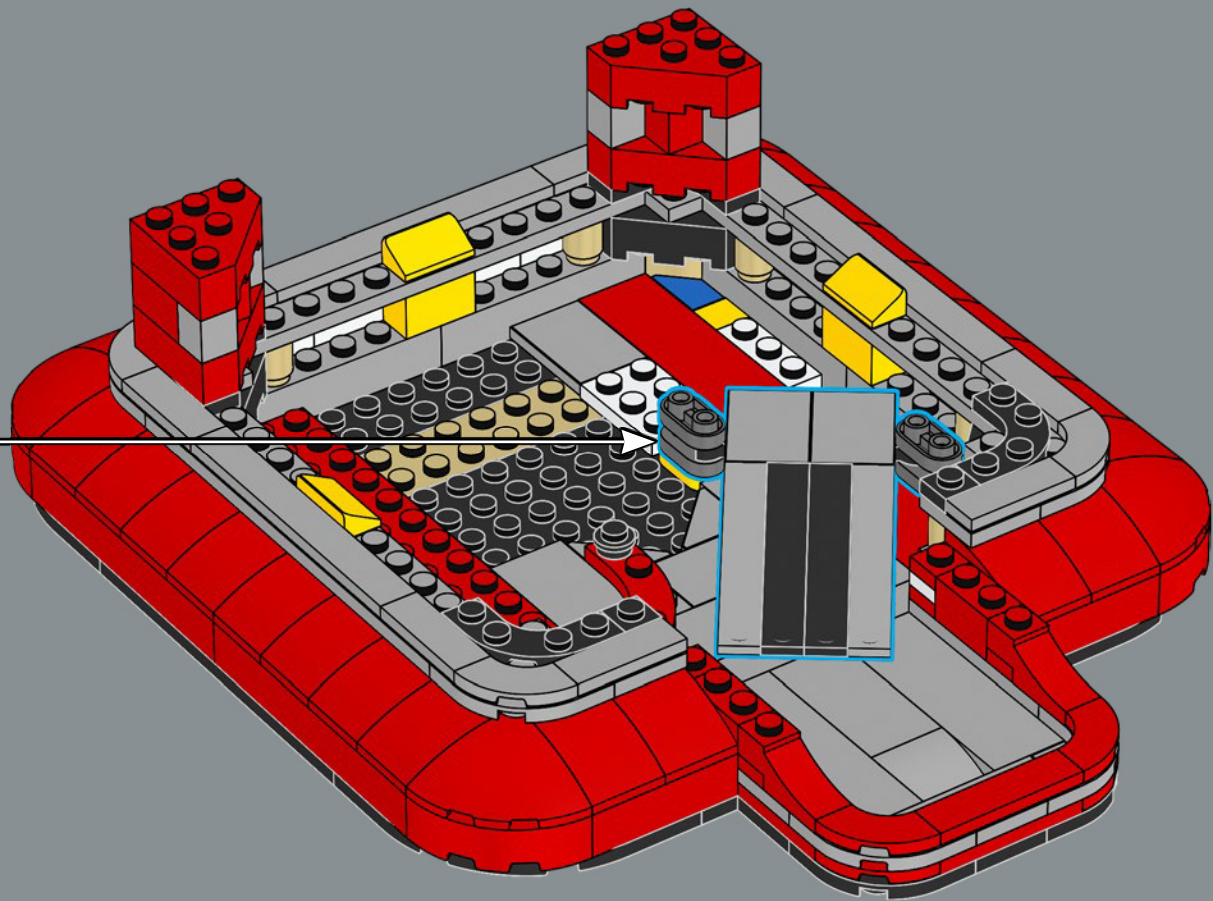

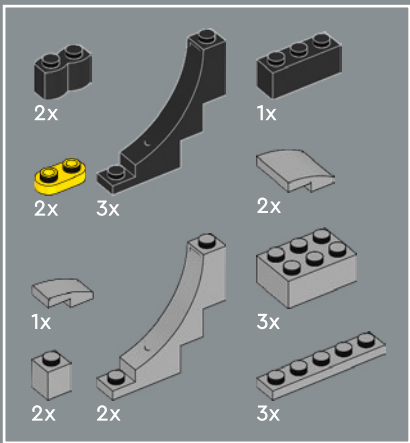

32

1

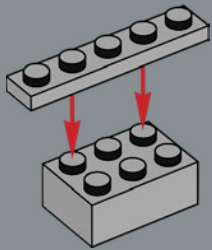

2

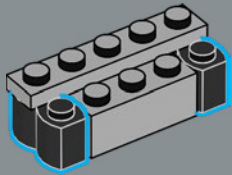

3

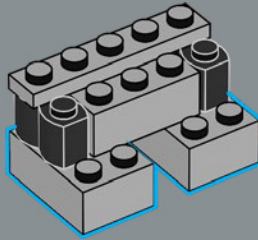

4

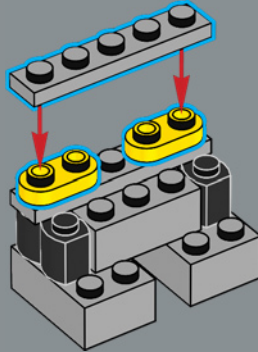

5

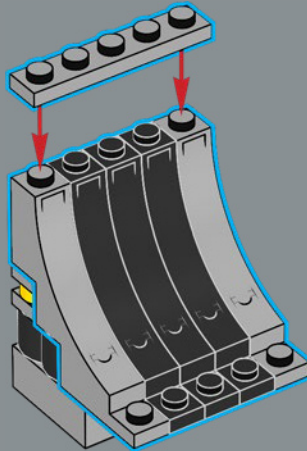

6

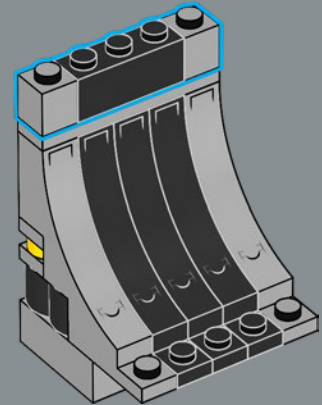

7

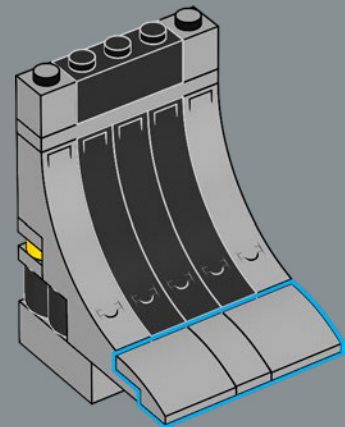

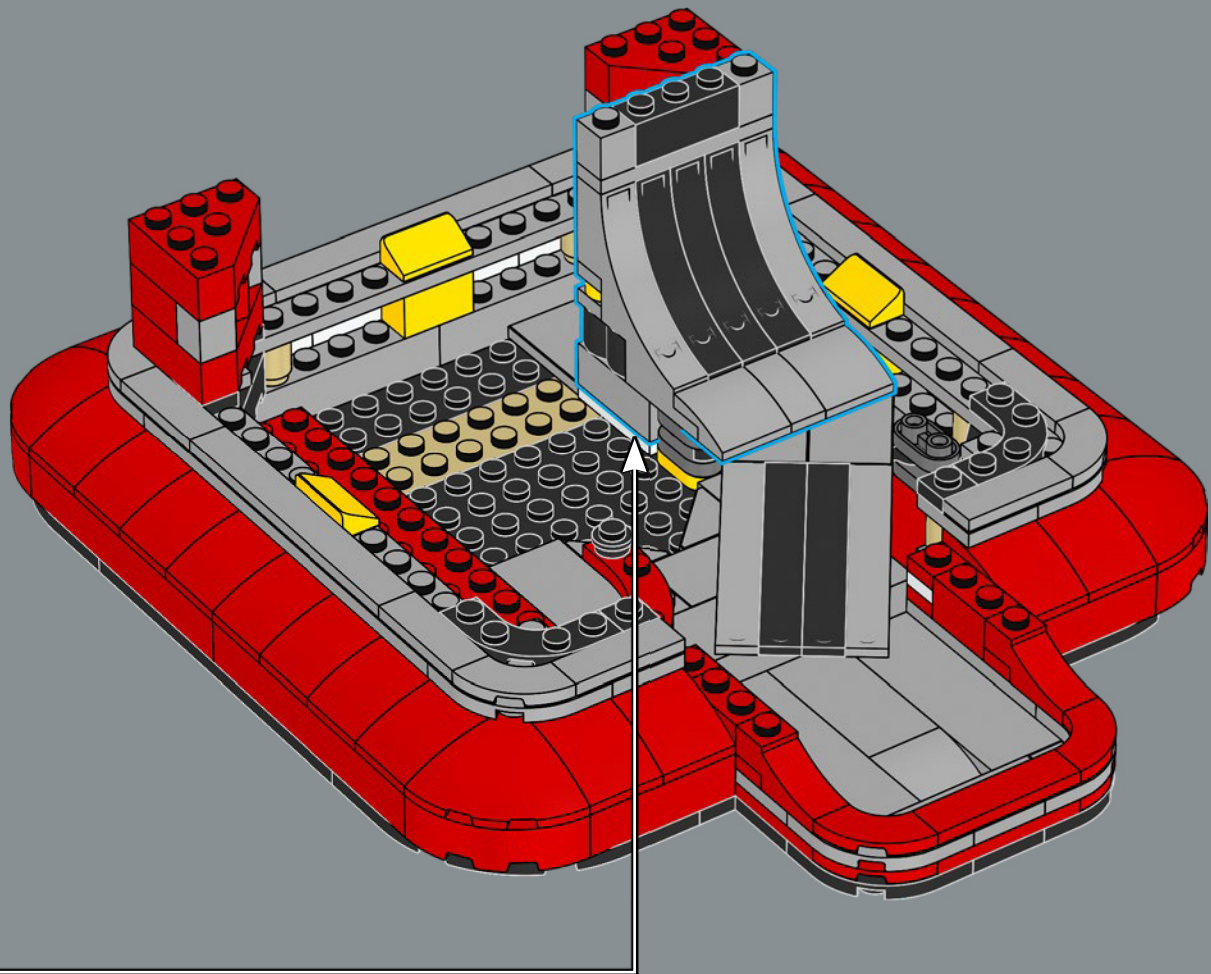

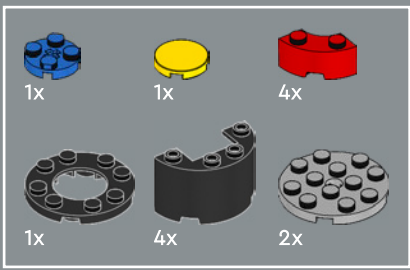

33

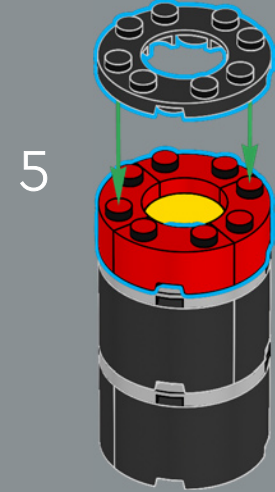
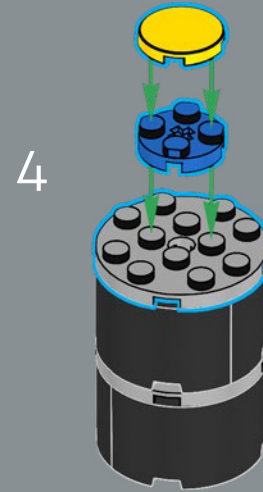
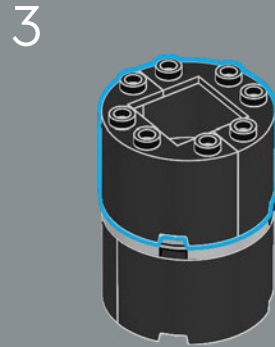
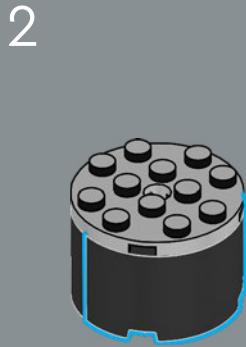
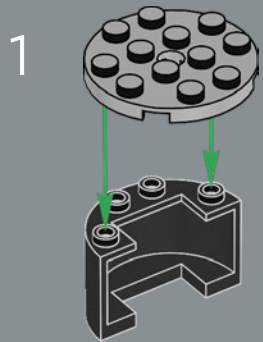

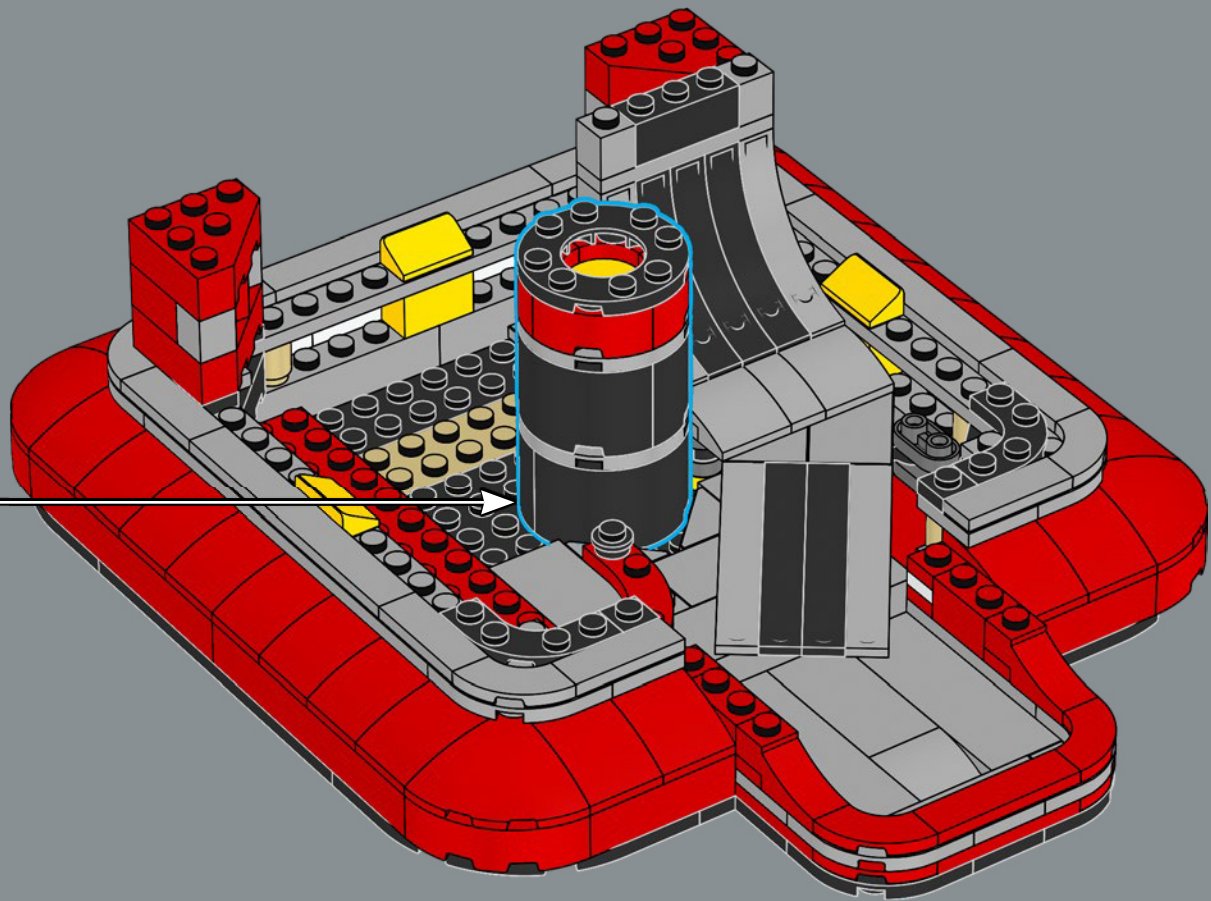

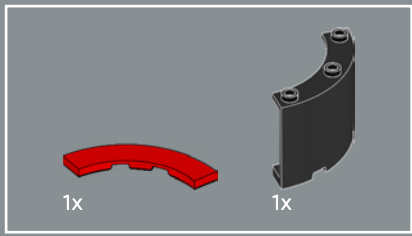

34

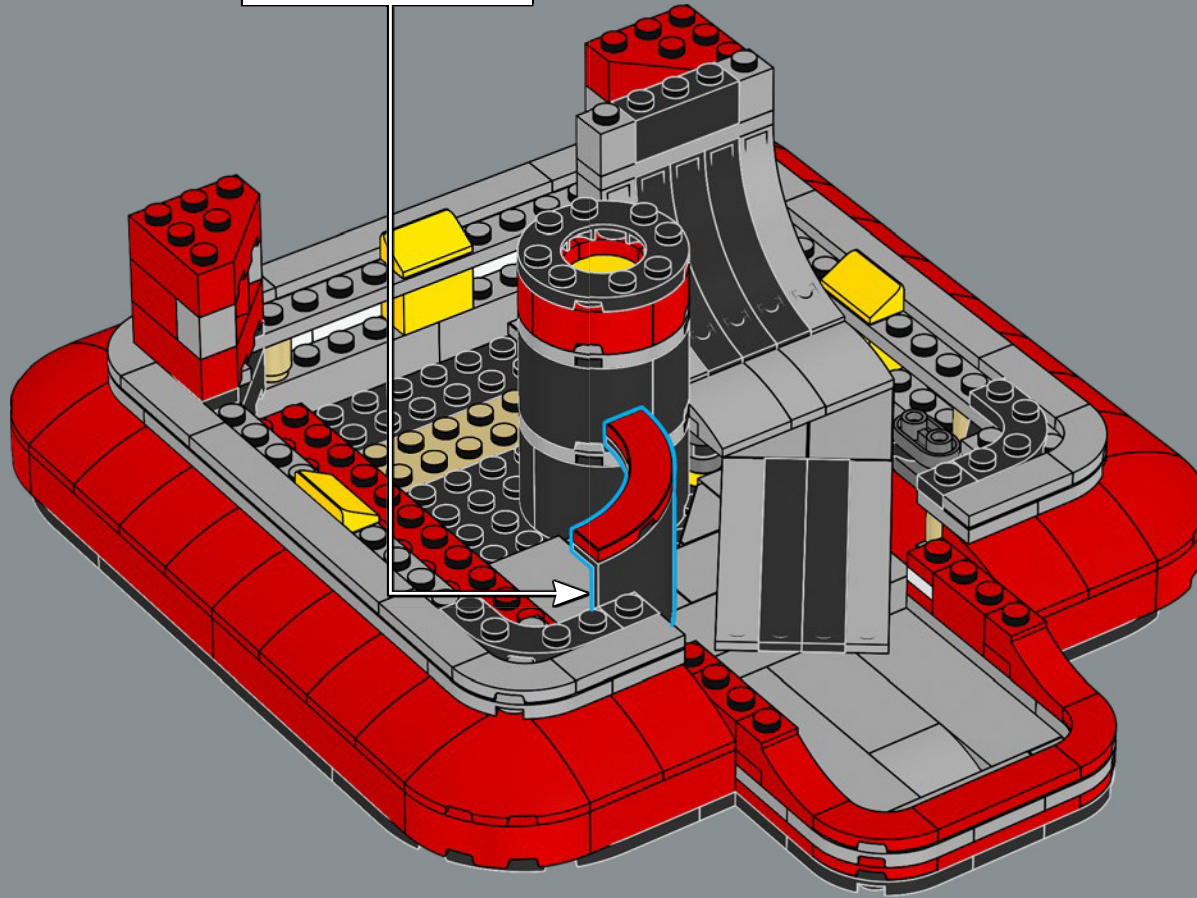
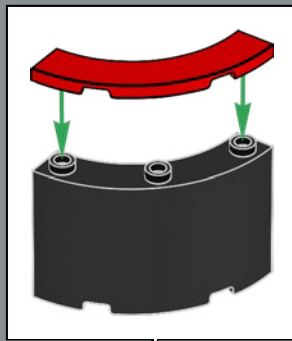

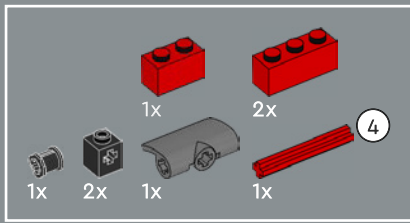

35

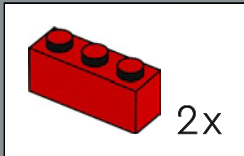
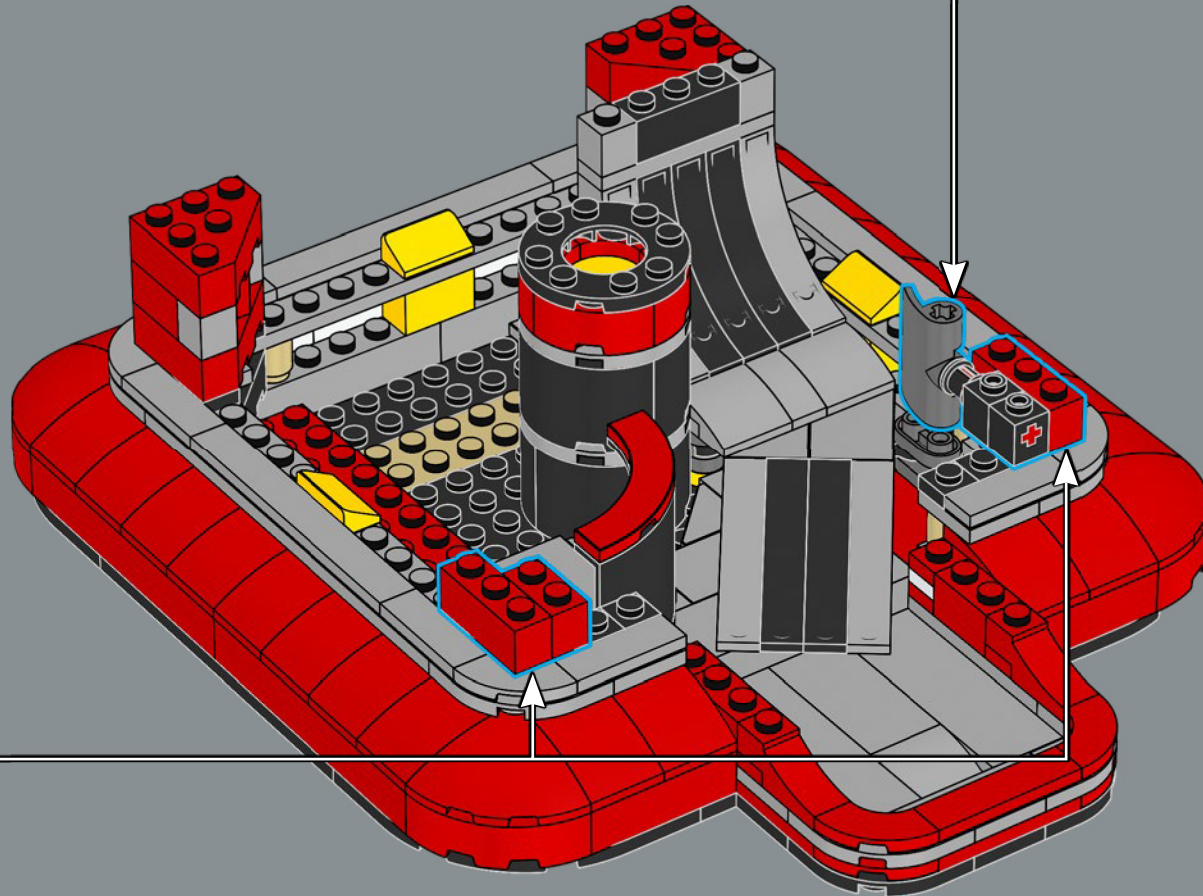
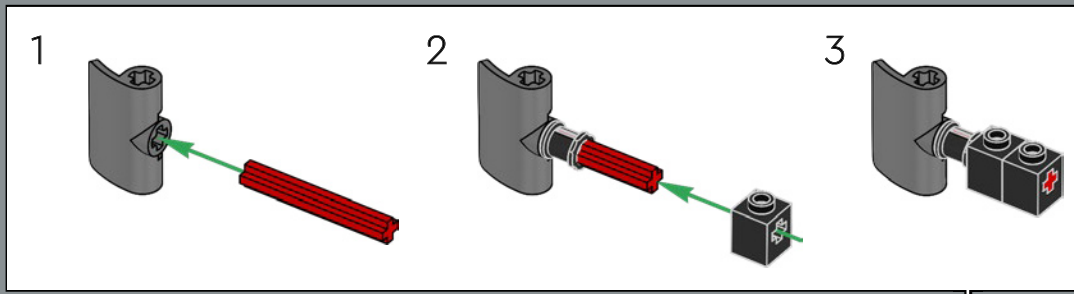

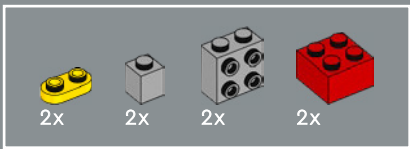

36

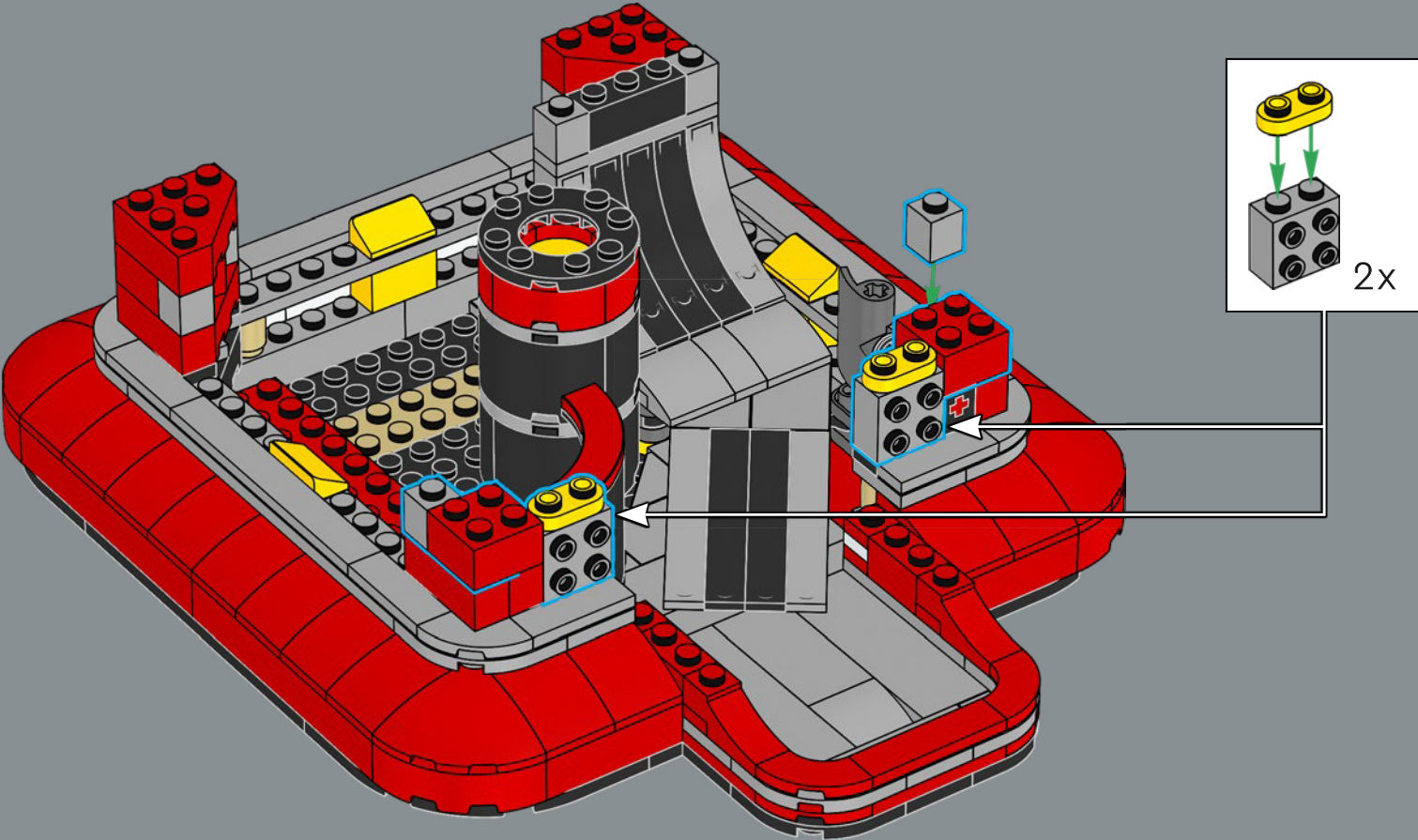

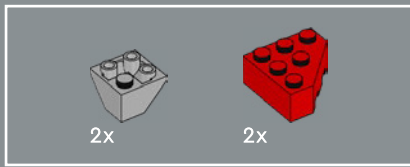

37

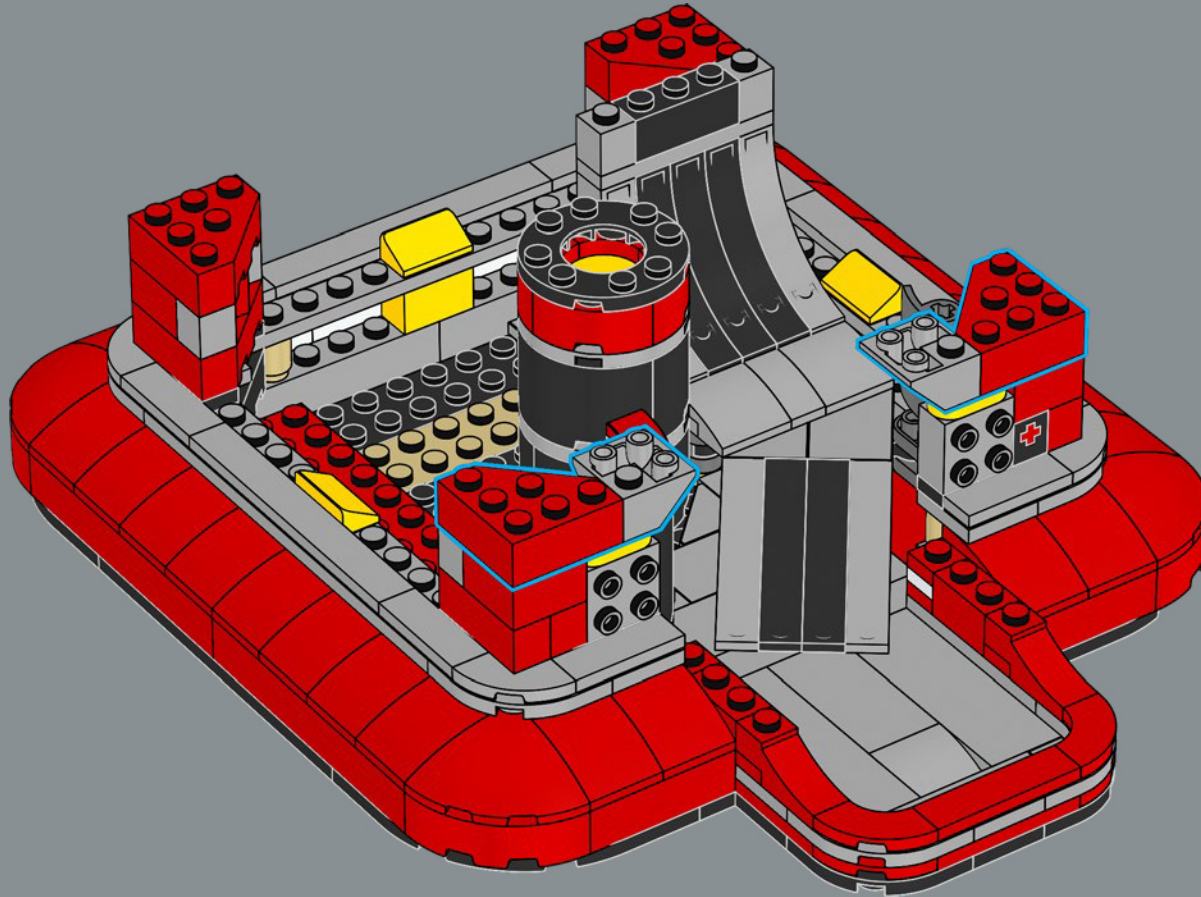

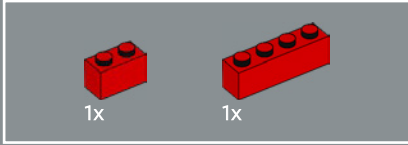
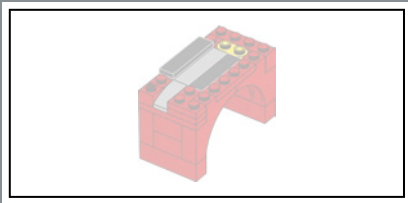

38

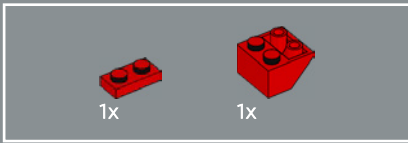
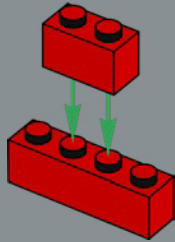

39

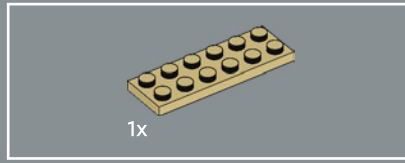
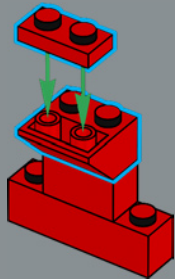

40

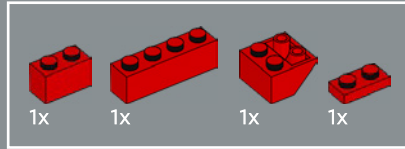
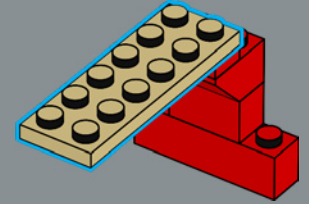

41

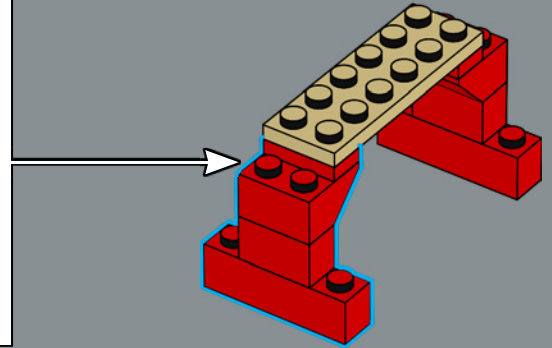
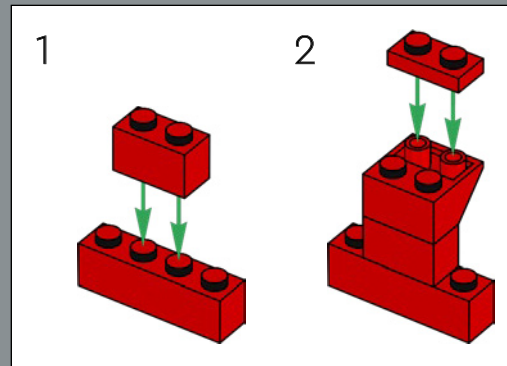

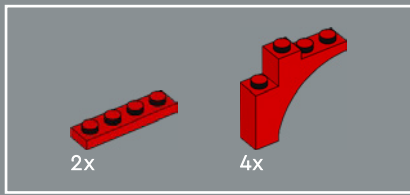

42

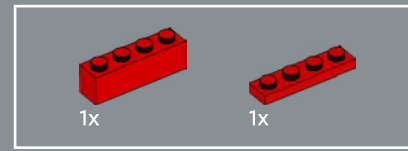
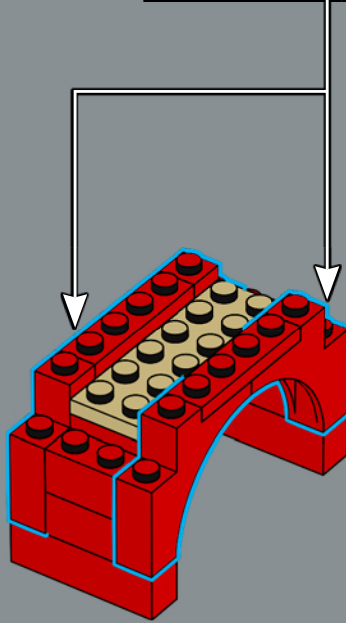
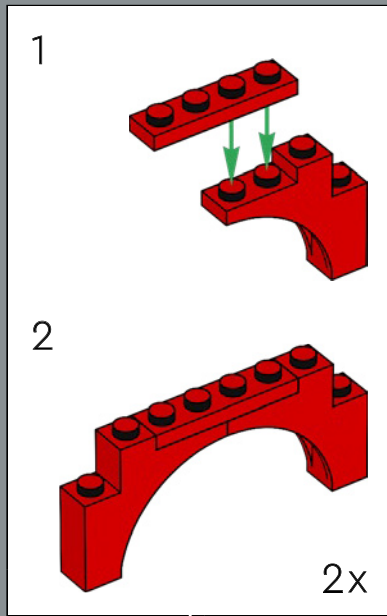

43

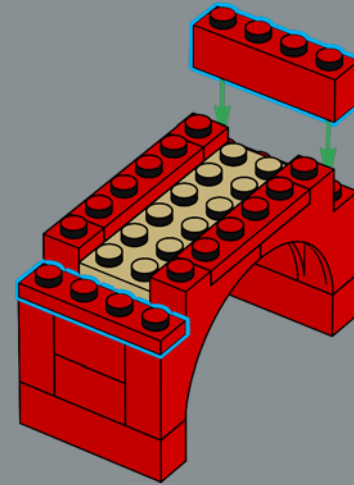

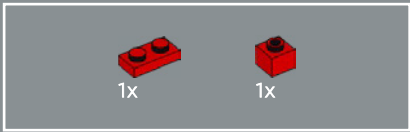

44

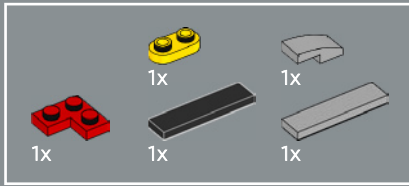
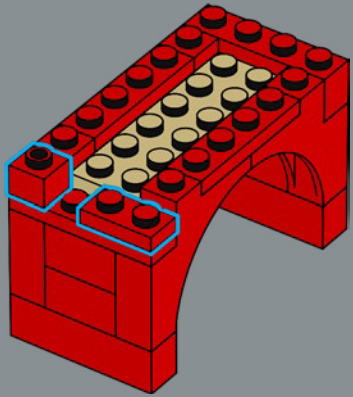

45

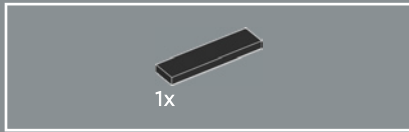
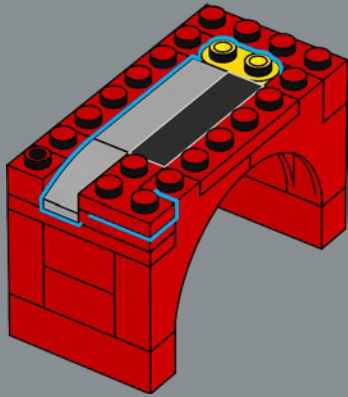

46

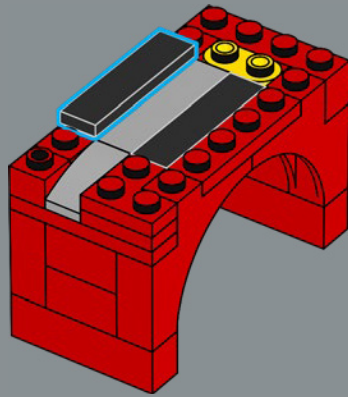

47

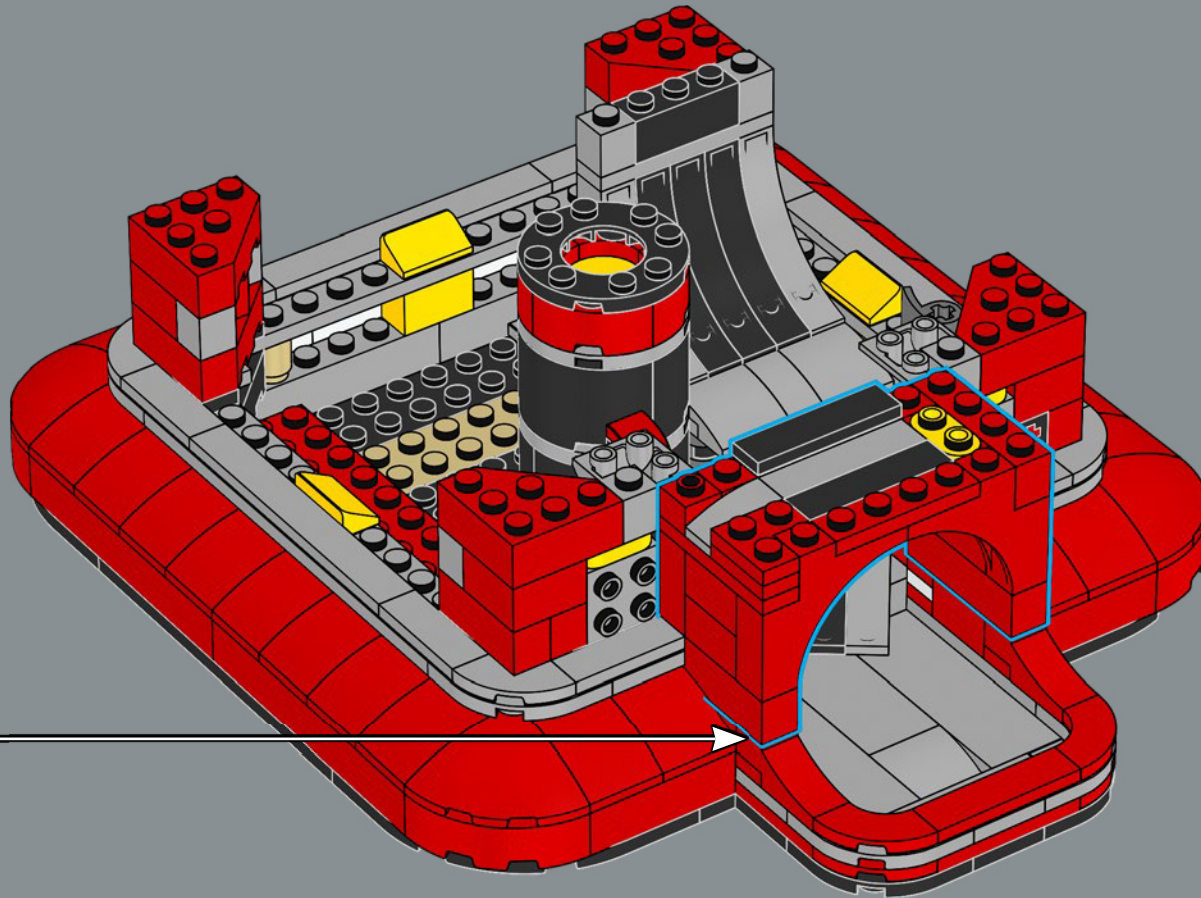

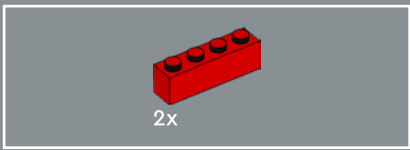

48

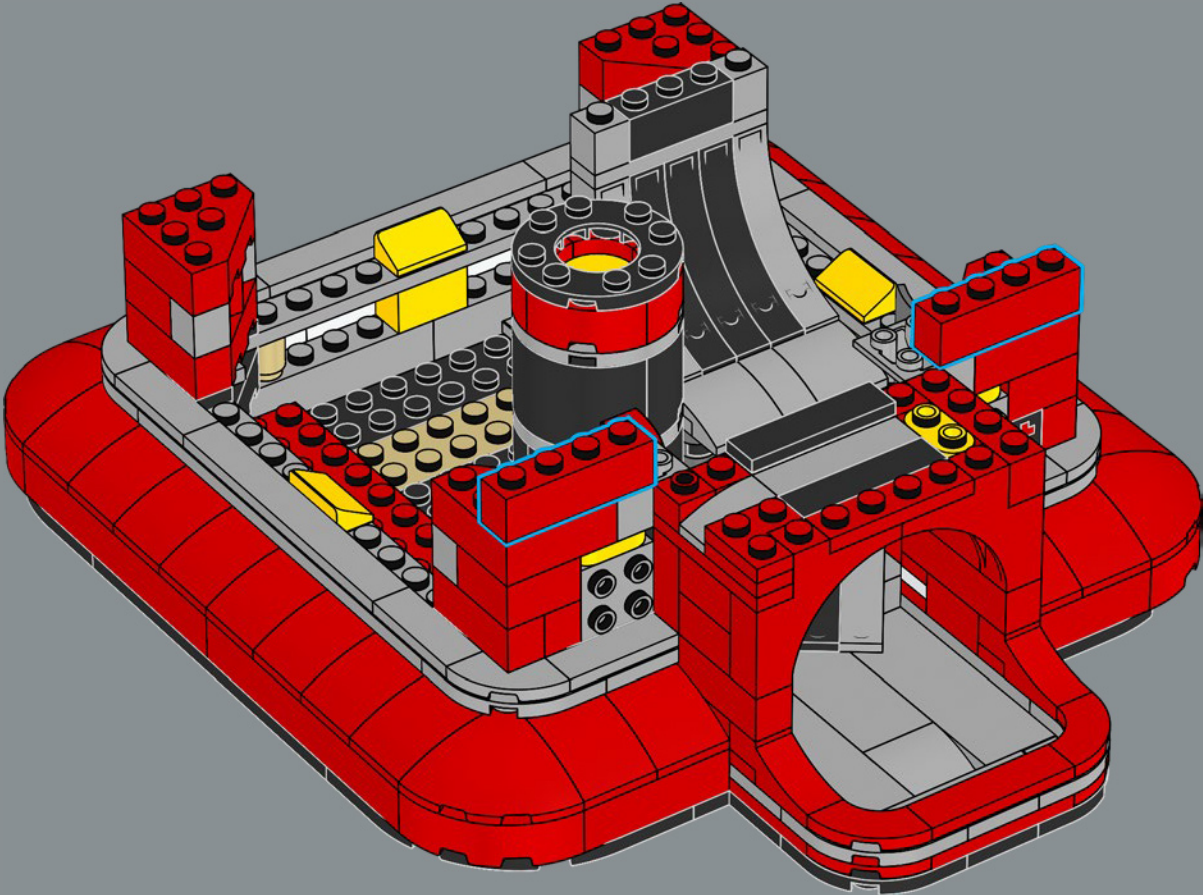

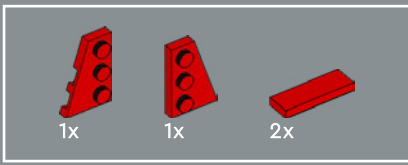

49

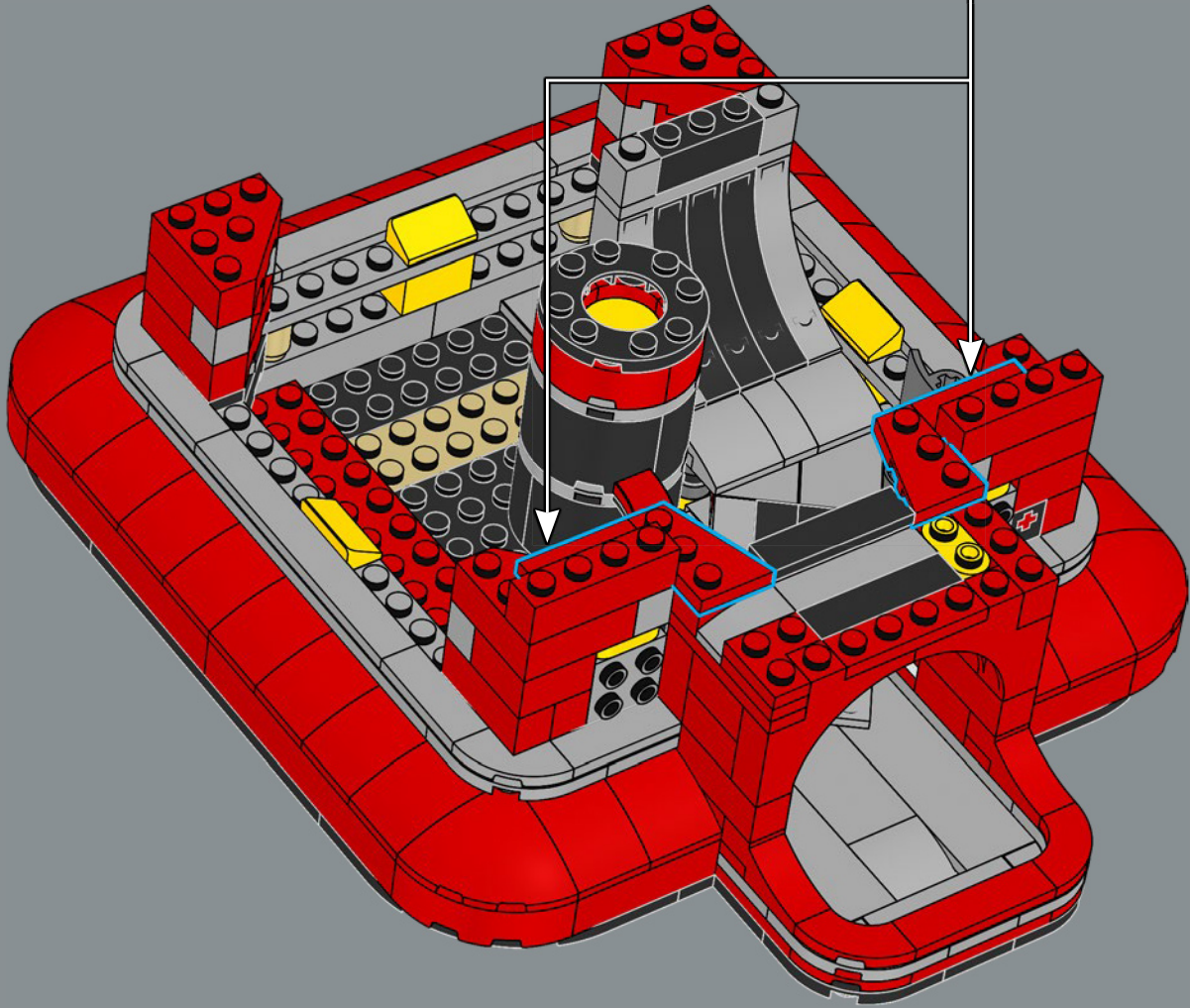
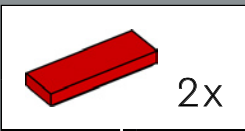

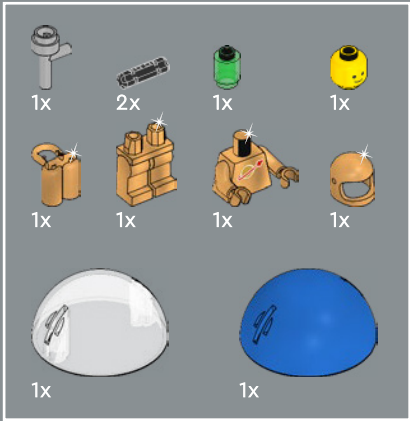
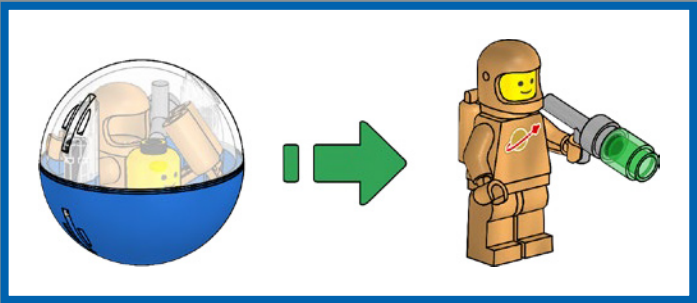

1

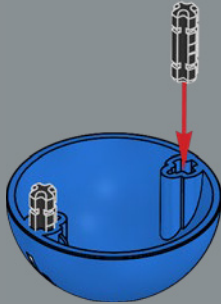

2

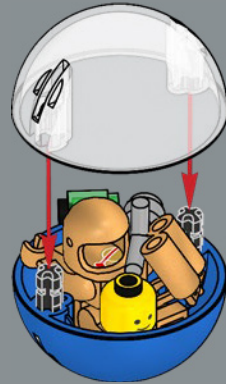

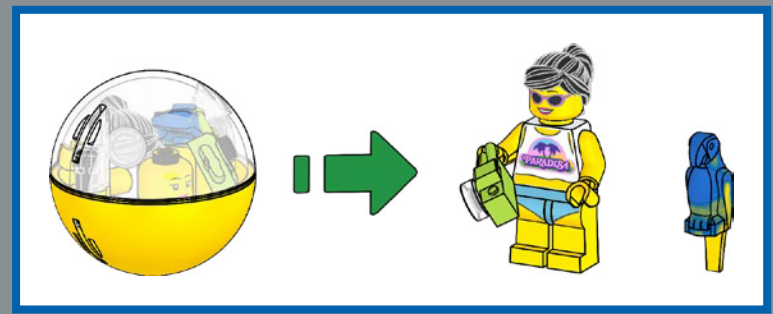
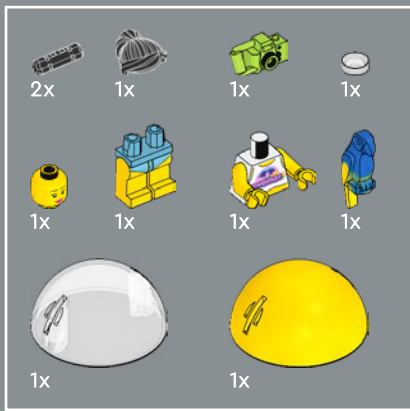

1

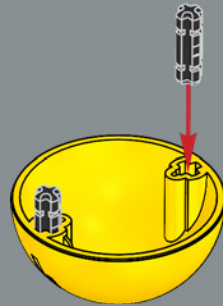

2



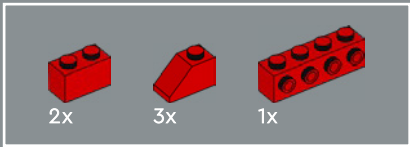

50

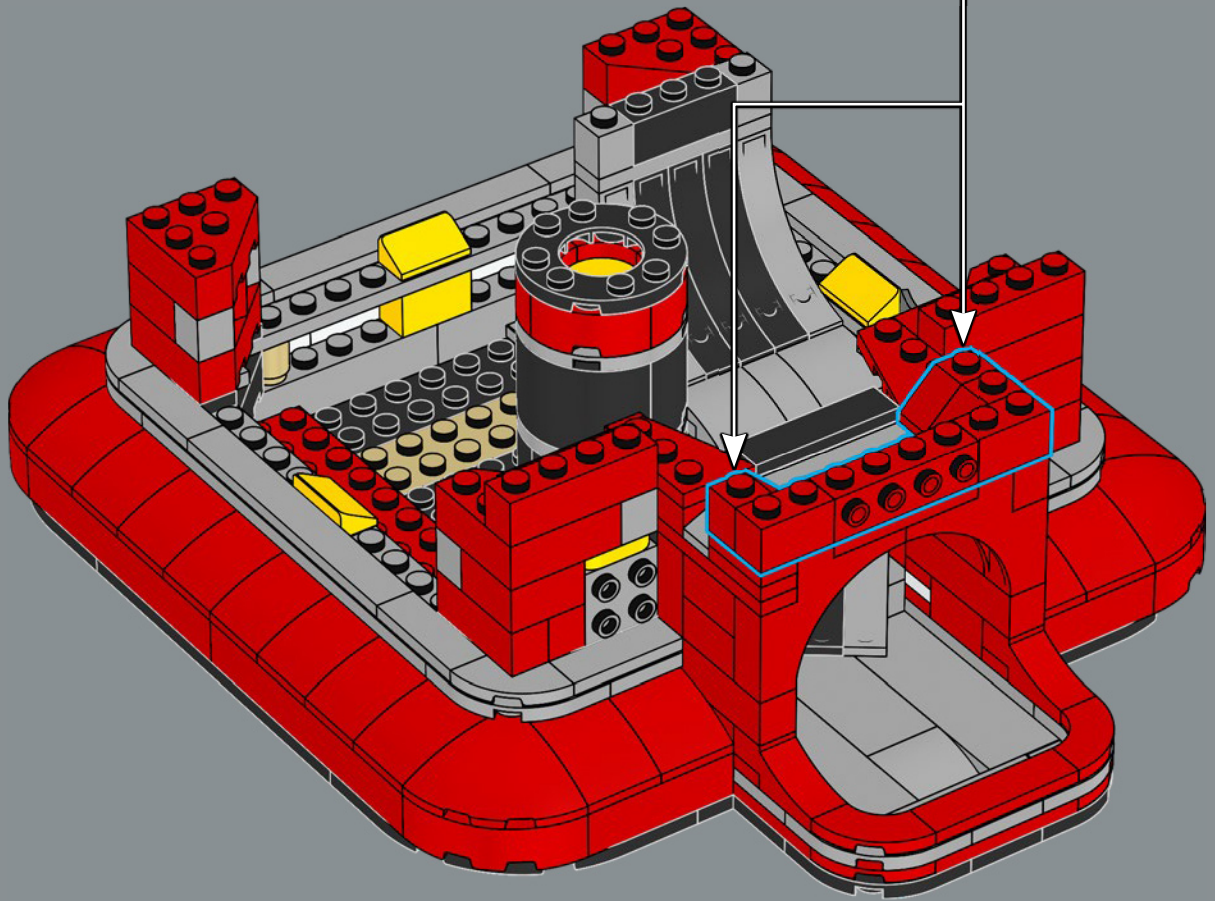
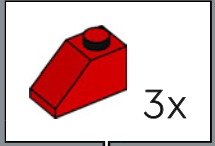

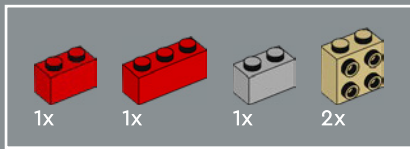

51

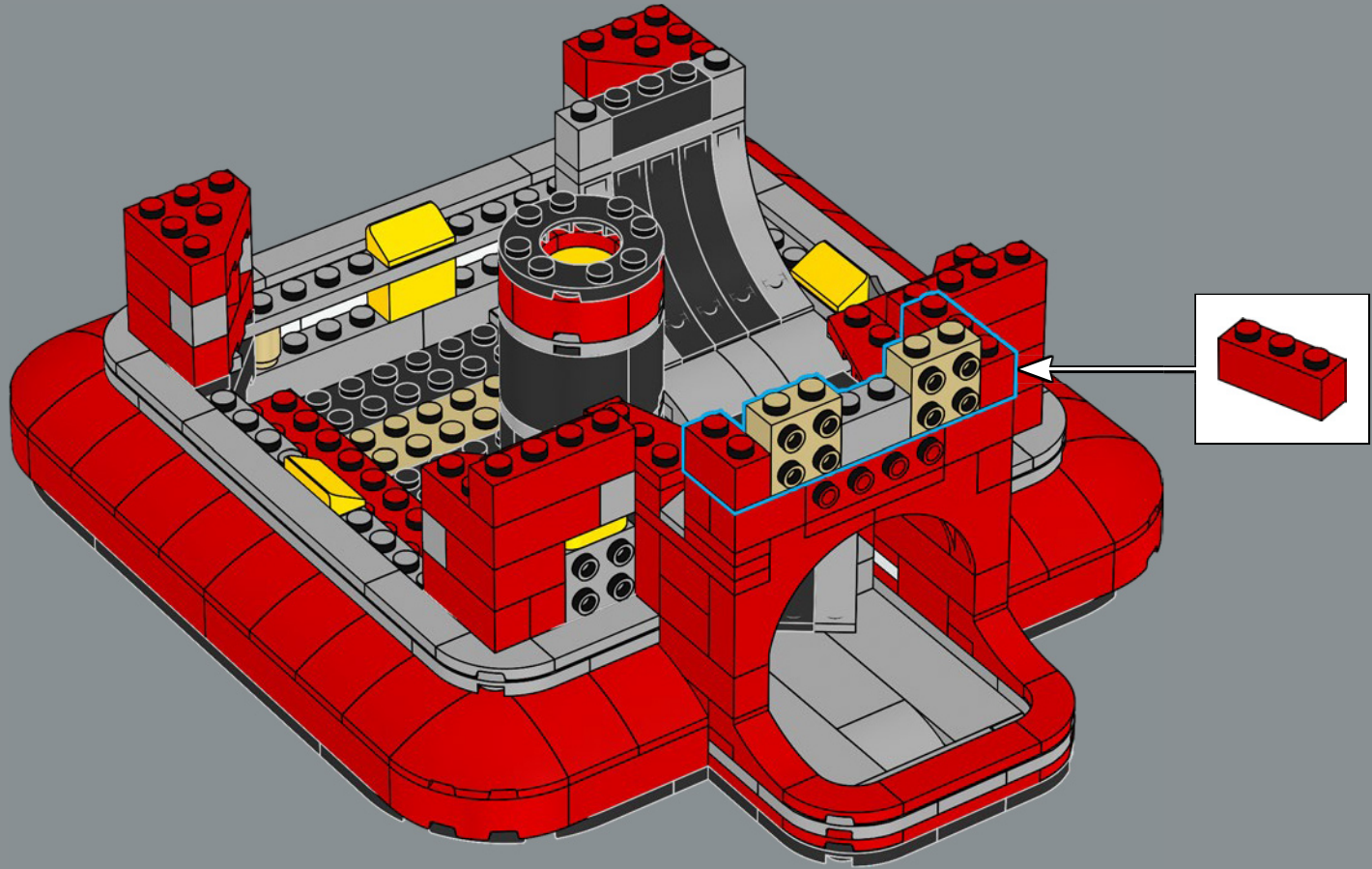

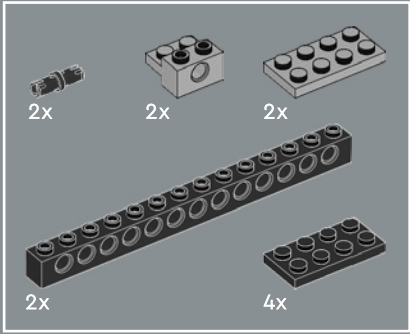
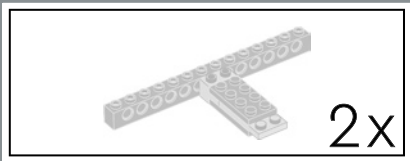

52

1

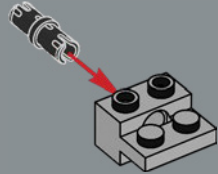

2

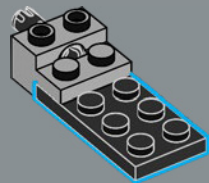

3

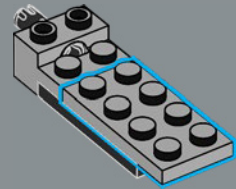

4

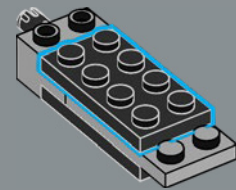

5

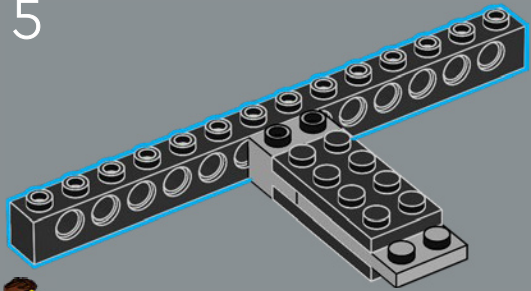

2x



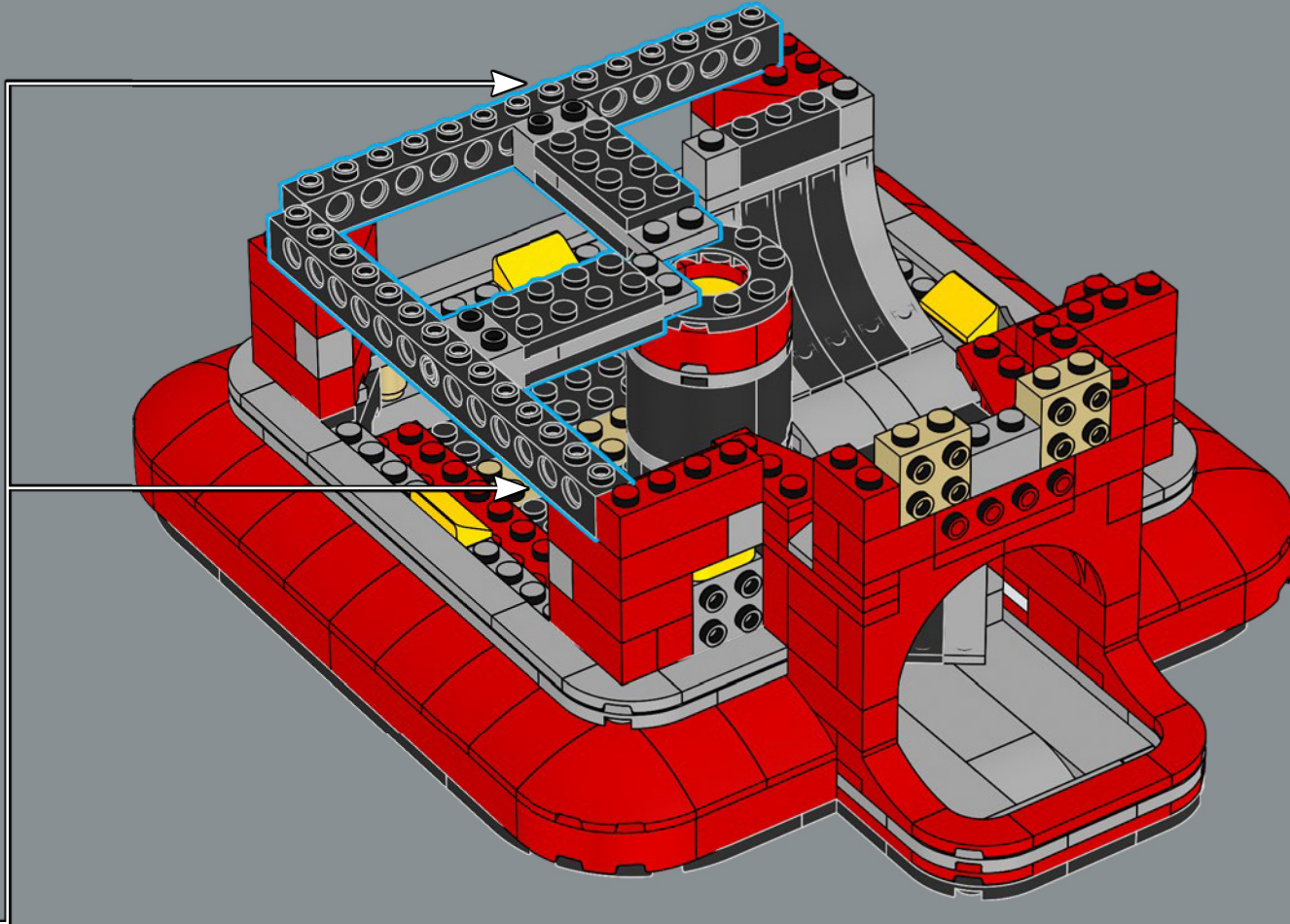

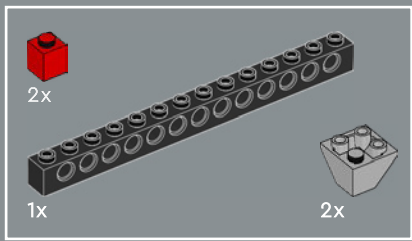

53

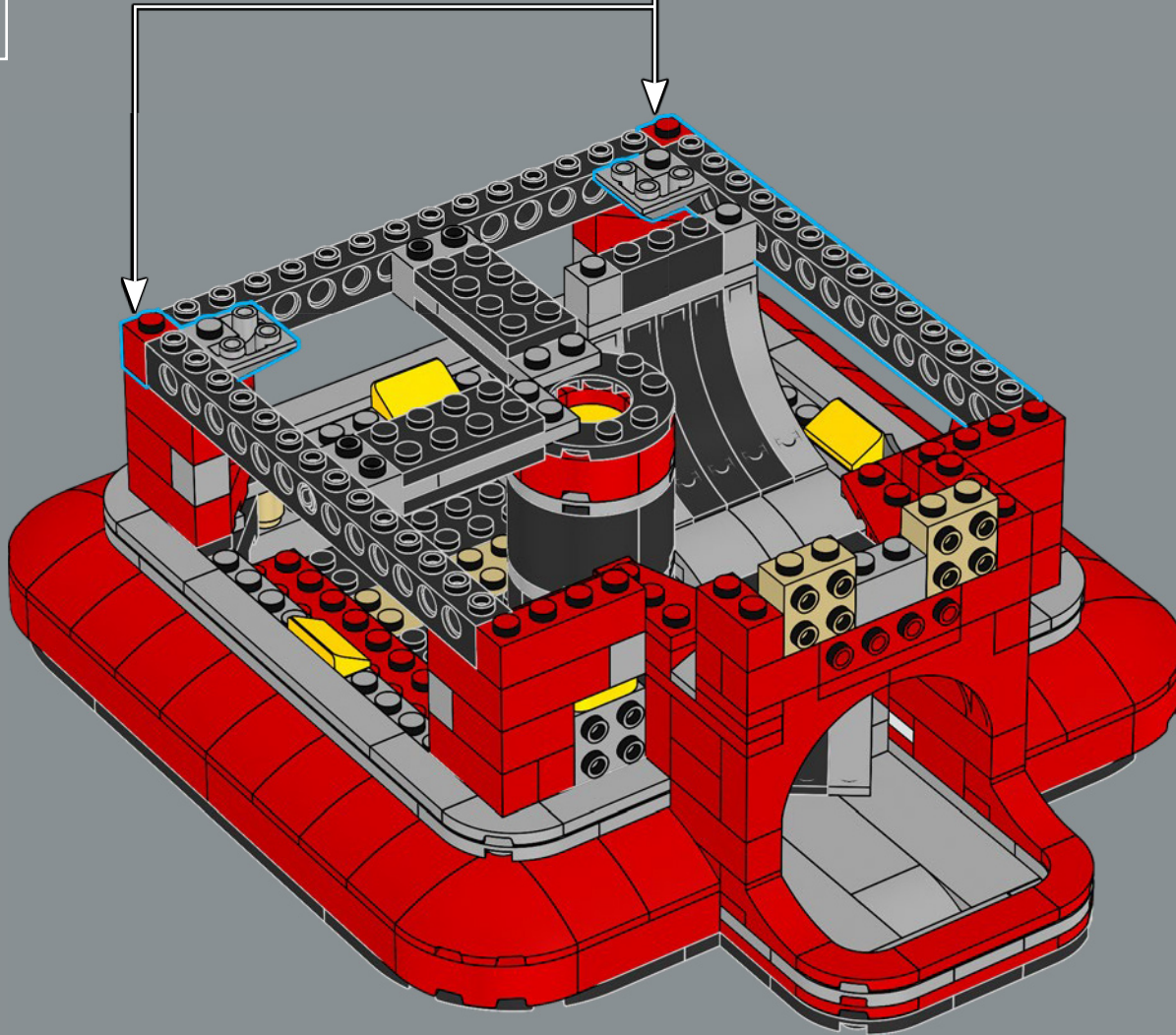
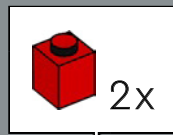

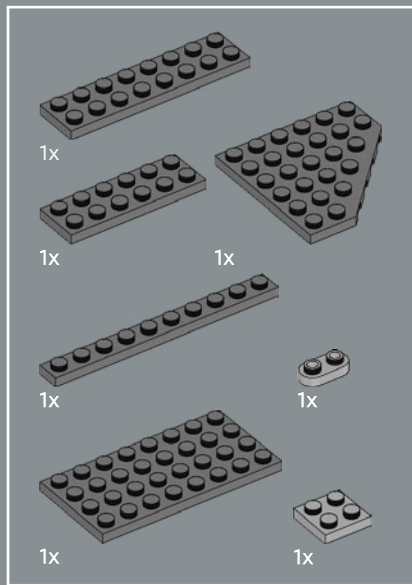

54

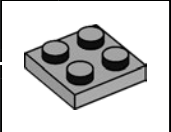
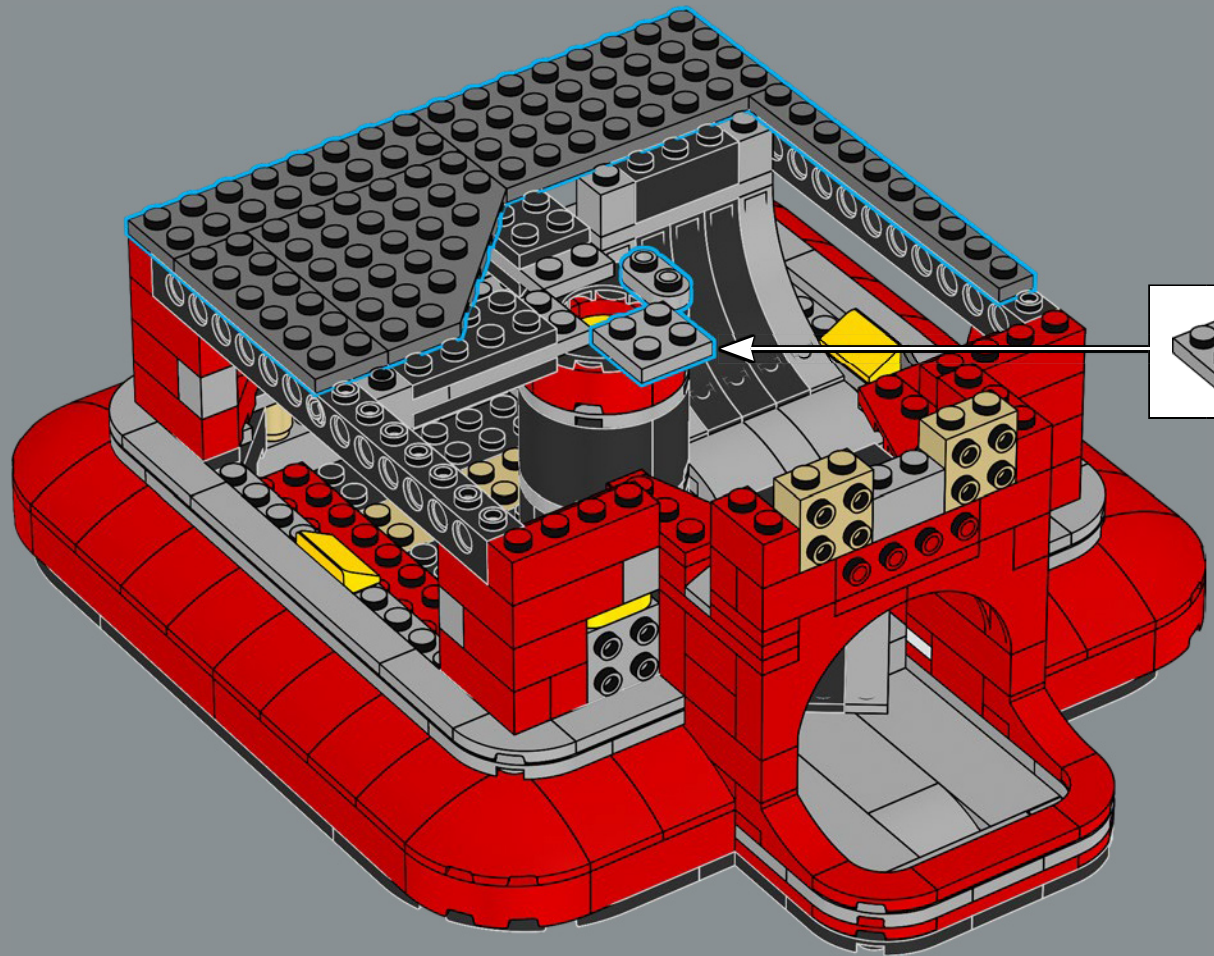

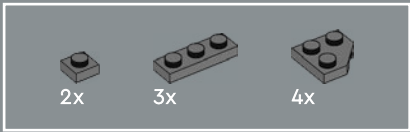

55

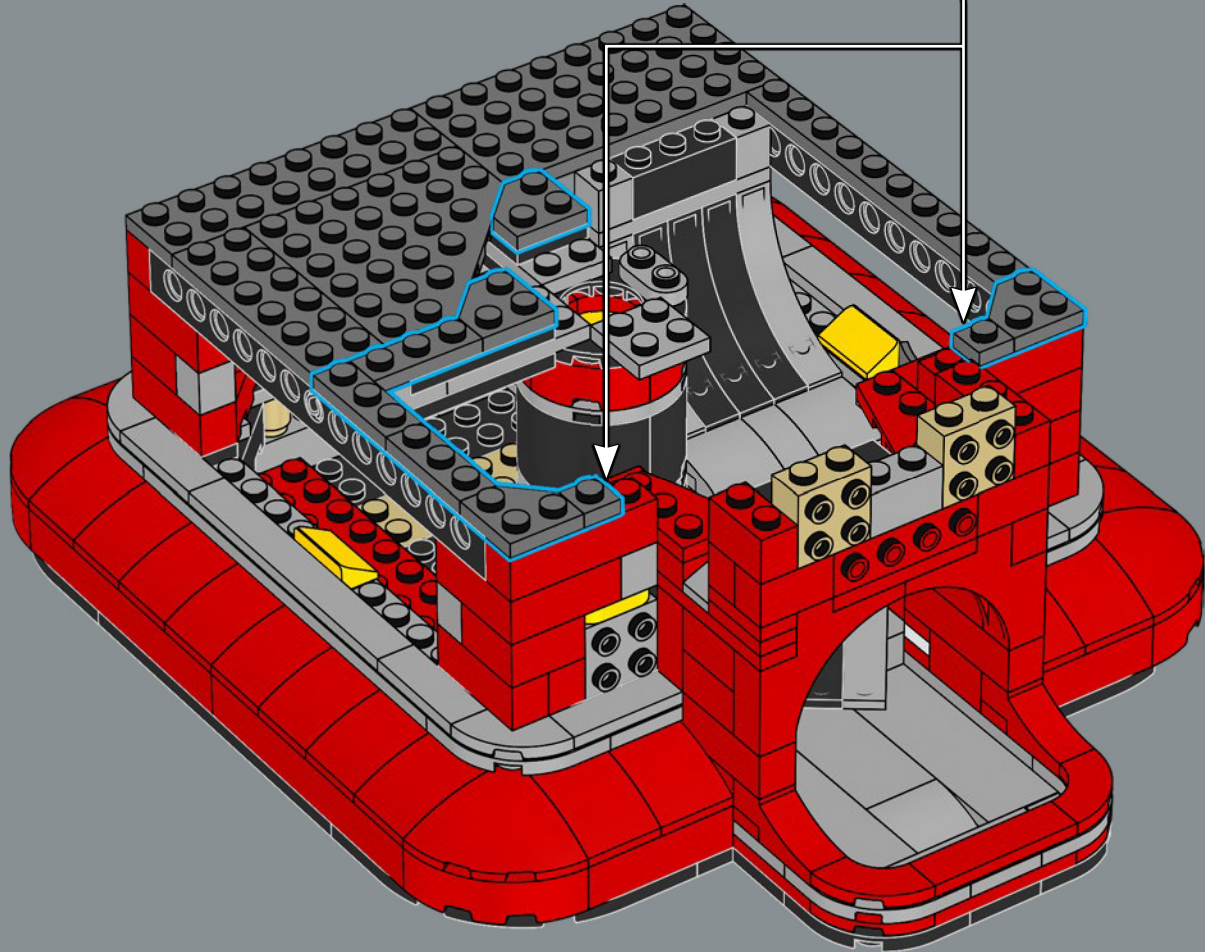

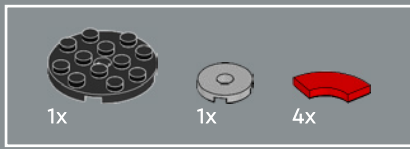

56

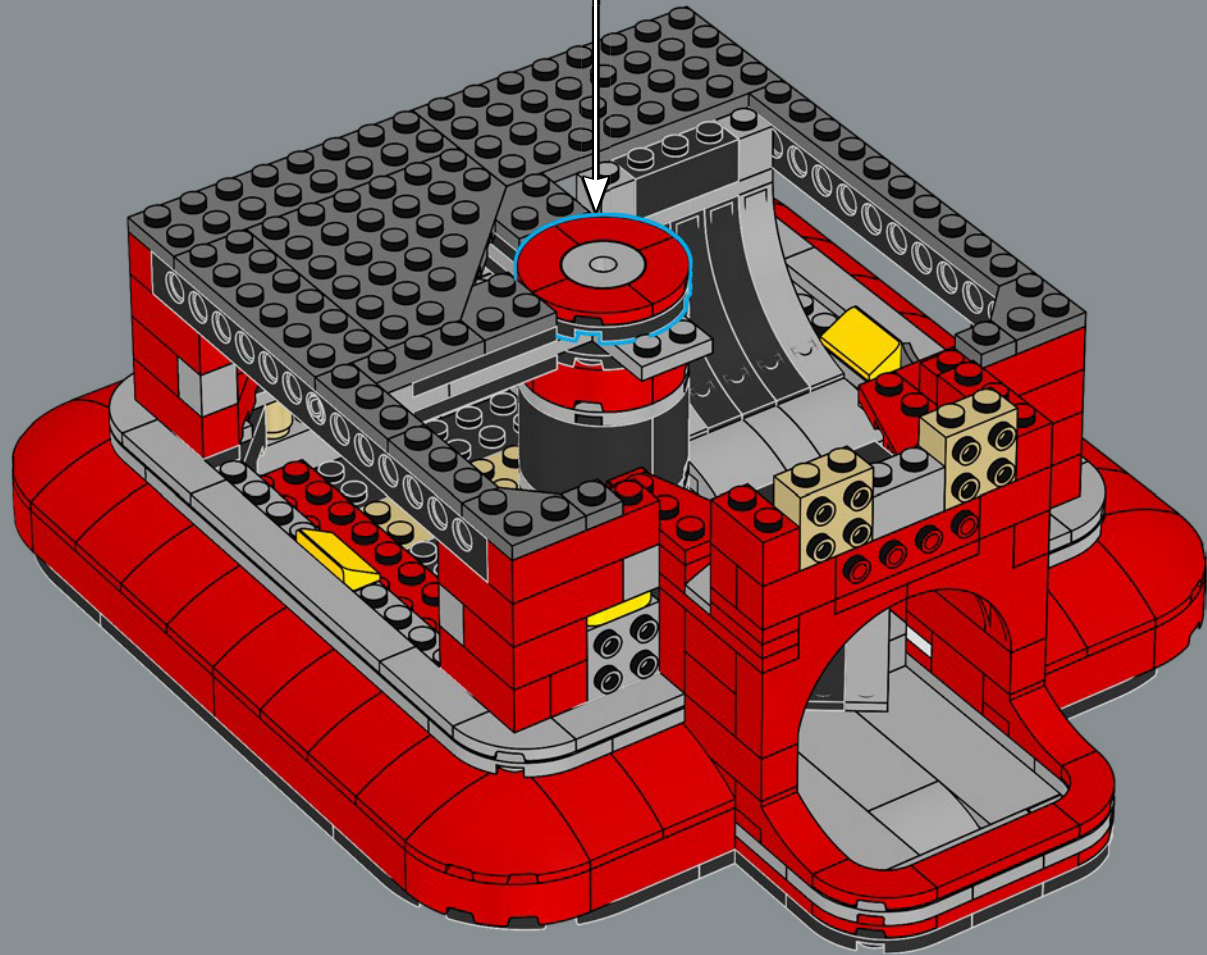
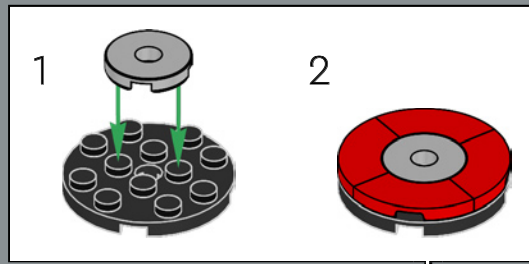

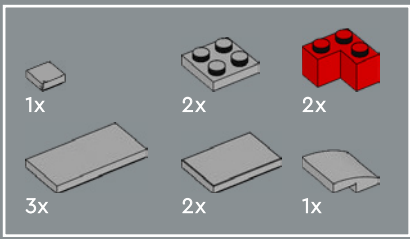

57

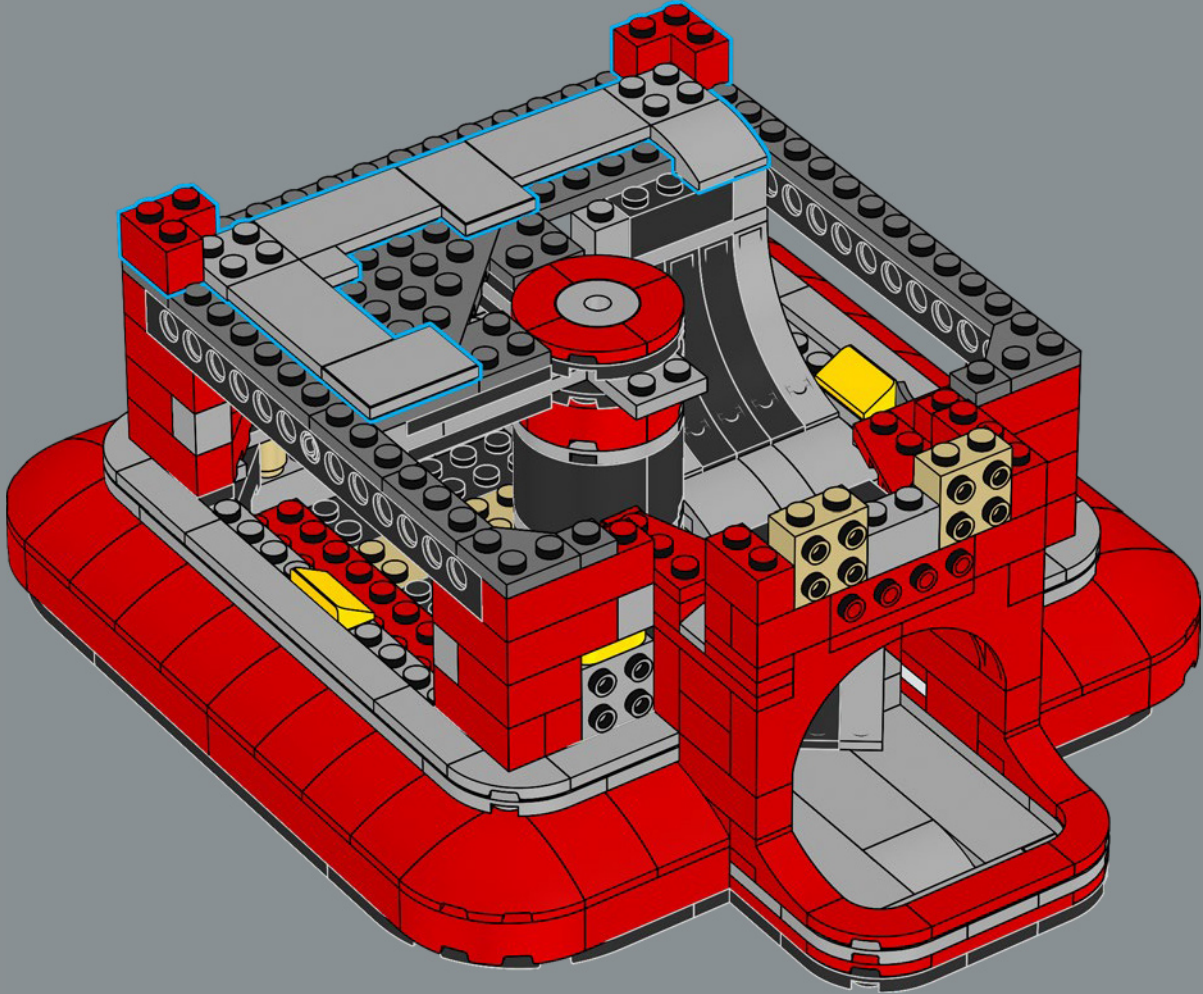

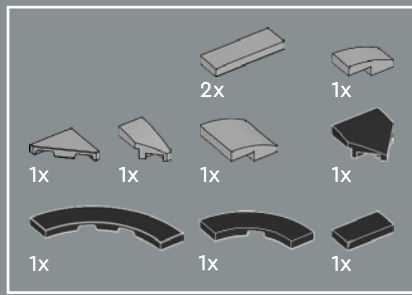

58

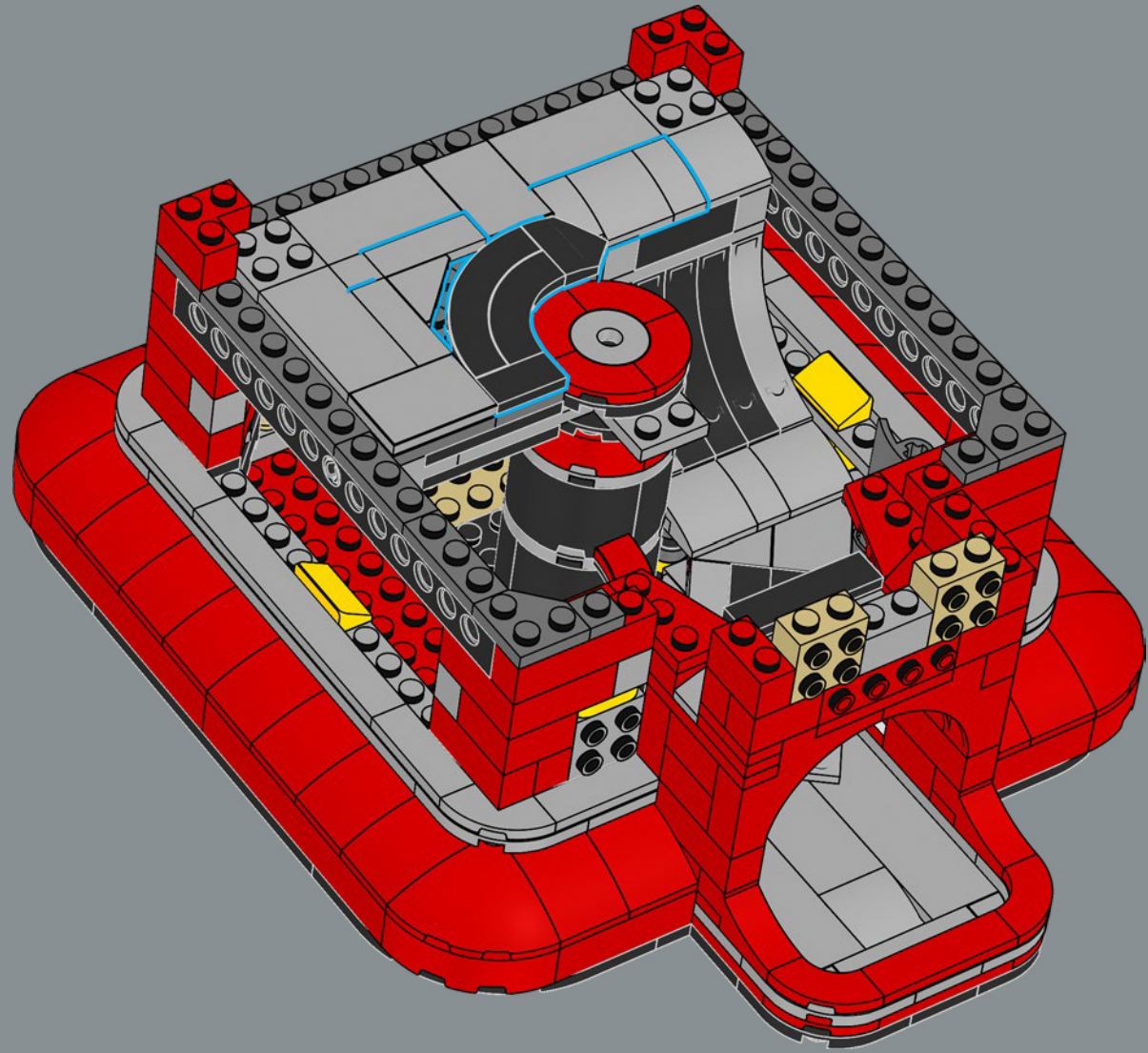

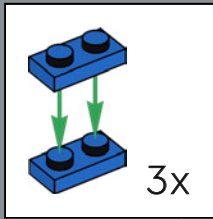
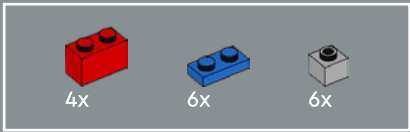

59

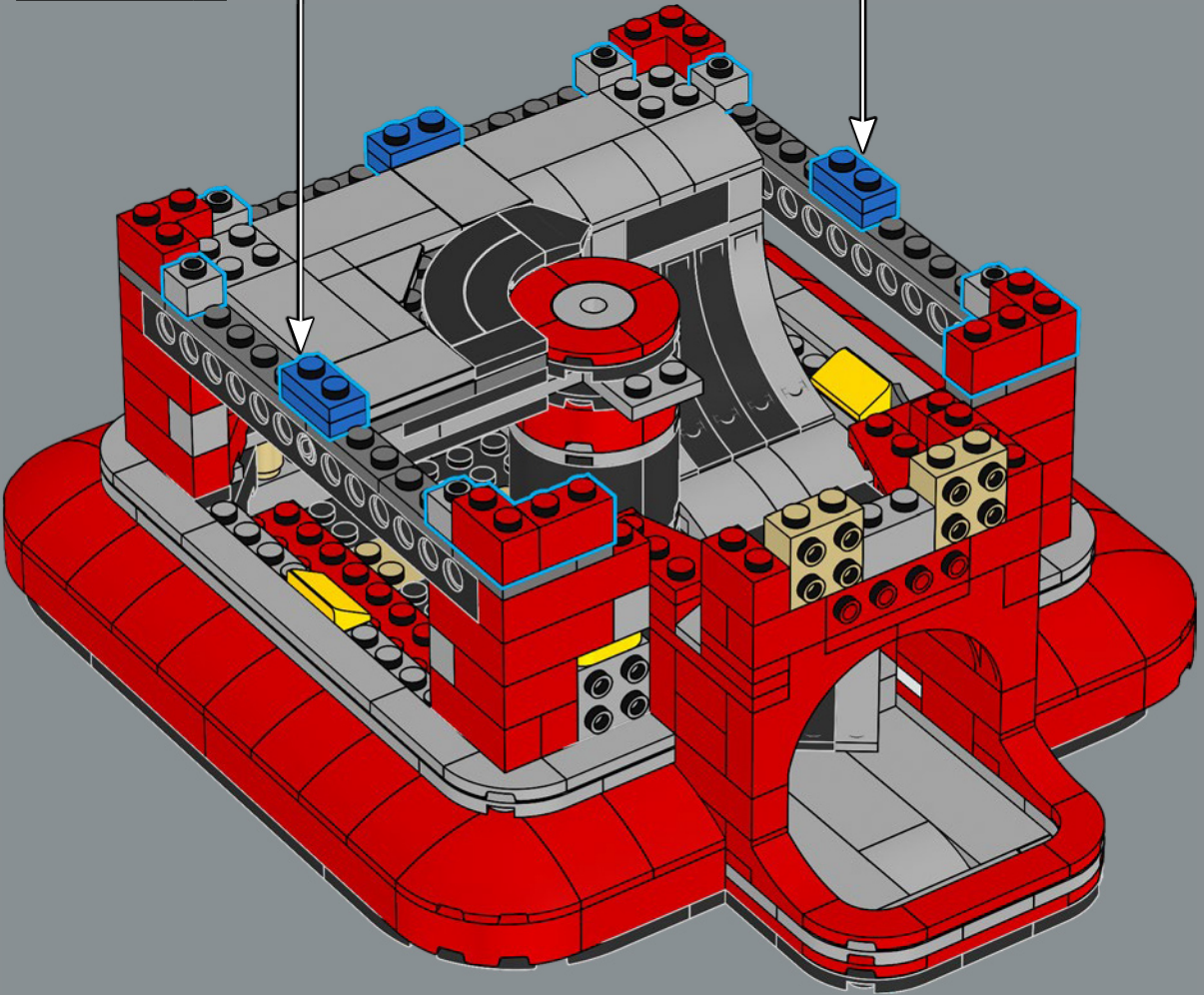

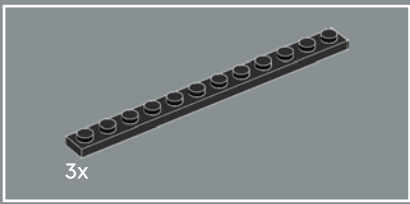

60

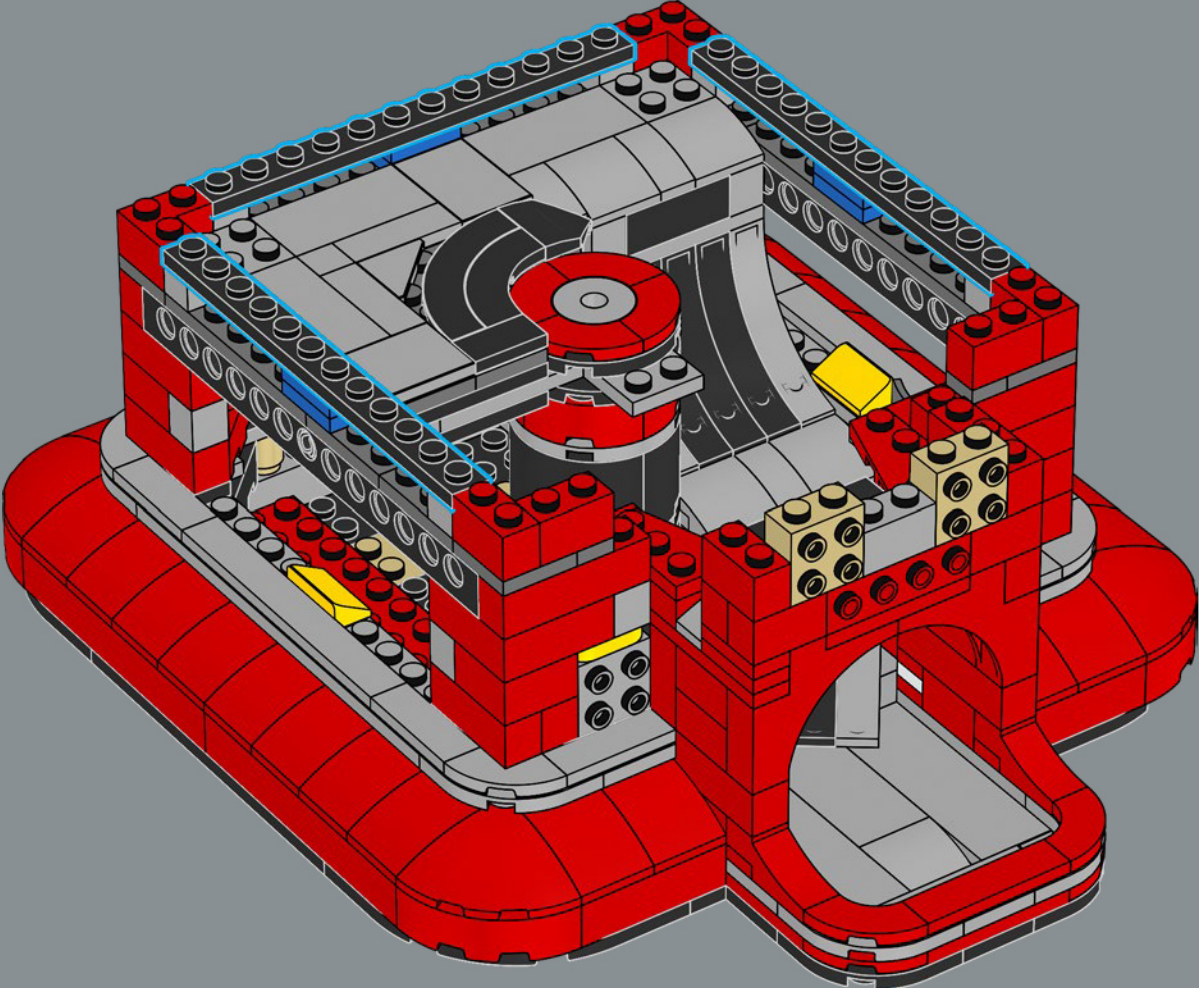

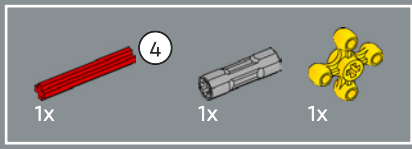

61

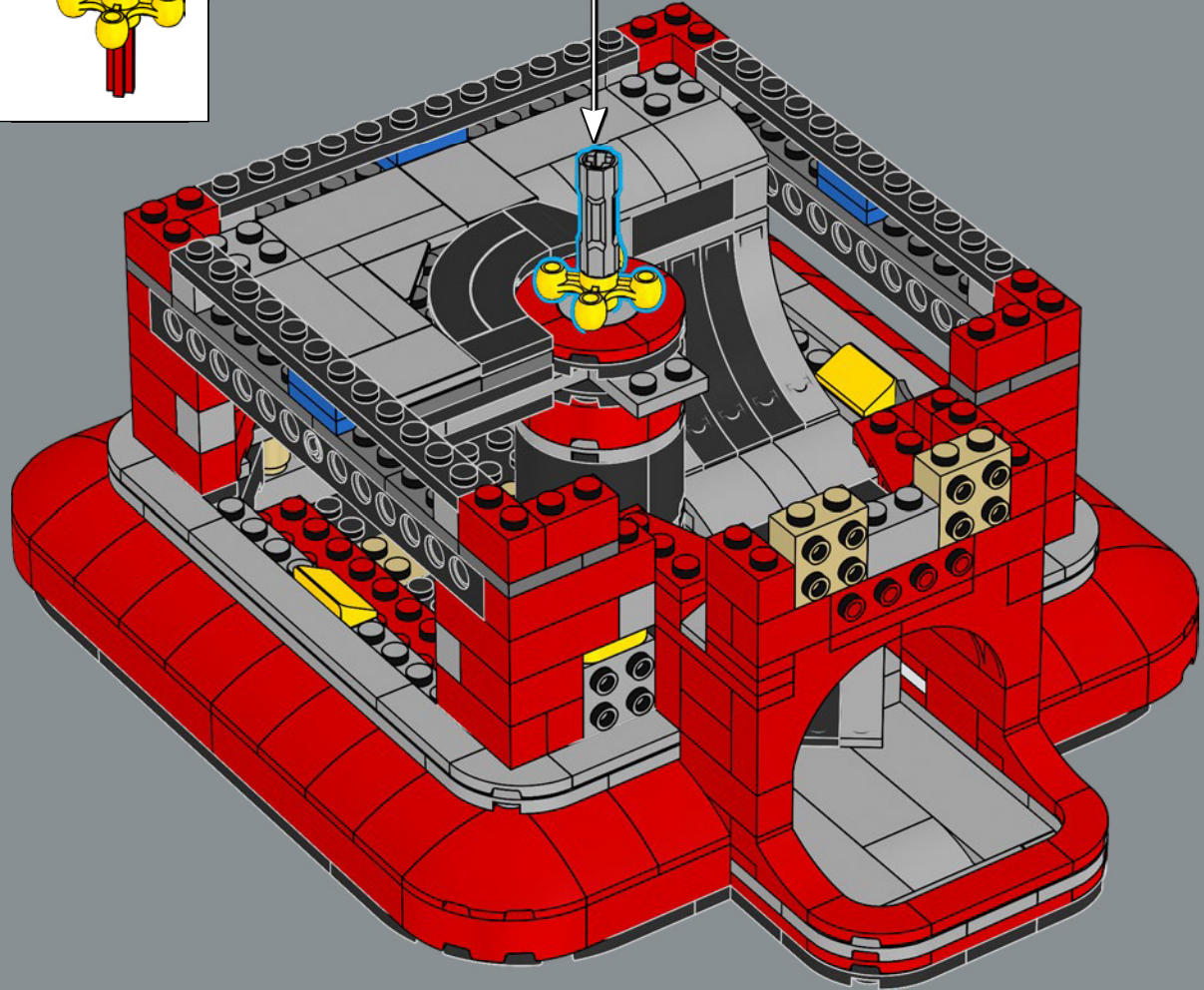
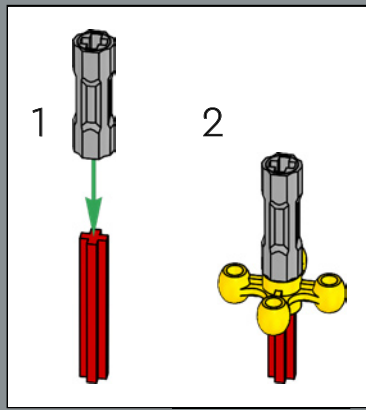

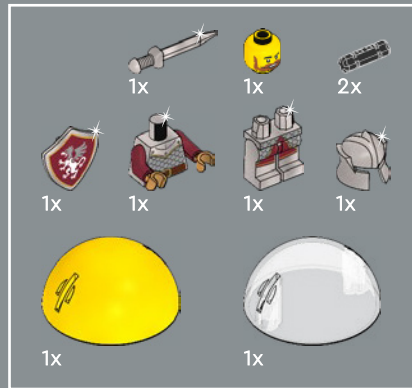
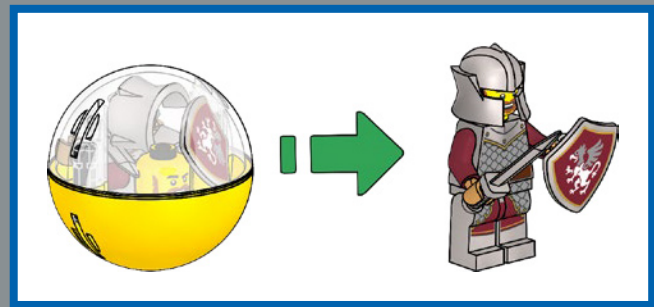

1

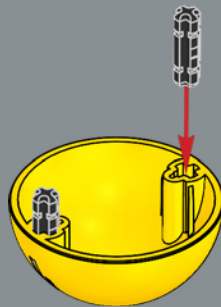

2

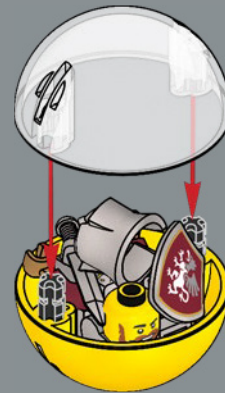

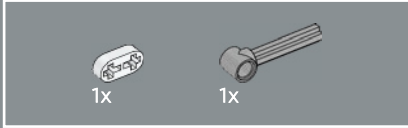
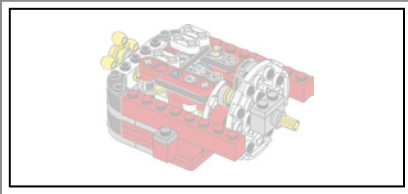

62

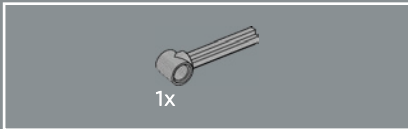
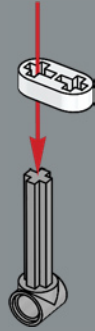

63

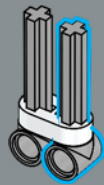

64

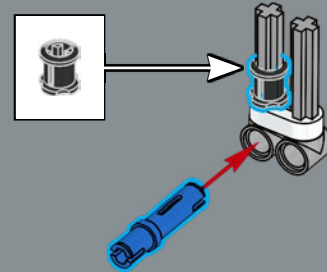

65

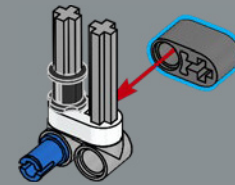



66

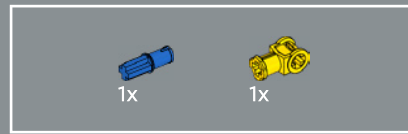
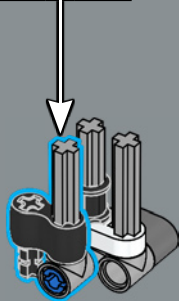
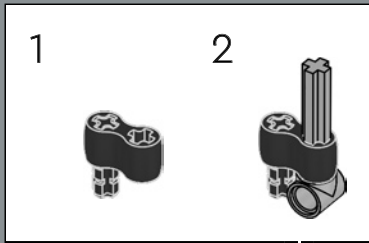

67

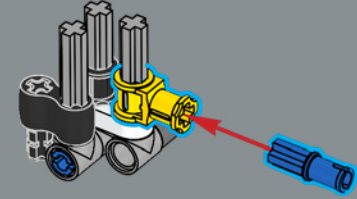

68

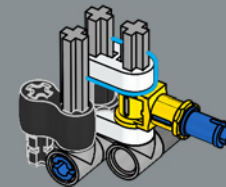

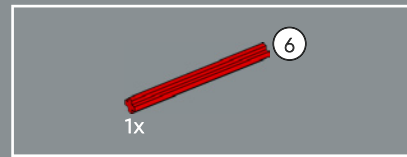
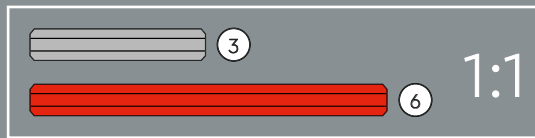
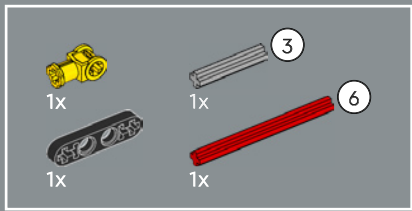

69

70

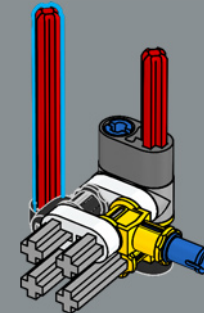
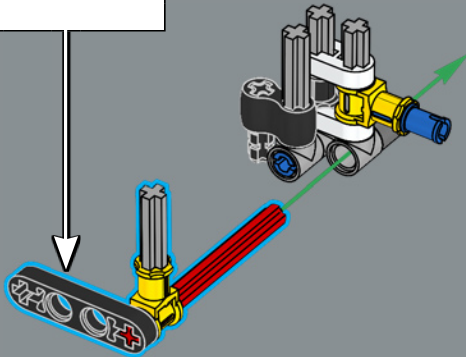
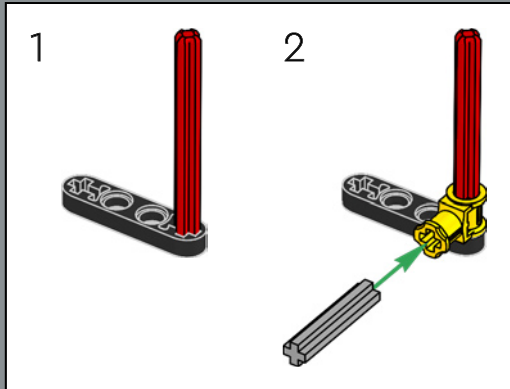



71

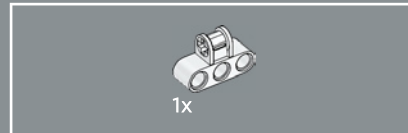
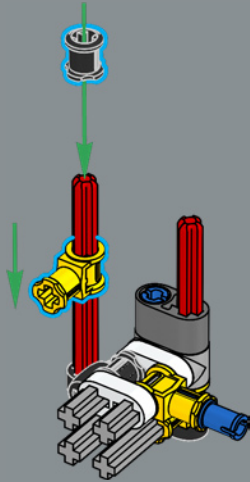

72

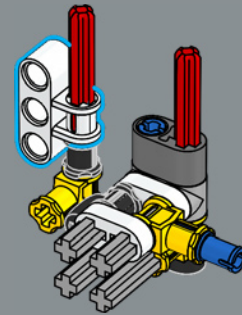



73

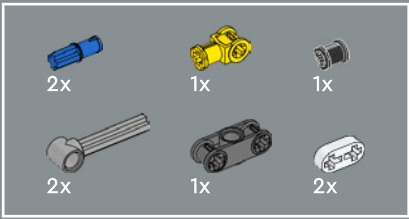
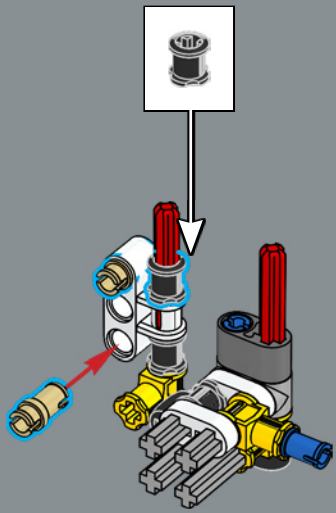

74

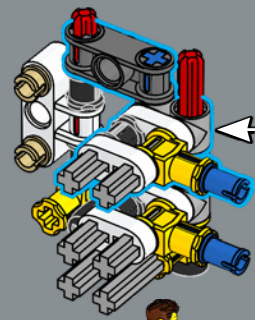
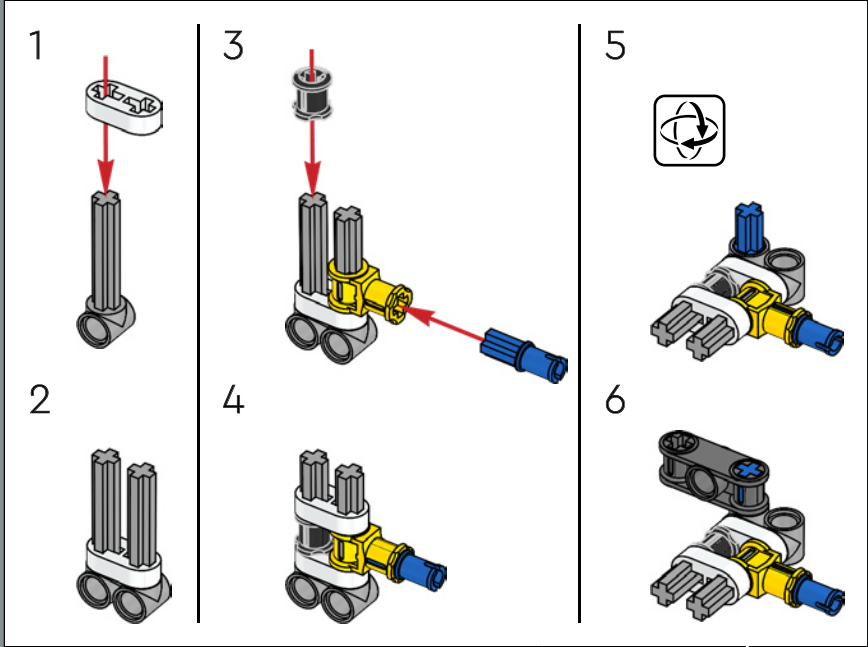

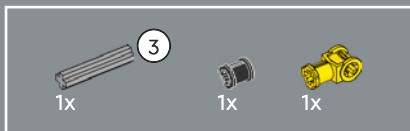

75

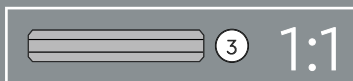
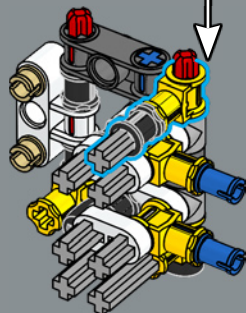
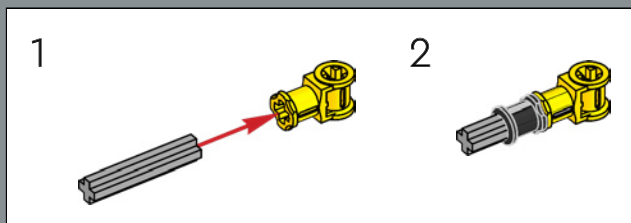

76

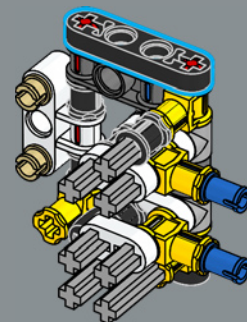

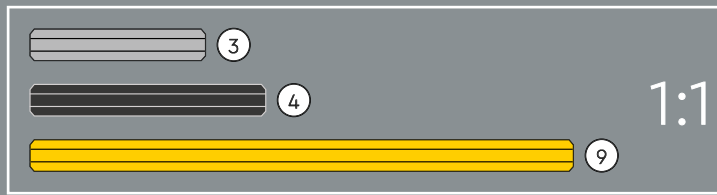
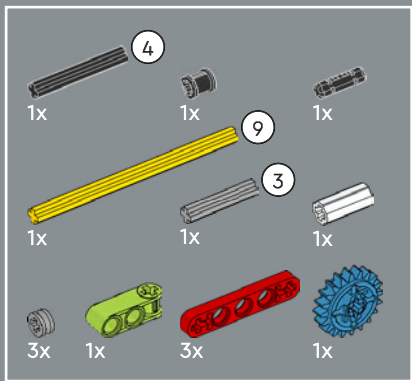

77

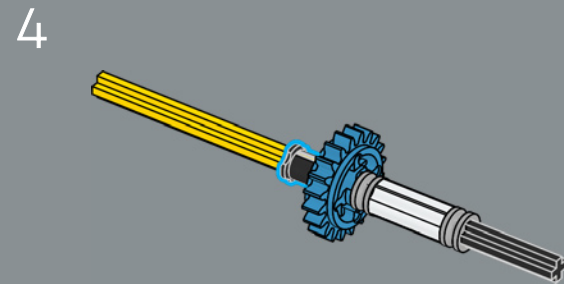
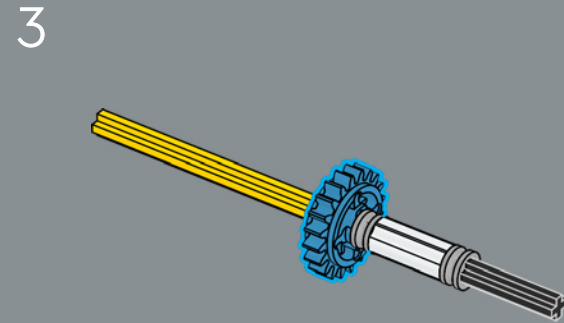
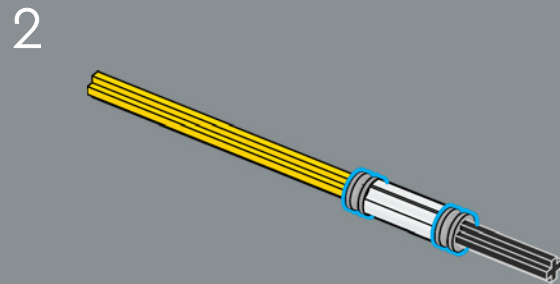
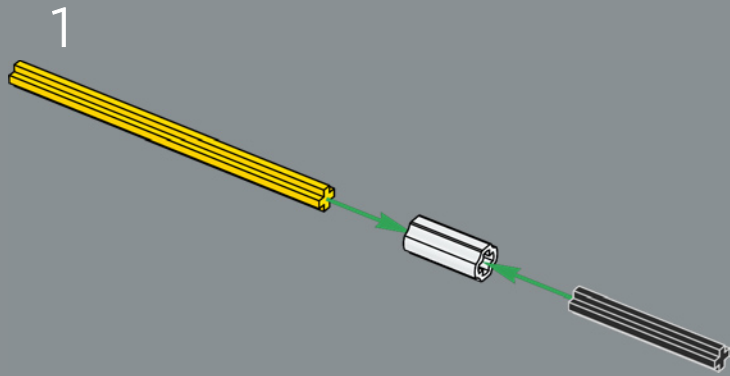

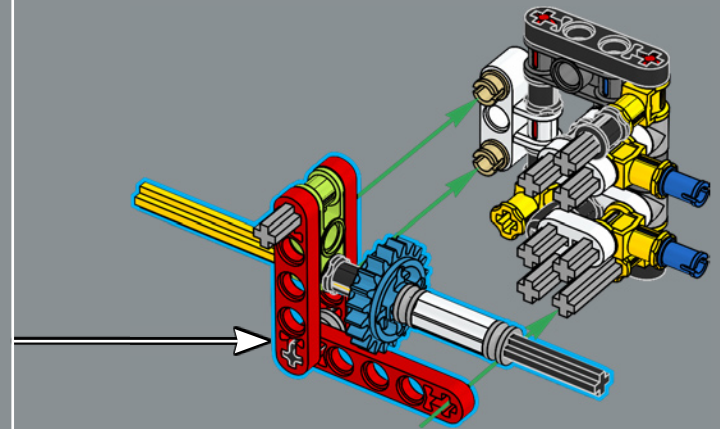
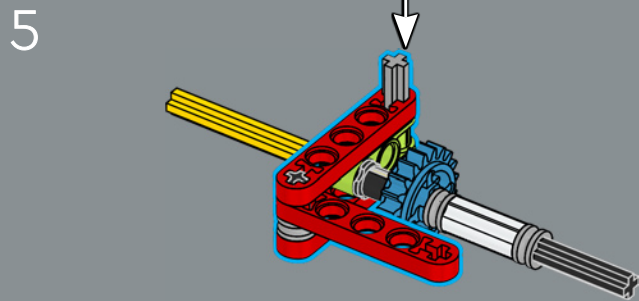
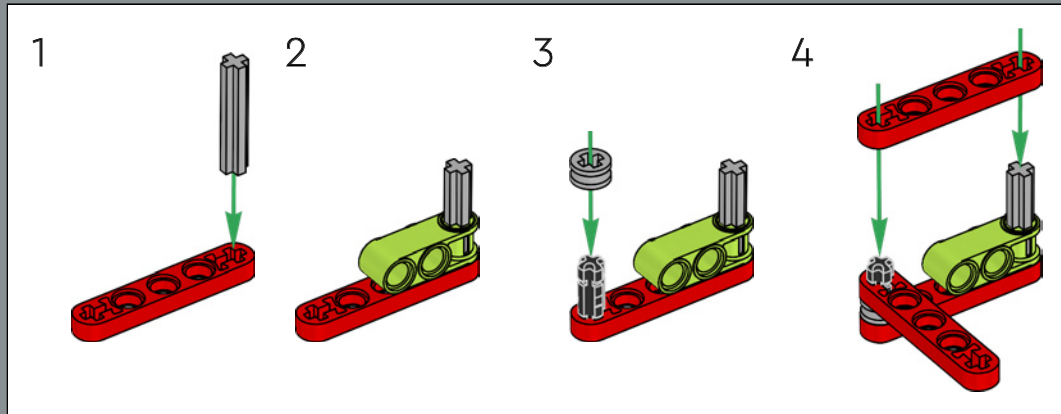

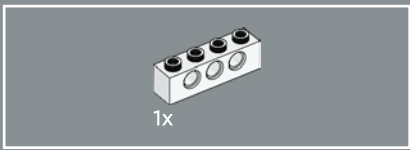

78

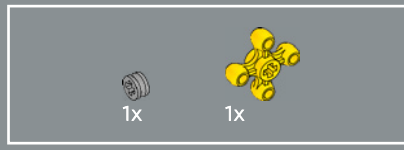
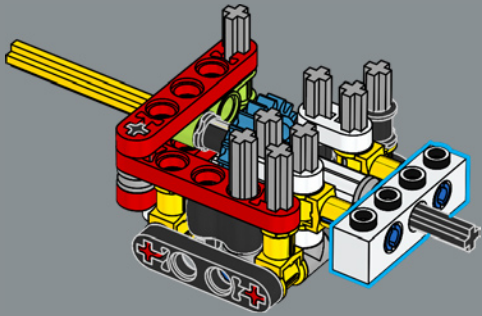

79

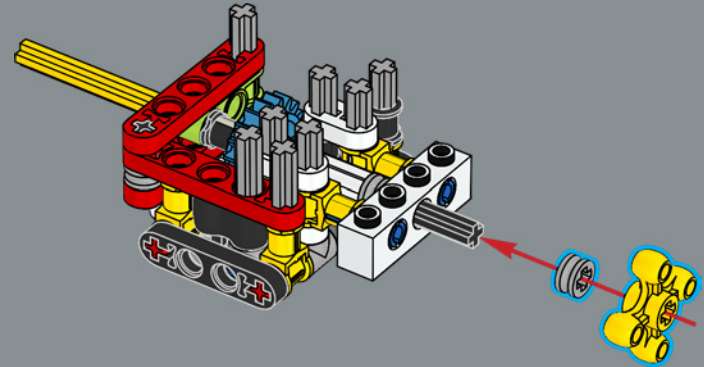



80

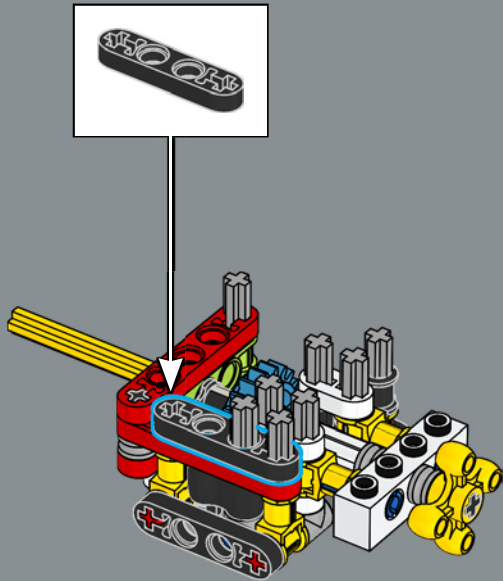

81

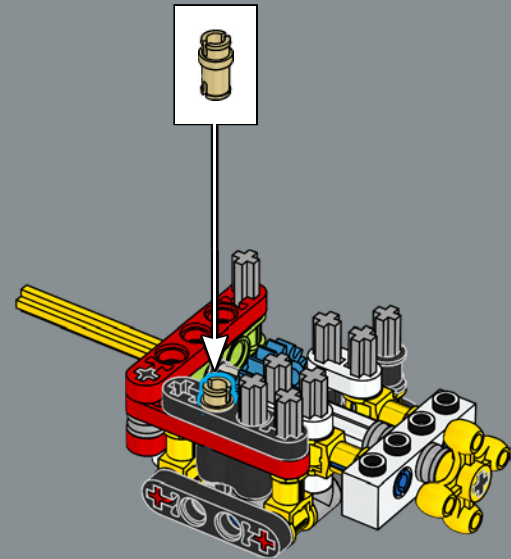

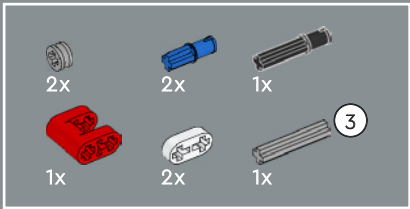

82

1

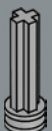

2

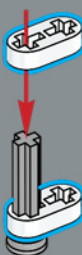

3



4

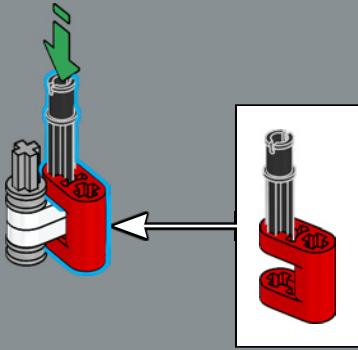

5

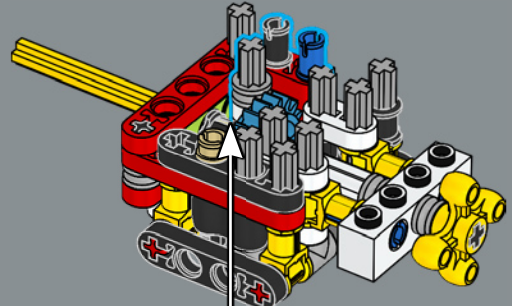
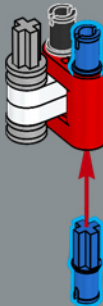



83

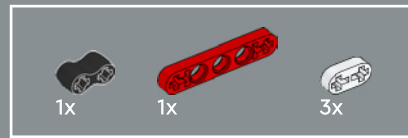
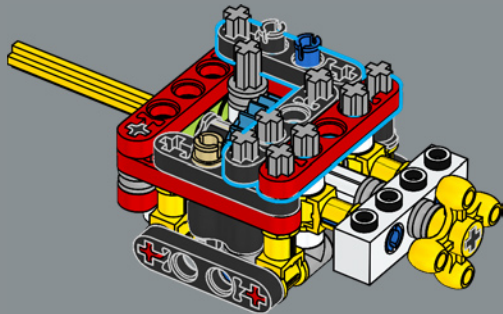

84

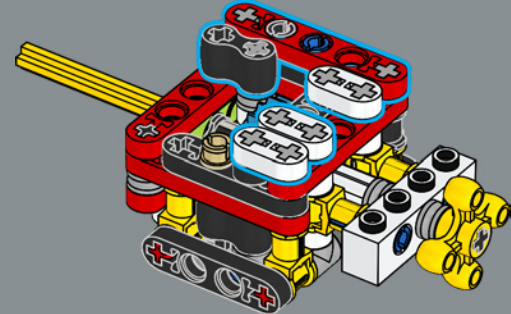

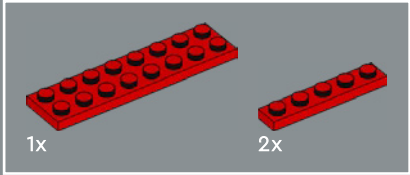
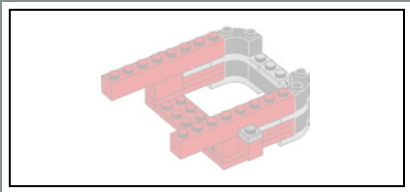

85

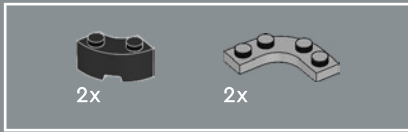
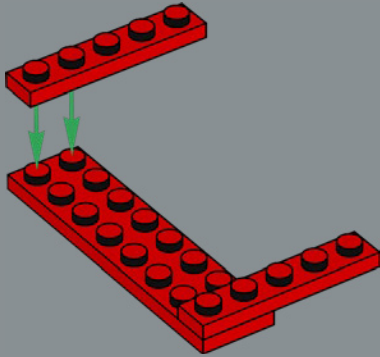

86

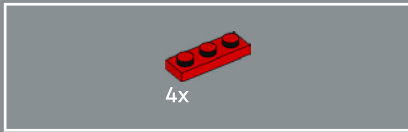
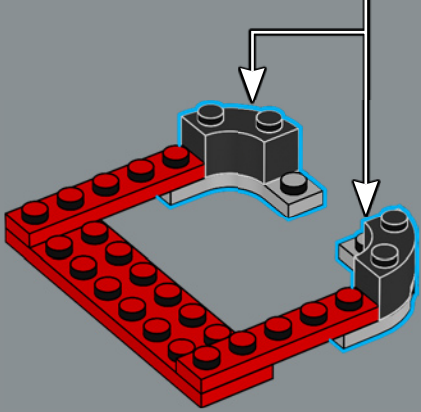
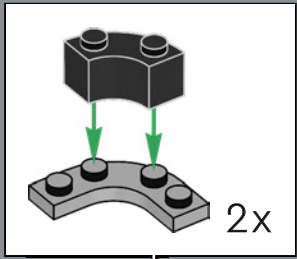

87

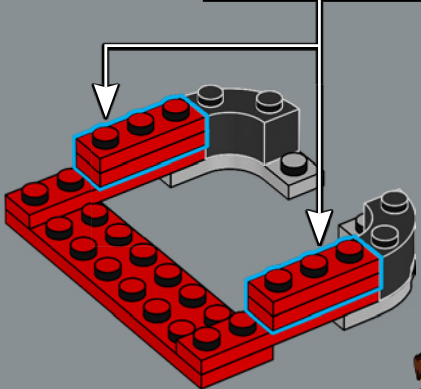
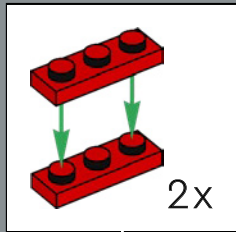

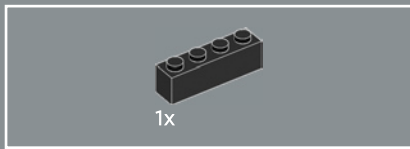

88

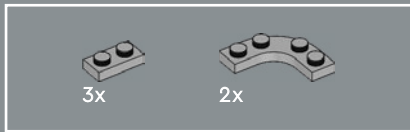
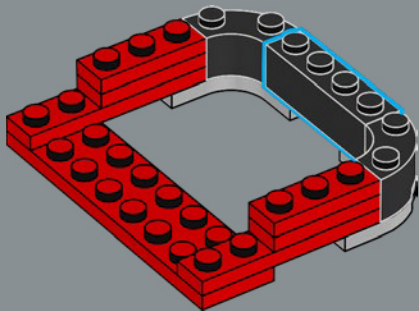

89

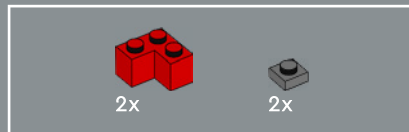
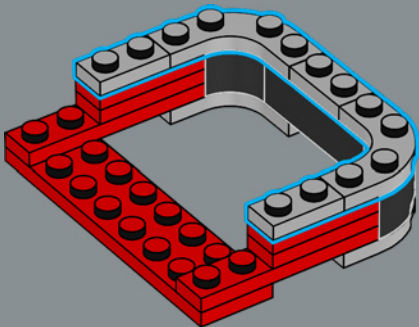

90

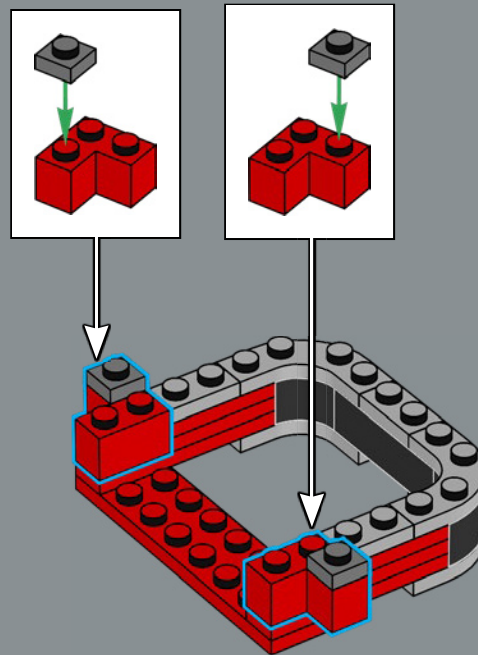

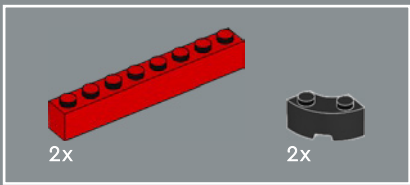

91

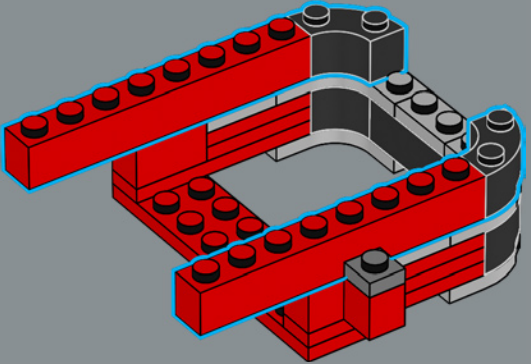

92

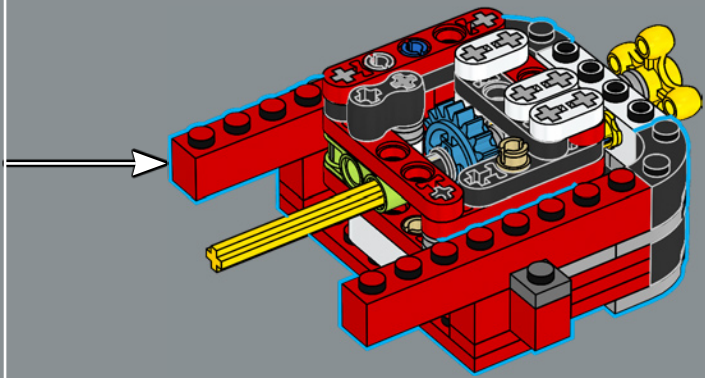



93

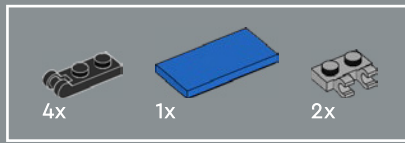
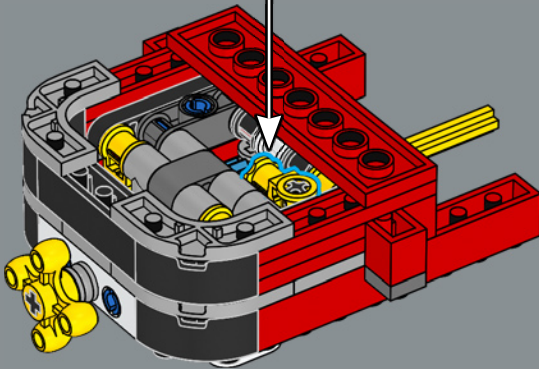

94

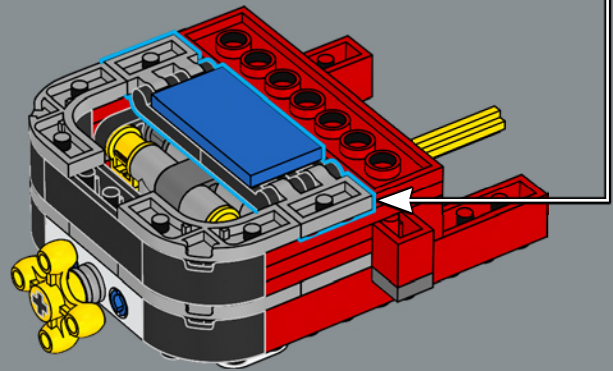
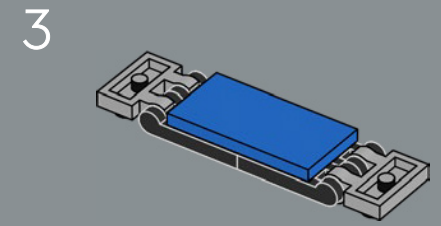
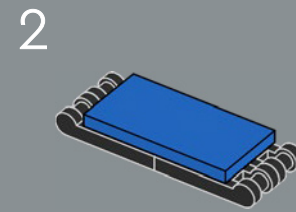
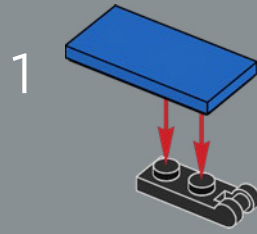
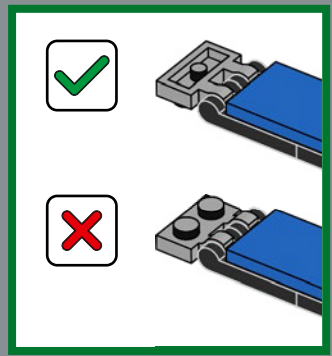

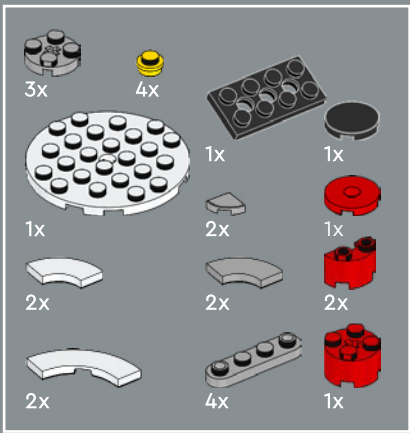

95

1



2

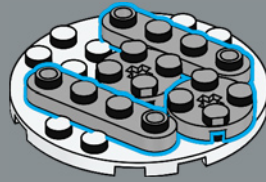

3

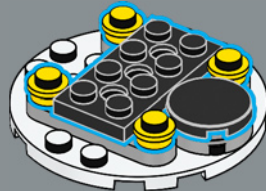

4

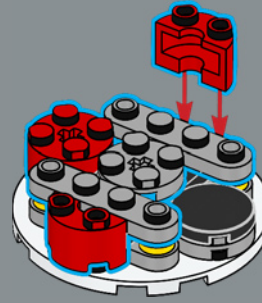

5

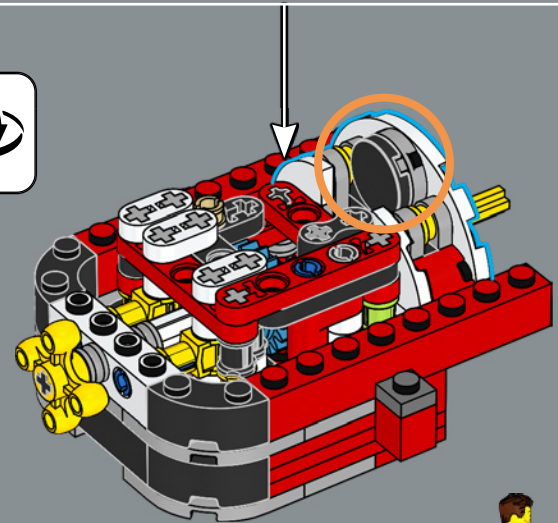
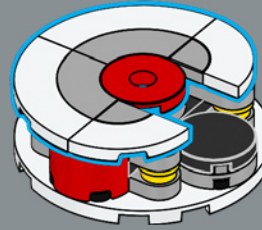

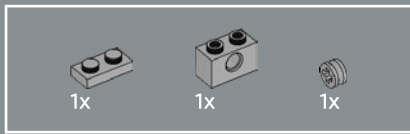

96

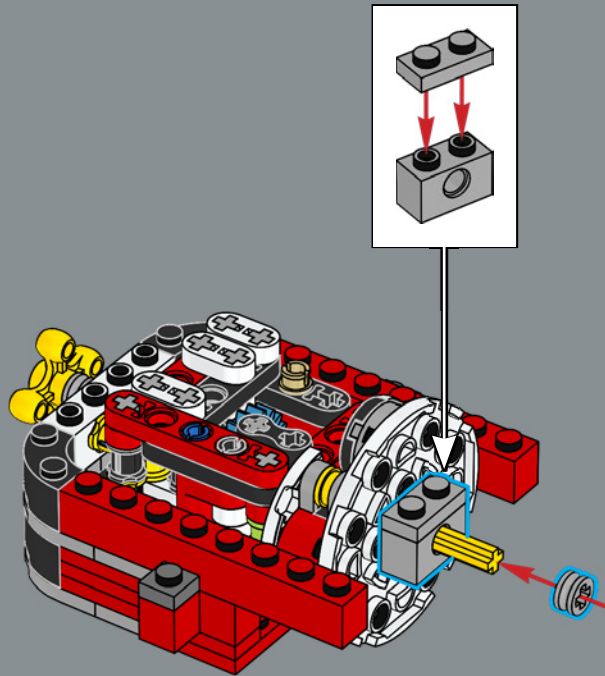

97

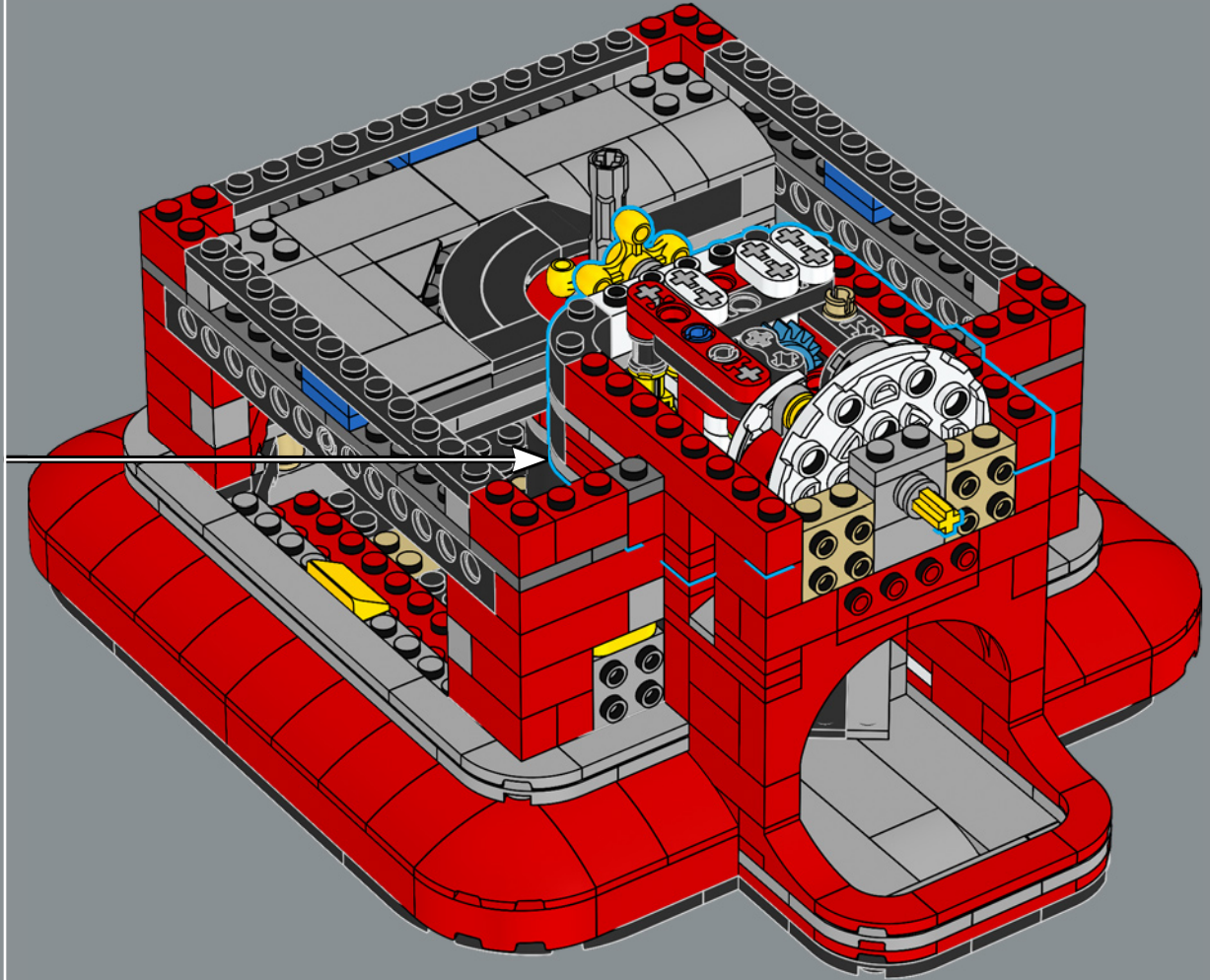

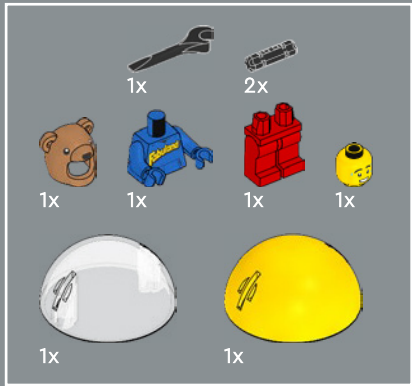
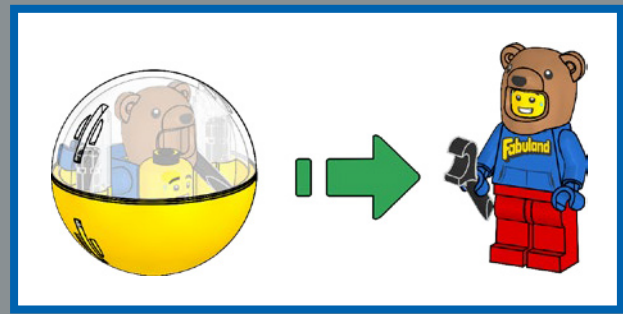

1

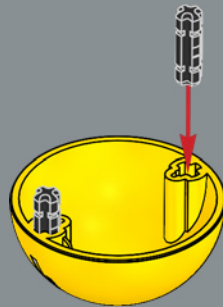

2

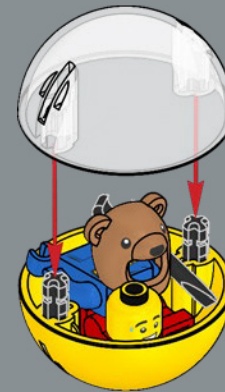

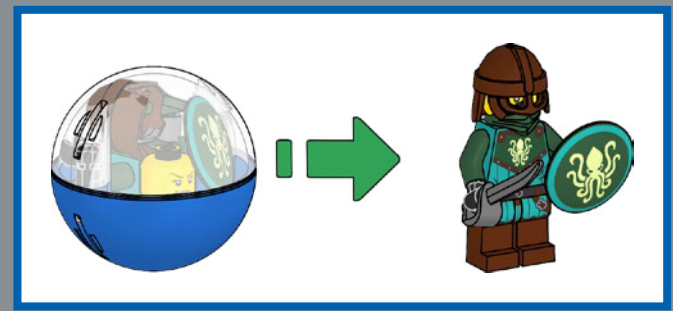

1

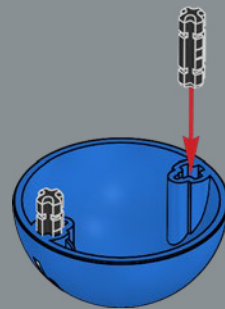

2

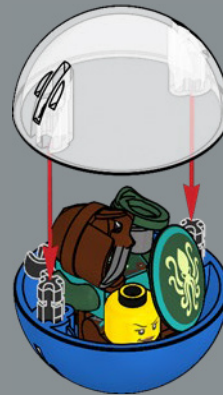

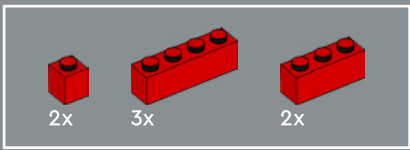

98

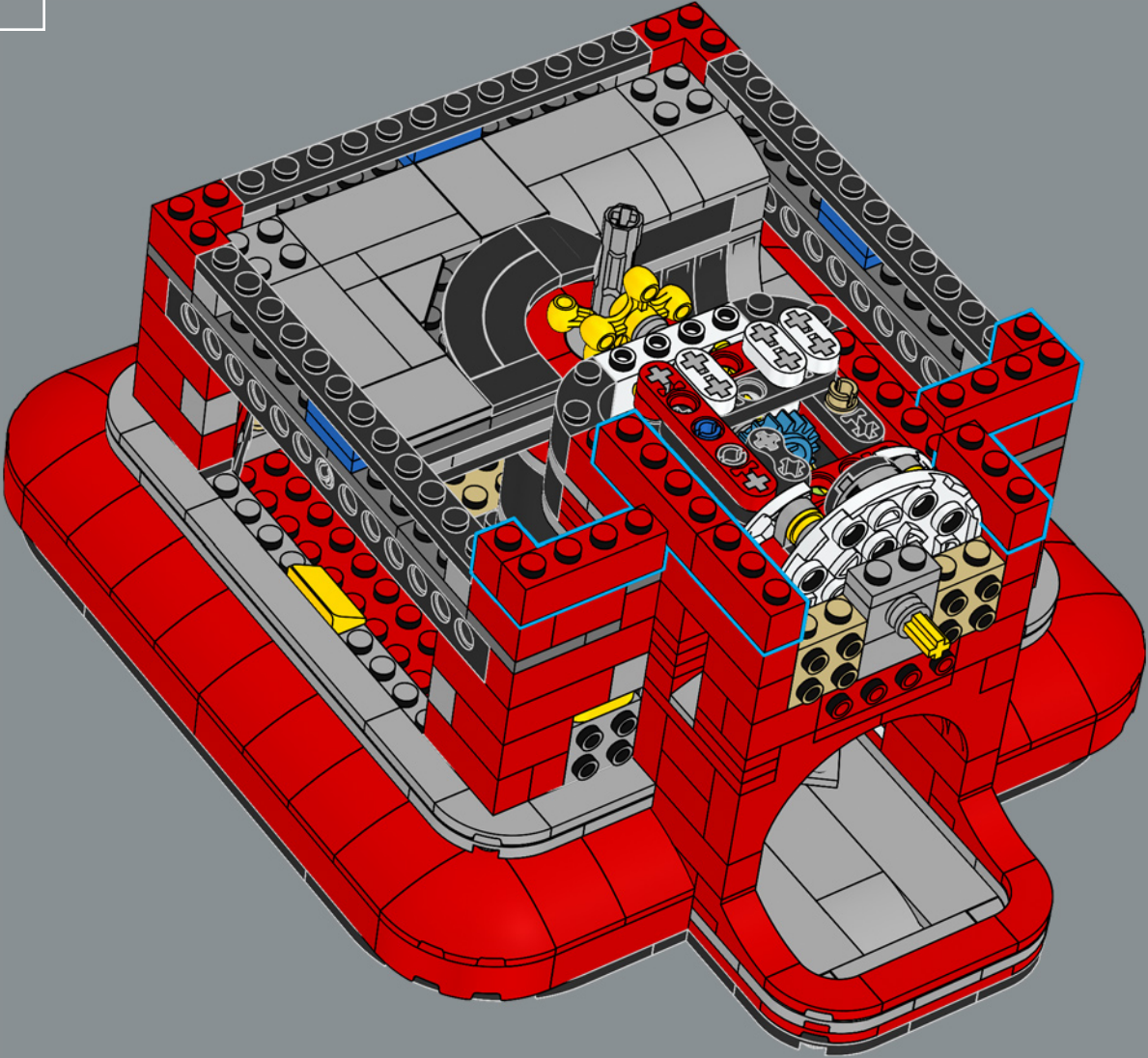

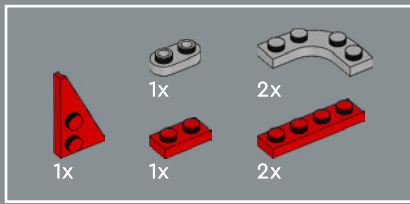

99

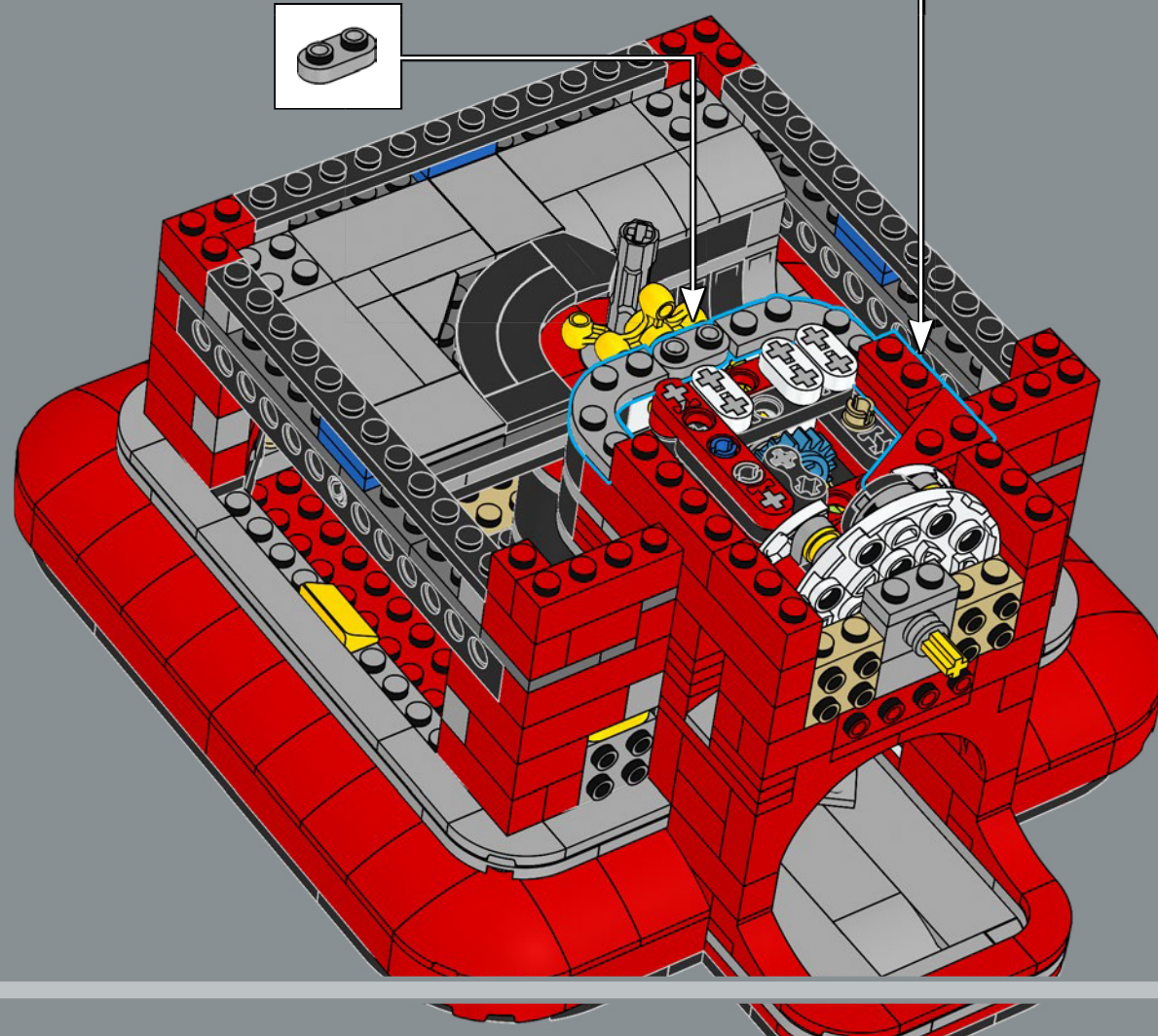
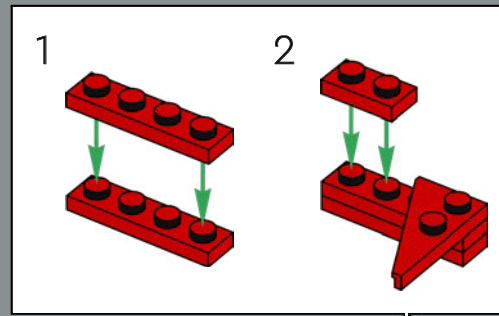

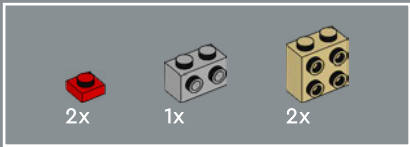

100

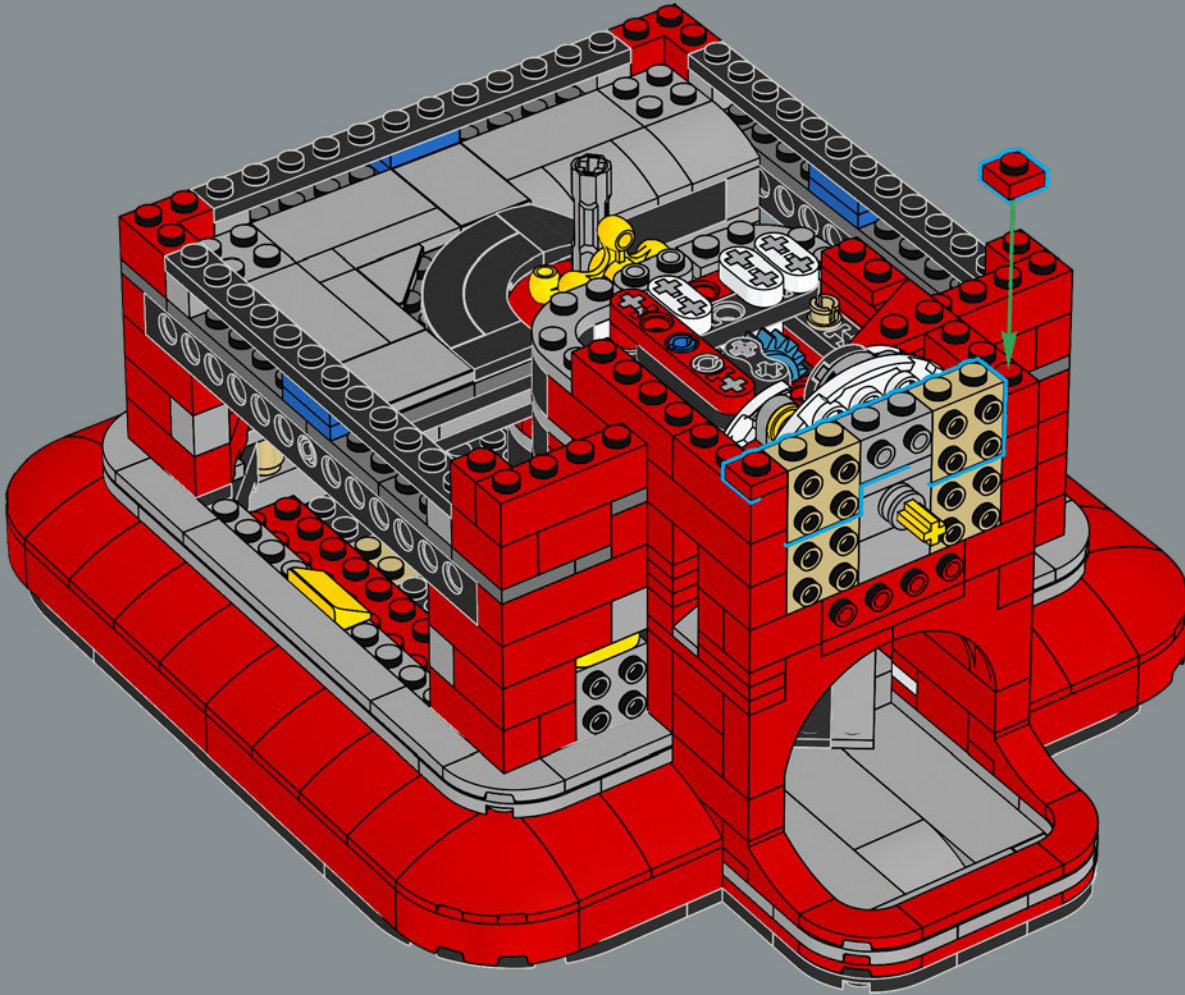

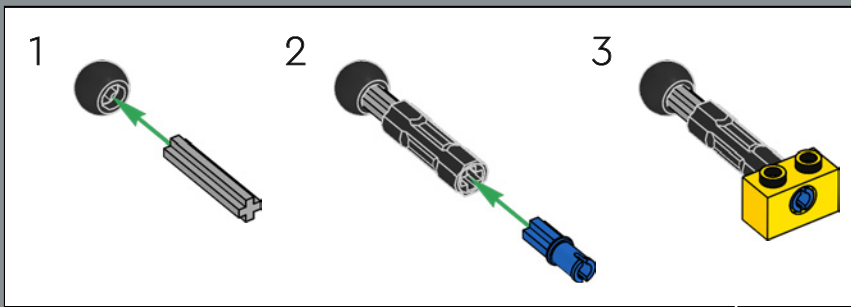
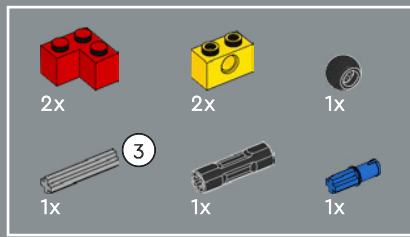

101

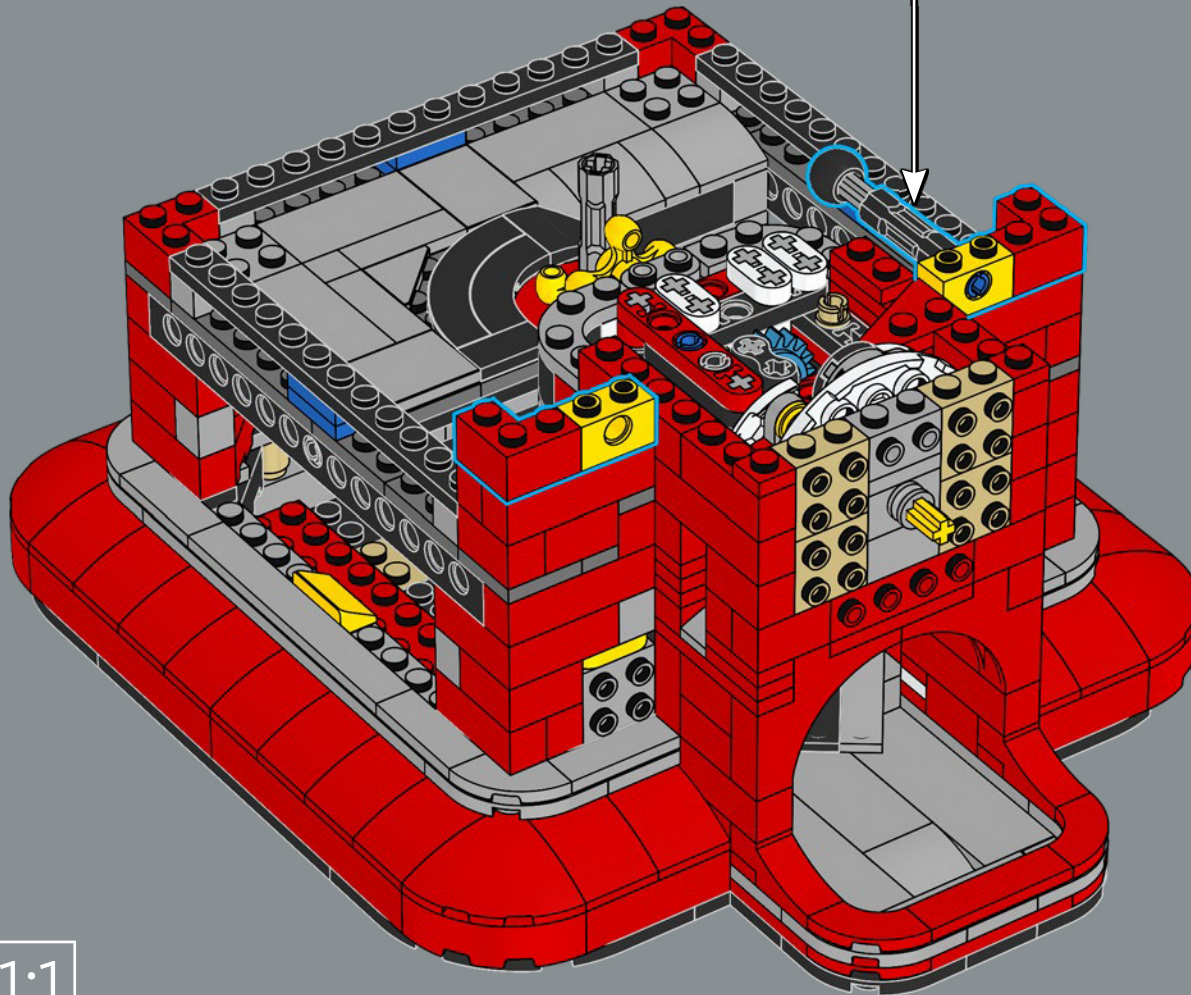

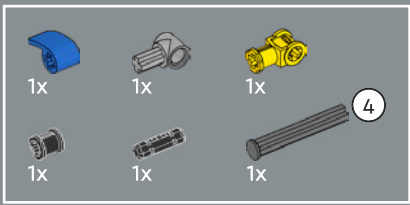

102

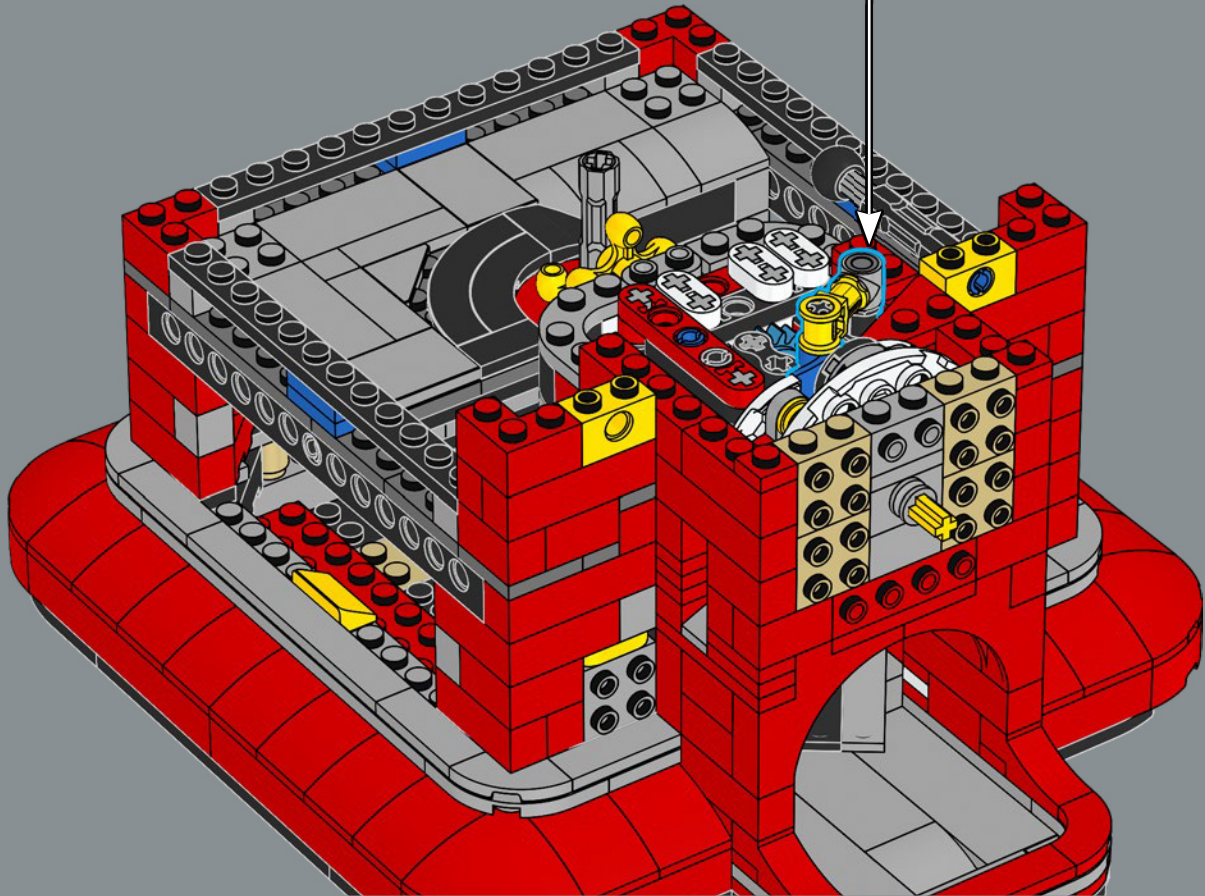
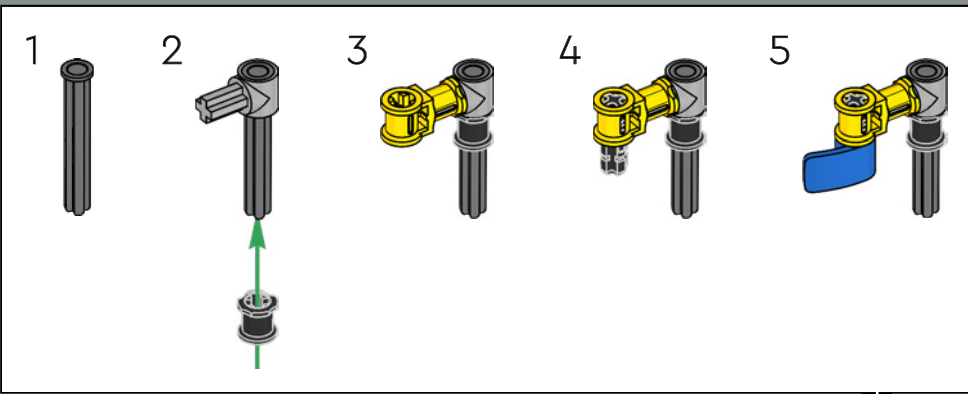

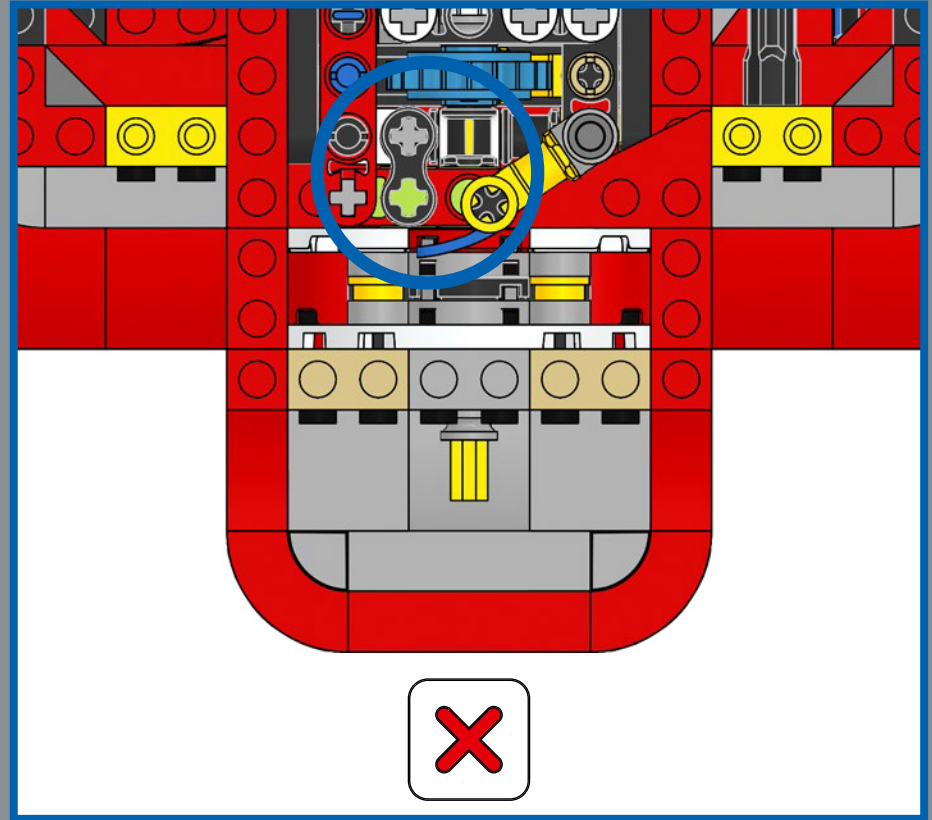
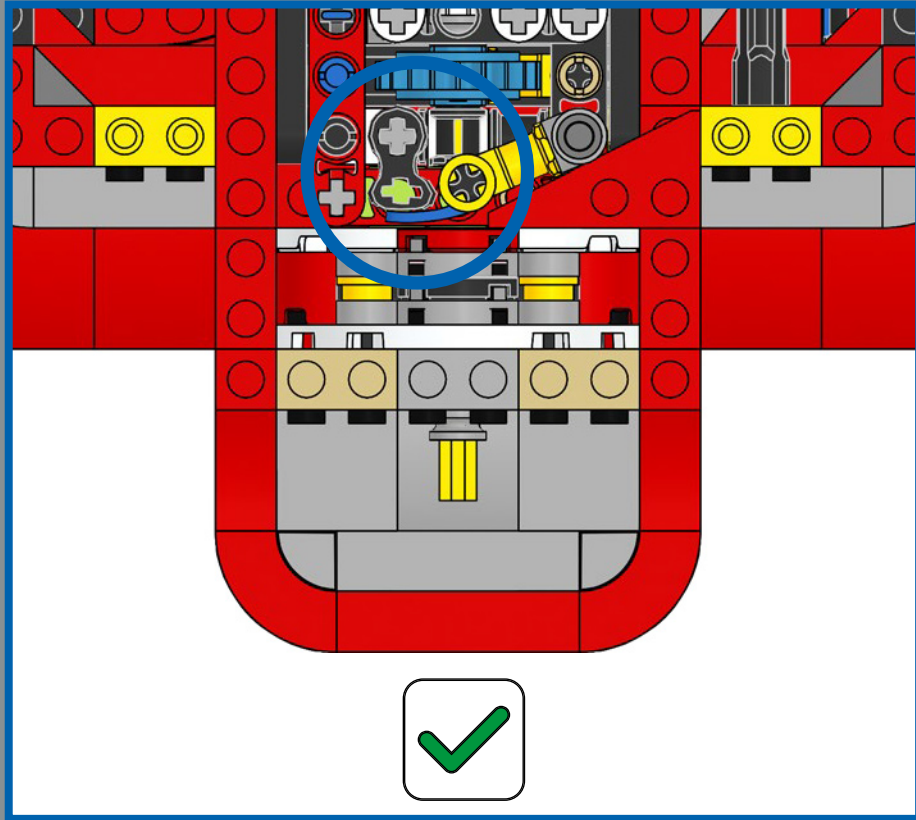

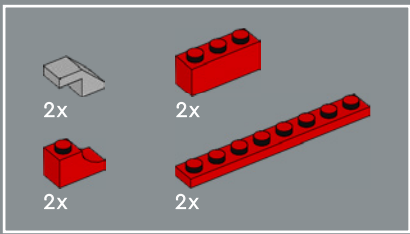

103

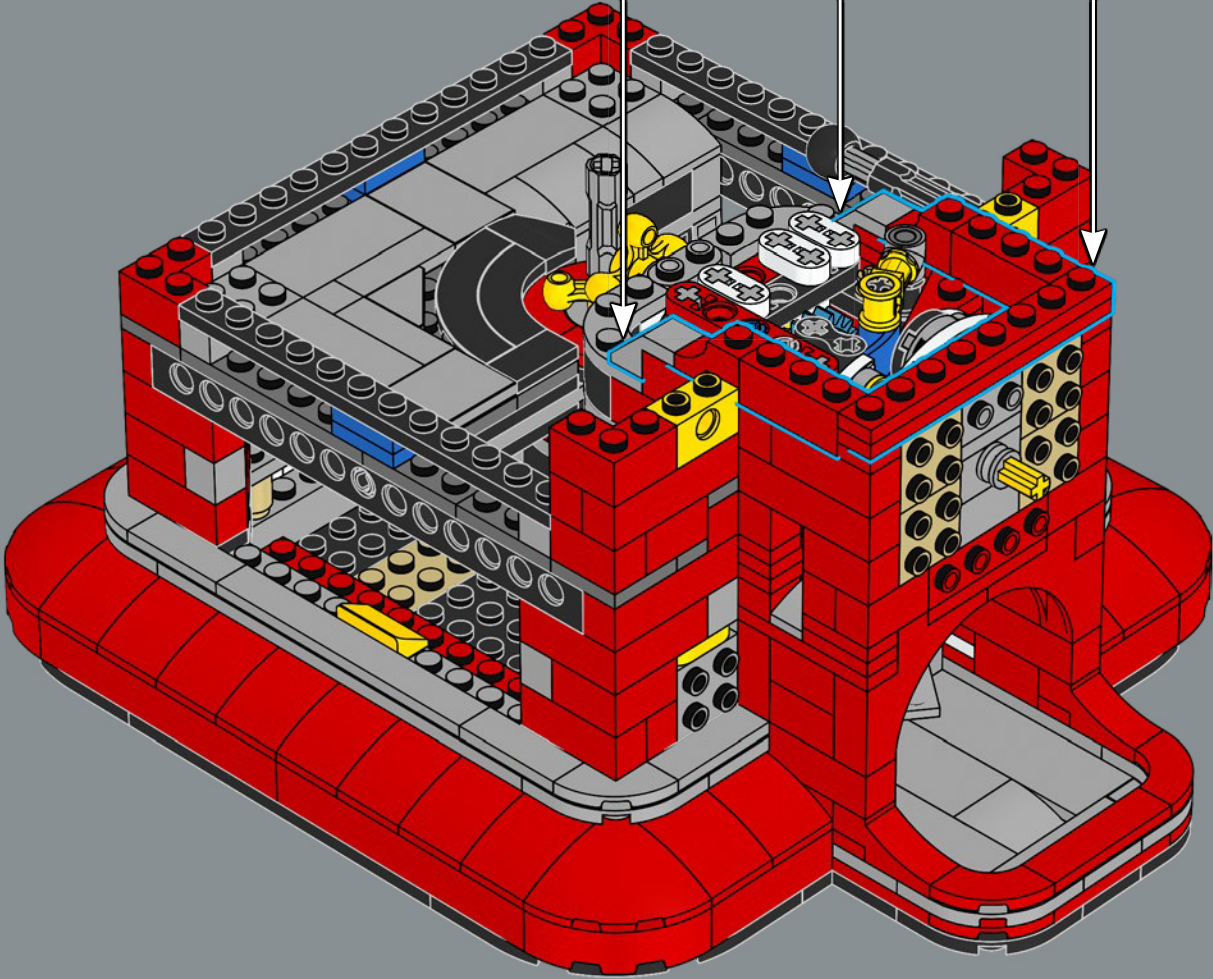
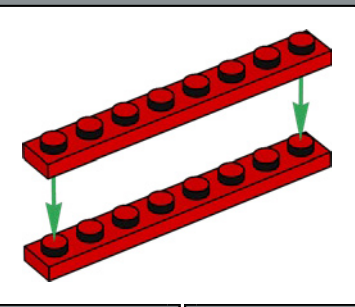
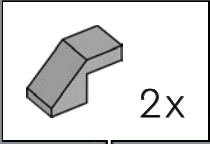

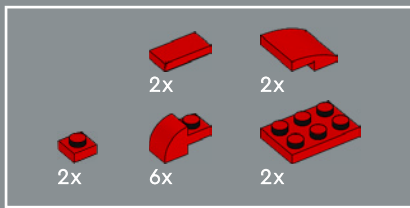

104

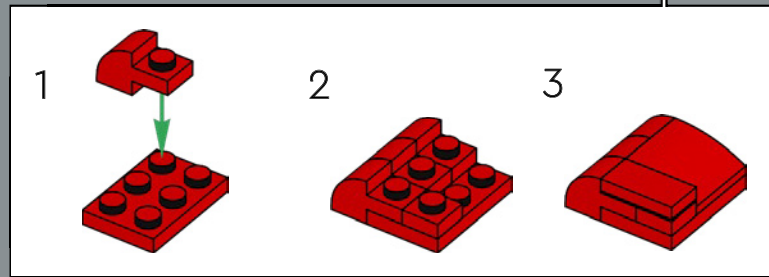
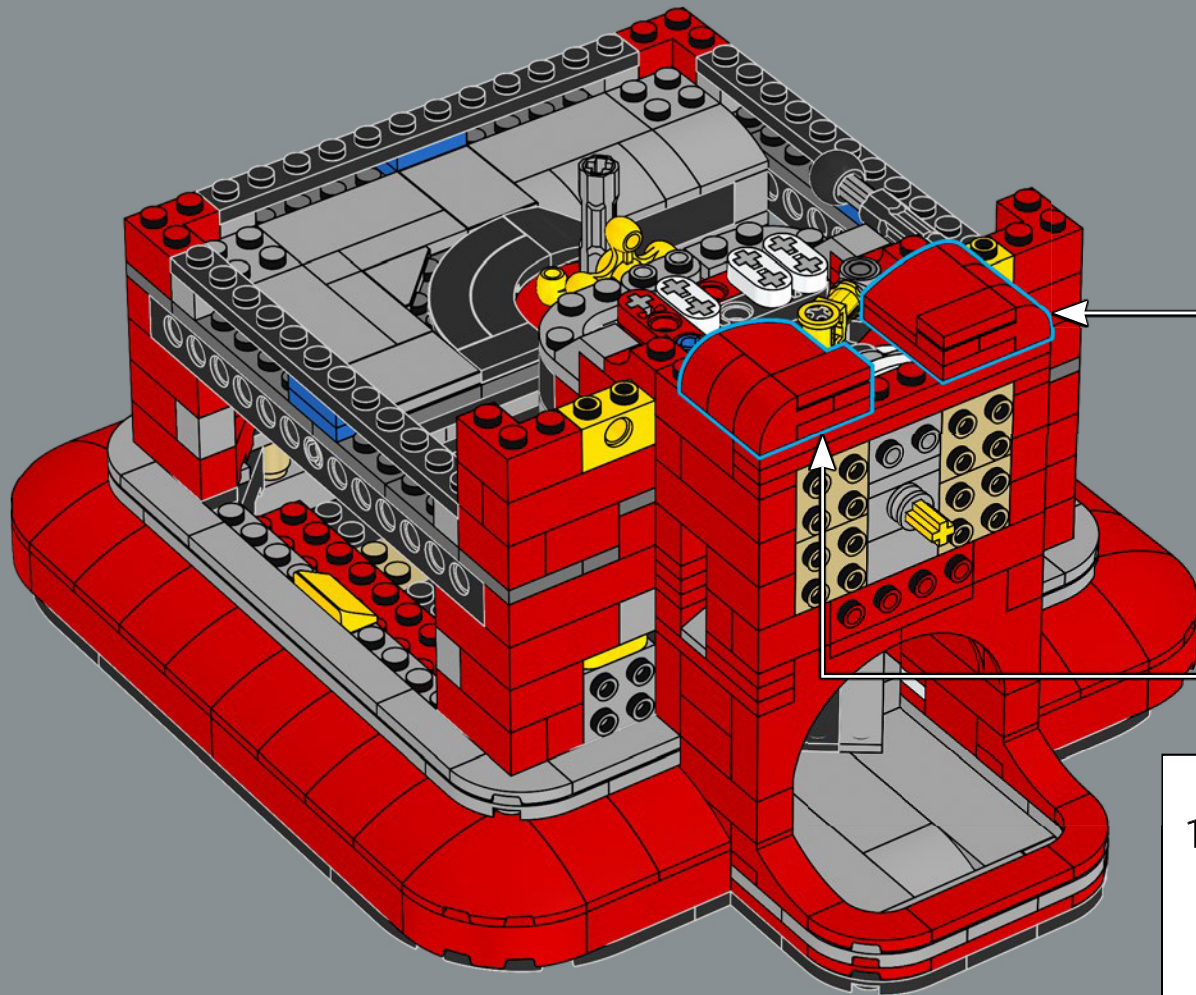
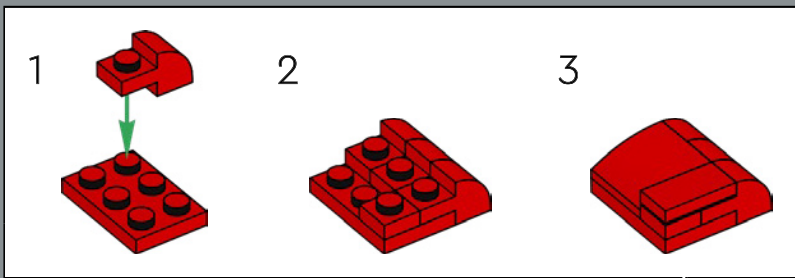

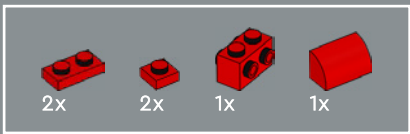

105

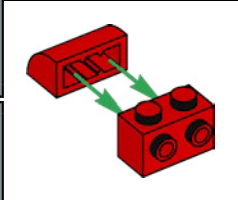
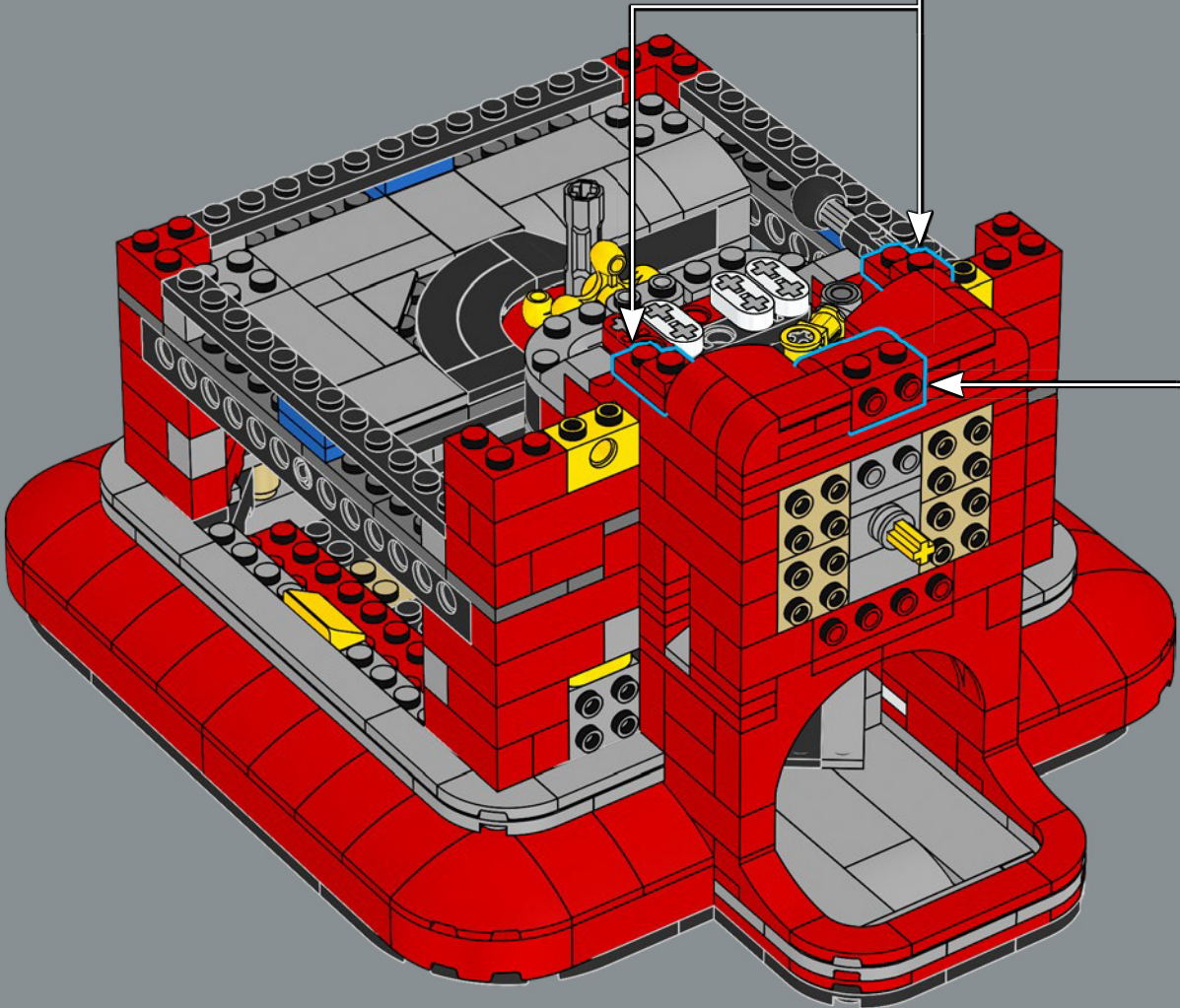
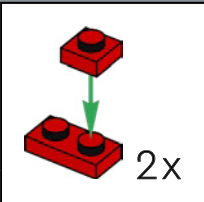

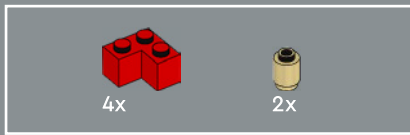

106

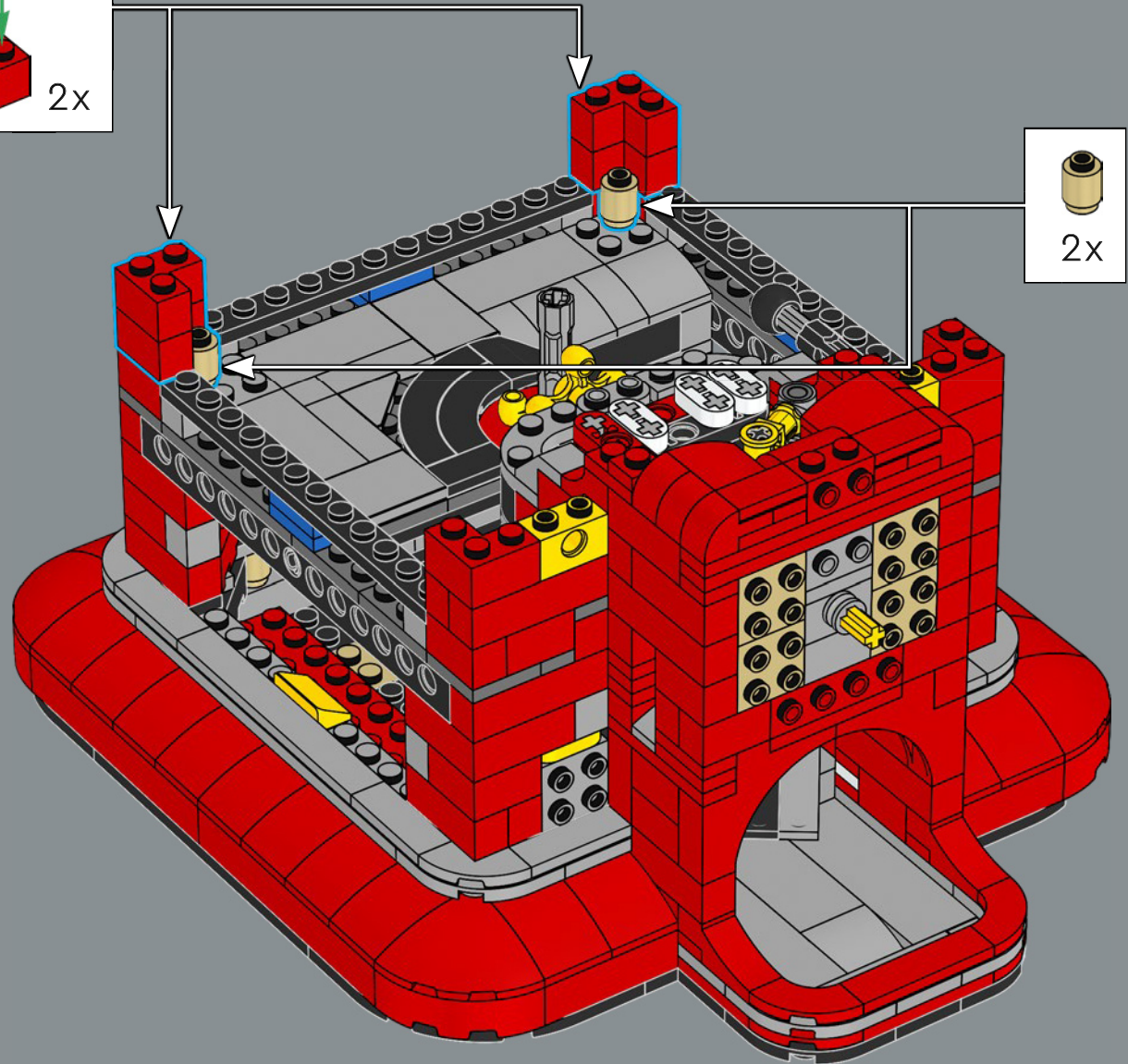
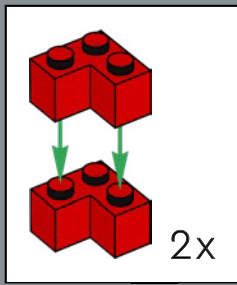

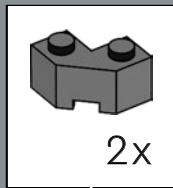
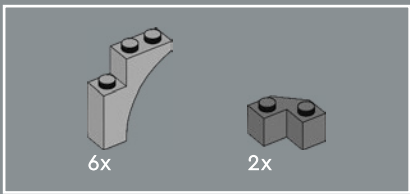

107

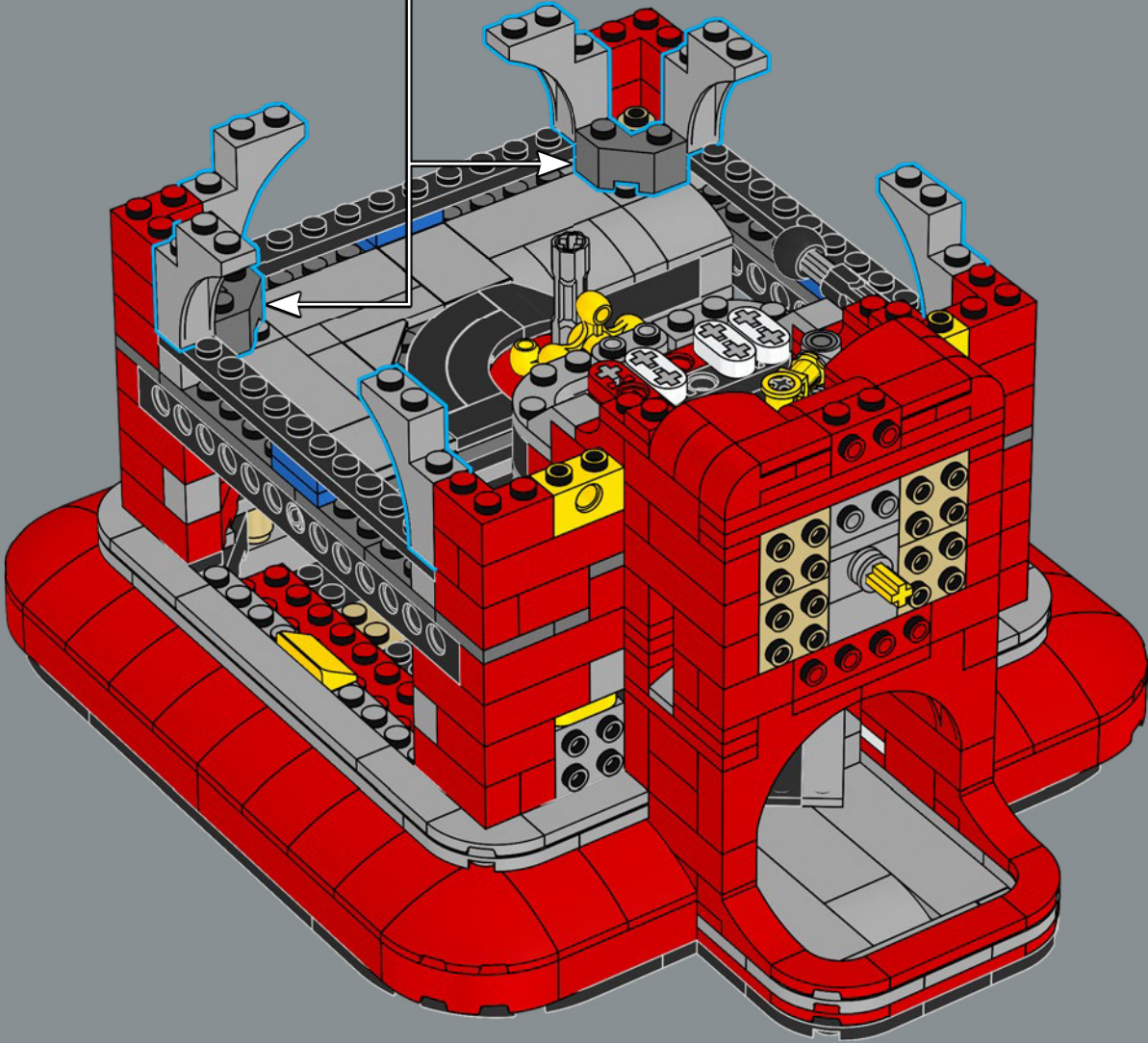

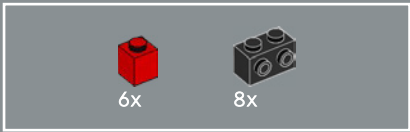

108

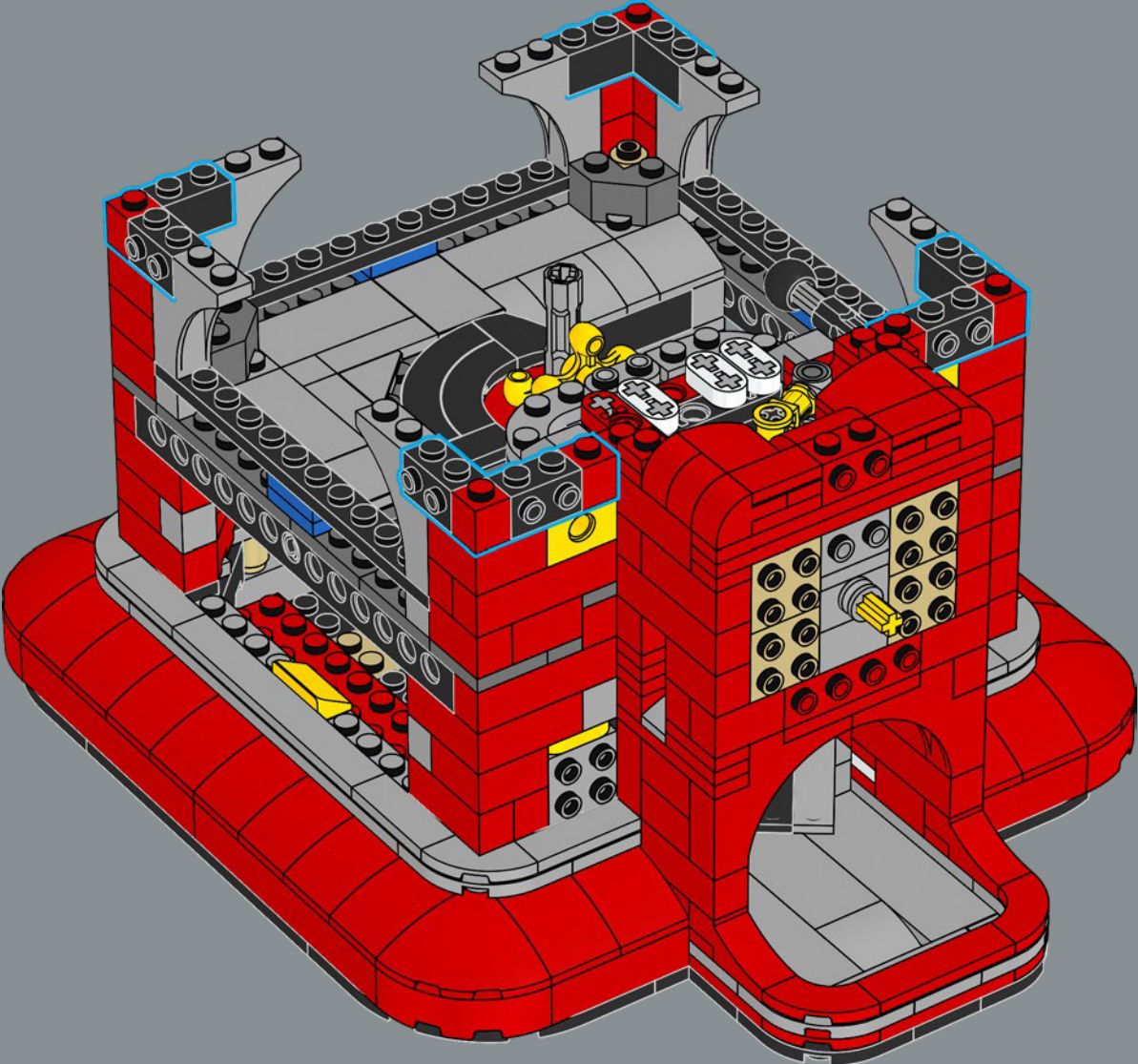

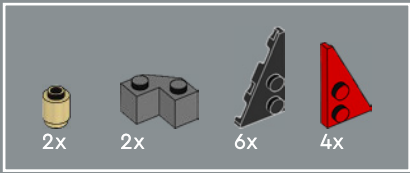

109

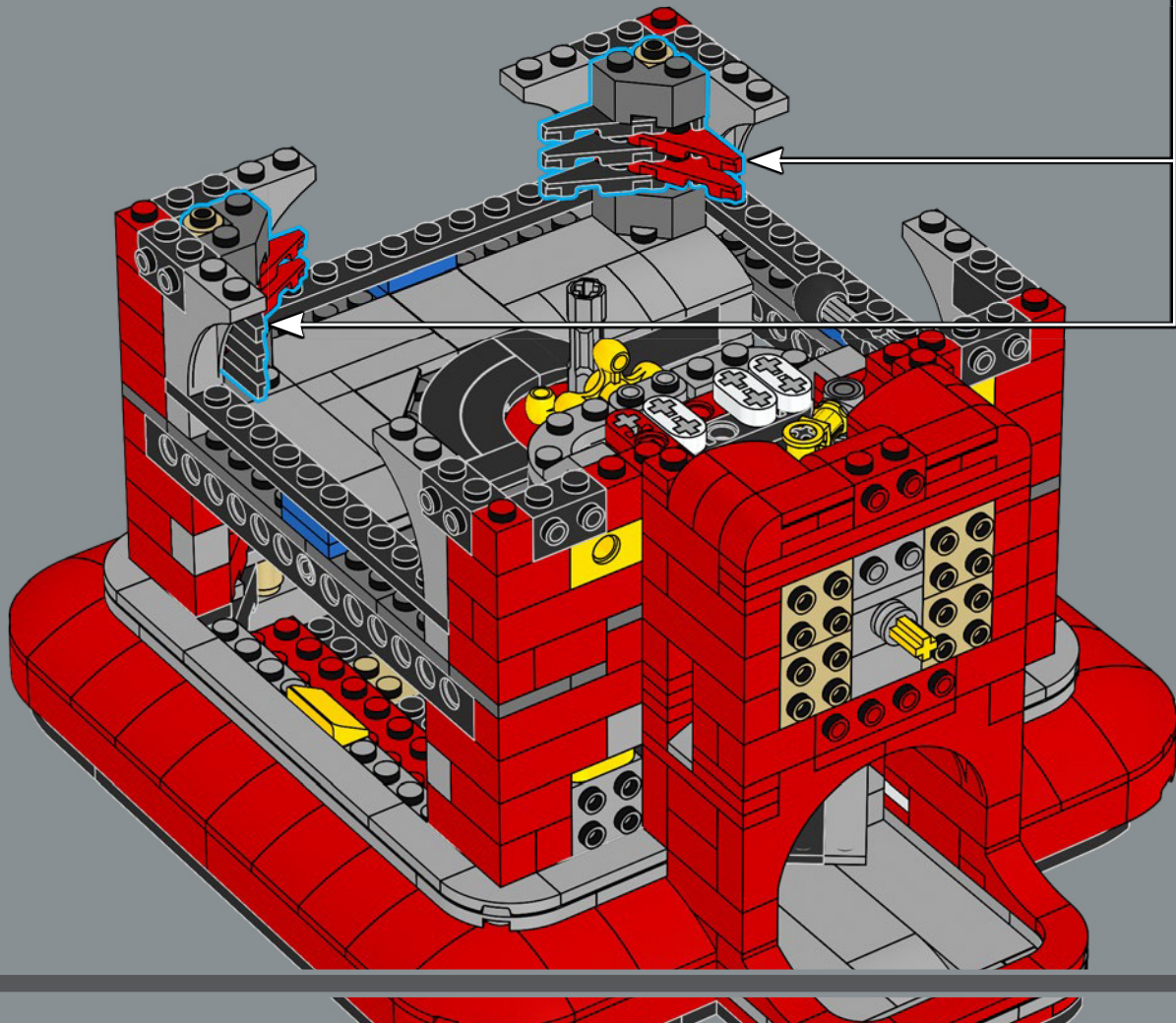
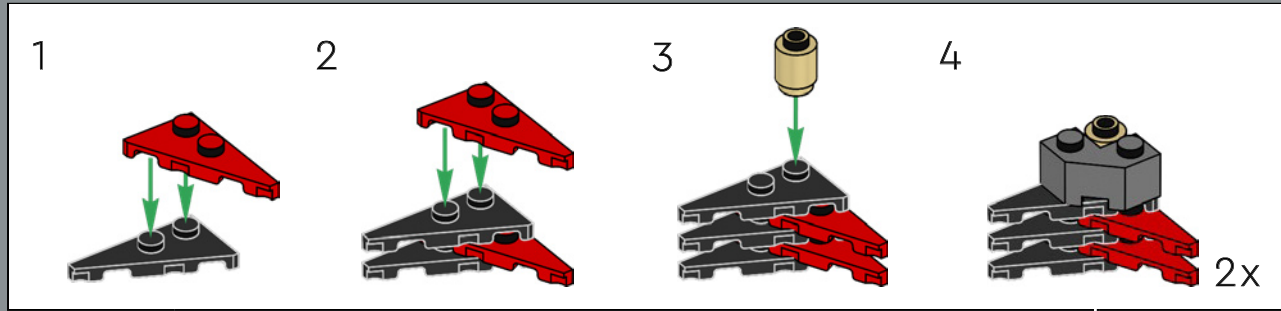



4x

110

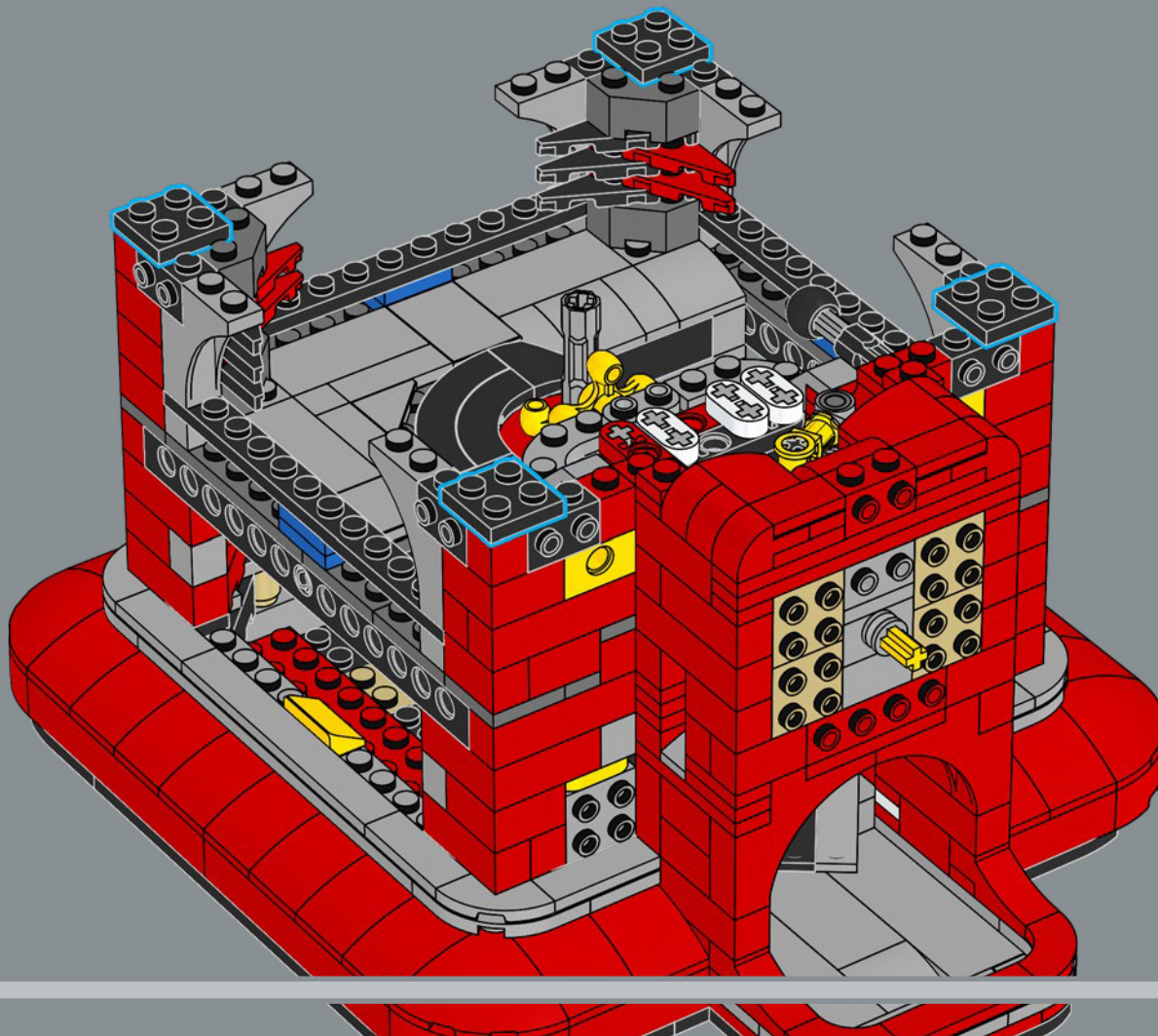

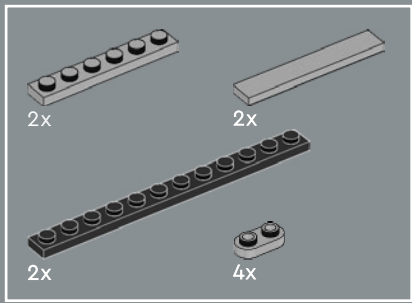

111

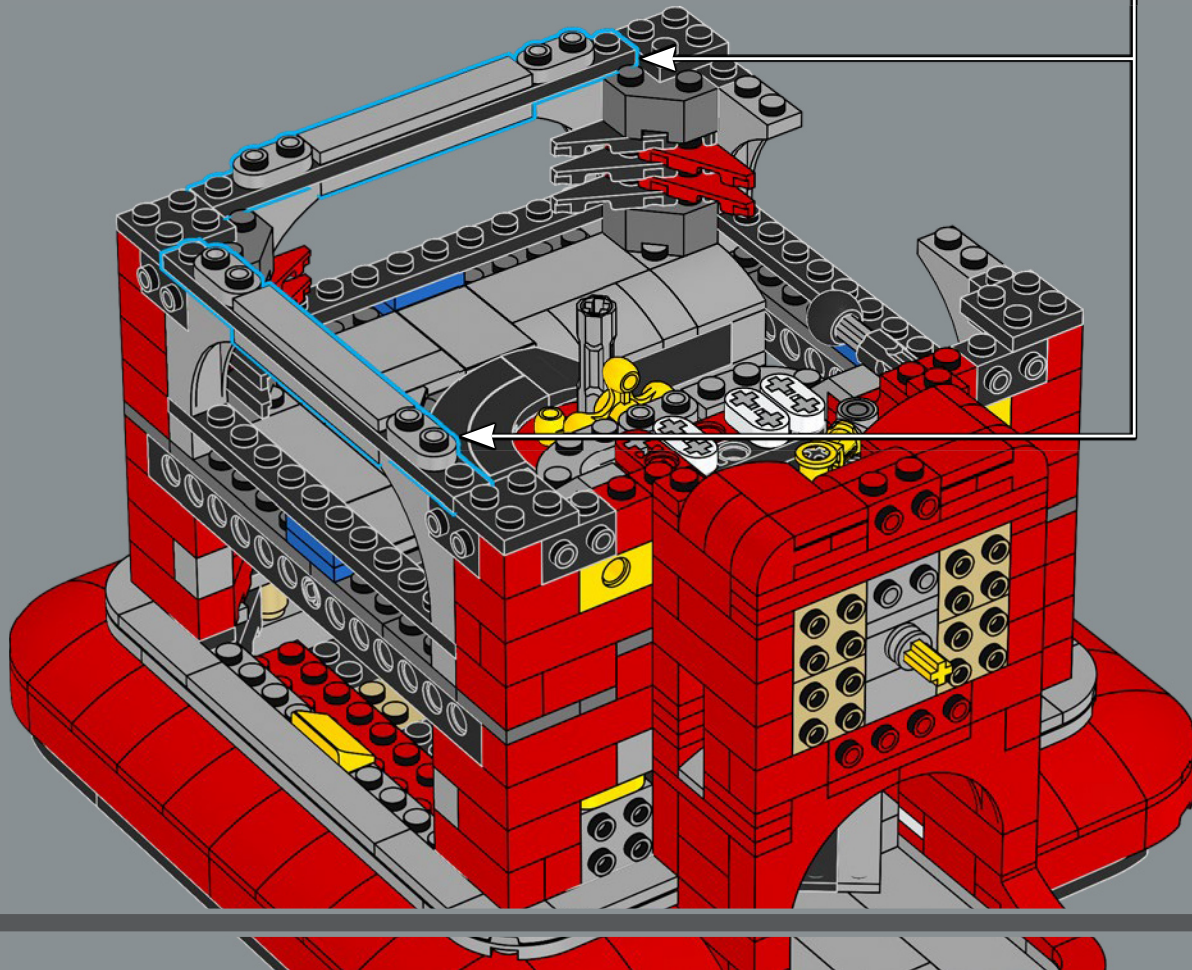
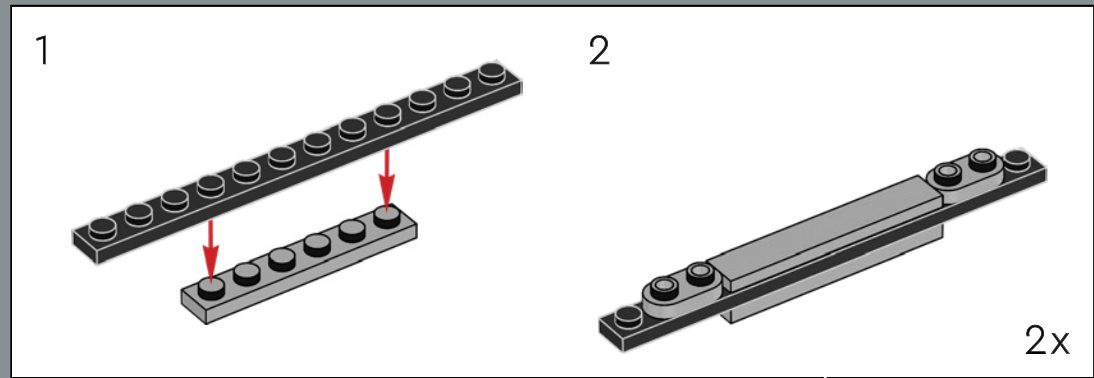

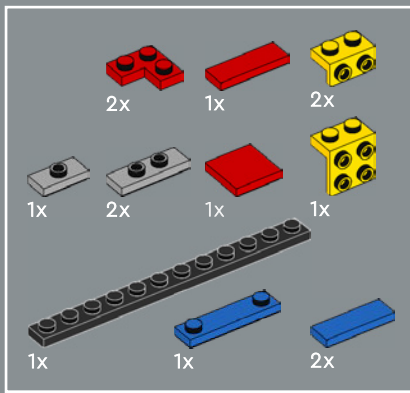

112

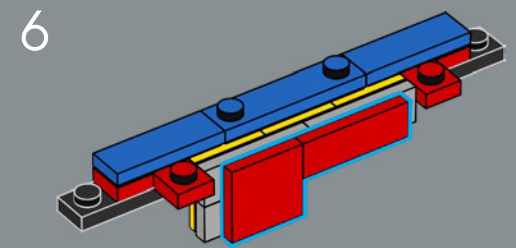
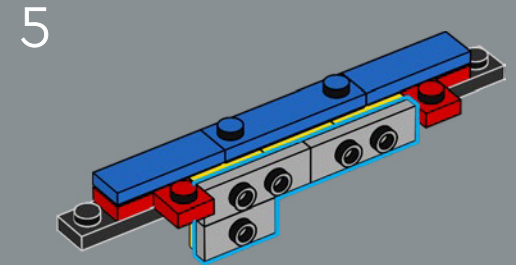
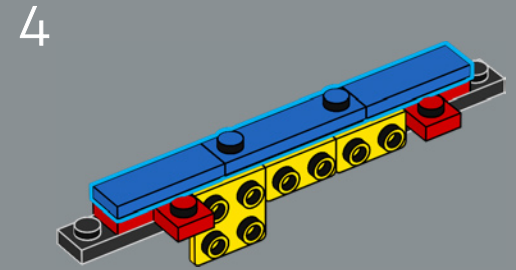
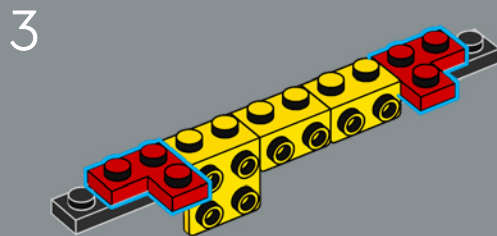
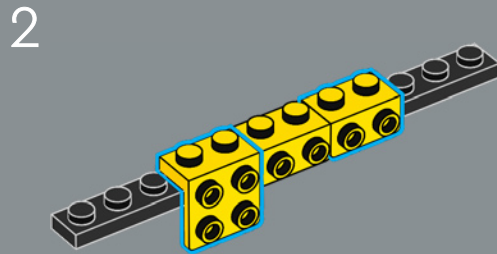
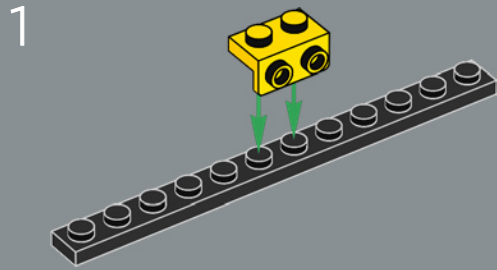

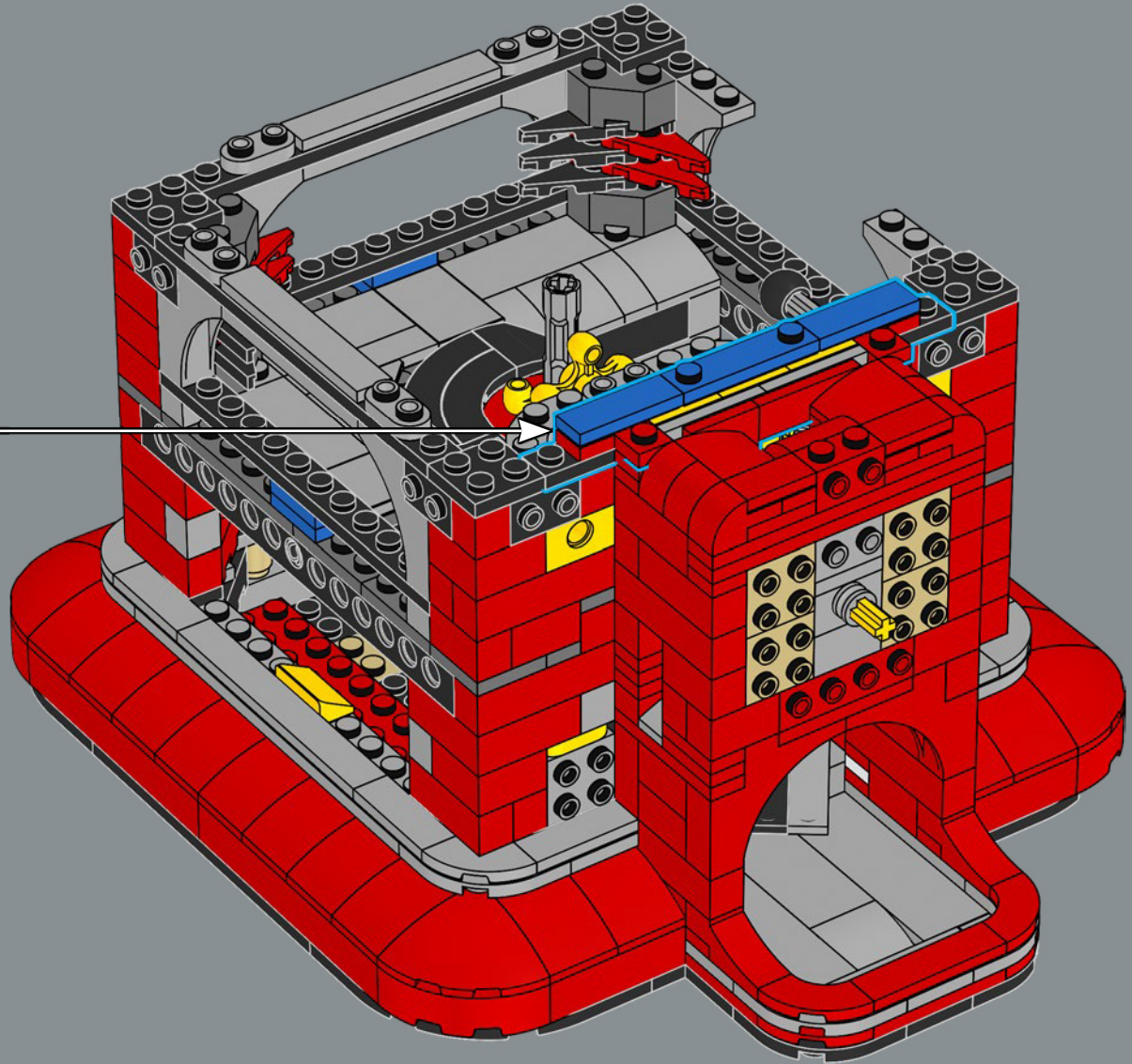

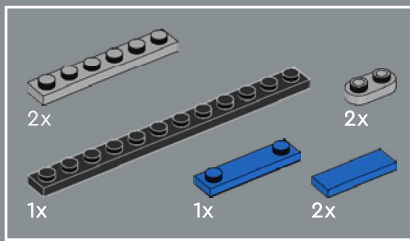

113

1

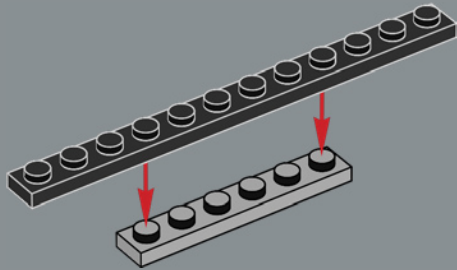

2

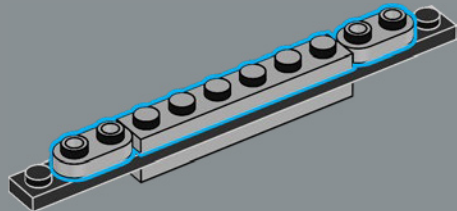

3

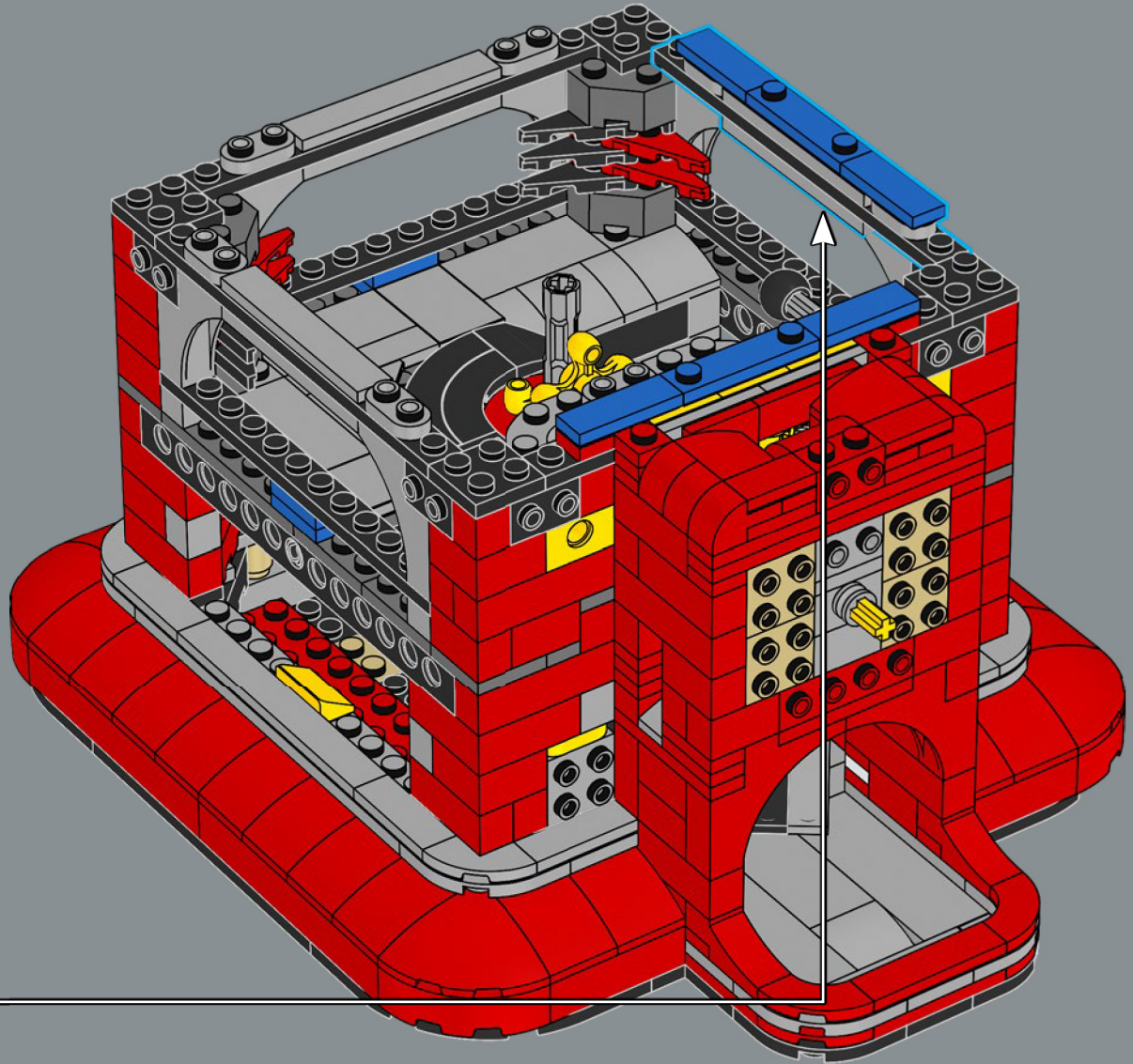
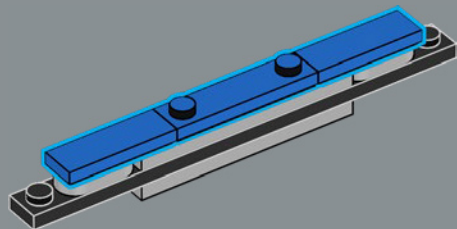

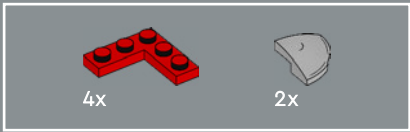

114

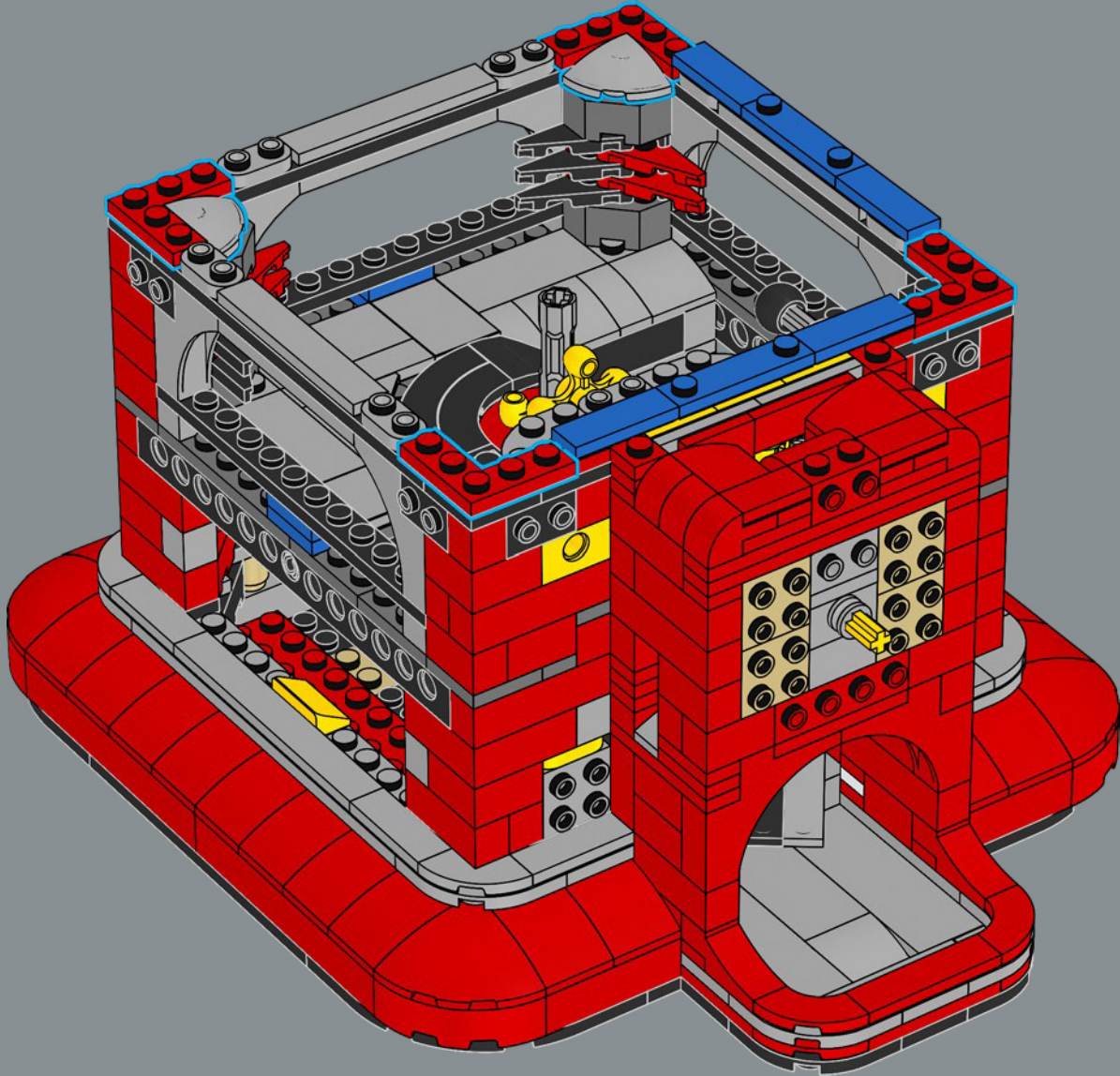

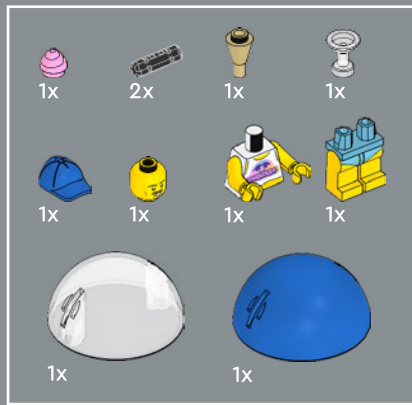
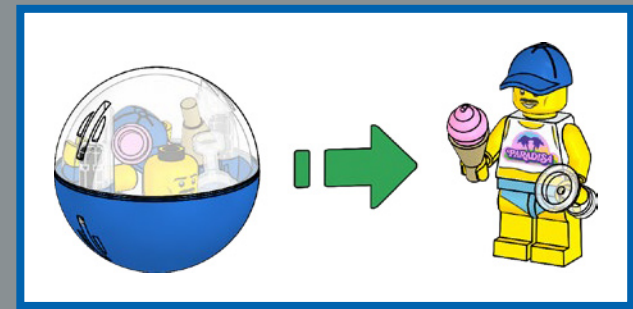

1

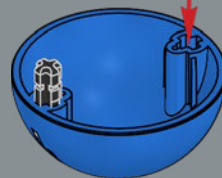

2

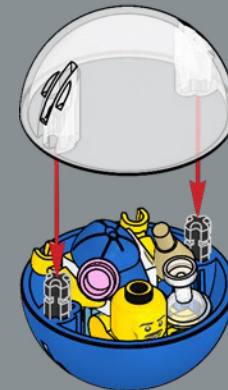

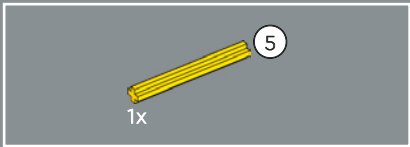

115

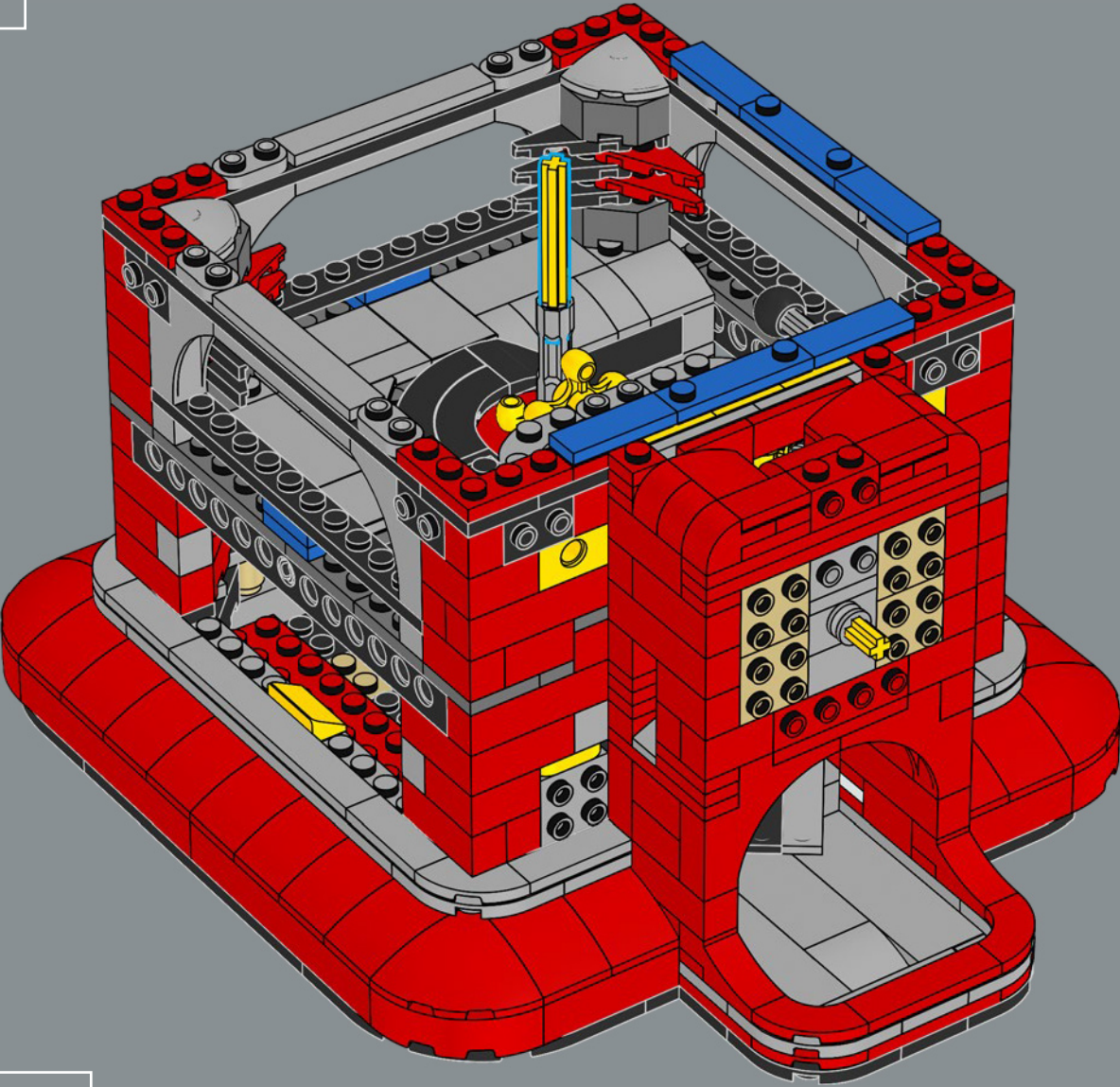

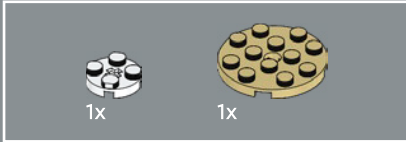
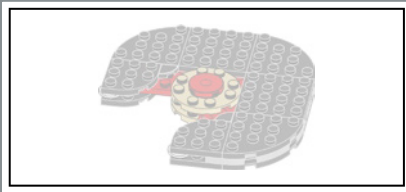

116

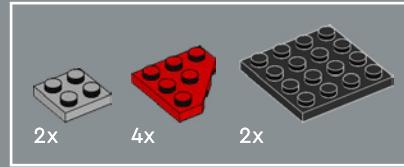

117

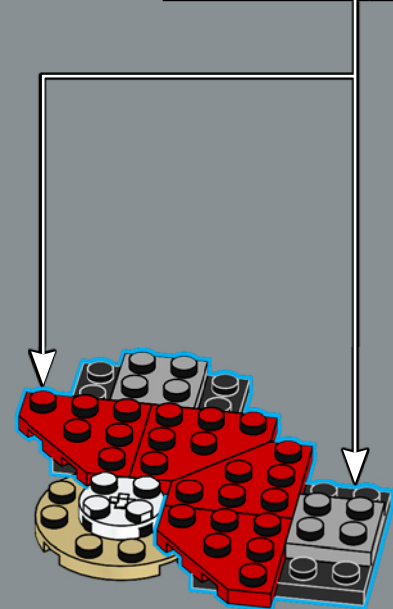
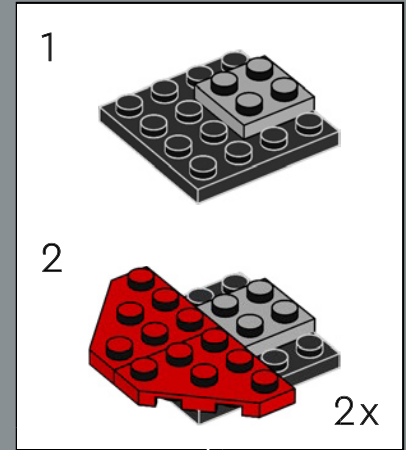

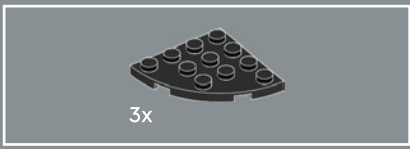

118

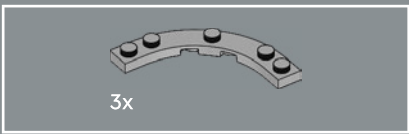
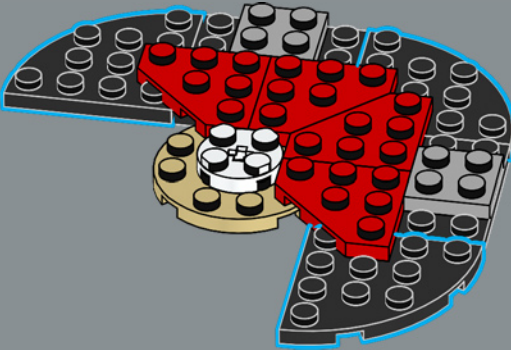

119

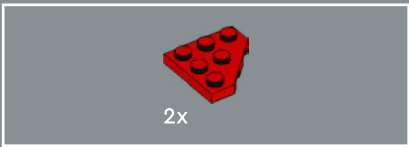
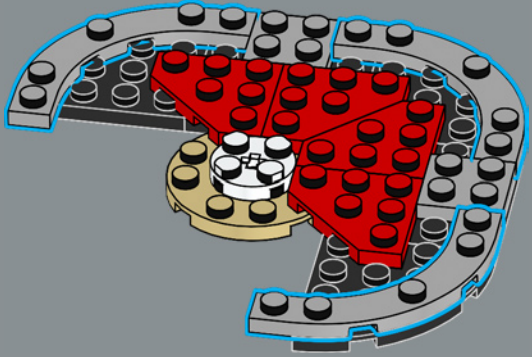

120

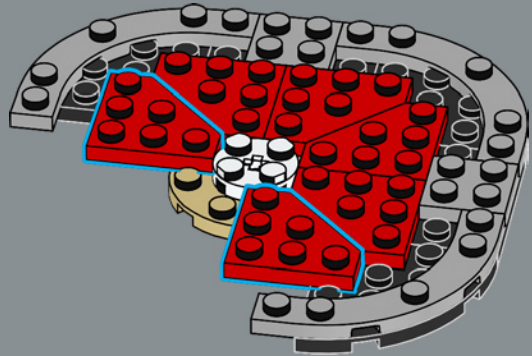

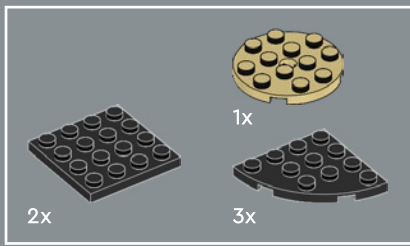

121

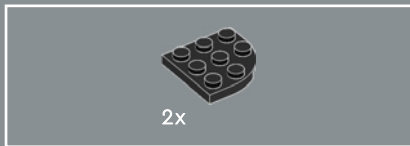
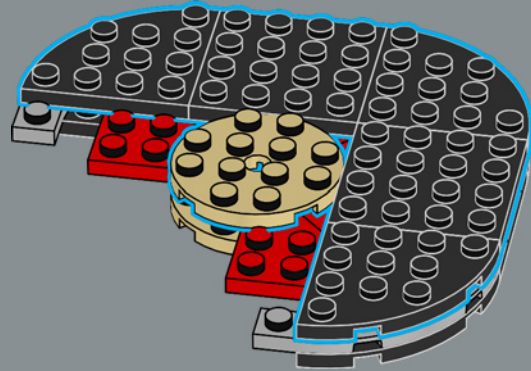

122

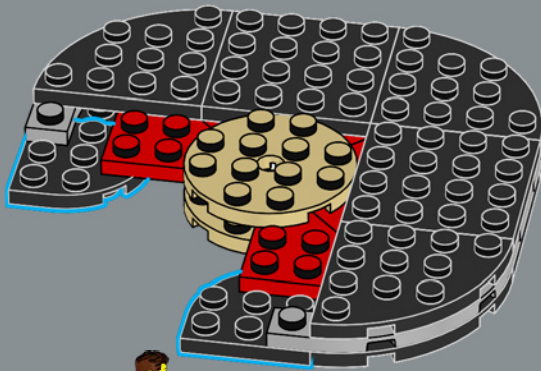

123

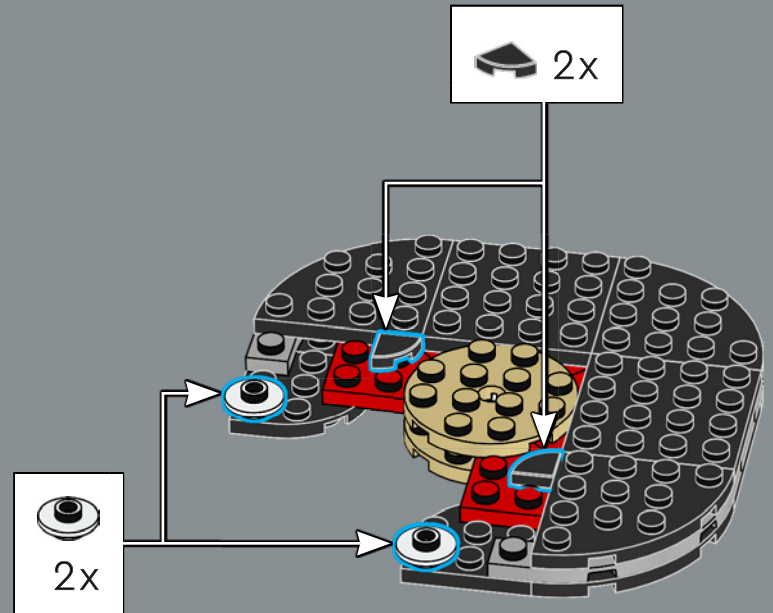

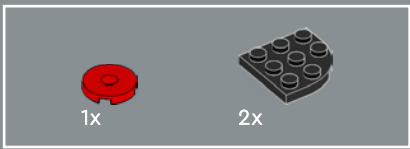

124

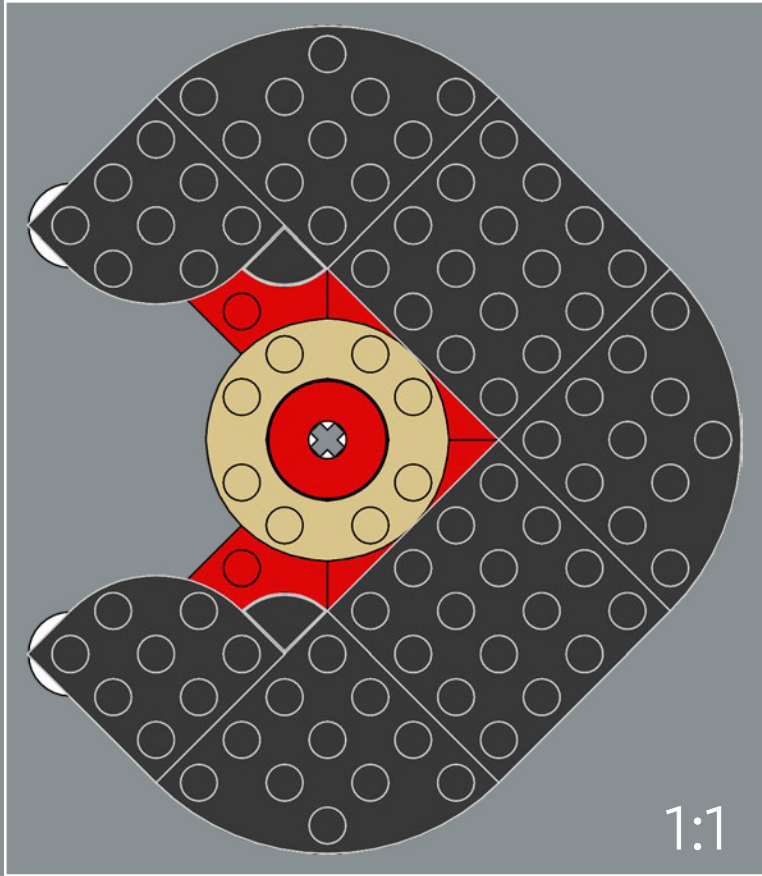
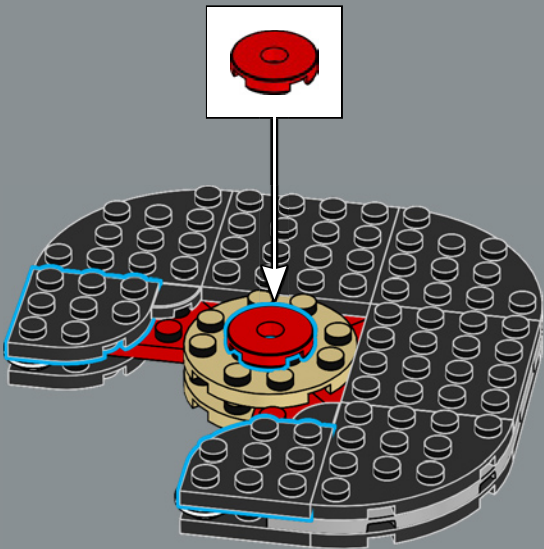

125

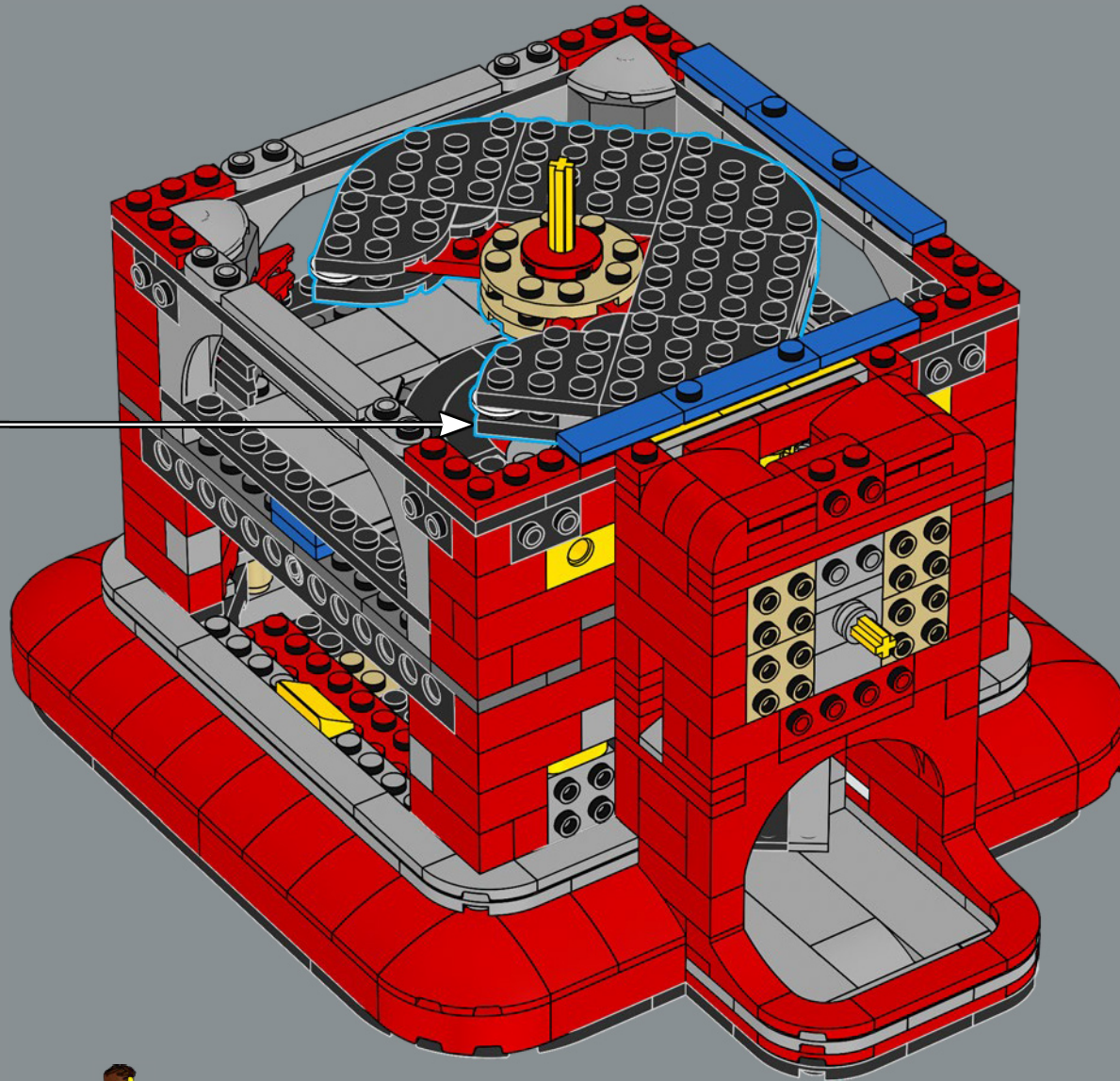

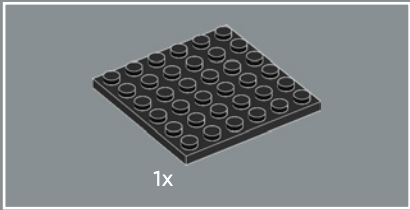
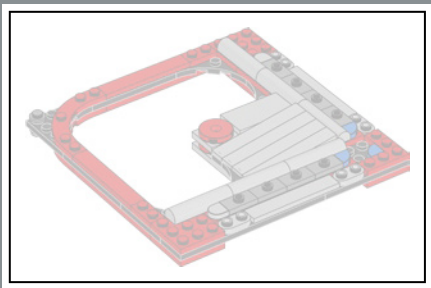

1x

126

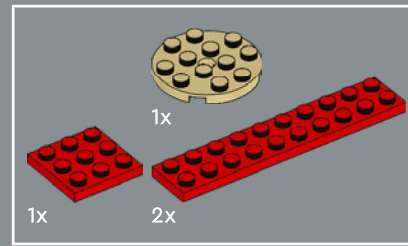
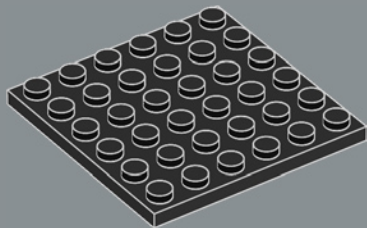

1x

1x

2x

127

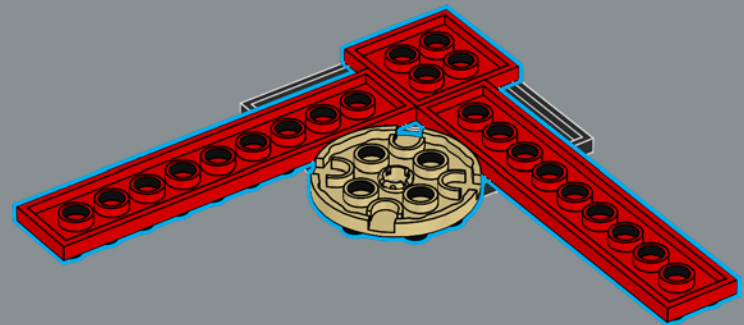

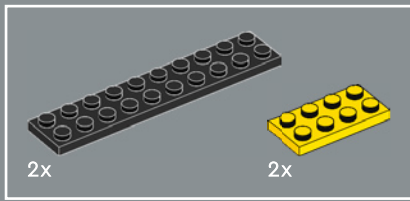

128

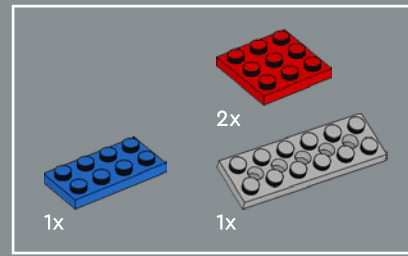
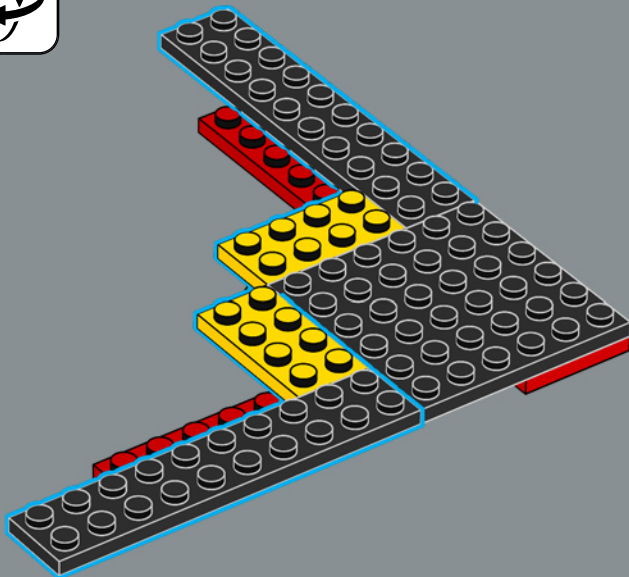

129

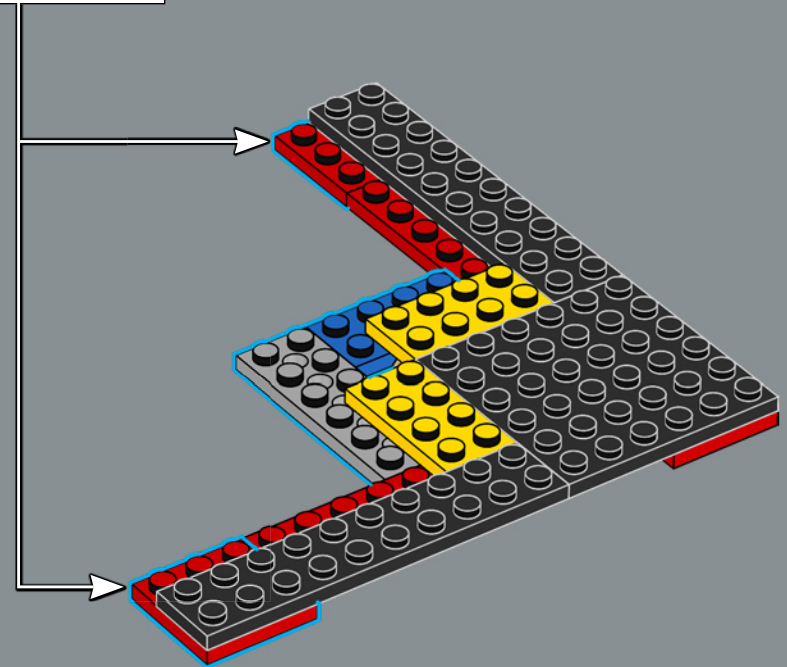
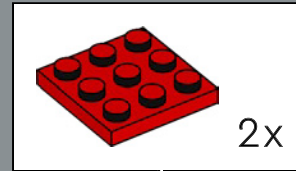

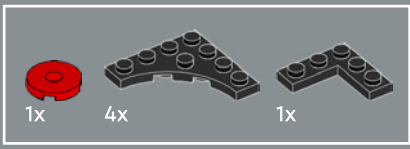

130

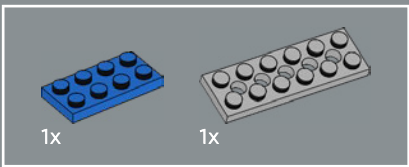
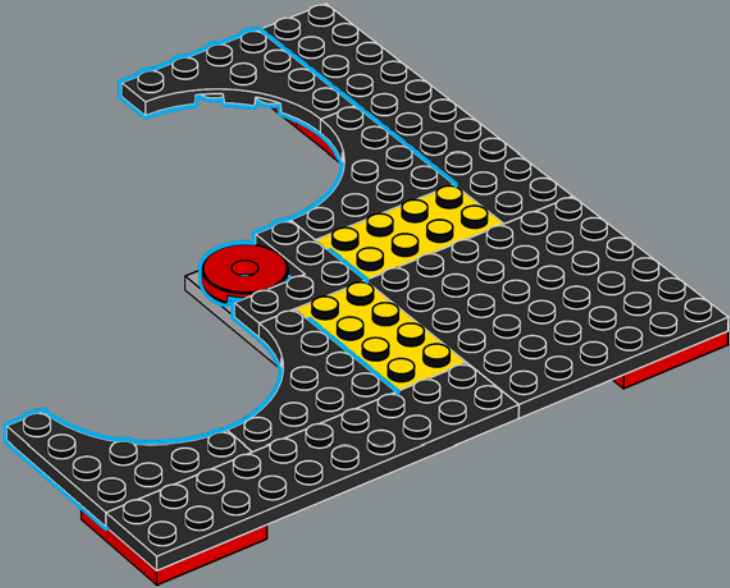

131

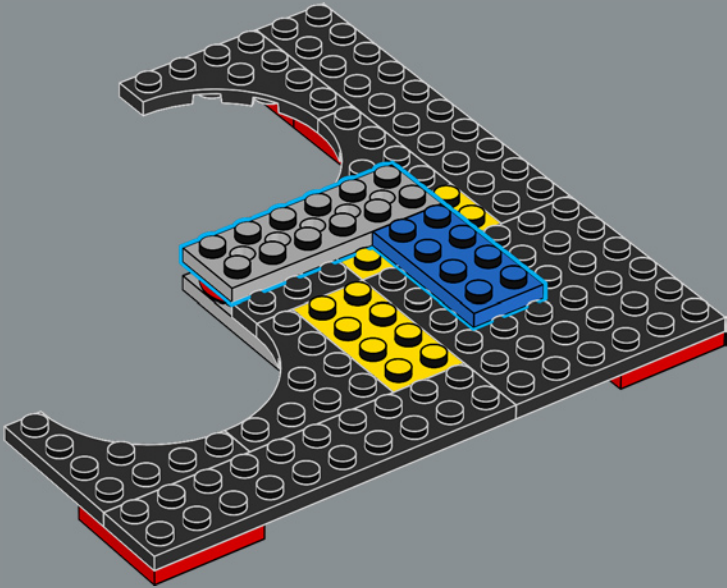

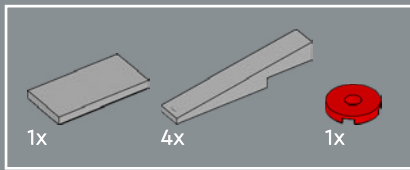

132

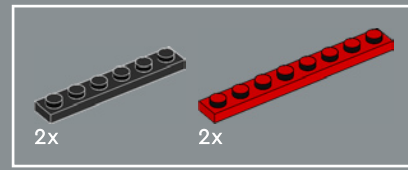
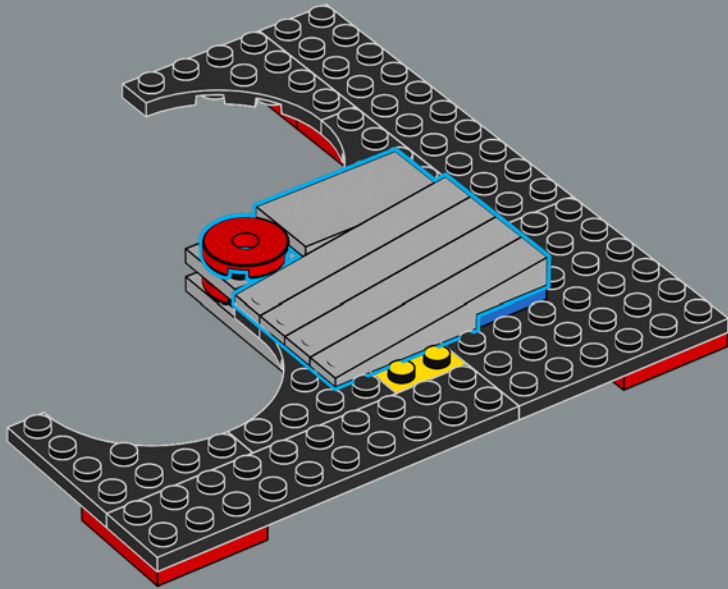

133

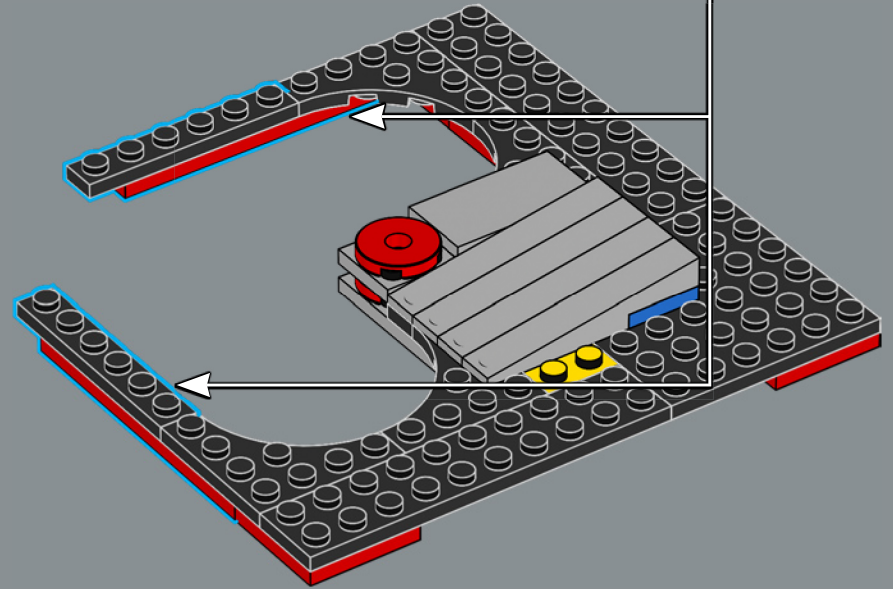
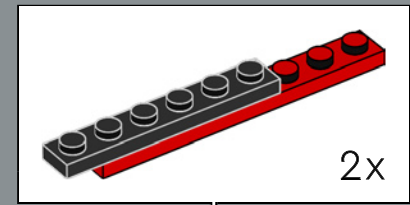

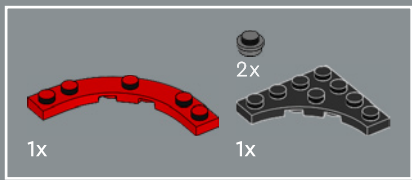

134

1

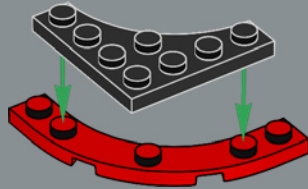

2

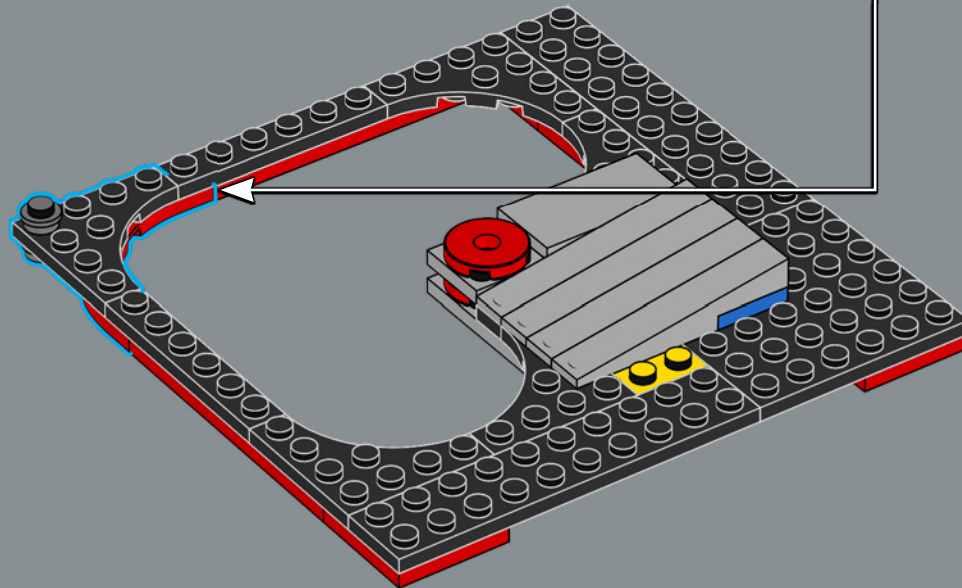
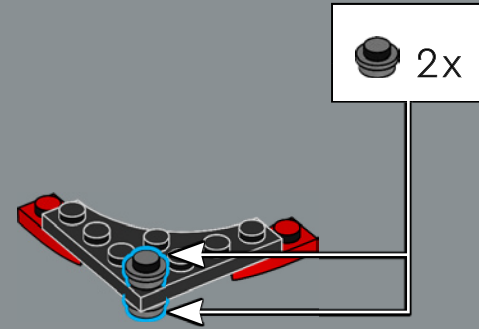

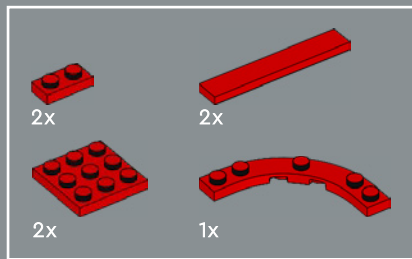

135

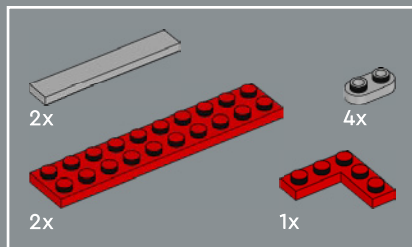
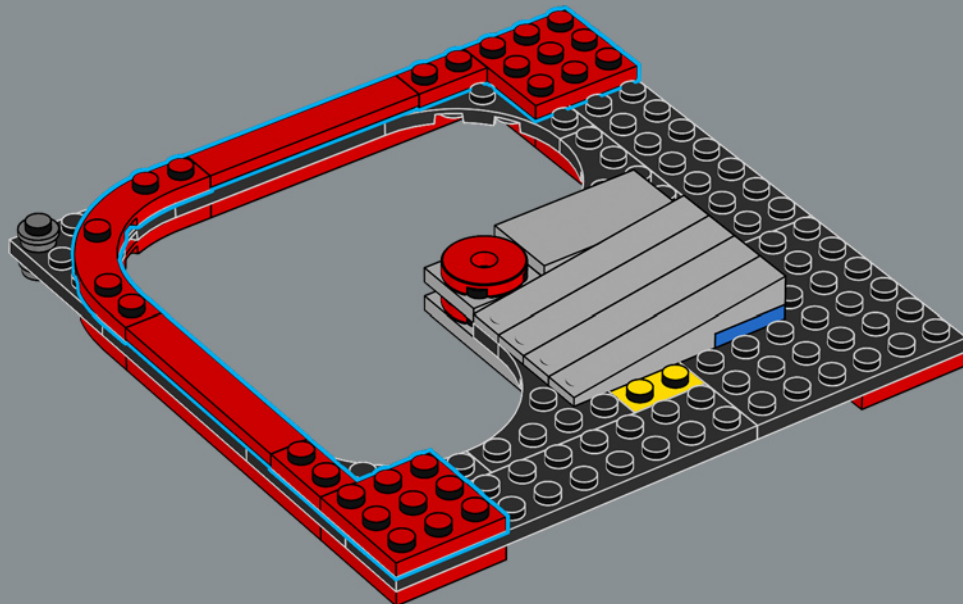

136

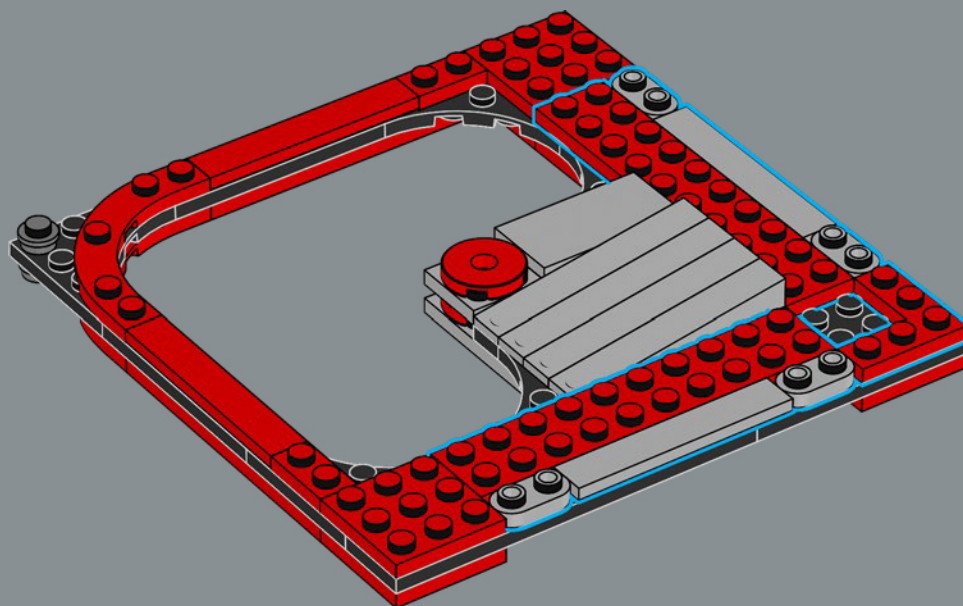

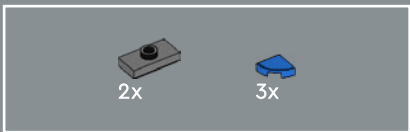

137

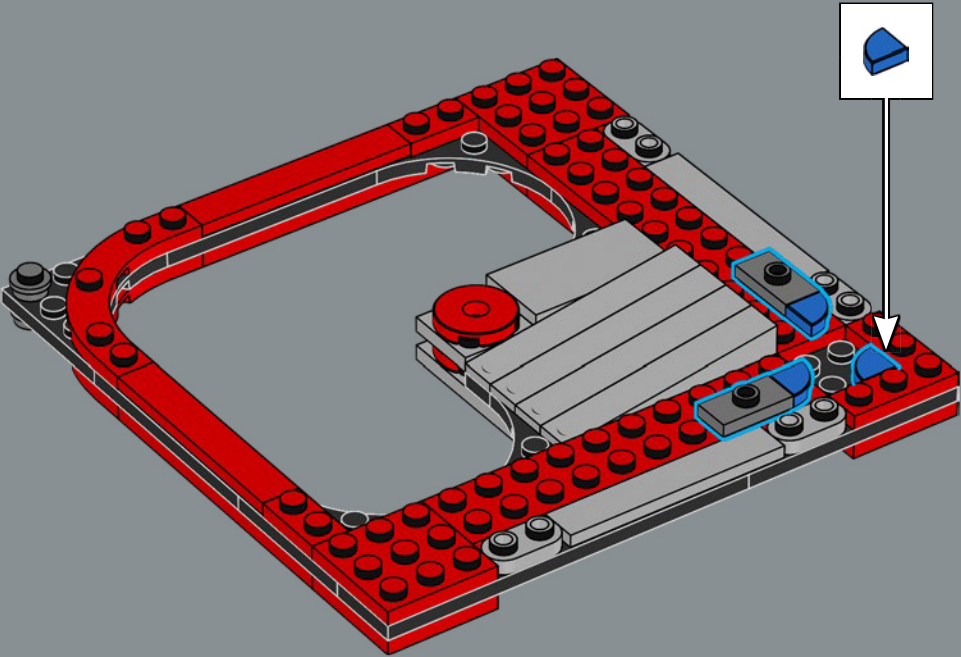

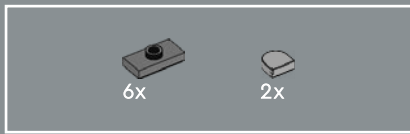

138

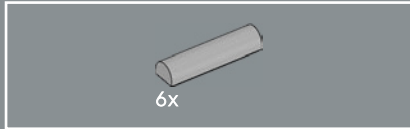
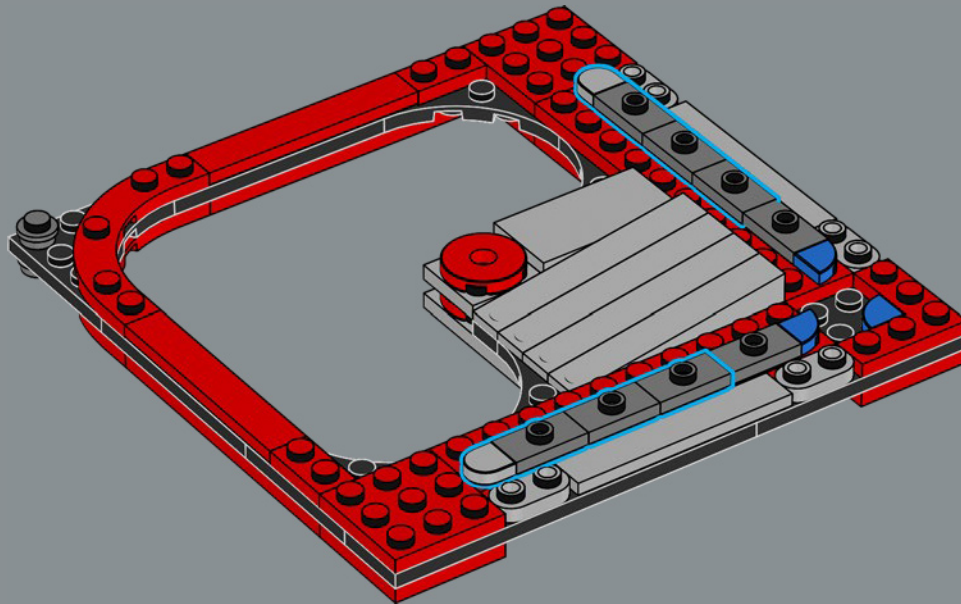

139

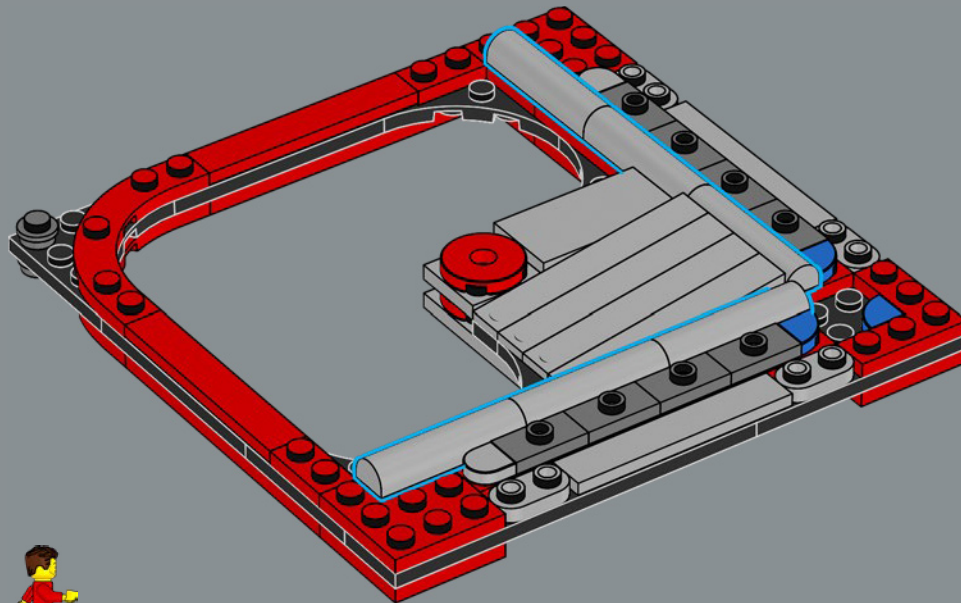

140

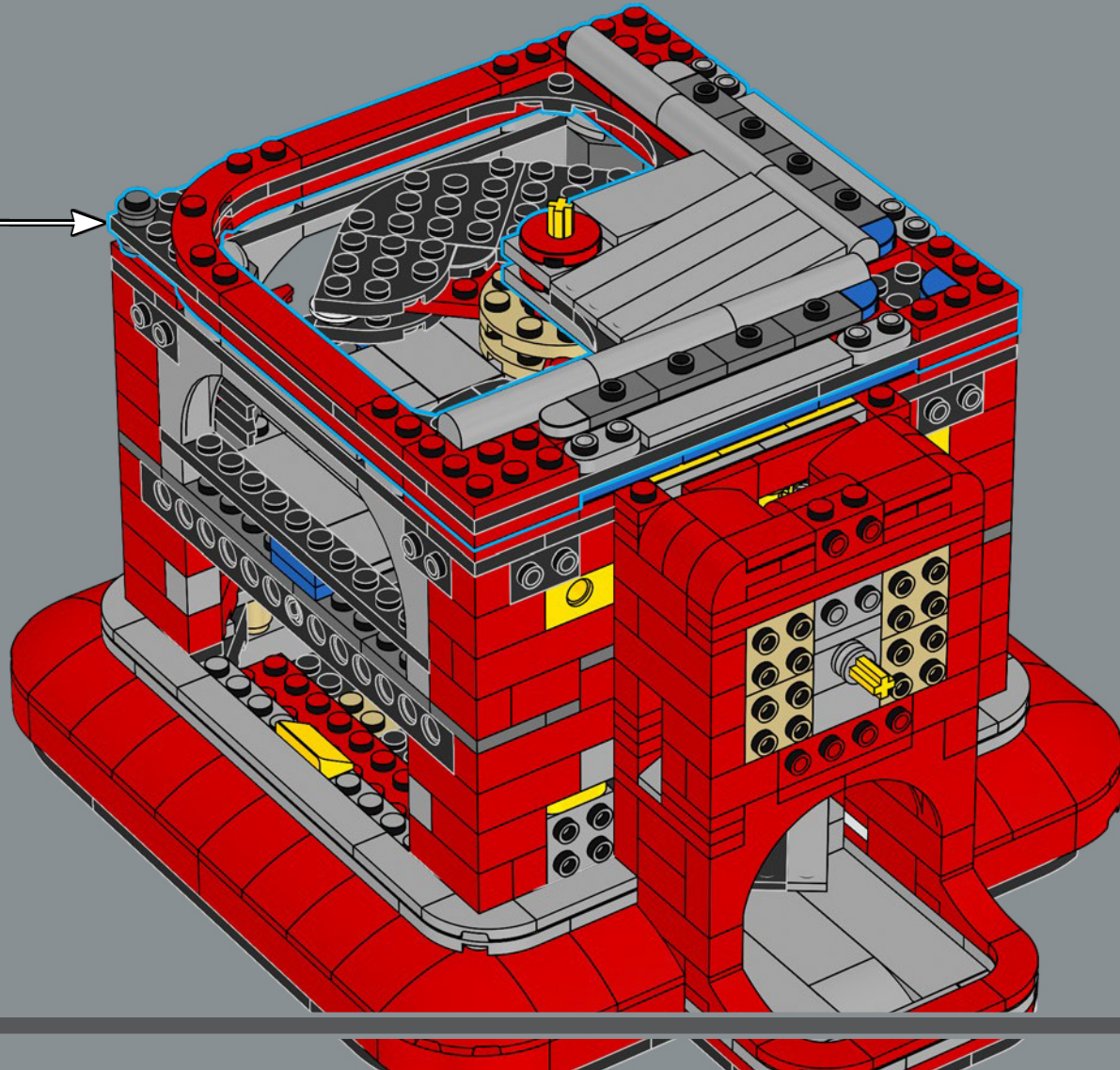

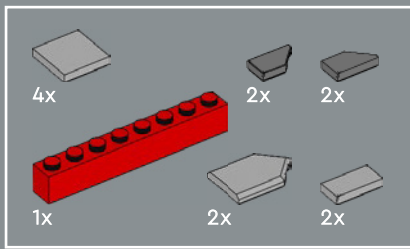

141

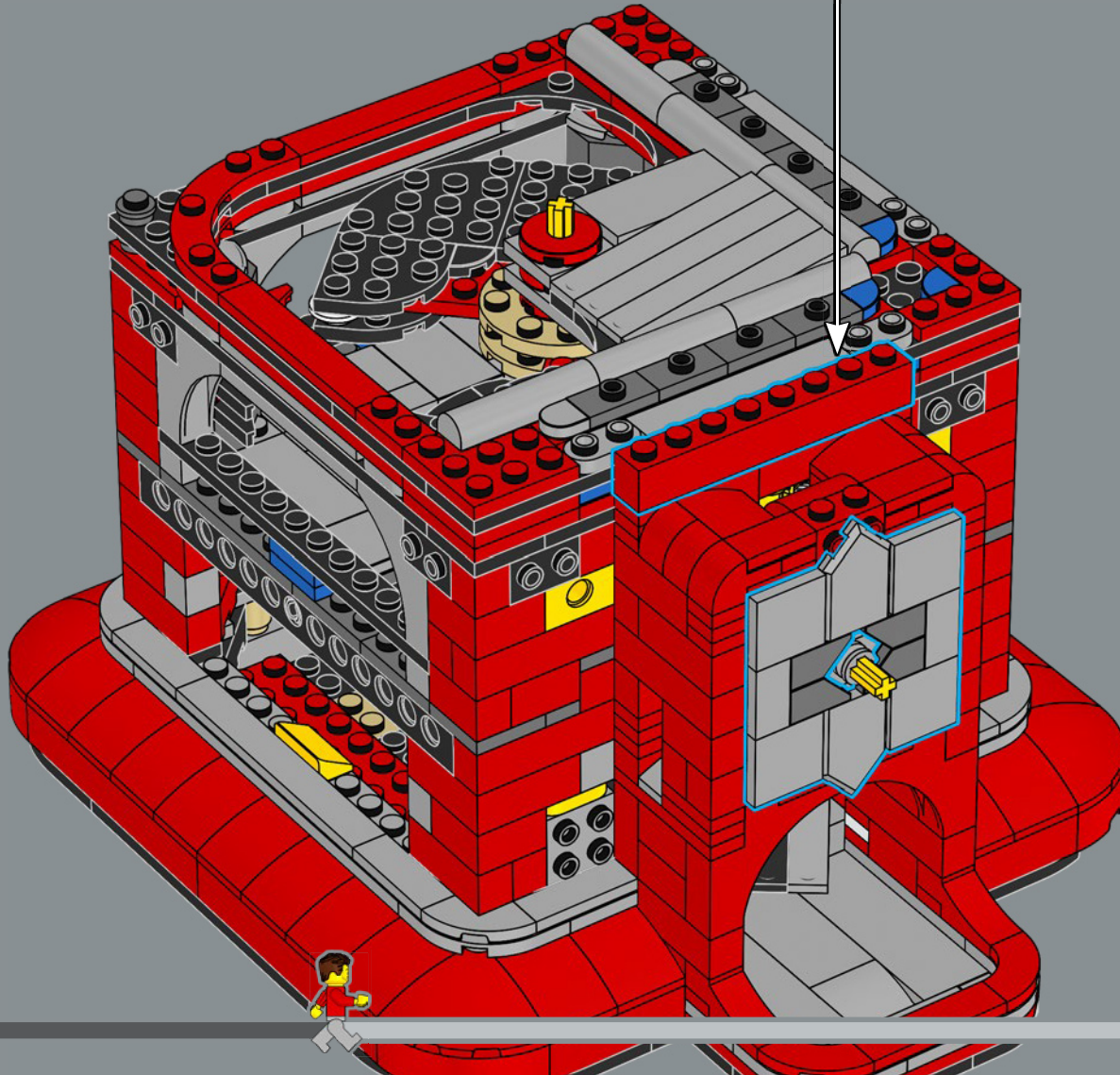
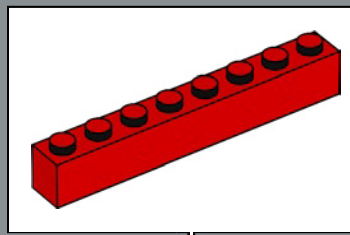

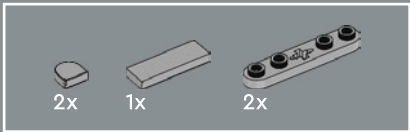

142

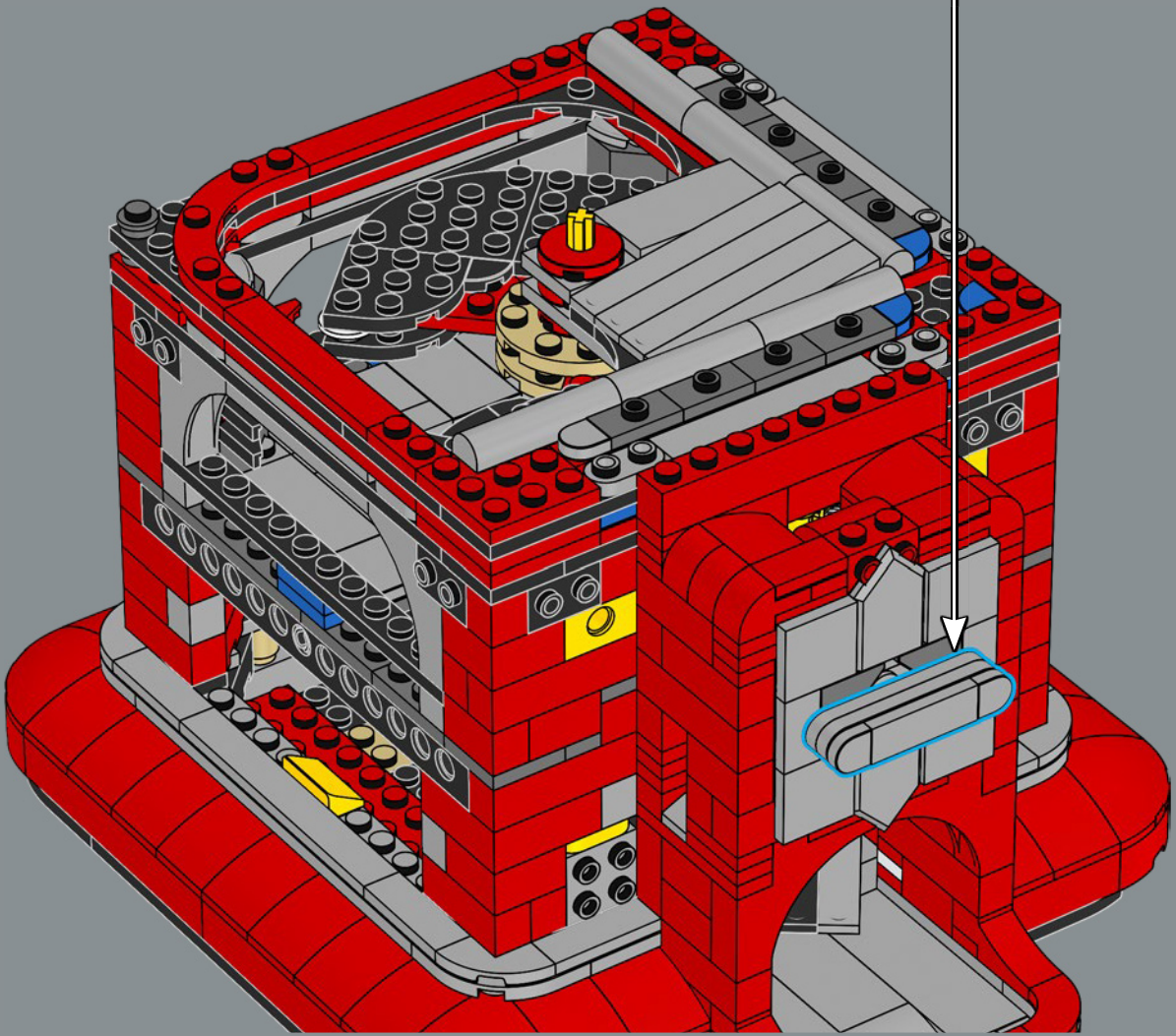
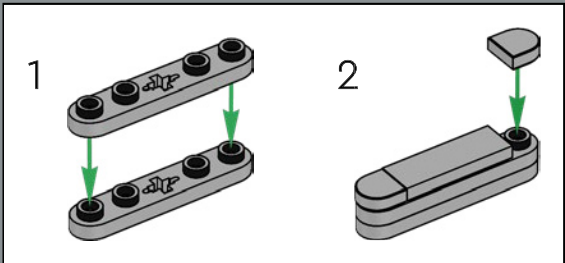



143

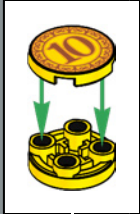
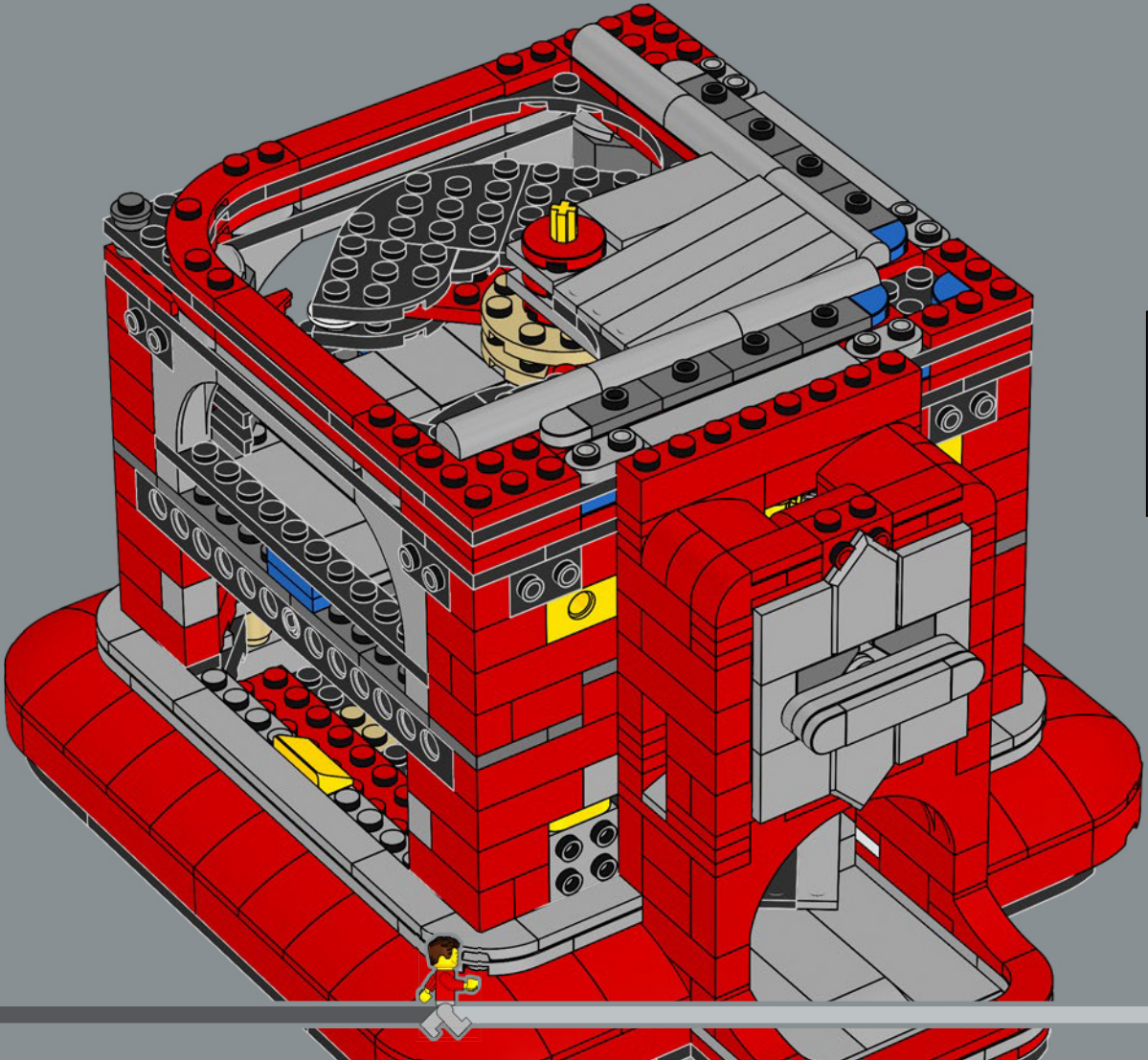

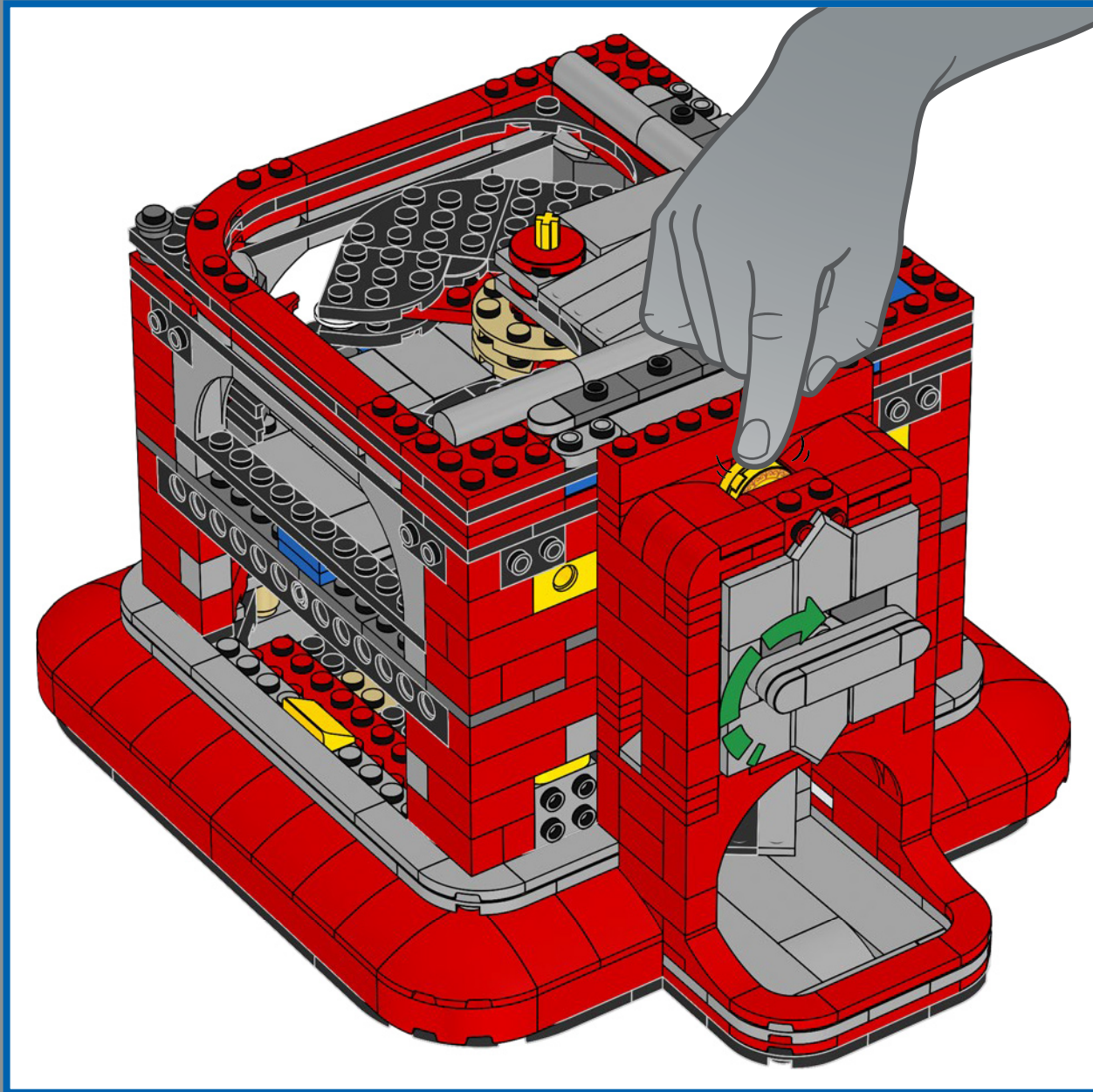

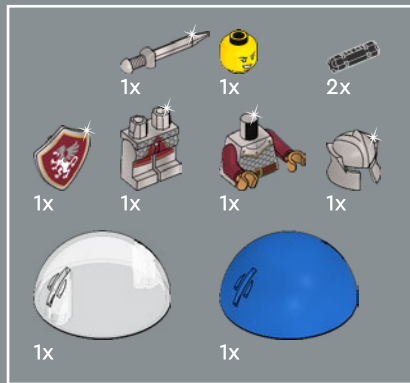
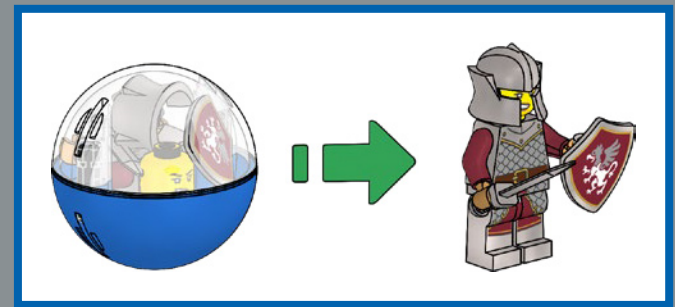

1

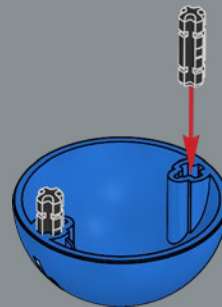

2

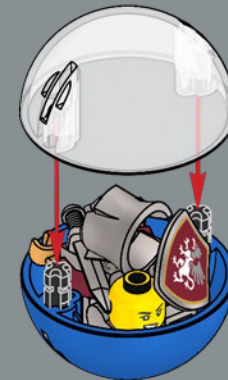

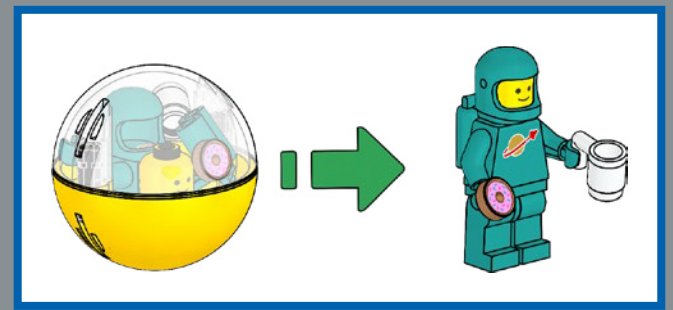
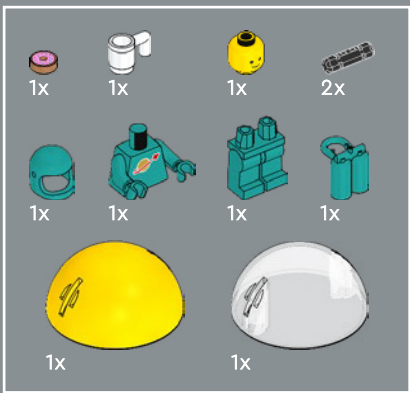

1

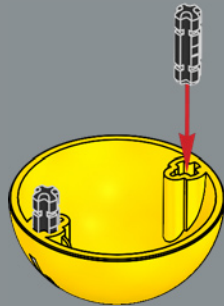

2

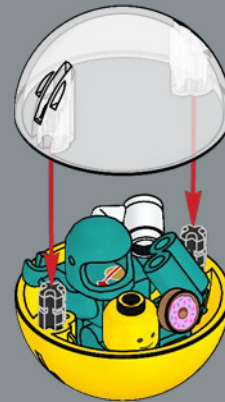

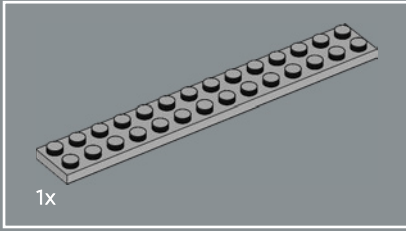
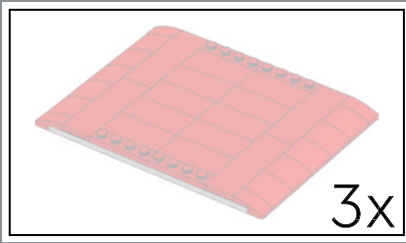

144

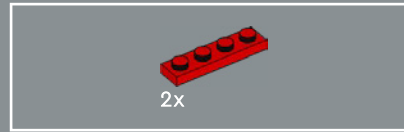
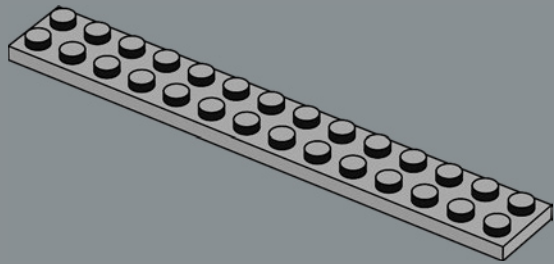

145

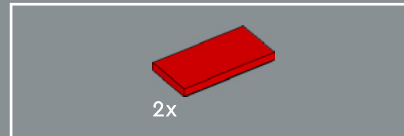
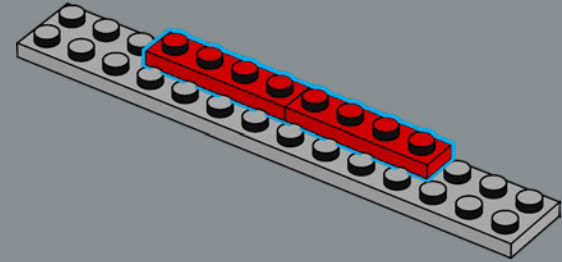

146

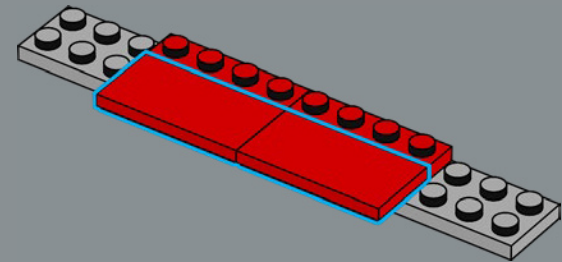

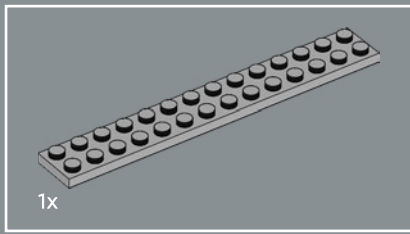

149

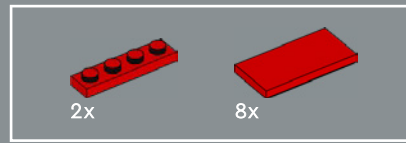
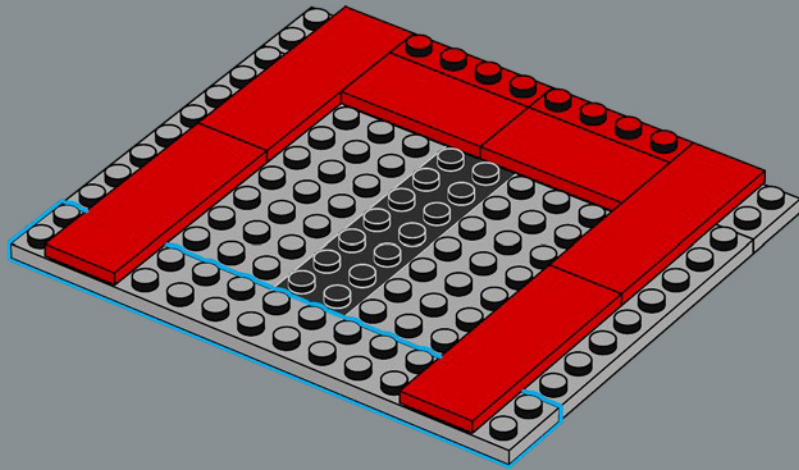

150

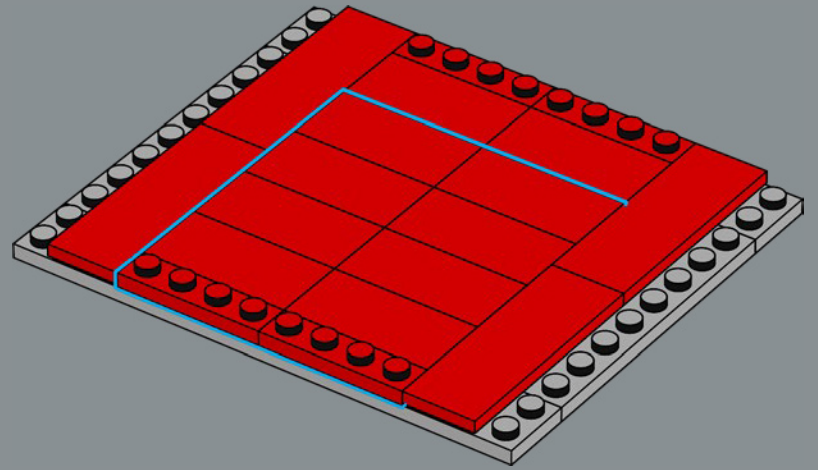



4x

151

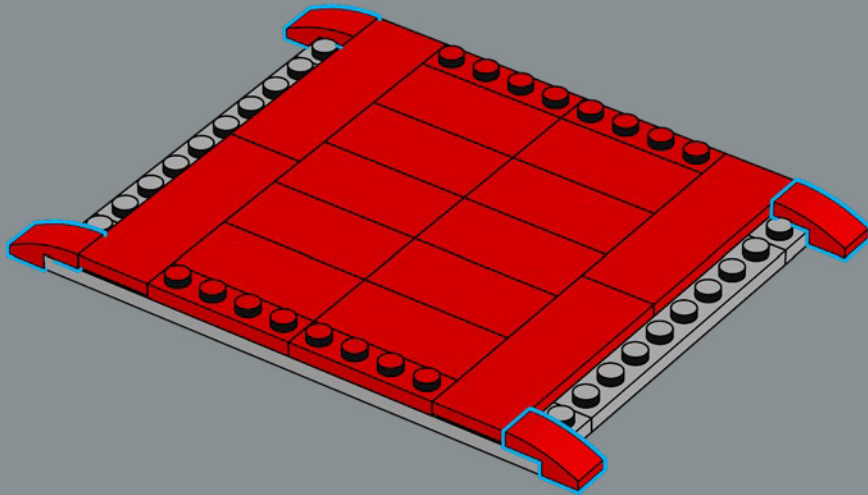

10x

152

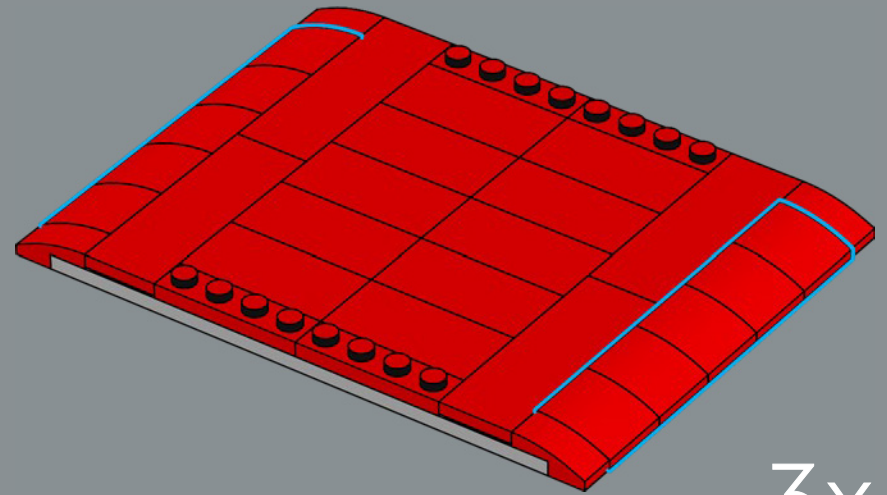

3x

153

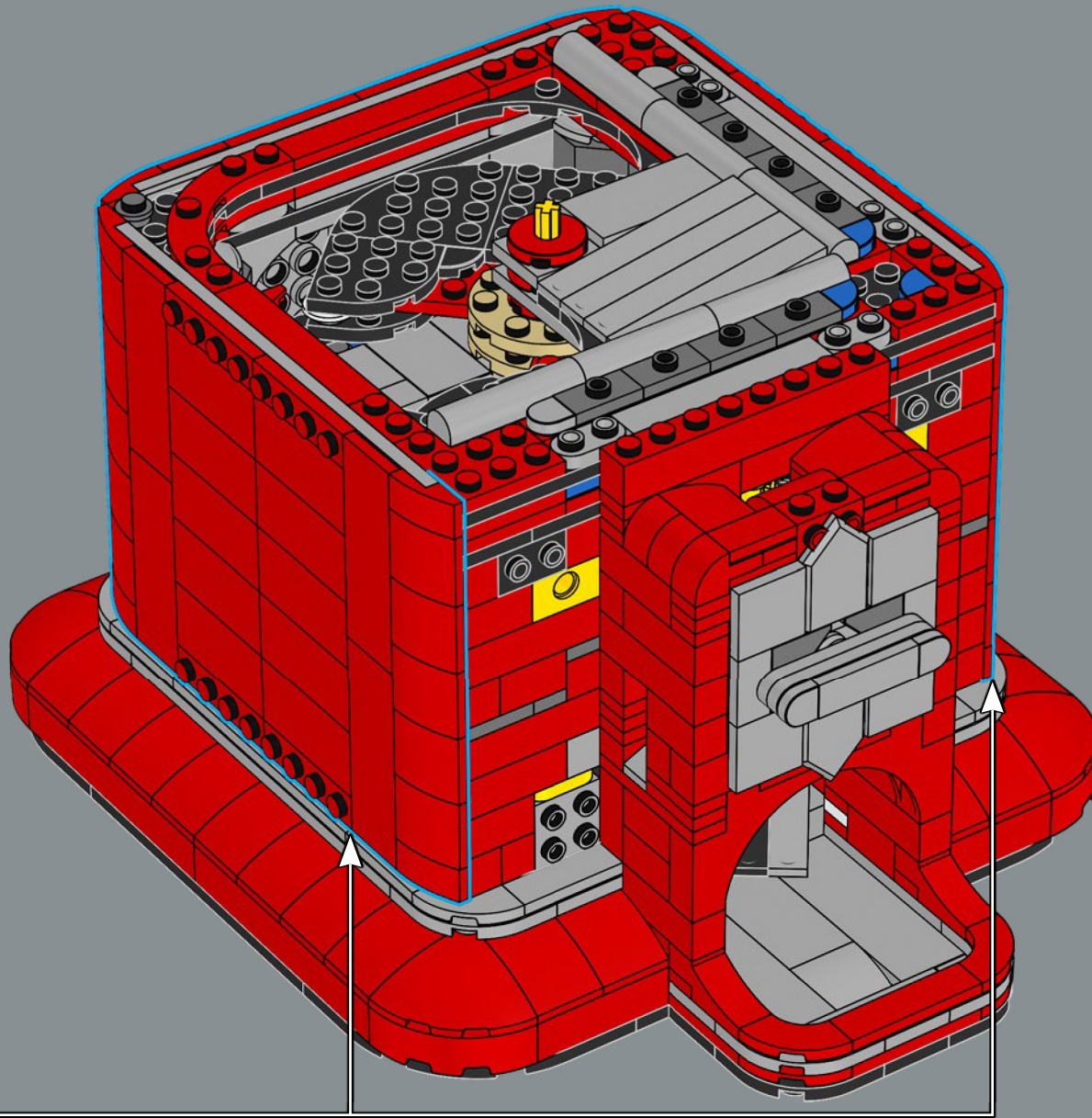

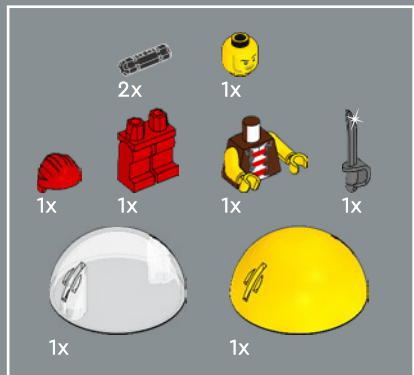
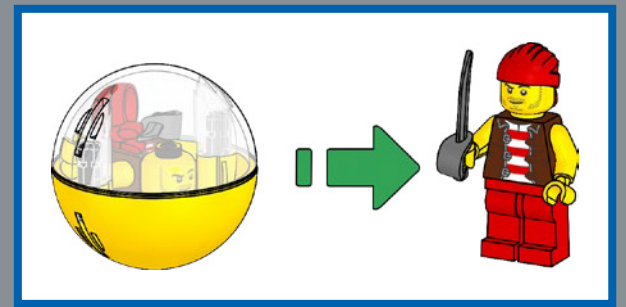

1

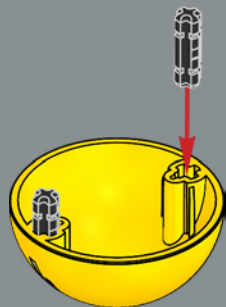

2



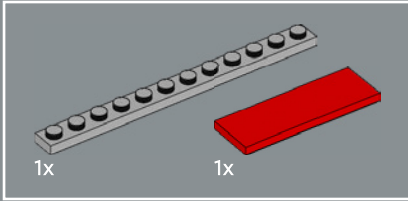
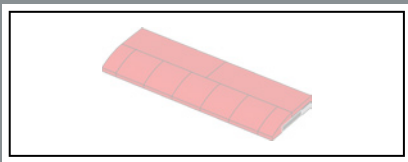

154

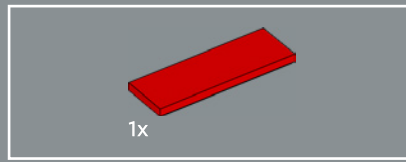
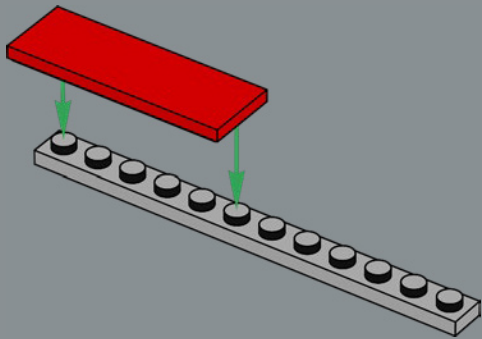

155

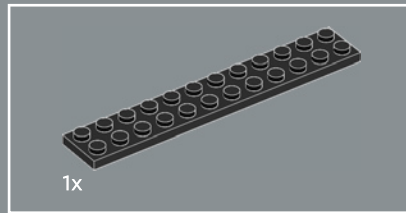
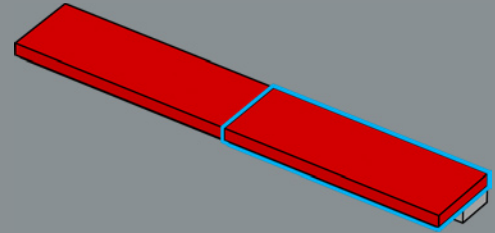

156

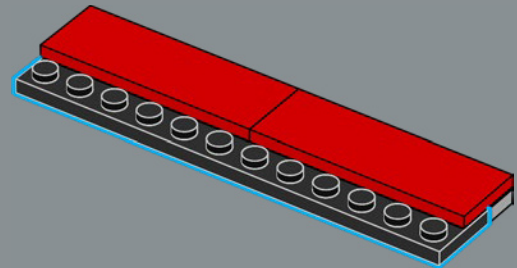



2x

157

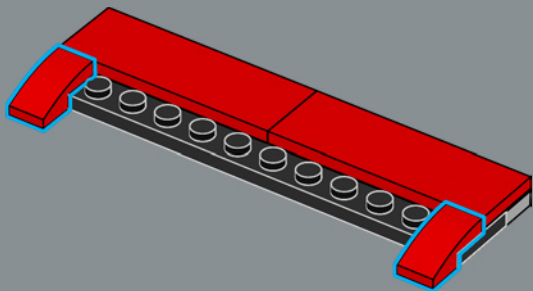

5x

158

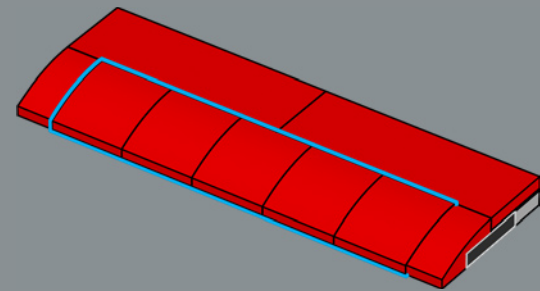

159

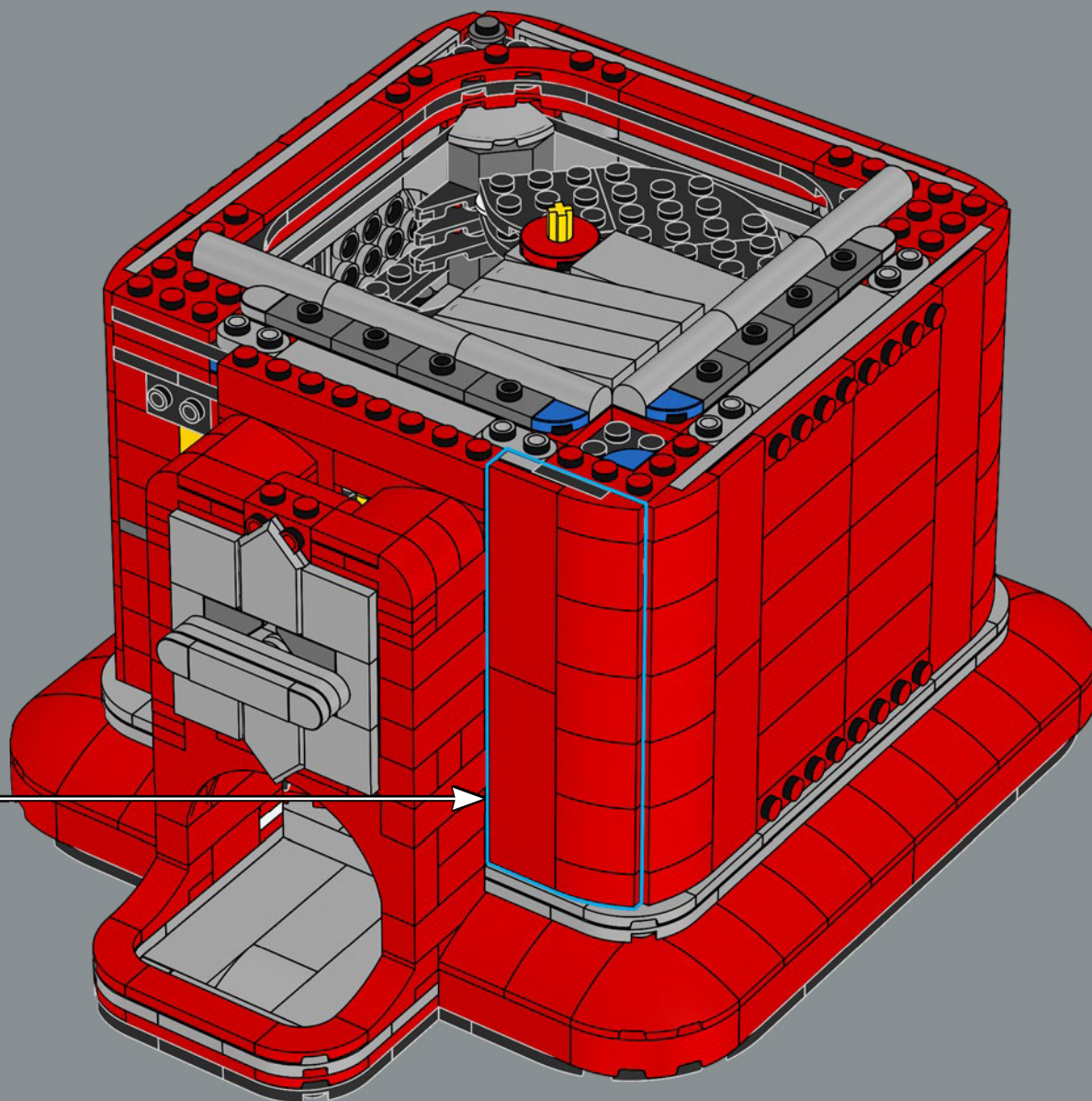

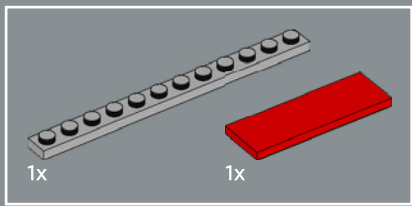

160

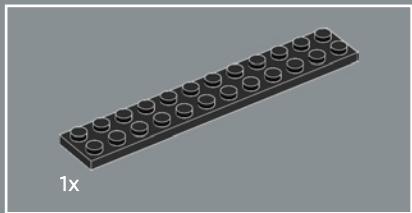
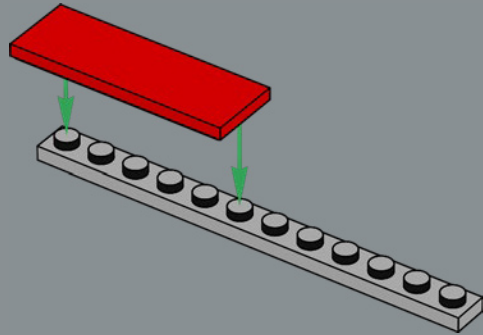

161

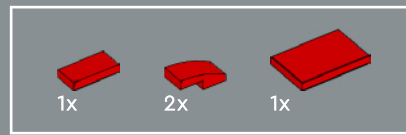
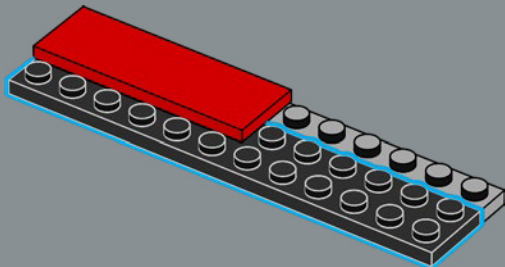

162

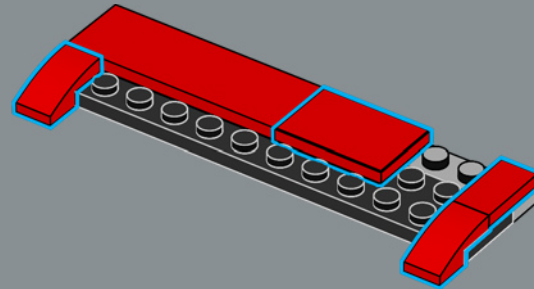

163

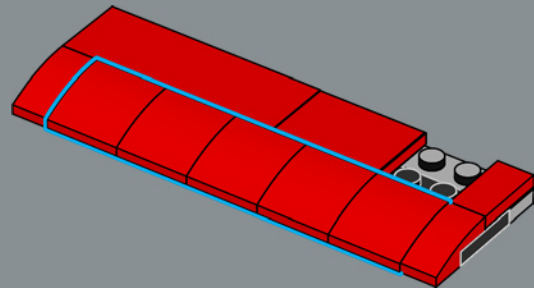

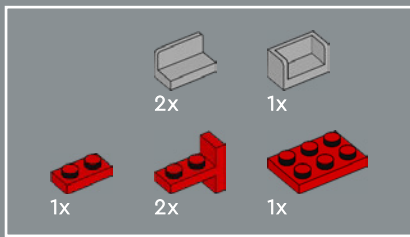

164

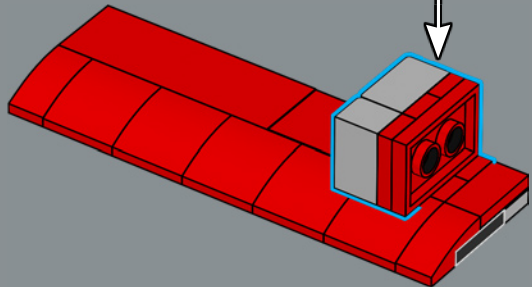
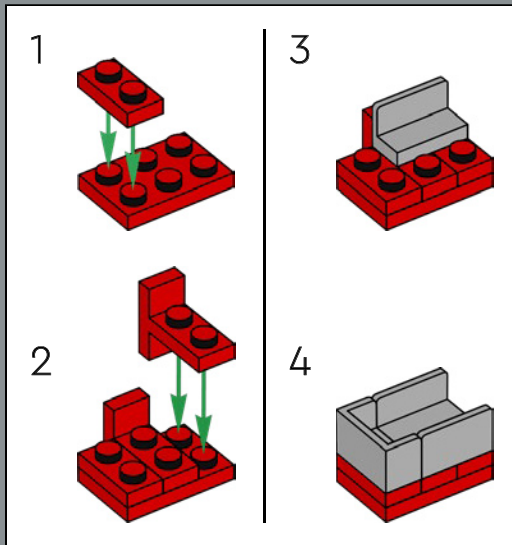

165

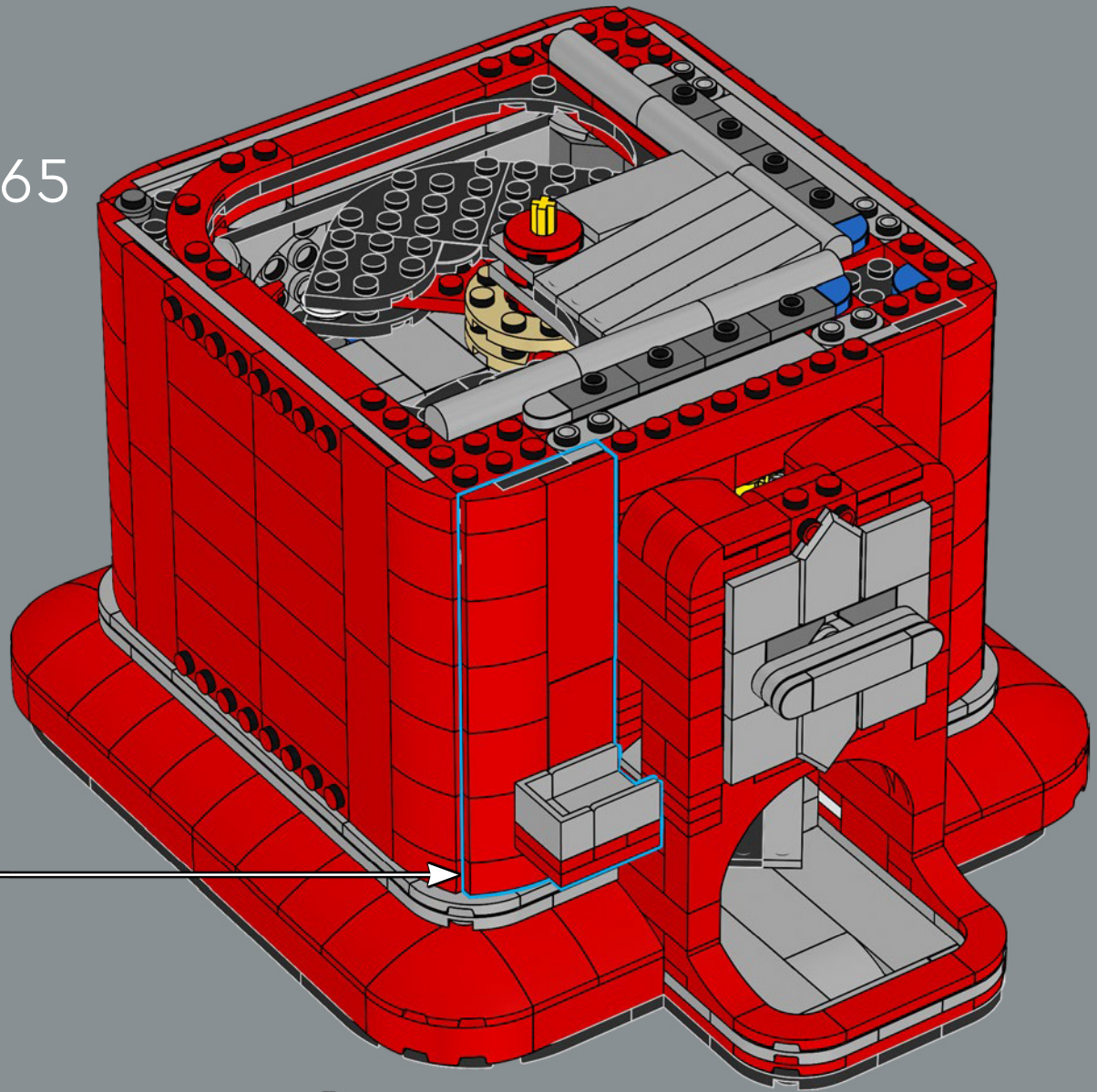

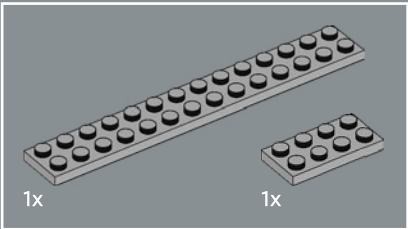
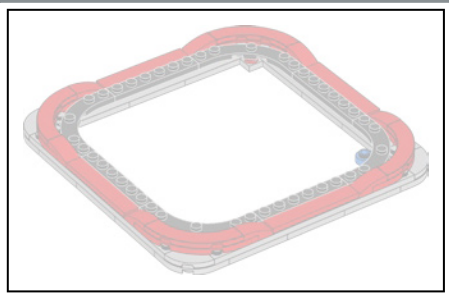

166

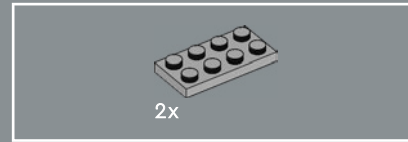
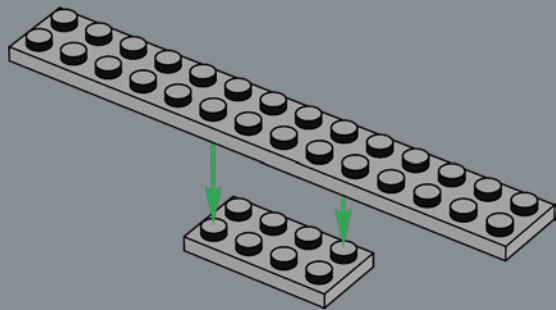

167

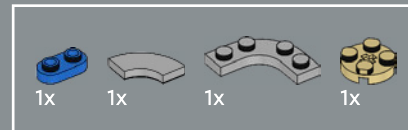
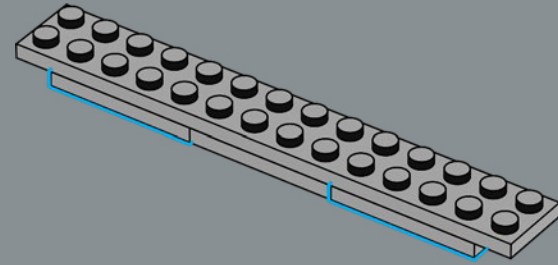

168

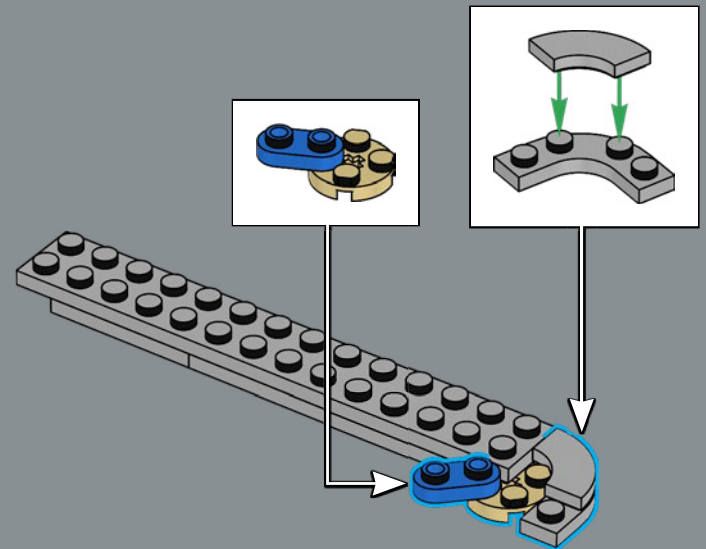

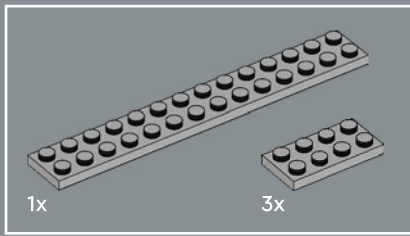

169

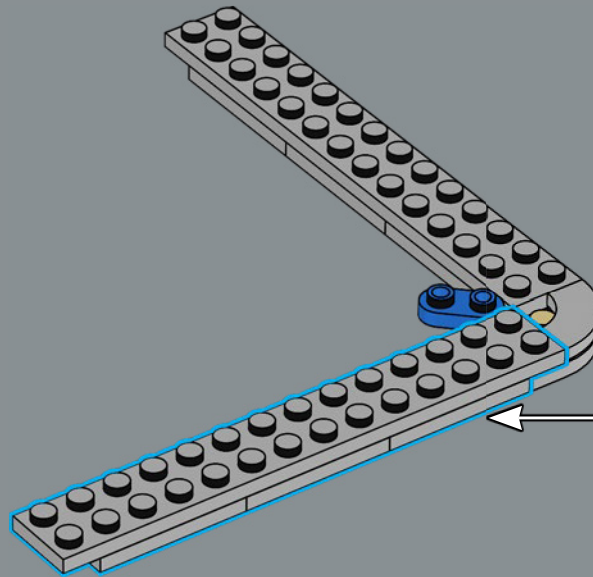
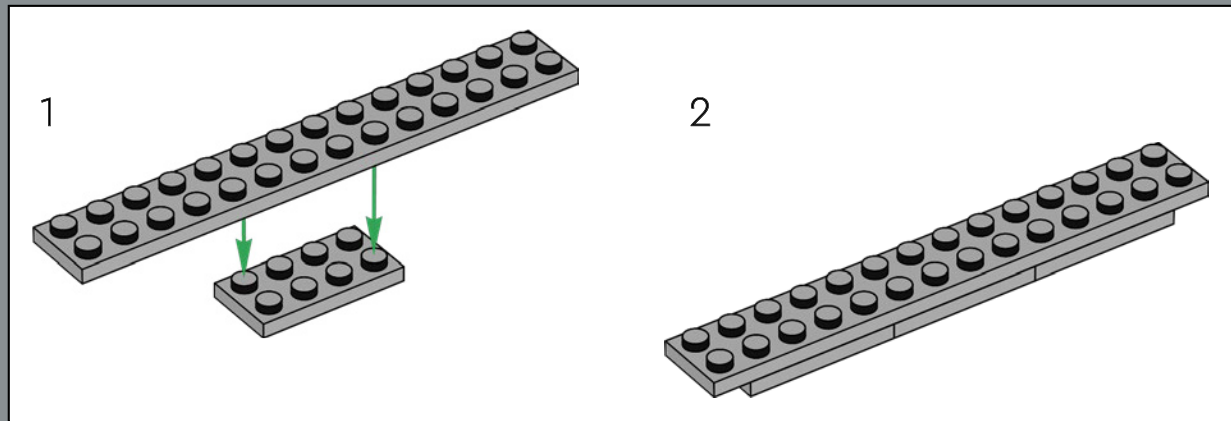

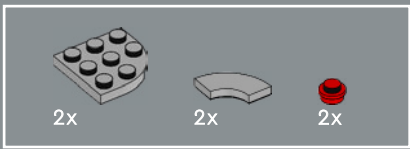

170

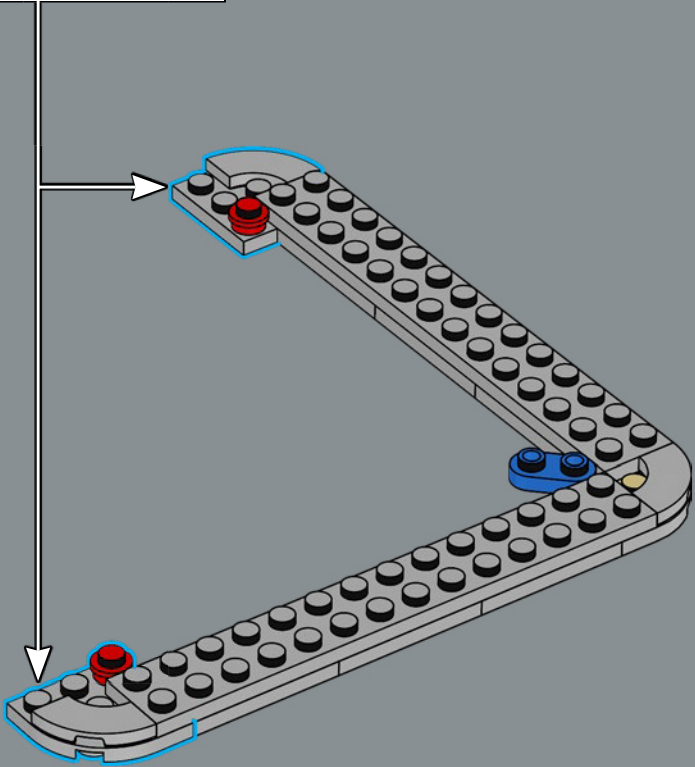
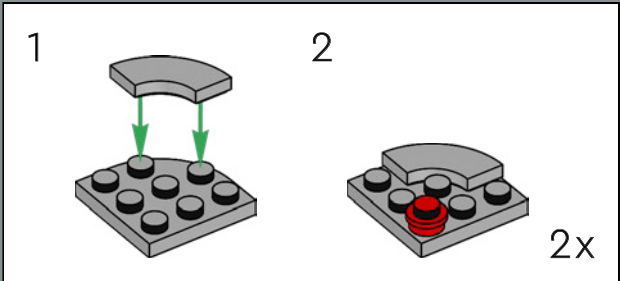

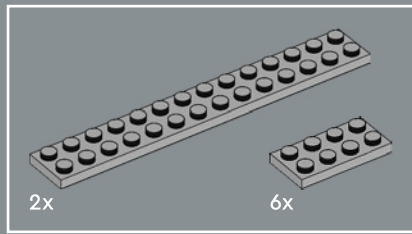

171

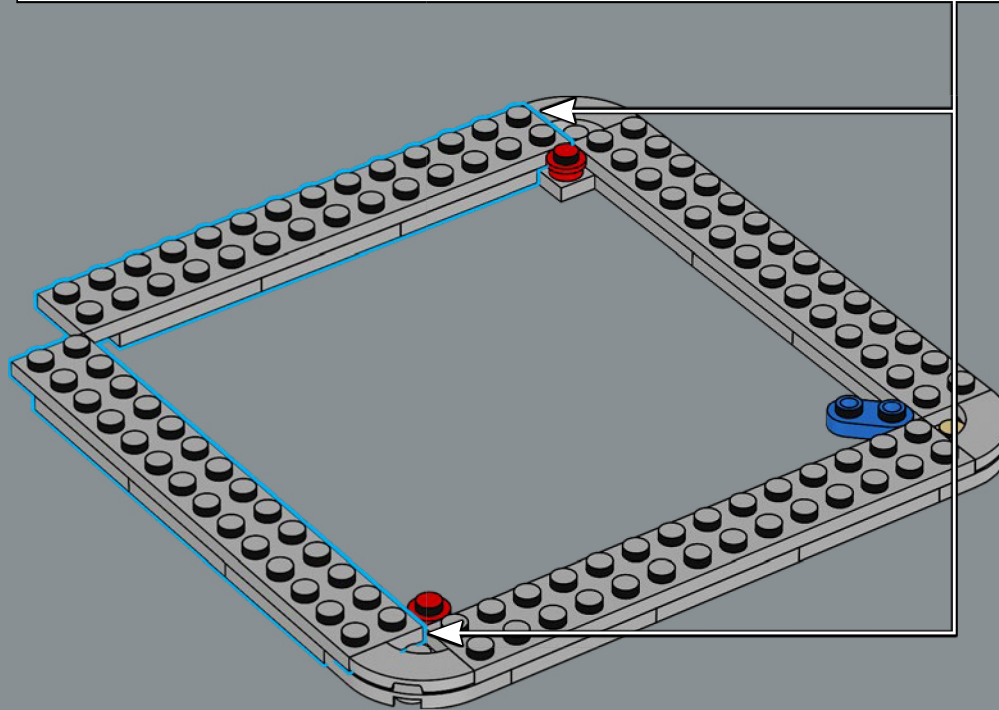
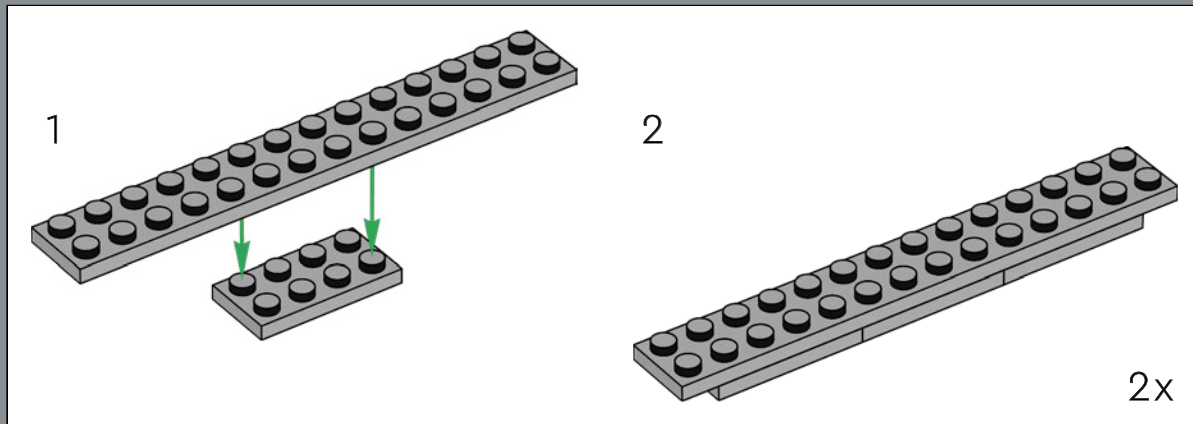

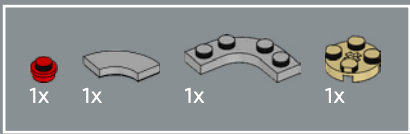

172

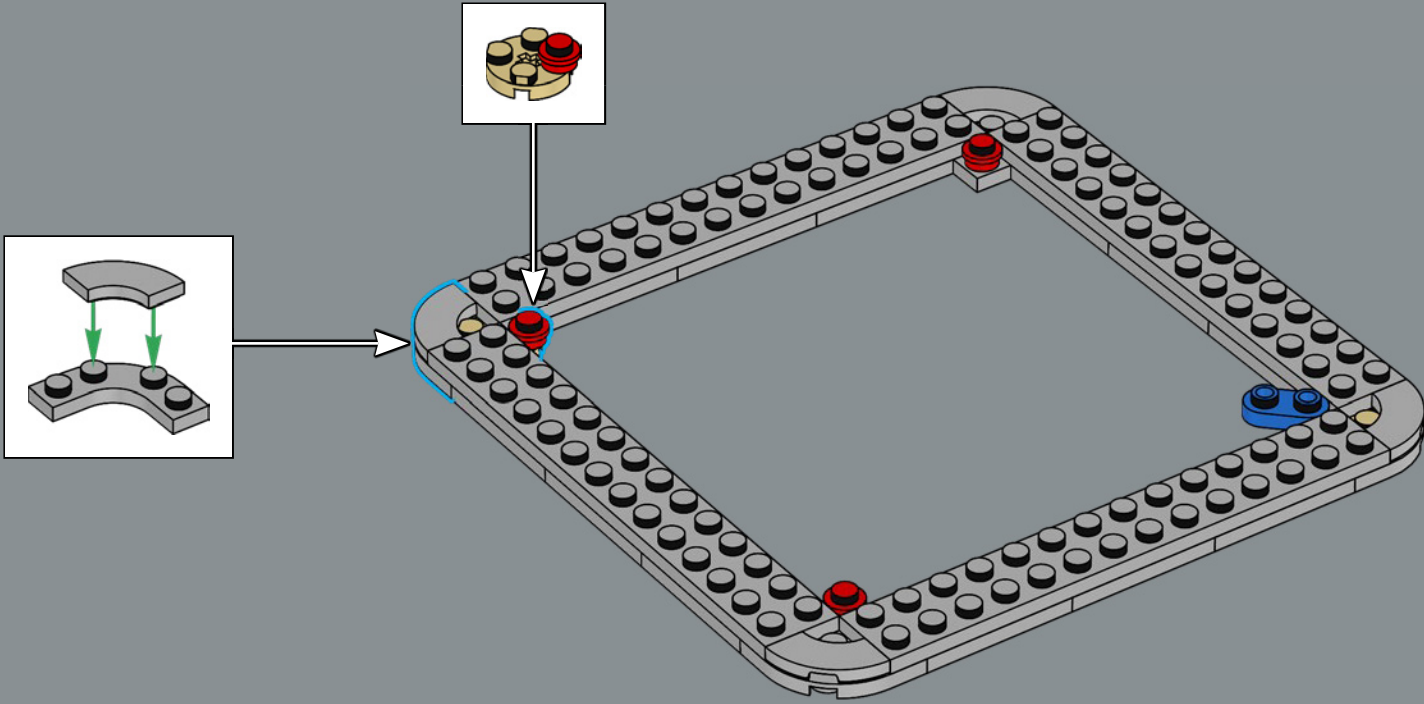

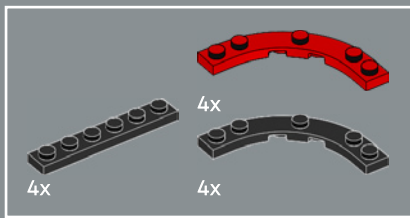

173

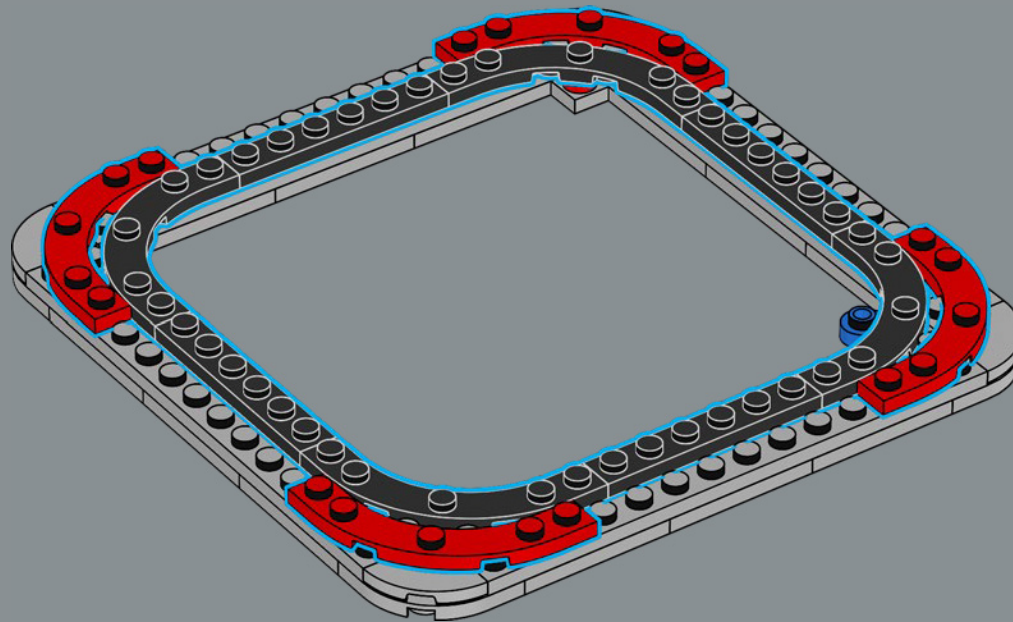

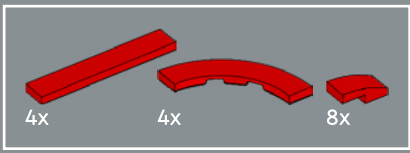

174

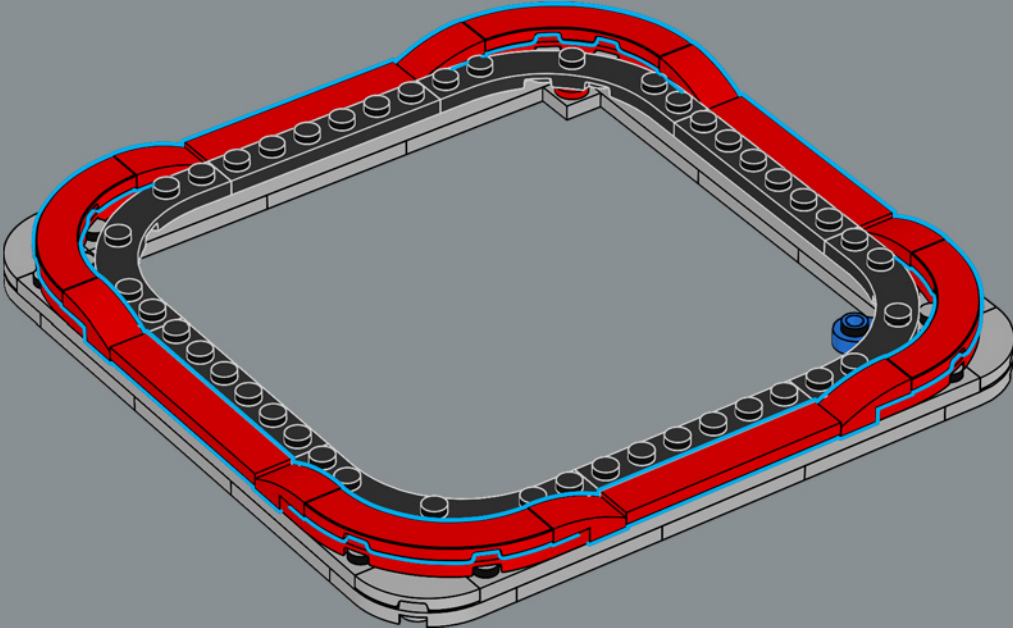

175

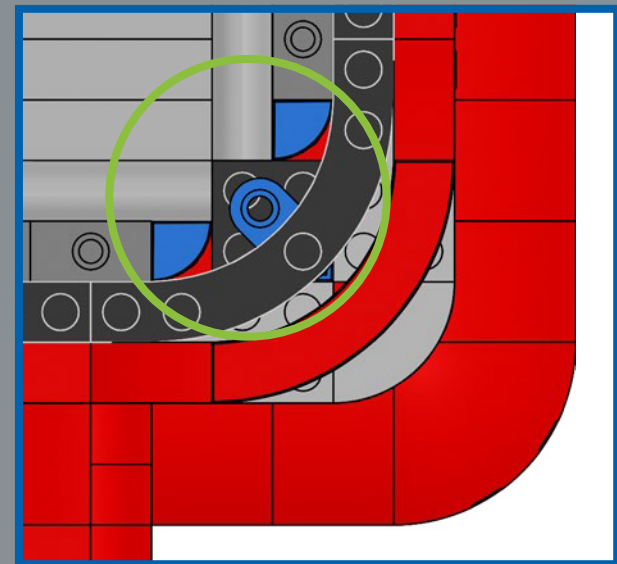
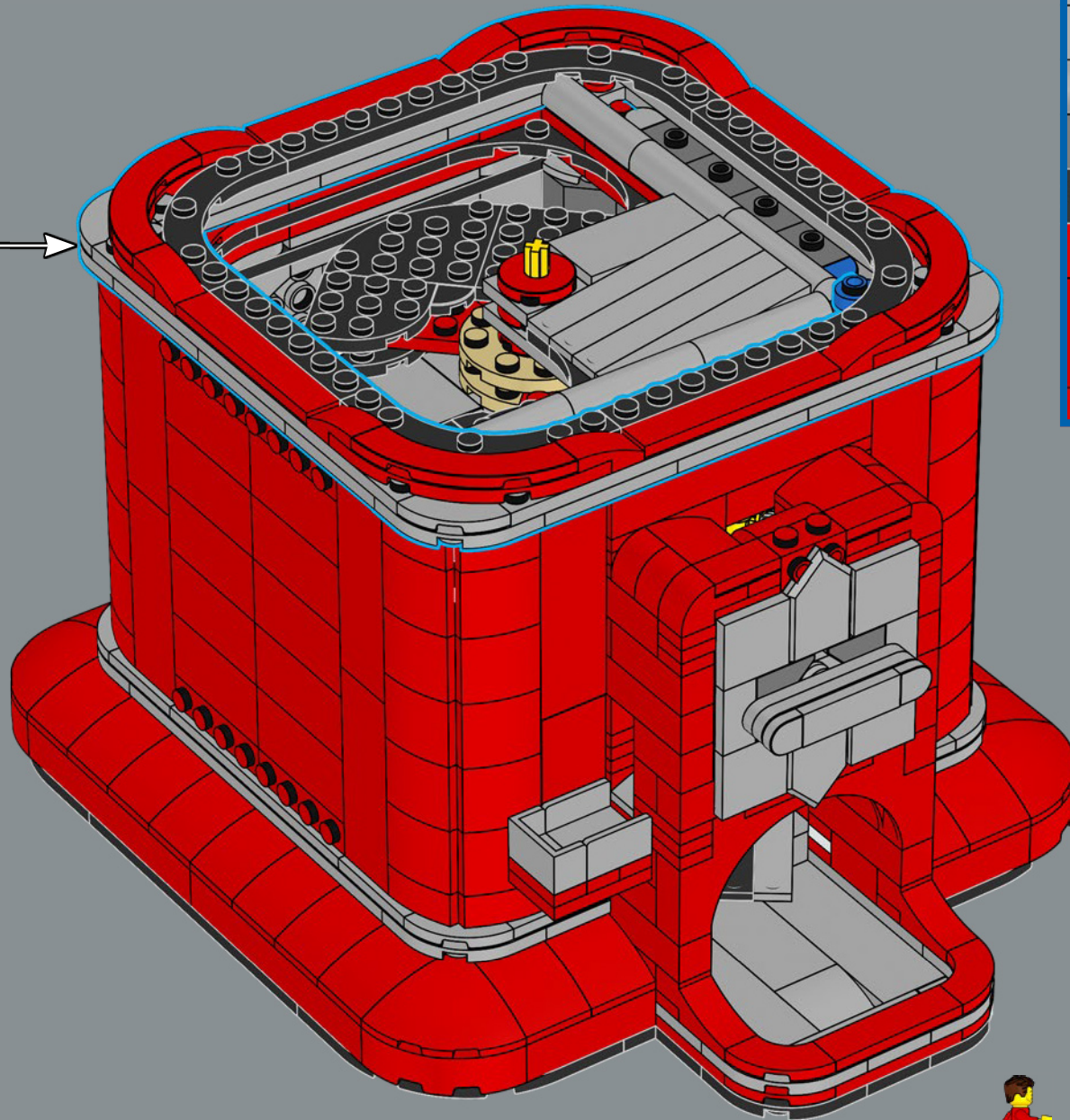



8x

176

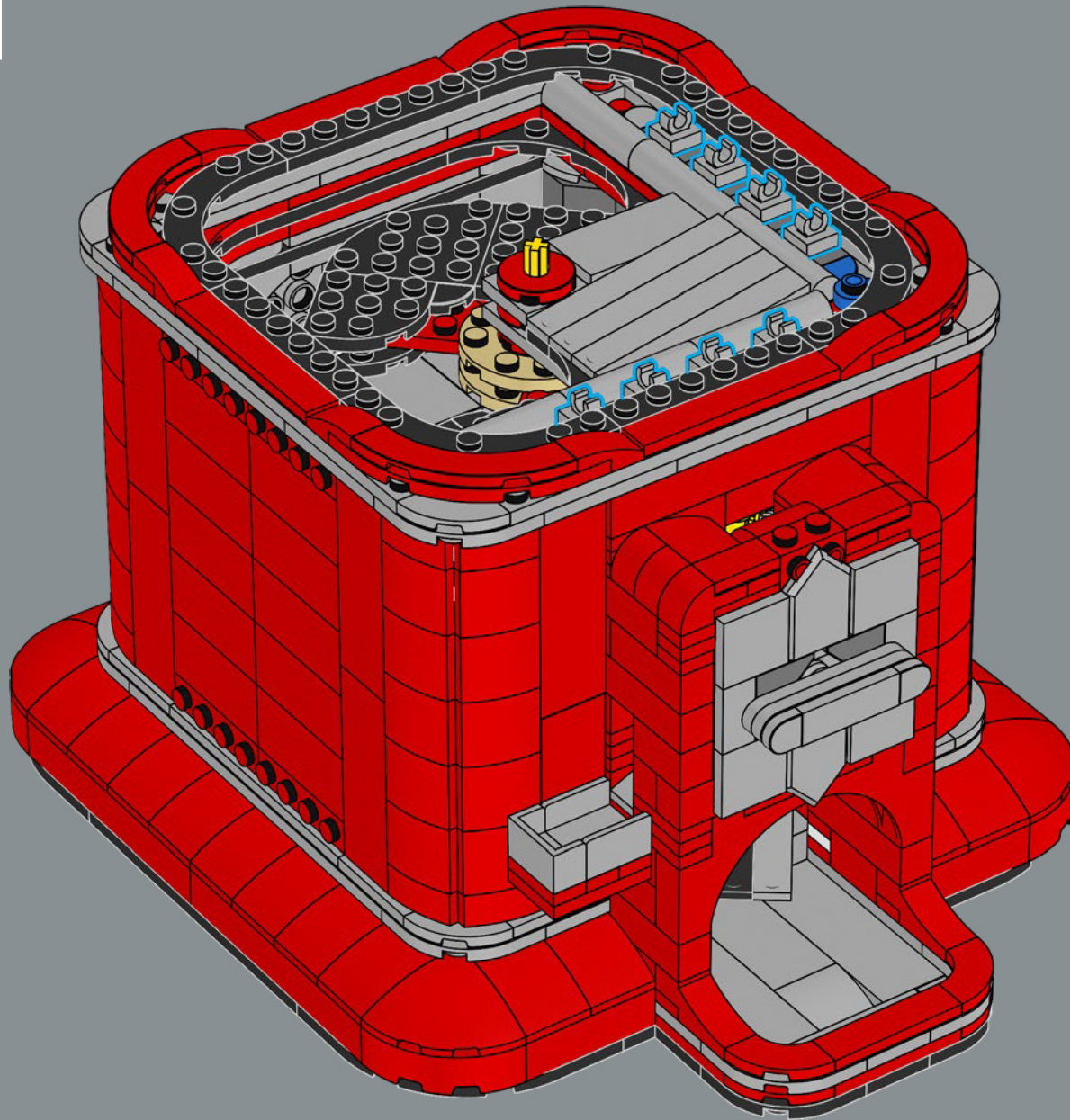

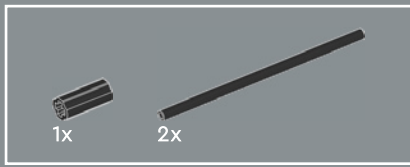

177

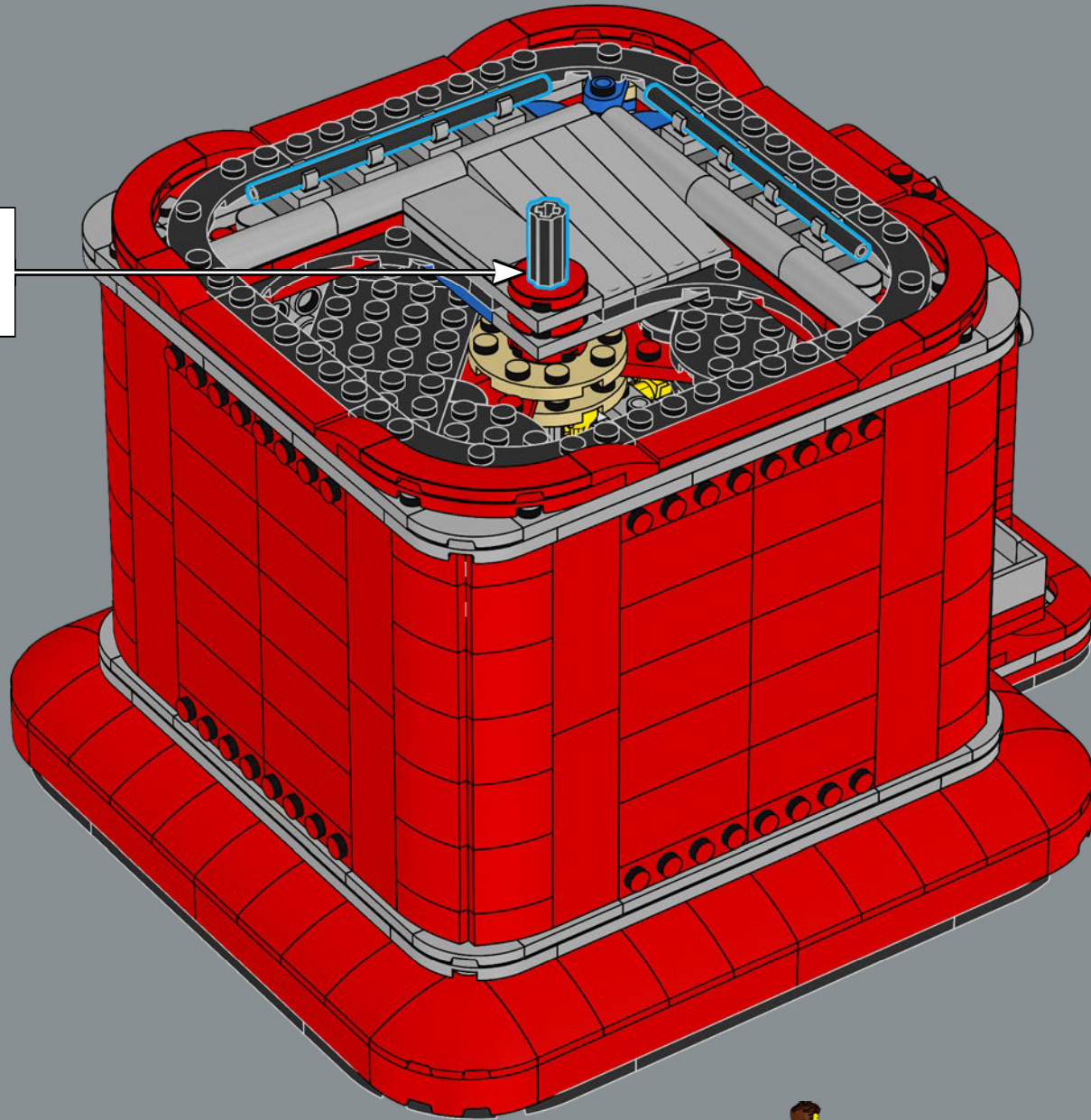
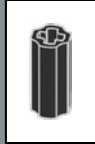



10x

178

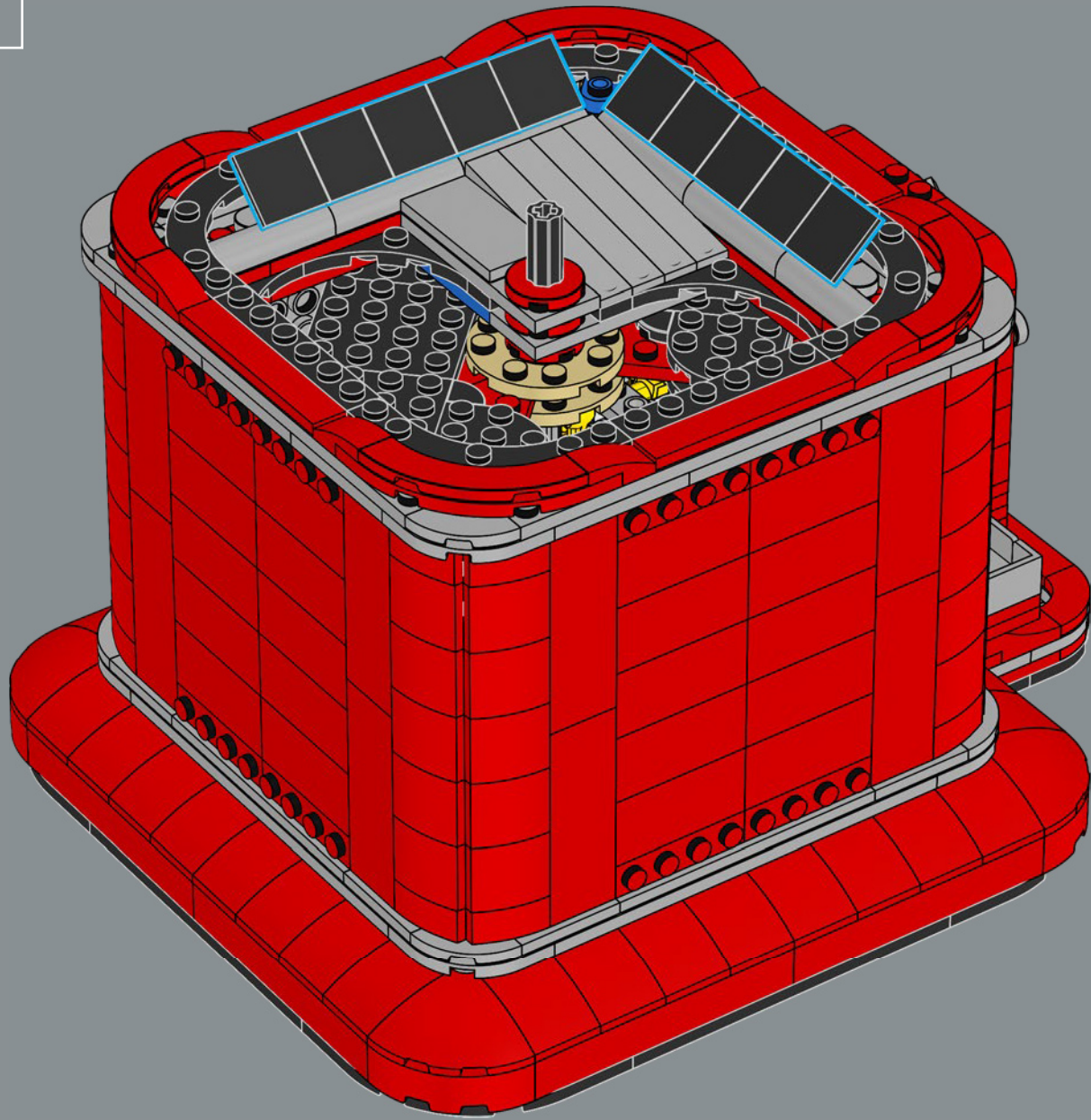

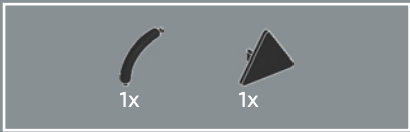

179

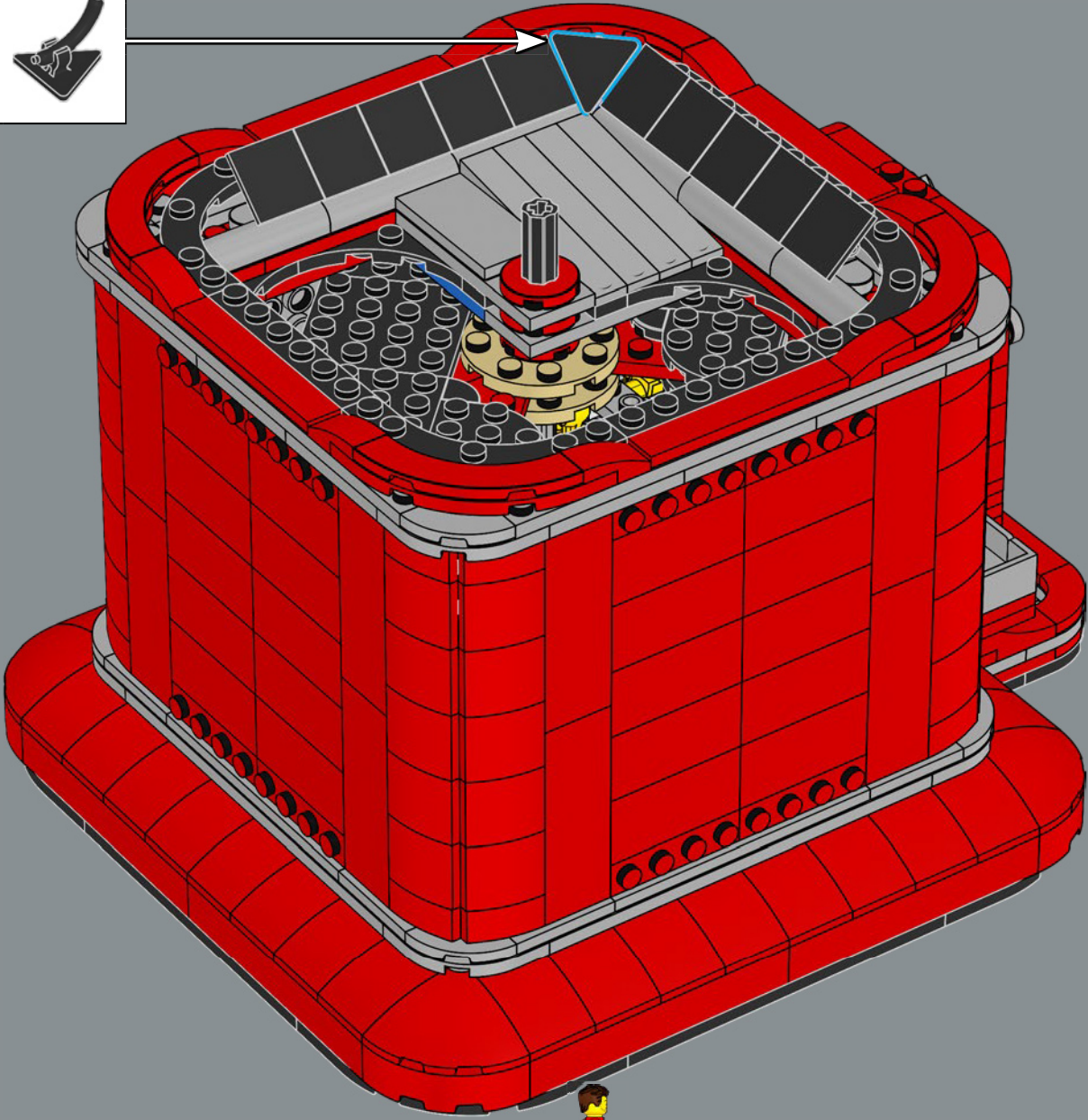
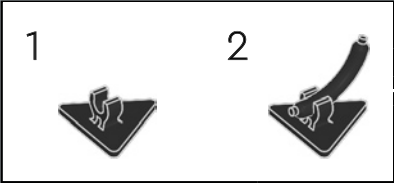

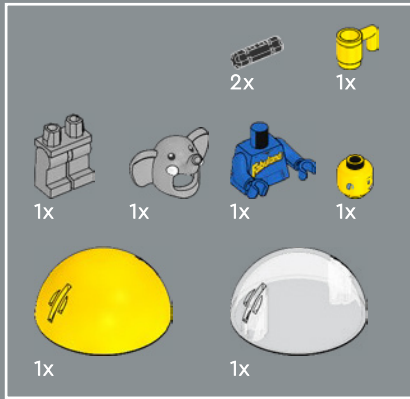
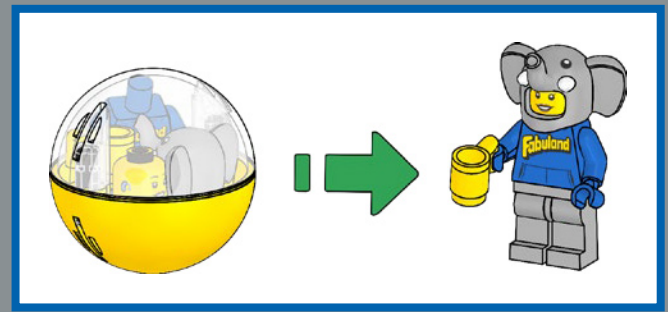
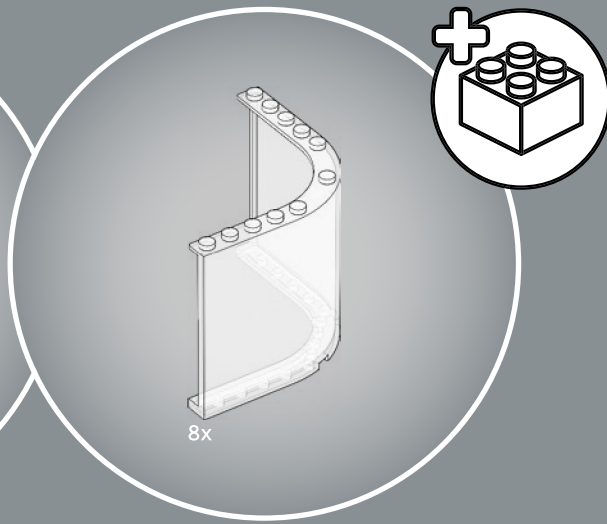

1

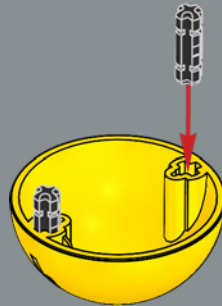

2

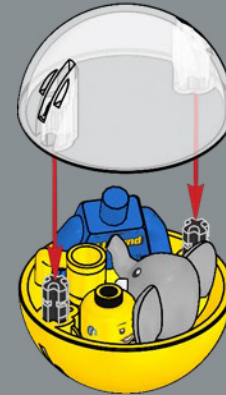

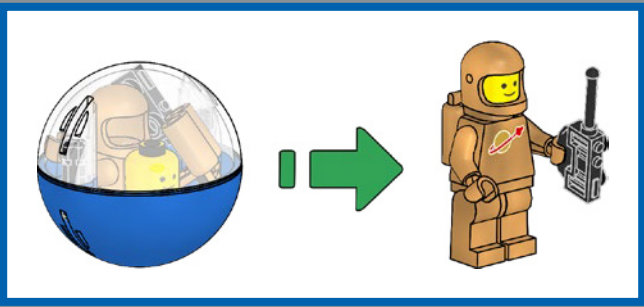
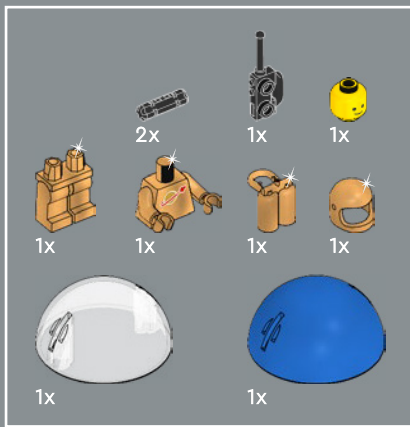

1

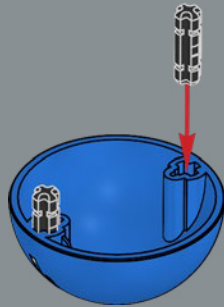

2

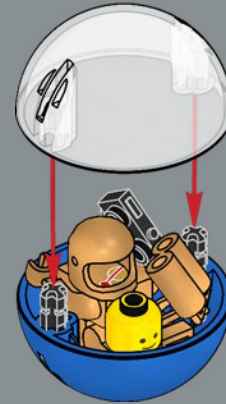

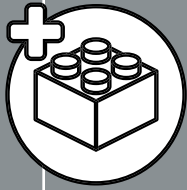
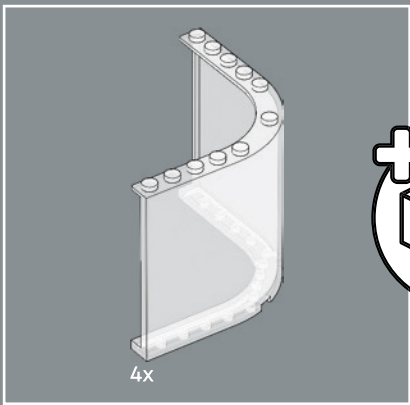

180

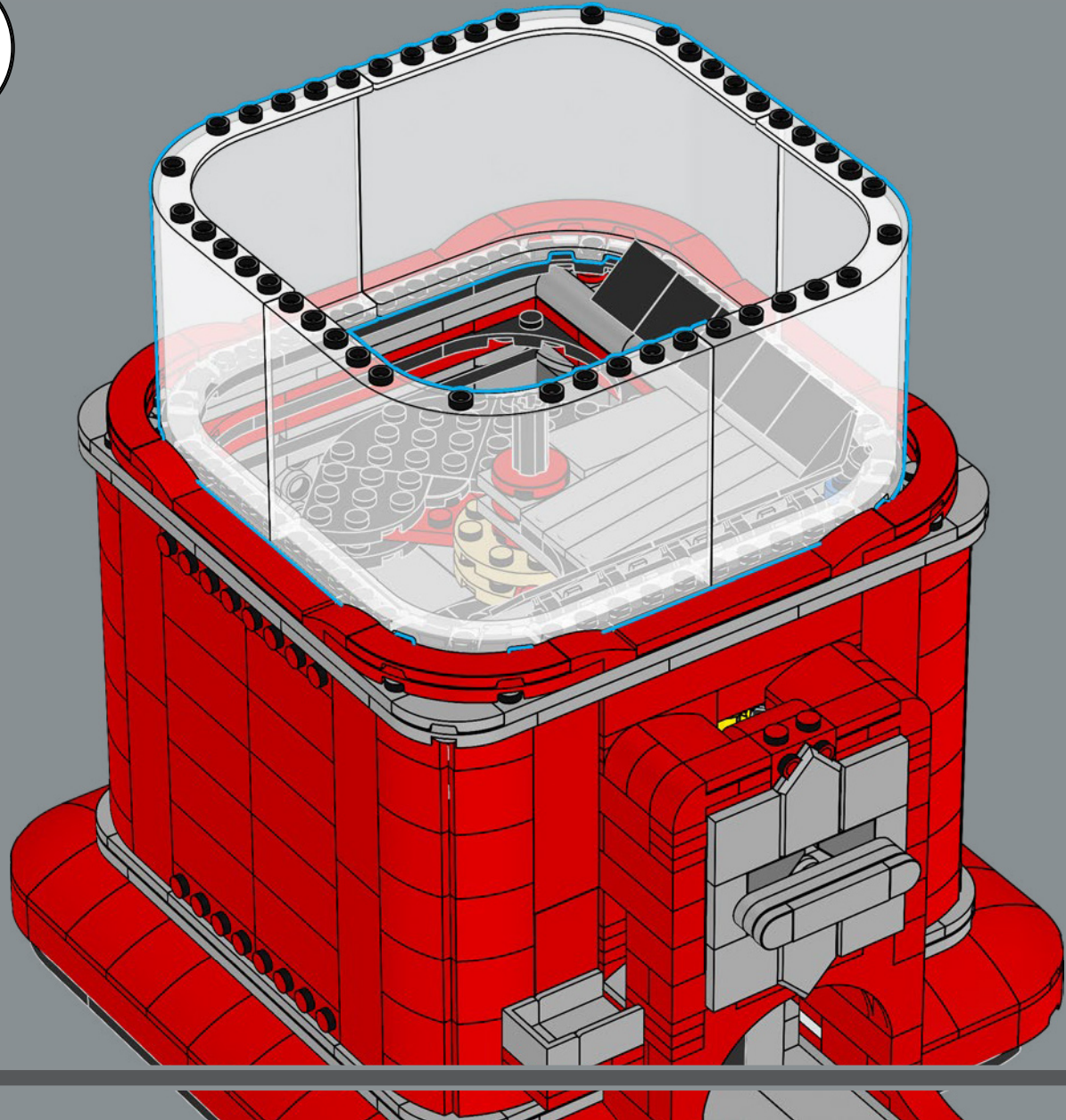



181

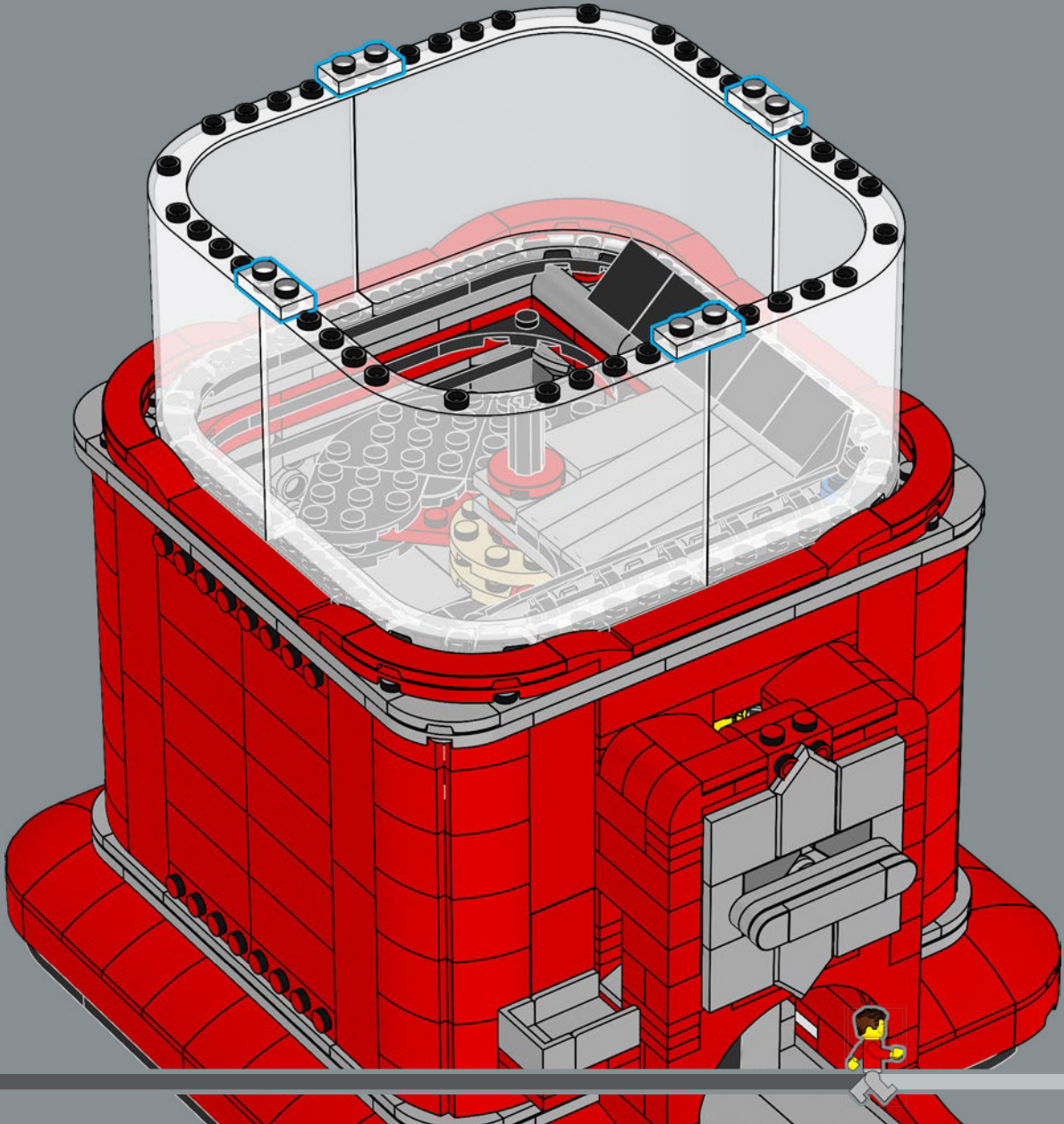

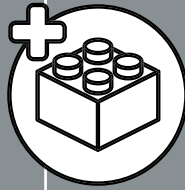
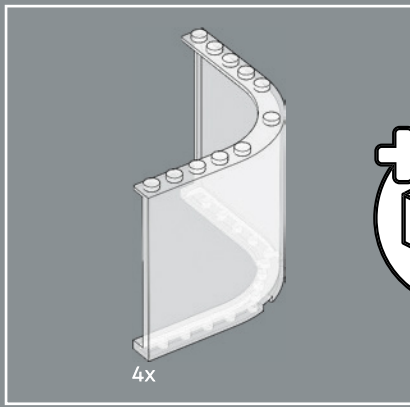

183

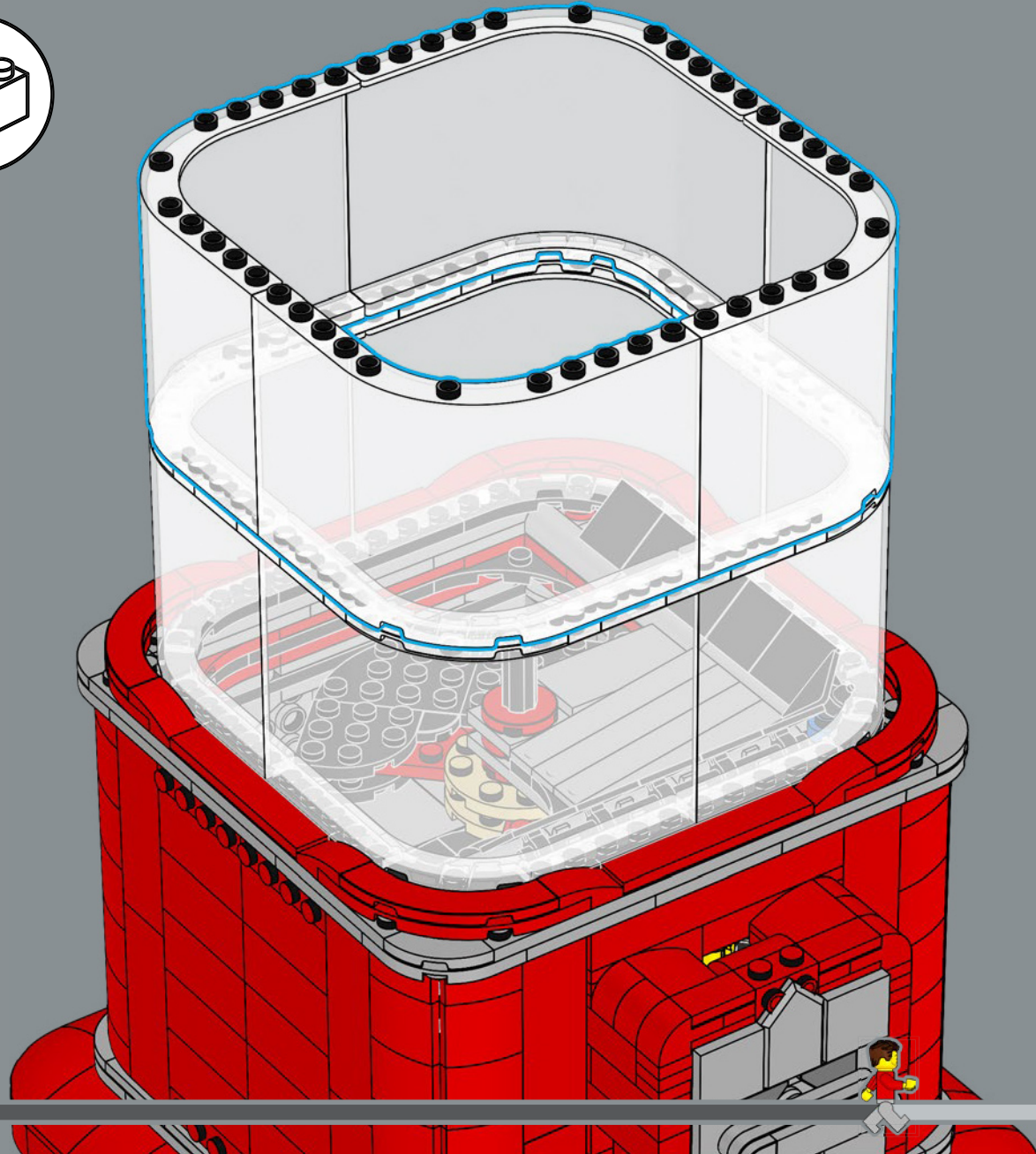

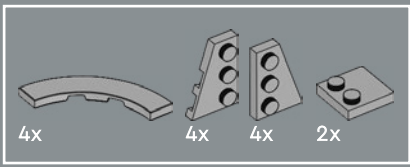

184

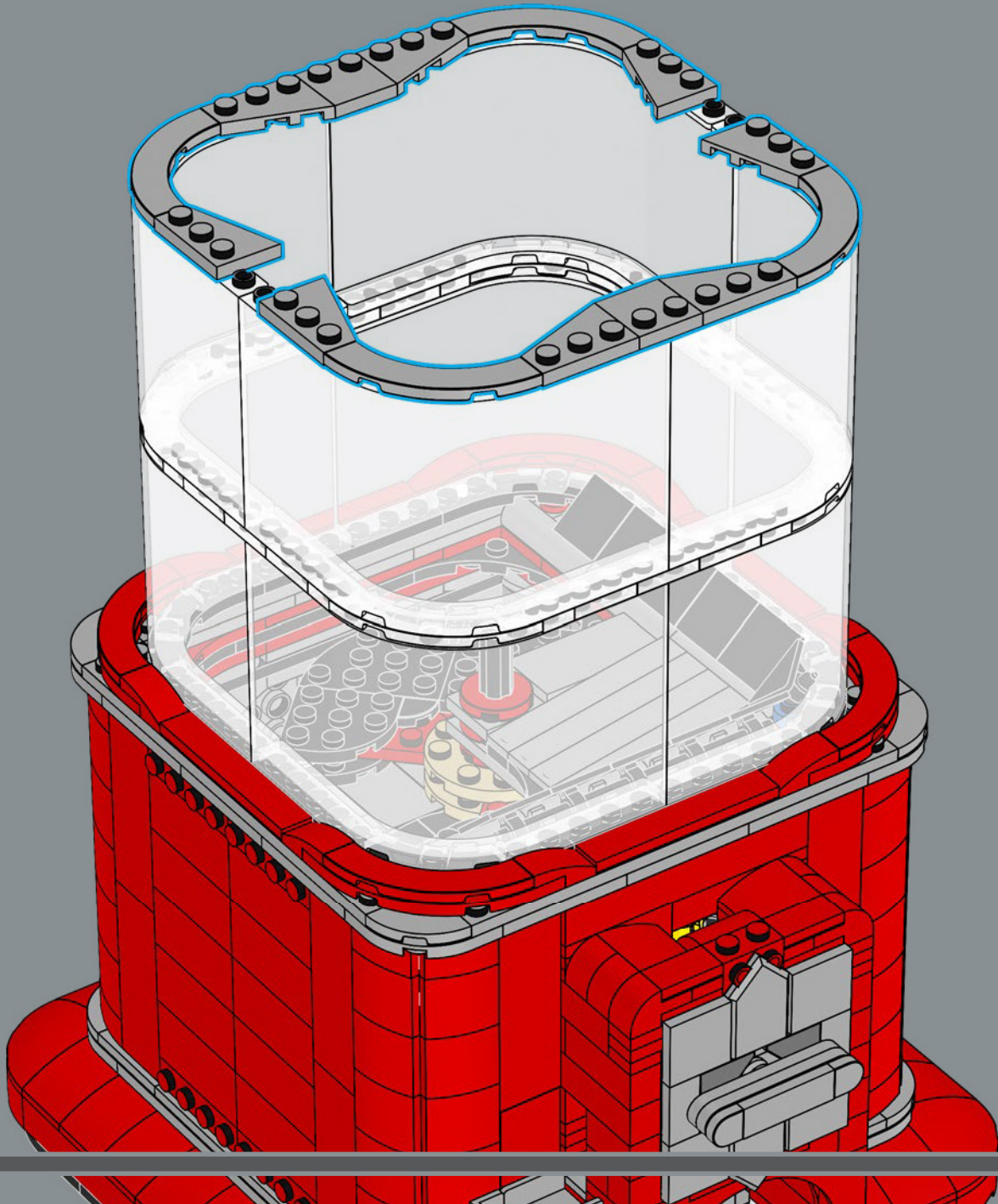

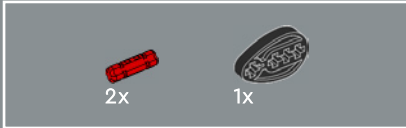
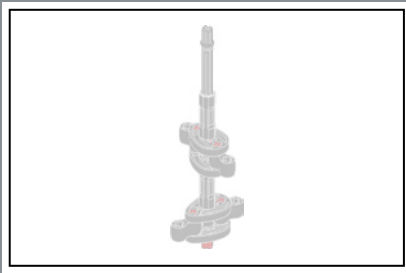

185

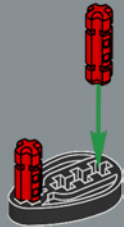

186



187

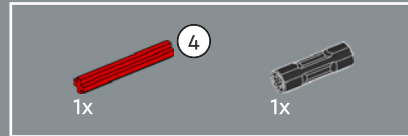

188

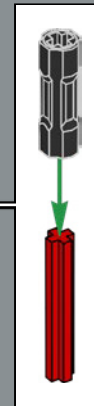
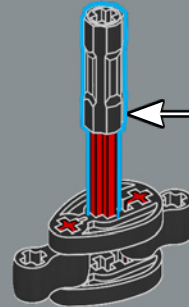

189

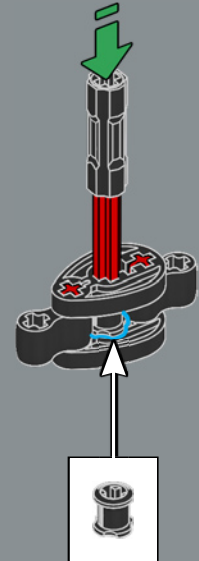

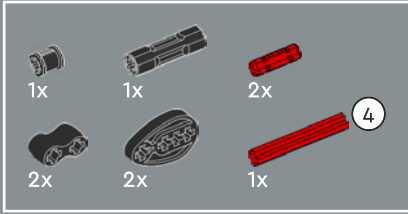
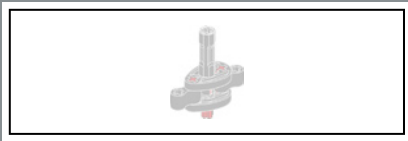

190

1

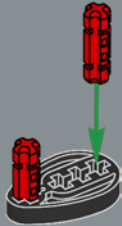

2



3



4

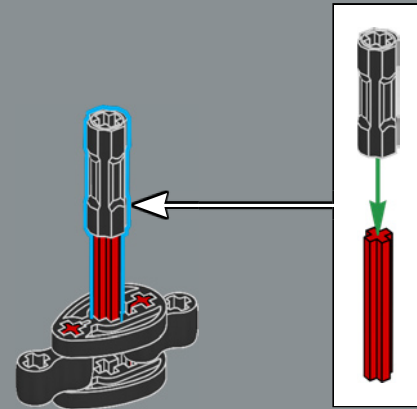

5

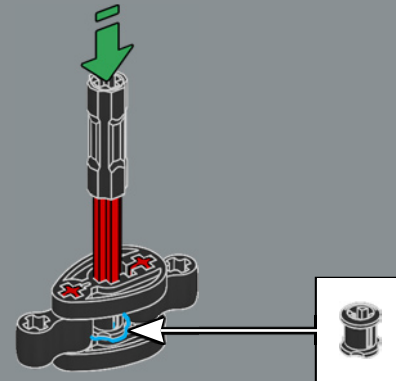

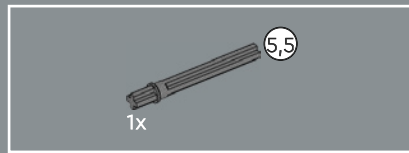

191

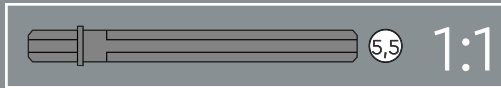
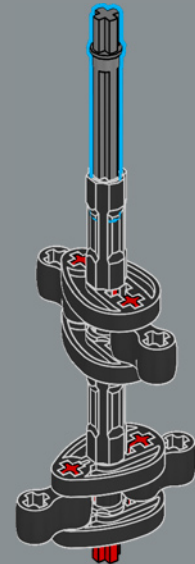
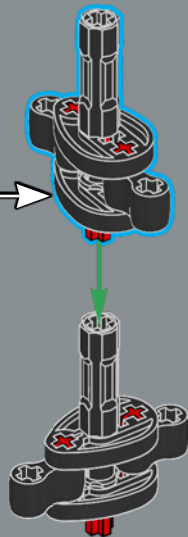

192

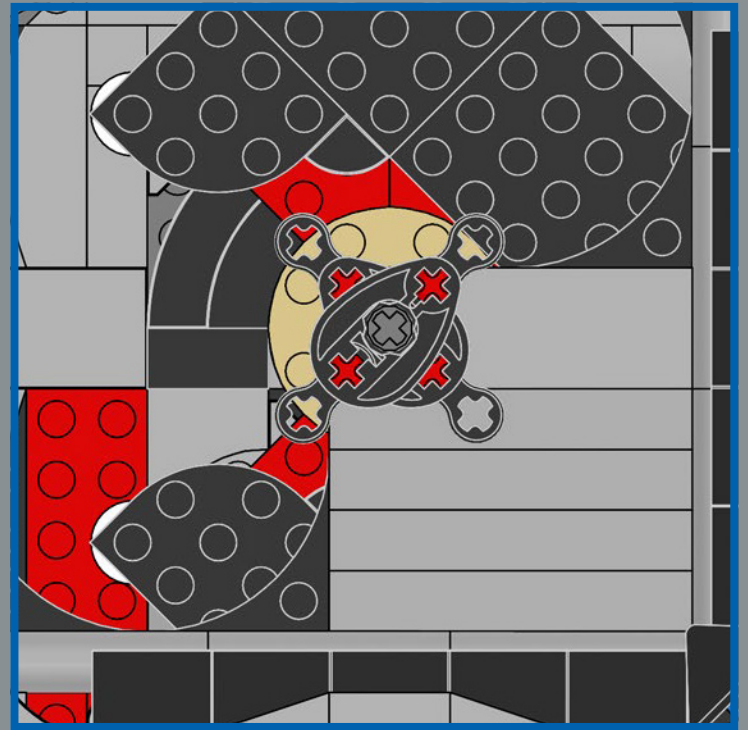
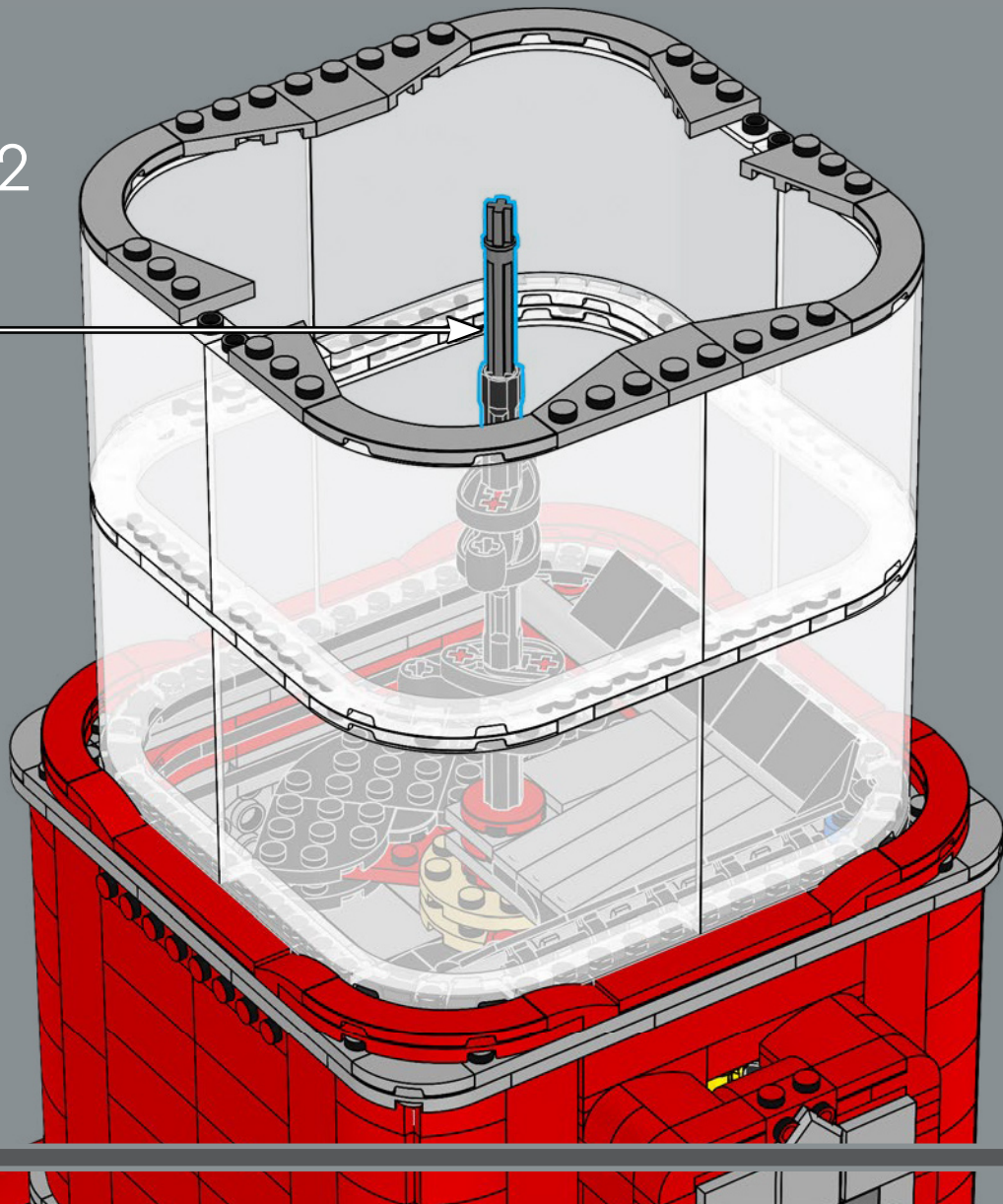

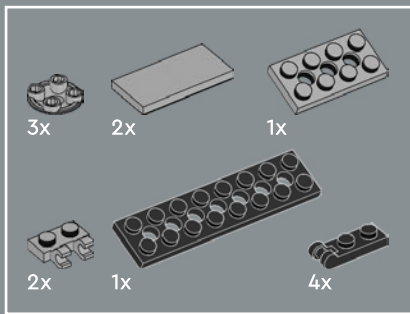

193

1

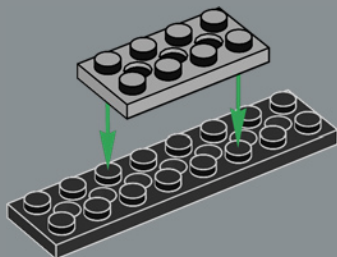

2

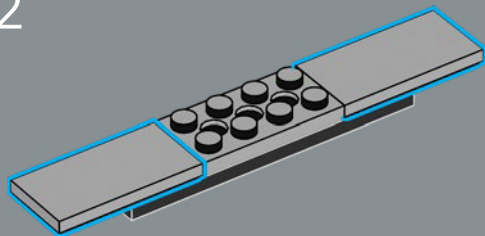

3

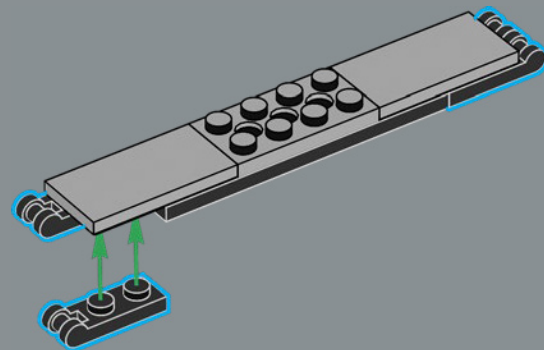

4

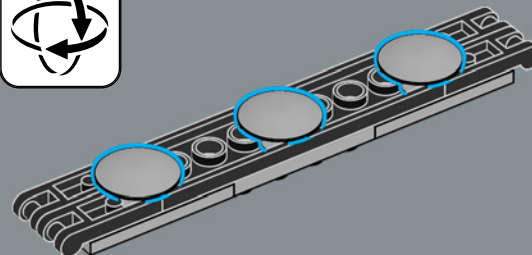

5

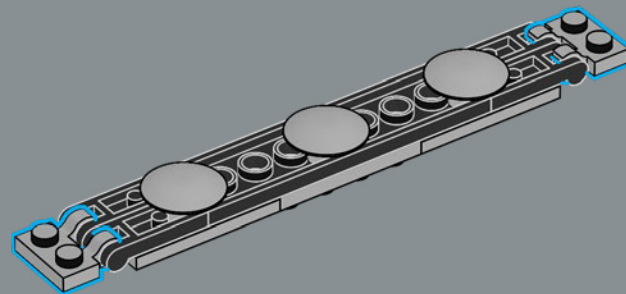

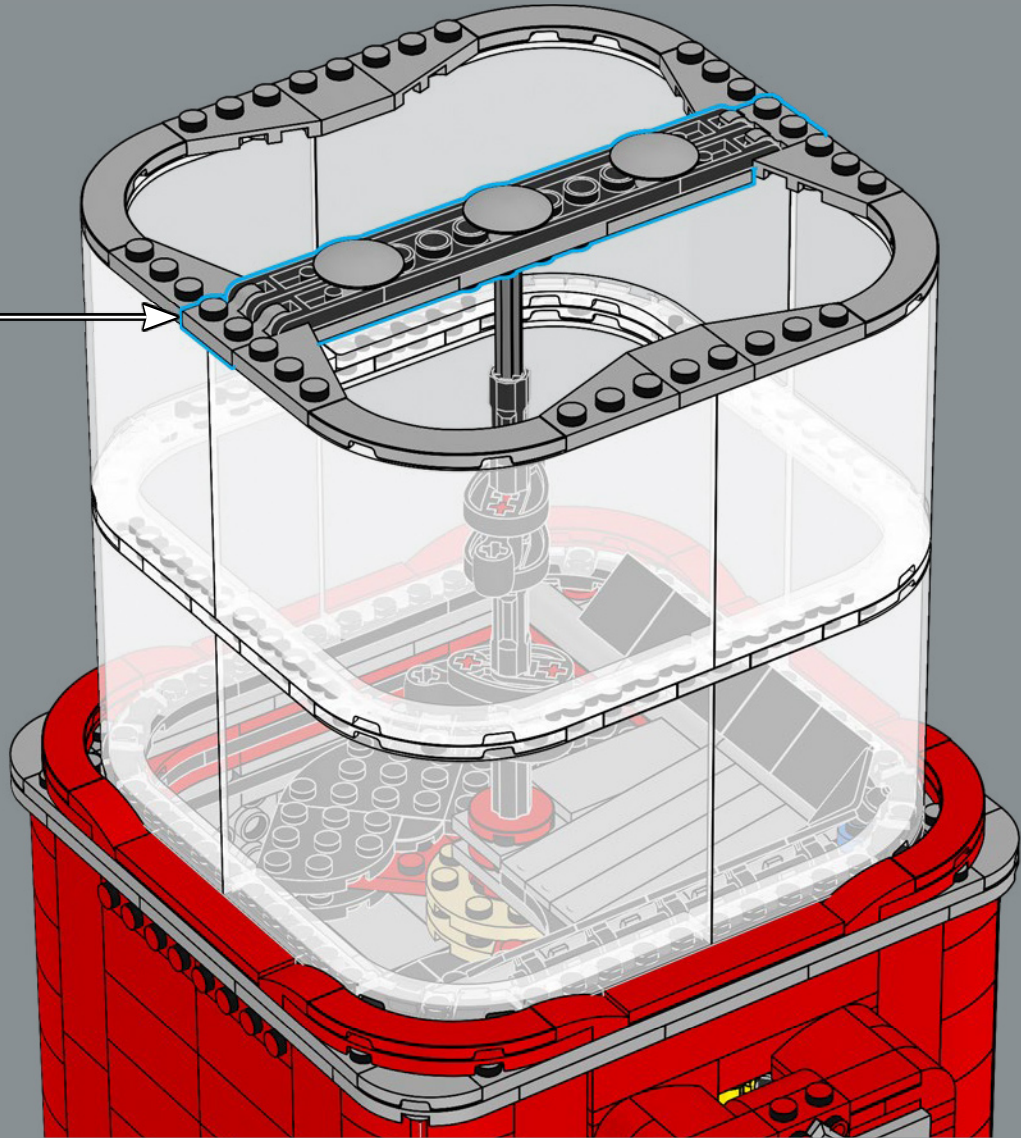

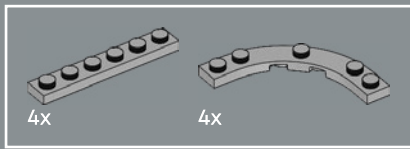

194

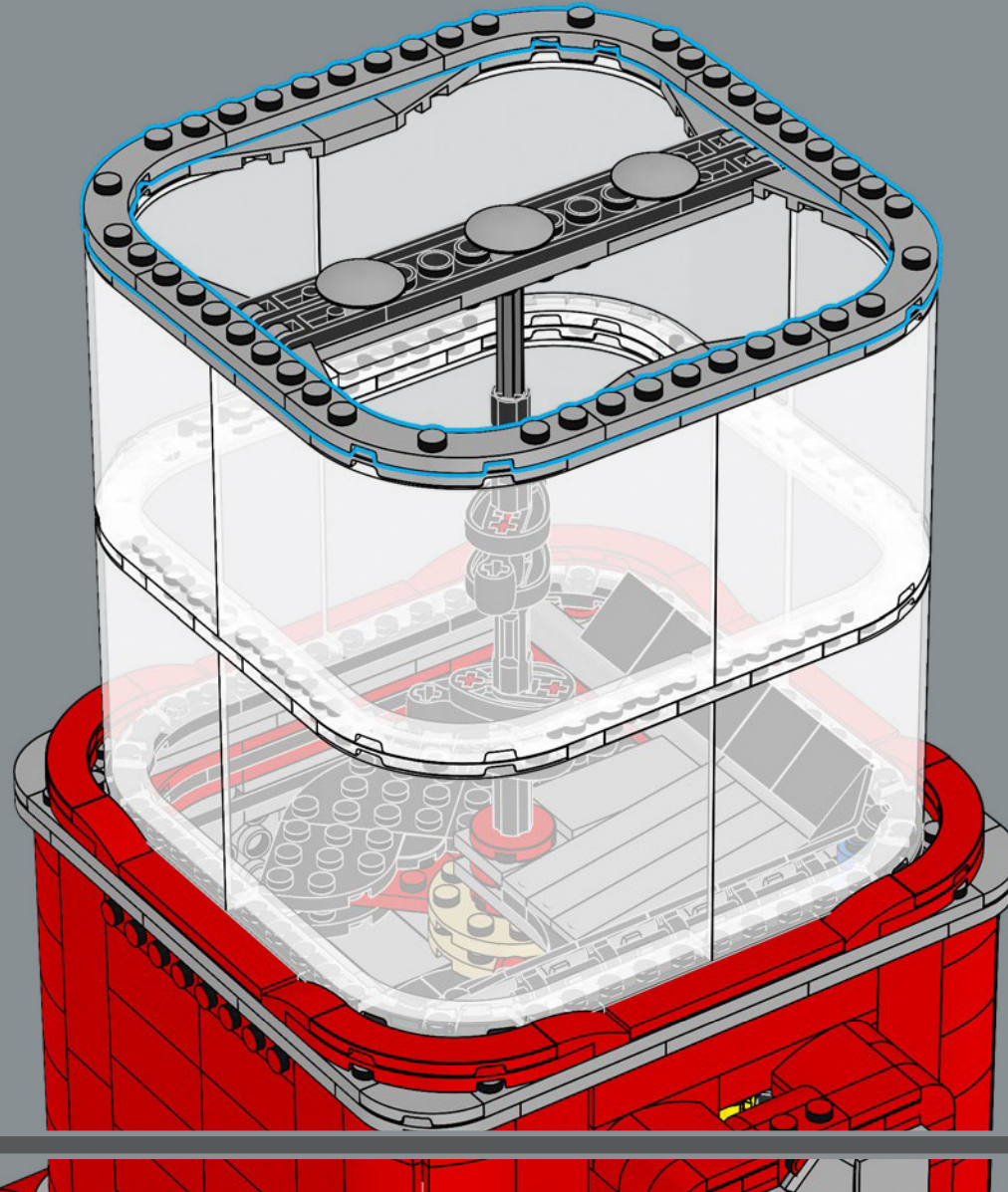

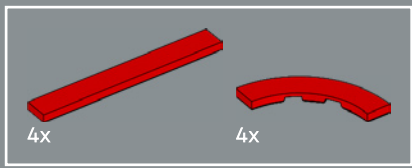

195

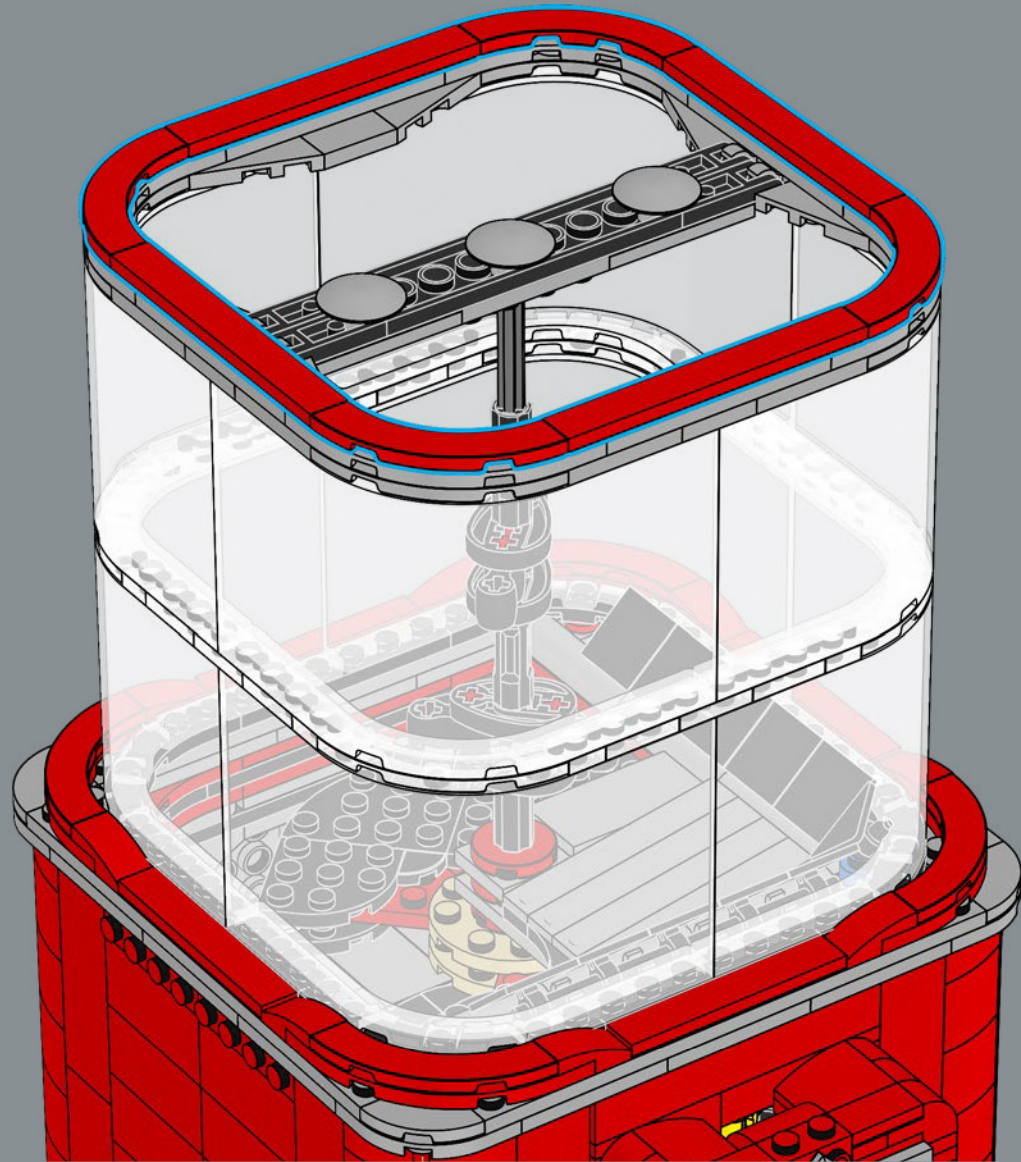

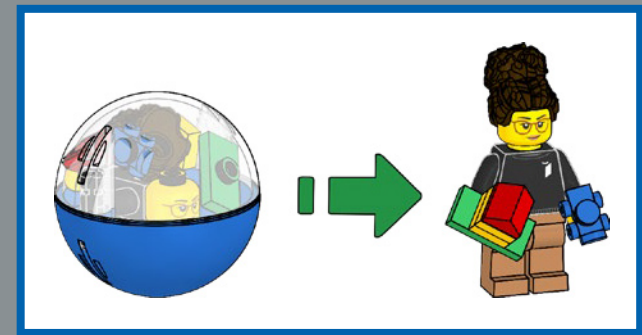
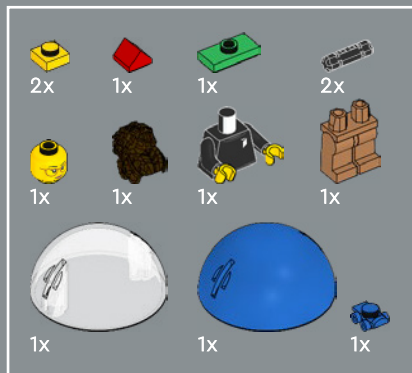

1

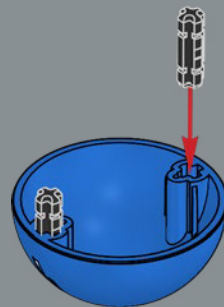

2

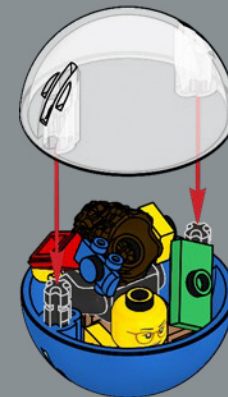

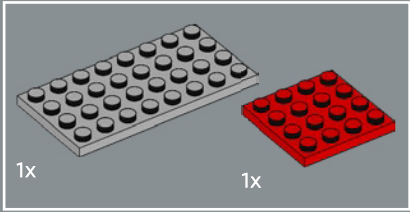
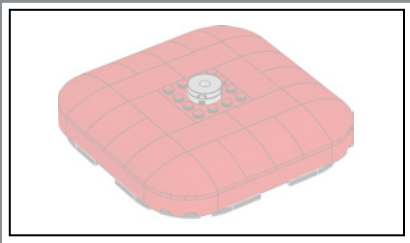

196

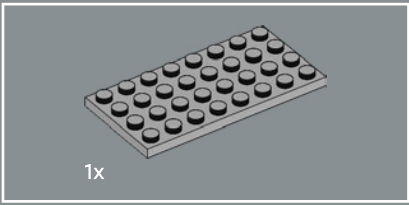
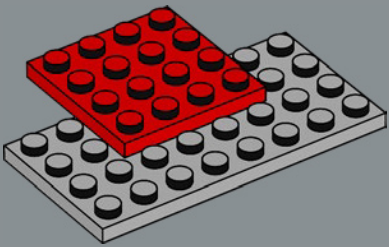

197

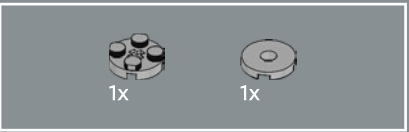
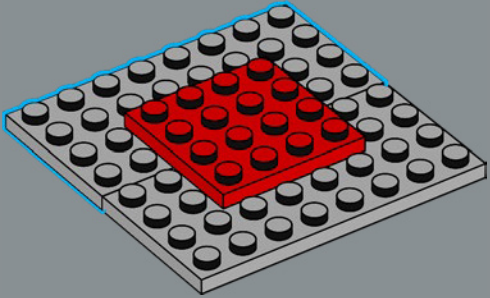

198

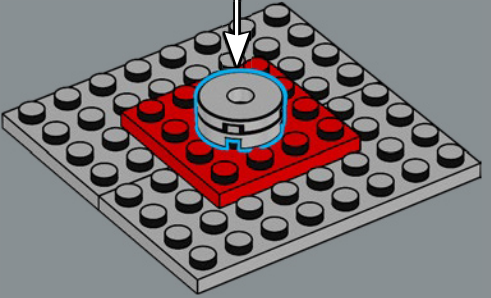
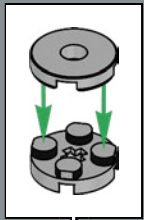

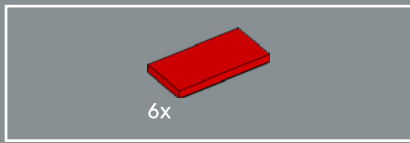

199

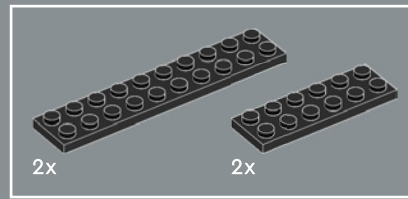
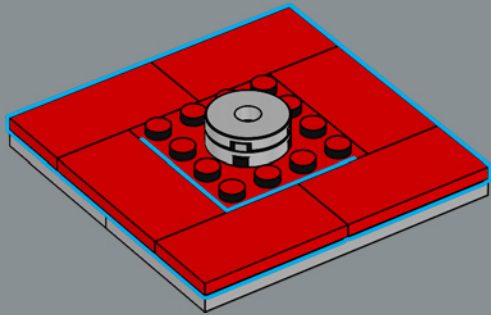

200

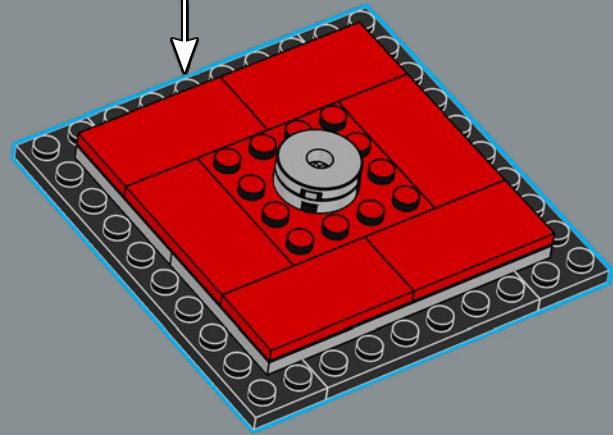
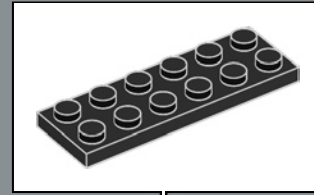

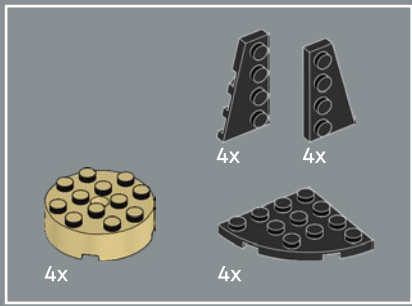

201

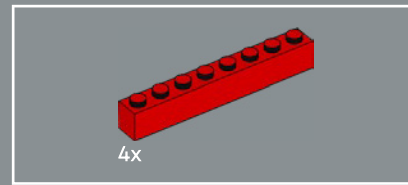
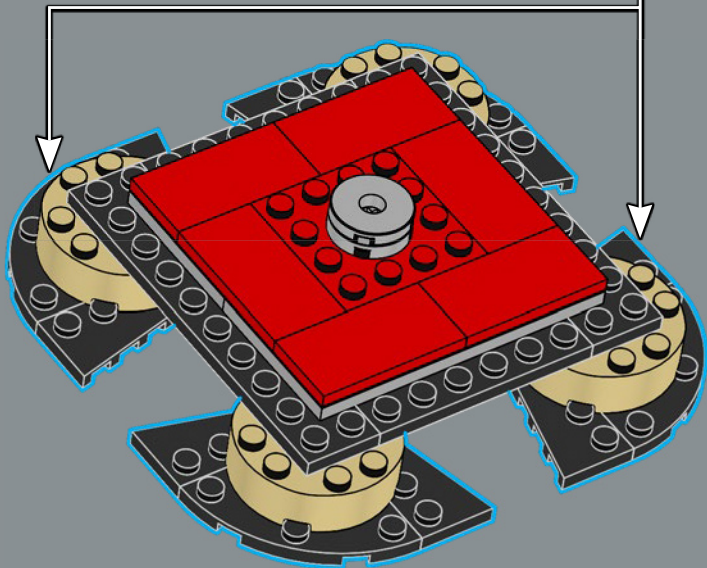
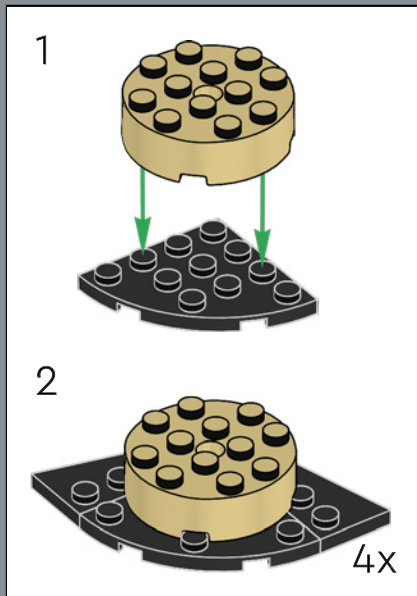

202

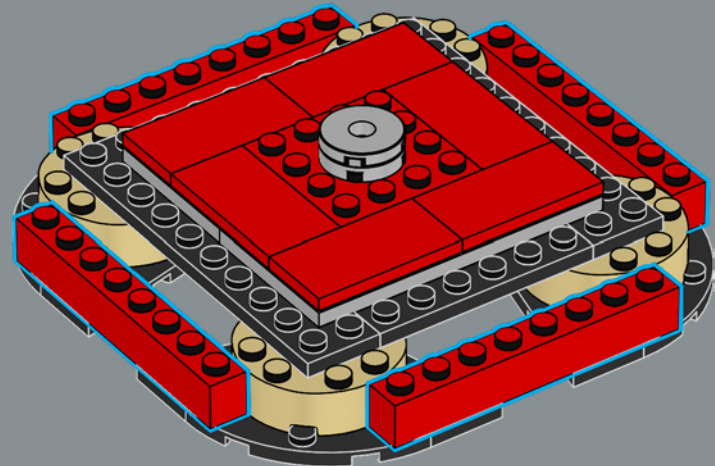

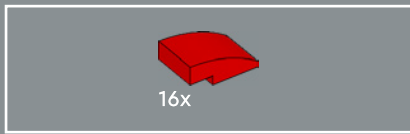

203

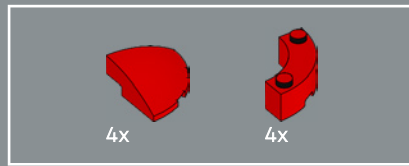
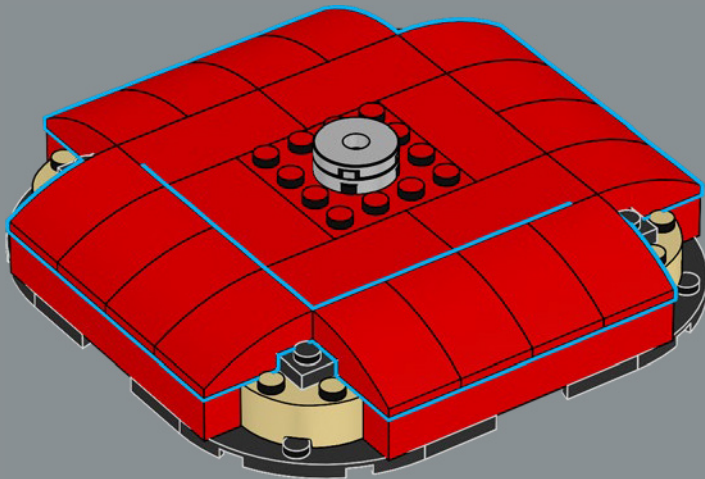

204

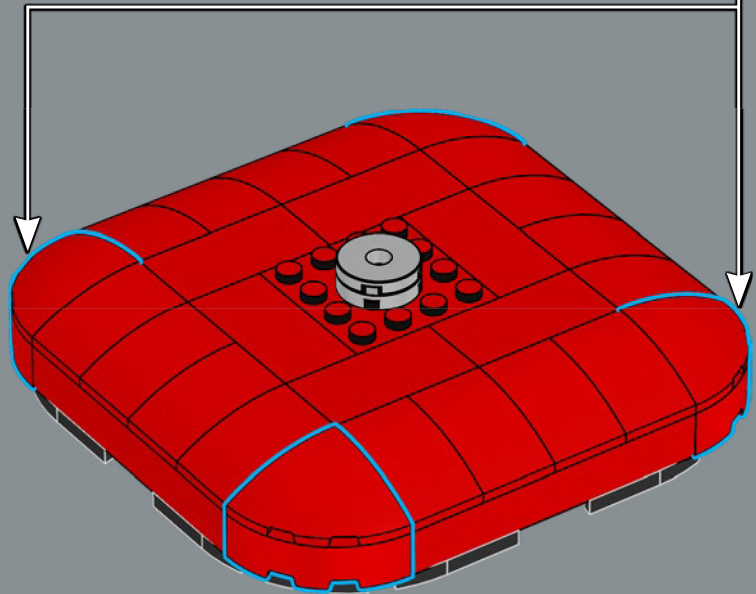
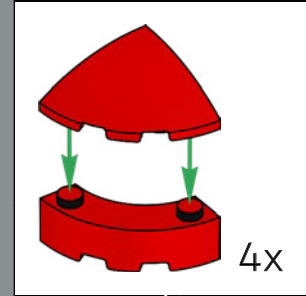

205

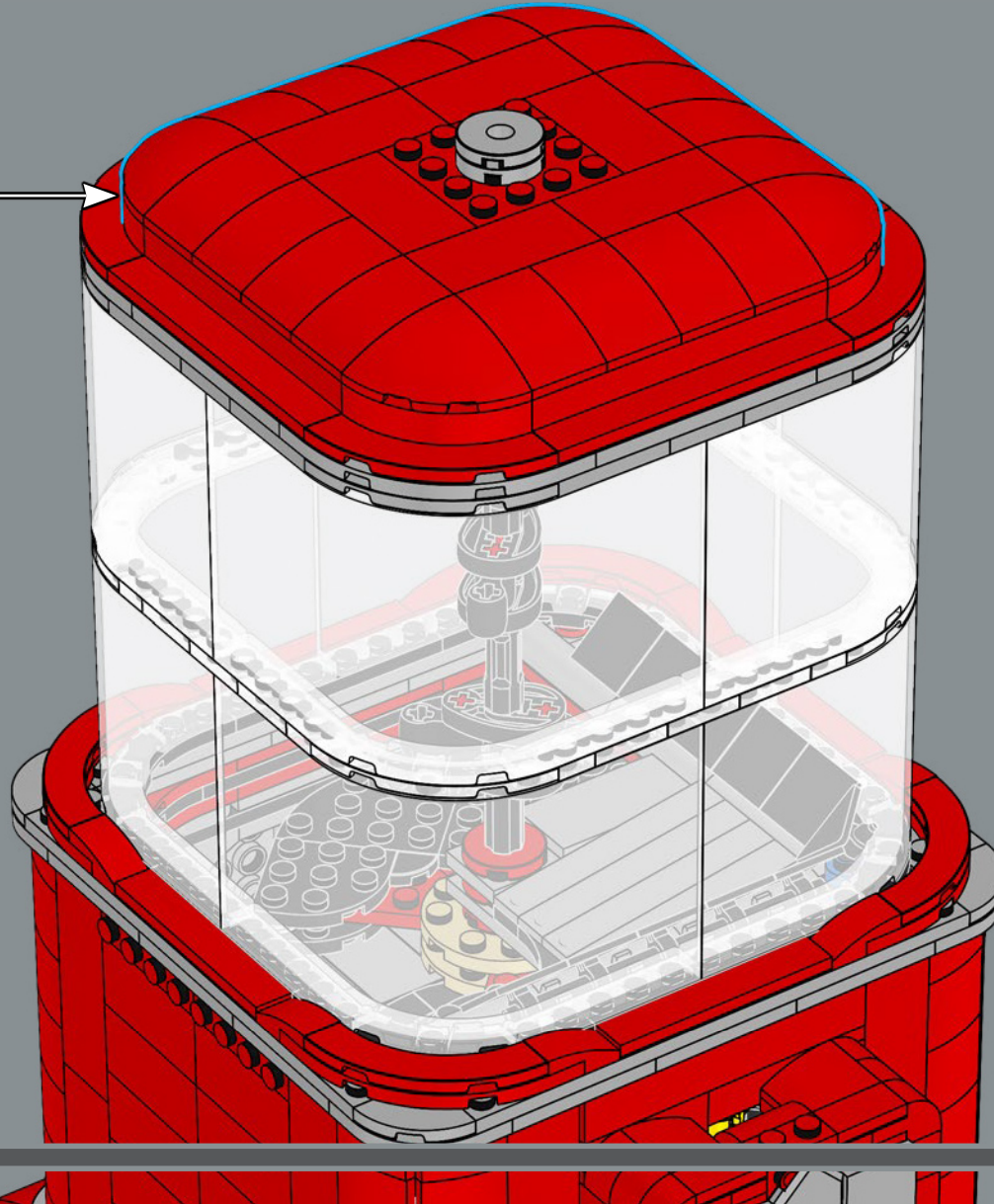



206

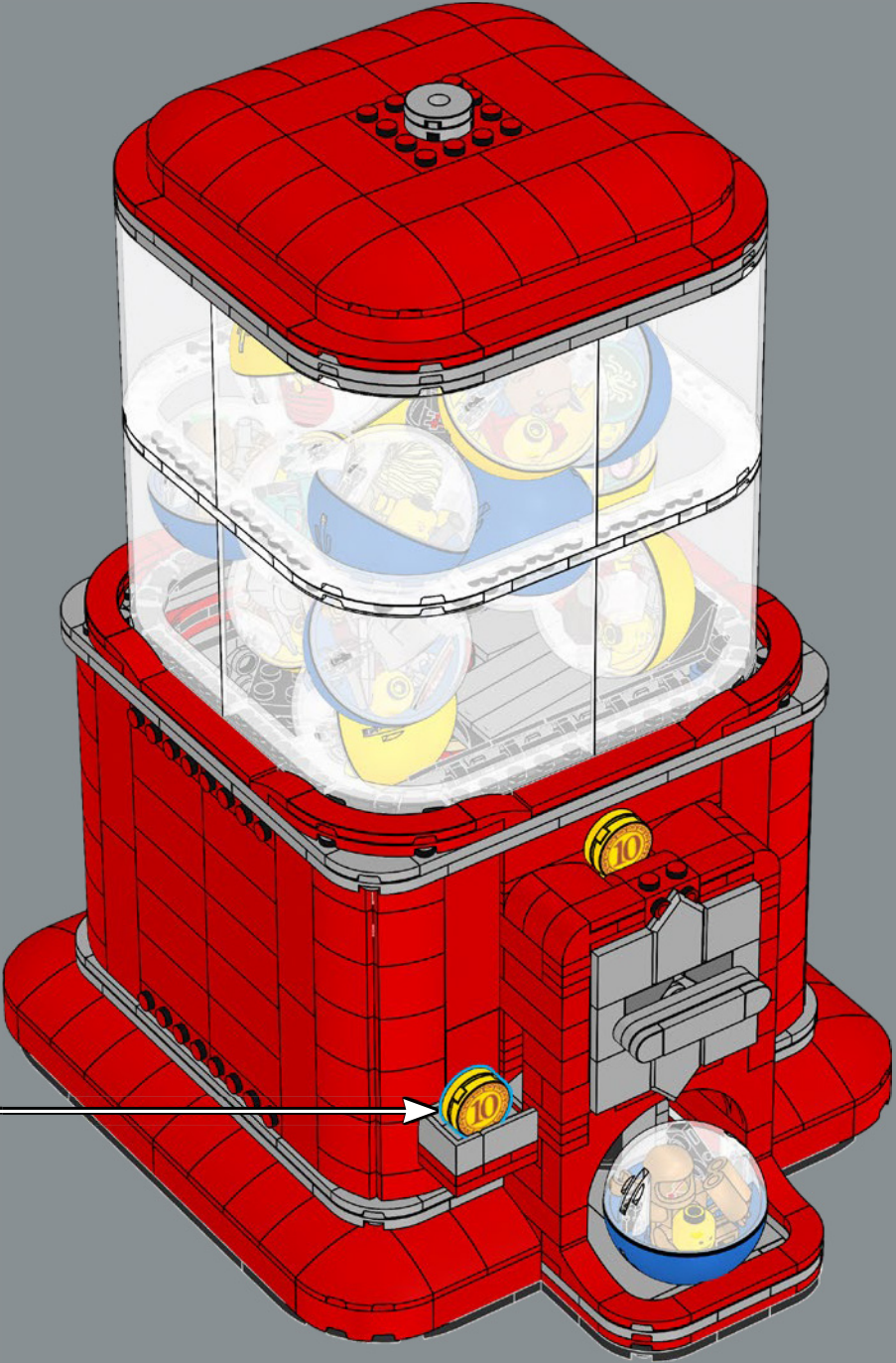
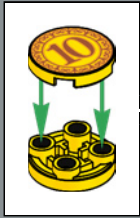

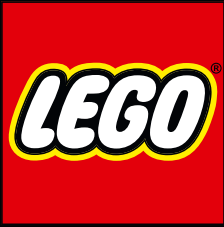

IDEAS

GATHER SUPPORT
OBTENEZ DE L'APPUI
OBTÉN APOYOS

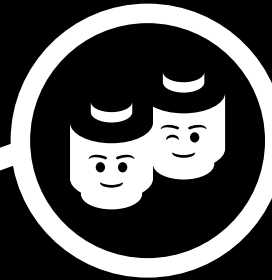

SHARE YOUR IDEA
PARTAGEZ VOTRE IDÉE
COMPARTE TU IDEA

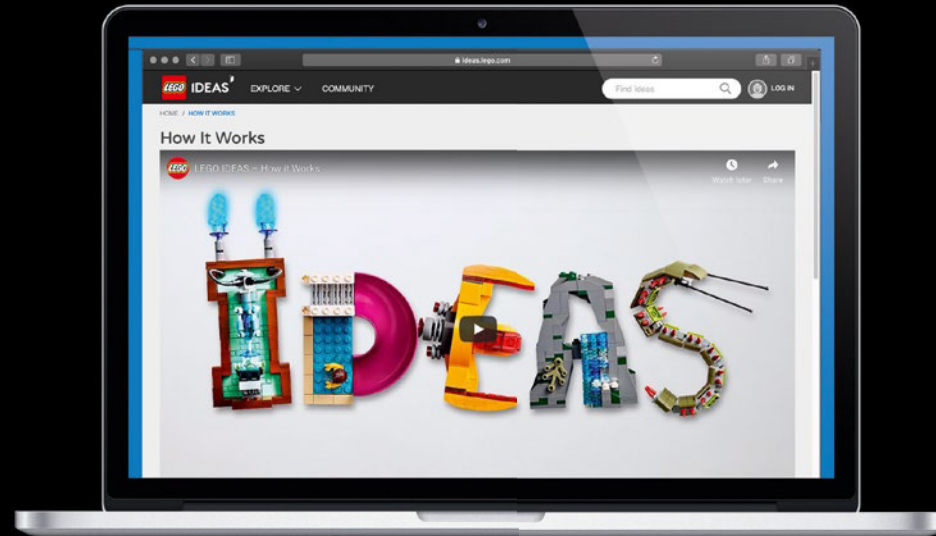
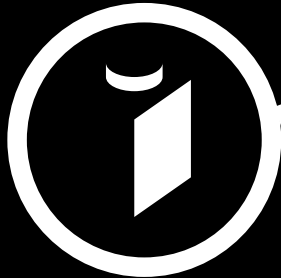

NEW LEGO® PRODUCT
NOUVEAU PRODUIT LEGO®
NUEVO PRODUCTO LEGO®

LEGO® REVIEW
EXAMEN LEGO®
REVISIÓN DE LEGO®



ideas.LEGO.com

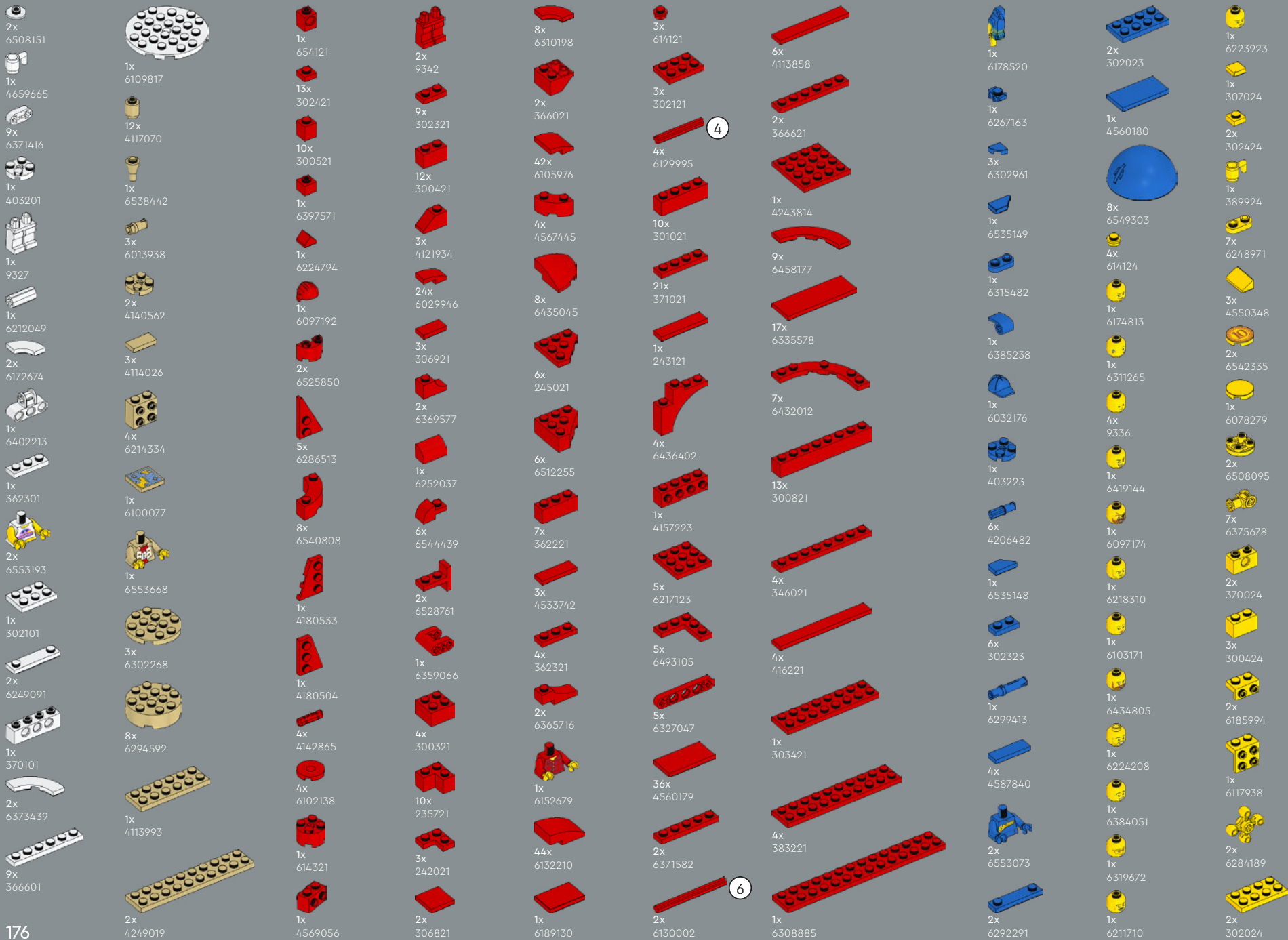

1x
6130008



8x
6549301

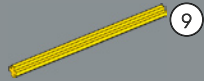

1x
6130010

2x
614126

10x
6332148

1x
4290713

1x
6170545

2x
6172383

2x
6344819

2x
302426

1x
6156414

10x
6323189

6x
6295295

1x
6365482

4x
4160869

4x
4161332

35x
4109810

1x
6491608

1x
6070695

2x
6279875

2x
4644456

6x
4198367

1x
4512363

1x
306926

1x
6308912

8x
6138173

4x
4143187

2x
6350725

5x
302226

4x
4567436

1x
6089119

8x
4515368

1x
6510117

3x
6286381

4x
4159550

1x
362226

1x
6553089

2x
400626

6x
4227392

5x
6327548

1x
370526

4x
6251544

2x
243126

1x
301026

1x
4515350

1x
6167800

4x
6325190

1x
6439175

1x
6434275

1x
370926

4x
302026

3x
4116854

6x
366626

2x
6508013

4x
4243819

5x
6208787

1x
6458165

10x
6101857

2x
379526

4x
6372045

2x
6409912

4x
303426

1x
373826

1x
395826

4x
6137779

4x
383226

7x
4514845

2x
244526

5x
303326

3x
4107558

1x
6092586

1x
6514191

1x
6454463

1x
6514207

8x
6513962

12x
6514001

16x
6537230

8x
6537237

4x
6544432

1x
6514234

1x
6240515

2x
6549098

2x
6550811

2x
6397830

2x
6553088

2x
6552650

1x
6476482

1x
4595836

2x
6542336

1x
6401395

1x
6267760

2x
6553087

2x
6542343

1x
6553226

7x
6271165

1x
6510218

4x
6250597

4x
6176433

8x
4211389













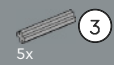





























































































































1x
4211415

8x
6308012

6x
6401023

1x
4595836

12x
6248890

- | | | | | | | | | | |
|--|--|--|--|--|---|--|--|--|--|
| 
4x
4211791 | 
6x
4211398 | 
4x
6337268 | 
5x
4211815 | 
2x
4515351 | 
4x
6458164 | 
2x
4210633 | 
1x
6435030 | 
1x
6529039 | 
1x
6262262 |
| 
4x
4211794 | 
1x
6066097 | 
3x
6217876 | 
1x
6551874 | 
10x
6383110 | 
6x
4211795 | 
2x
6492106 | 
1x
6083620 | 
1x
6519699 | 
1x
6329604 |
| 
1x
6225142 | 
3x
4211414 | 
7x
4211397 | 
1x
6273212 | 
2x
6549304 | 
4x
6318584 | 
4x
4210719 | 
1x
4508553 | 
2x
6531660 | 
2x
6487209 |
| 
4x
4211475 | 
3x
6028813 | 
10x
6163990 | 
2x
6245254 | 
1x
4211444 | 
2x
4211542 | 
2x
6510145 | 
1x
4508553 | 
2x
6531658 | 
2x
6542337 |
| 
3x
4278273 | 
2x
6123809 | 
2x
4211387 | 
11x
4558169 | 
8x
4560183 | 
7x
6430583 | 
2x
6510213 | 
1x
4211002 | 
2x
6531658 | 
2x
6542337 |
| 
2x
6179186 | 
1x
6248492 | 
4x
6310976 | 
6x
6225228 | 
14x
4211395 | 
3x
4211481 | 
2x
6510131 | 
1x
4211002 | 
2x
4512021 | 
2x
6551868 |
| 
2x
6529502 | 
2x
6146223 | 
4x
6310976 | 
2x
6211969 | 
5x
6372029 | 
2x
4211407 | 
2x
6510213 | 
1x
4211002 | 
2x
4512021 | 
2x
6551868 |
| 
1x
6123815 | 
1x
6015344 | 
5x
6102357 | 
6x
4645412 | 
2x
6372029 | 
2x
4211407 | 
8x
6092572 | 
1x
4211002 | 
1x
6306071 | 
2x
6553083 |
| 
2x
4227657 | 
1x
4211388 | 
2x
6212077 | 
4x
6456718 | 
2x
6310881 | 
2x
4211407 | 
4x
6092572 | 
1x
4211002 | 
2x
6552651 | 
2x
6093532 |
| 
2x
6213378 | 
1x
4211440 | 
2x
6326478 | 
6x
6171894 | 
8x
4211438 | 
6x
4211408 | 
4x
6164073 | 
1x
4210997 | 
2x
6552651 | 
2x
6093532 |
| 
4x
4211413 | 
4x
4211413 | 
4x
4211413 | 
3x
4211386 | 
4x
4211549 | 
2x
4514846 | 
4x
6164073 | 
1x
4210997 | 
1x
6552651 | 
2x
6093532 |
| 
5x
6484902 | 
5x
6484902 | 
5x
6484902 | 
5x
6484902 | 
6x
6508016 | 
3x
4211360 | 
4x
6164073 | 
4x
4210997 | 
1x
6552651 | 
2x
6093532 |
| 
6x
6402876 | 
6x
6402876 | 
6x
6402876 | 
6x
6402876 | 
6x
6508016 | 
3x
4211360 | 
4x
6164073 | 
1x
4210997 | 
1x
6552651 | 
2x
6093532 |
| 
4x
4211356 | 
4x
4211356 | 
4x
4211356 | 
1x
4243797 | 
1x
4243797 | 
10x
44662161 | 
4x
6164073 | 
1x
4210997 | 
1x
6552651 | 
2x
6093532 |



[LEGO.com/service](https://www.LEGO.com/service)



YOU COULD
WIN



**YOU COULD
WIN**

Your feedback will help shape the future development of this product series.

Visit:

**DU KÖNNTEST
GEWINNEN**

Dein Feedback trägt zur Weiterentwicklung dieser Produktreihe bei.

Geh auf:

**VOUS POURRIEZ
GAGNER**

Vos commentaires nous aideront à concevoir les futurs produits de cette gamme.

Visitez :

**POTRESTI
VINCERE TU**

La tua opinione ci aiuterà a migliorare la creazione futura di questa linea di prodotti.

Visita:

**PUEDES
GANAR**

Tu opinión contribuirá al futuro de esta serie de productos.

Visita:

轻松获奖

您的反馈将有助于我们在今后改进本产品系列。

请访问:

LEGO.com/productfeedback

You also have the chance to win a LEGO® set.

Terms and conditions apply.*

Außerdem hast du die Chance, ein LEGO® Set zu gewinnen.

Es gelten die Teilnahmebedingungen.*

Vous pourriez également gagner un ensemble LEGO®.

Des conditions s'appliquent.*

Hai anche la possibilità di vincere un set LEGO®.

Termini e condizioni sono applicabili.*

También tienes la oportunidad de ganar un set LEGO®.

Aplican términos y condiciones.*

您还有机会赢取乐高®套装。

条款和条件适用。*

*LEGO.com/productfeedback-terms



LEGO and the LEGO logo are trademarks of the/son des marques de commerce du/
son marcas registradas de LEGO Group. ©2025 The LEGO Group.