



# MINECRAFT

21592



LEGO® Builder





### **Get excited about our new packaging!**

We're switching from plastic to paper-based packaging. That's why you might find a mix of paper and plastic in our boxes!

### **Nos nouveaux emballages vous emballeront !**

Nous passons des emballages en plastique aux emballages à base de papier. C'est pourquoi vous pourriez trouver un mélange de papier et de plastique dans nos boîtes !

### **¡Te presentamos nuestros nuevos empaques!**

Estamos sustituyendo las bolsas de plástico por bolsas con base de papel. ¡Por eso, puedes encontrar una mezcla de papel y de plástico en nuestras cajas!

**[LEGO.com/sustainable-packaging](https://www.lego.com/sustainable-packaging)**



LEGO® Builder

# BUILDER



Apple and the Apple logo are trademarks of Apple Inc., registered in the U.S. and other countries and regions. App Store is a service mark of Apple Inc. Google Play and the Google Play logo are trademarks of Google LLC. Tencent and the Tencent logo are trademarks of Tencent Inc.

**LEGO.com/devicecheck**

**EN** Ask parents' permission before going online | **DE** Eltern um Erlaubnis bitten, bevor du online gehst | **FR** Demande l'autorisation d'un parent avant d'aller en ligne | **IT** Chiedi il permesso ai tuoi genitori prima di andare online | **ES** Pídeles permiso a tus papás antes de conectarte a Internet | **PT** Pede autorização aos teus pais antes de ficares online | **ZH** 上网前应先征得父母的同意 | **PL** Poproś rodziców o zgodę, zanim wejdiesz do Internetu | **CS** Než půjdeš na internet, požádej rodiče o svolení | **SK** Skôr než pôjdeš na internet, vypýtaj si povolenie od rodičov | **HU** Kérj szülői engedélyt, mielőtt online csatlakoznál! | **UA** Запитуйте дозволу батьків, перш ніж користуватися інтернетом | **RO** Cere permisiunea părinților înainte de a te conecta online | **BG** Поискайте разрешение от родител, преди да влезете онлайн | **LV** Pirms došanās tiešsaistē palūdz atļauju vecākiem | **ET** Enne Interneti kasutamist küsi vanematelt luba | **LT** Prieš prisijungdami prie interneto, atsiklauskite tėvų | **TR** İnternete girmeden önce anne babandan izin iste





1x



1x

1

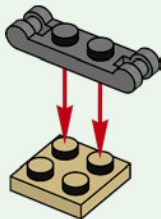

1x

2

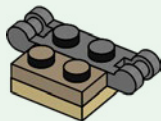



1x



2x

# 3

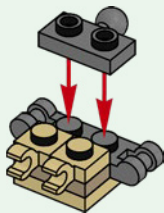



1x

4

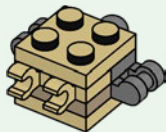

1x

5

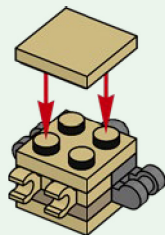



2x



1x



1x

6

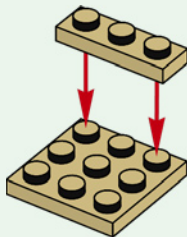

7

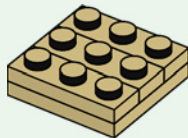

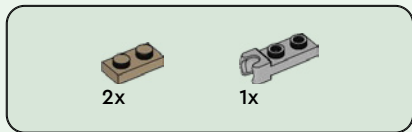

8

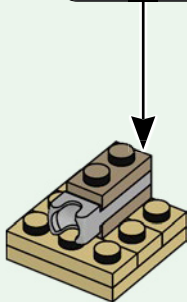
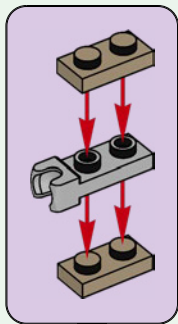



2x



2x

9

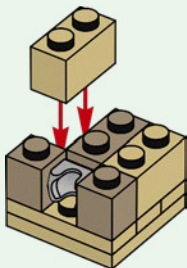

1x



1x

10

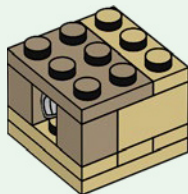

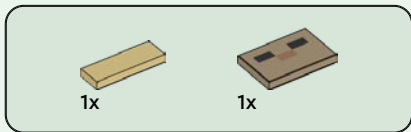

11

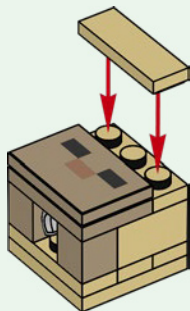

12

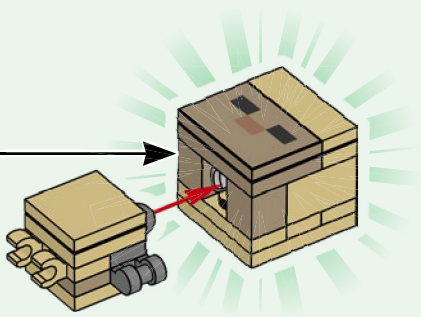



4x



2x

# 13

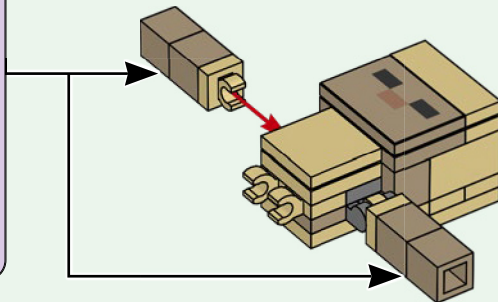
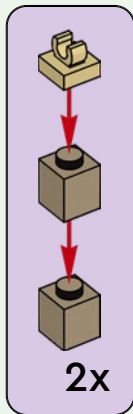



2x



1x



1x

14

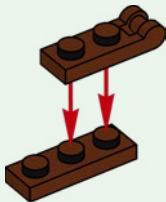

1x

15

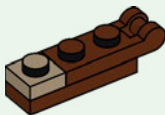

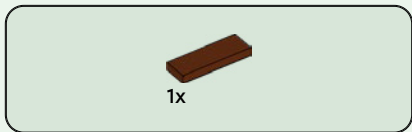

16



2x

17

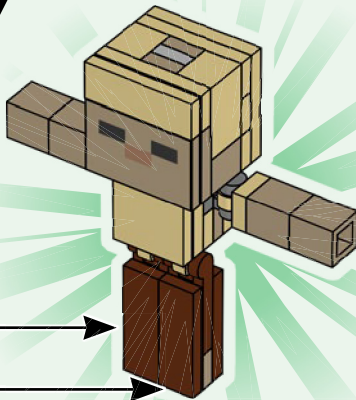



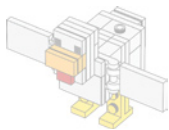

1x



1x

1

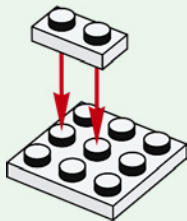

2x

2

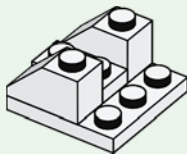



1x



1x

3

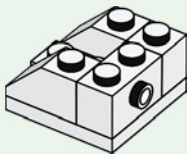

2x

4

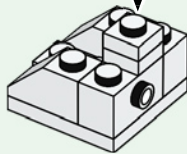
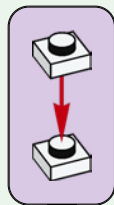



2x

5

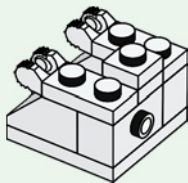

2x

6

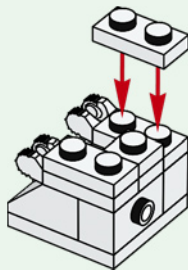

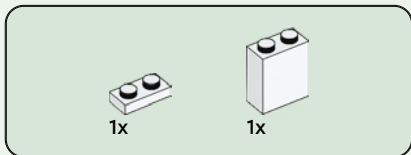

7

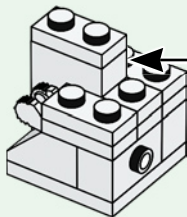
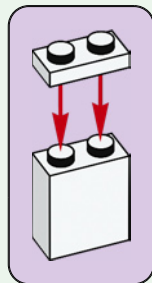



1x



1x

8

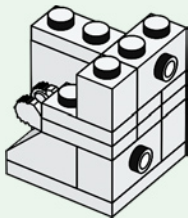

2x

9

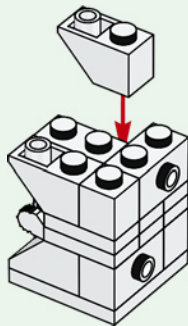



2x

10

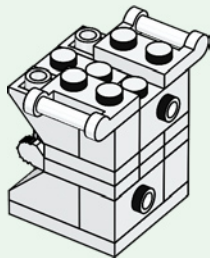

2x



1x

11

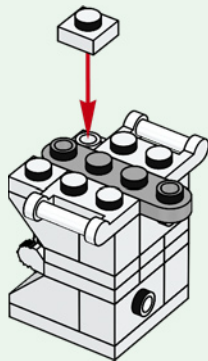



1x



1x

# 12

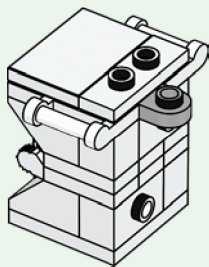



2x

13

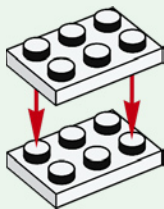

1x

14

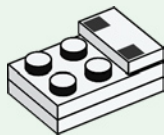



1x



2x

15

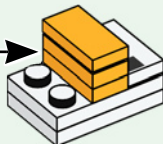
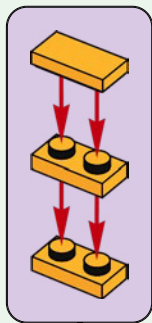



1x



1x

# 16

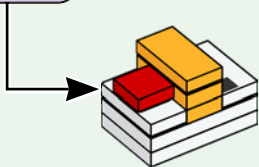
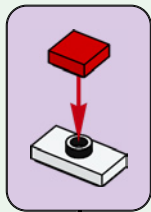

2x

# 17

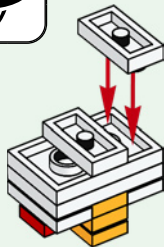

18

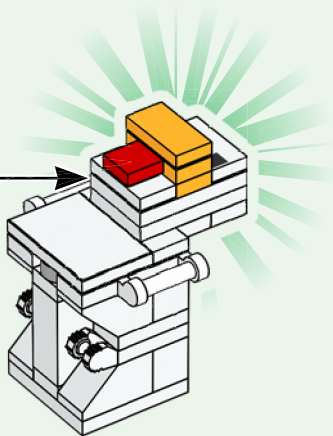

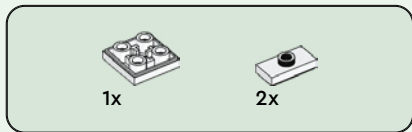

19

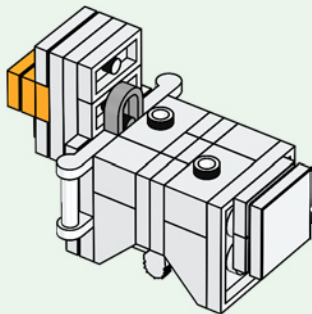
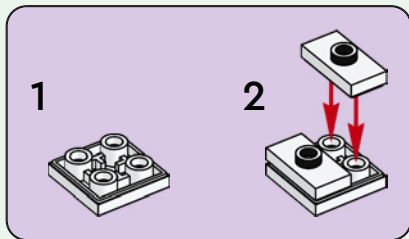

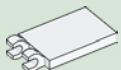

2x

20

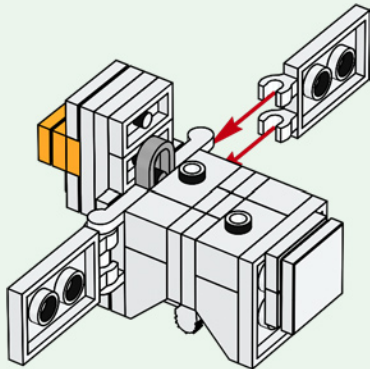



2x



2x

# 21

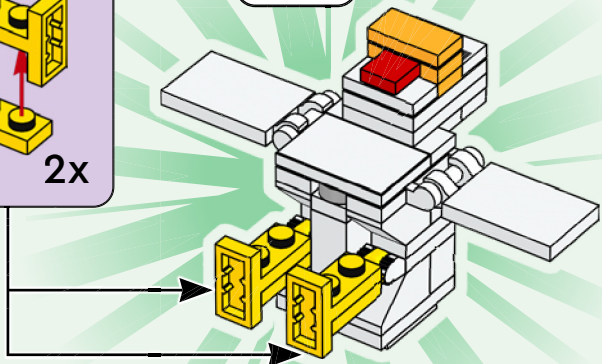
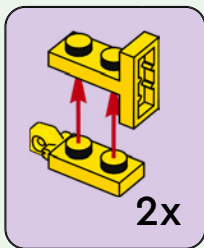
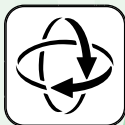

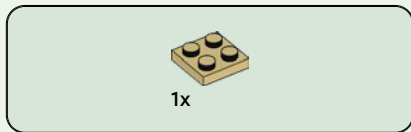
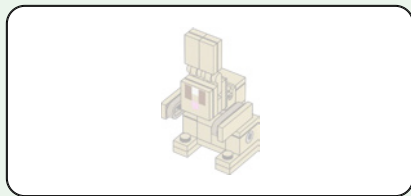

1





2x



2x

2

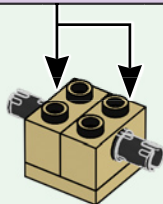
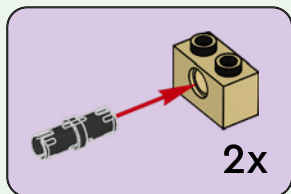

1x

3

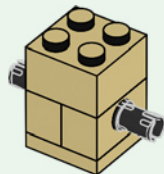



1x



1x

4

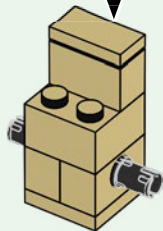
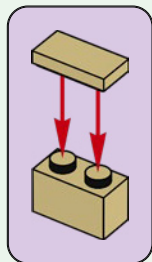

2x

5

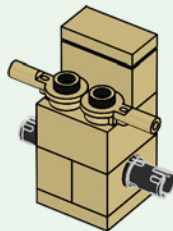



1x



1x

6

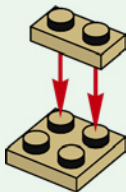

2x

7

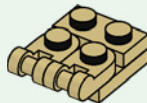



1x



1x

8

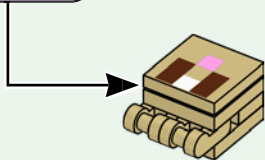
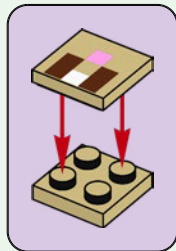

1x



1x

9

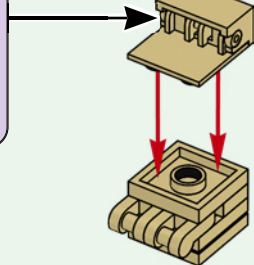
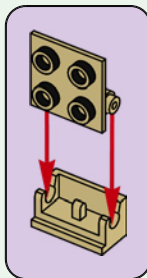
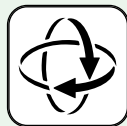

10

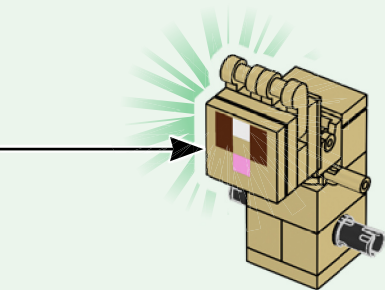

11

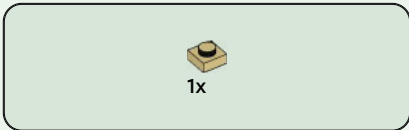
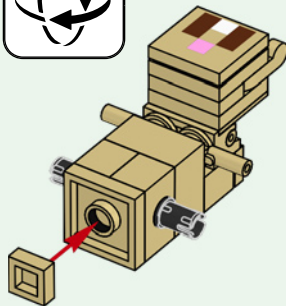

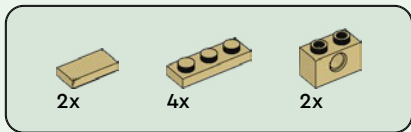

# 12

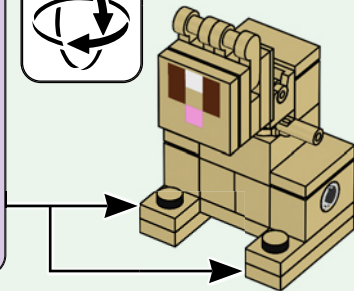
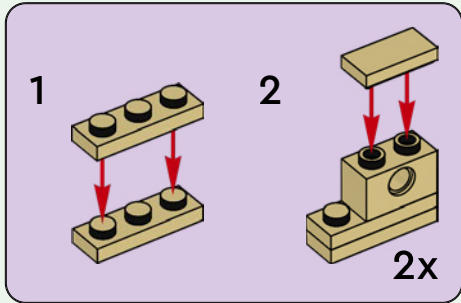

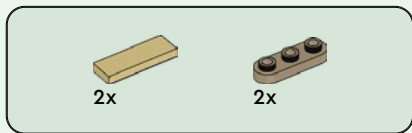

13

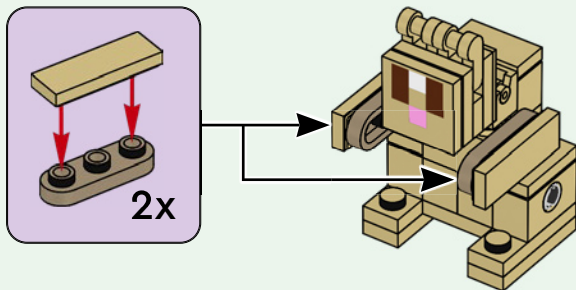



2x



2x

14

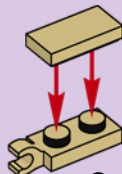
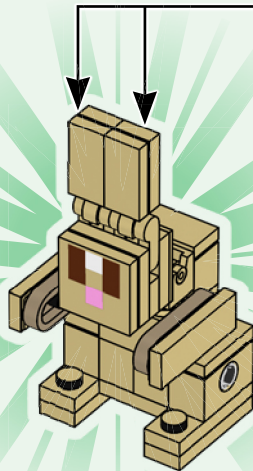

2x

