

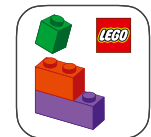

21066



Available in English
In deutscher Sprache verfügbar
Disponibles en français
Disponibile in italiano
Disponible en español
提供中文版本



LEGO® Builder

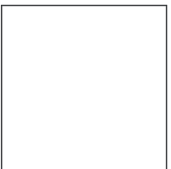



LEGO.com/sustainable-packaging



FR
**DONNEZ
OU
RECYCLEZ**



ASSOCIATION

OU



MAGASIN

OU



DÉCHÈTERIE

Adresses sur quefairedemesdechets.fr



BUILDER



Apple and the Apple logo are trademarks of Apple Inc., registered in the U.S. and other countries and regions. App Store is a service mark of Apple Inc. Google Play and the Google Play logo are trademarks of Google LLC. Tencent and the Tencent logo are trademarks of Tencent Inc.

LEGO.com/devicecheck

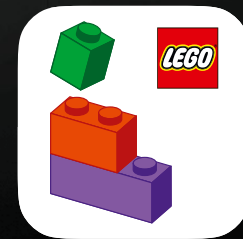

LEGO® Builder



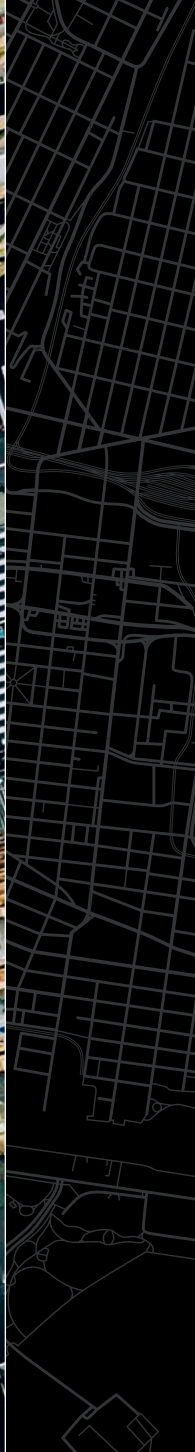



THE BIG APPLE

New York, New York – the city that never sleeps, city of dreams, the Big Apple – the city known by many names as a place of boundless energy and opportunity. Founded in 1624 as 'New Amsterdam', it has evolved into a vibrant beacon of culture, trade, art and innovation. New York City's iconic skyline features instantly recognisable landmarks spread across its five boroughs. From the Statue of Liberty welcoming newcomers to the lively streets that inspire us to chase our dreams, the city's unique pulse captures the hearts of both visitors and residents. The borough of Manhattan alone is home to over 1.5 million people packed into just 23 square miles (59 sq. km), making it one of the most densely populated places on Earth. Whether you're drawn to its bright lights and buzz, or the peaceful paths of Central Park, the city's spirit, rich history and diversity is guaranteed to leave a lasting impression.

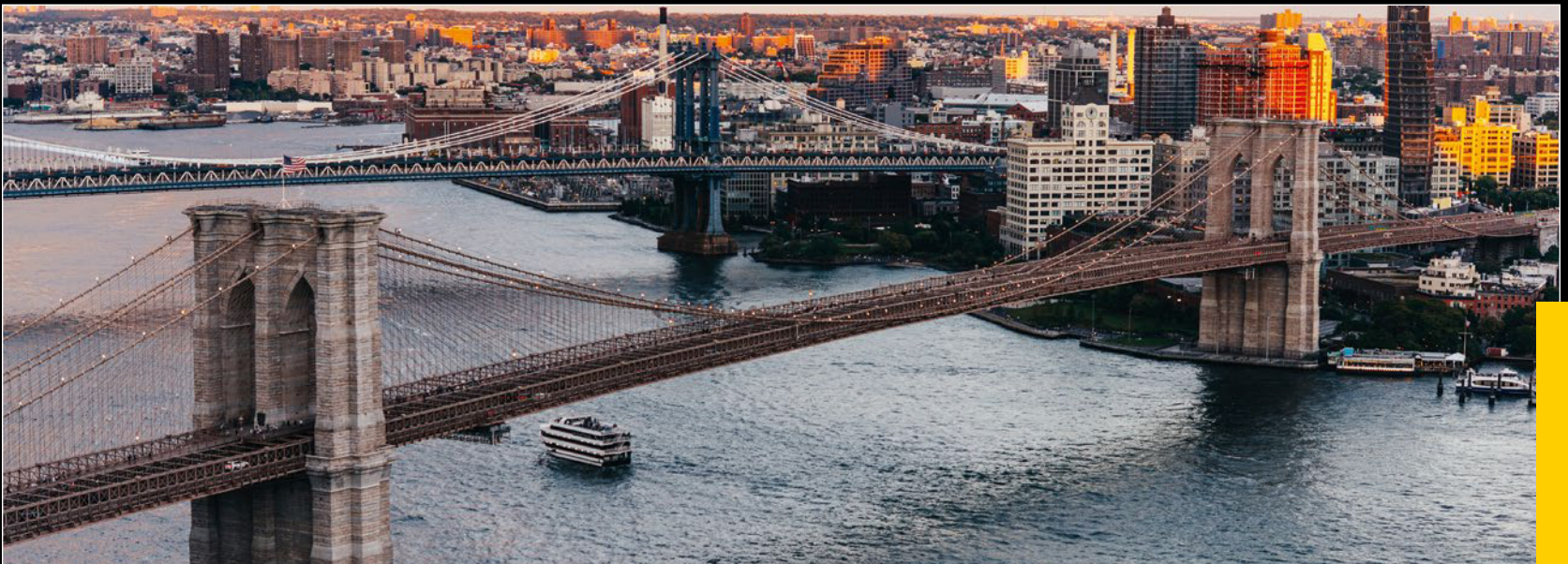



ONE WORLD TRADE CENTER (2014)

To date, One World Trade Center is the tallest building in the Western Hemisphere, built as a symbol of unity and resilience.



EMPIRE STATE BUILDING (1931)

The 102-storey New York icon offers stunning views of the city from the heart of Midtown Manhattan.



METROPOLITAN MUSEUM OF ART (1870)

Founded in 1870, The Met is one of the world's largest museums, showcasing more than 5,000 years of art history and modern masterpieces.



SOLOMON R. GUGGENHEIM MUSEUM (1959)

Since it opened, the museum has been recognised for its spiral architecture and world-class collection of modern and contemporary art.

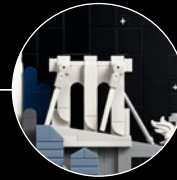
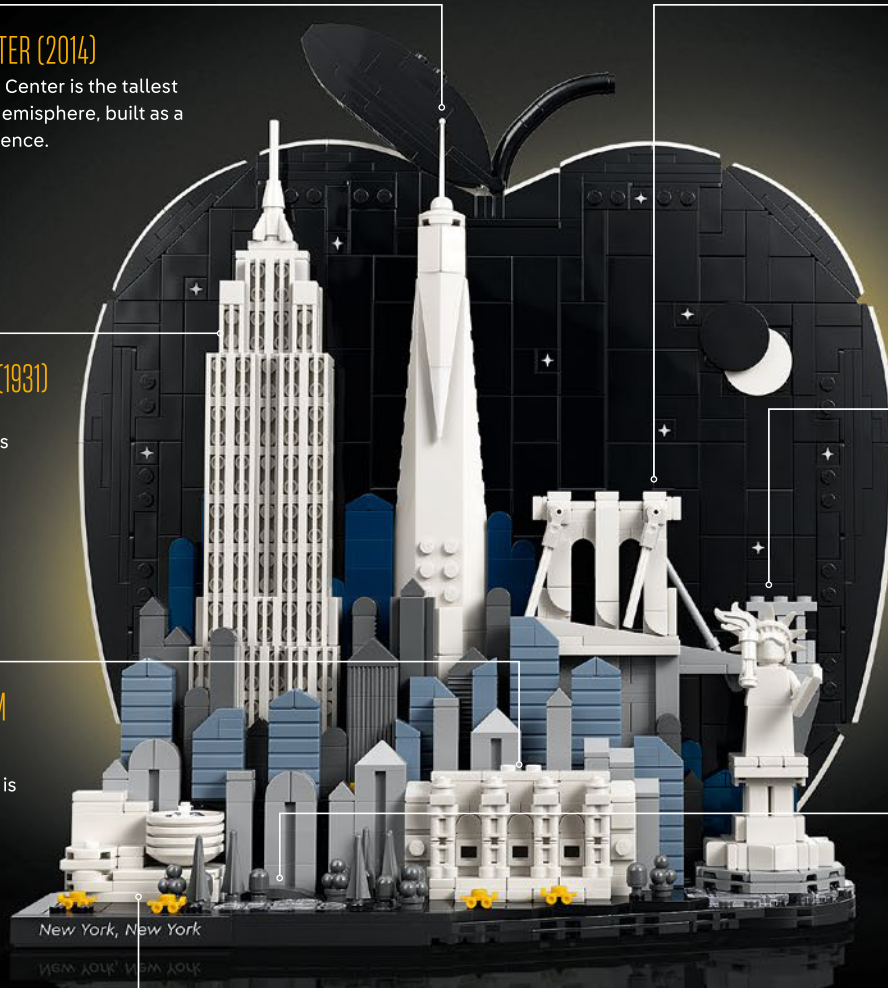

BROOKLYN BRIDGE (1883)

Spanning more than a mile, Brooklyn Bridge was the longest suspension bridge in the world when it opened.

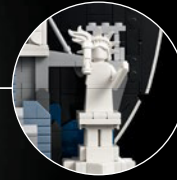

STATUE OF LIBERTY (1886)

The grand neoclassical statue stands on Liberty Island in New York Harbour, originally the most famed port of entry to the U.S.



CENTRAL PARK (1858)

Central Park welcomes 42 million visitors a year to its 341.1 ha (843 ac.) of meadows, trails and lakes.



FROM THE LEGO® ARCHITECTURE DESIGN TEAM

2026 marks the 250th anniversary of the signing of the United States Declaration of Independence AND the 10th anniversary of our first LEGO® Architecture New York City Skyline set! That inspired us to celebrate both occasions, with famous New York landmarks reinterpreted against a 'Big Apple' backdrop depicting a night sky. We used faceted elements to replicate the intricate geometry of One World Trade Center as it rests on the 'shoulders' of the Empire State Building and tapers as it rises. LEGO grille plates make up the windows and long upwards Art Deco lines on the Empire State Building. The build of the Brooklyn Bridge plays with a forced perspective effect, by drastically changing the size, adding colour variations in both towers and adding a slight angle to the road. With other iconic details, like 'Lady Liberty' as a minifigure, we hope you have fun building and exploring this magnificent city!



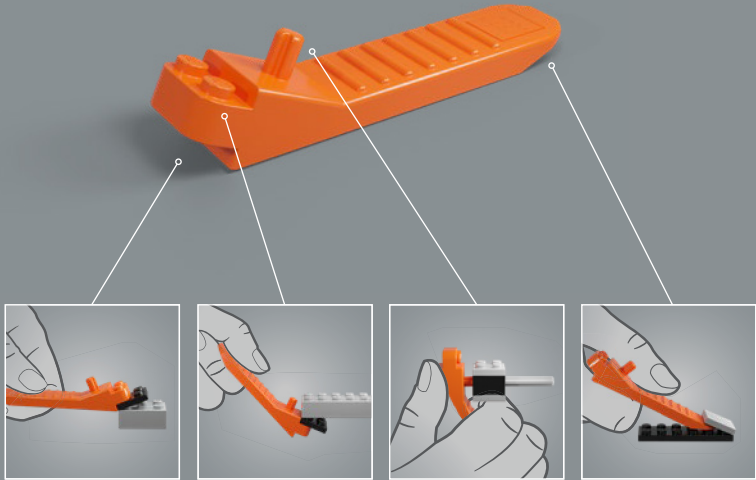

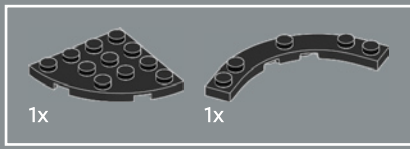

1

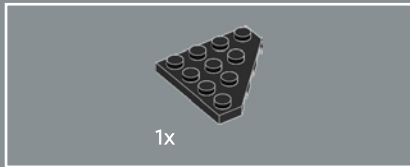
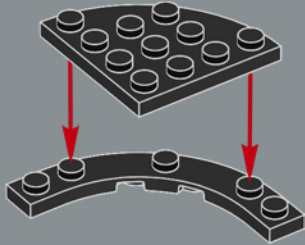

2

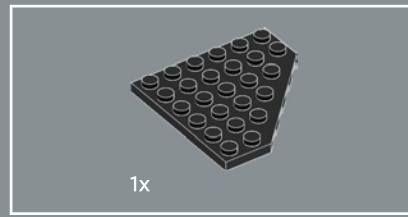
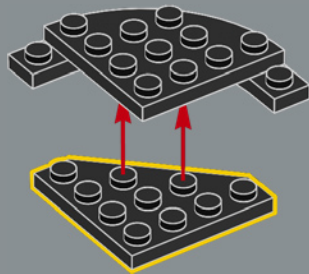

3

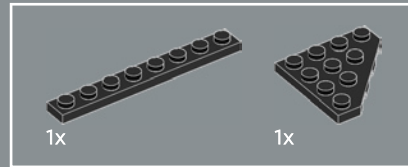
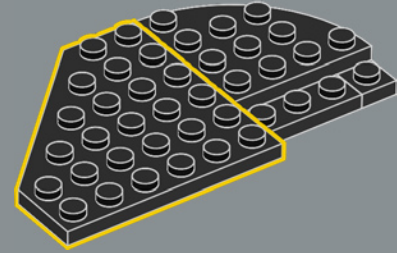

4

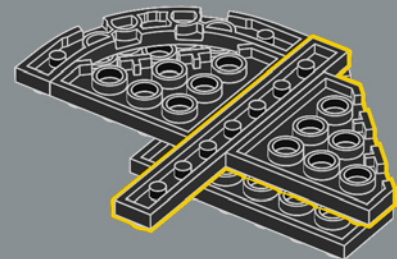

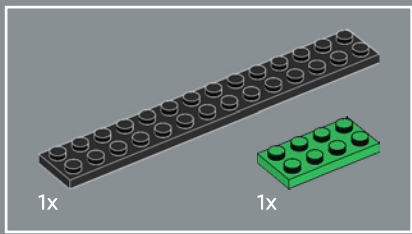

5

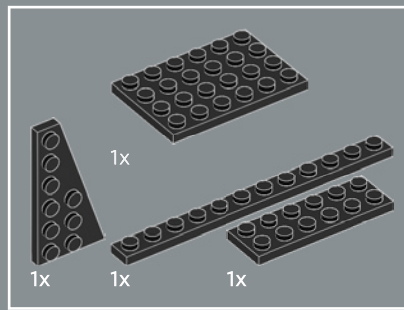
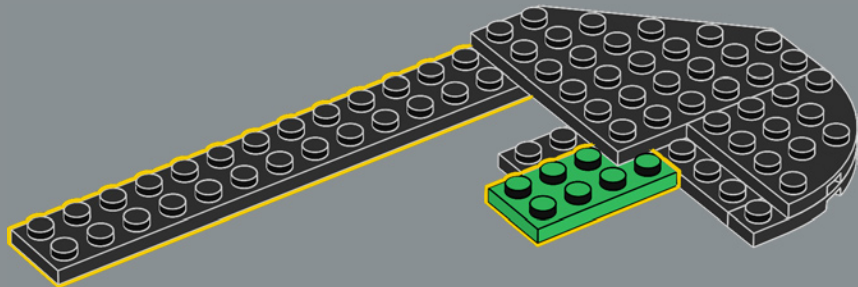

6

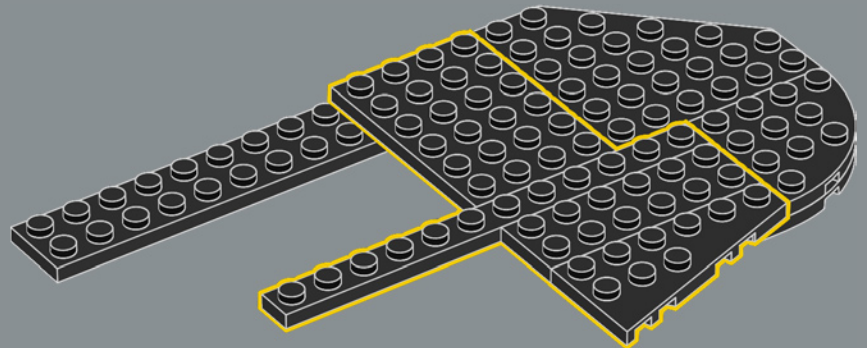

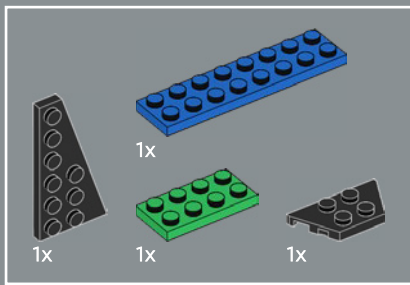

7

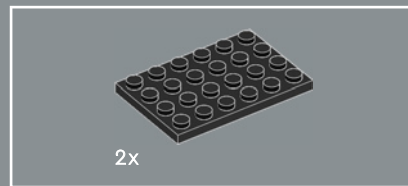
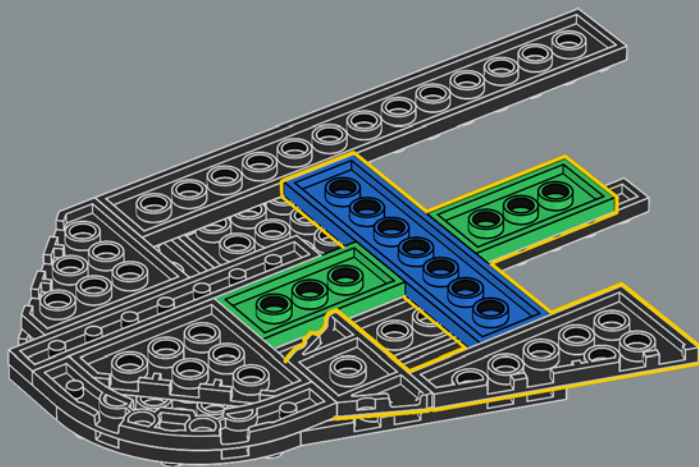

8

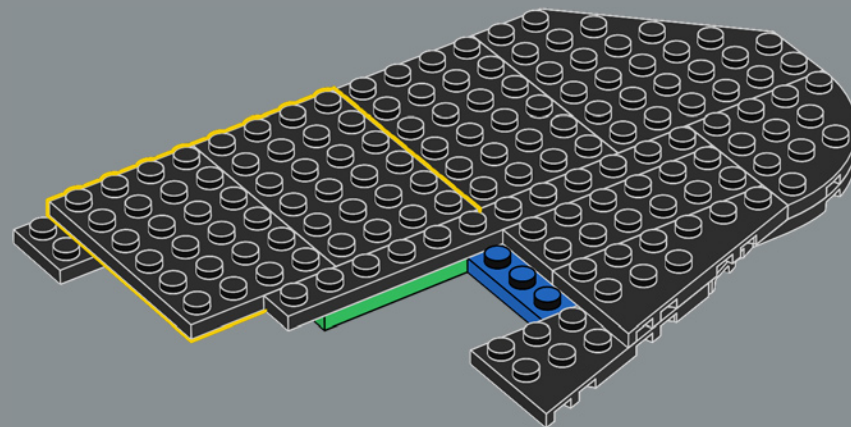

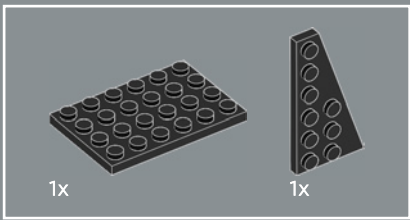

9

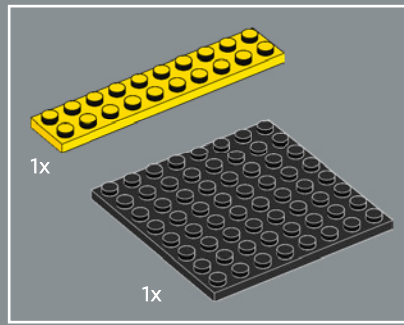
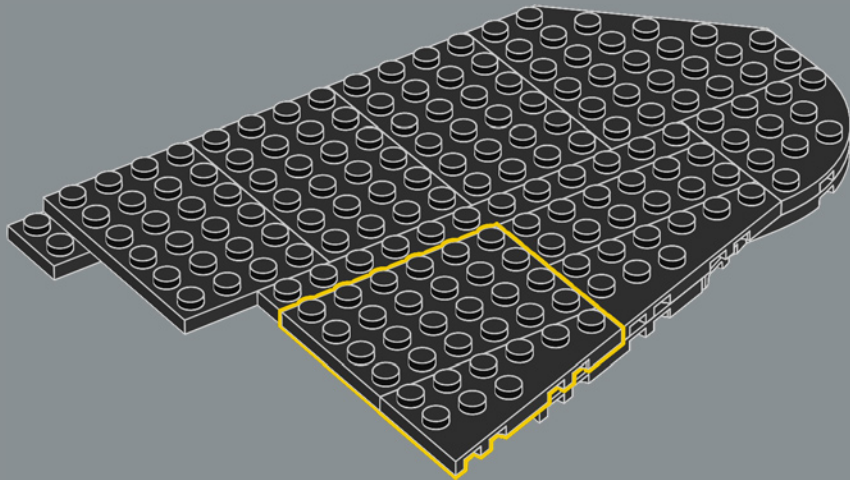

10

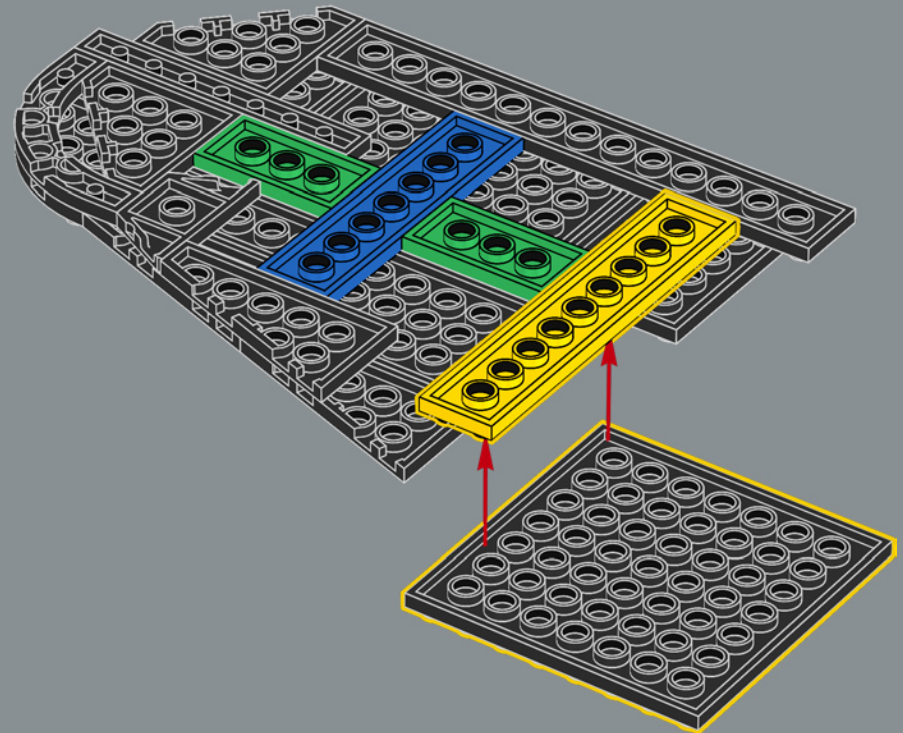

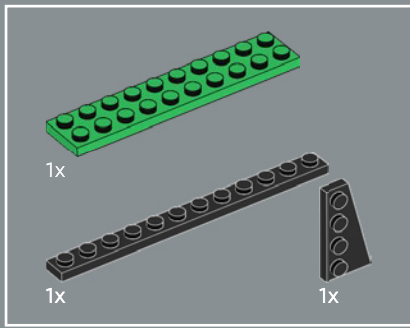

11

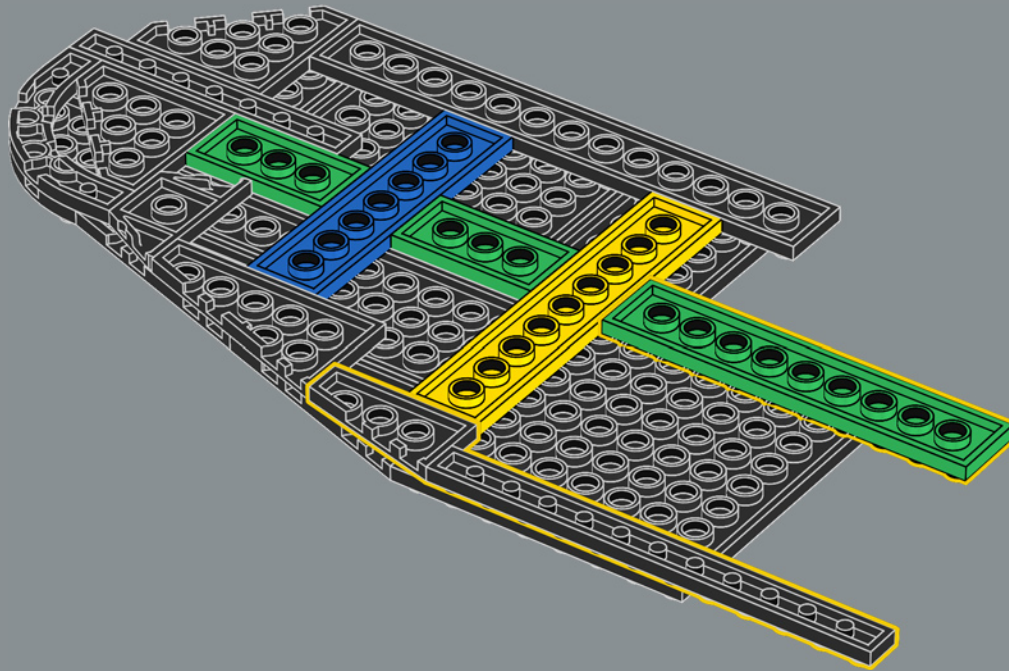

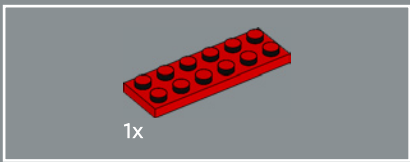

12

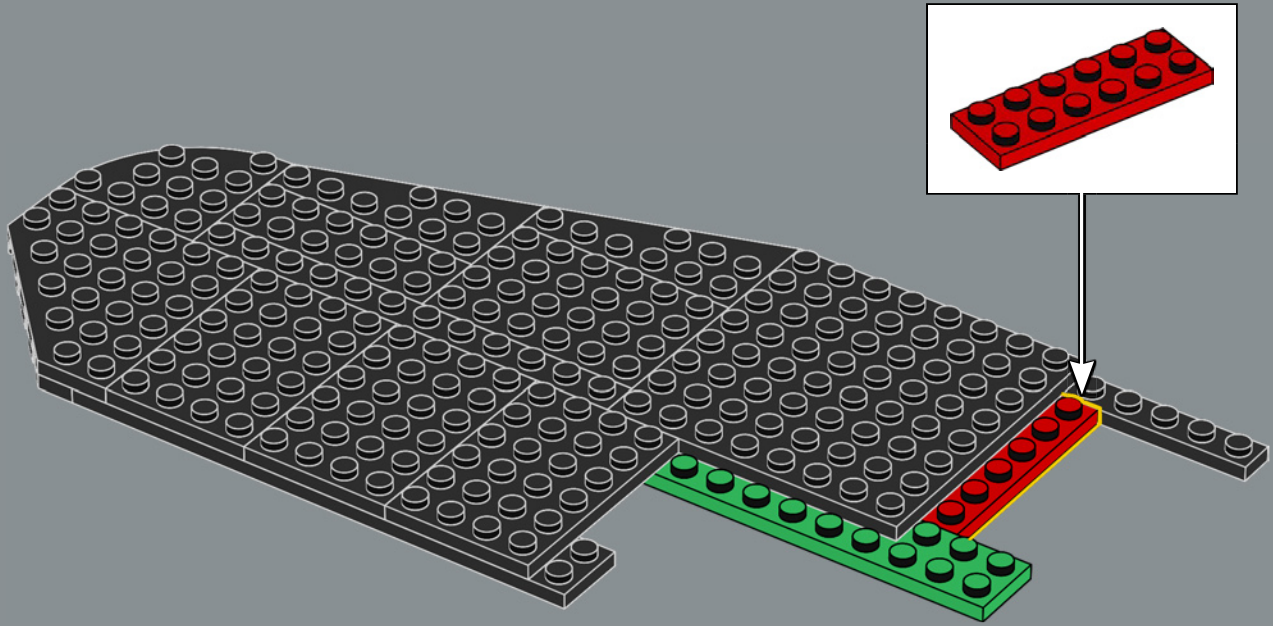

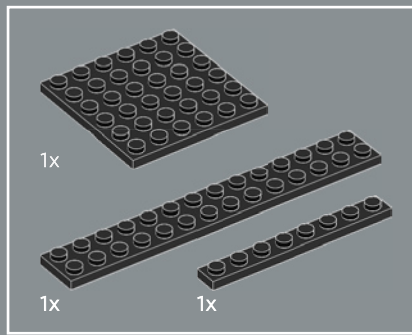

13

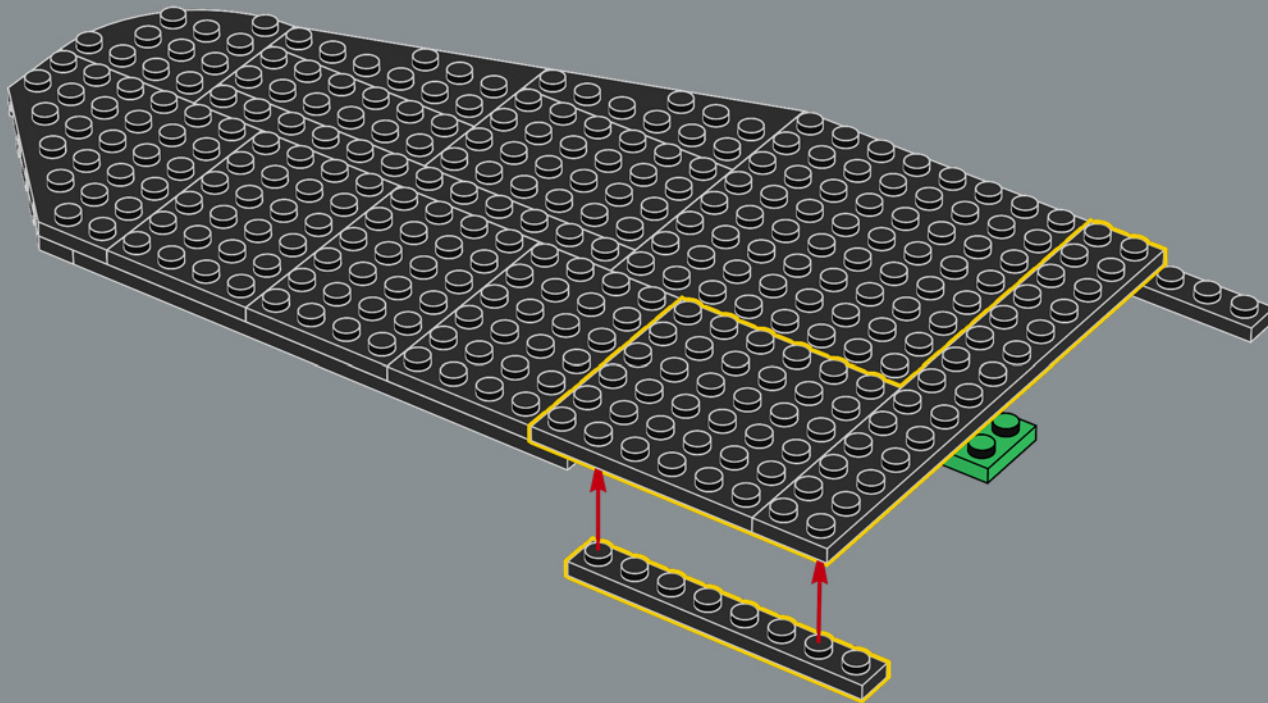

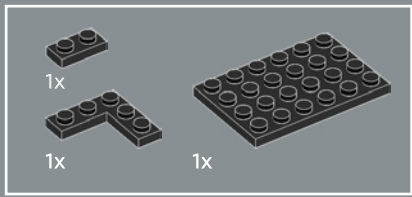

14

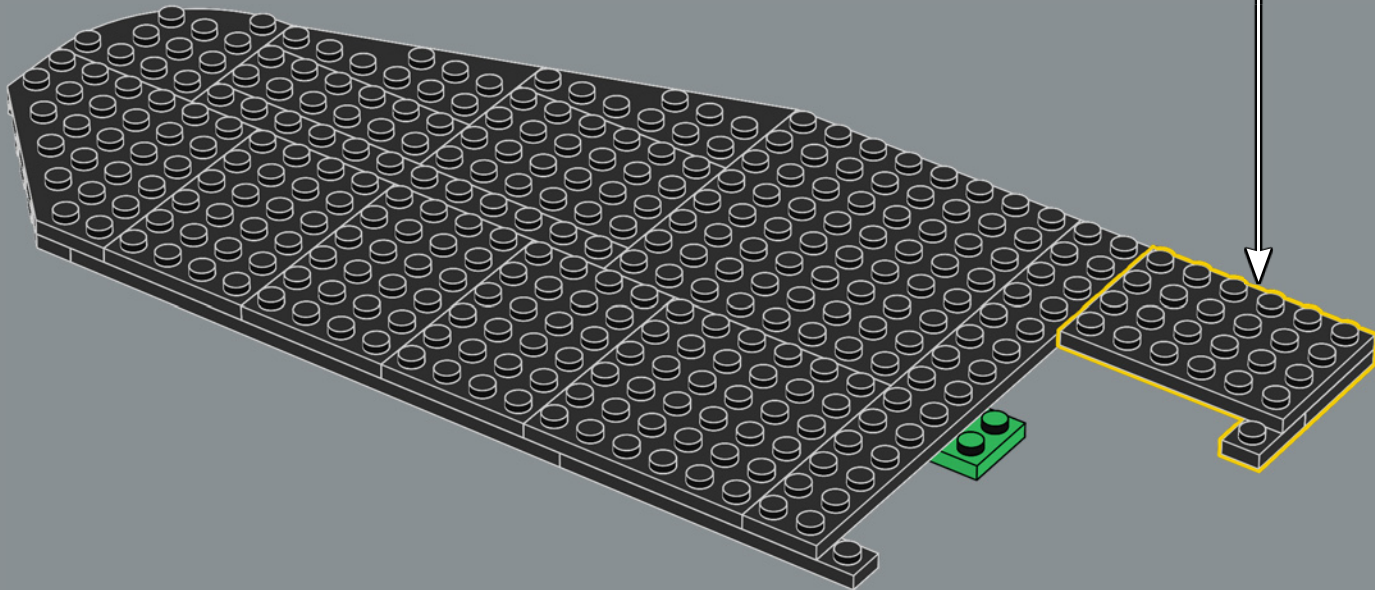
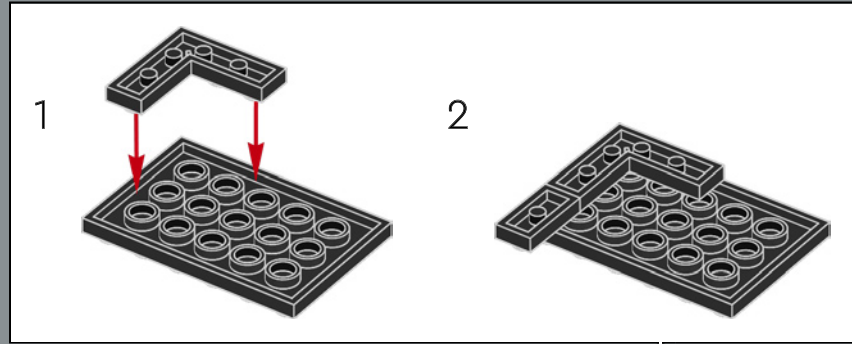

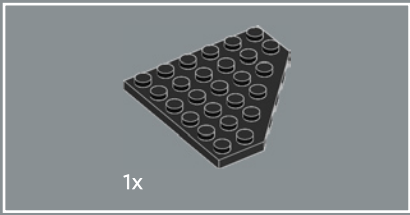

15

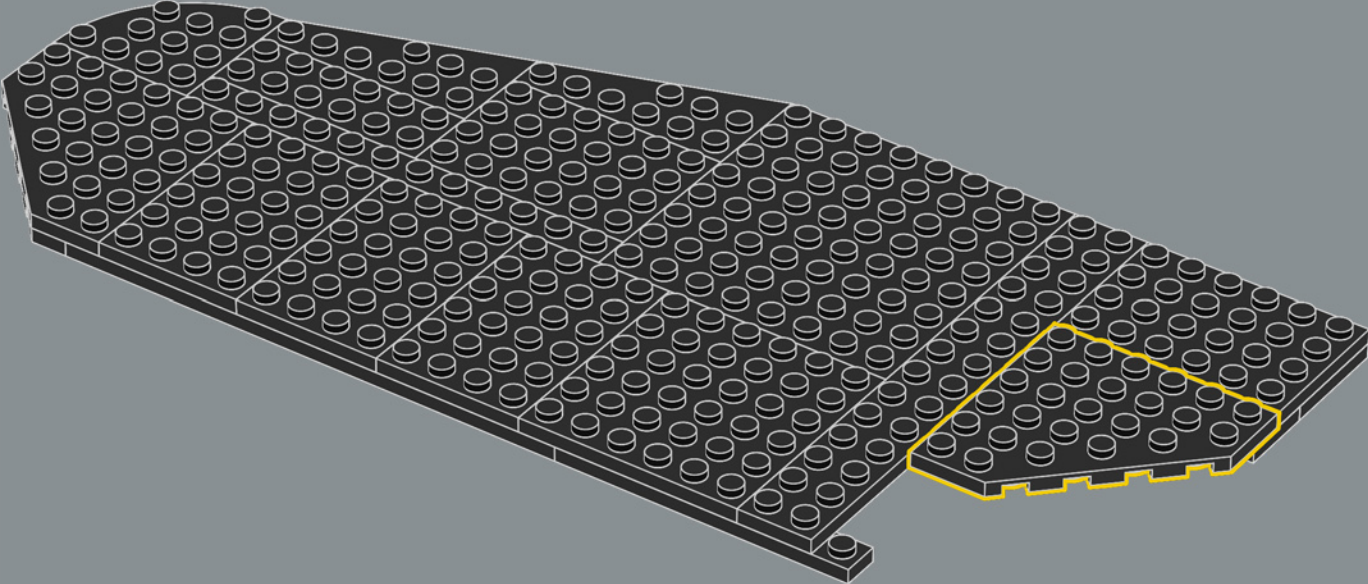

The colourful LEGO® plates within the base are inspired by a few of the 36 subway lines that connect the city.

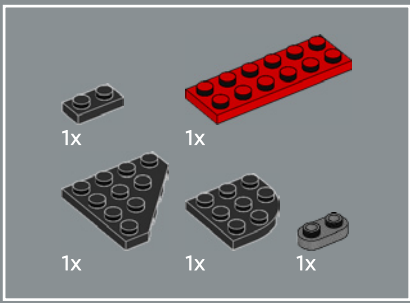

16

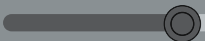
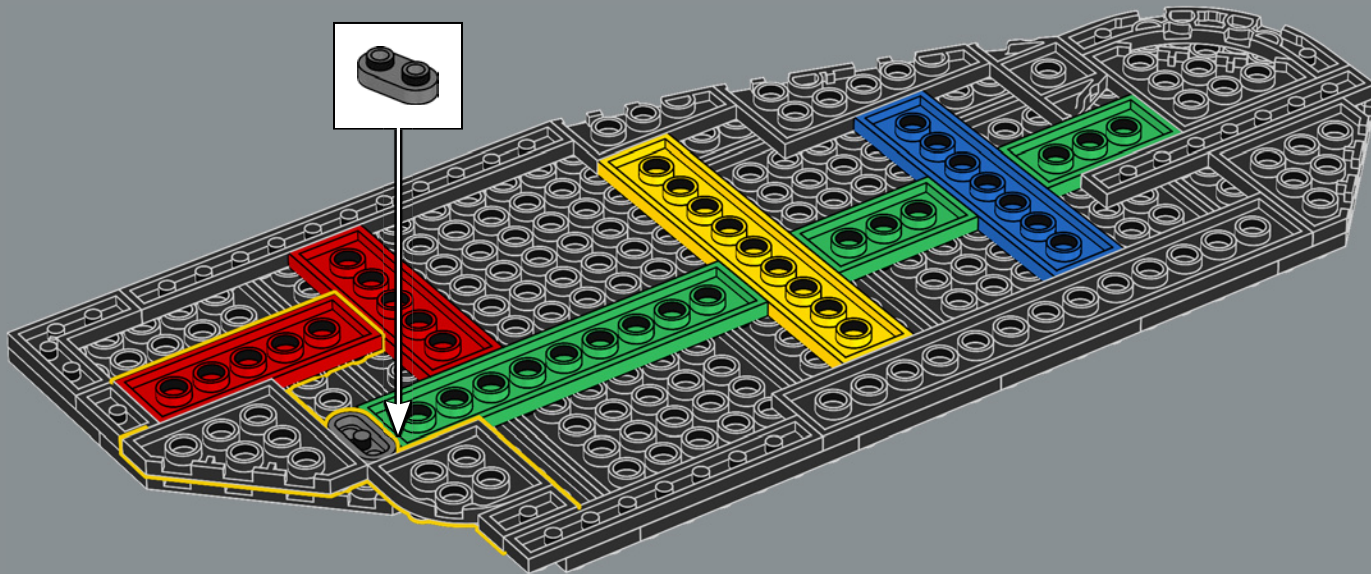

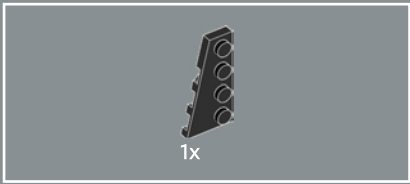

17

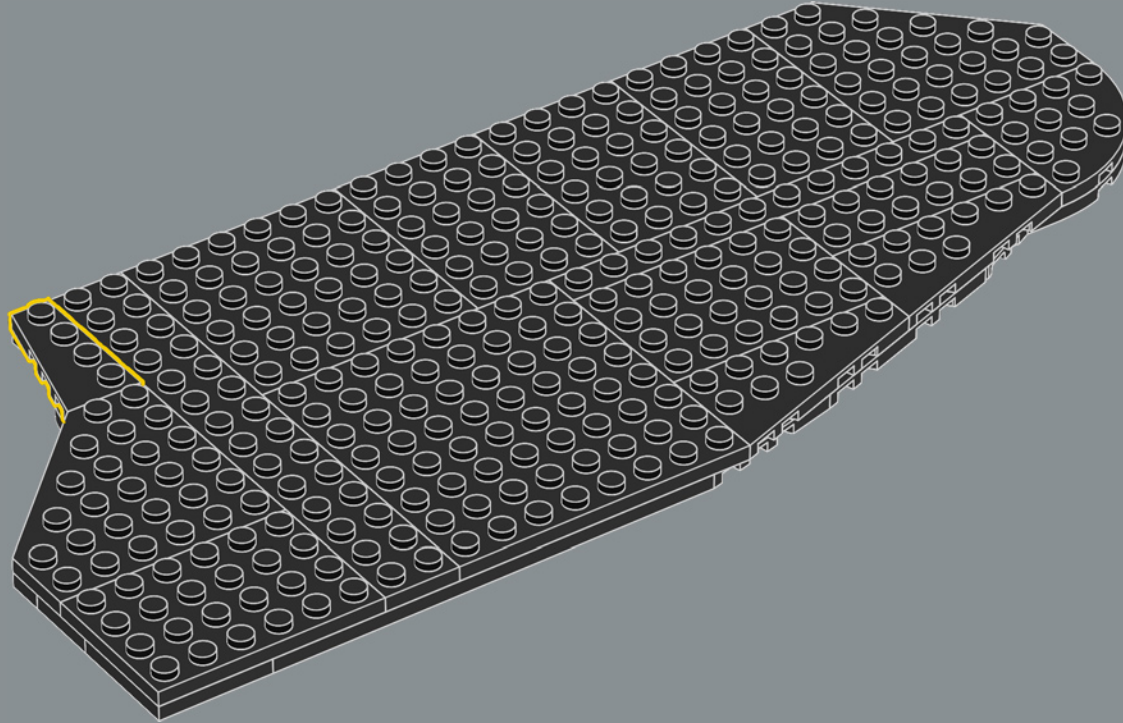

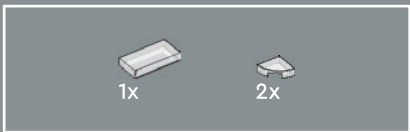

18



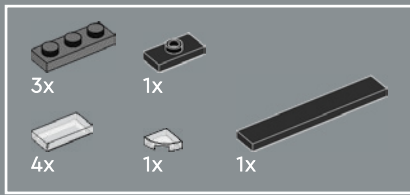

19

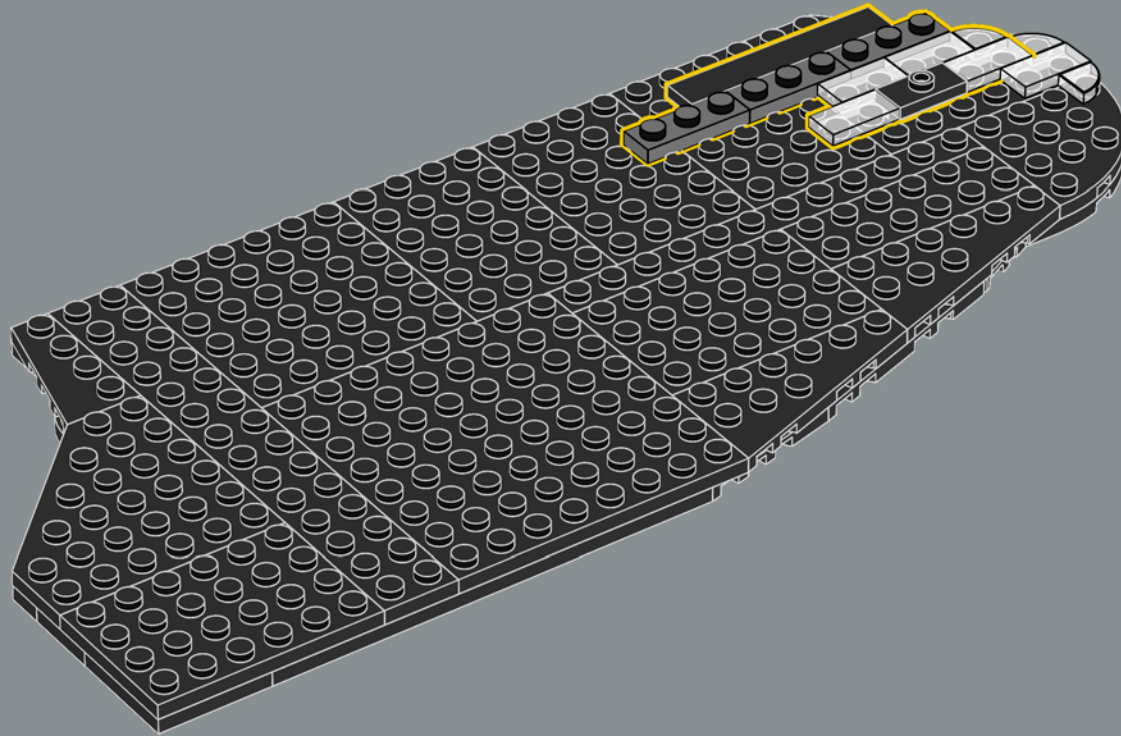

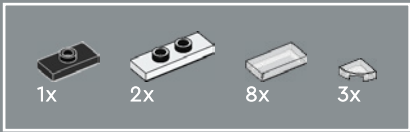

20

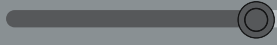
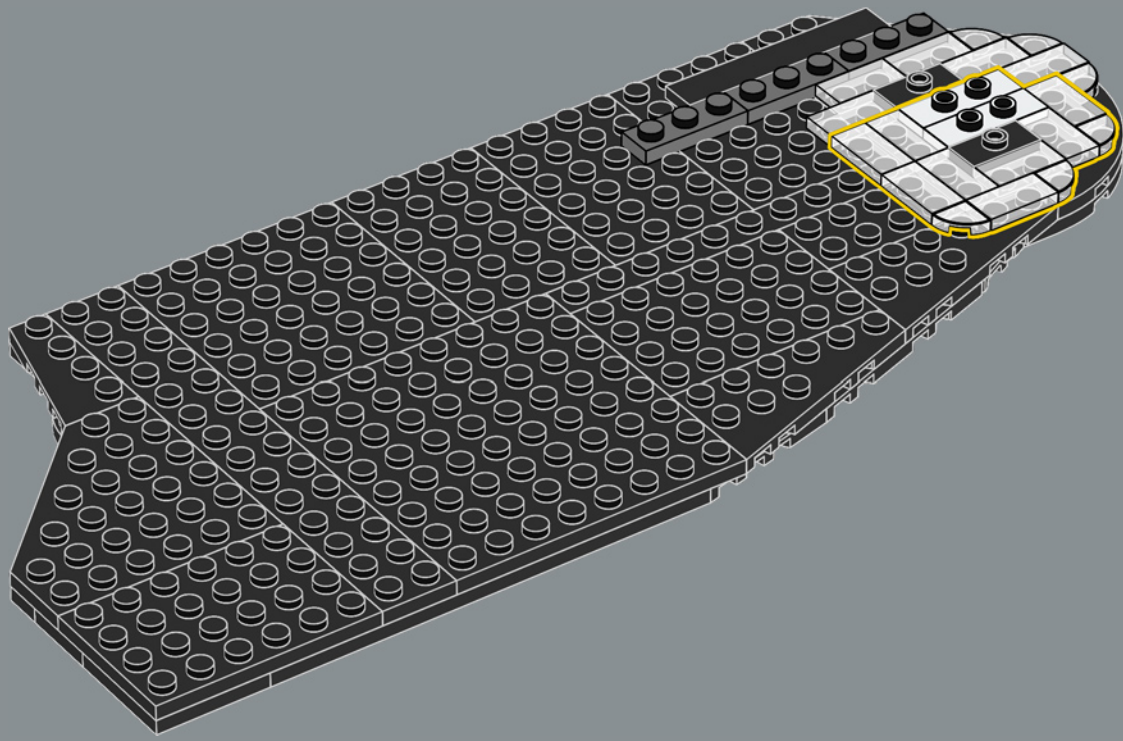

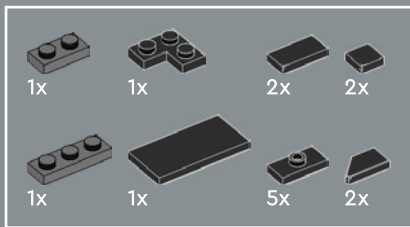

21

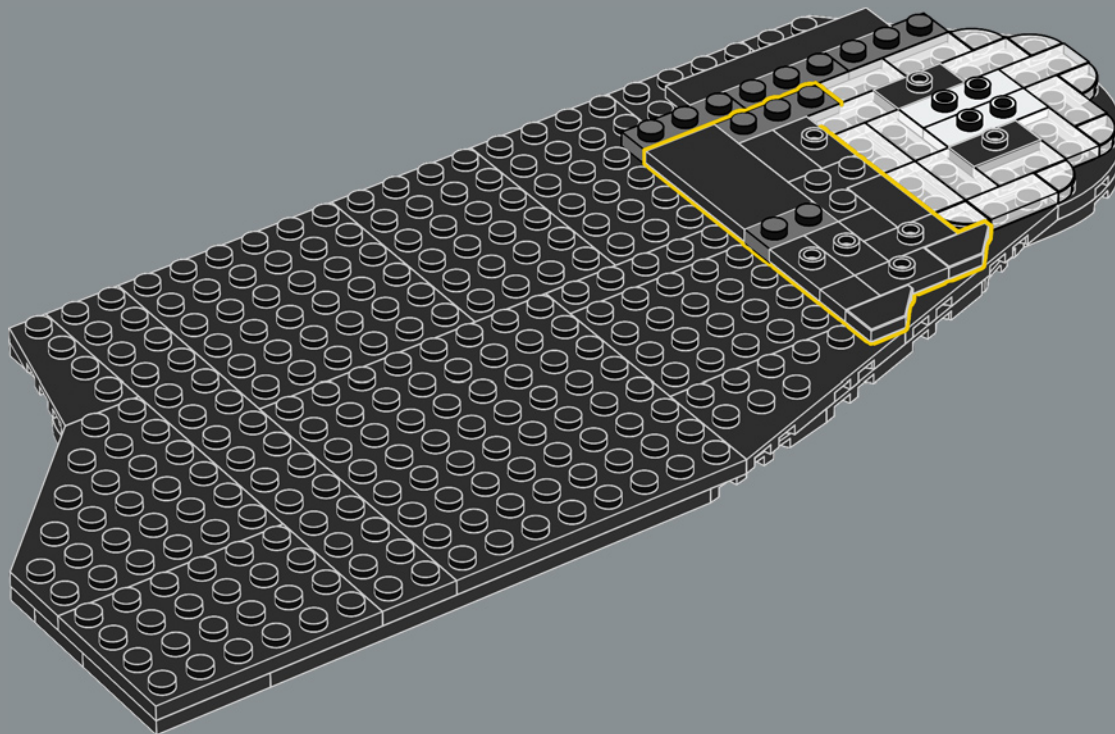

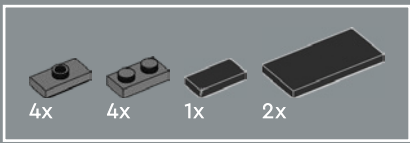

22

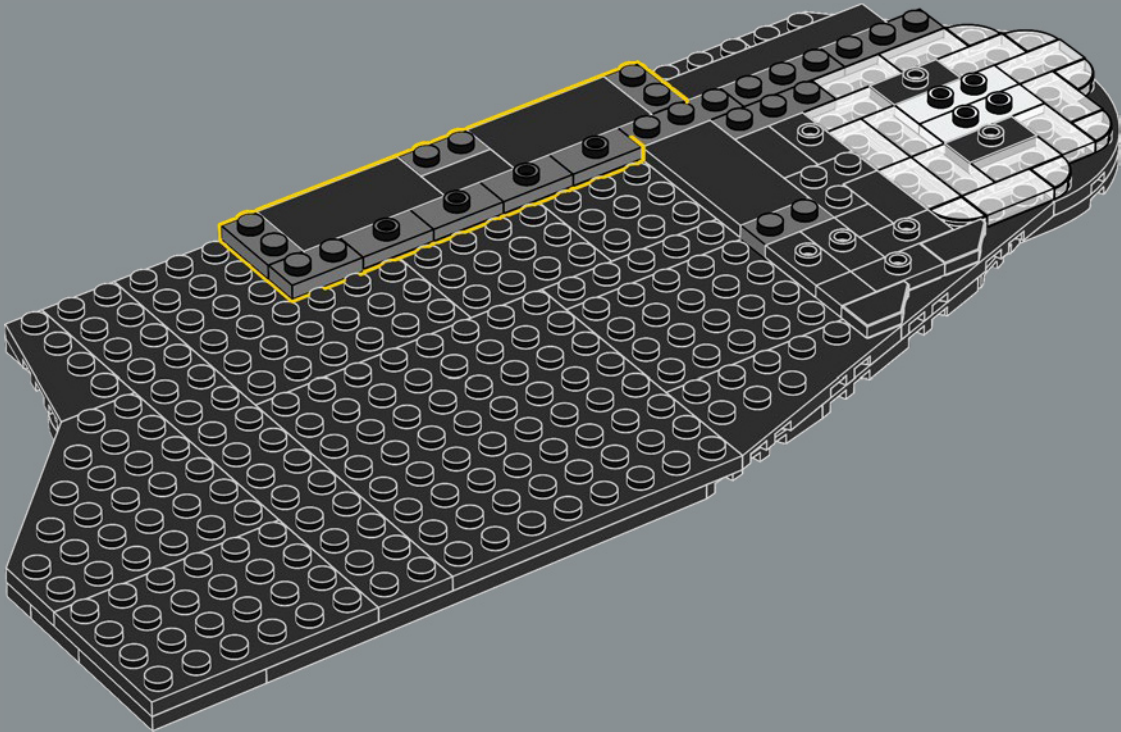

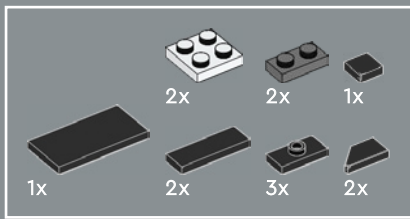

23

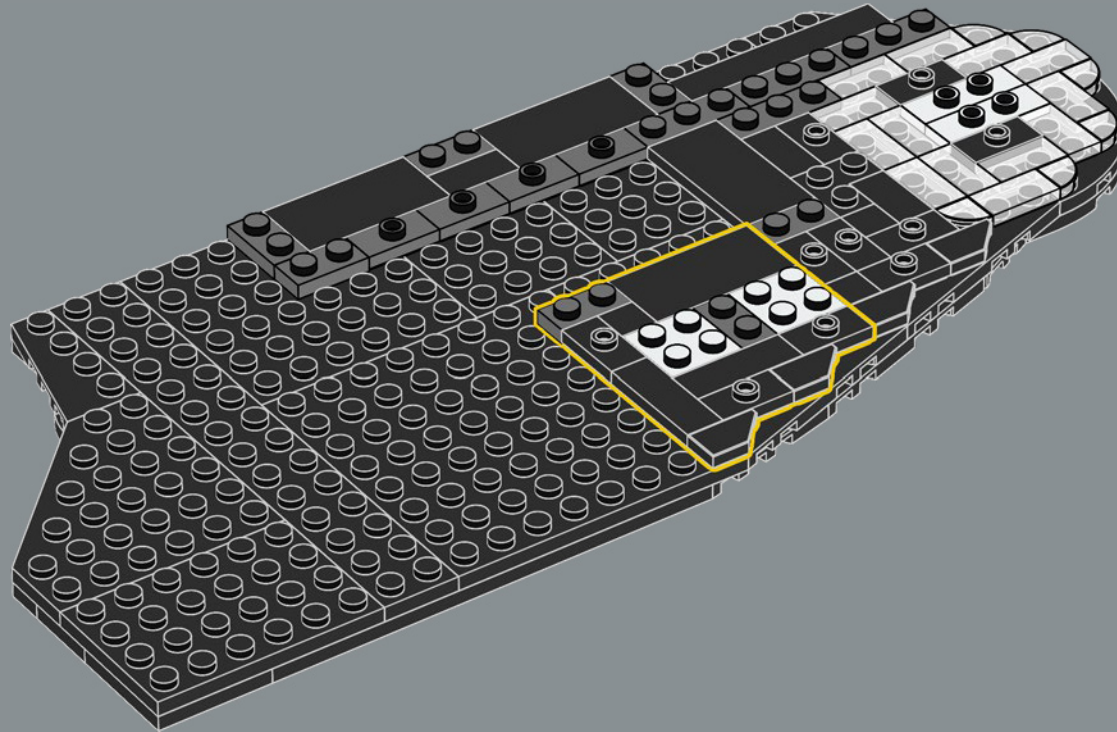

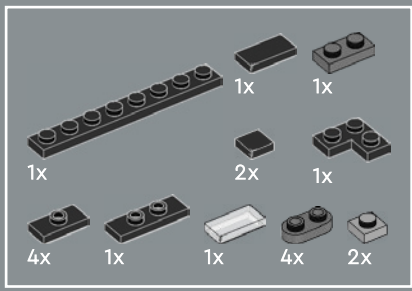

24

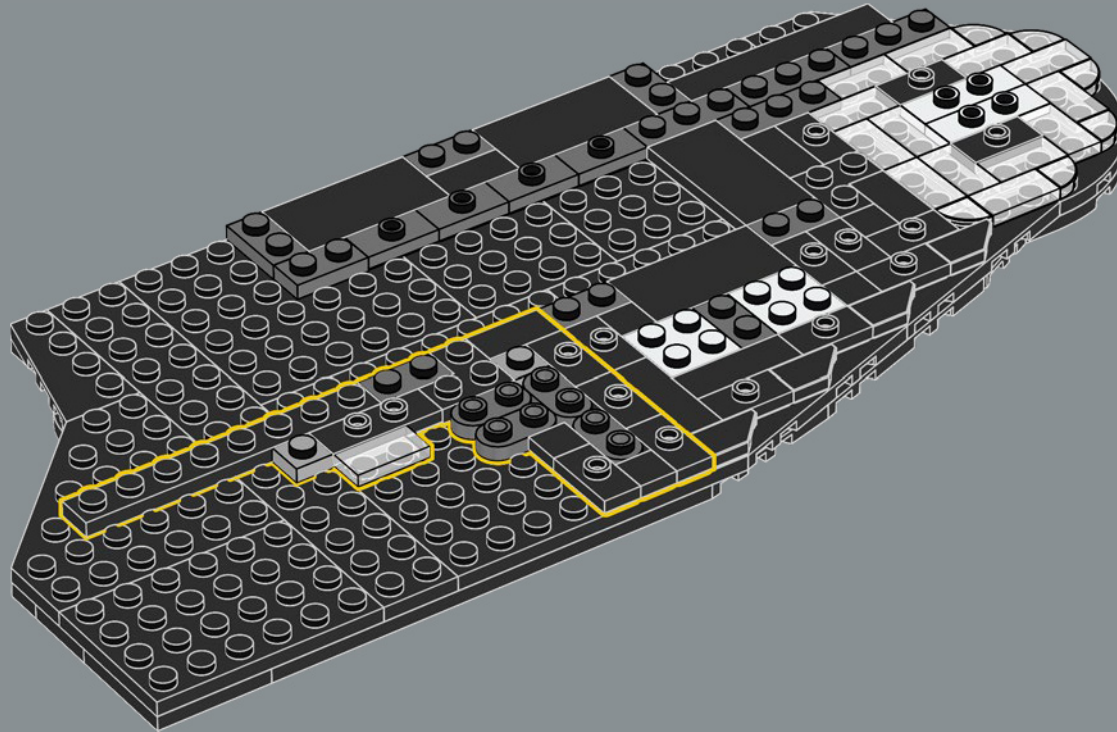

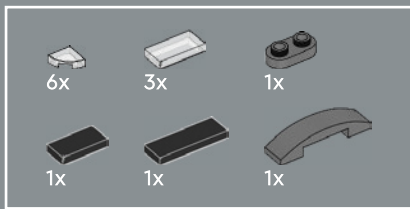

25

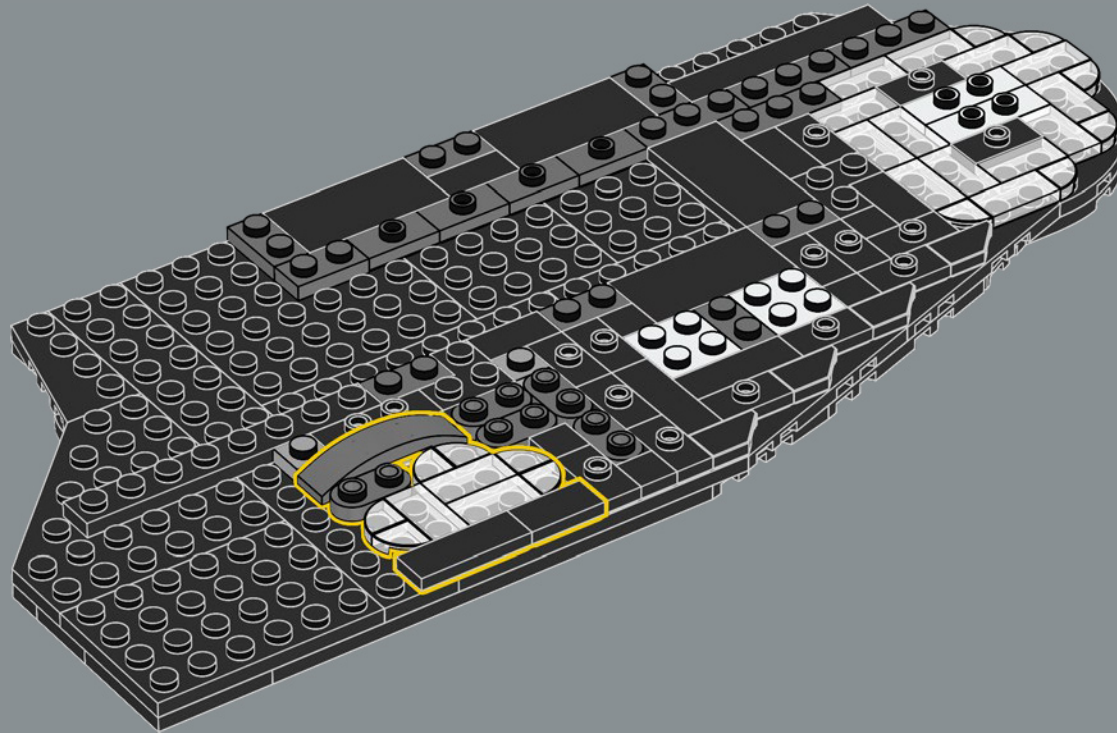

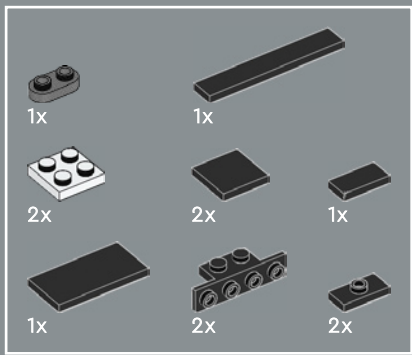

26

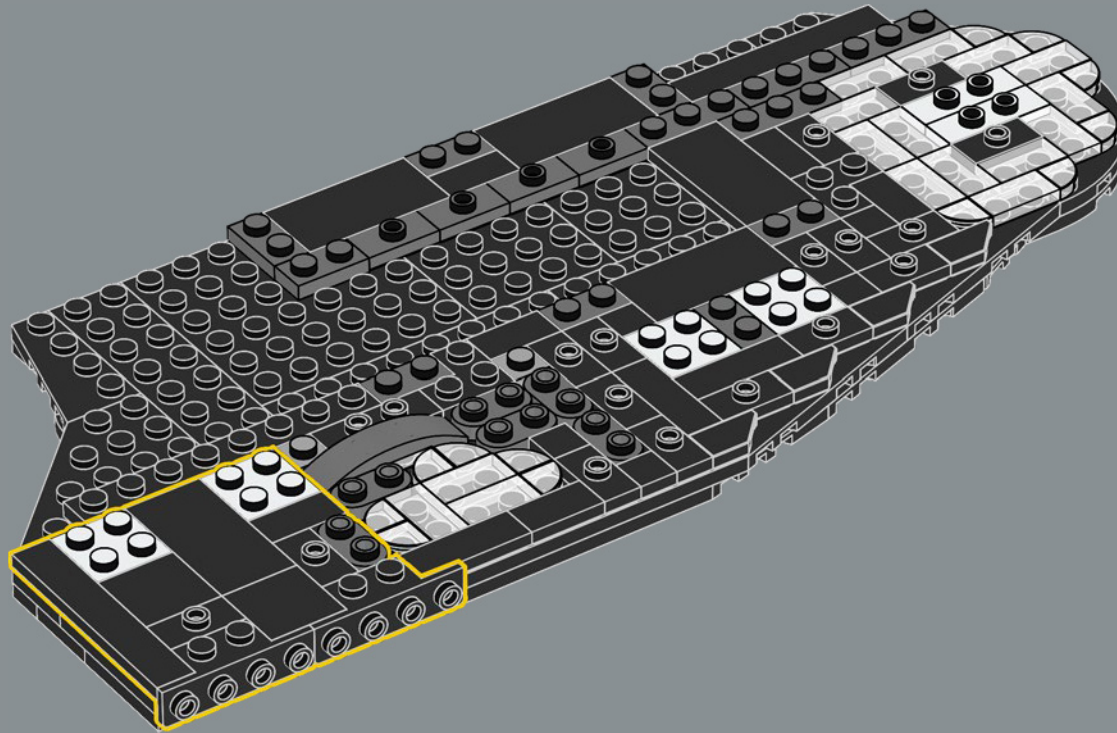

The base of the model is inspired by the largest New York borough, the Island of Manhattan.

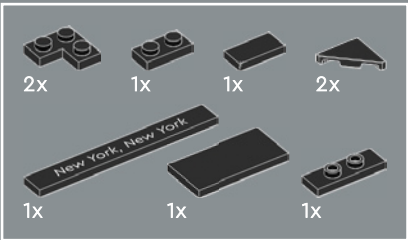

27

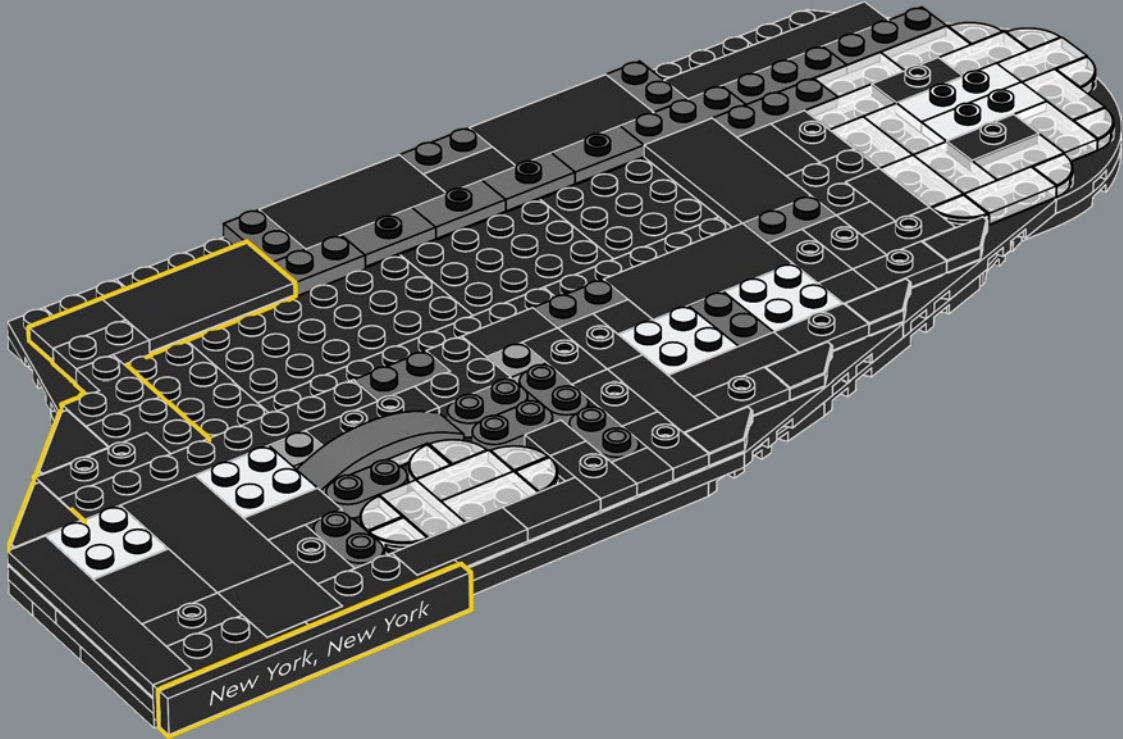

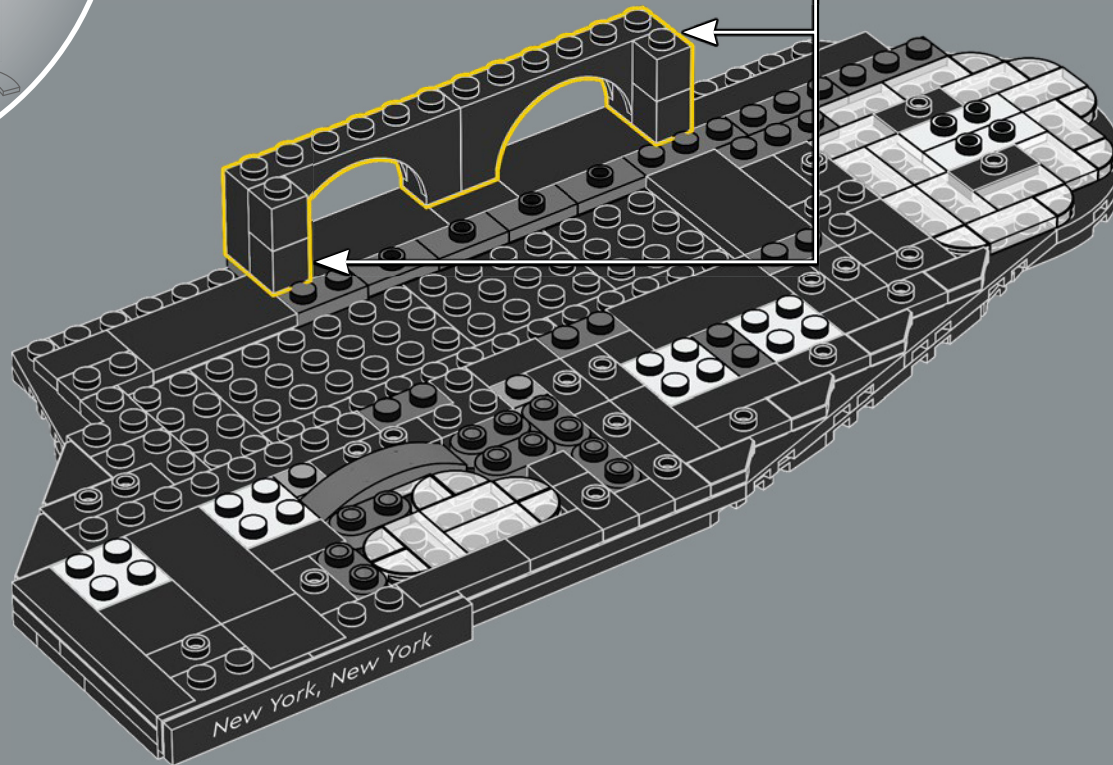
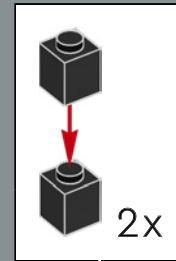
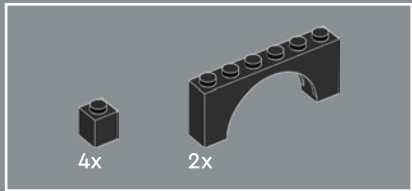

28

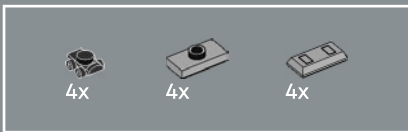

If you placed all 842 miles (1,355 km) of track in the New York subway system in a straight line, they would reach all the way from New York City to Chicago.

29

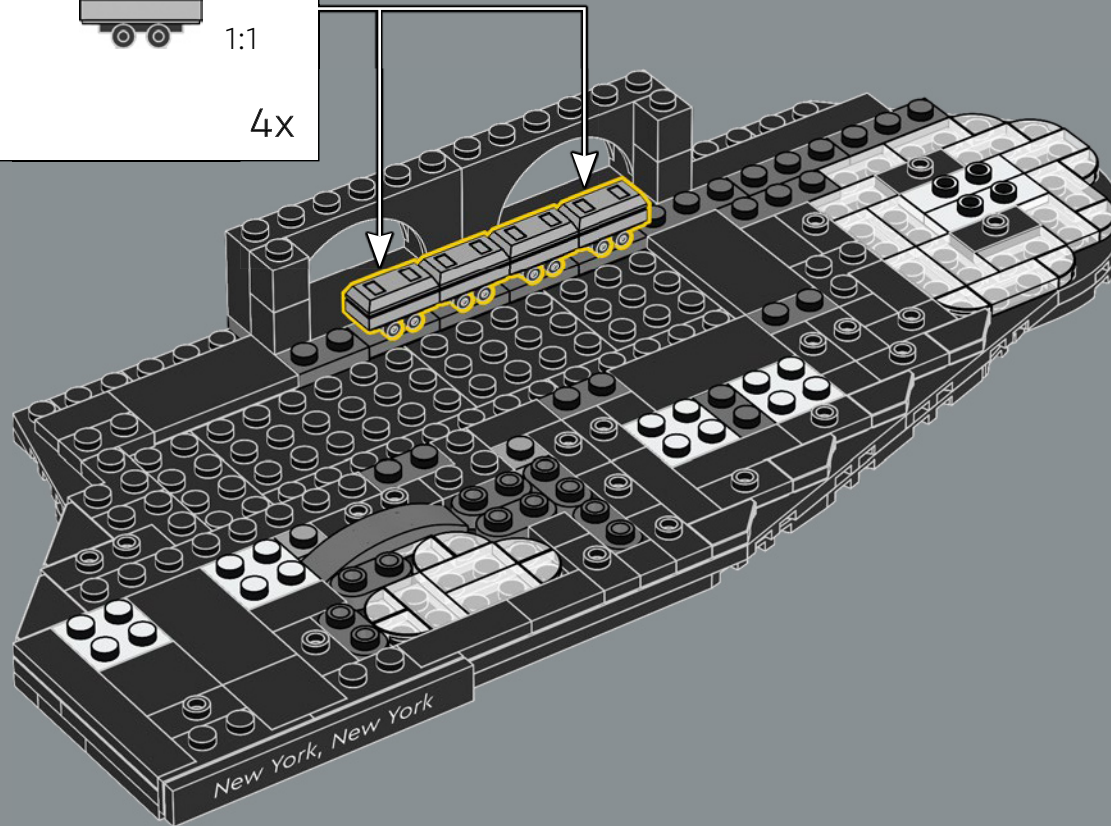
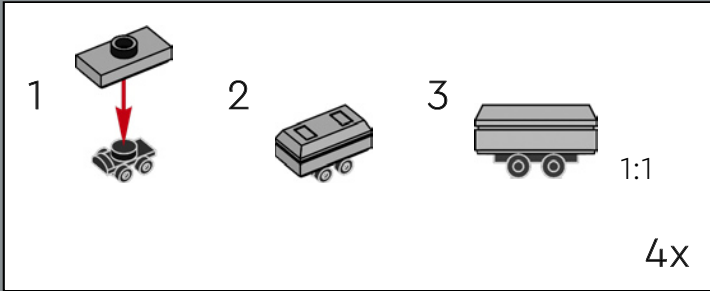

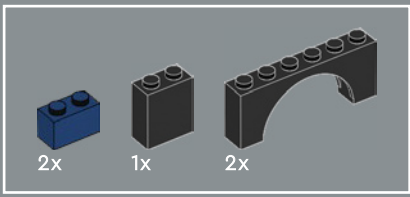

30

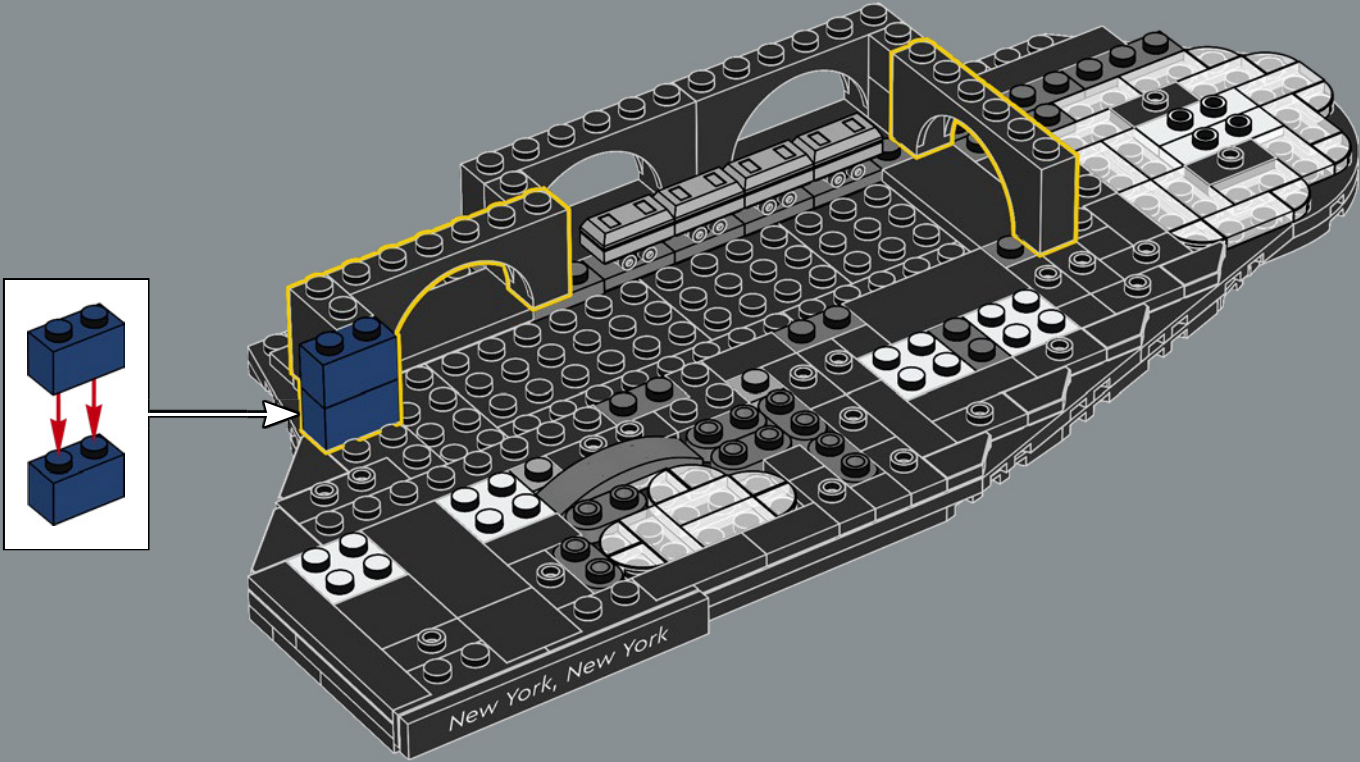

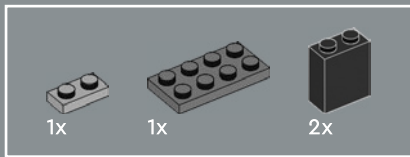

31

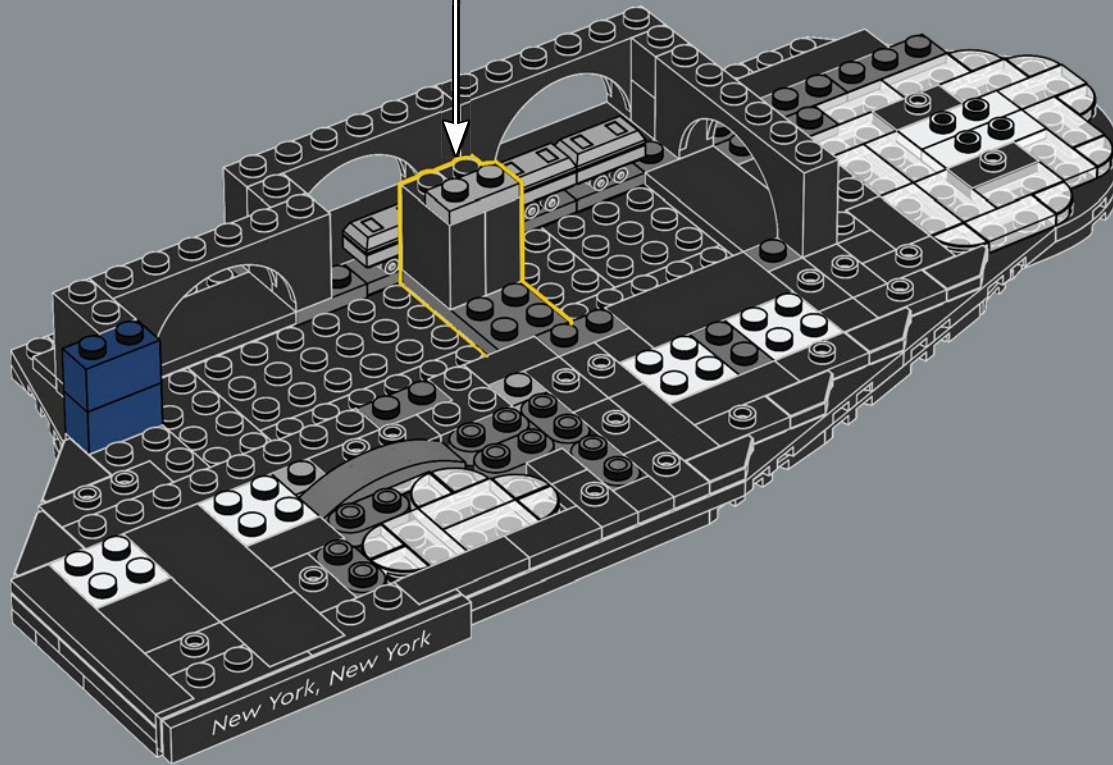
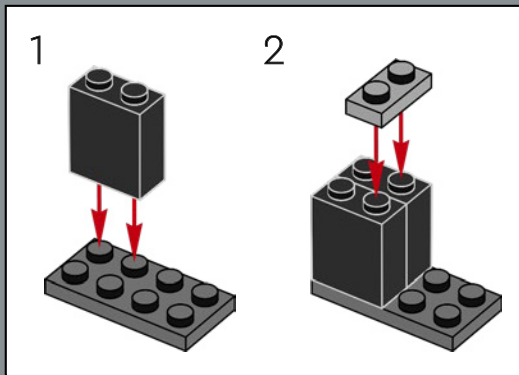

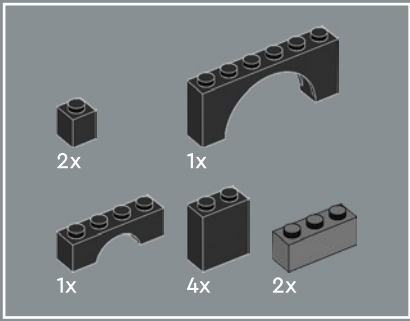

32

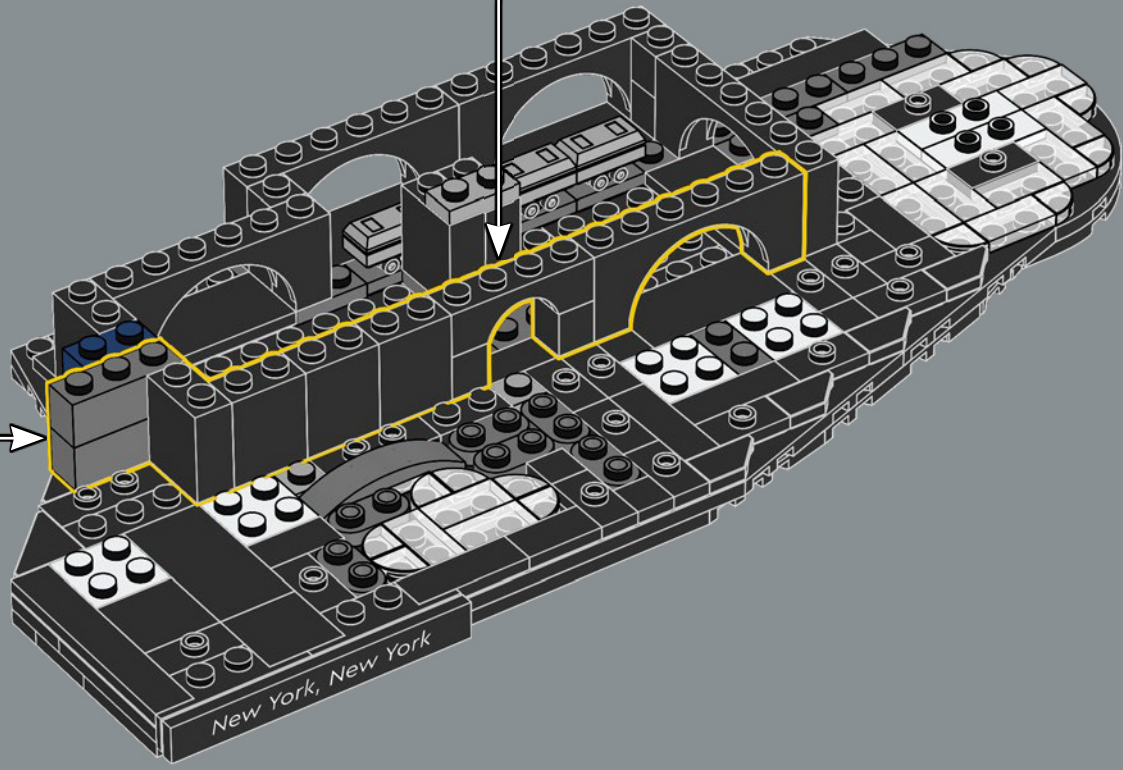
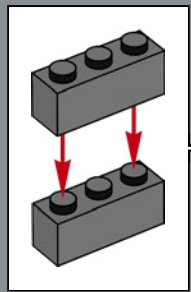
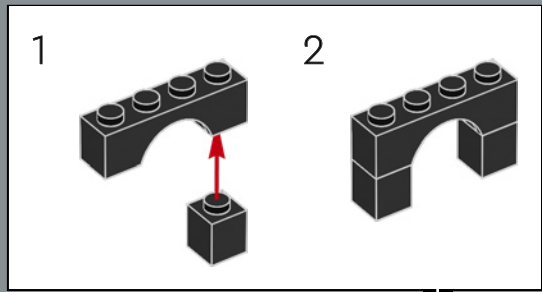

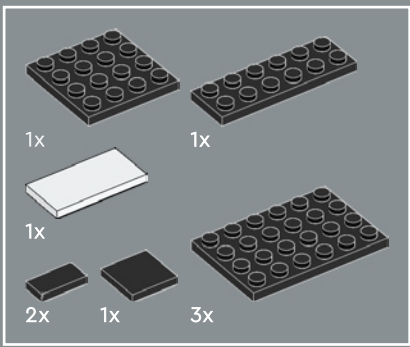

34

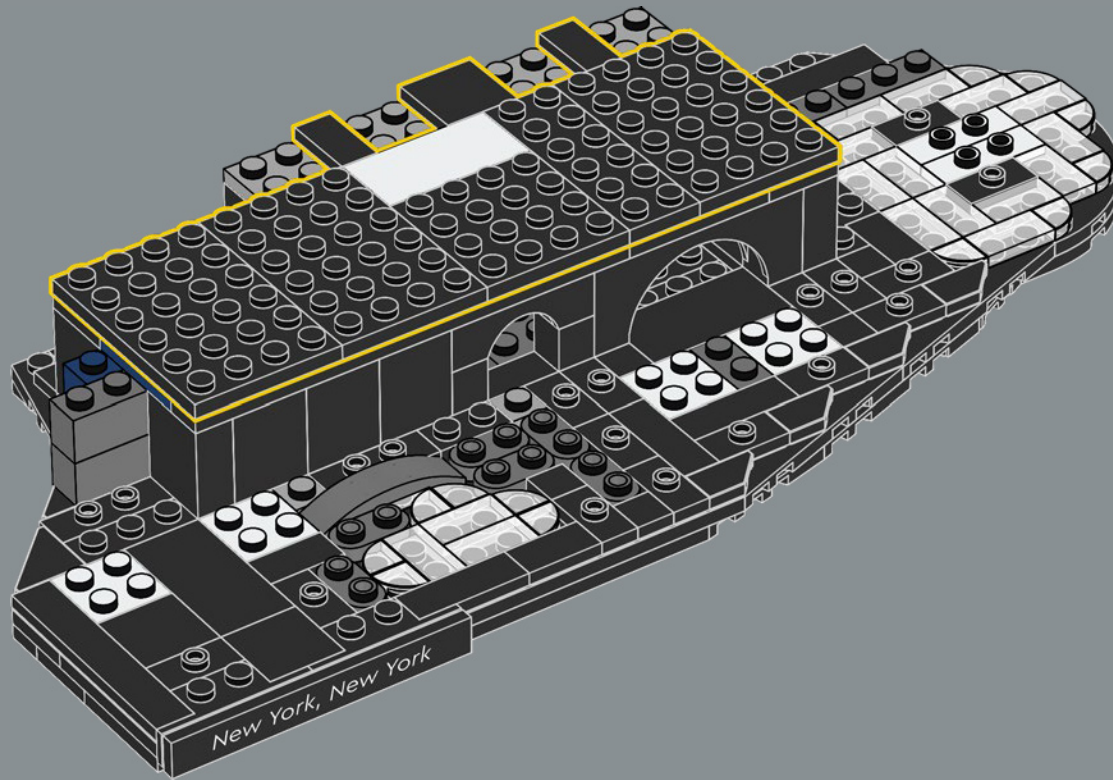

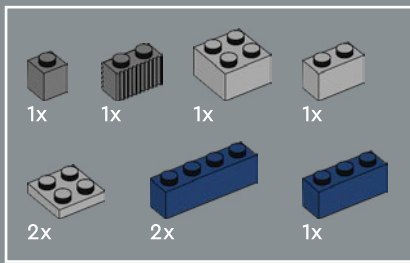

35

1

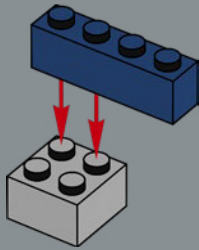

2

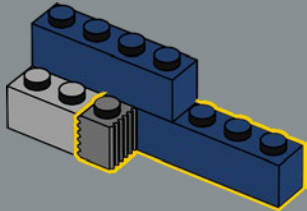

3

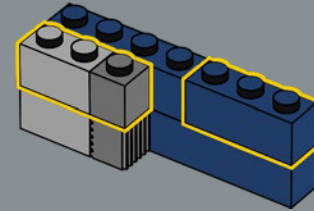

4

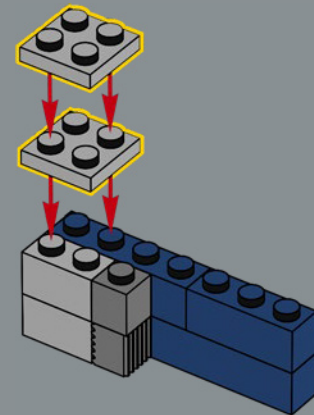

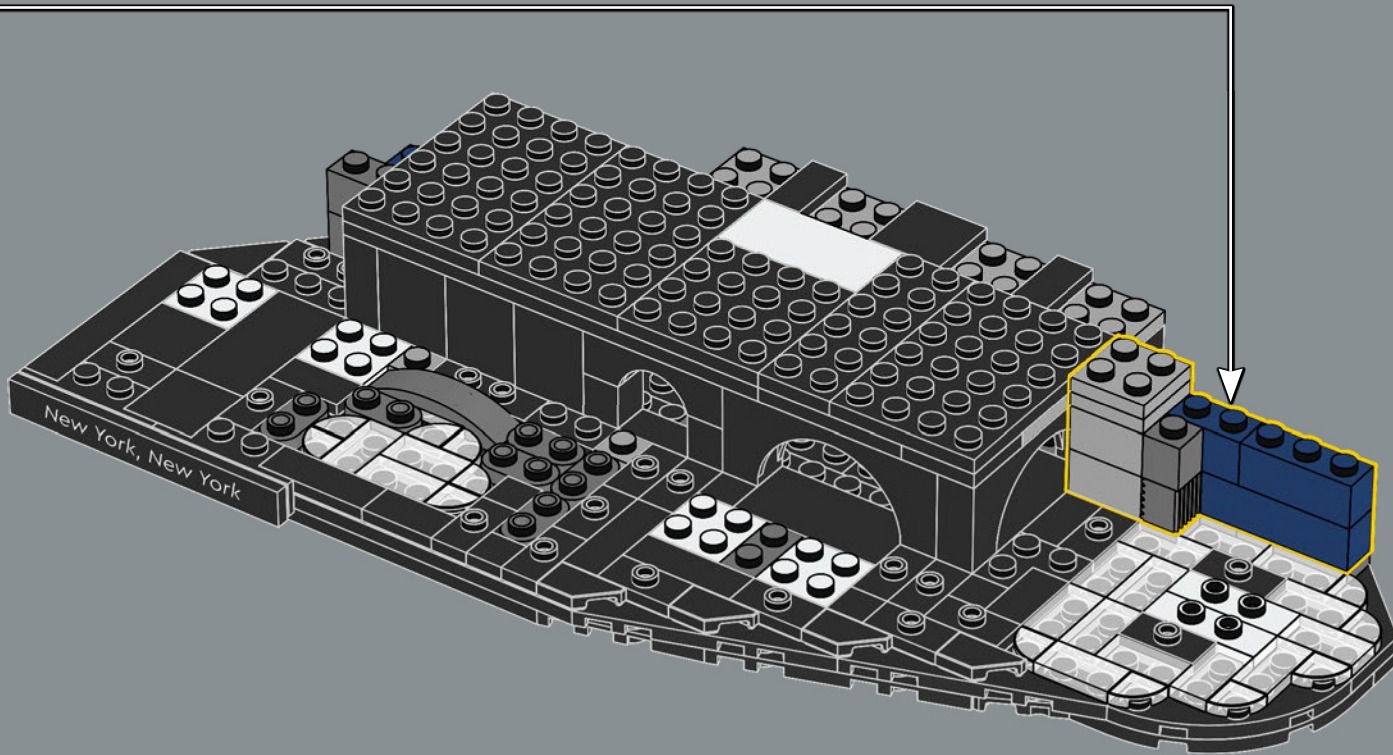

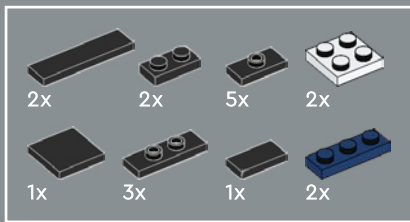

36

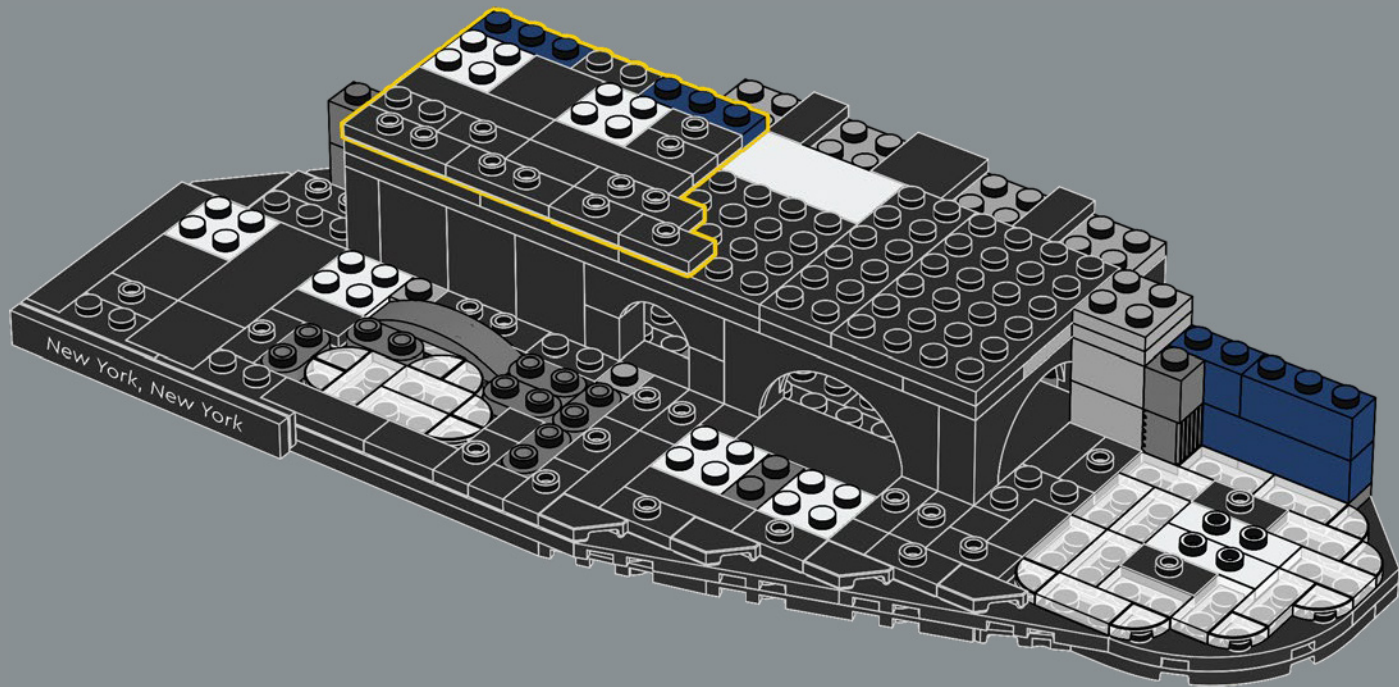

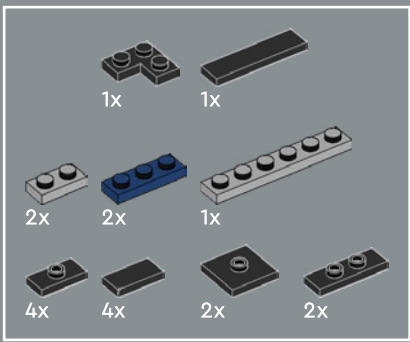

37

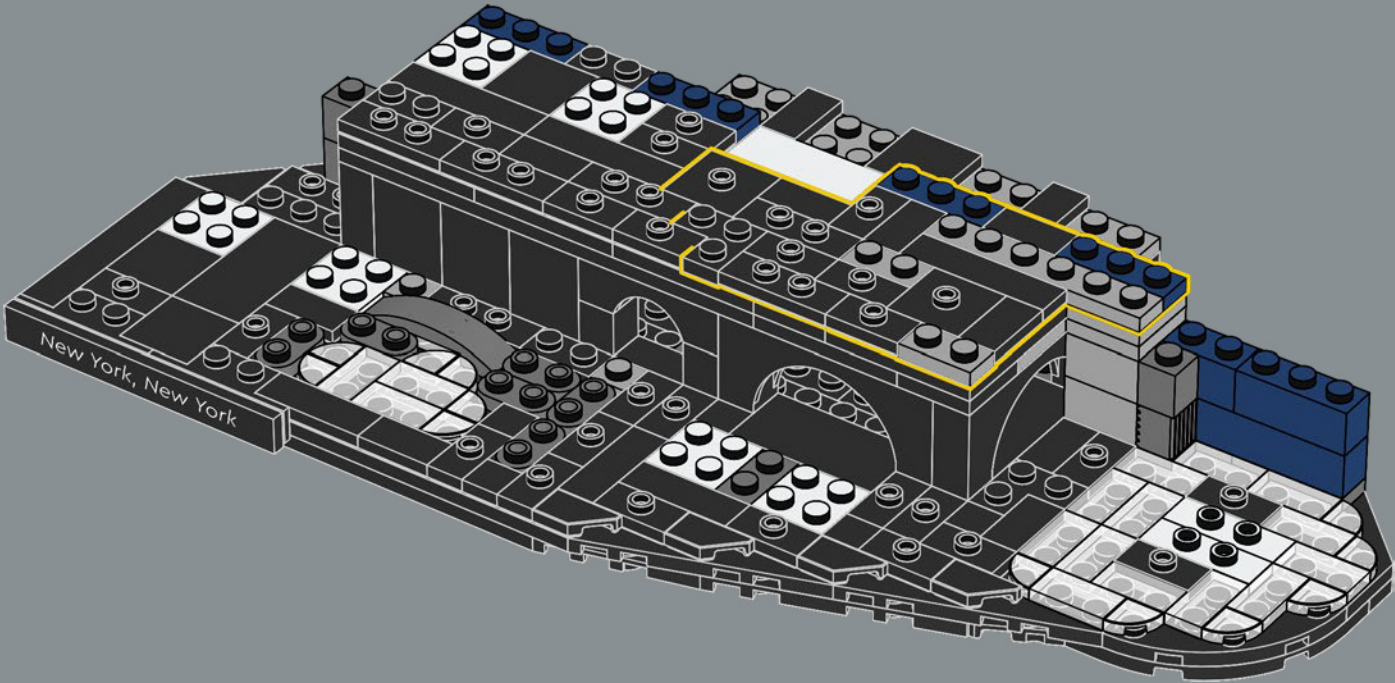

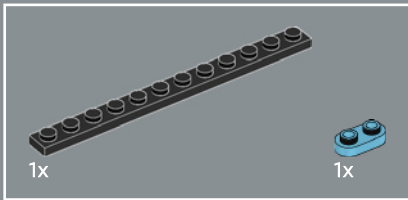
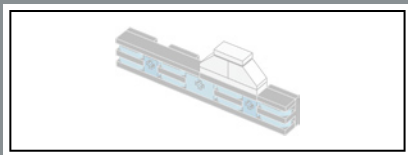

38

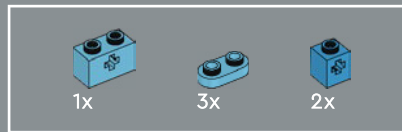
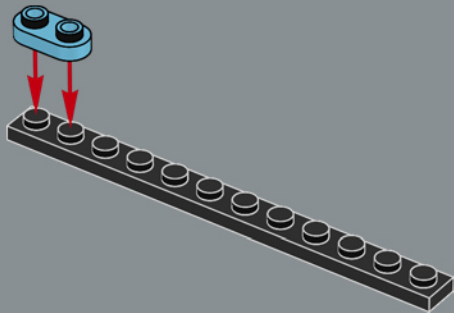

39

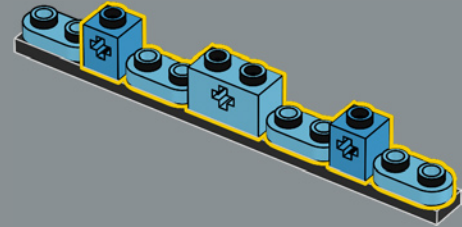

40

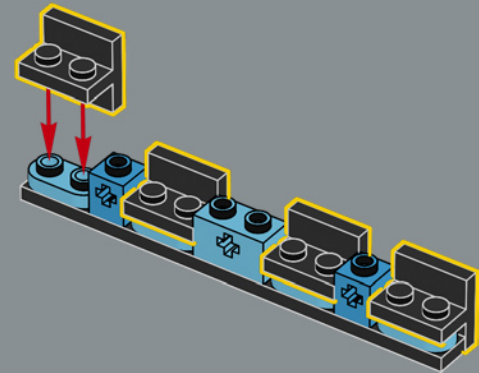

4x

41

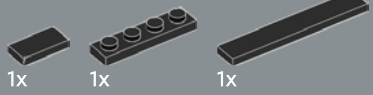
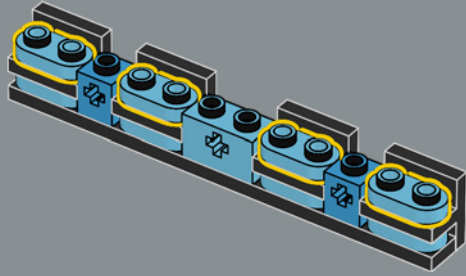

42

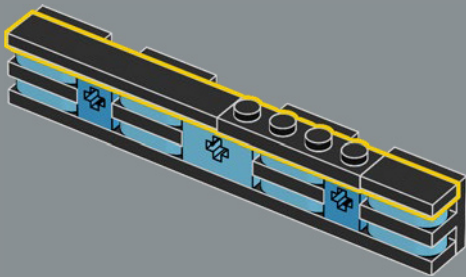

1x

1x

2x

43

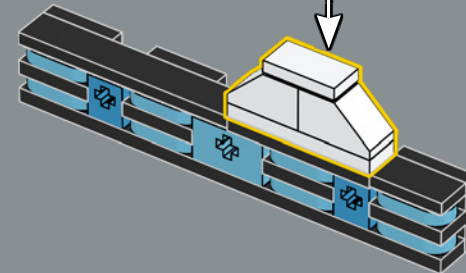
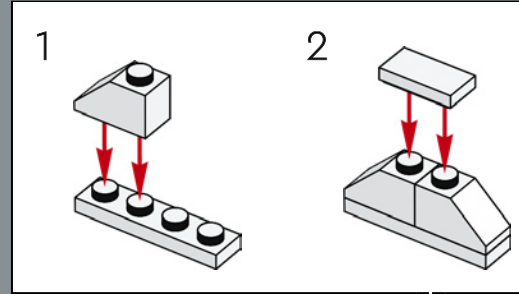

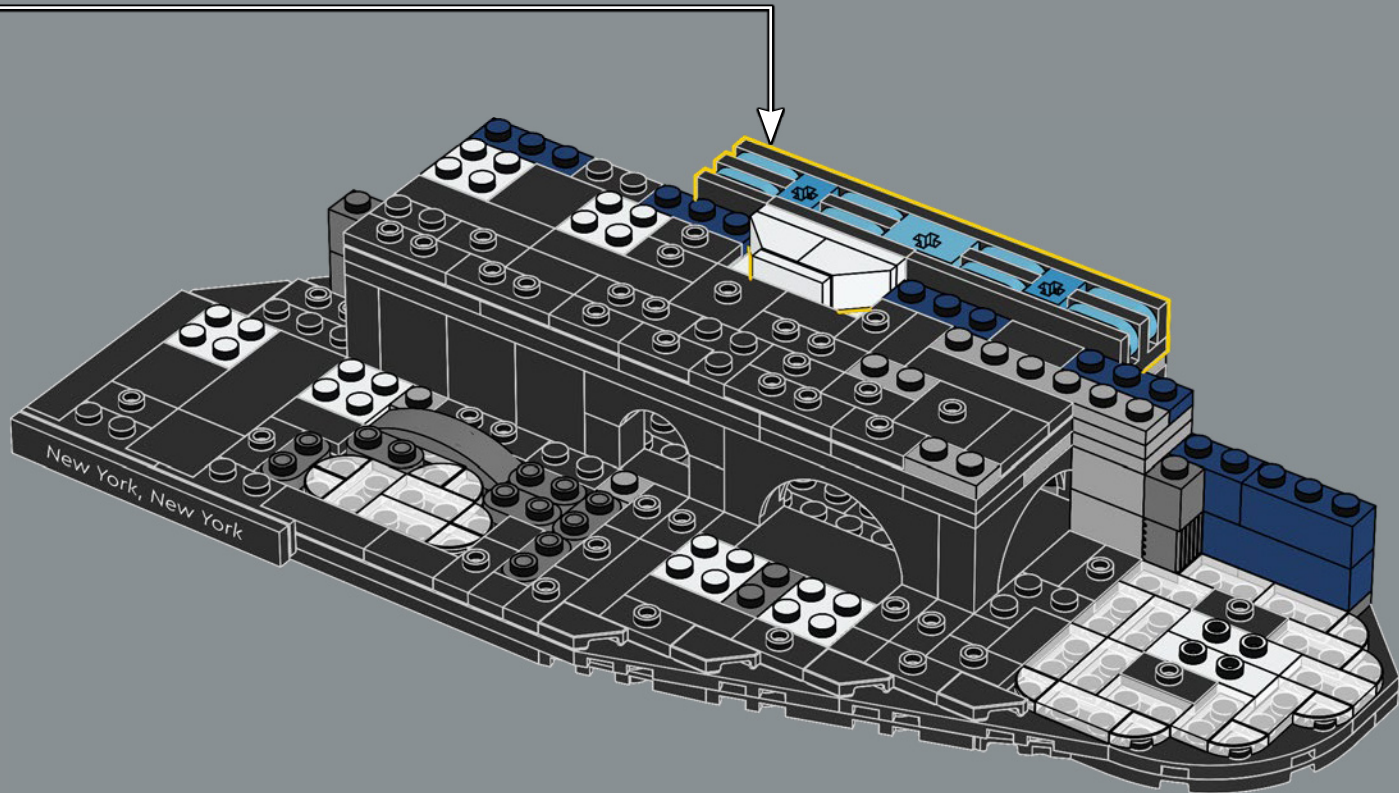

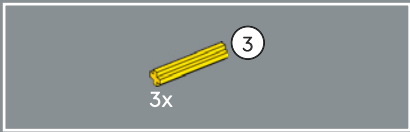

45

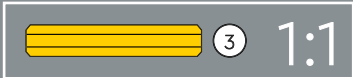
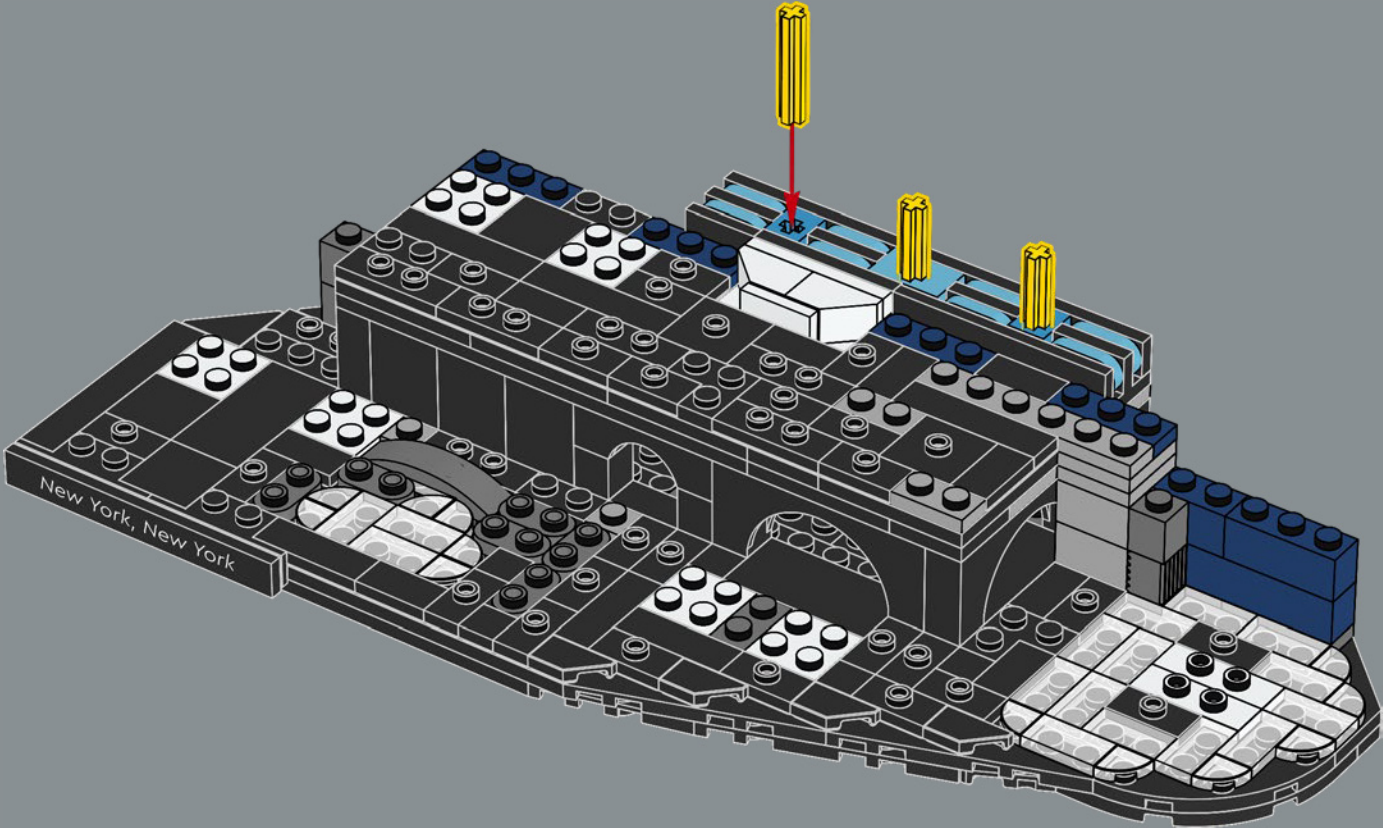

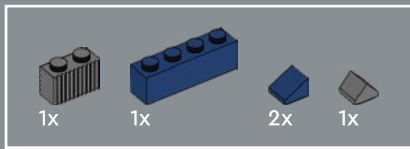

46

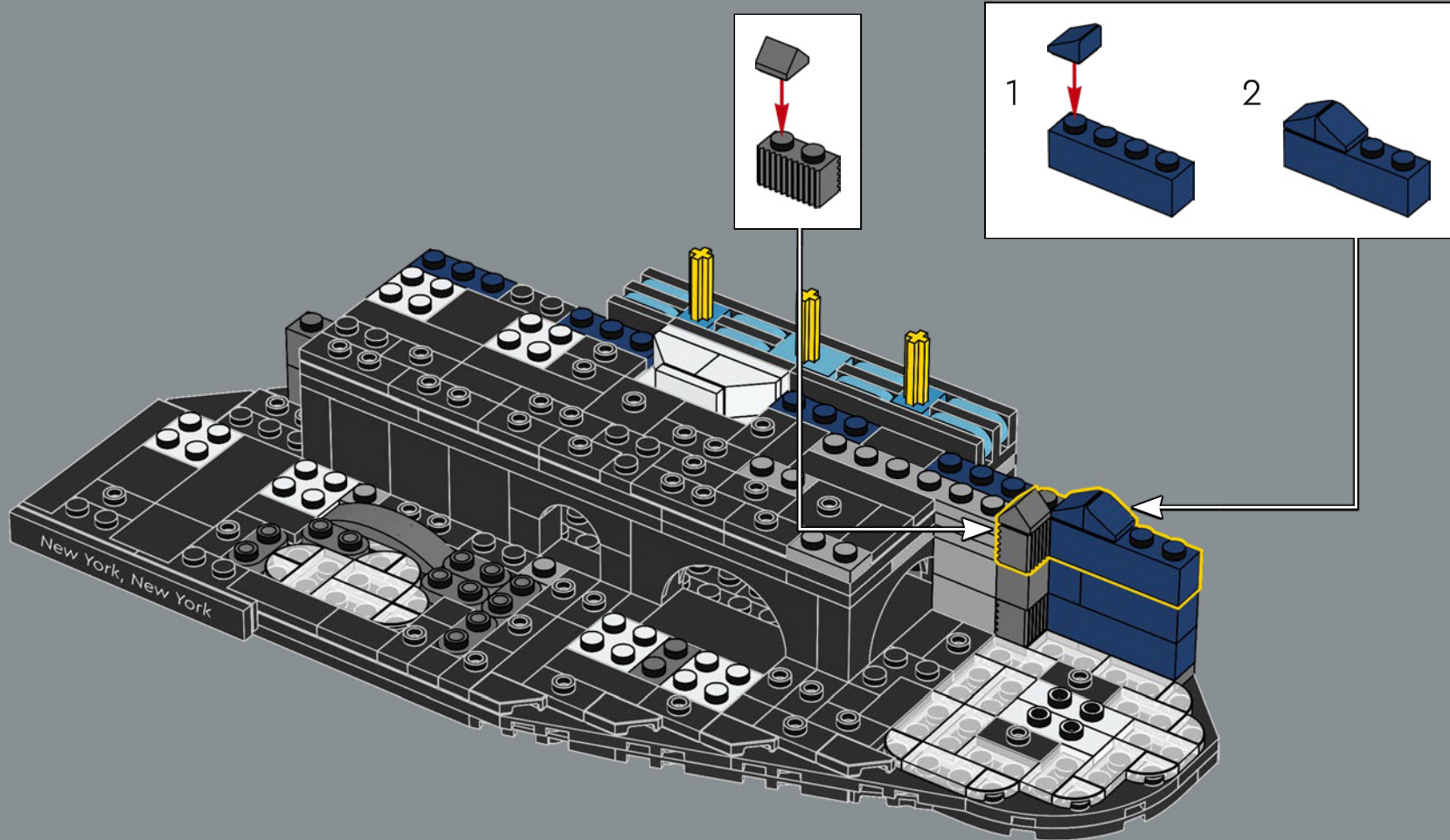

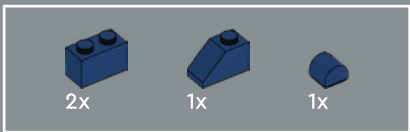

47

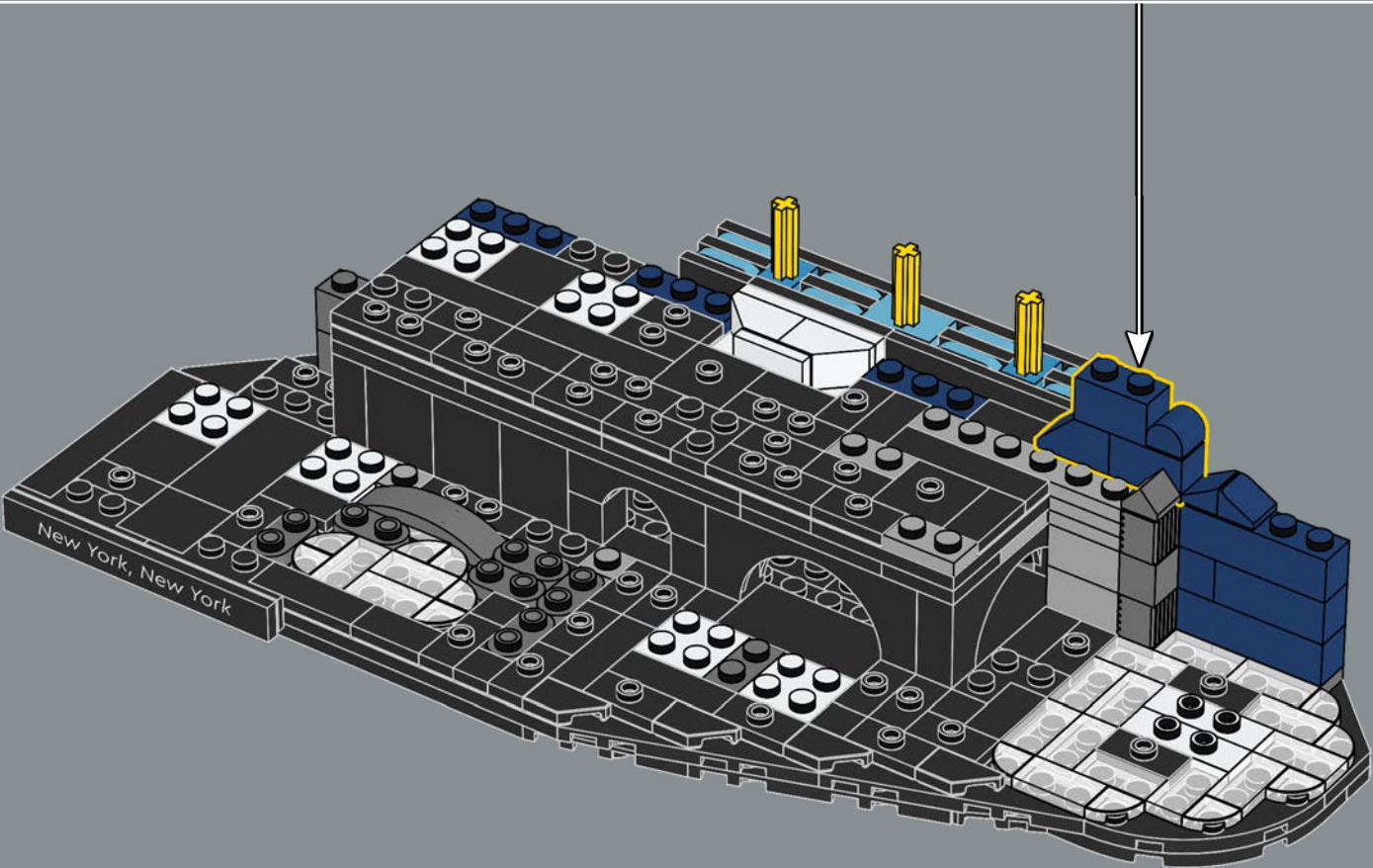
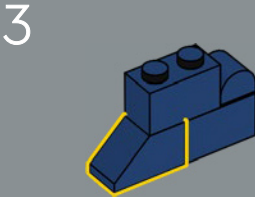
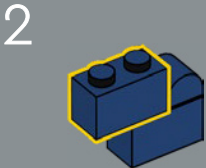
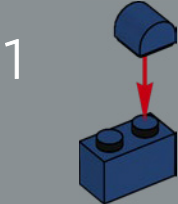

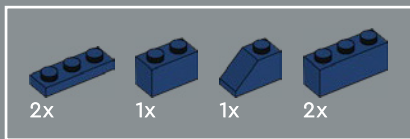

48

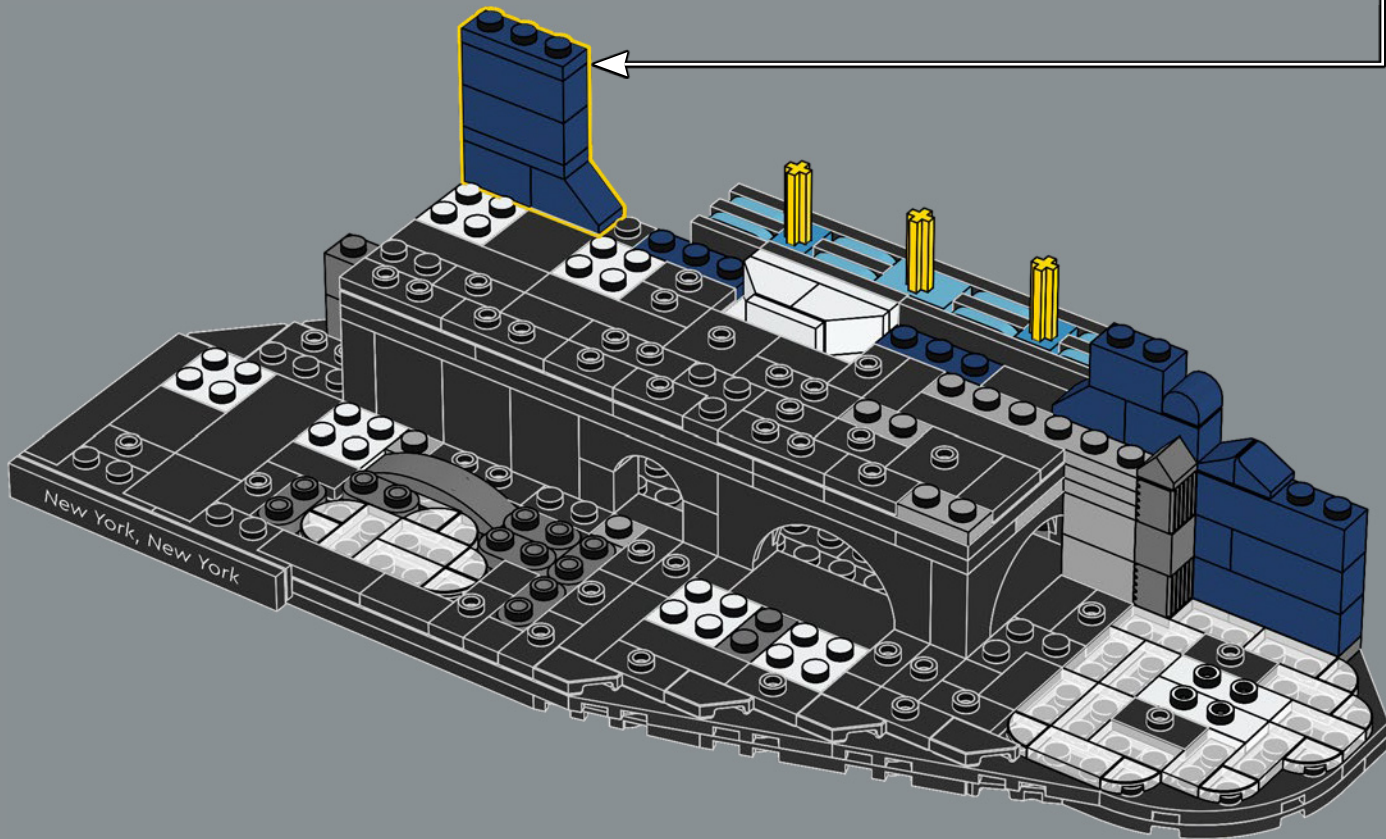

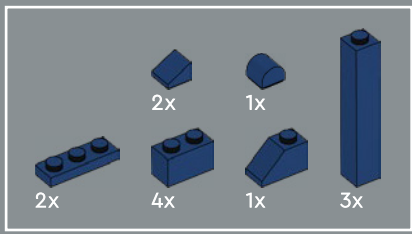

49

1

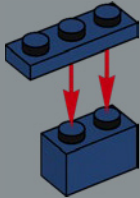

2

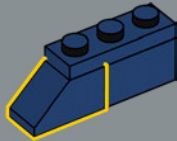

3

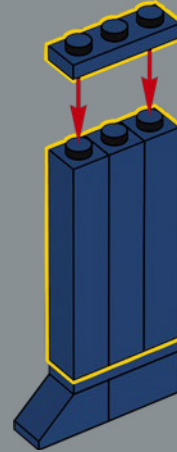

4

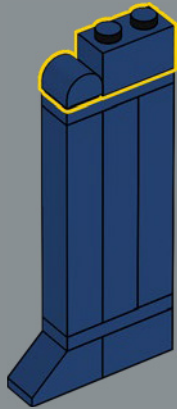

5

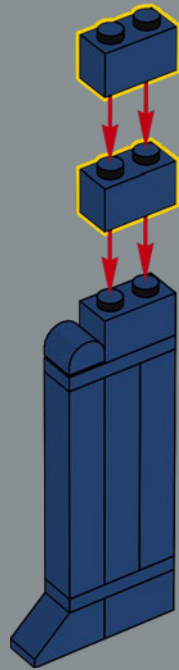

6

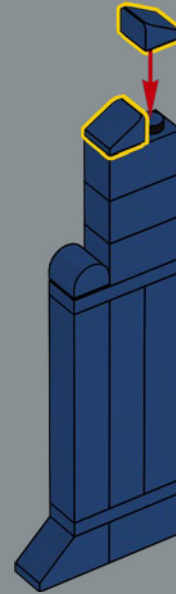

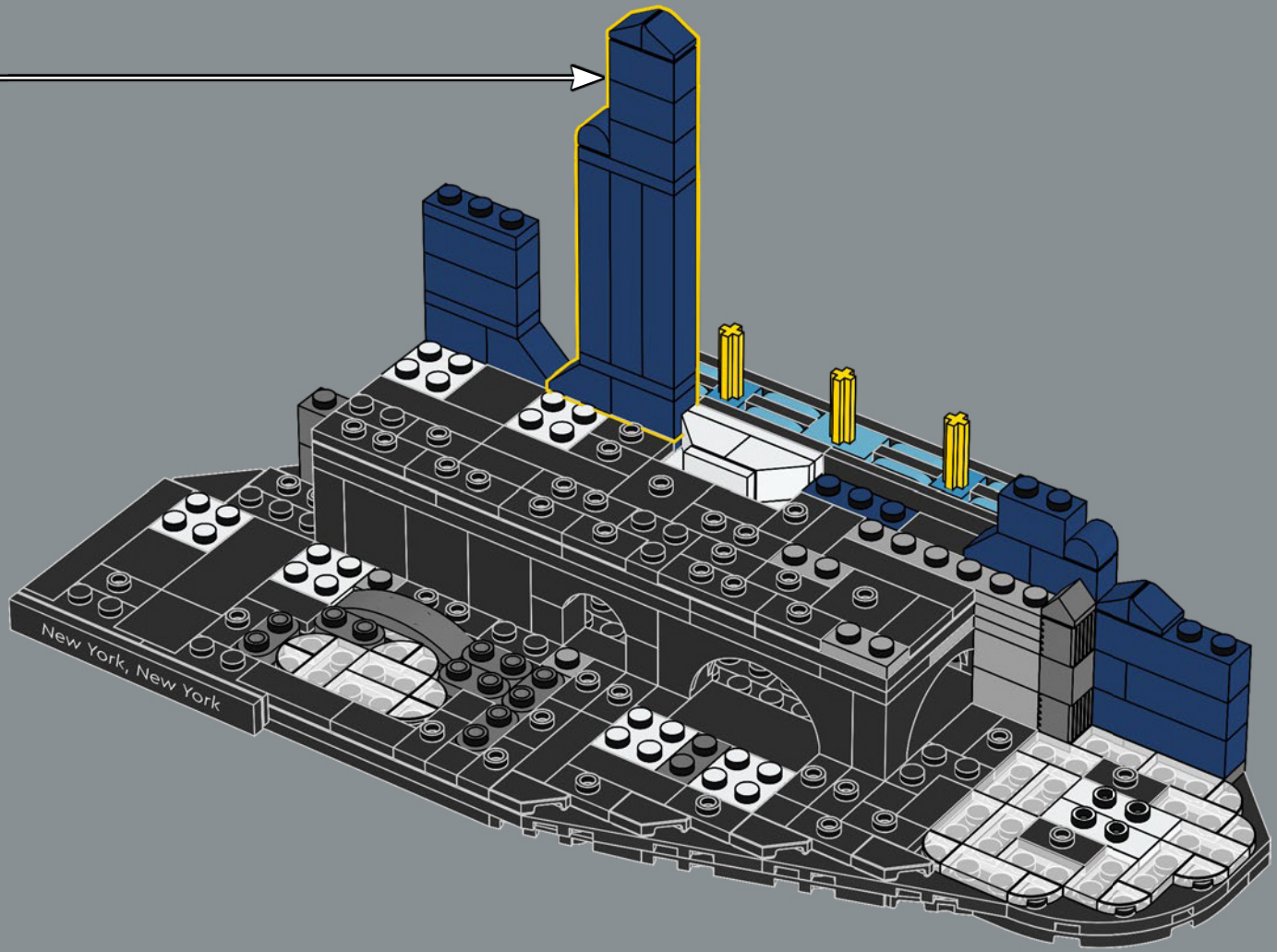

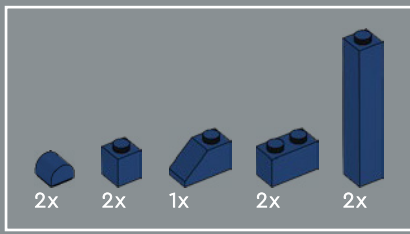

50

1

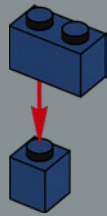

2

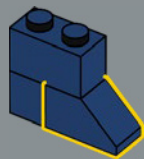

3

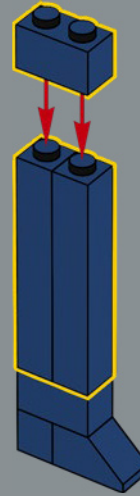

4

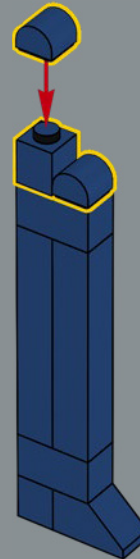

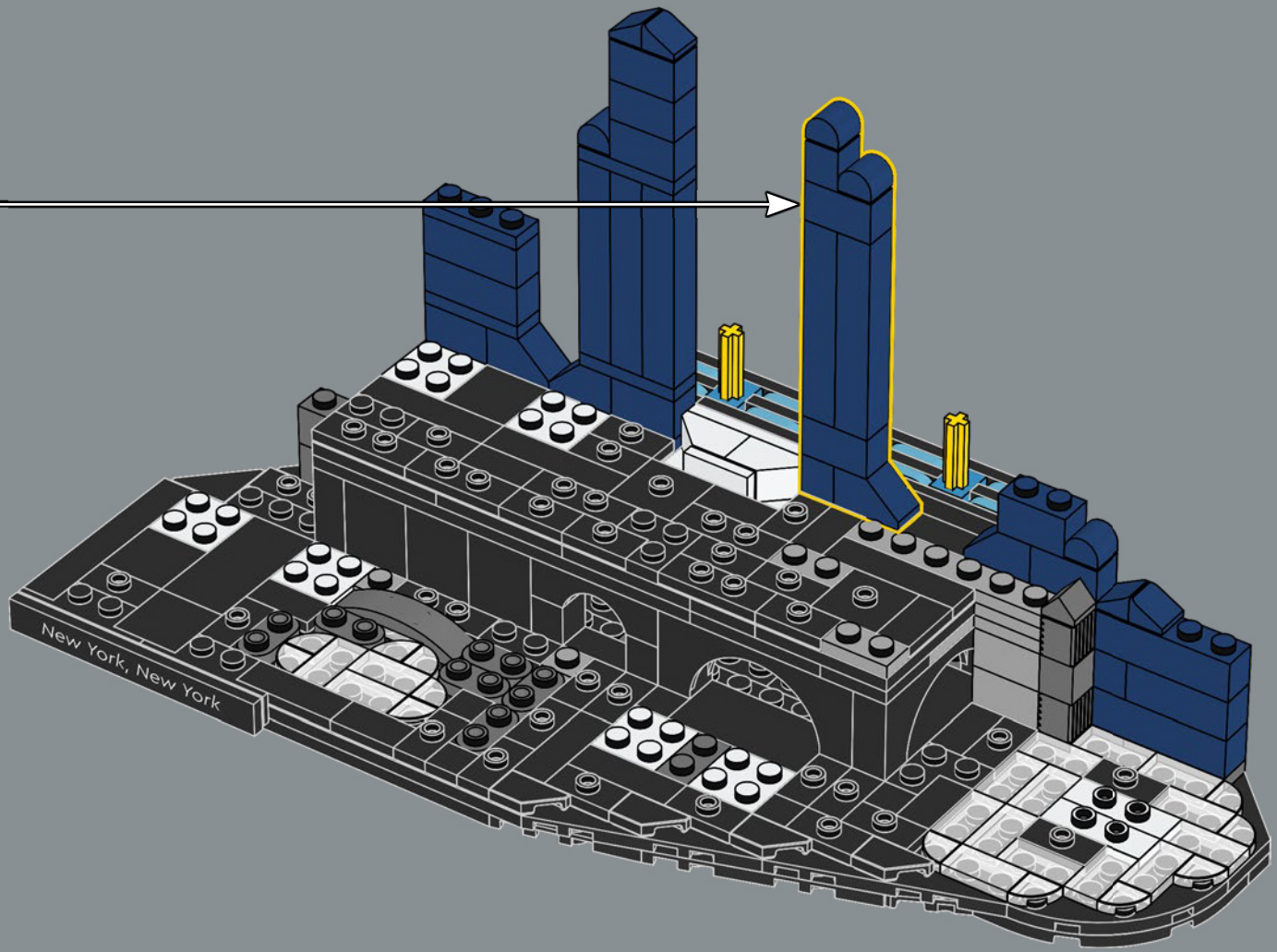

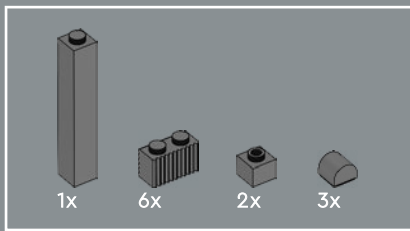

51

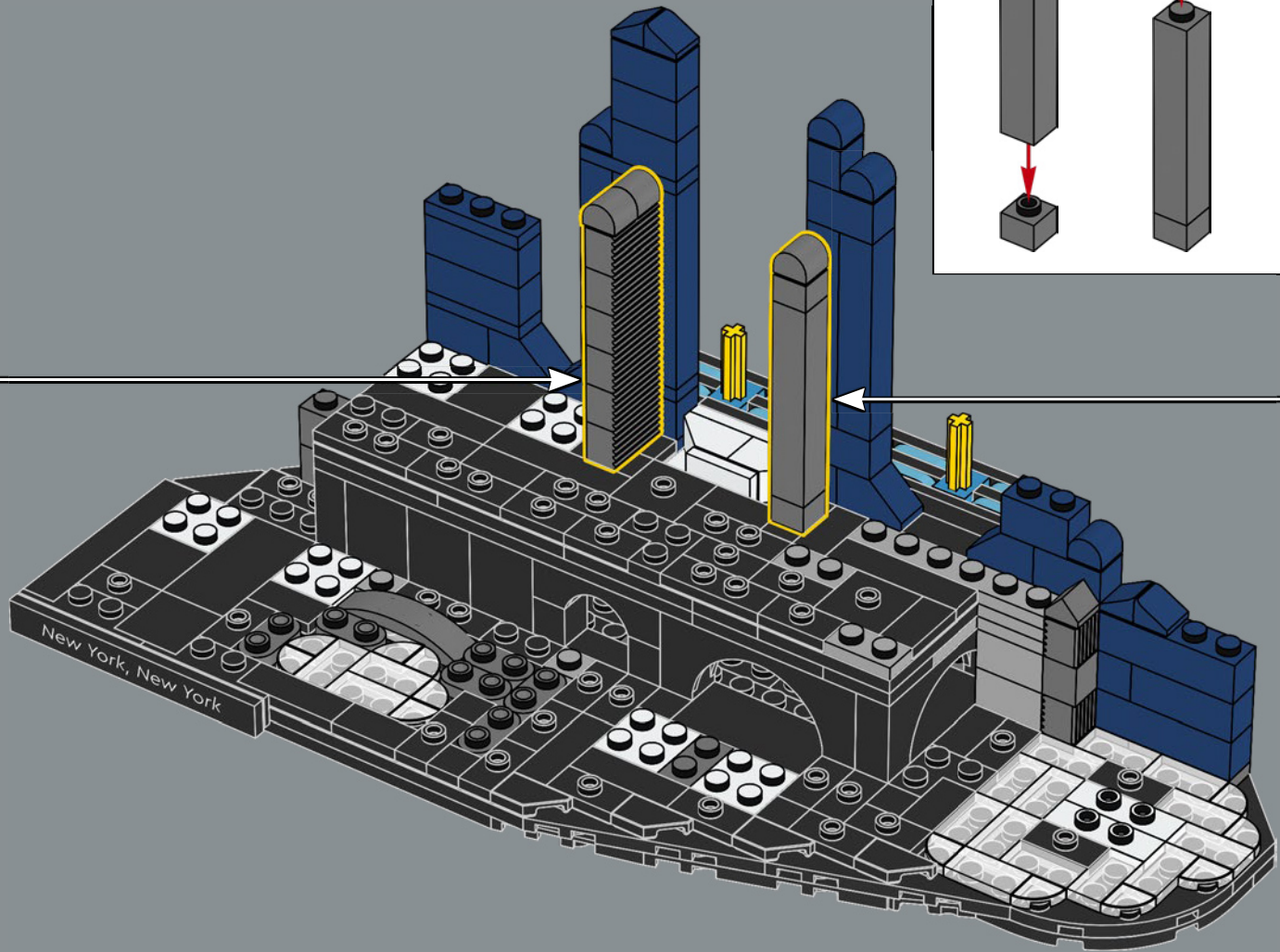
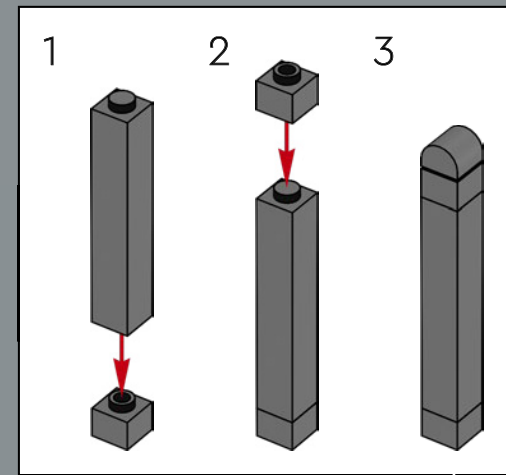
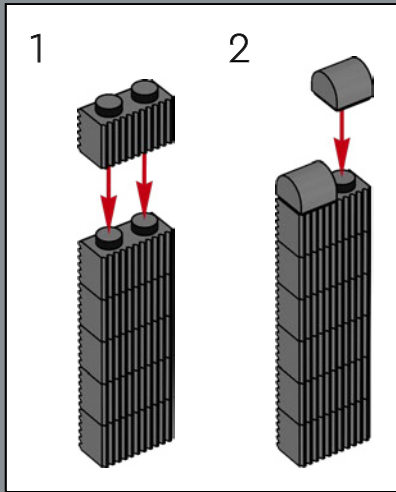

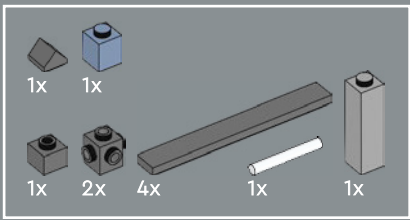

52

1

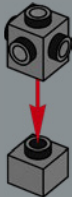

2



3



4



5

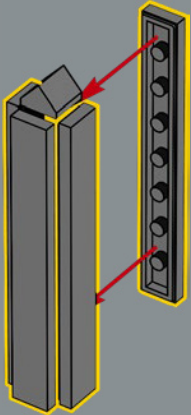

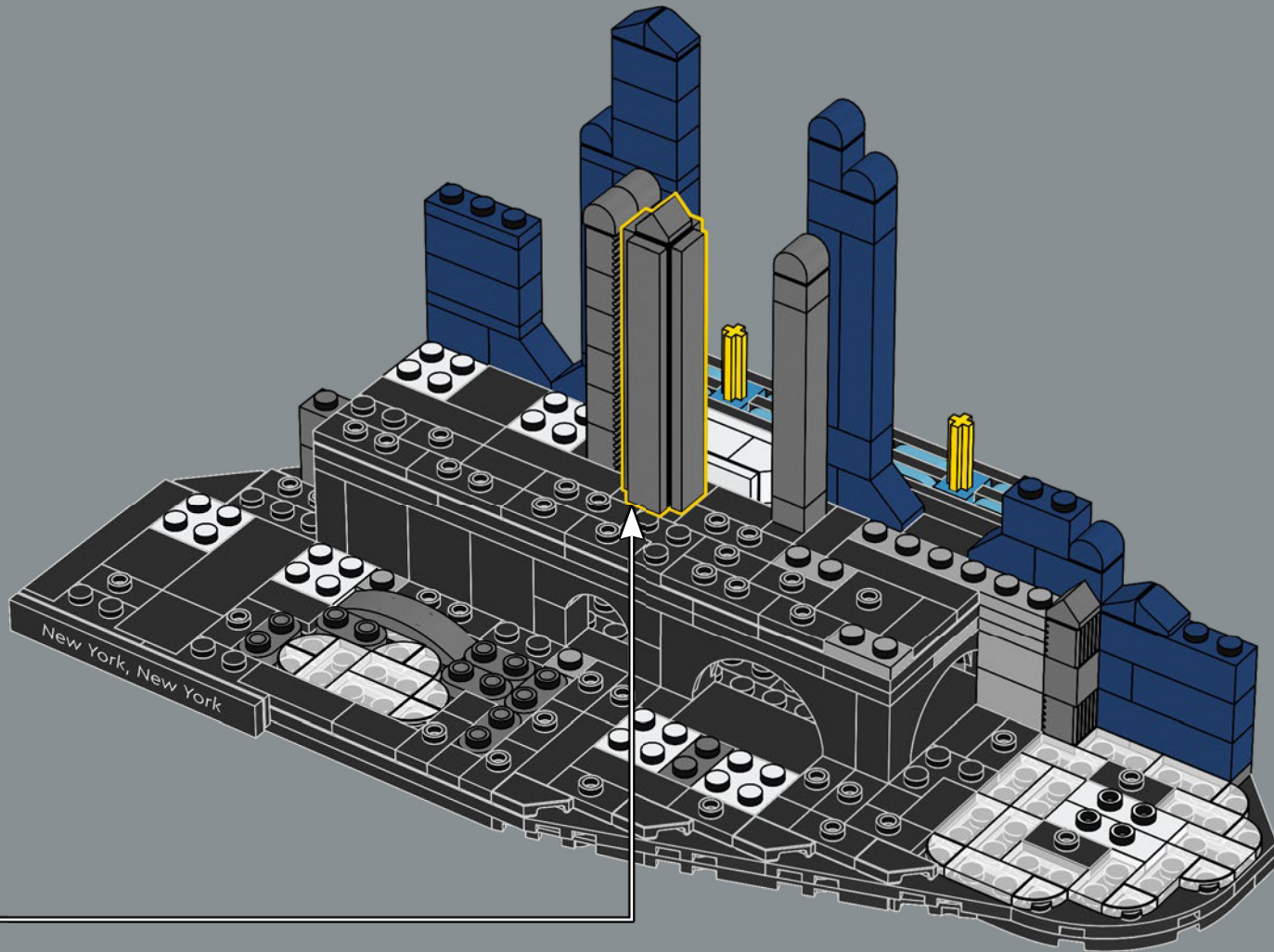

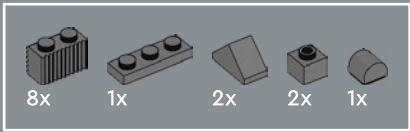

53

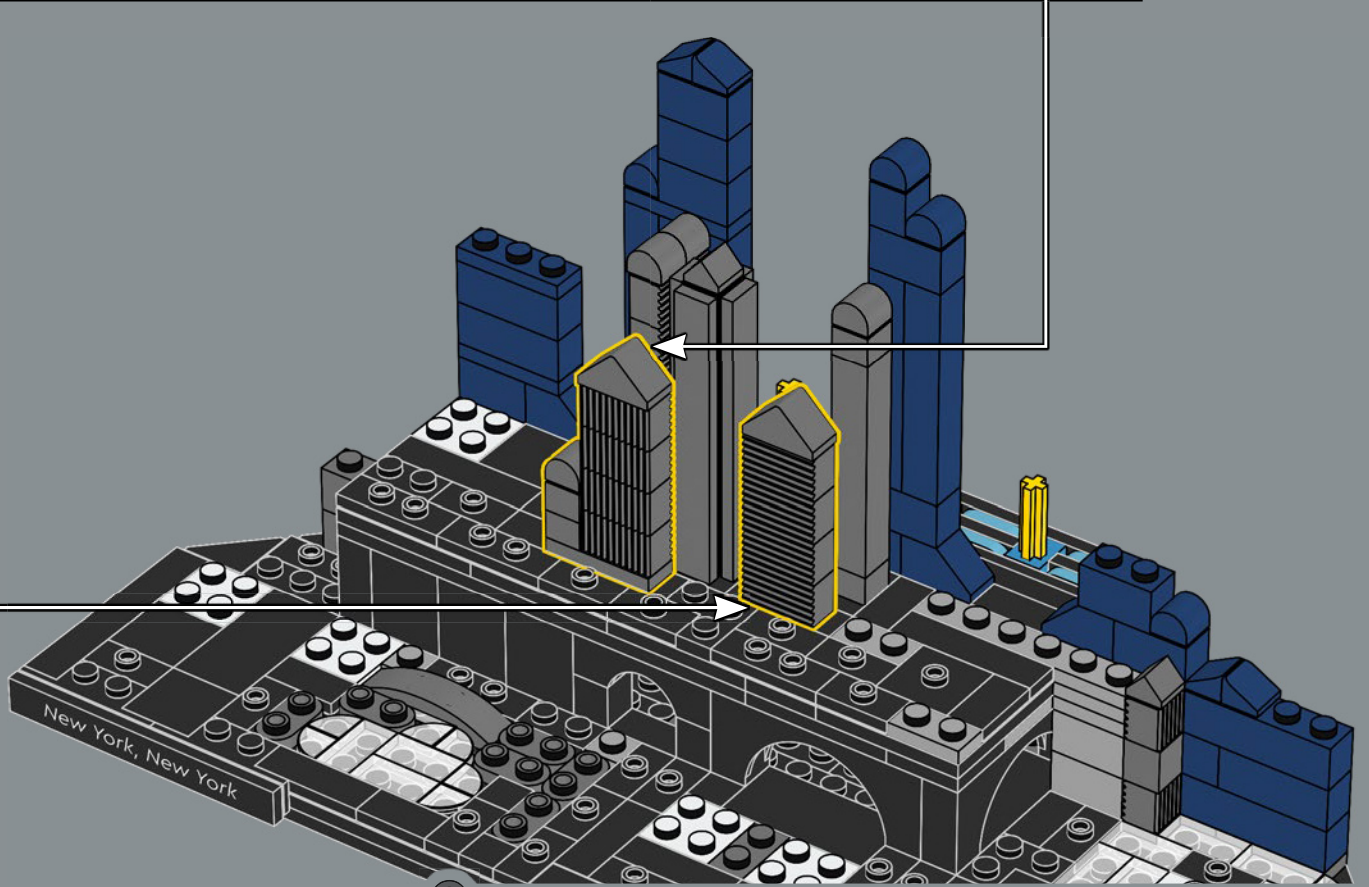
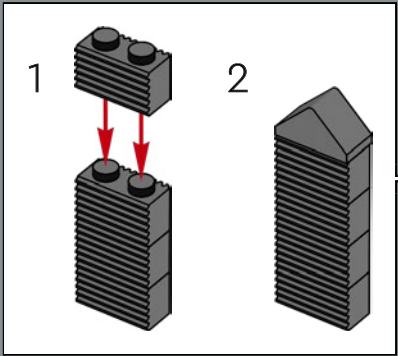
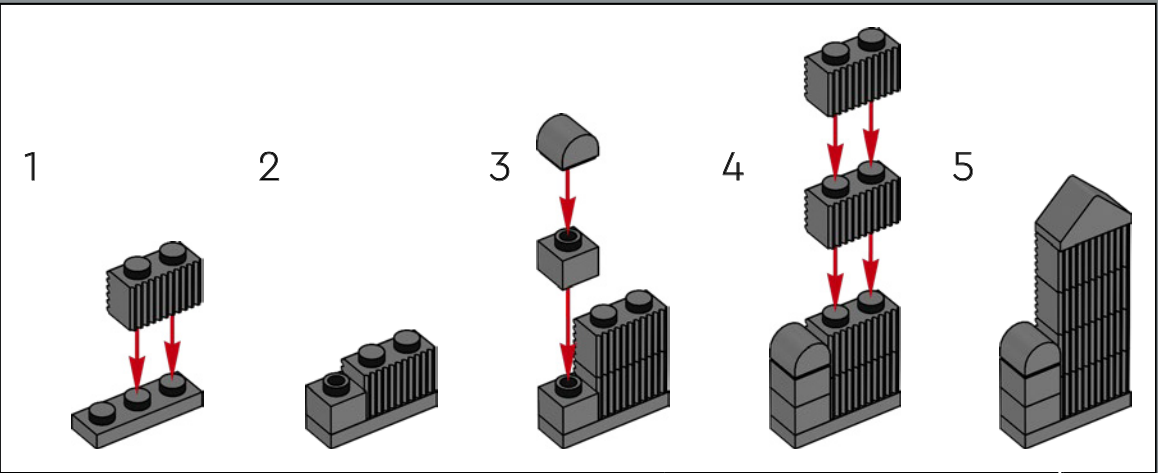

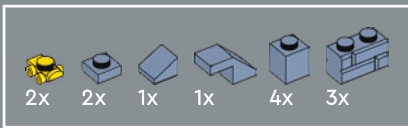

54

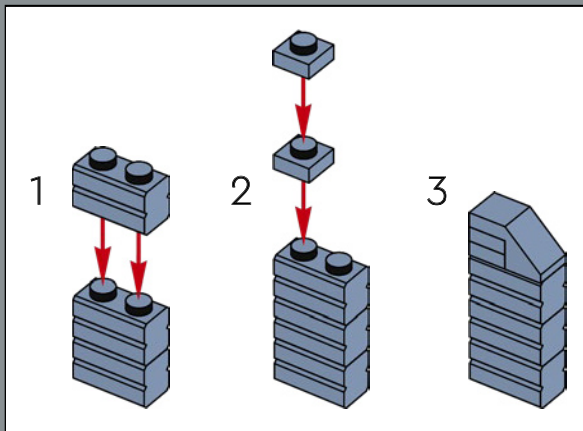

These yellow LEGO® minifigure roller-skate elements represent some of the more than 13,000 characteristic taxis in New York City.

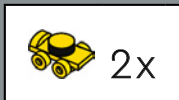
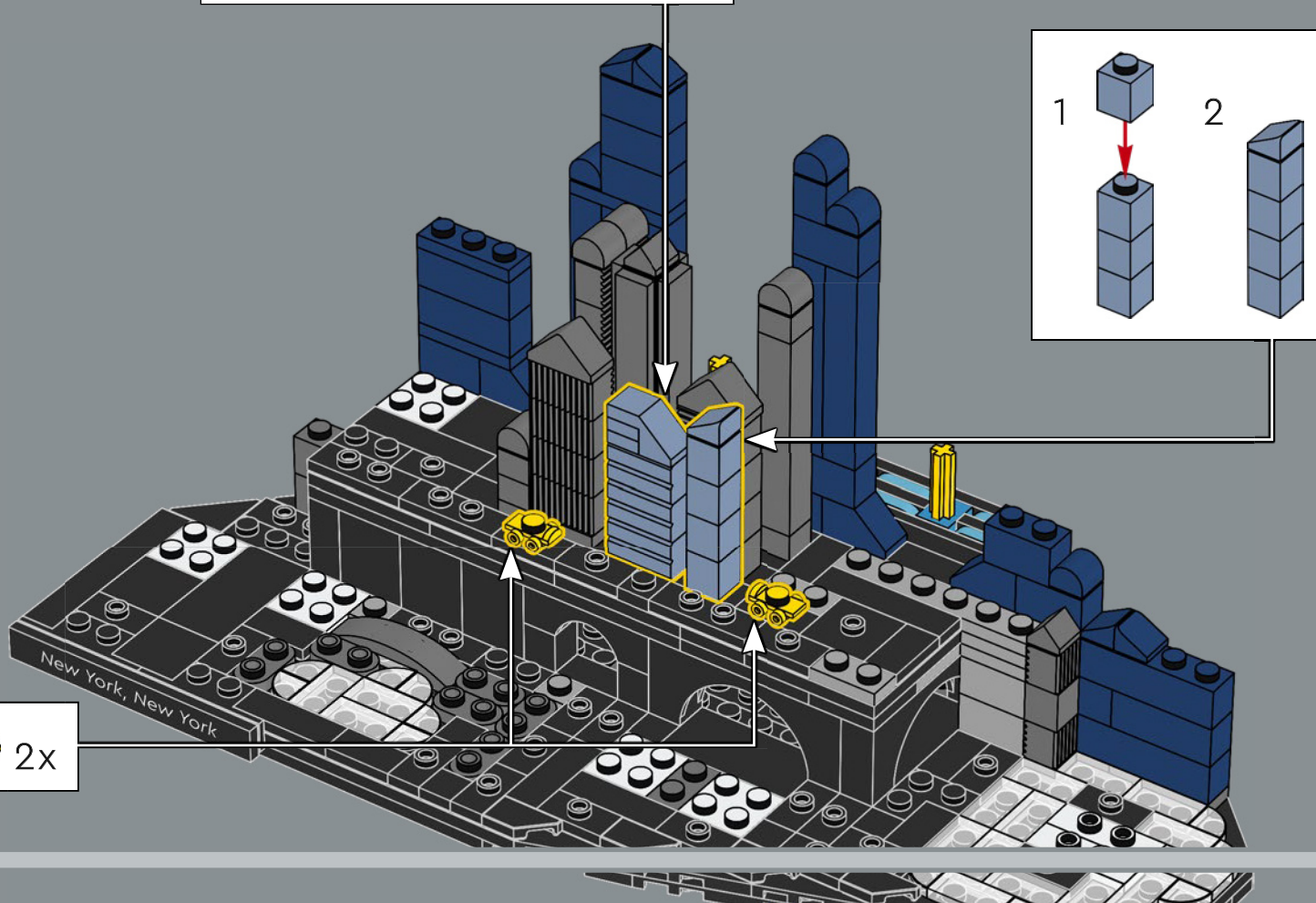

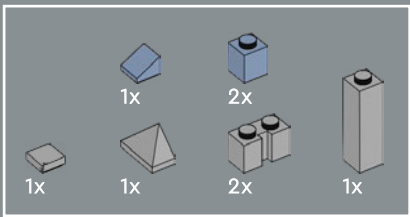

55

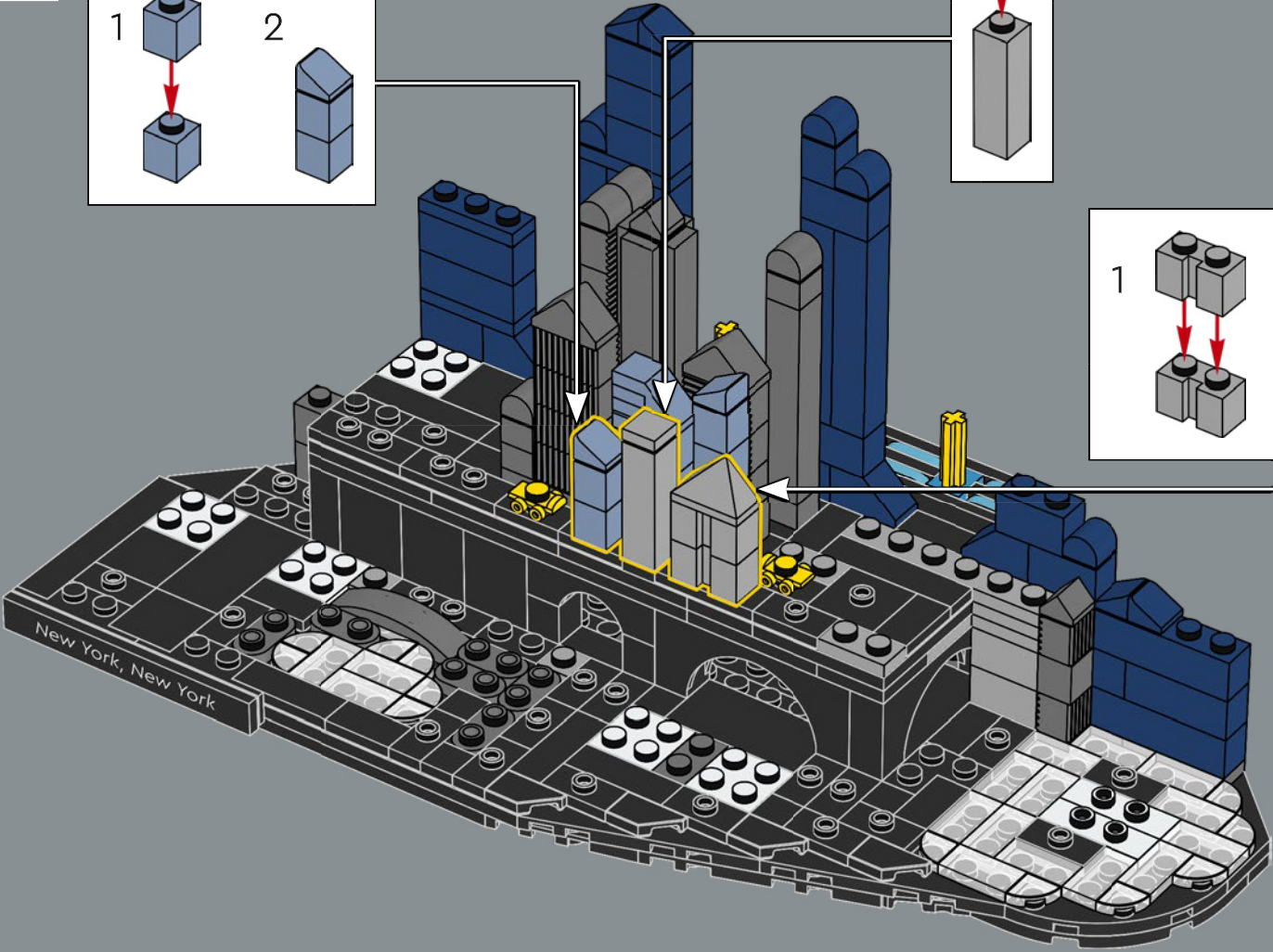
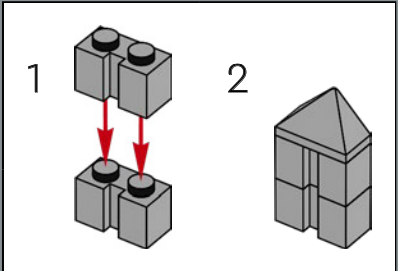
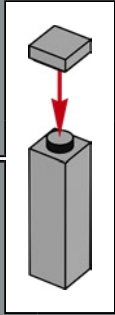
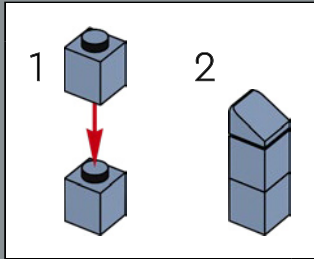

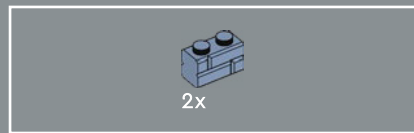

56

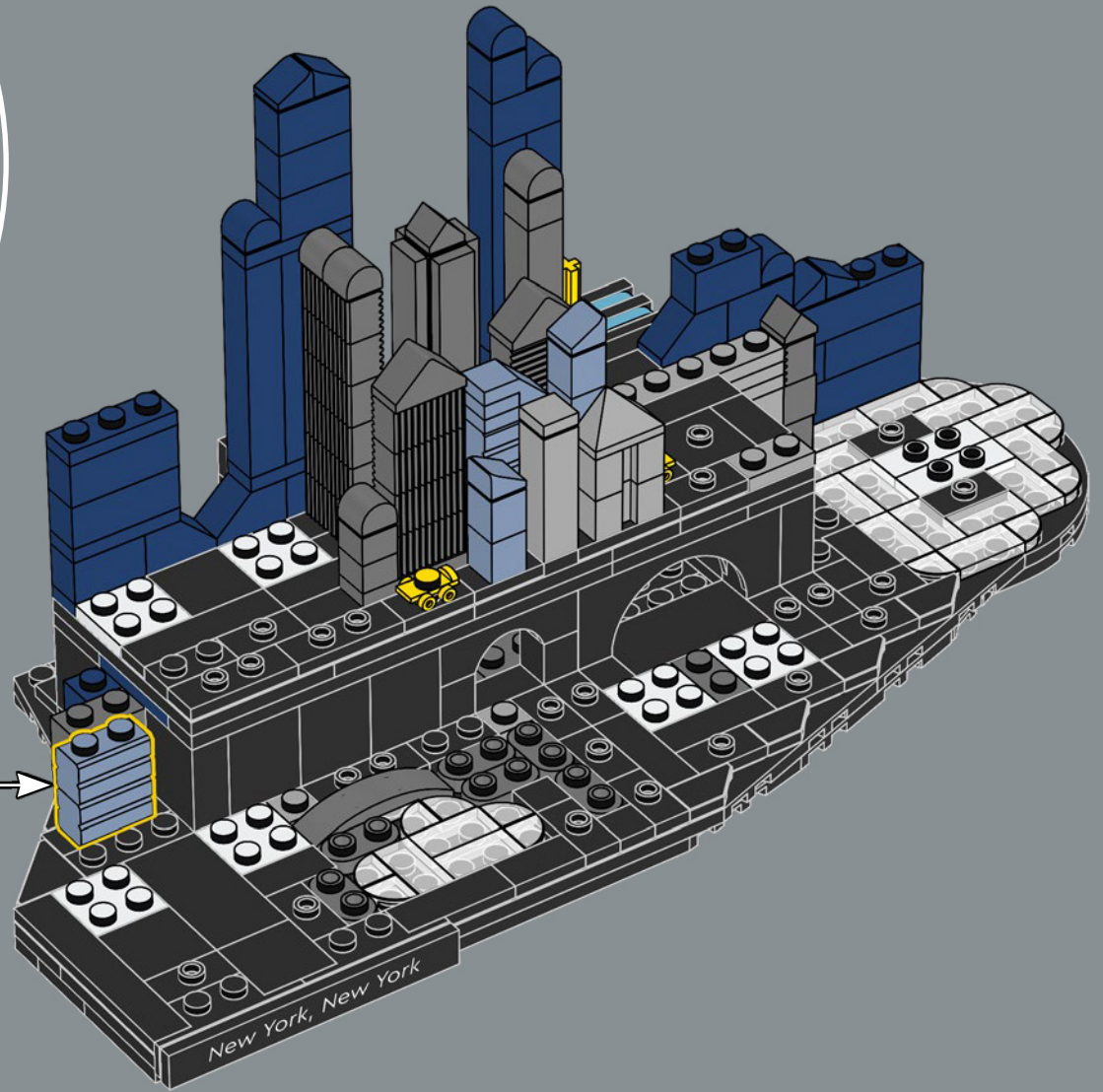
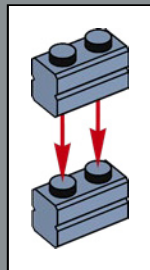

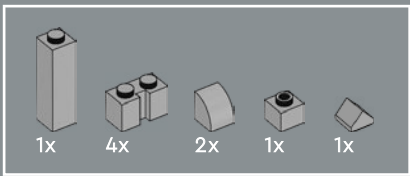

57

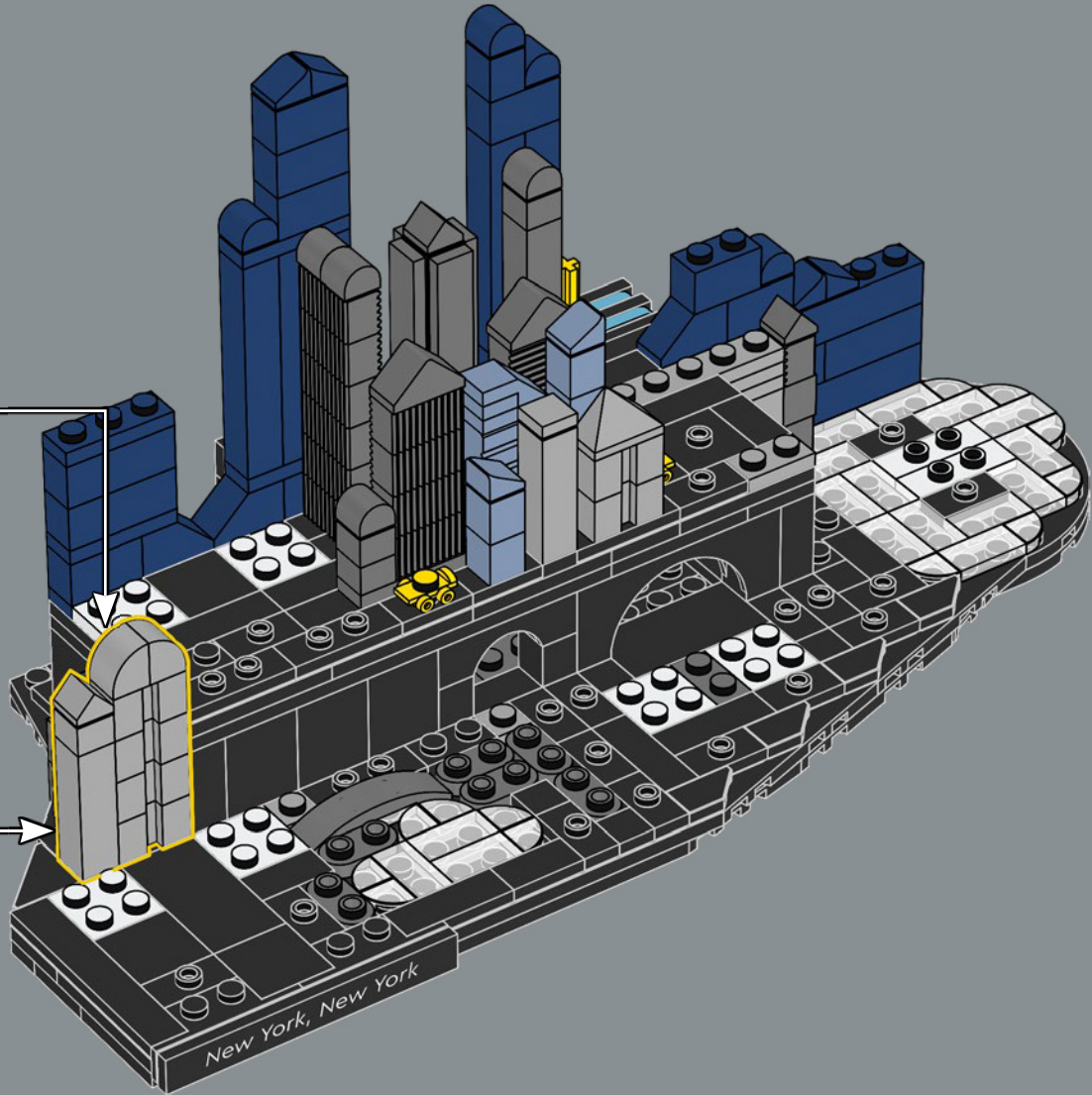
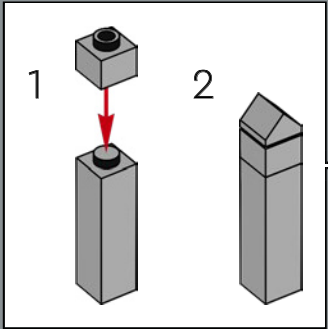
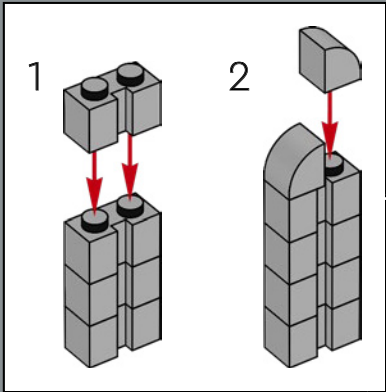

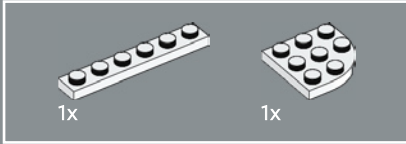
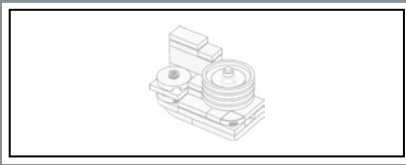

58

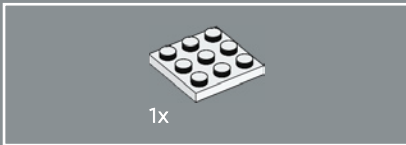
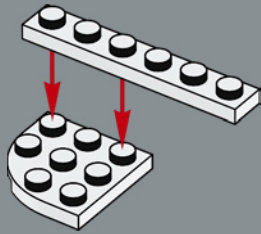

59

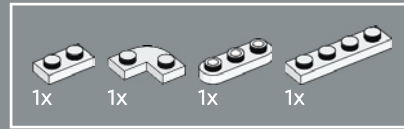
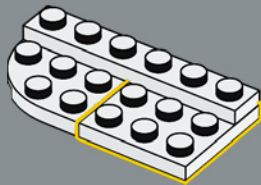

60

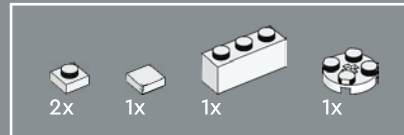
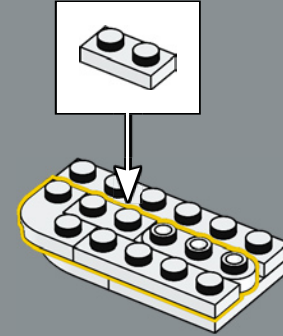

61

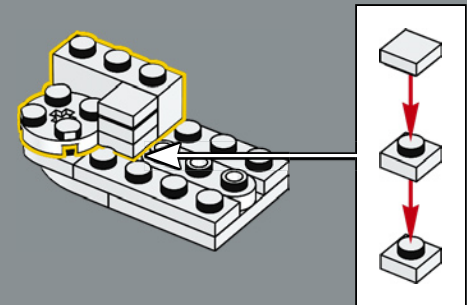

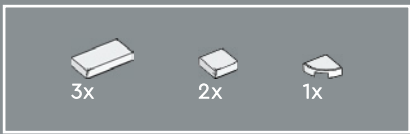

62

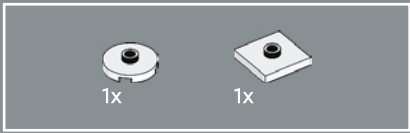
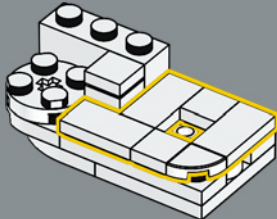

63

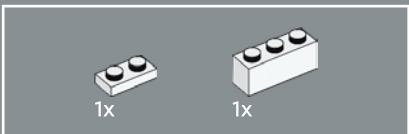
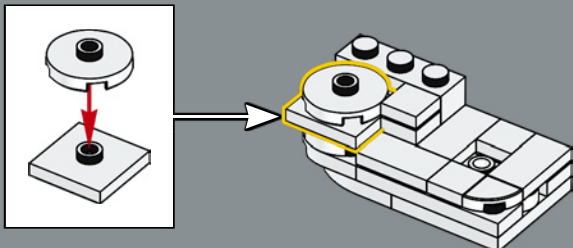

64

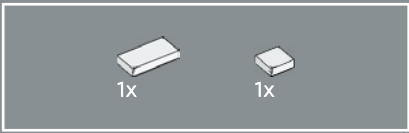
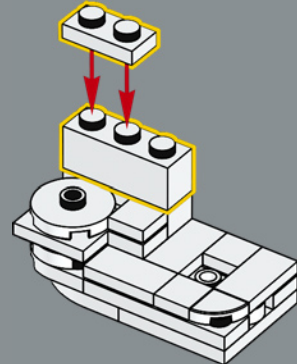

65

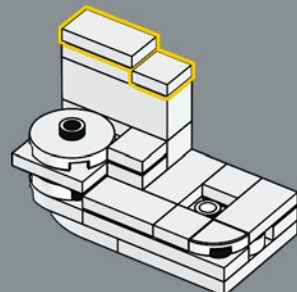

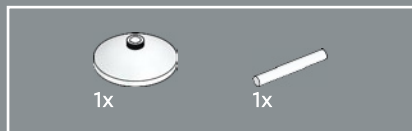

66

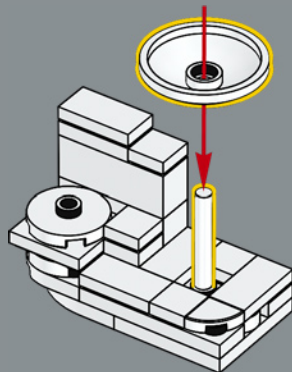

67

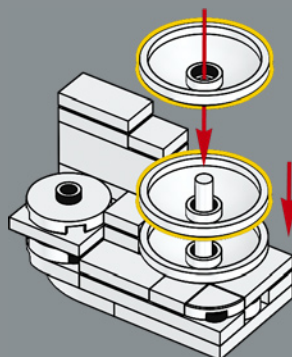

68

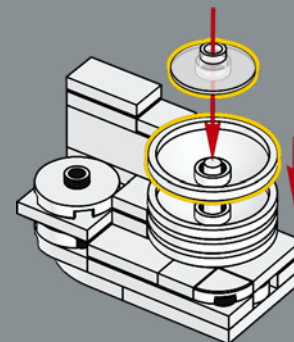

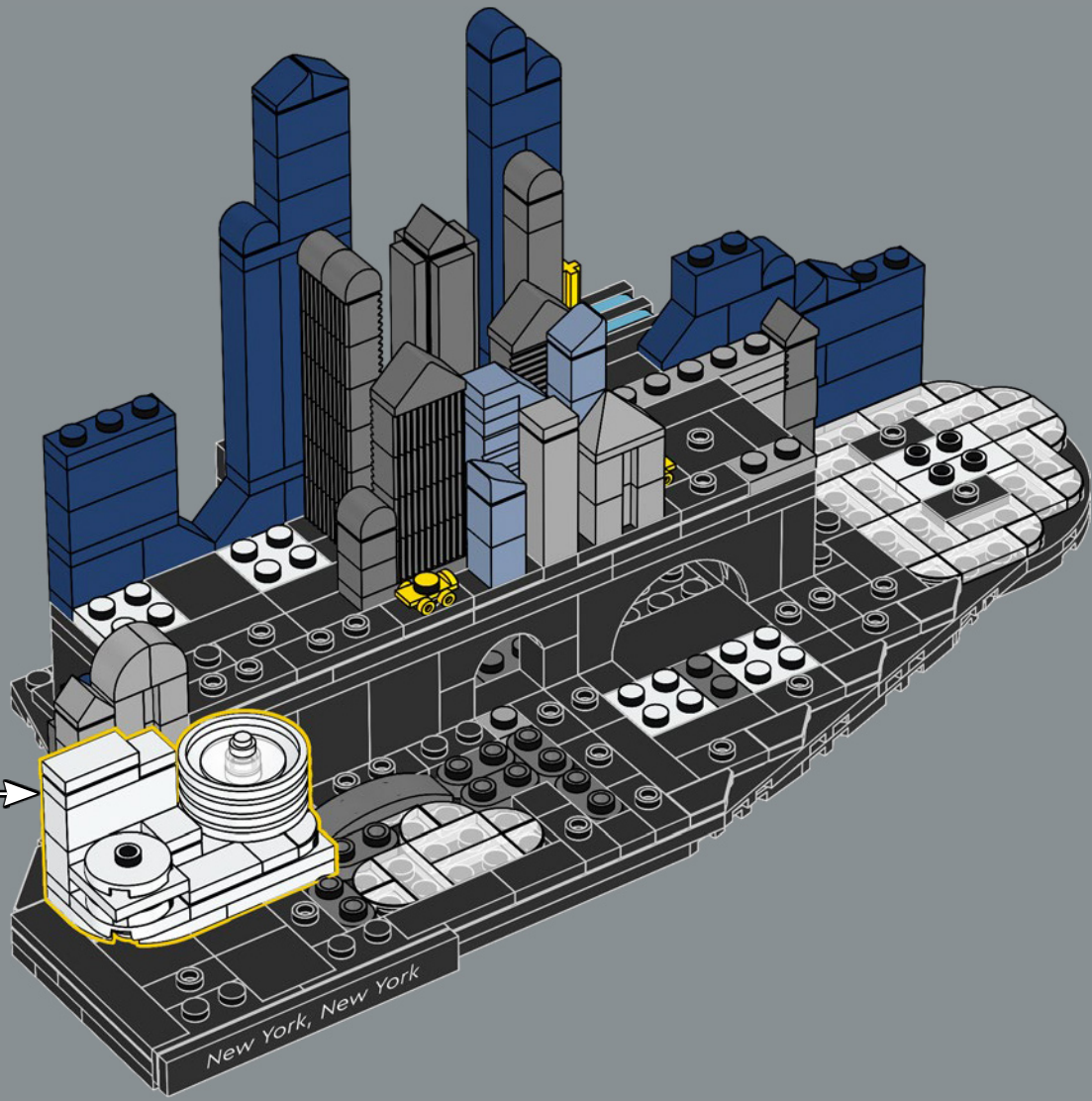

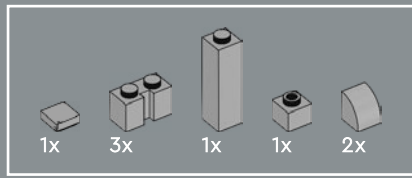

70

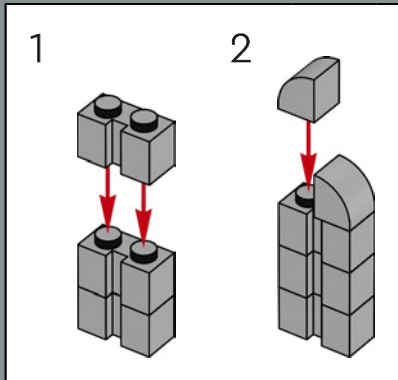
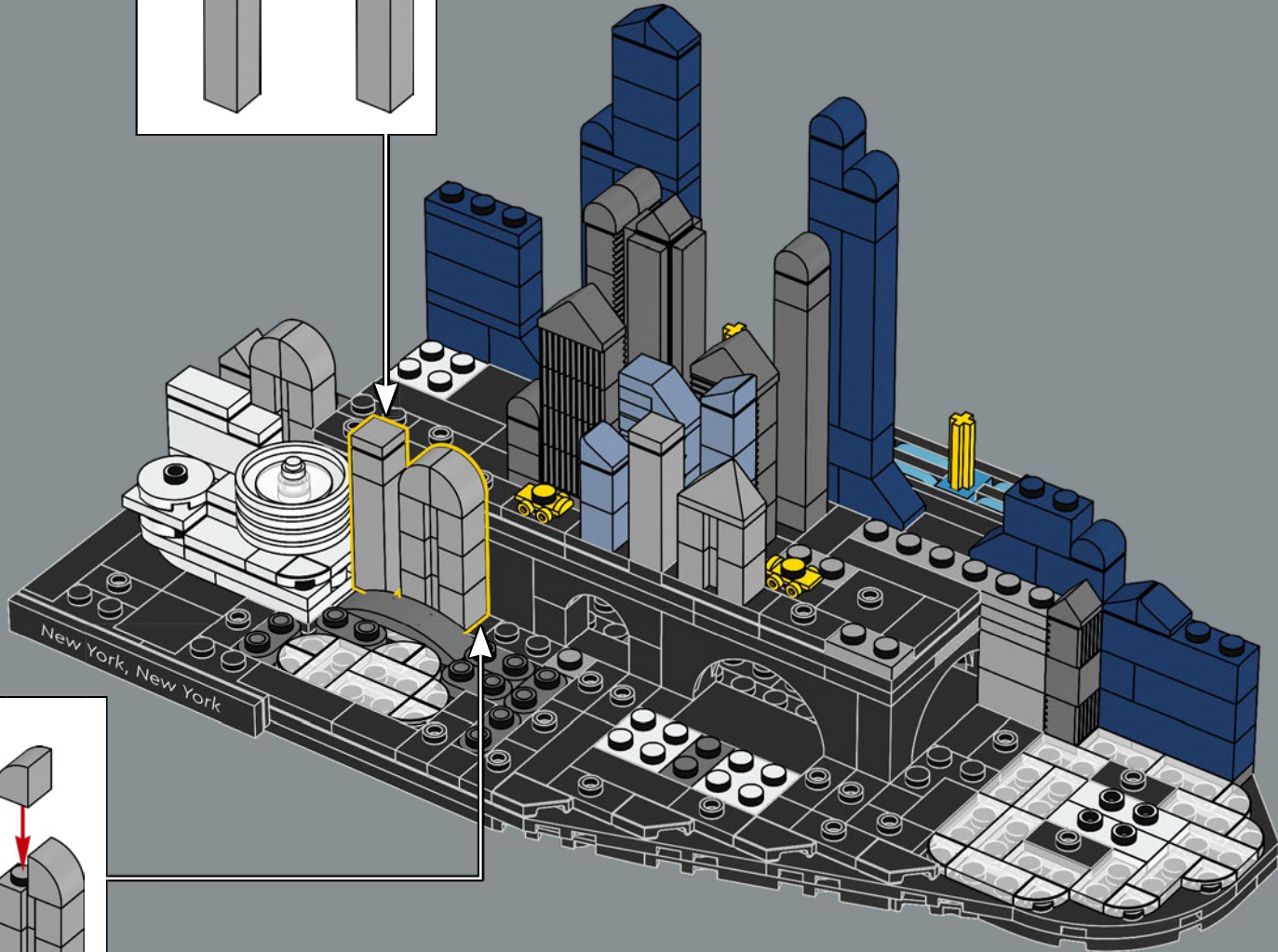
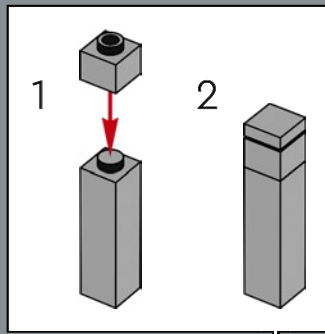

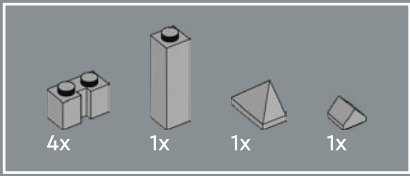

71

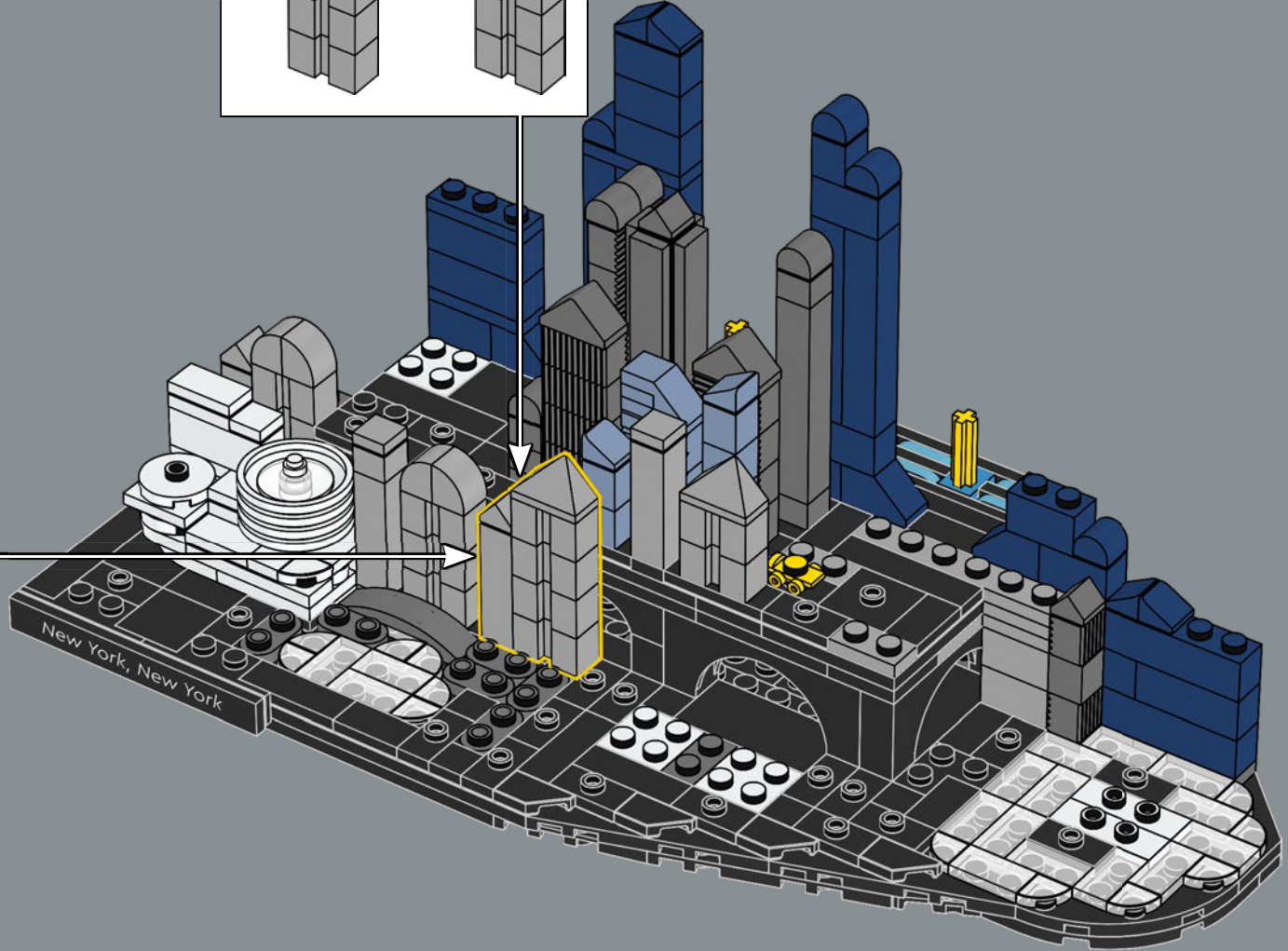
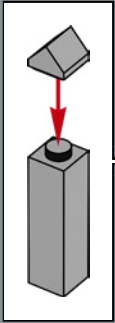
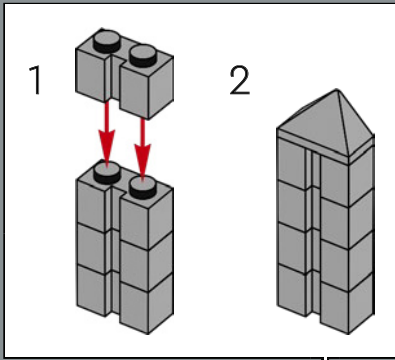

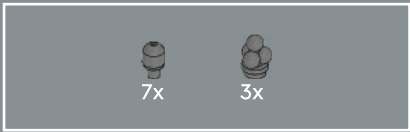

72

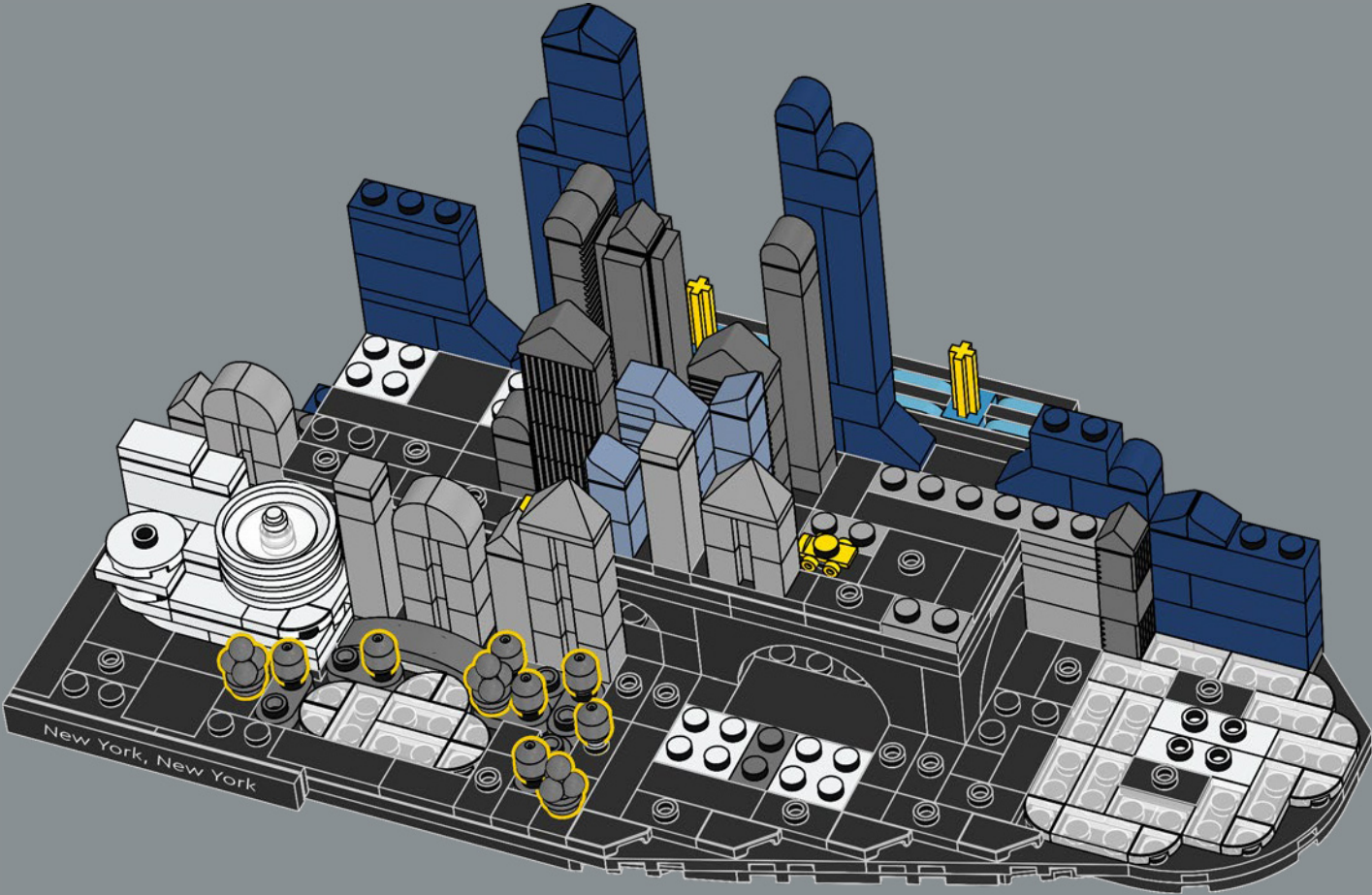



LEGO® ice cream elements, blades and globes are used here to make up some of the estimated 18,000 trees in Central Park.

73

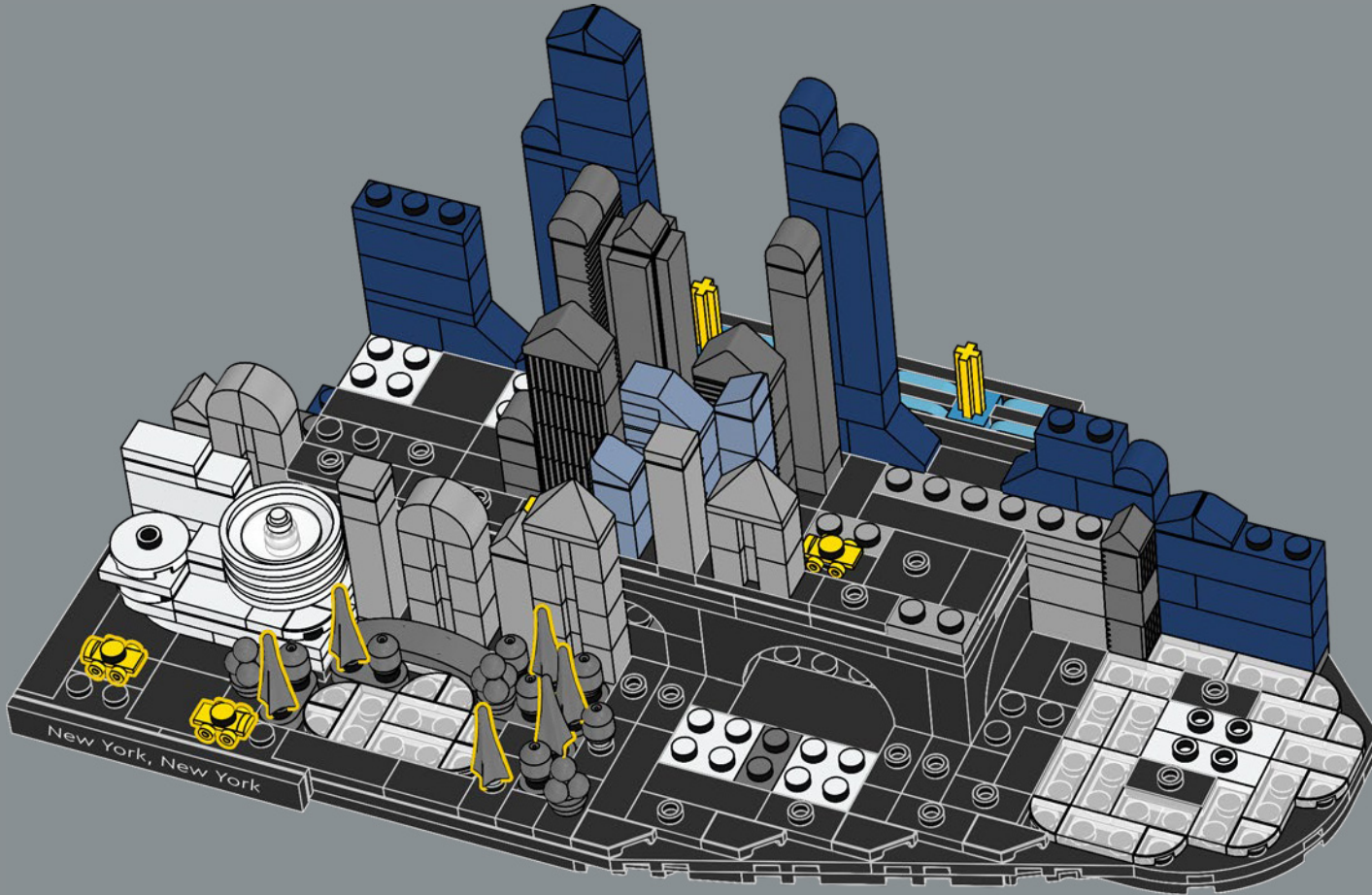

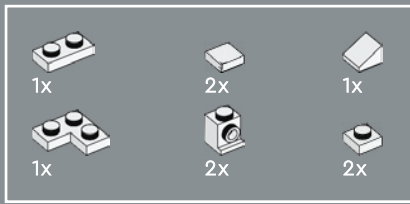

74

1

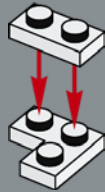

2



3

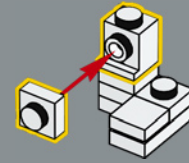

4

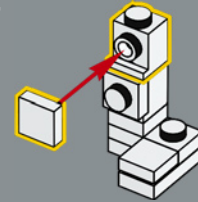

5

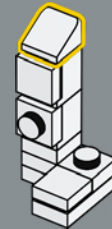

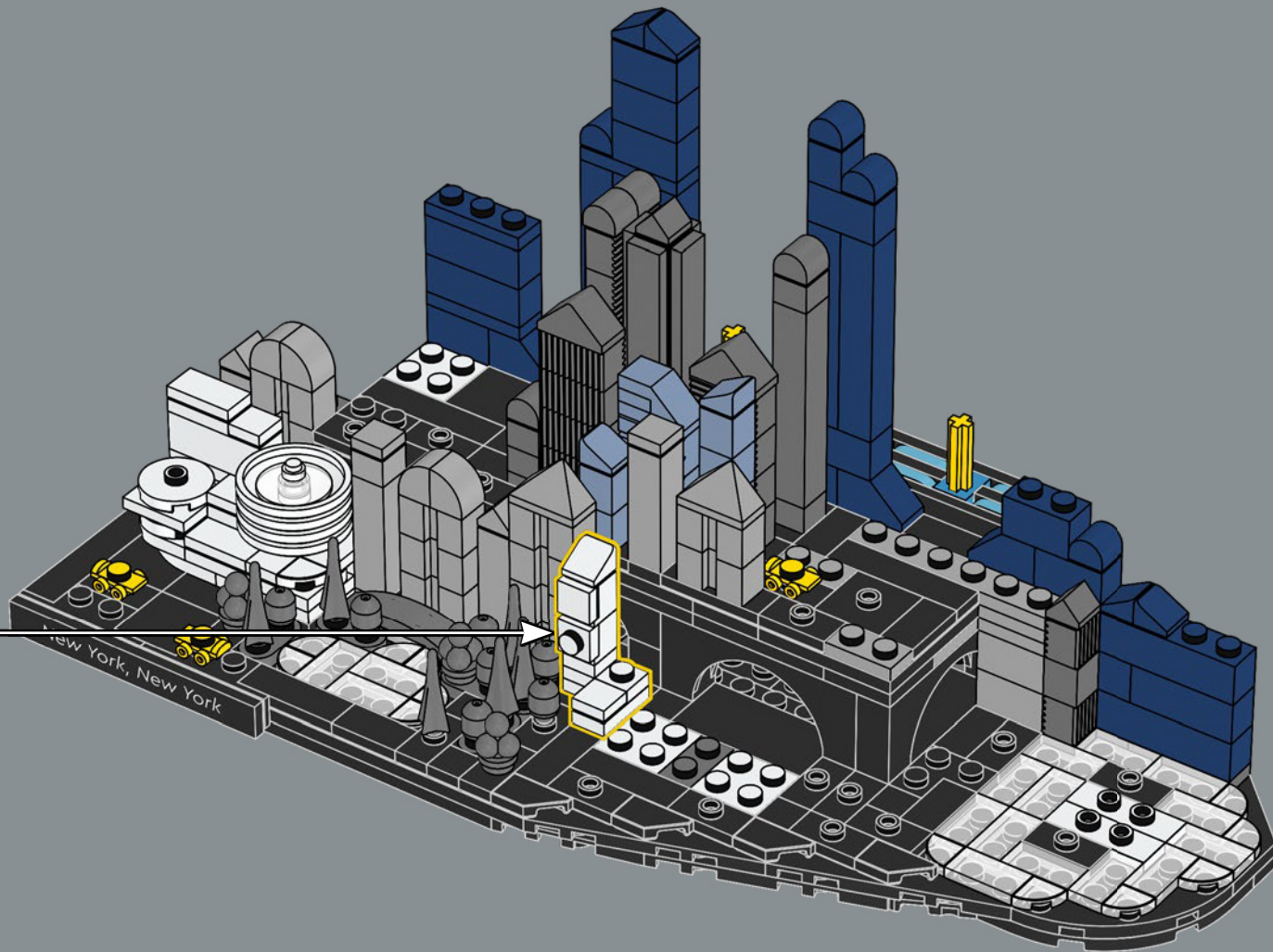



75

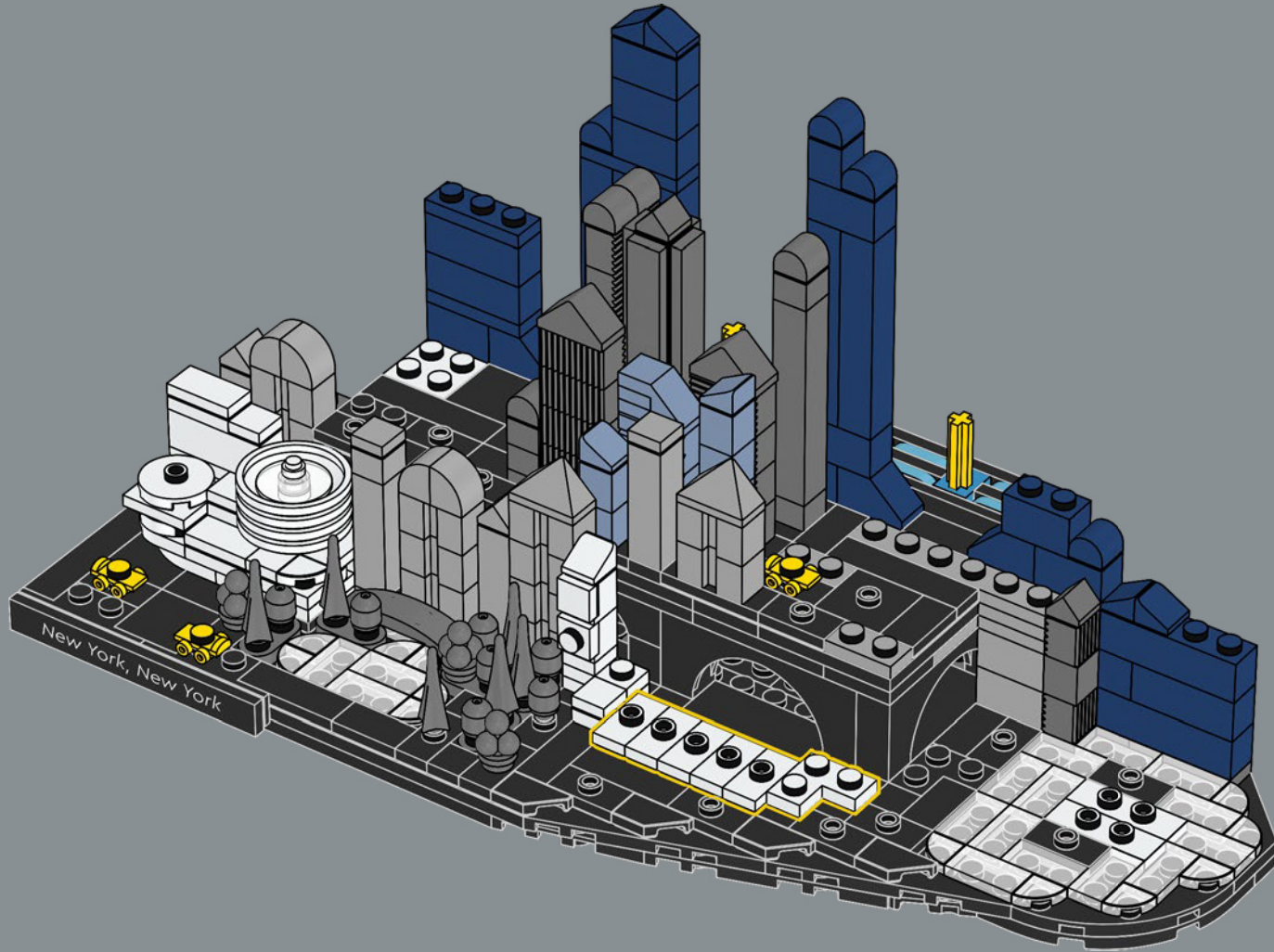

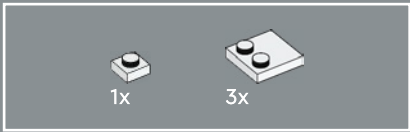

76

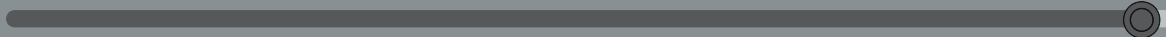
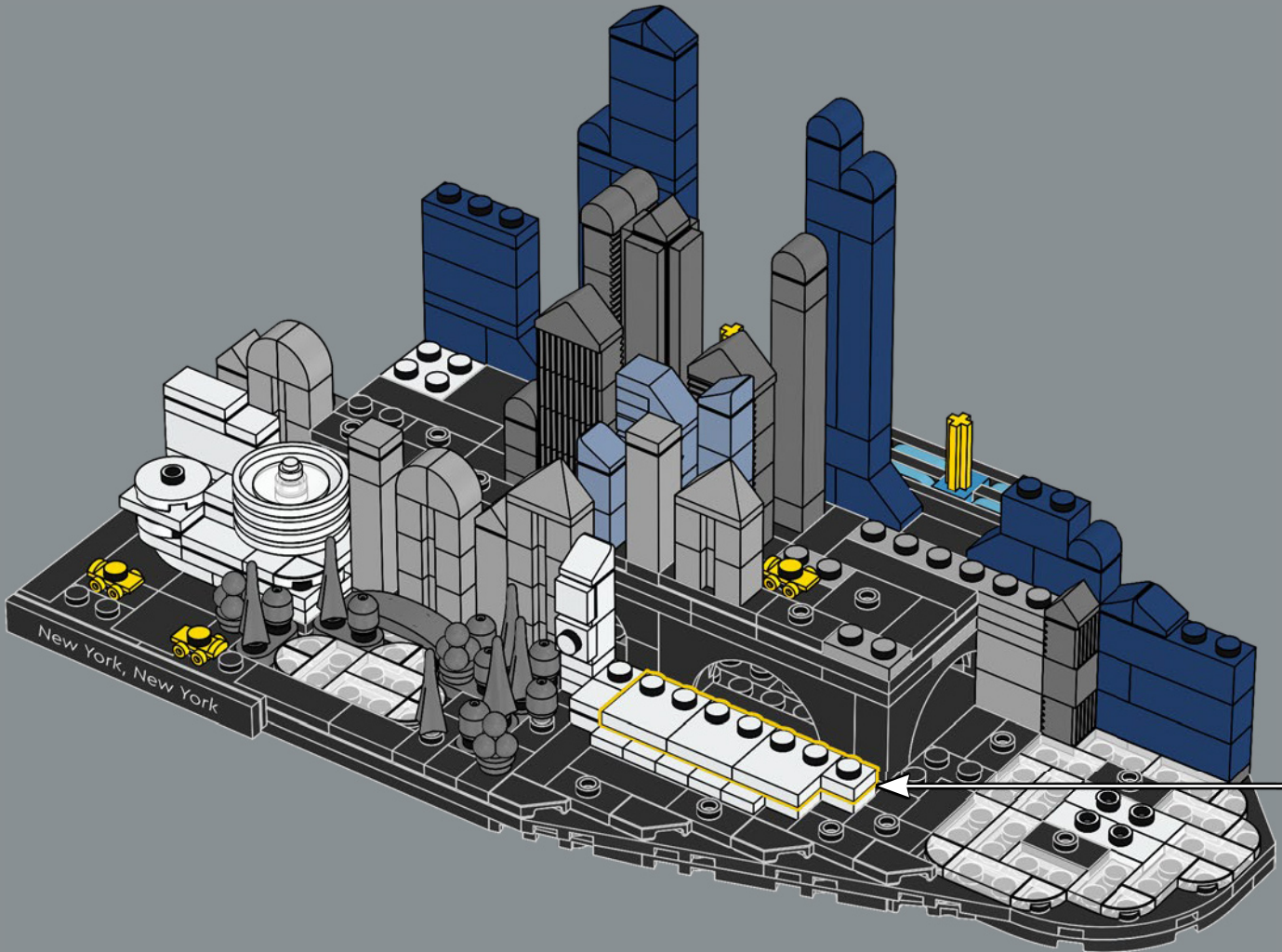

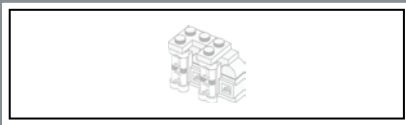

77

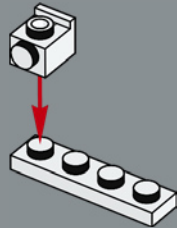

78

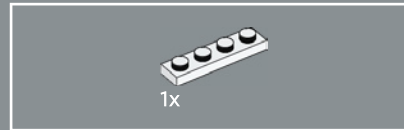
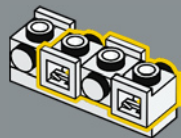

79

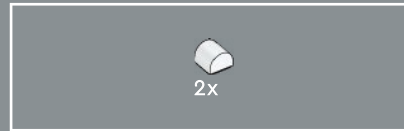
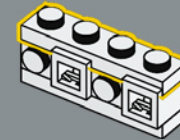

80

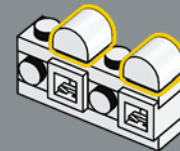

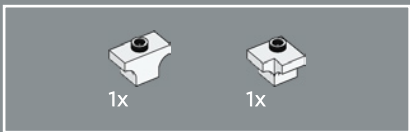

81

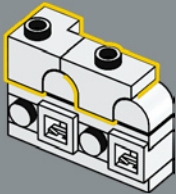

82

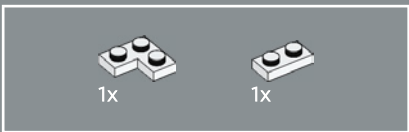
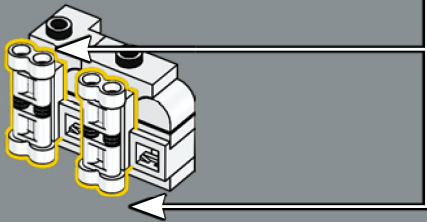
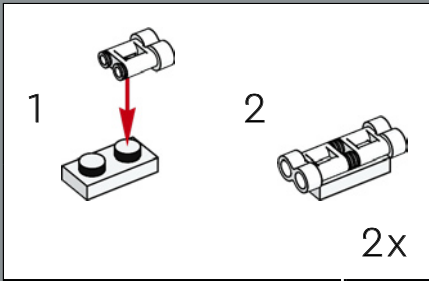

83

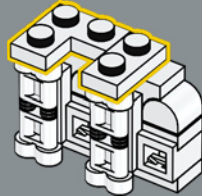

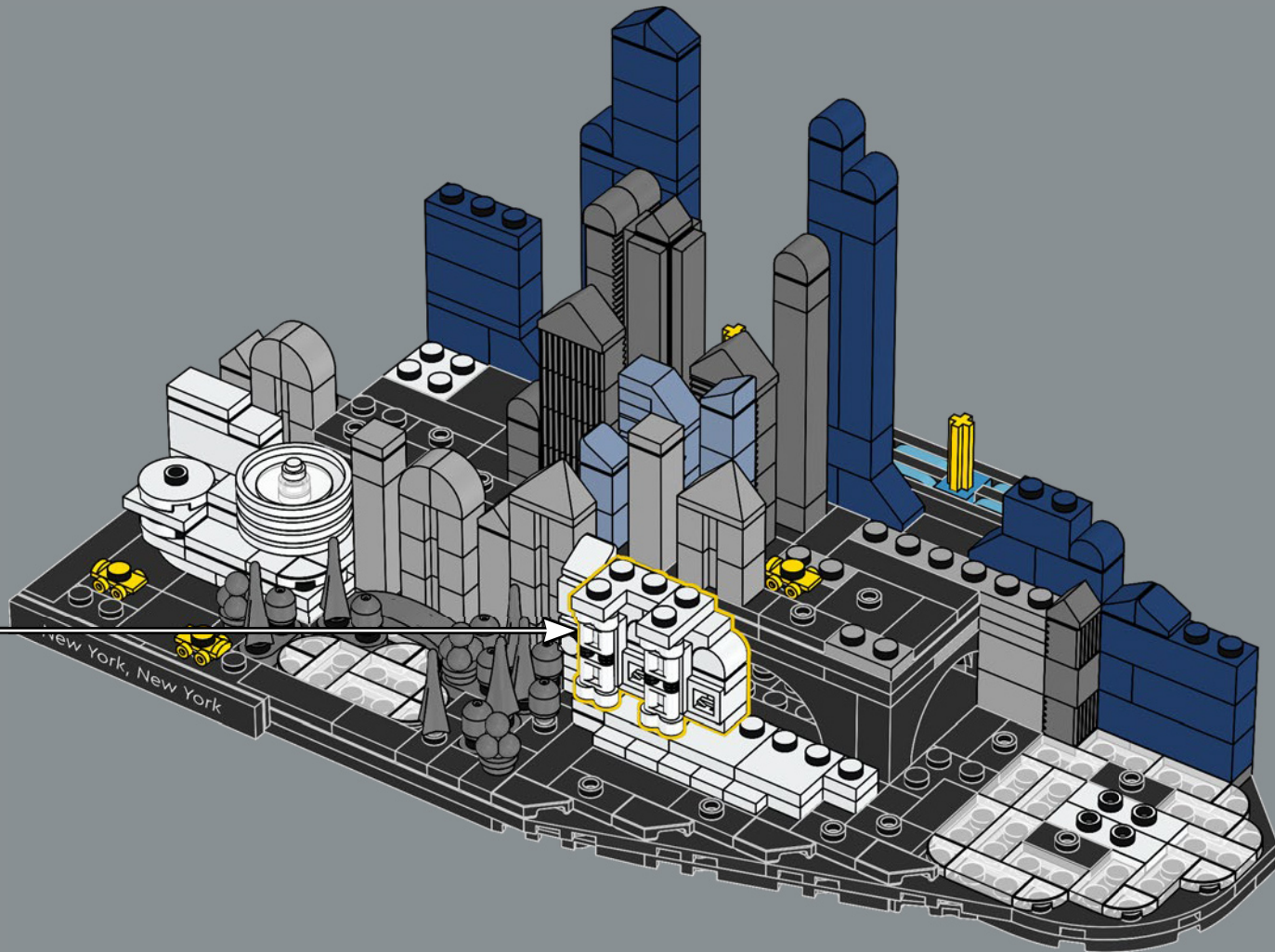

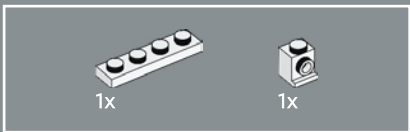

85

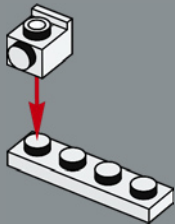

86

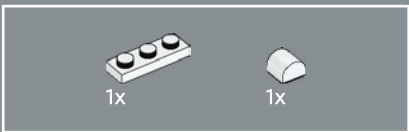
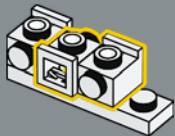

87

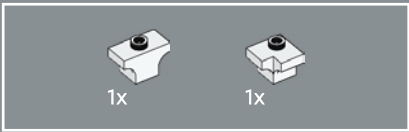
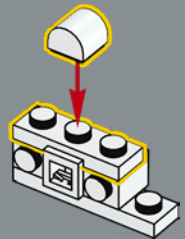

88

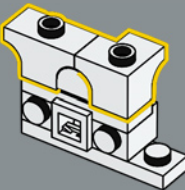

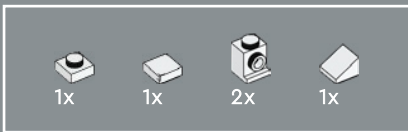

89

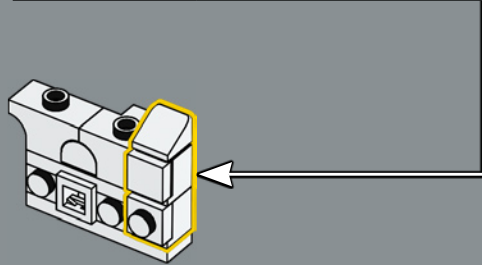
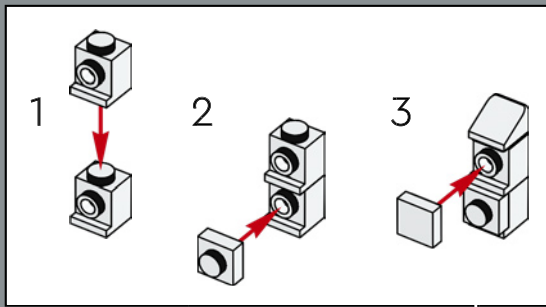

90

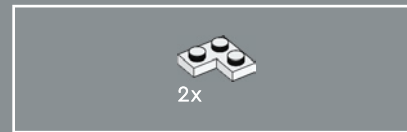
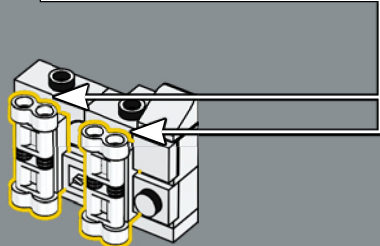
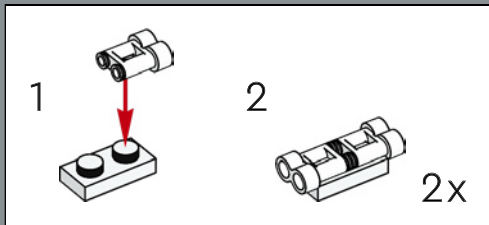

91

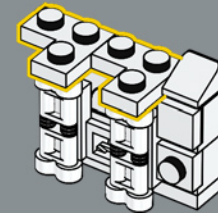

LEGO® binoculars create tiny pairs of columns that decorate the main entrance of the Metropolitan Museum of Art.

92

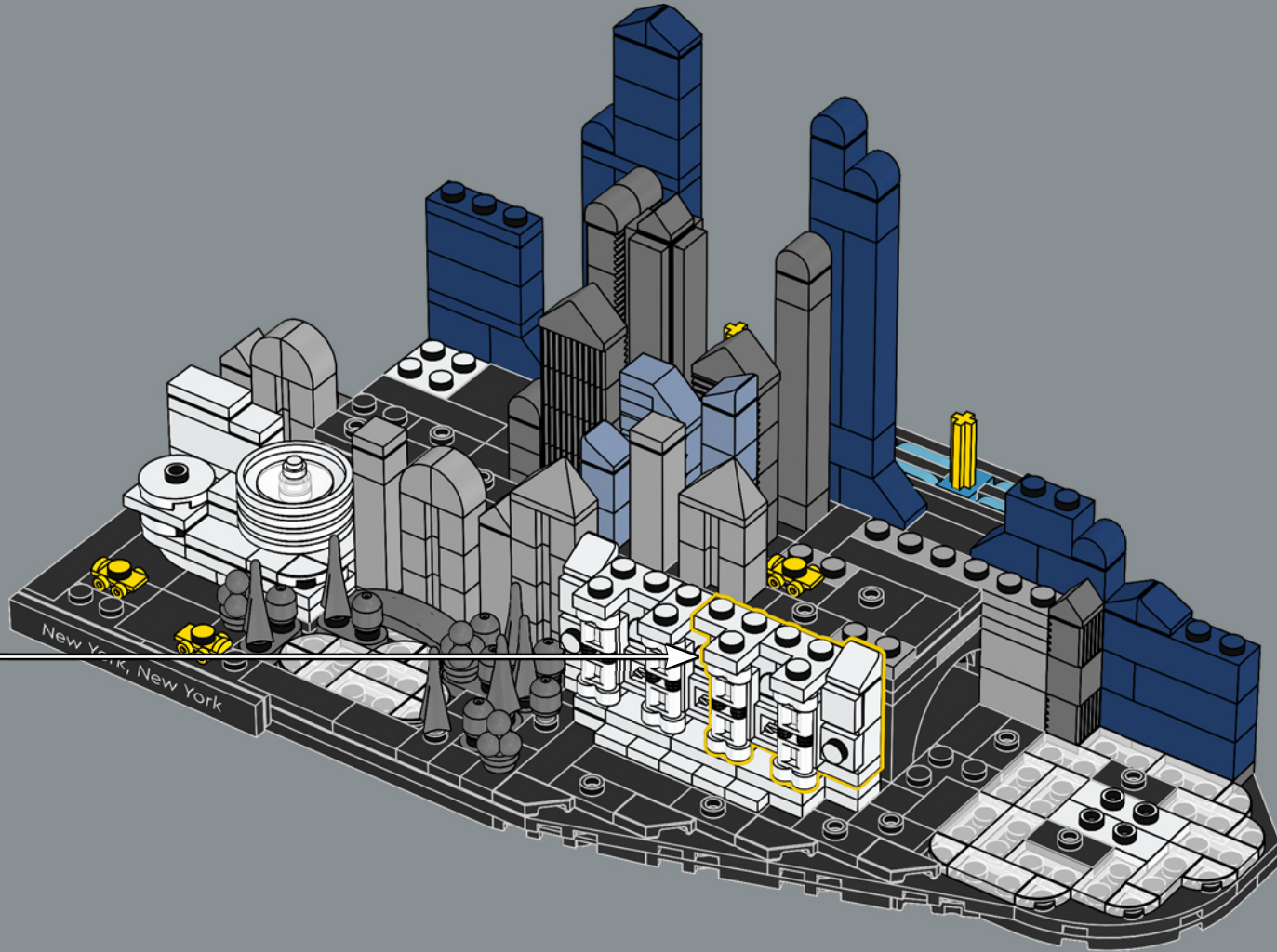

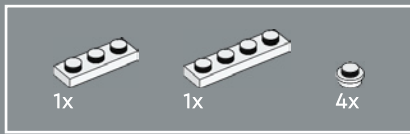

93

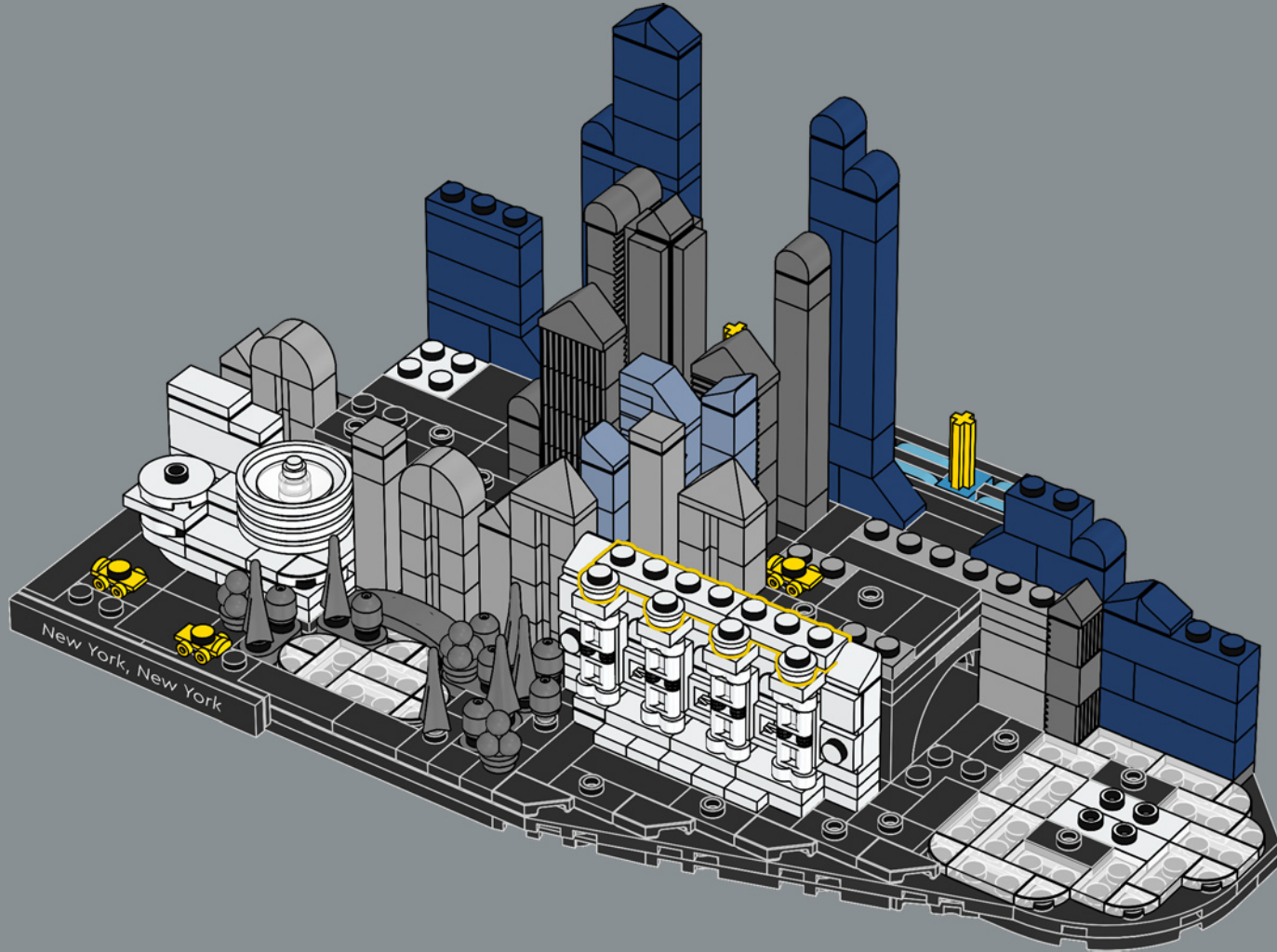

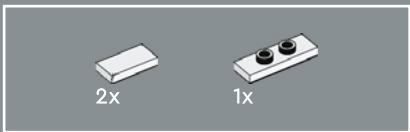

94

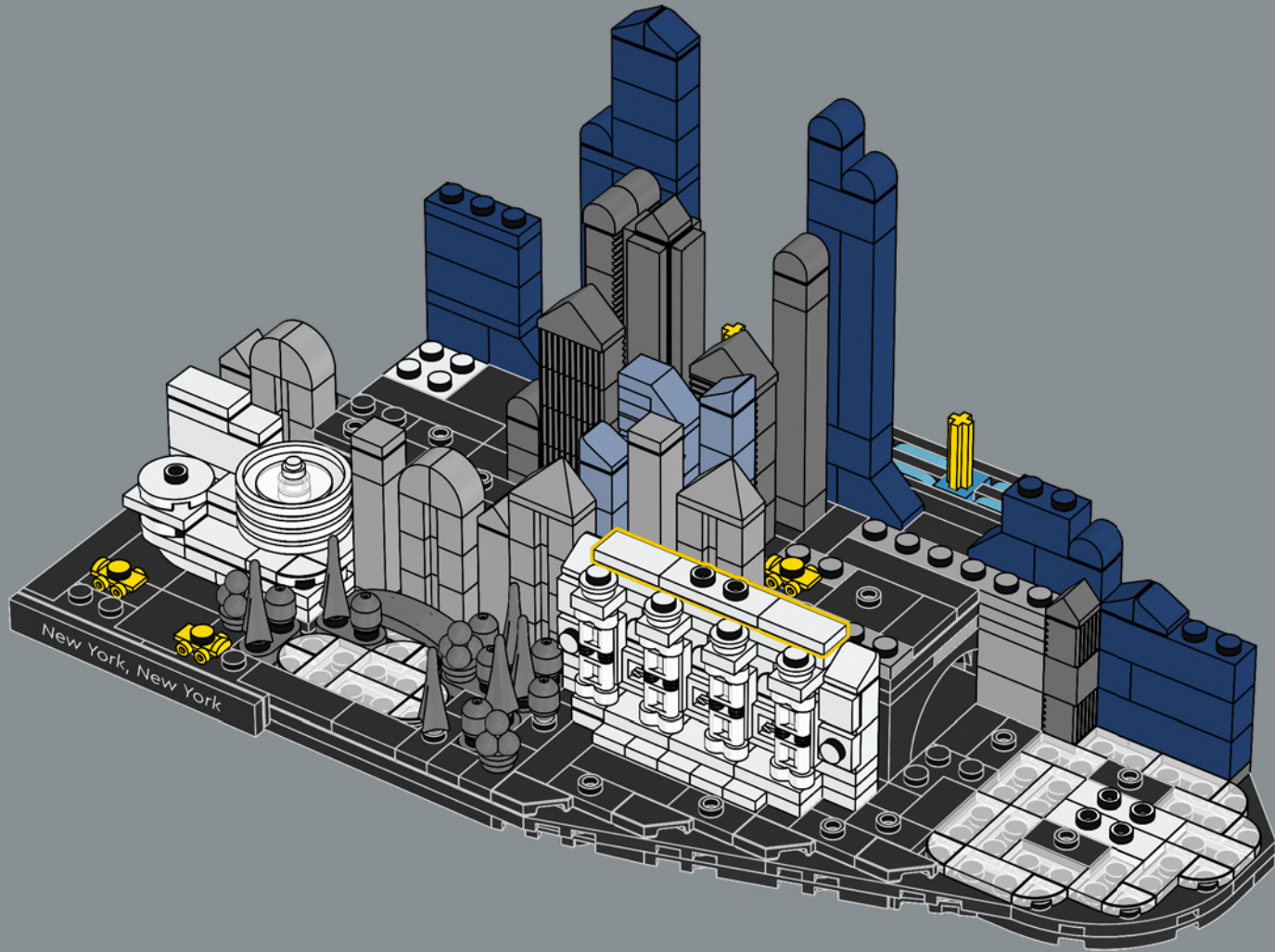

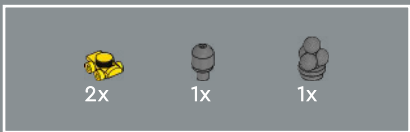

95

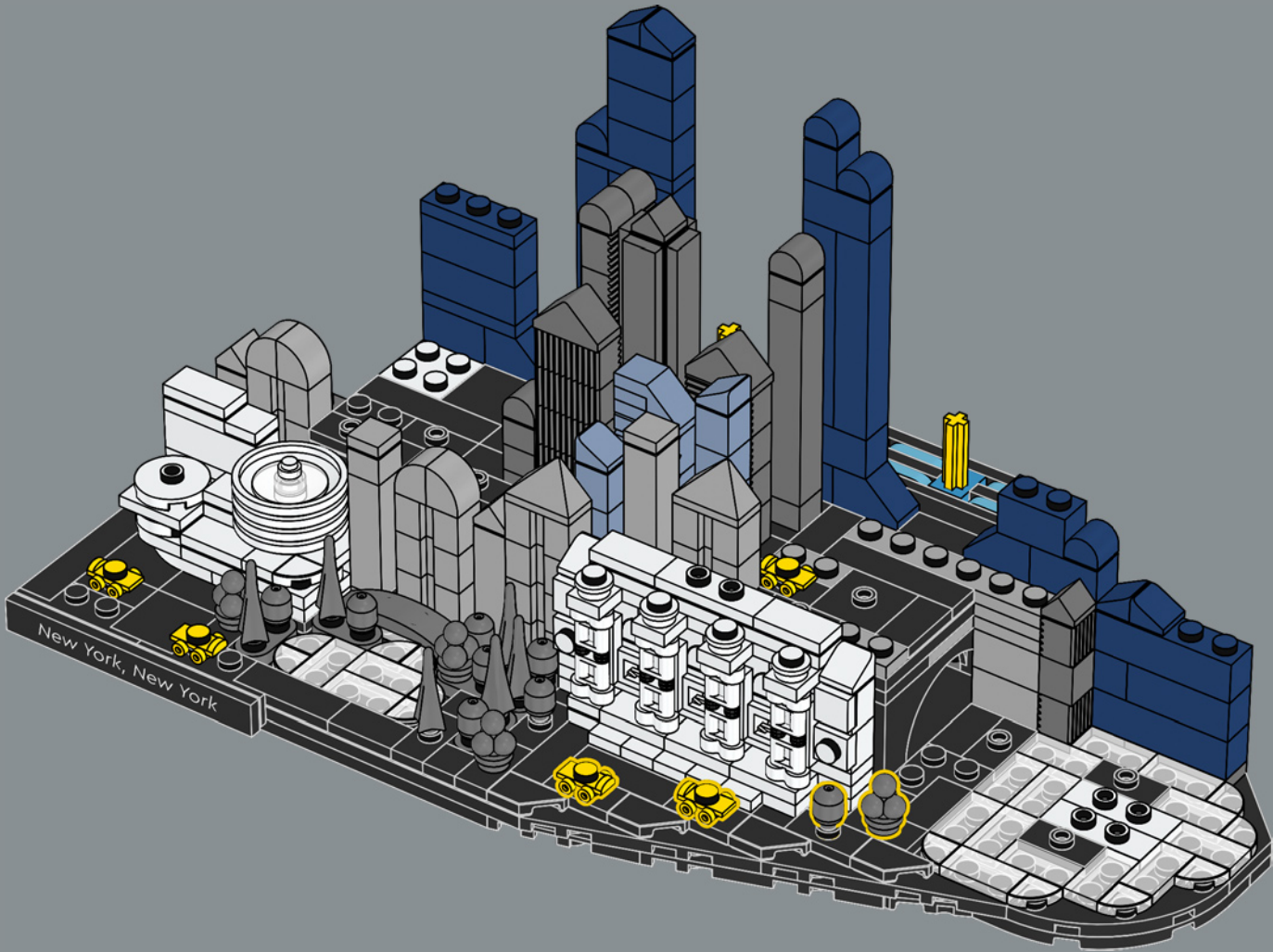

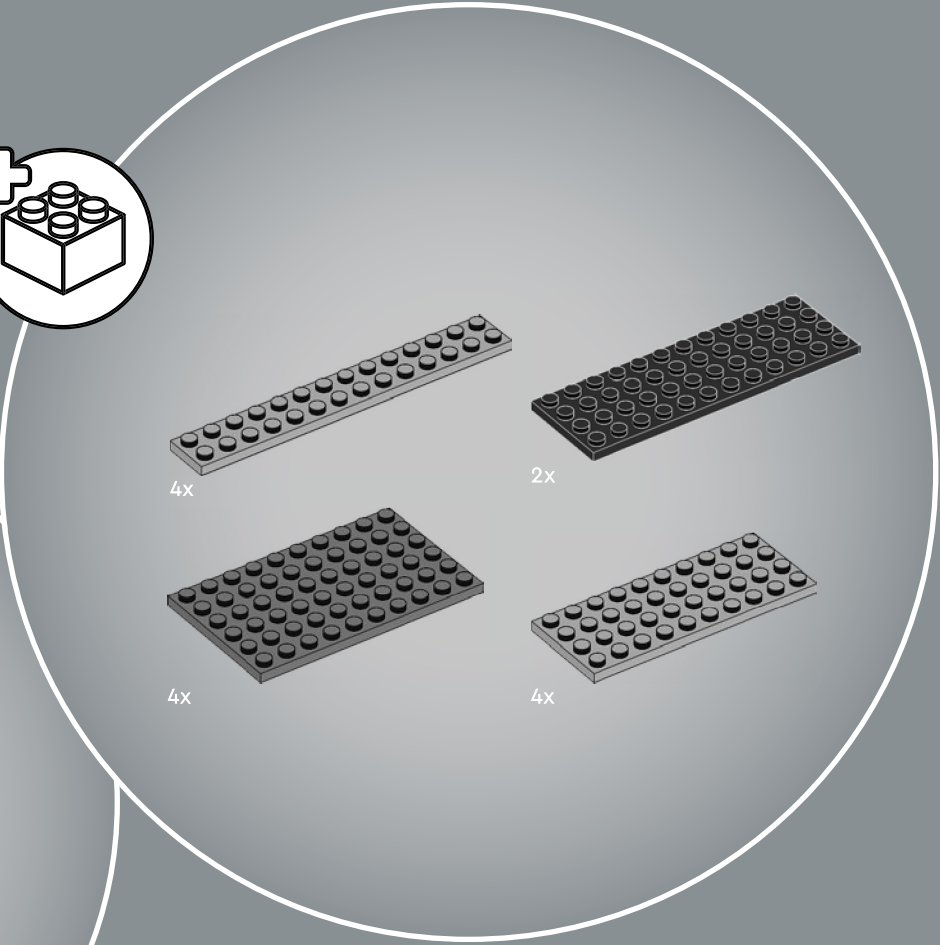
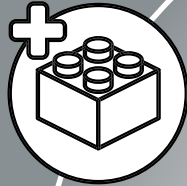

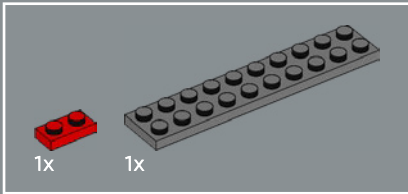
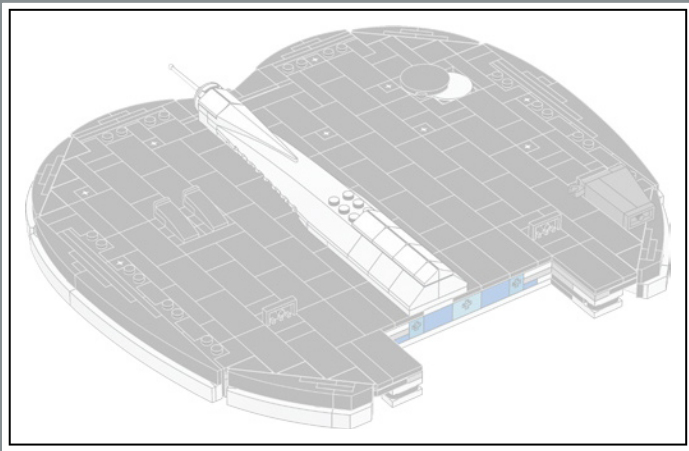

96

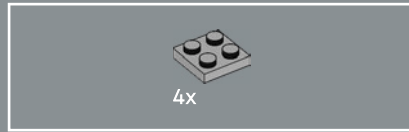
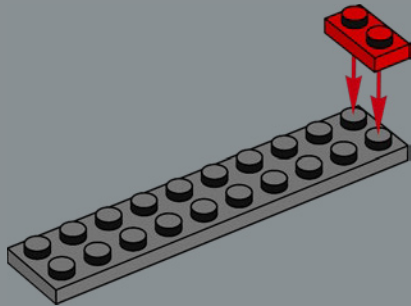

97

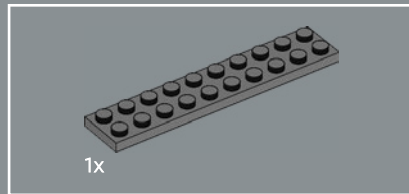
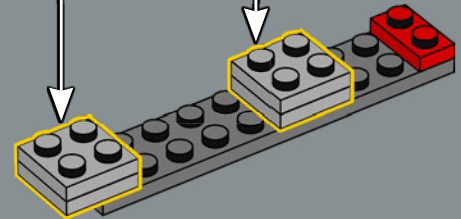
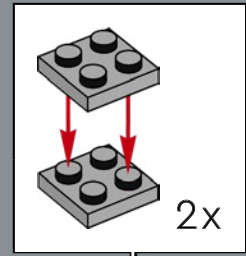

98

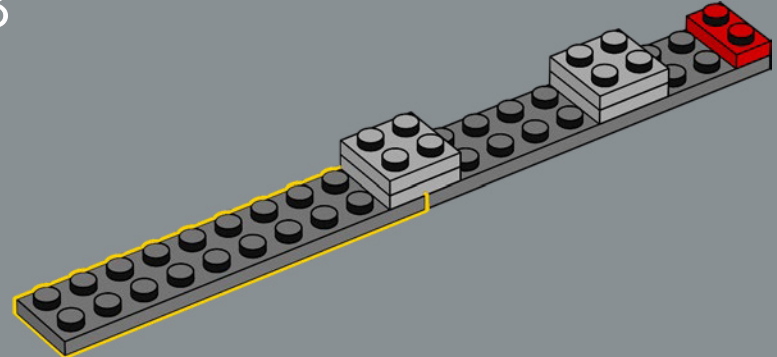

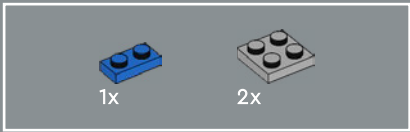

99

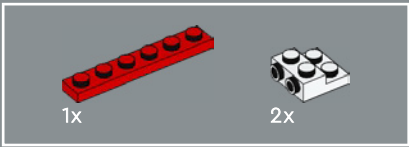
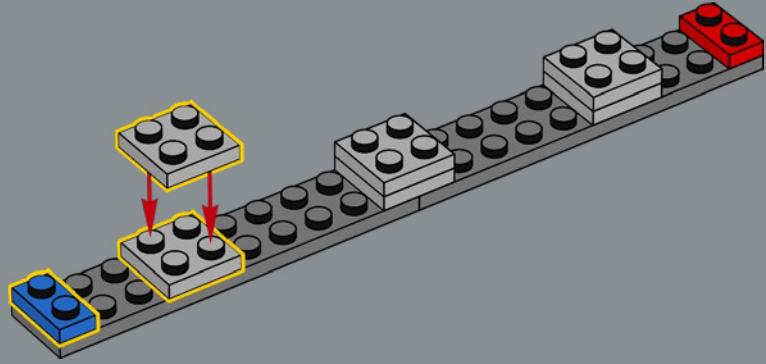

100

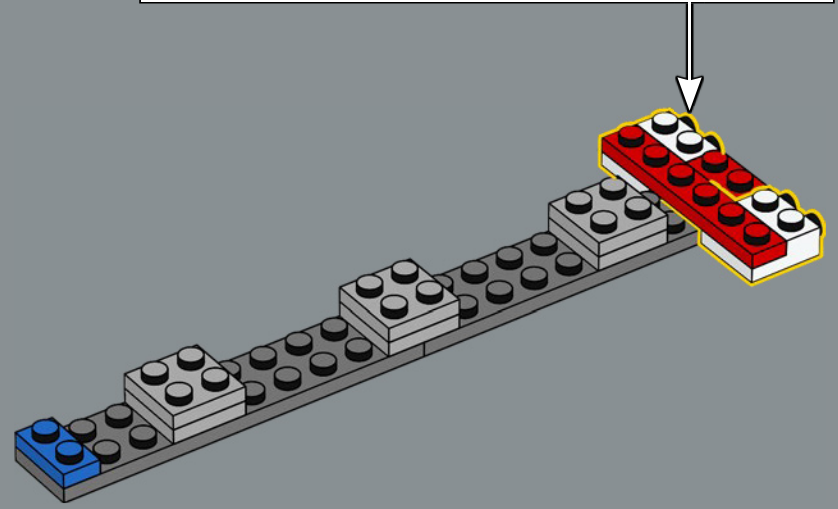
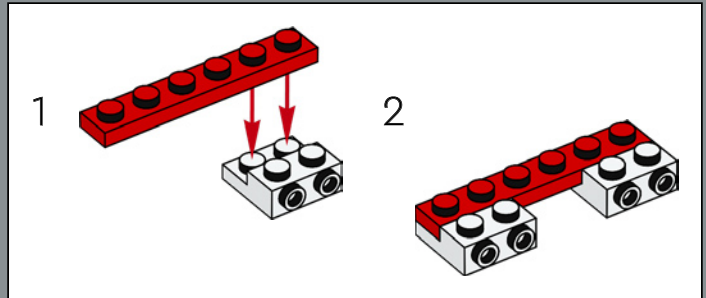

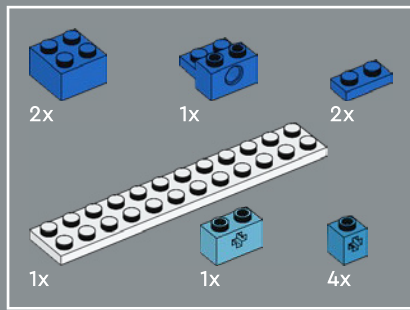

101

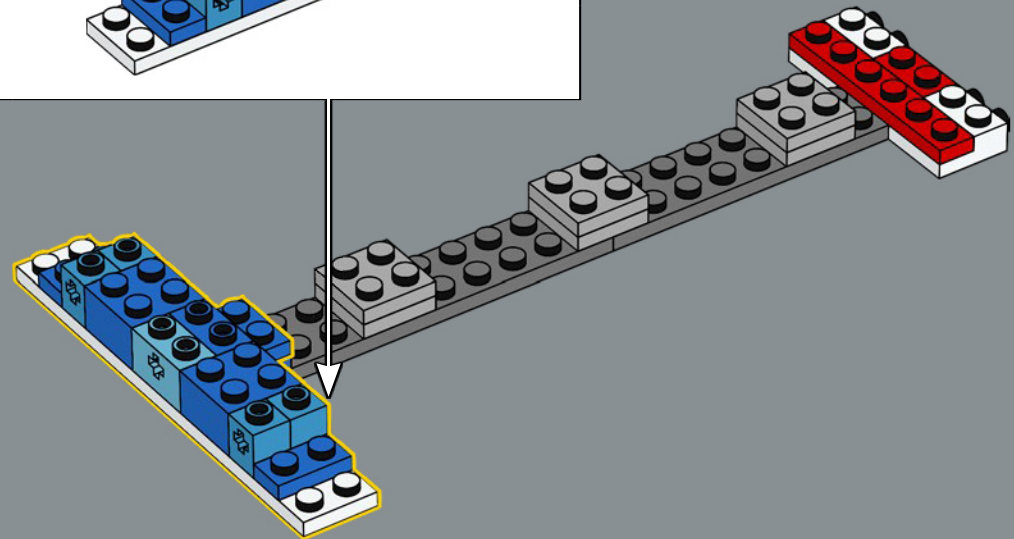
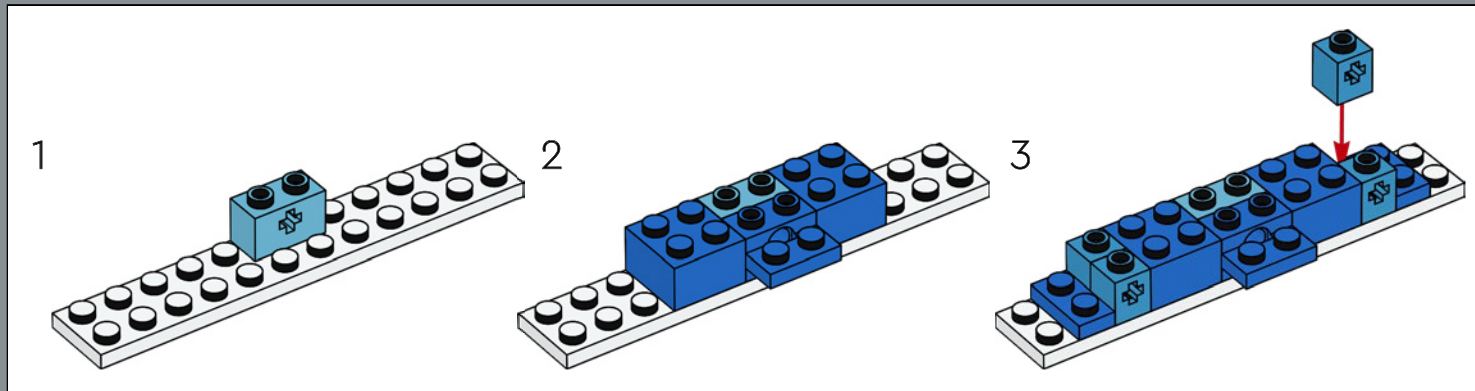

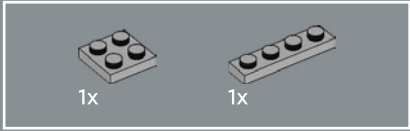
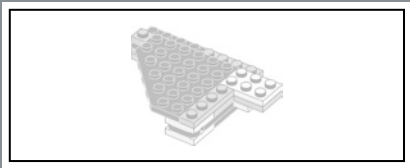

102

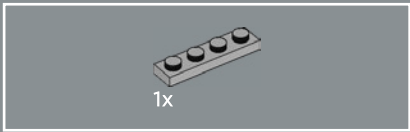
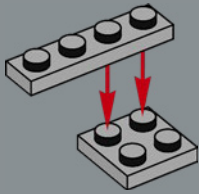

103

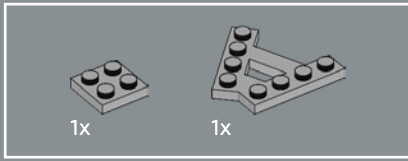
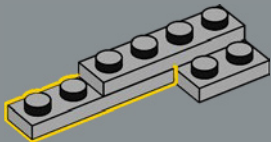

104

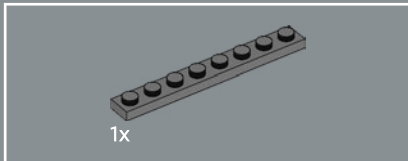
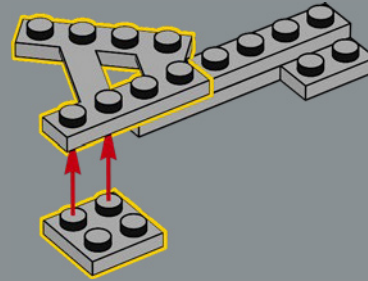

105

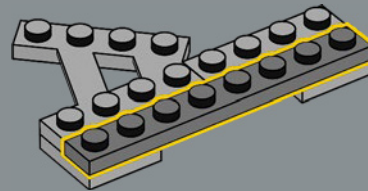



106

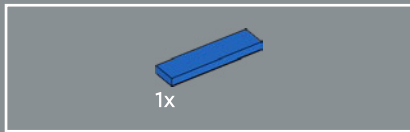
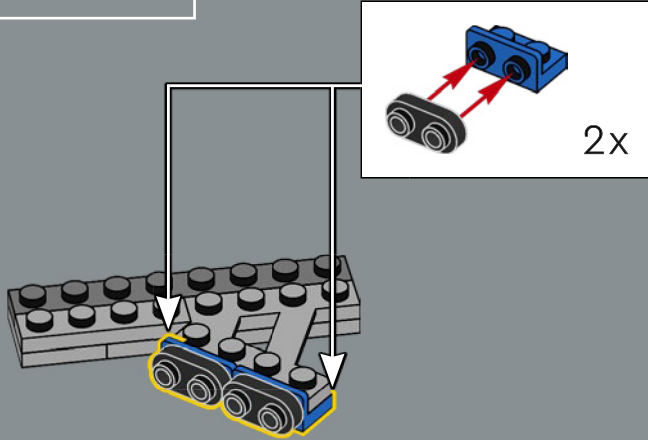

107

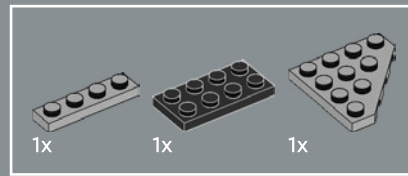
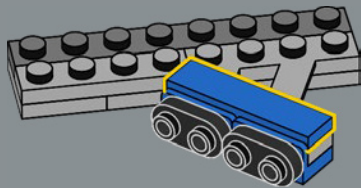

108

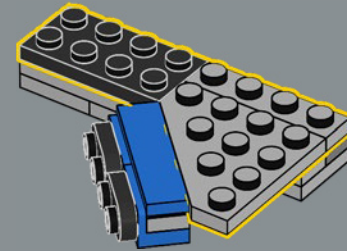

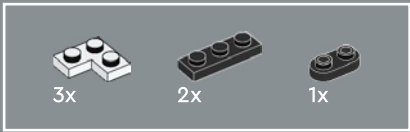

109

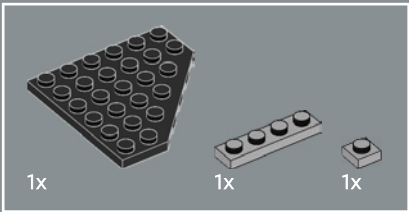
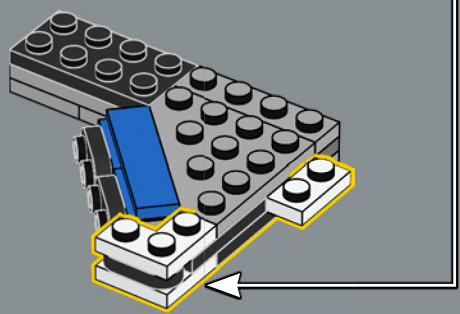
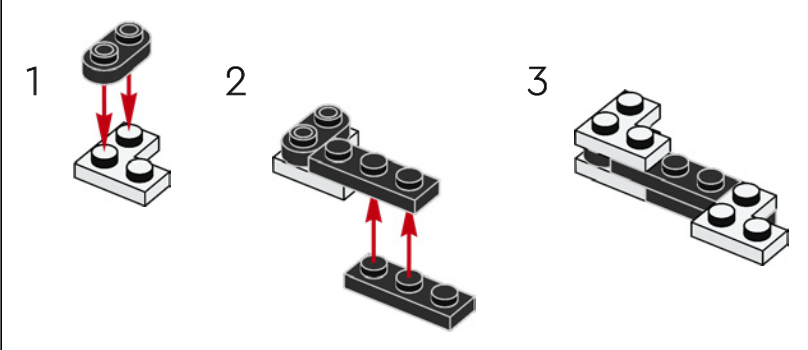

110

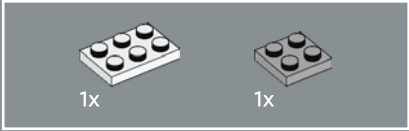
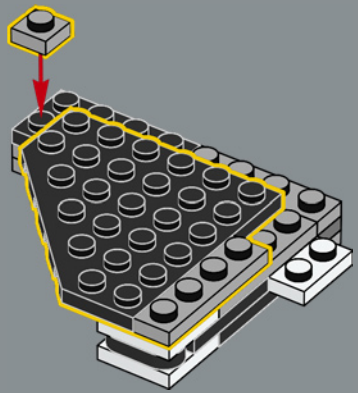

111

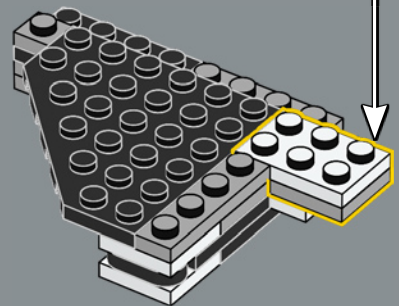
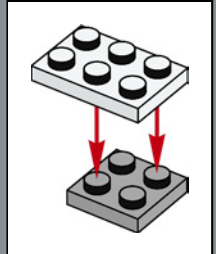

112

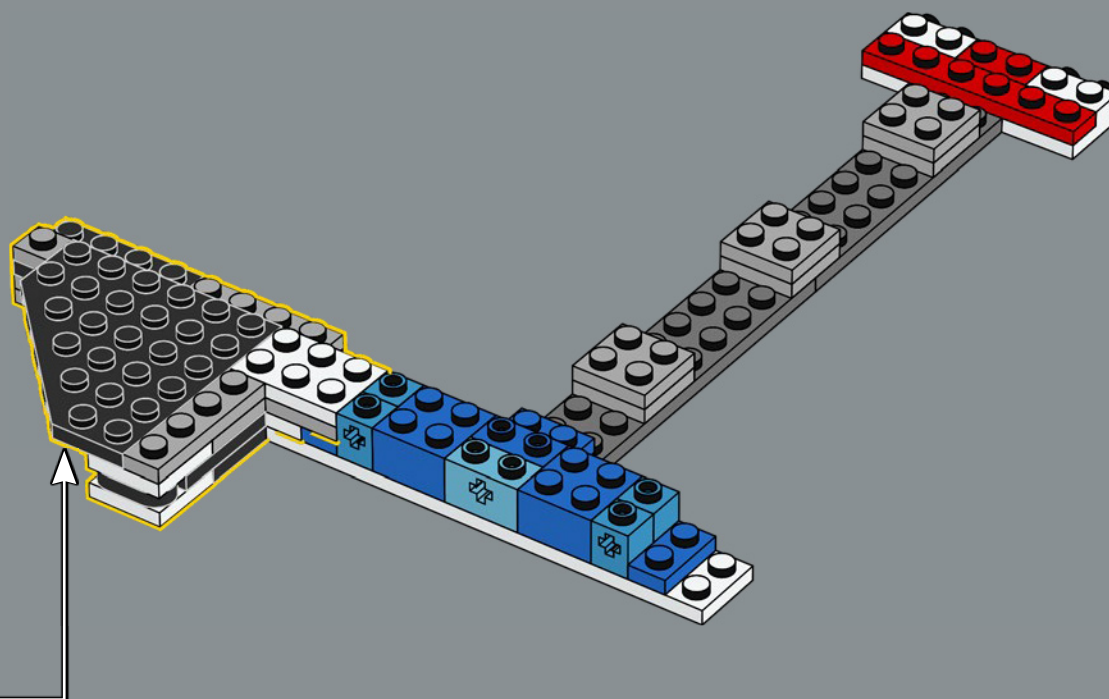



117

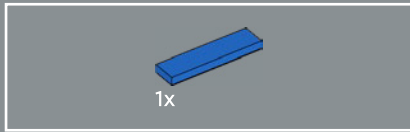
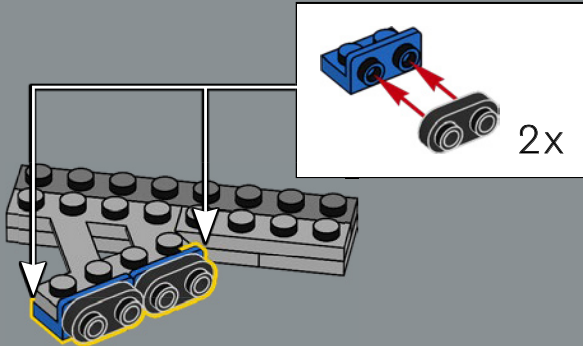

118

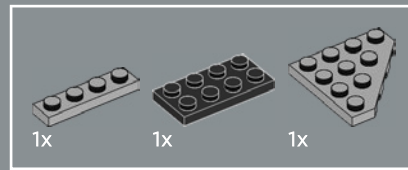
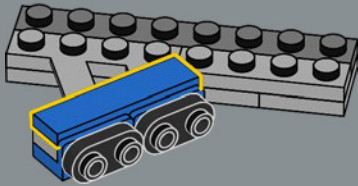

119

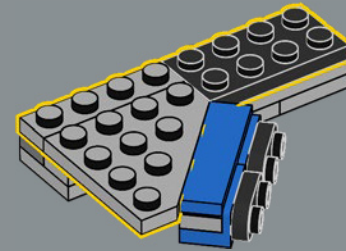

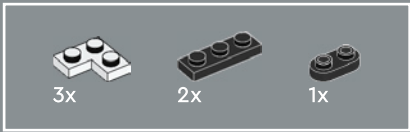

120

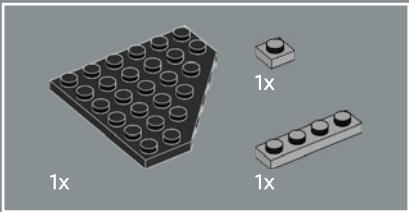
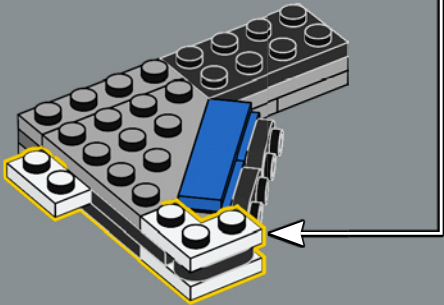
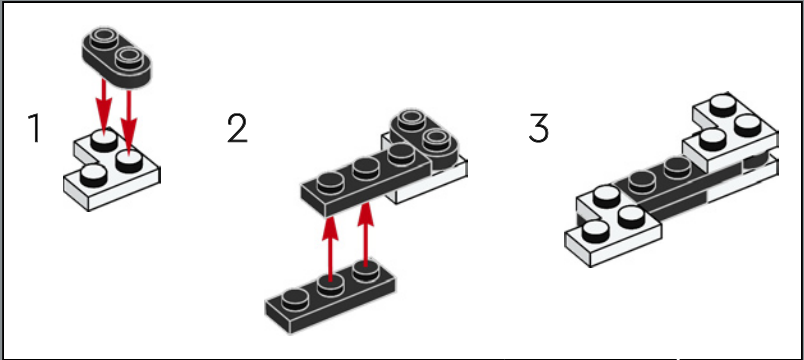

121

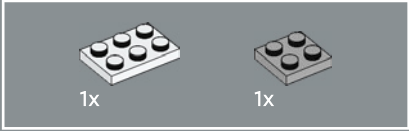
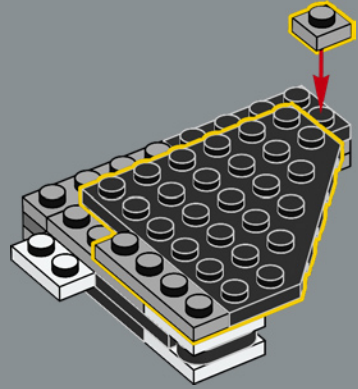

122

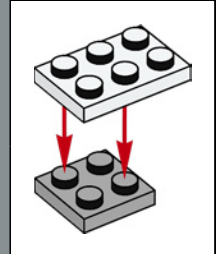
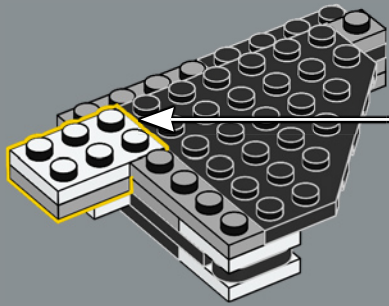

123

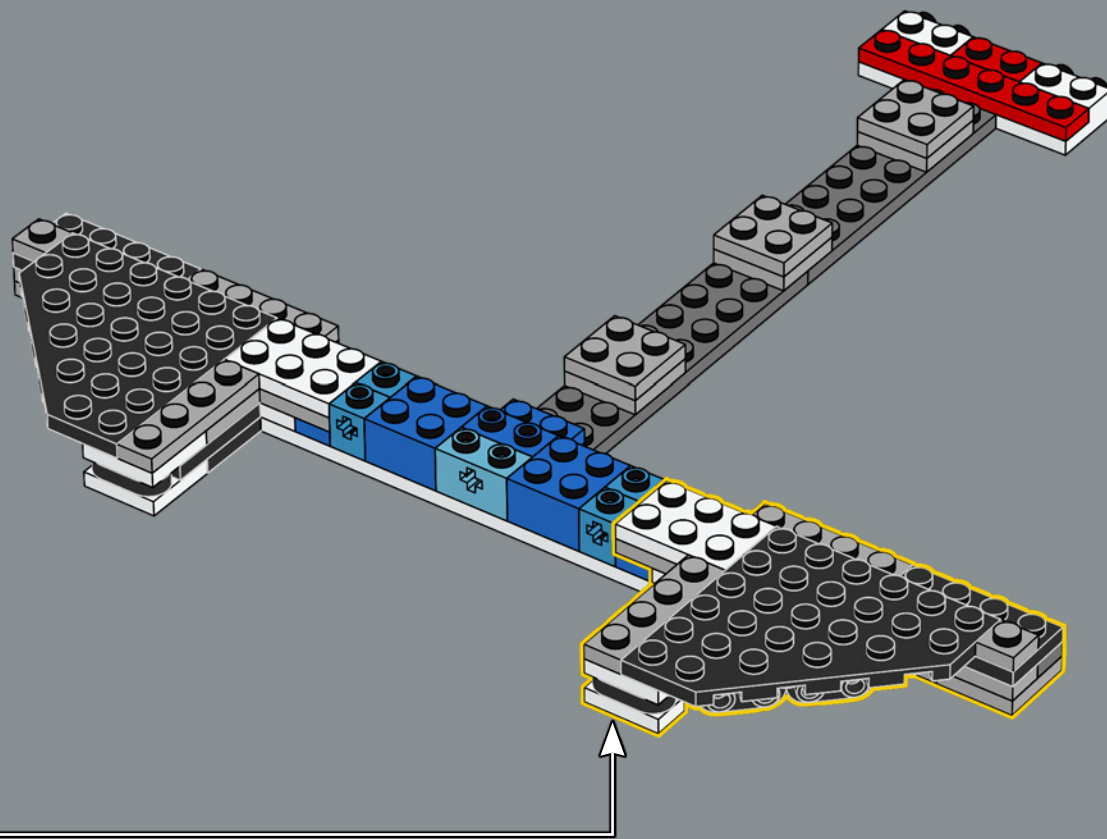

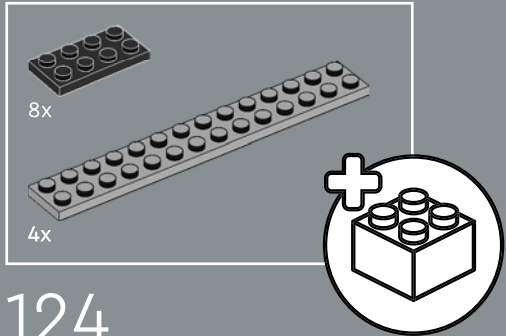
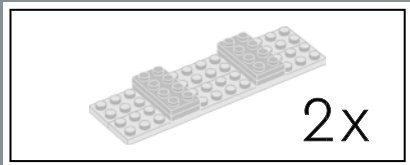

124

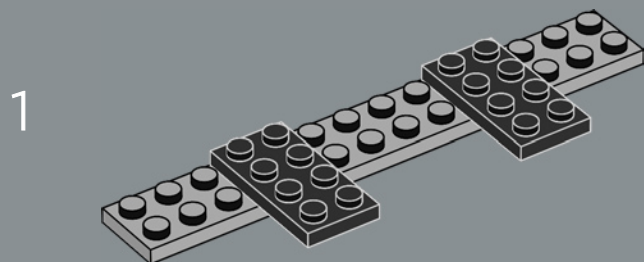

2

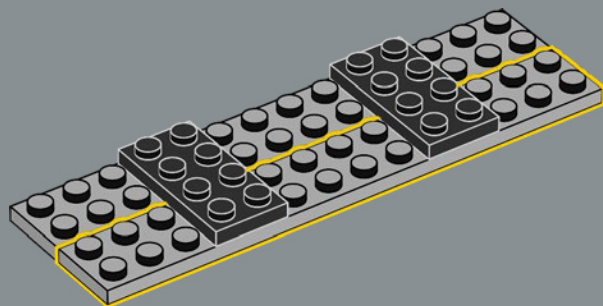

3

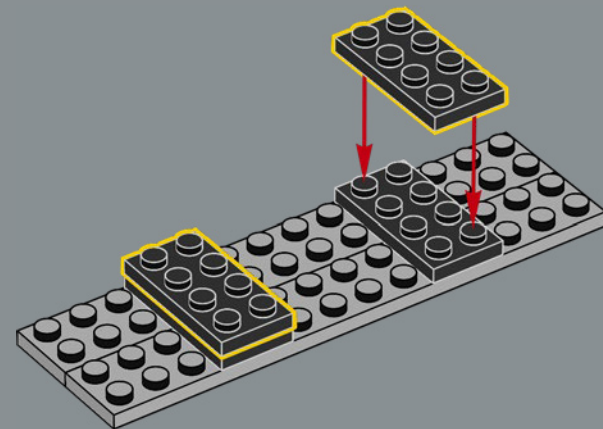

2x

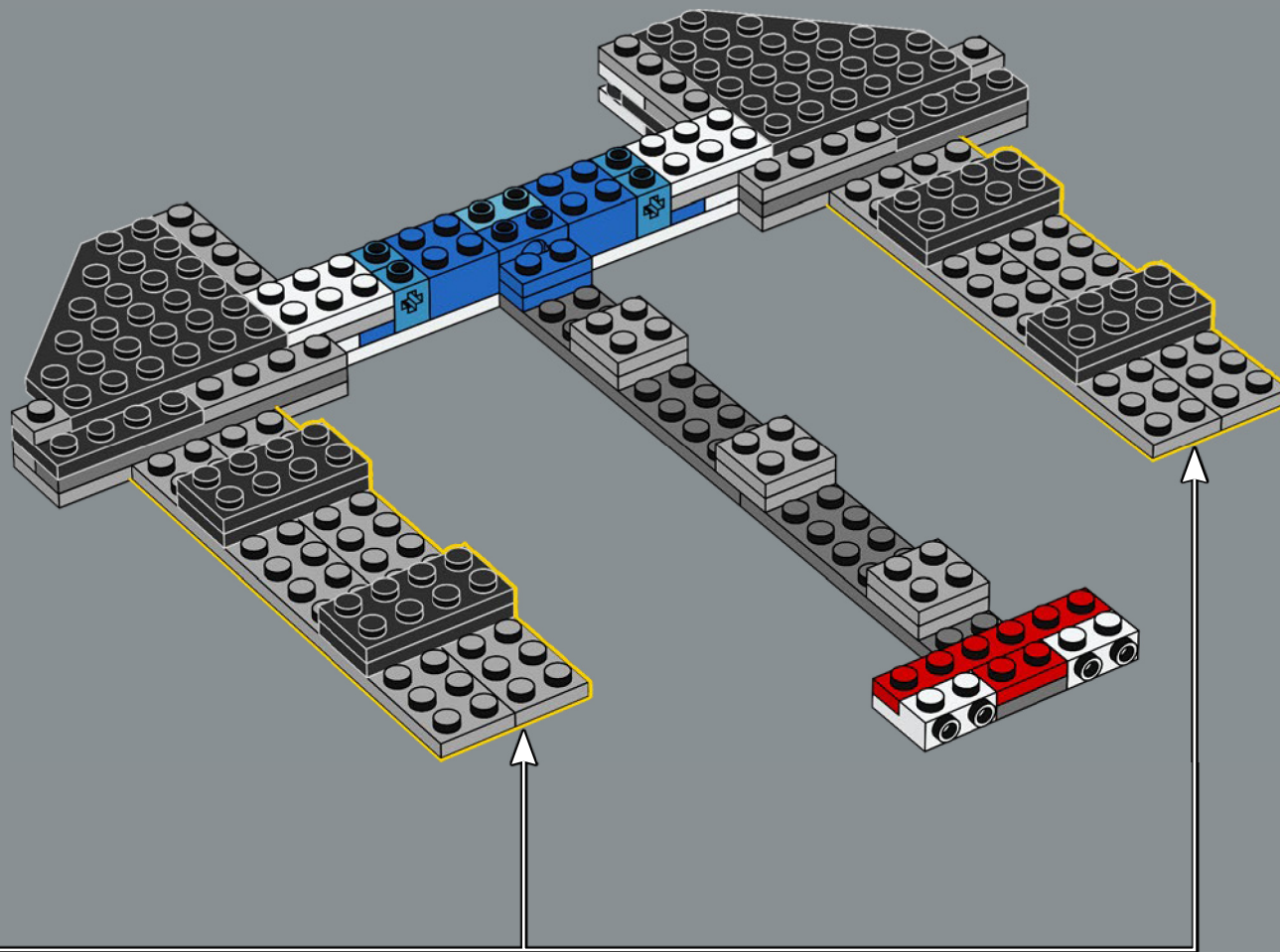

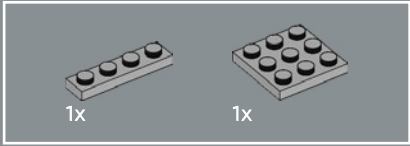
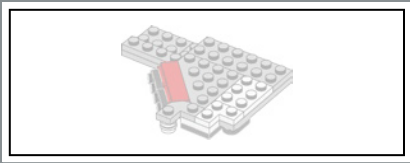

125

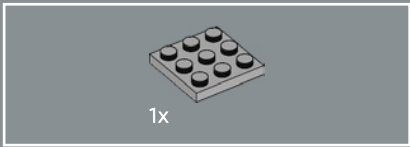
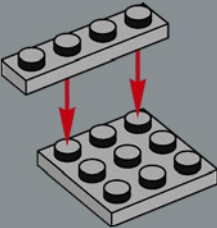

126

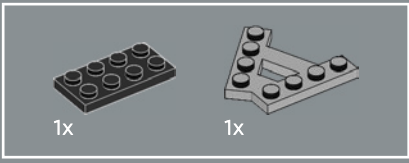
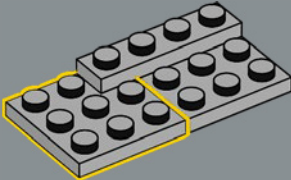

127

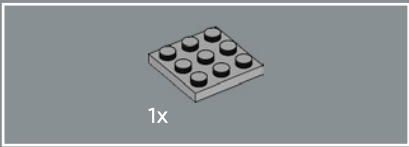
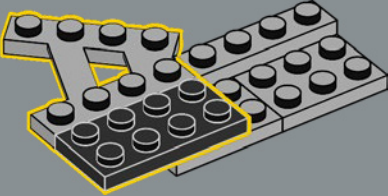

128

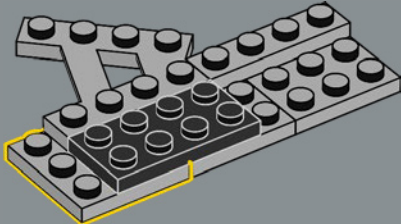



129

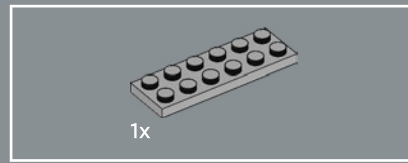
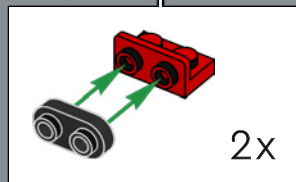
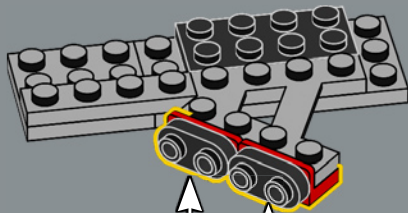

130

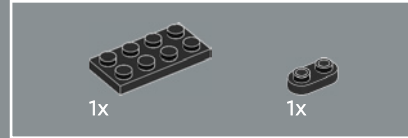
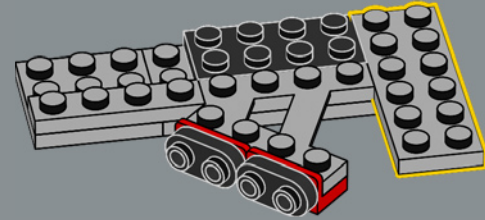

131

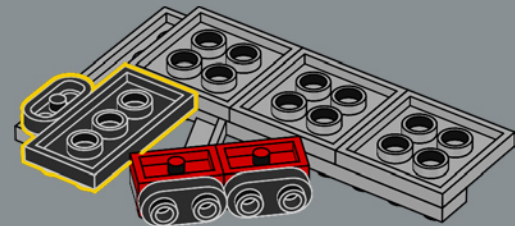



132

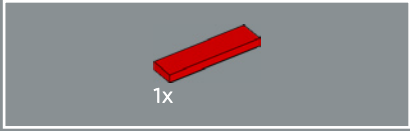
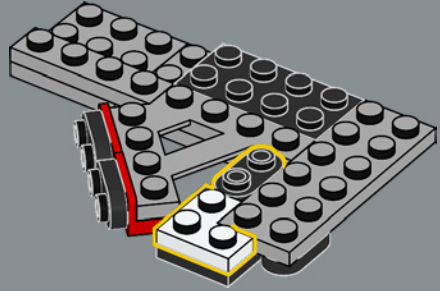

133

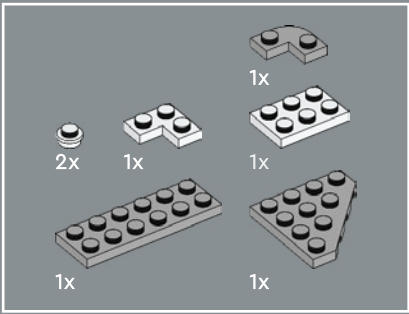
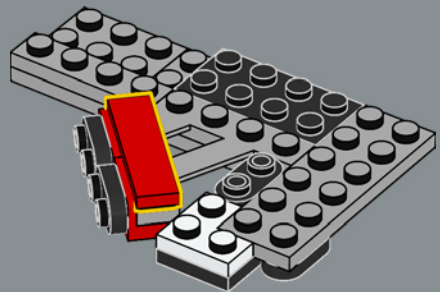

134

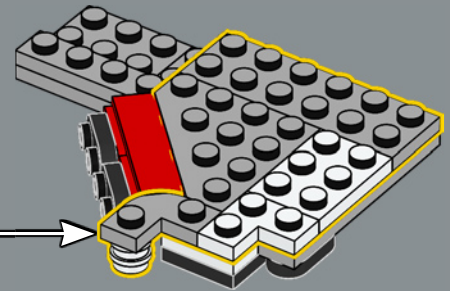
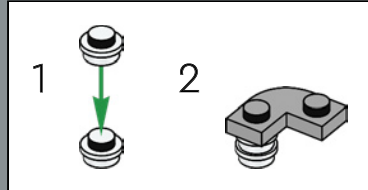

135

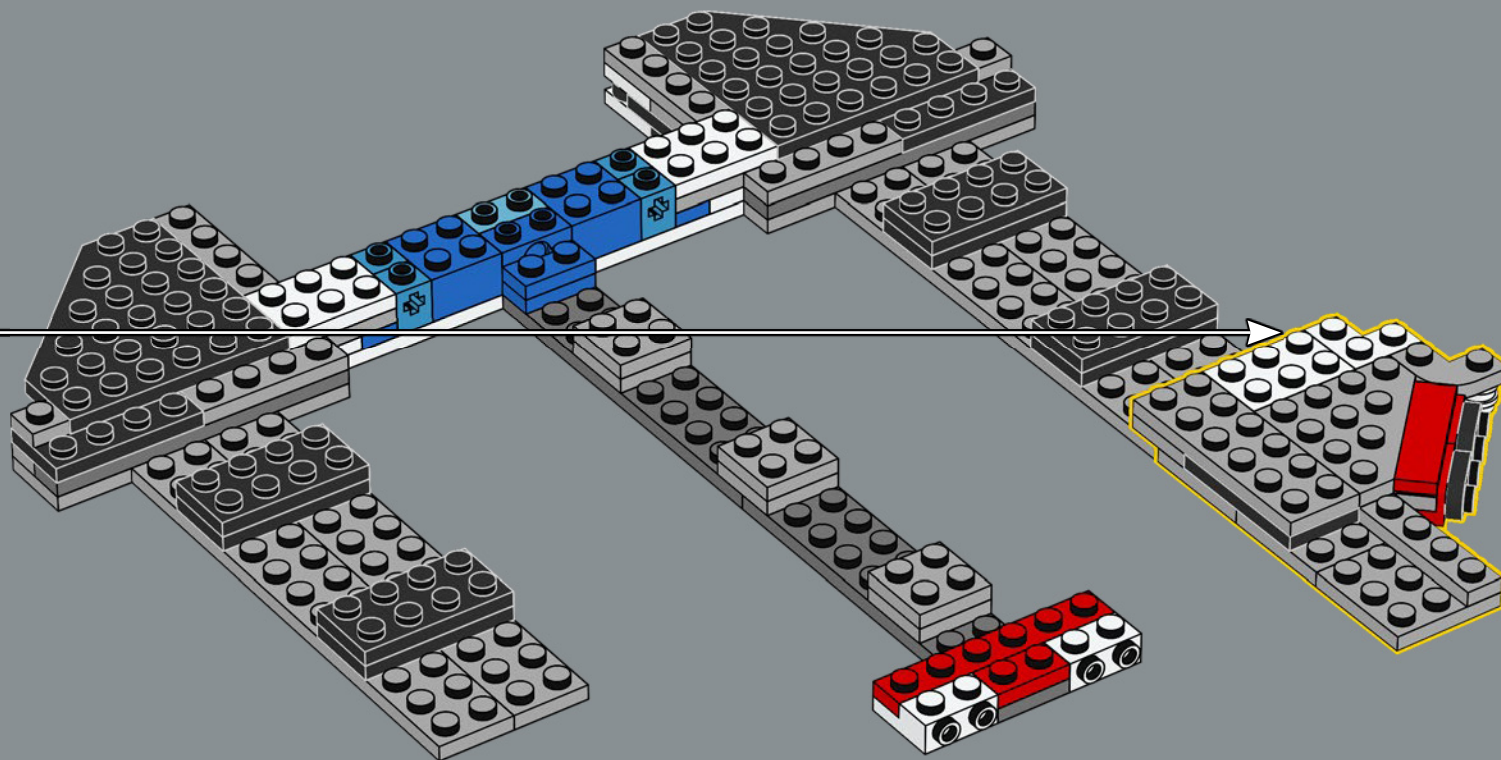

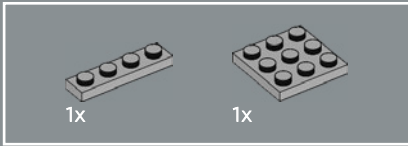
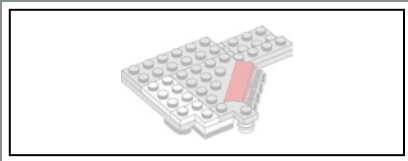

136

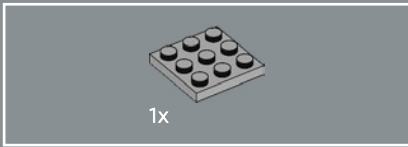
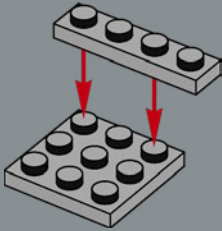

137

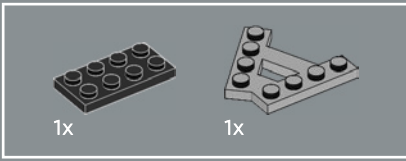
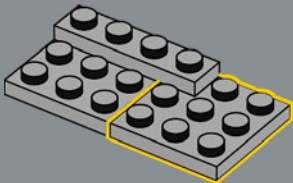

138

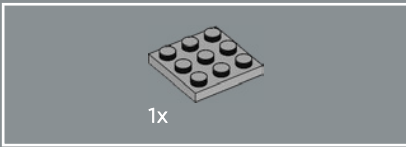
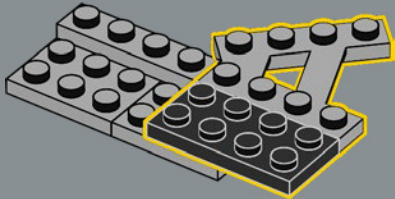

139

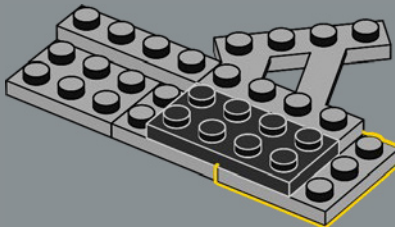



140

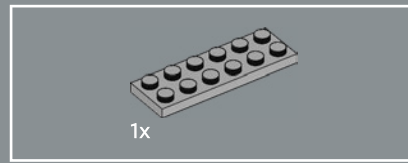
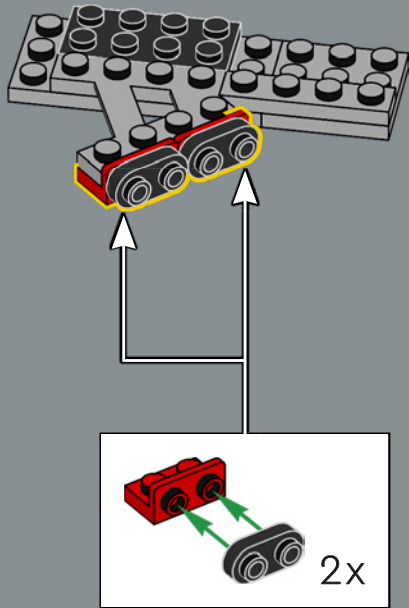

141

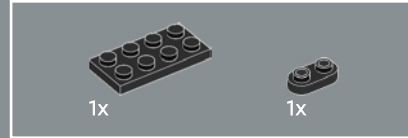
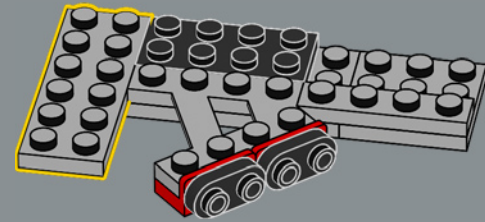

142

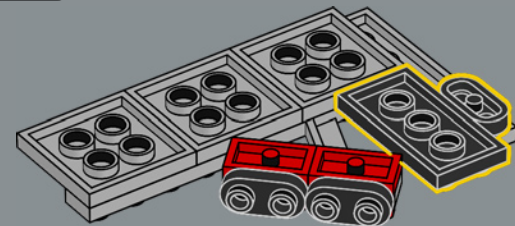



143

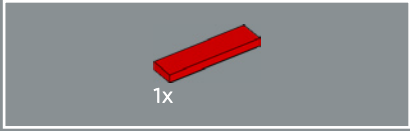
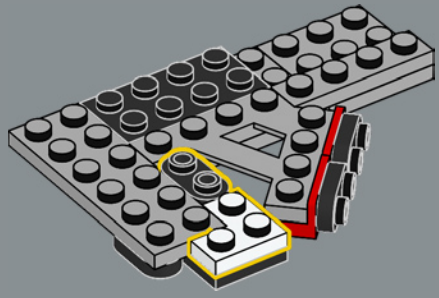

144

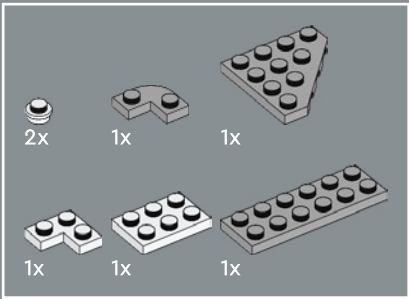
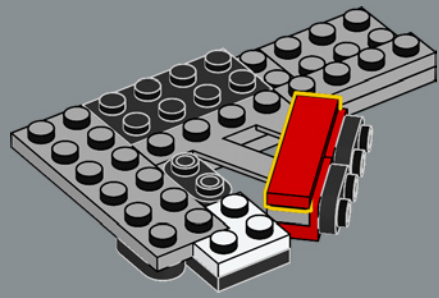

145

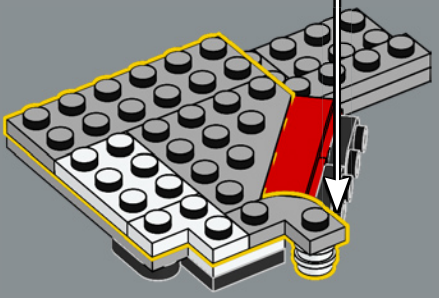
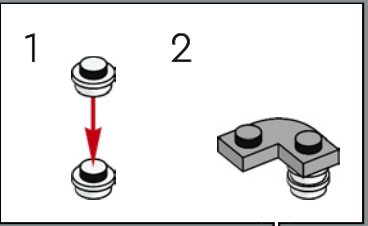

146

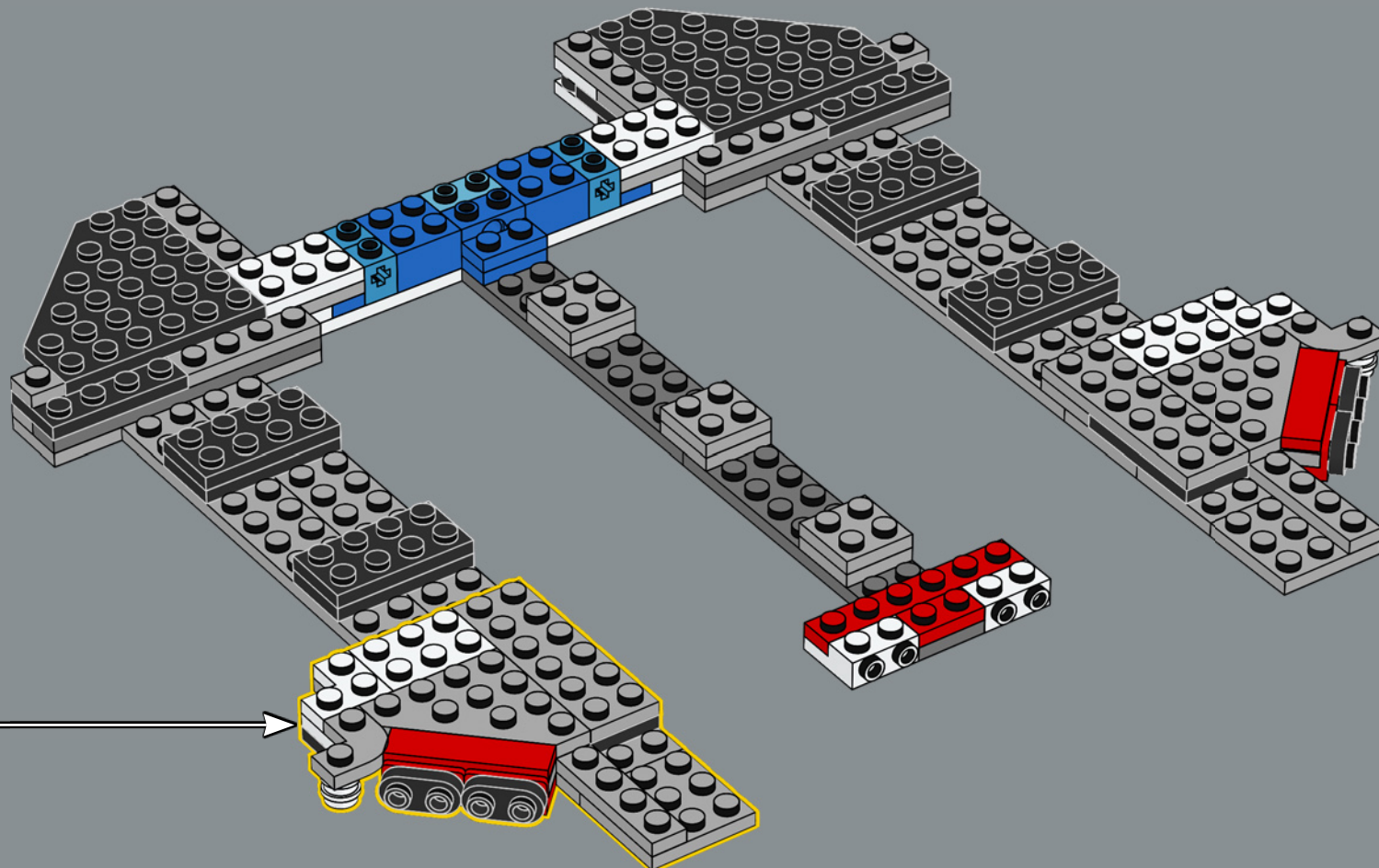

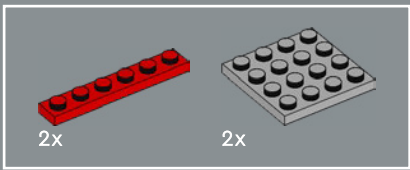

147

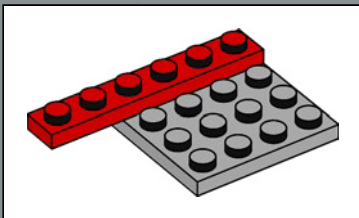
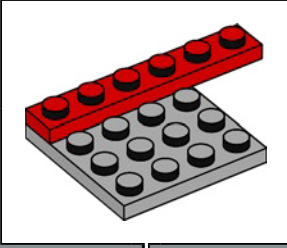
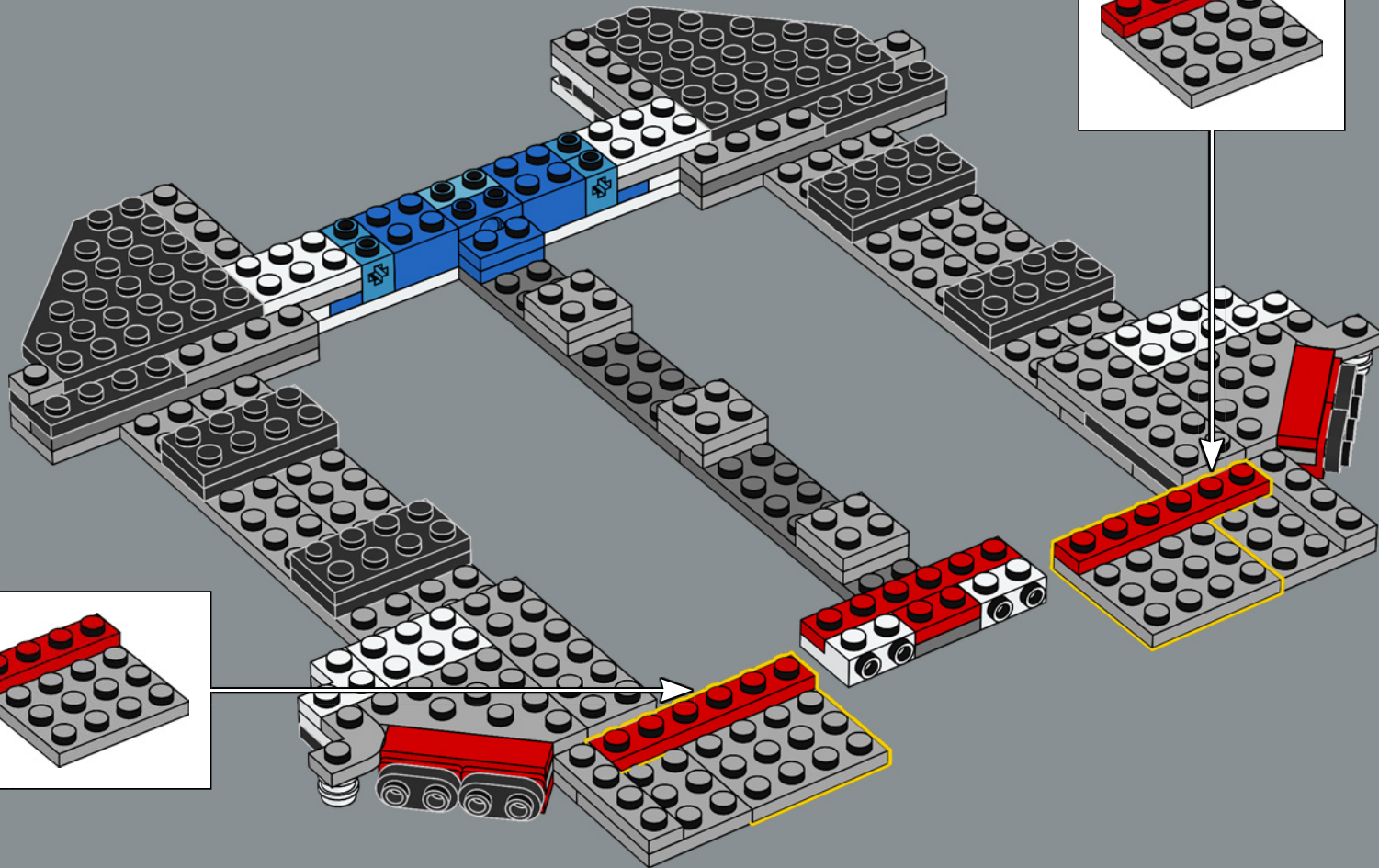

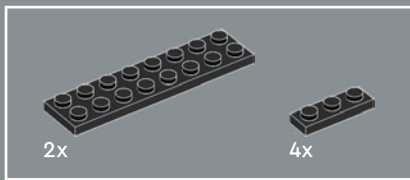

148

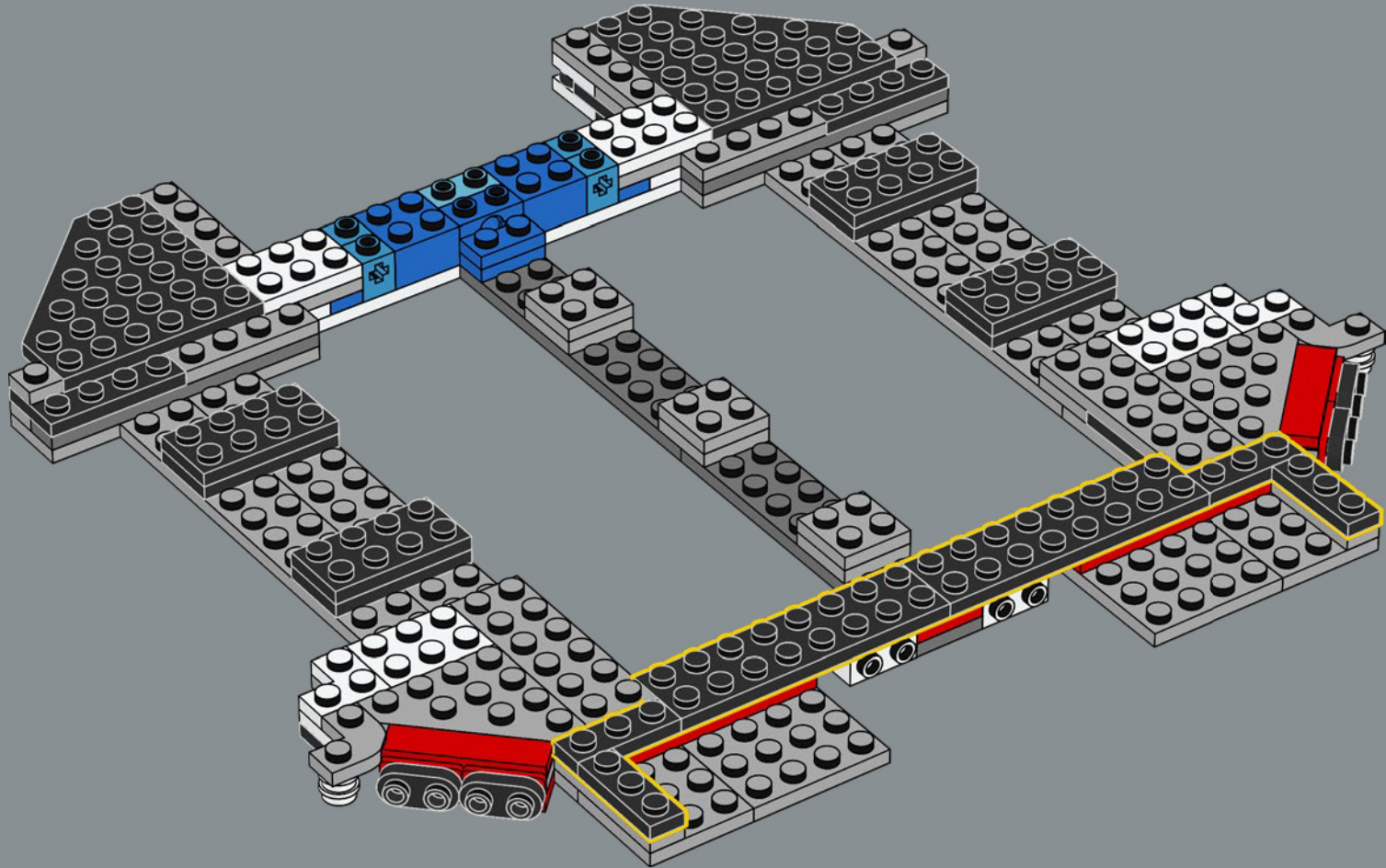

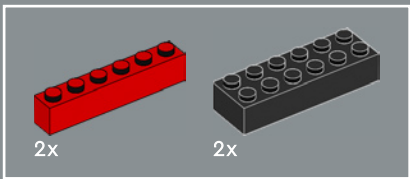

149

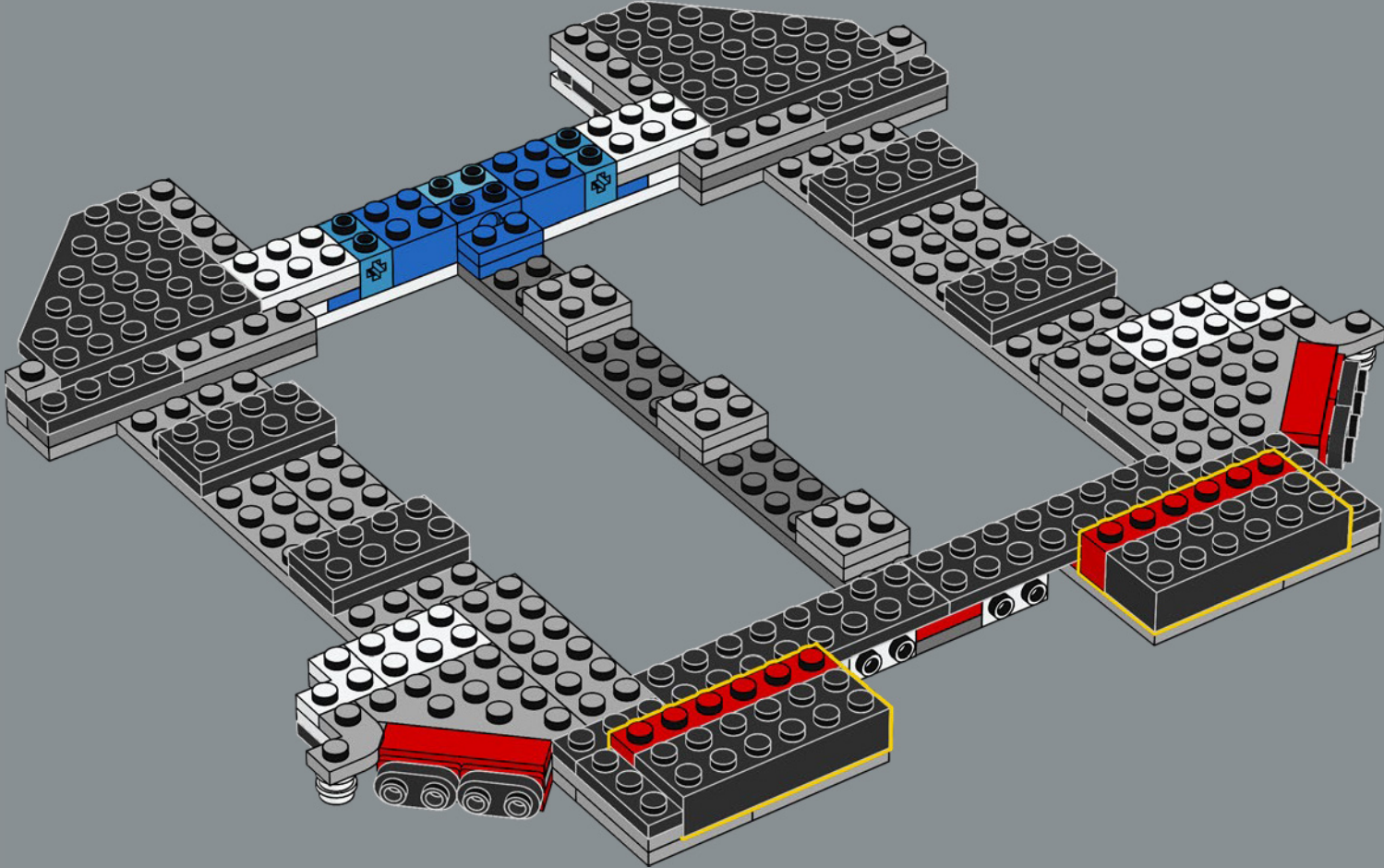

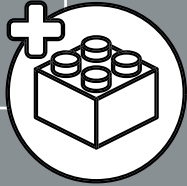
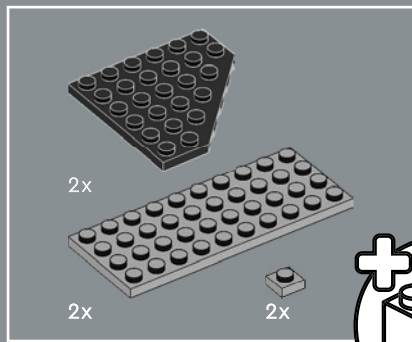

150

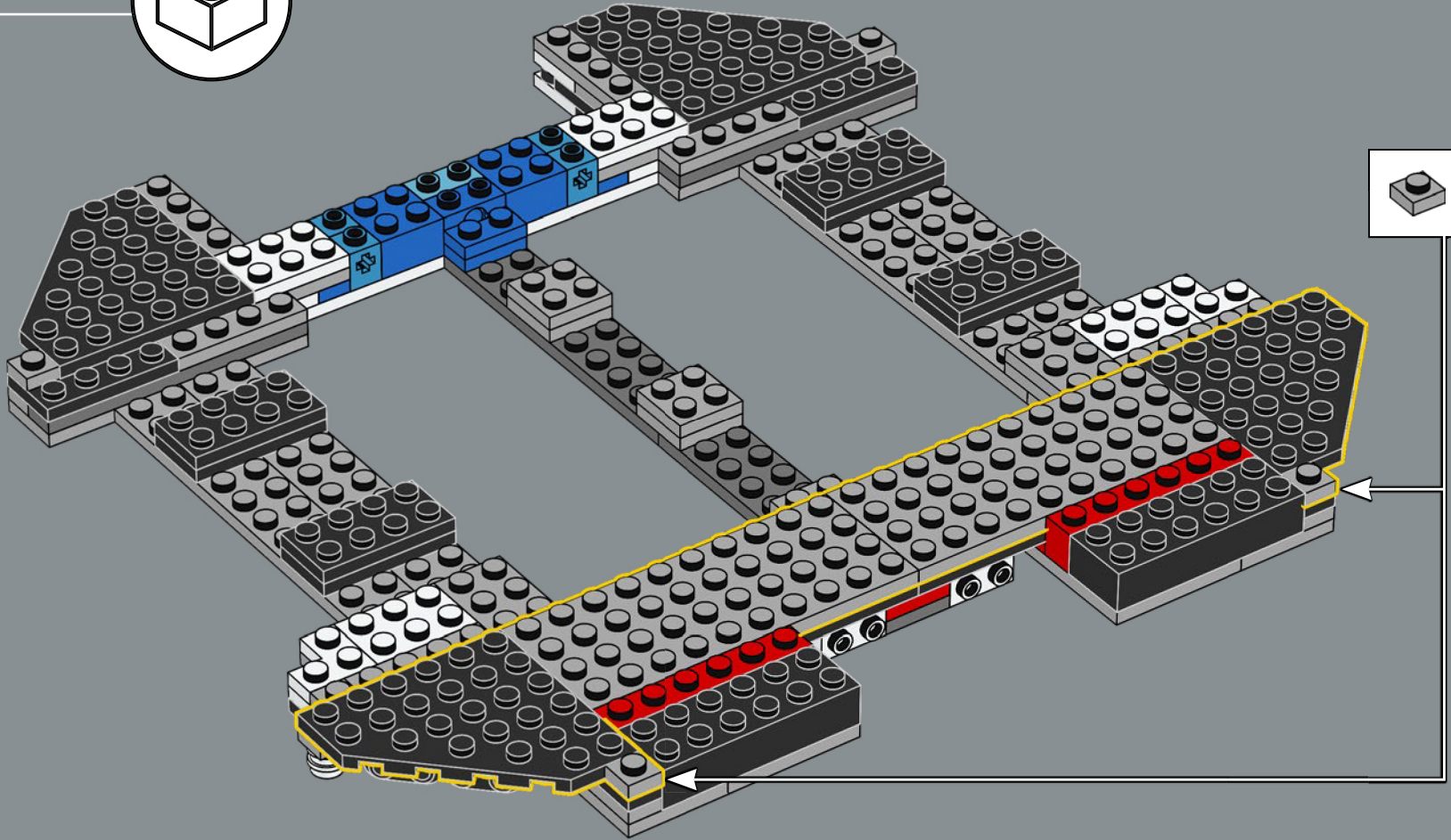

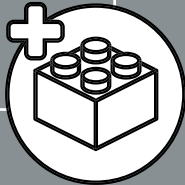
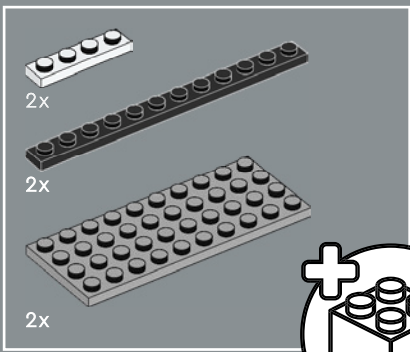

151

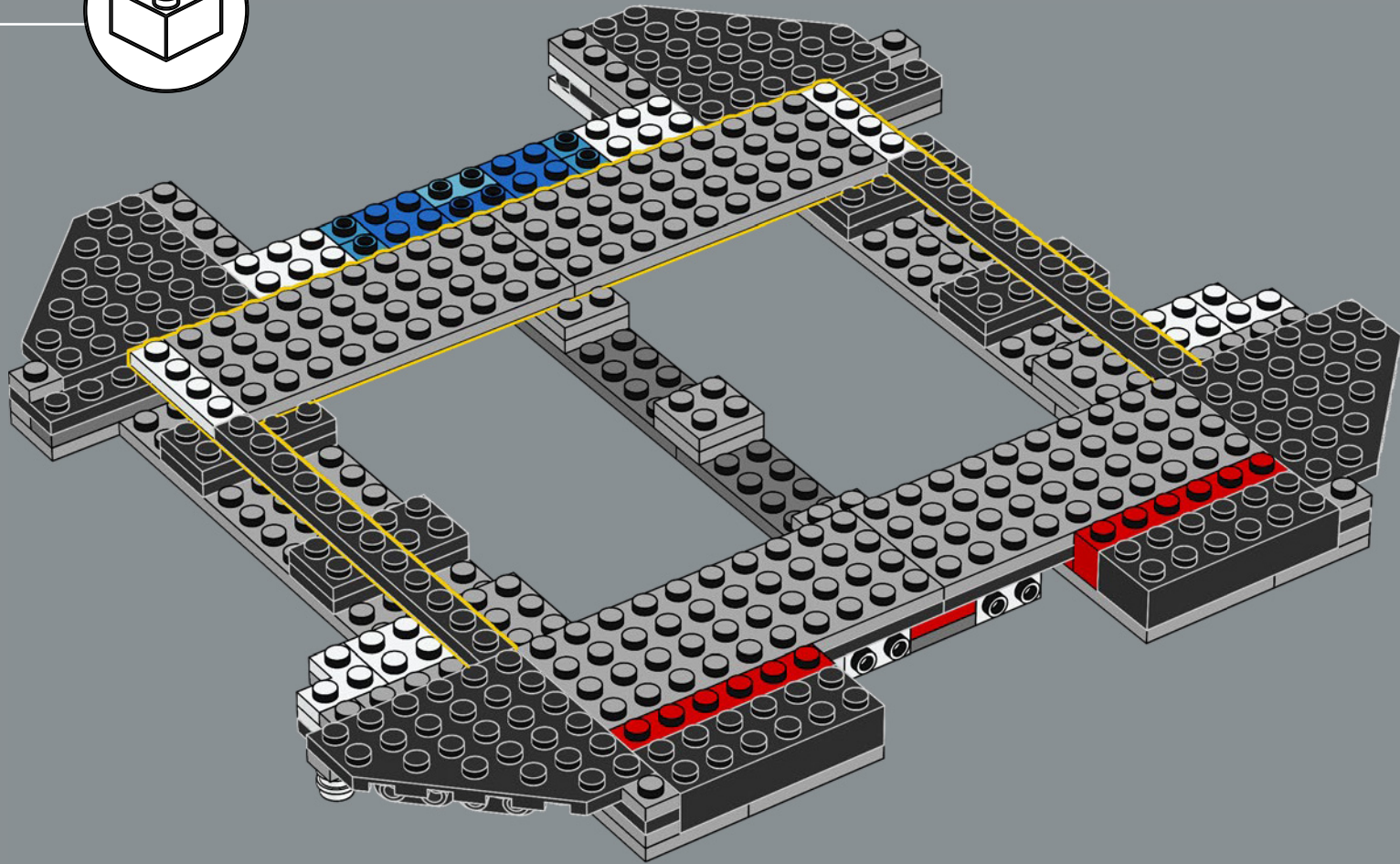

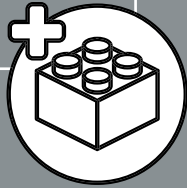
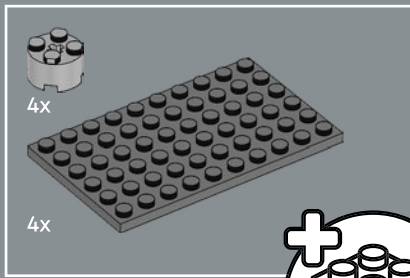

152

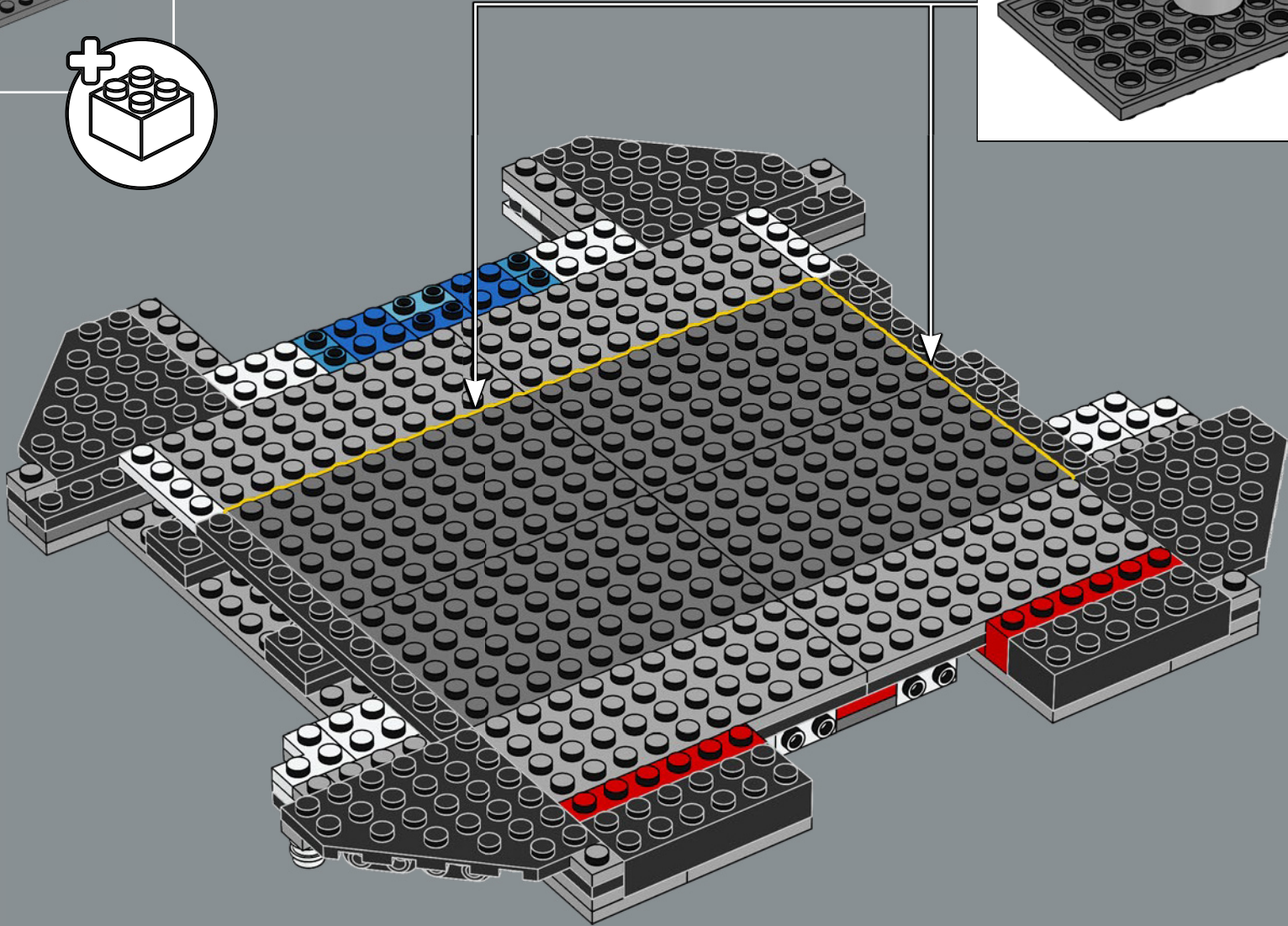
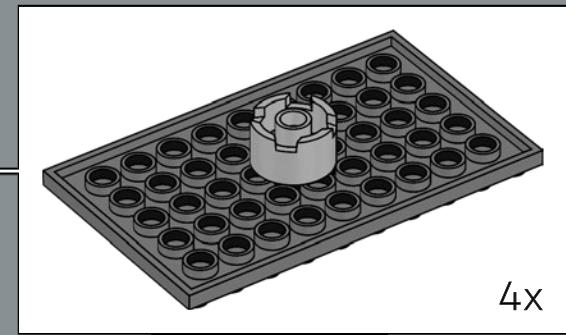

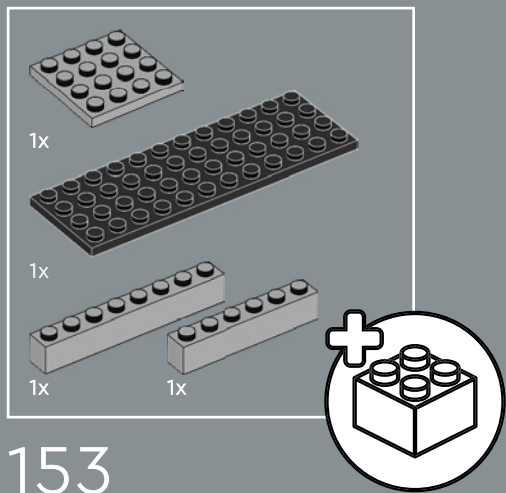

153

1

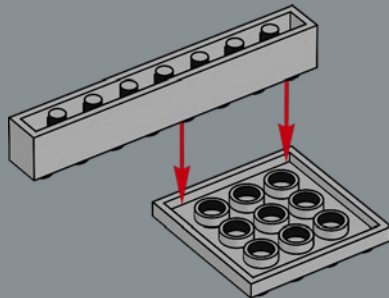

2

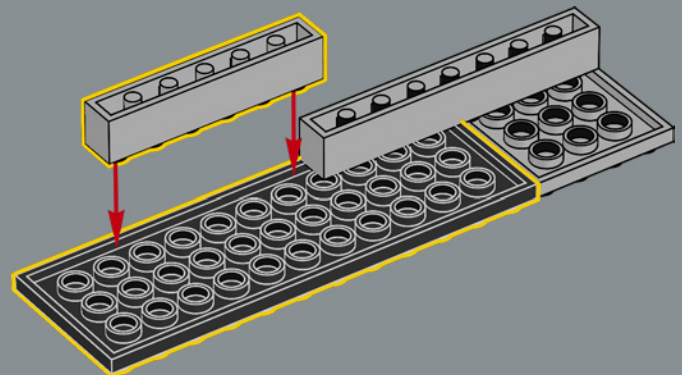

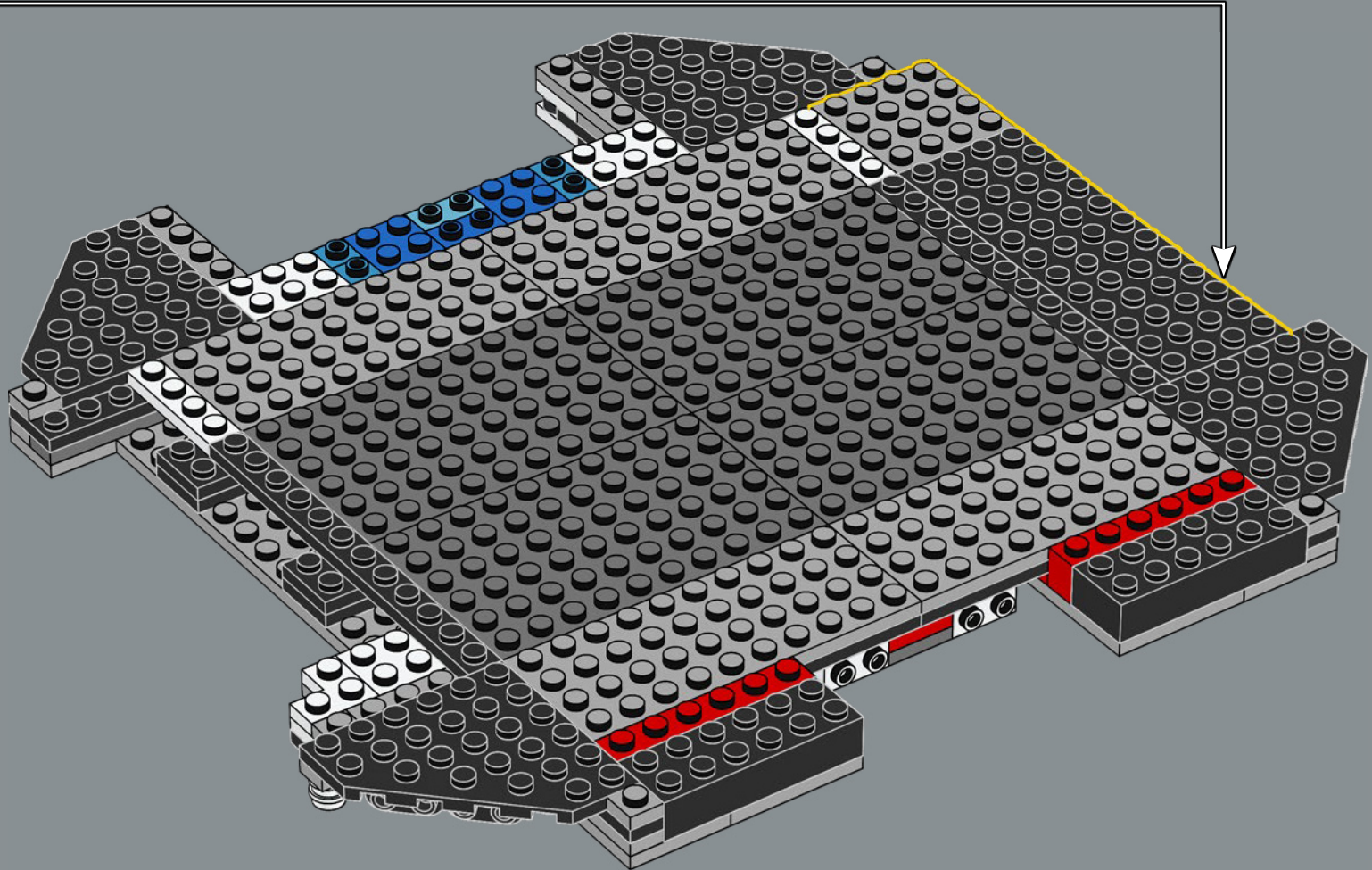

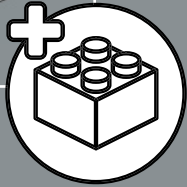
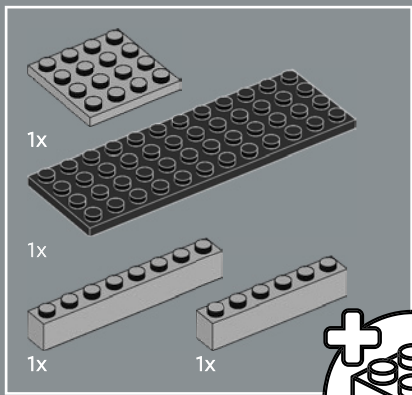

154

1

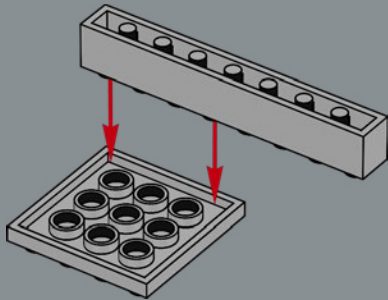

2

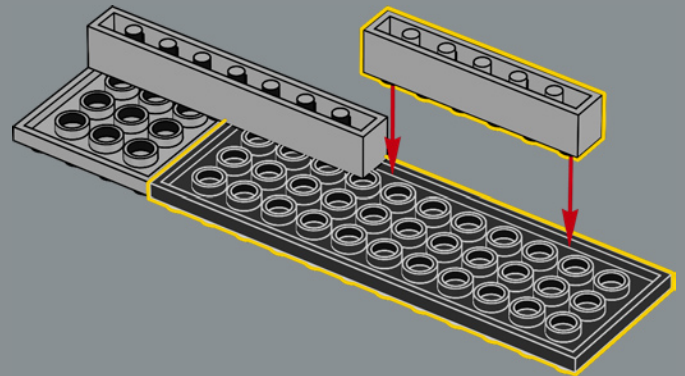

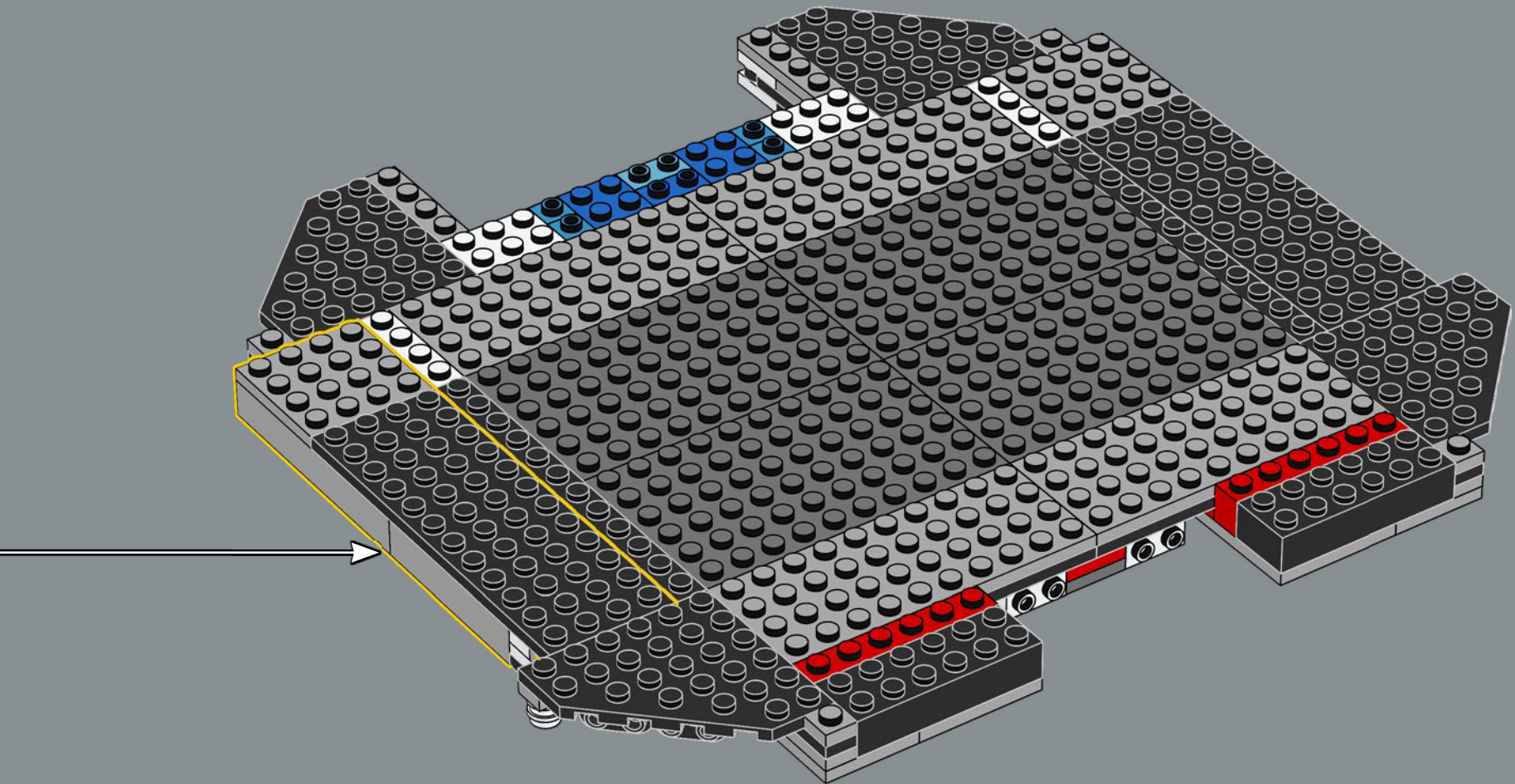

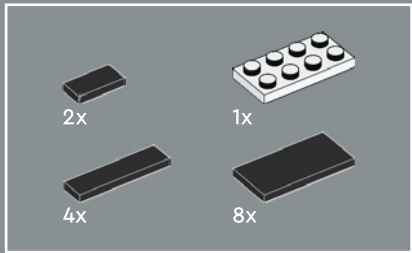

155

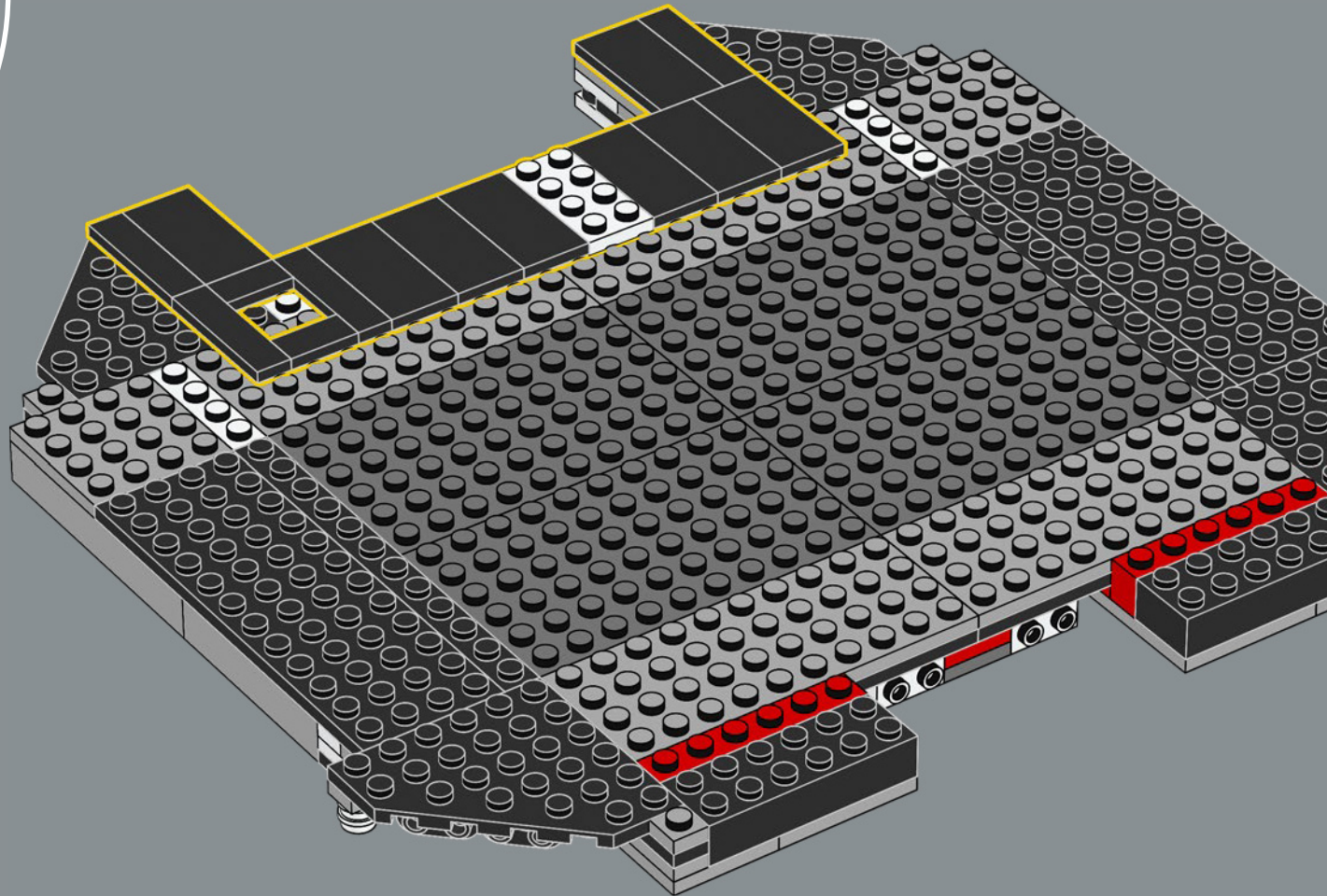

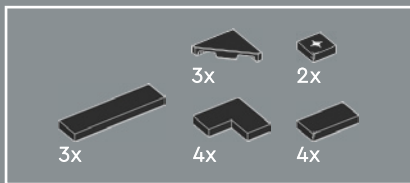

156

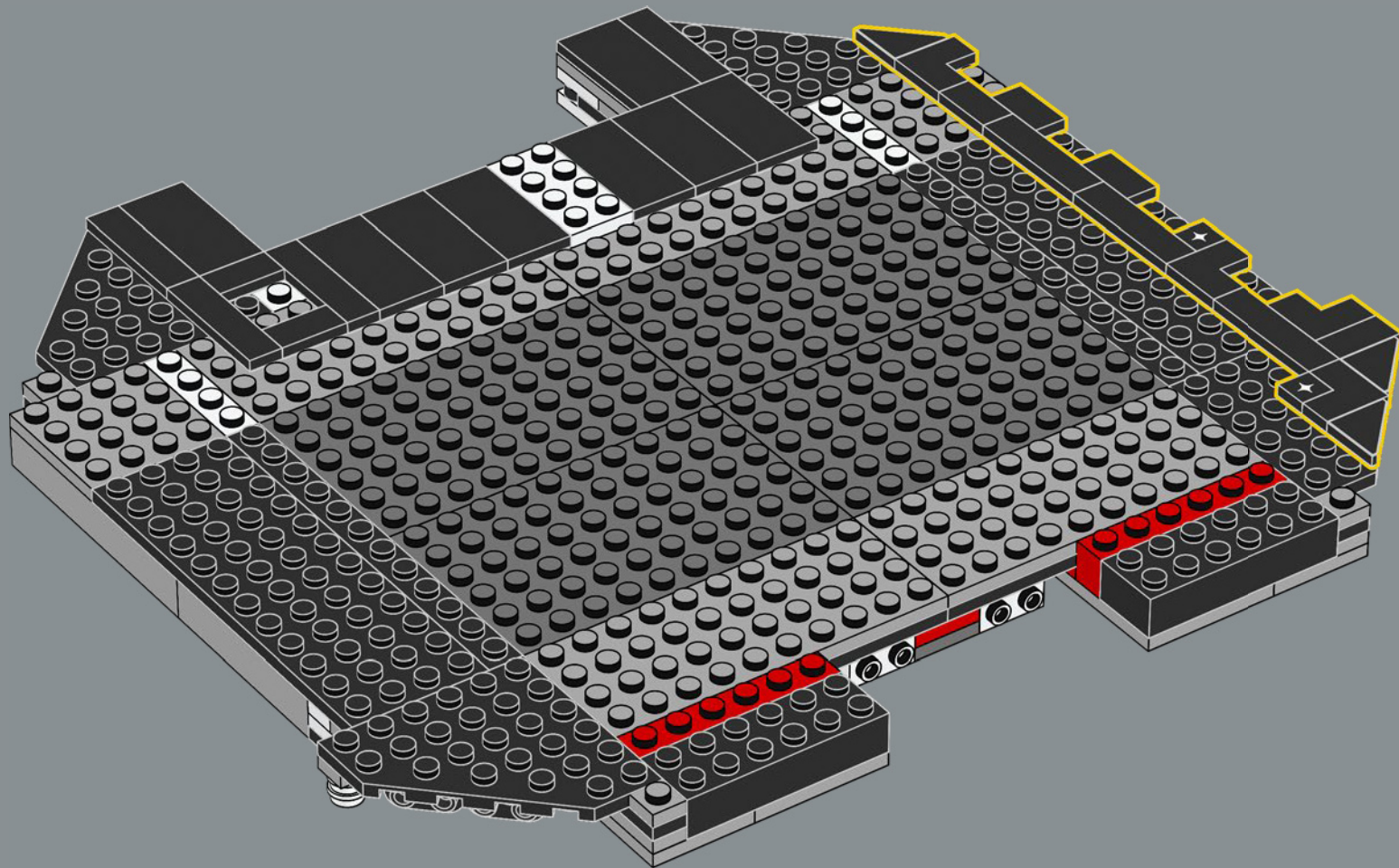

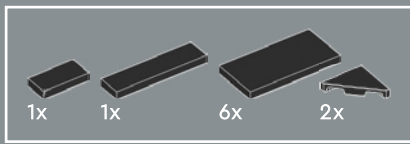

157

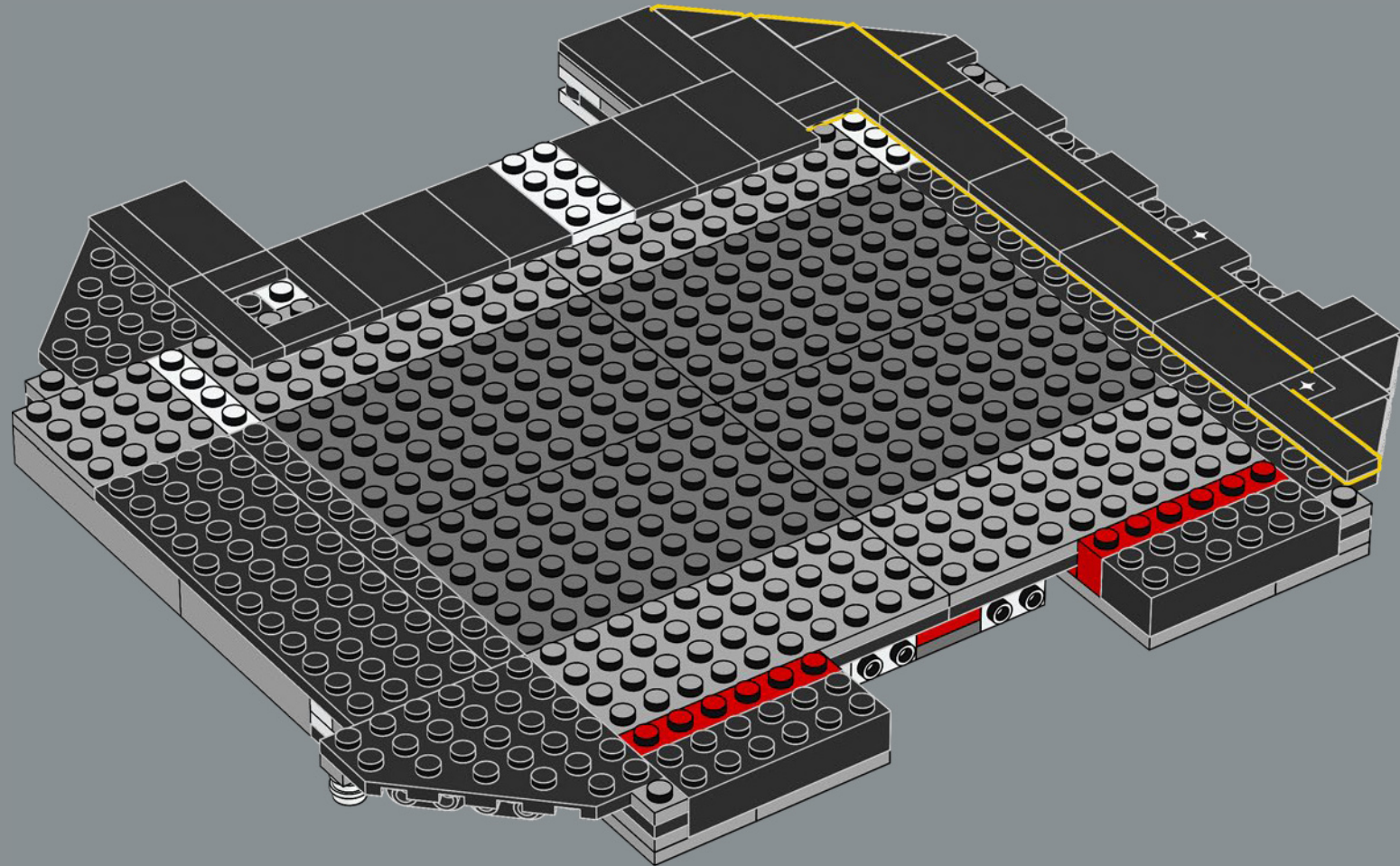

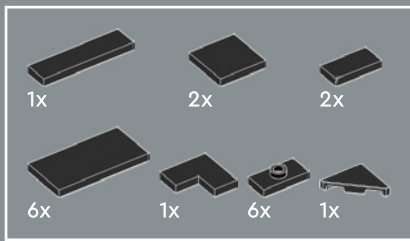

158

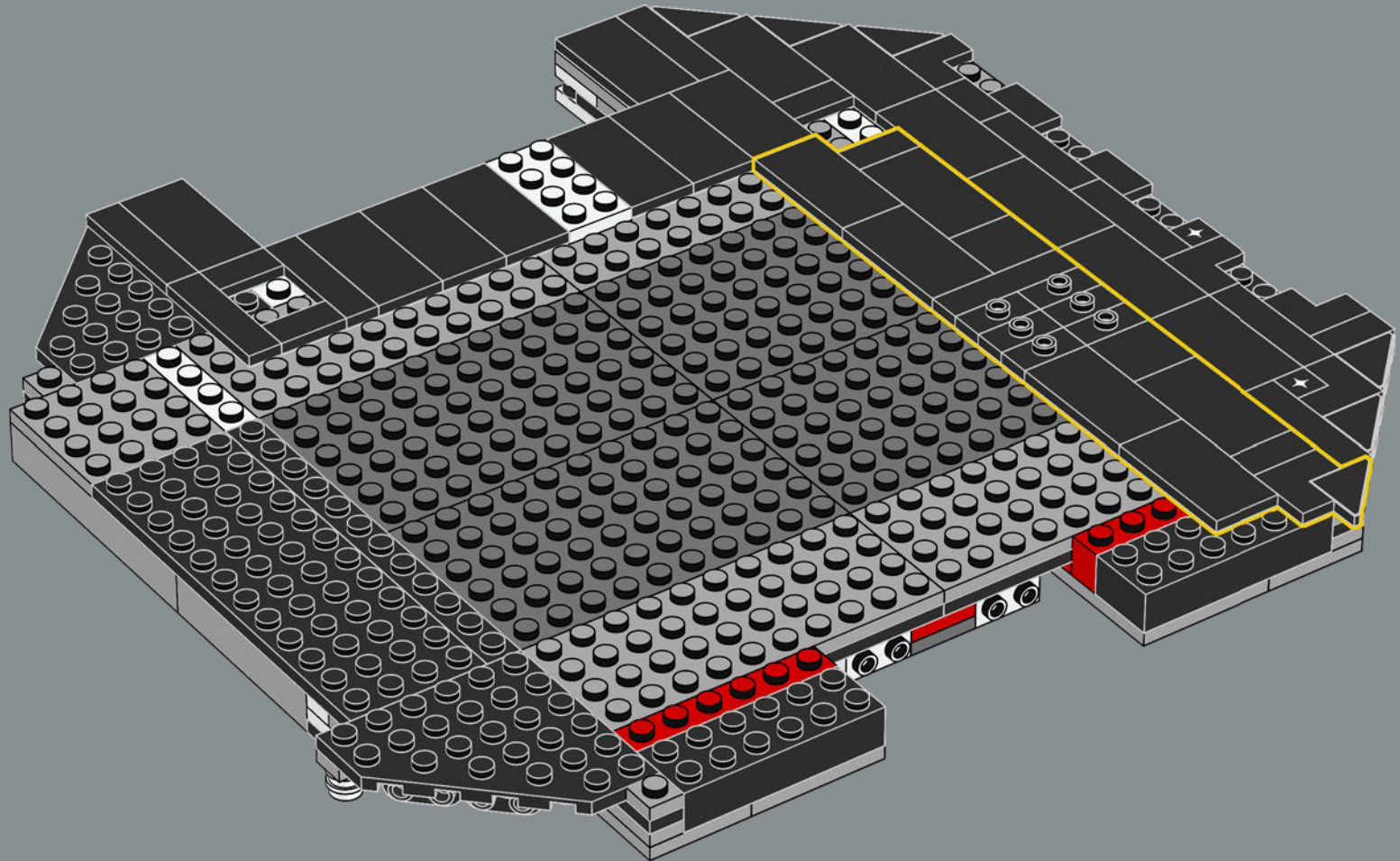

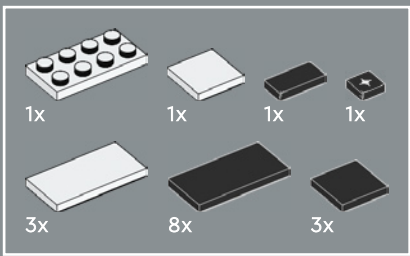

159

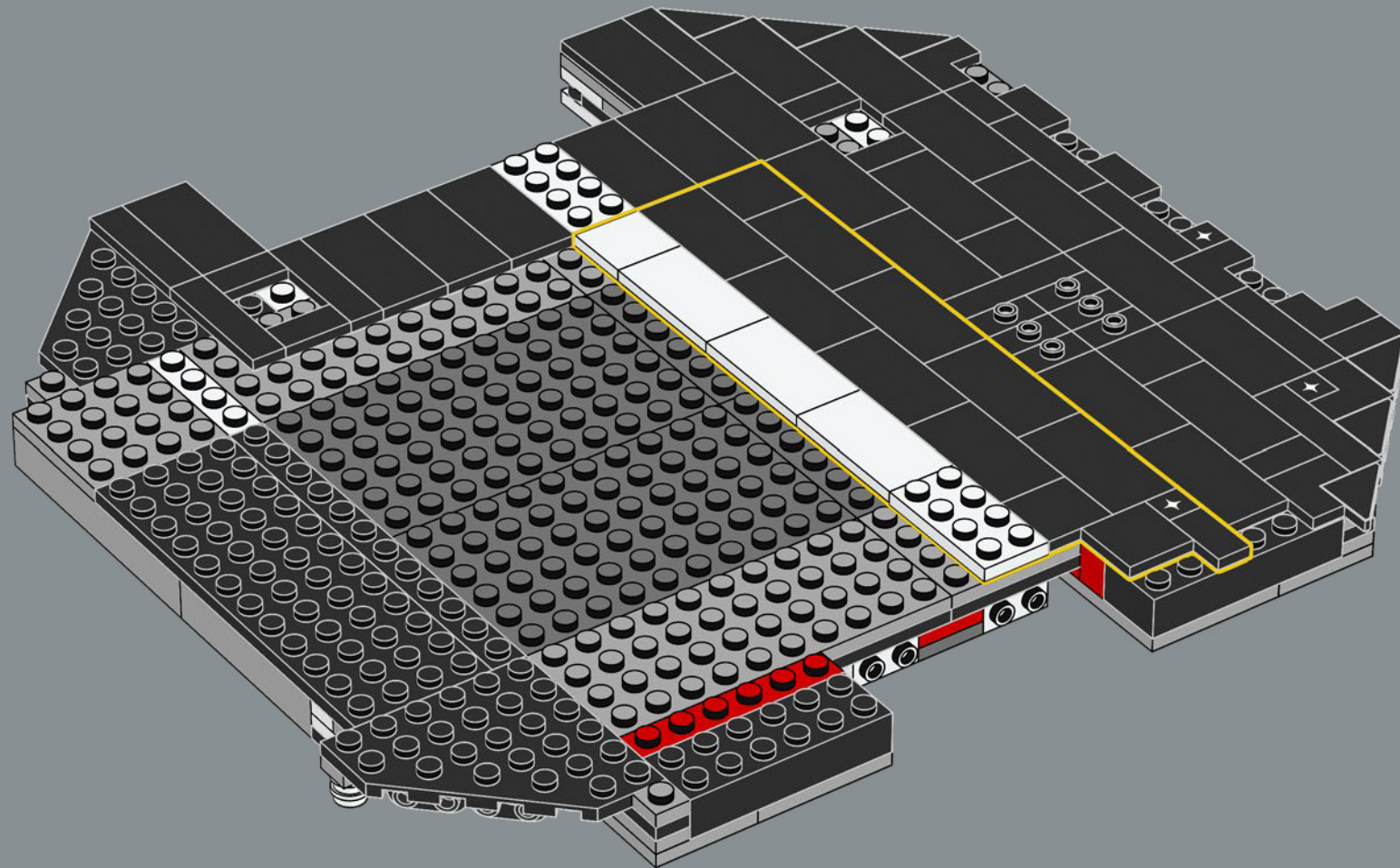

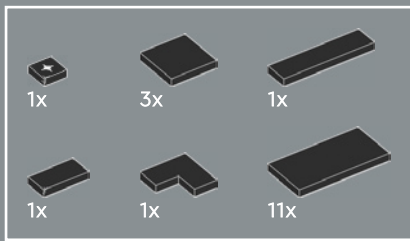

160

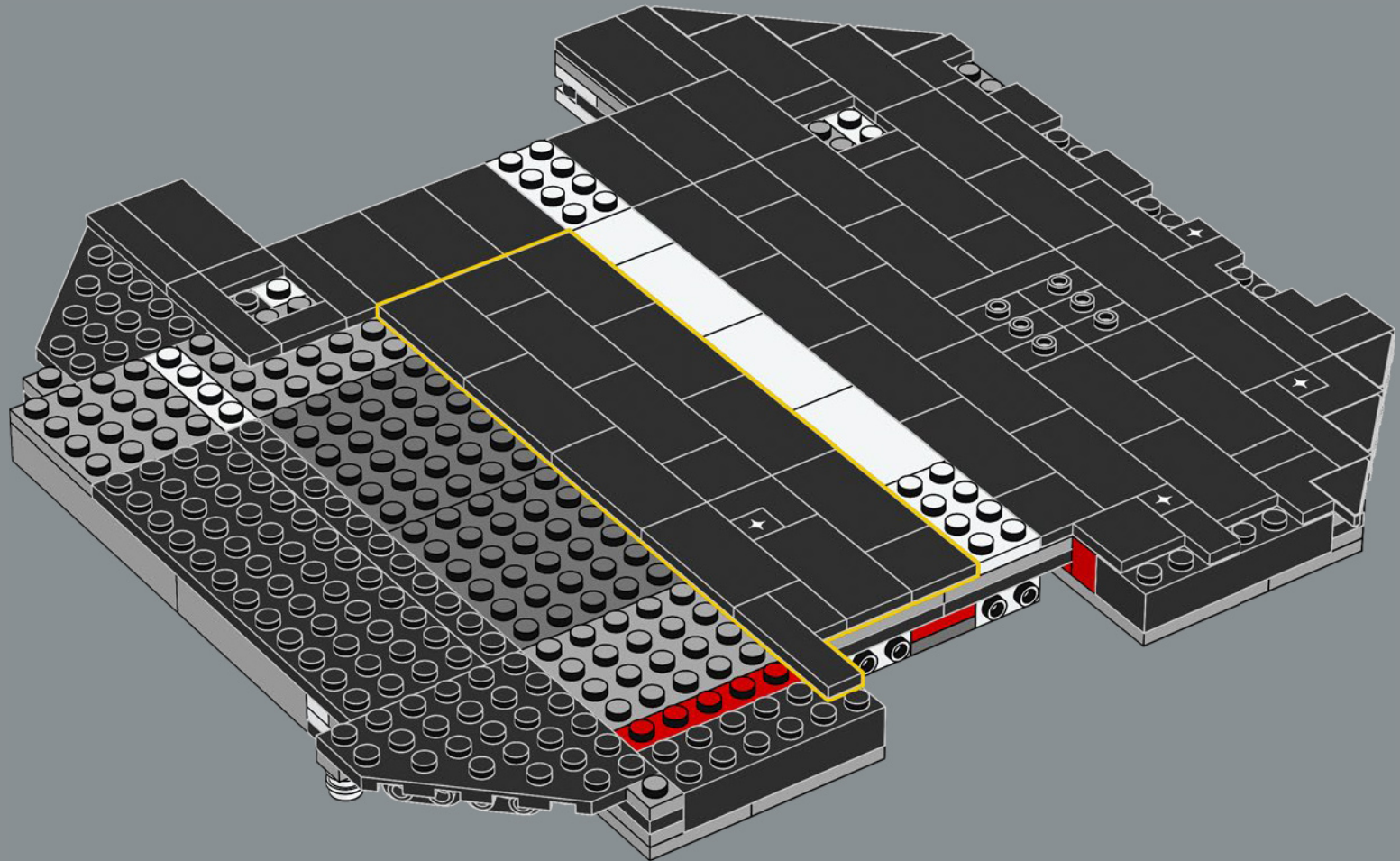

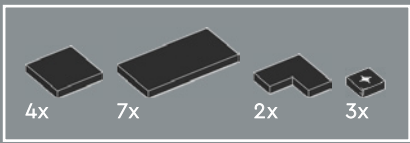

161

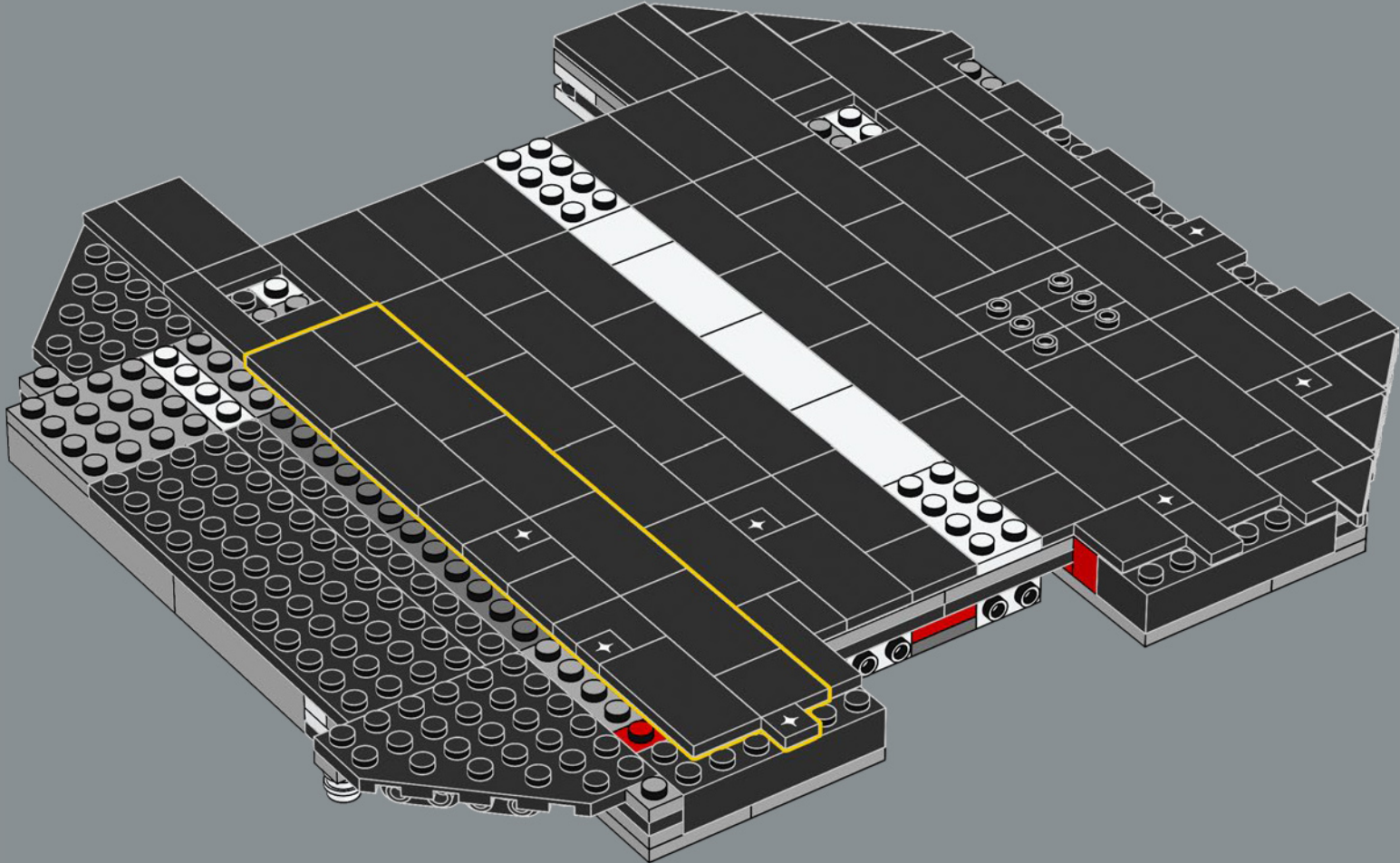

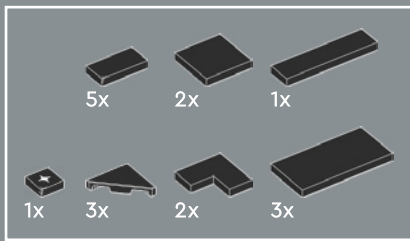

162

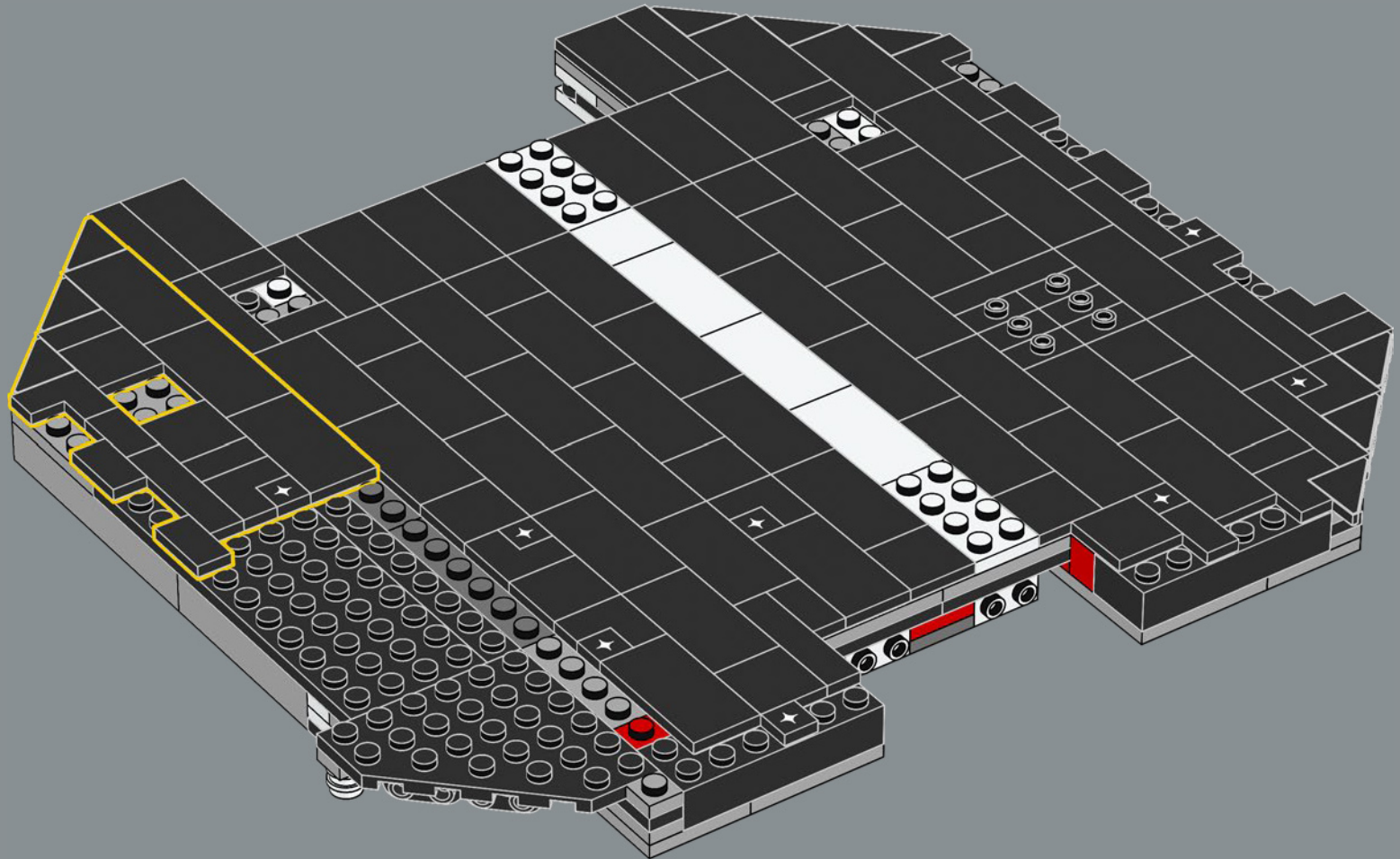

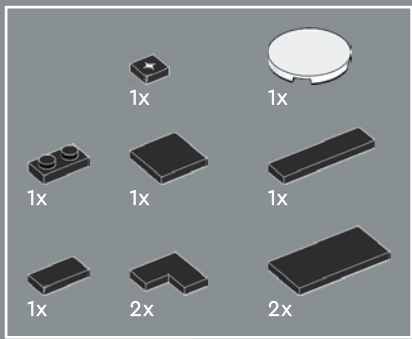

163

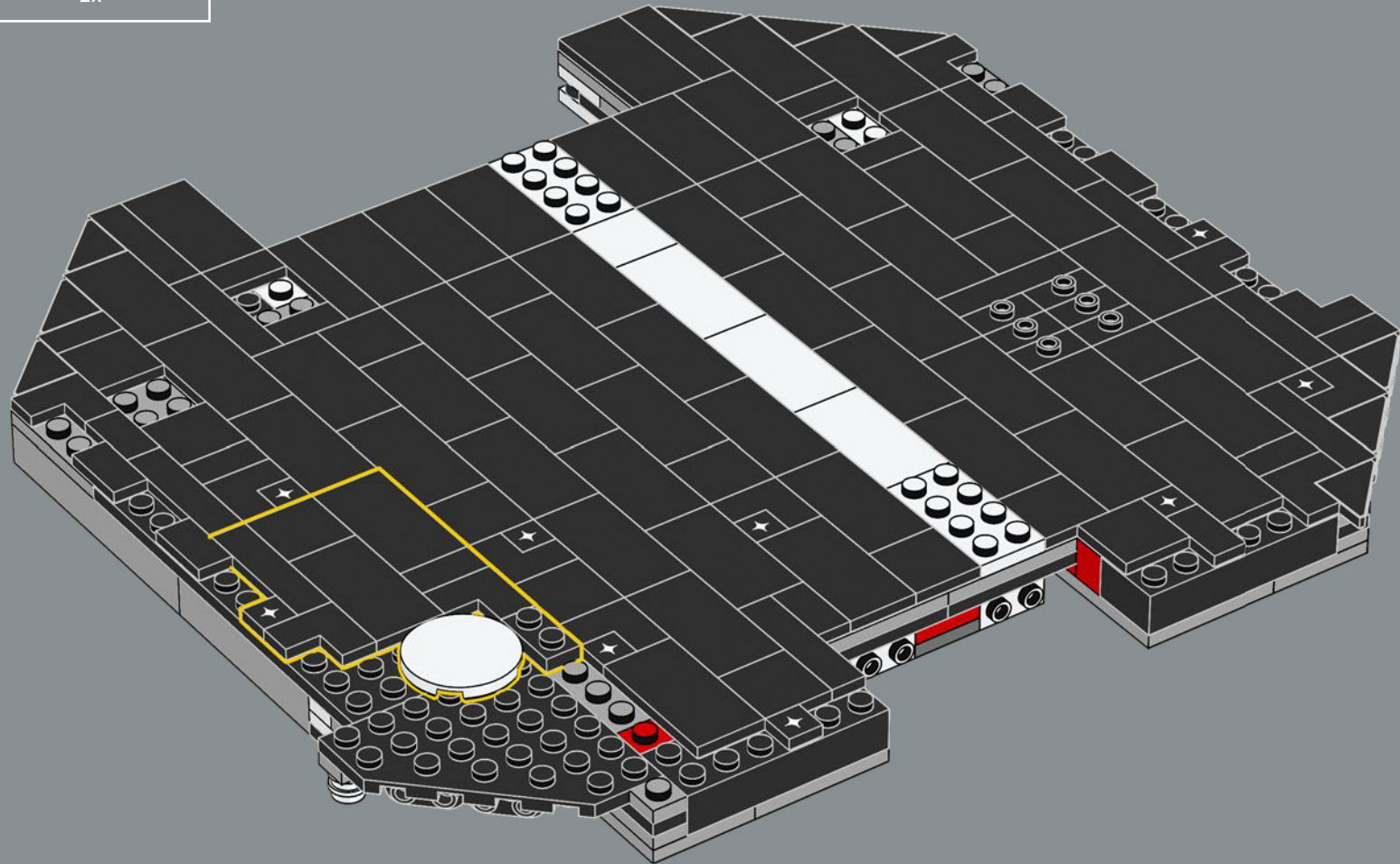

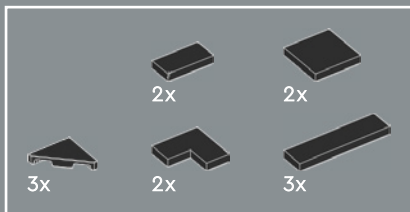

164

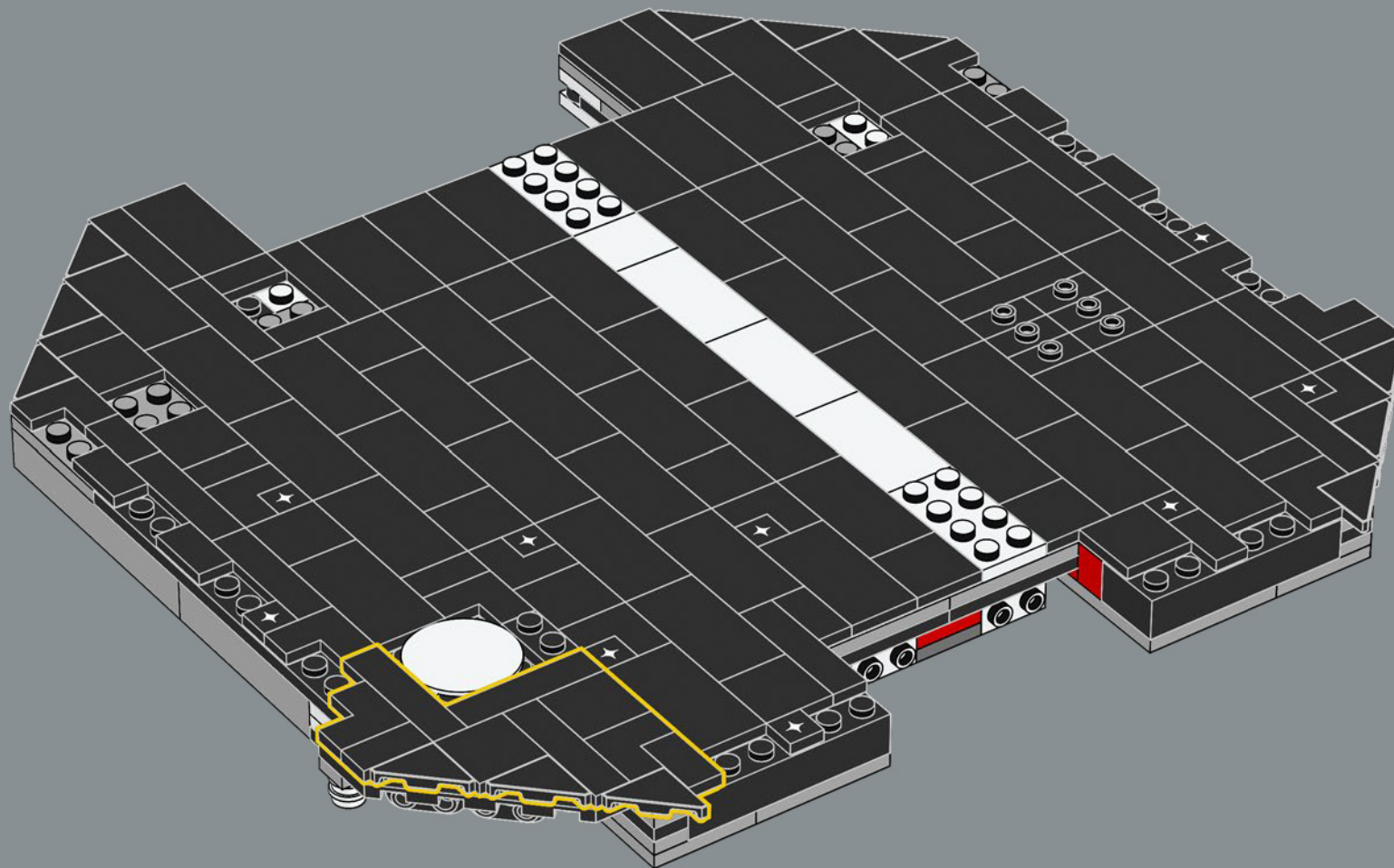

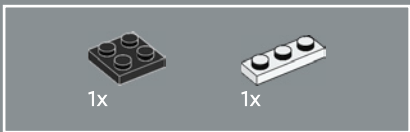

165

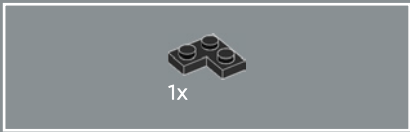
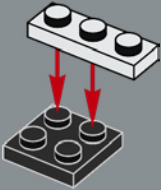

166

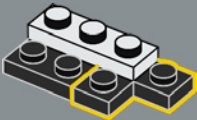

167

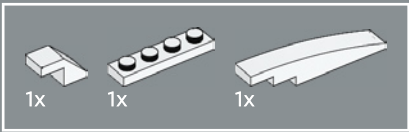
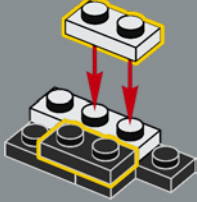

168

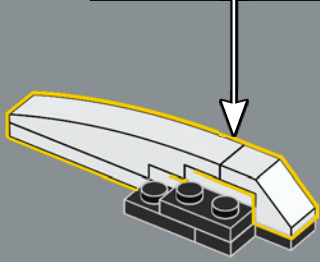
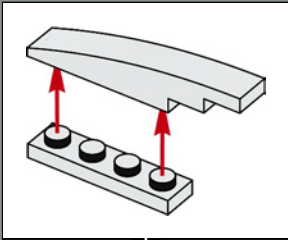

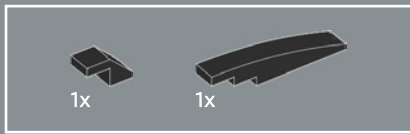

169

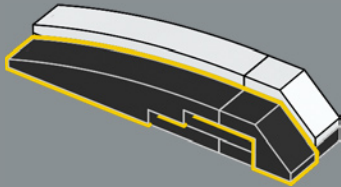

170

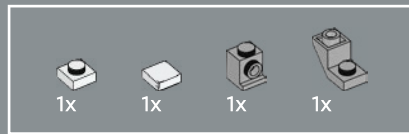
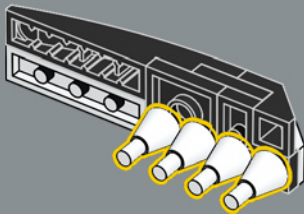

171

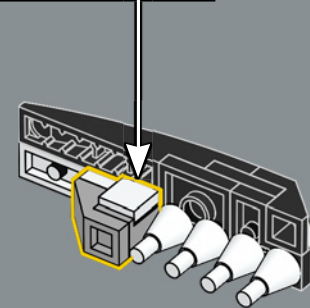
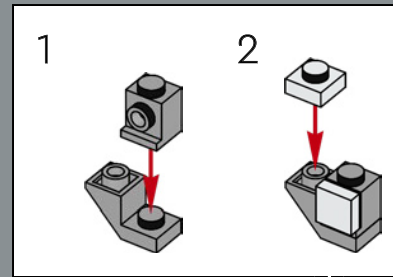

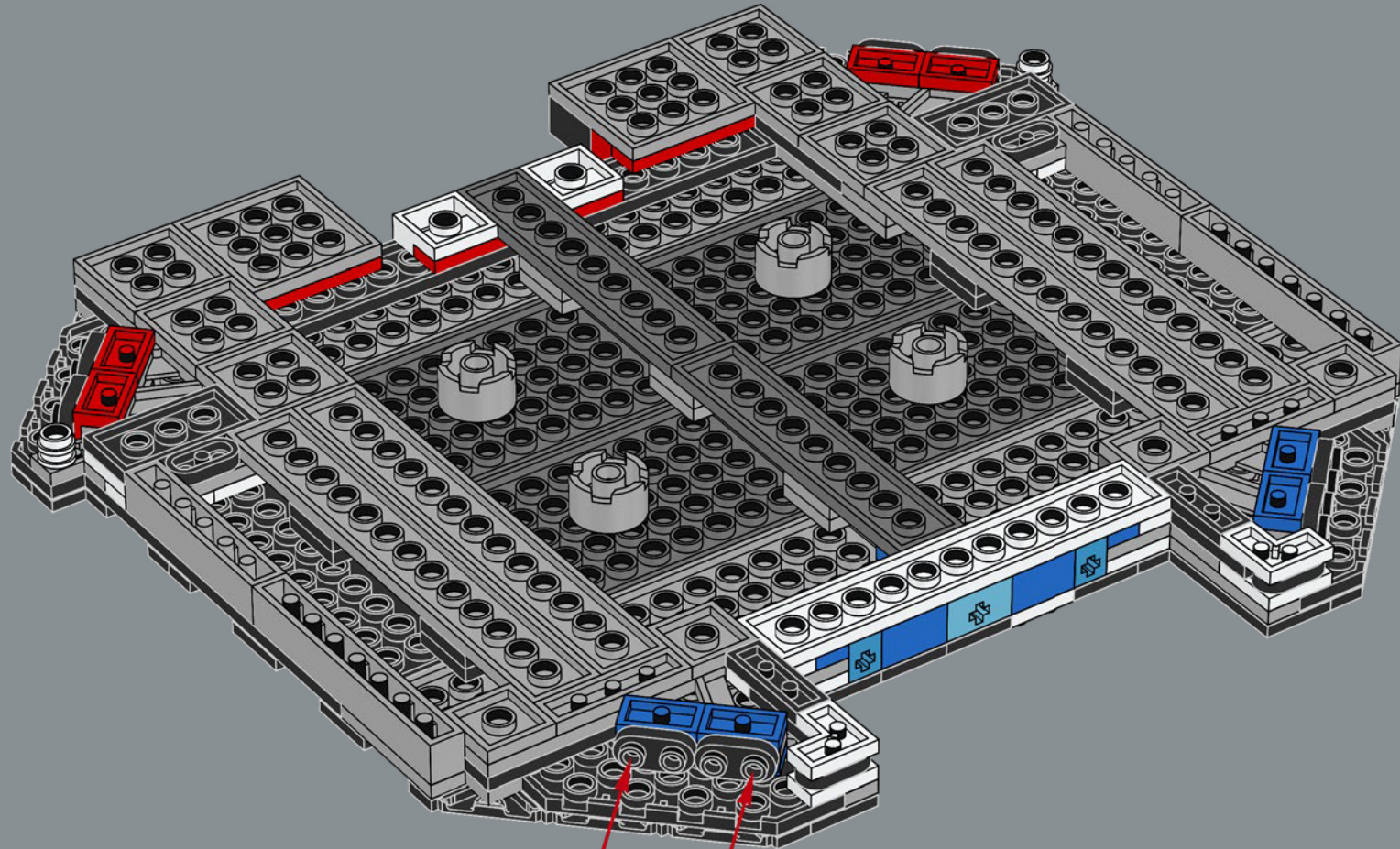

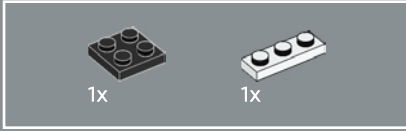
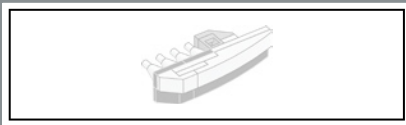

173

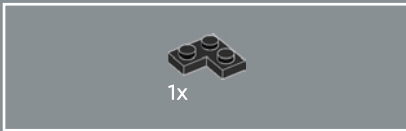
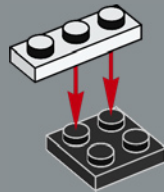

174

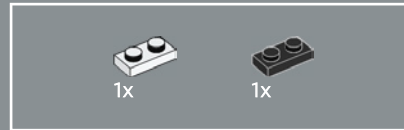
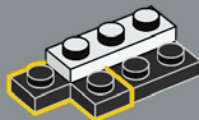

175

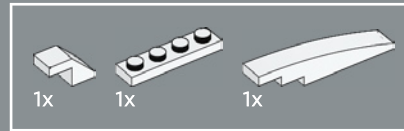
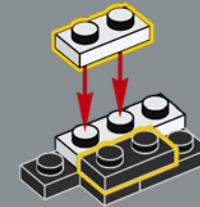

176

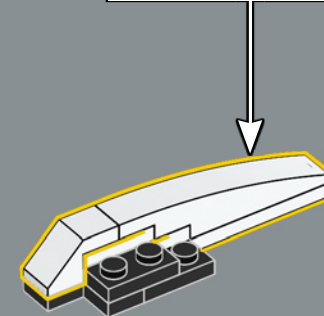
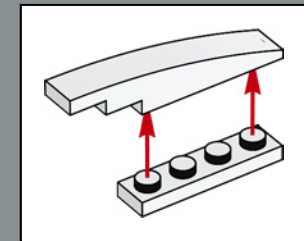

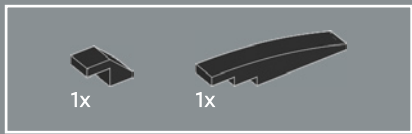

177

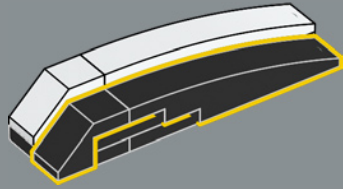

178

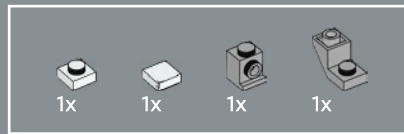
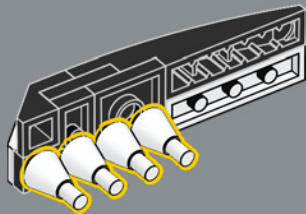

179

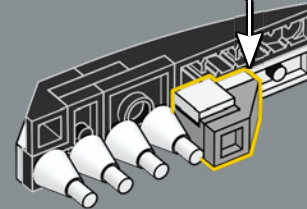
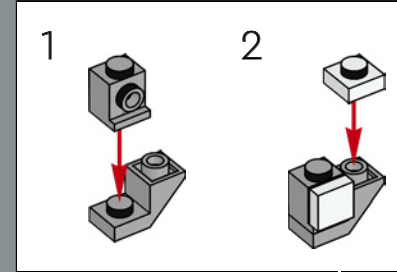

180

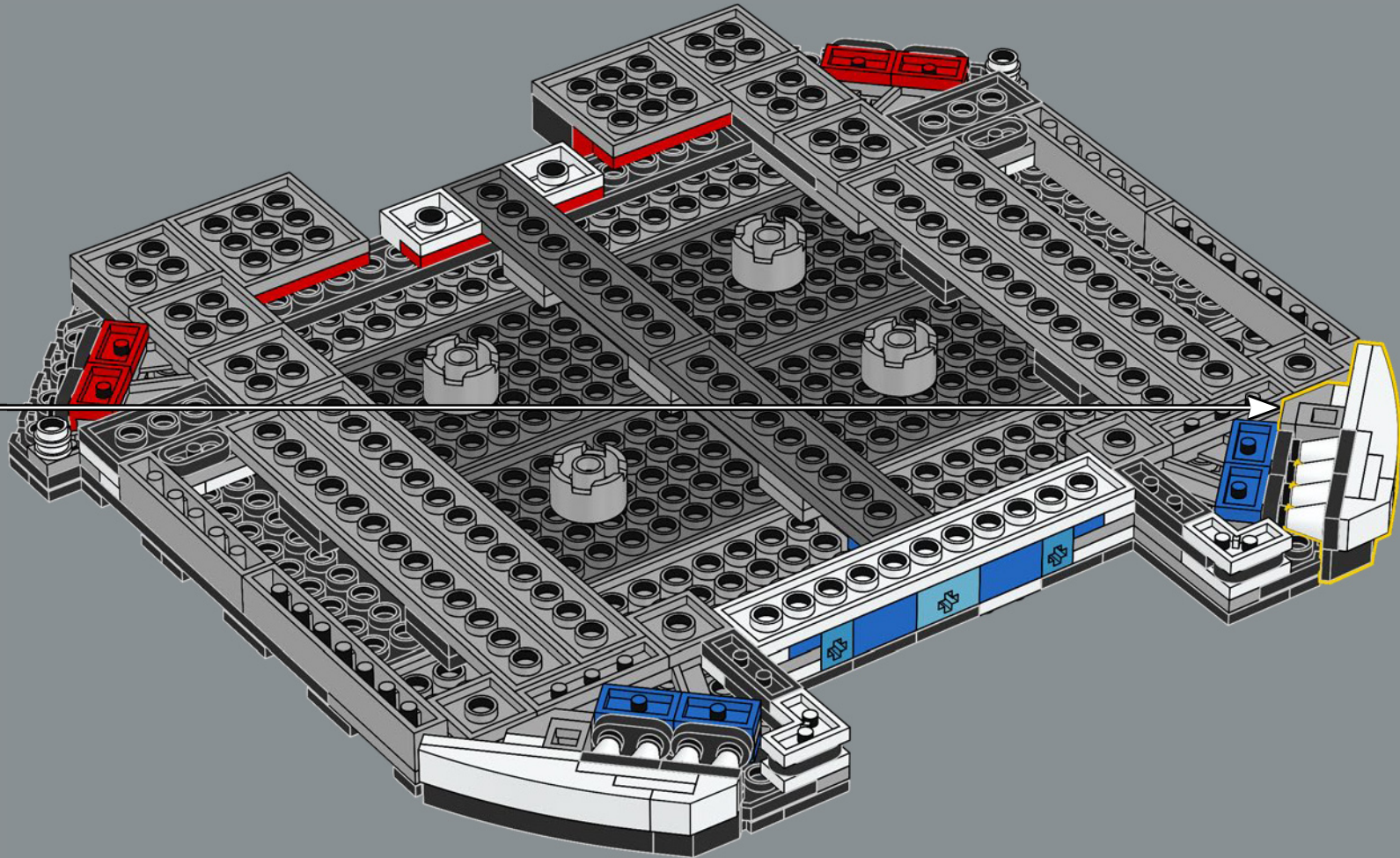

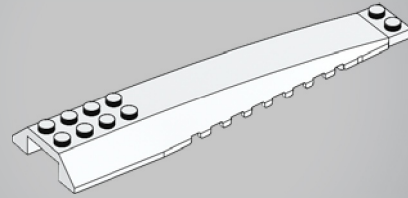
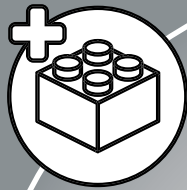

1x

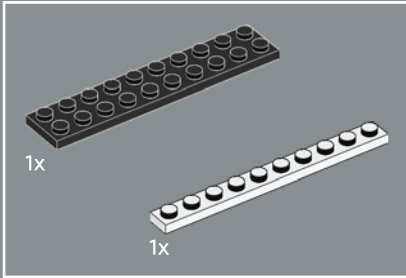
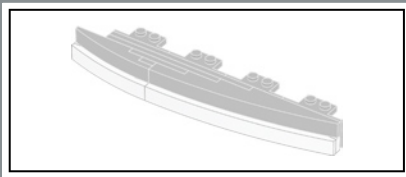

181

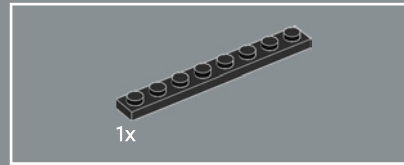
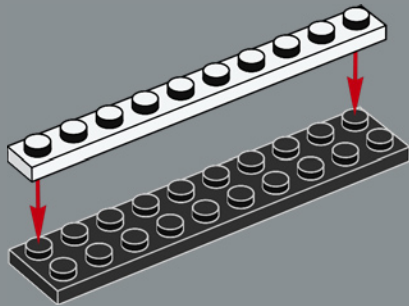

182

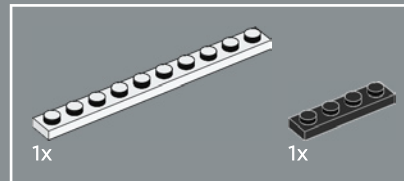
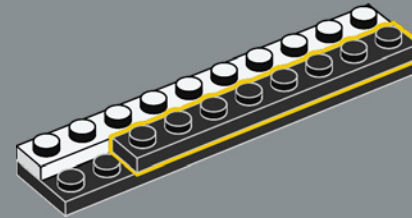

183

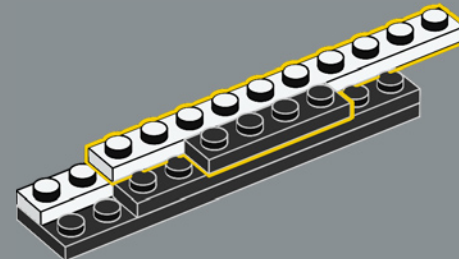

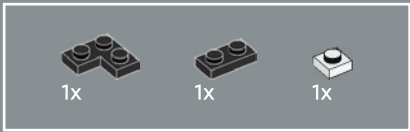

184

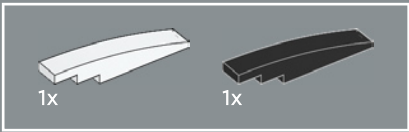
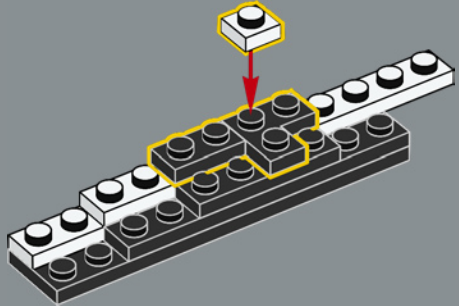

185

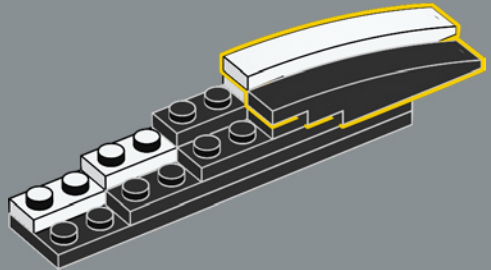

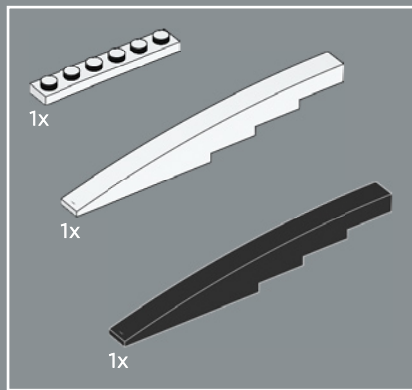

186

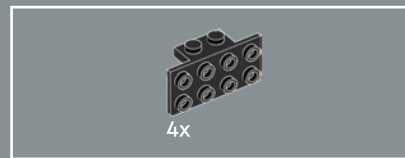
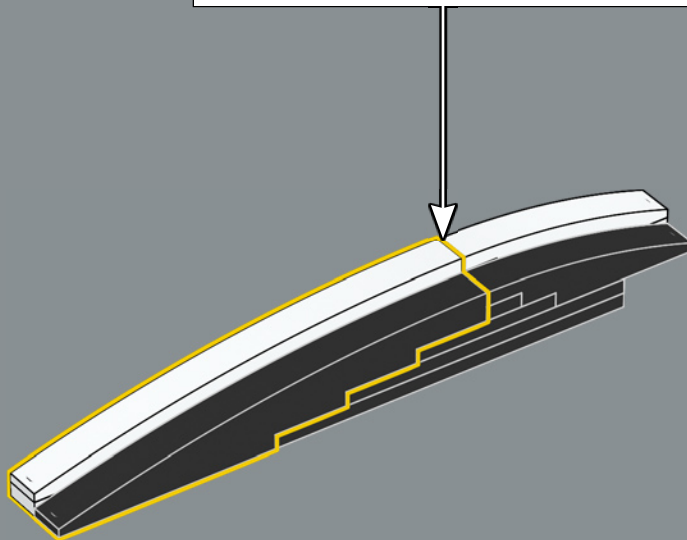
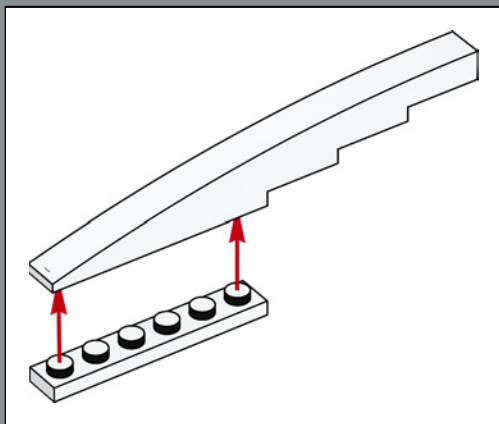

187

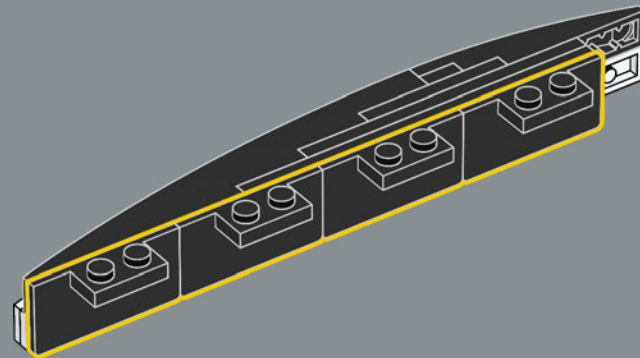

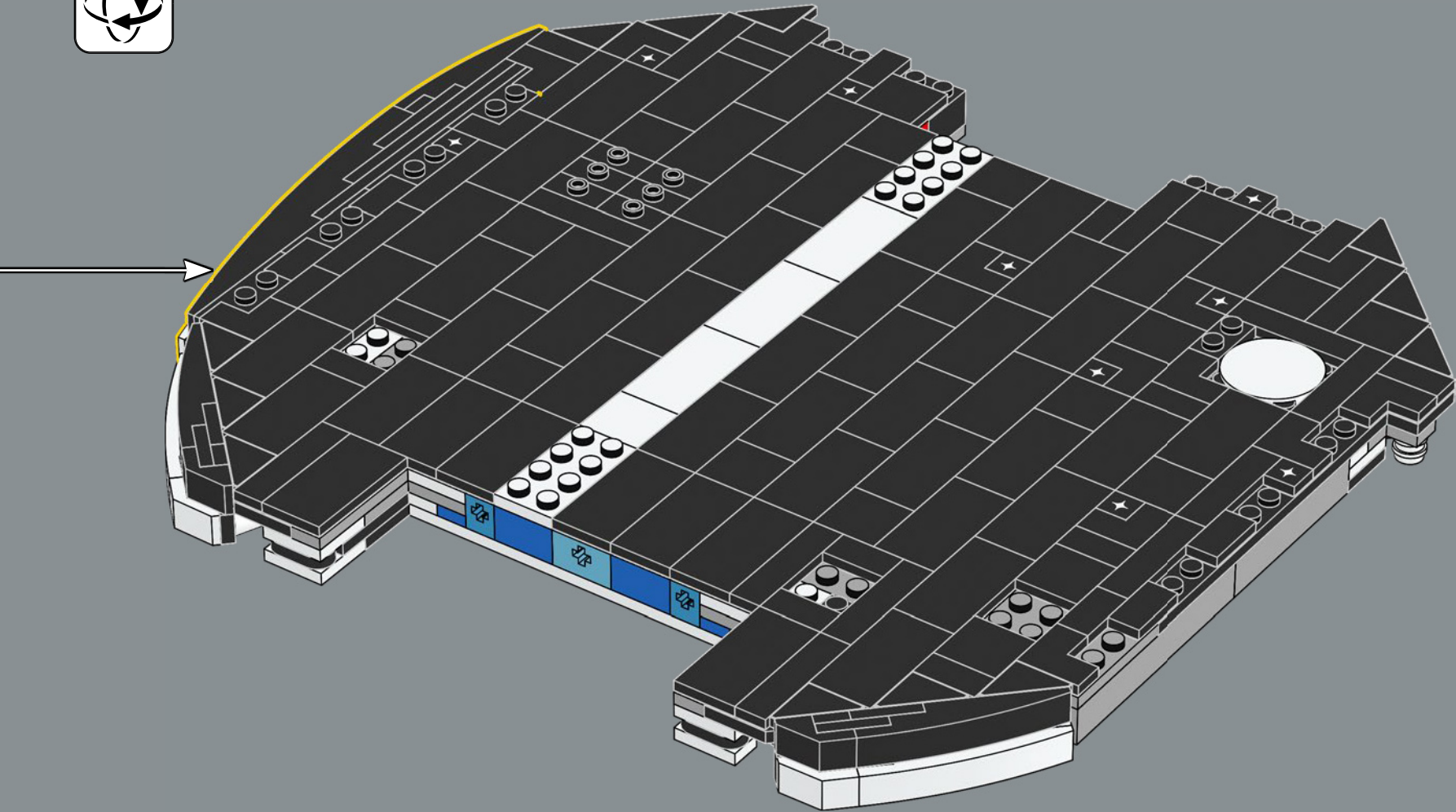

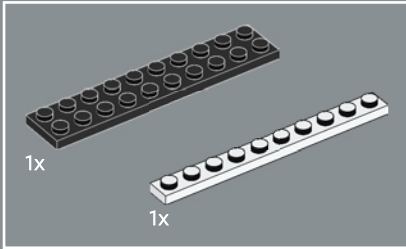
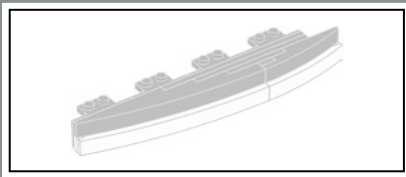

189

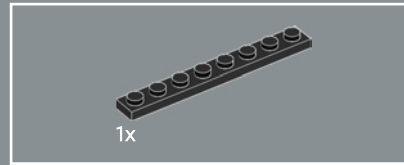
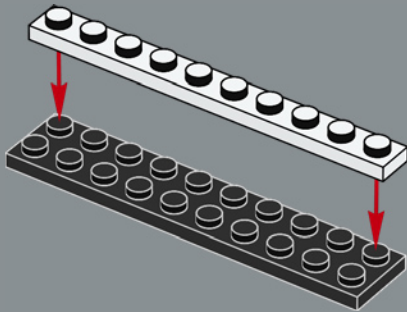

190

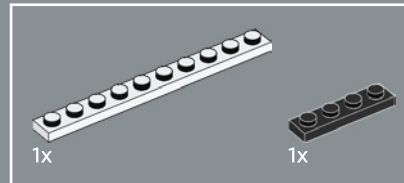
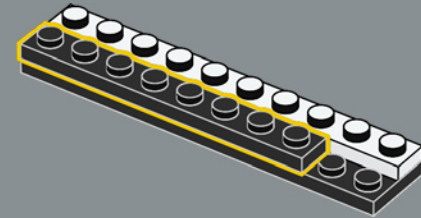

191

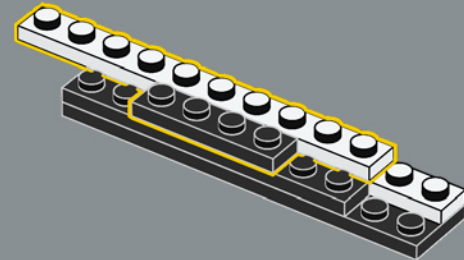

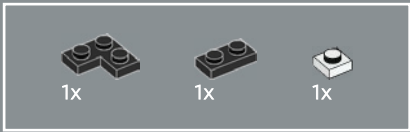

192

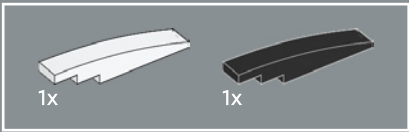
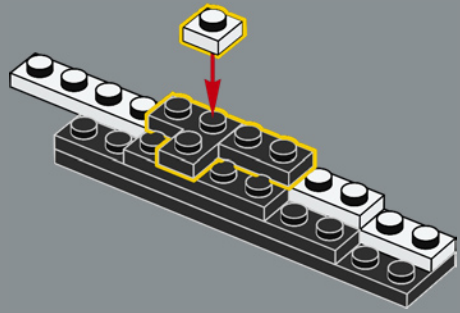

193

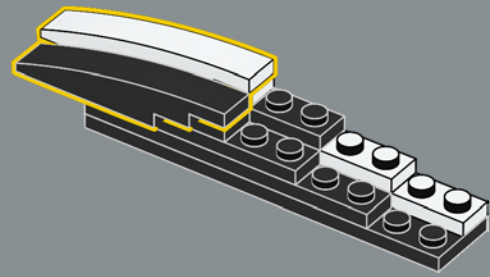

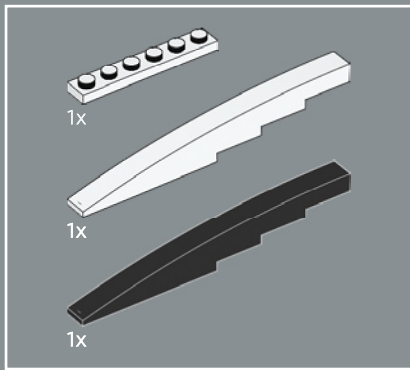

194

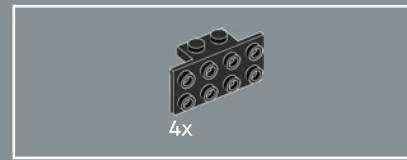
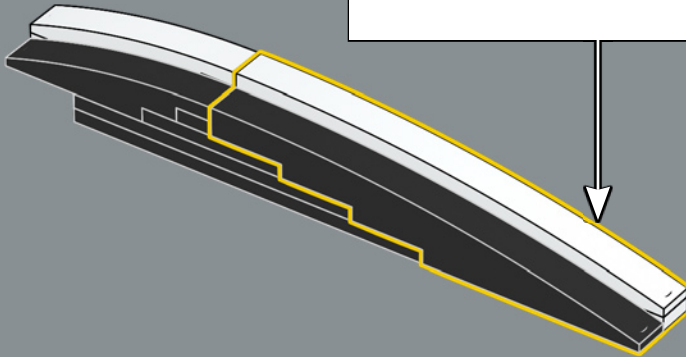
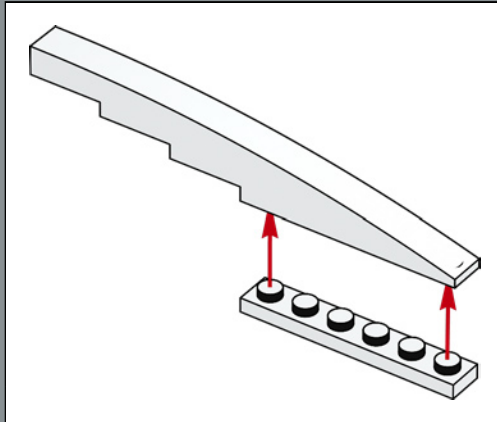

195

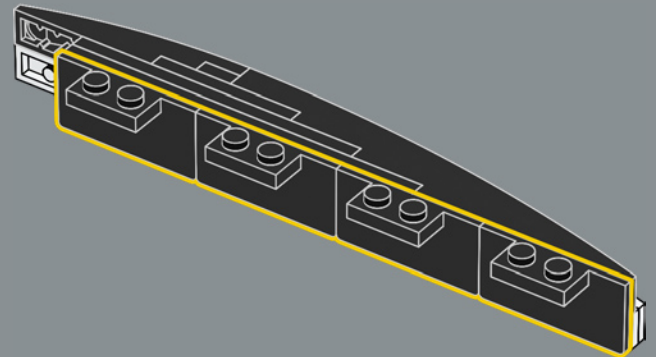

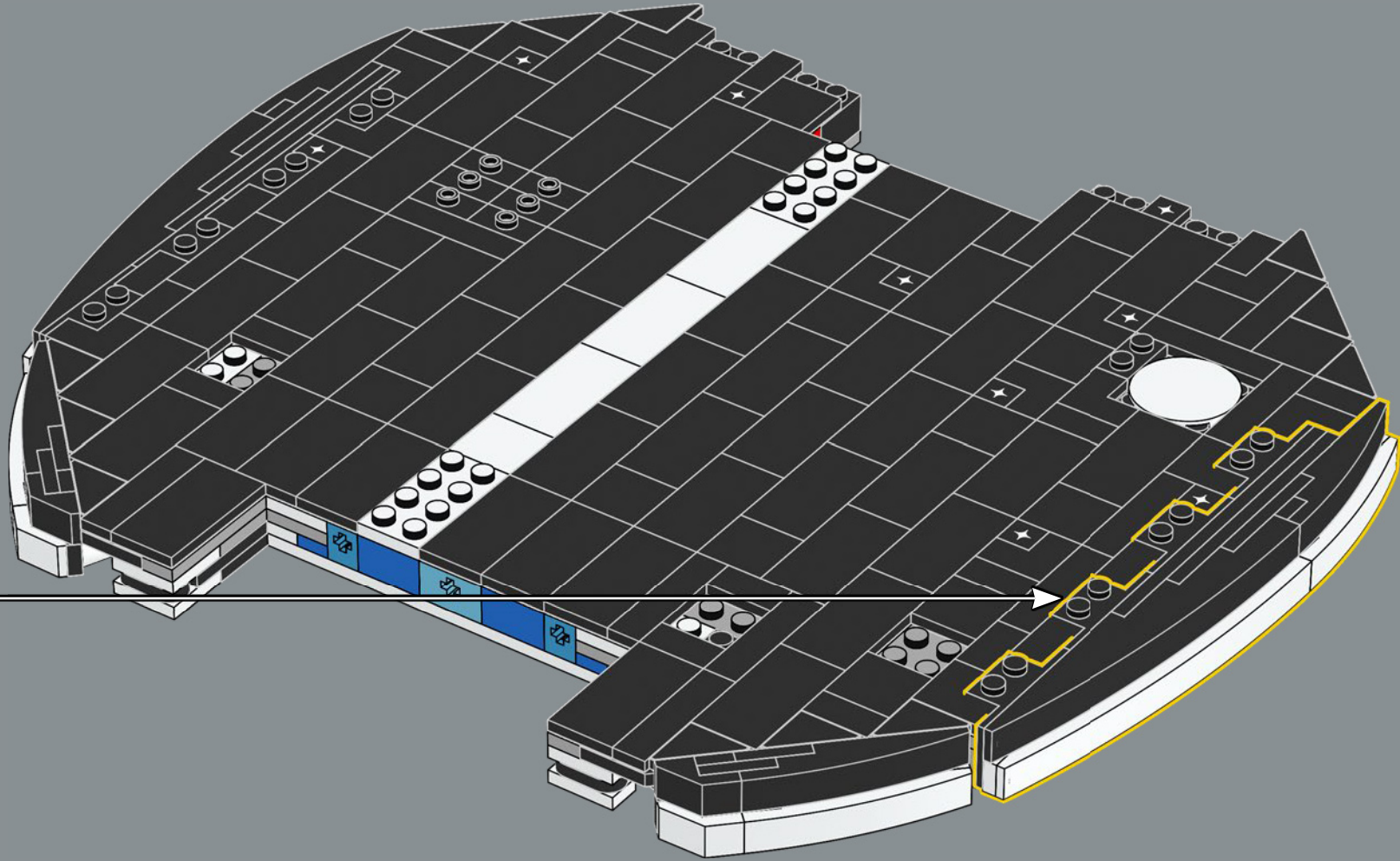

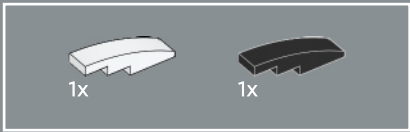

201

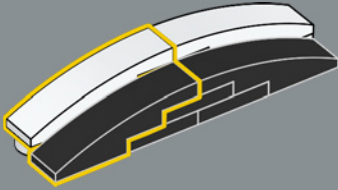

202

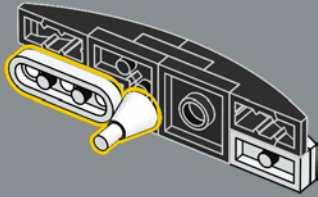

203

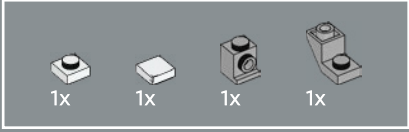
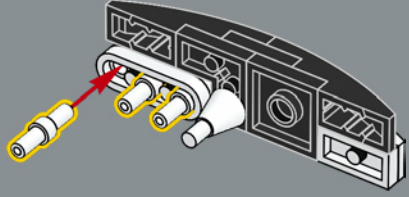

204

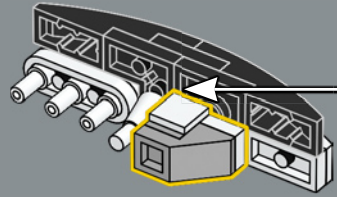
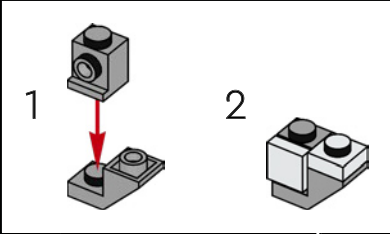

205

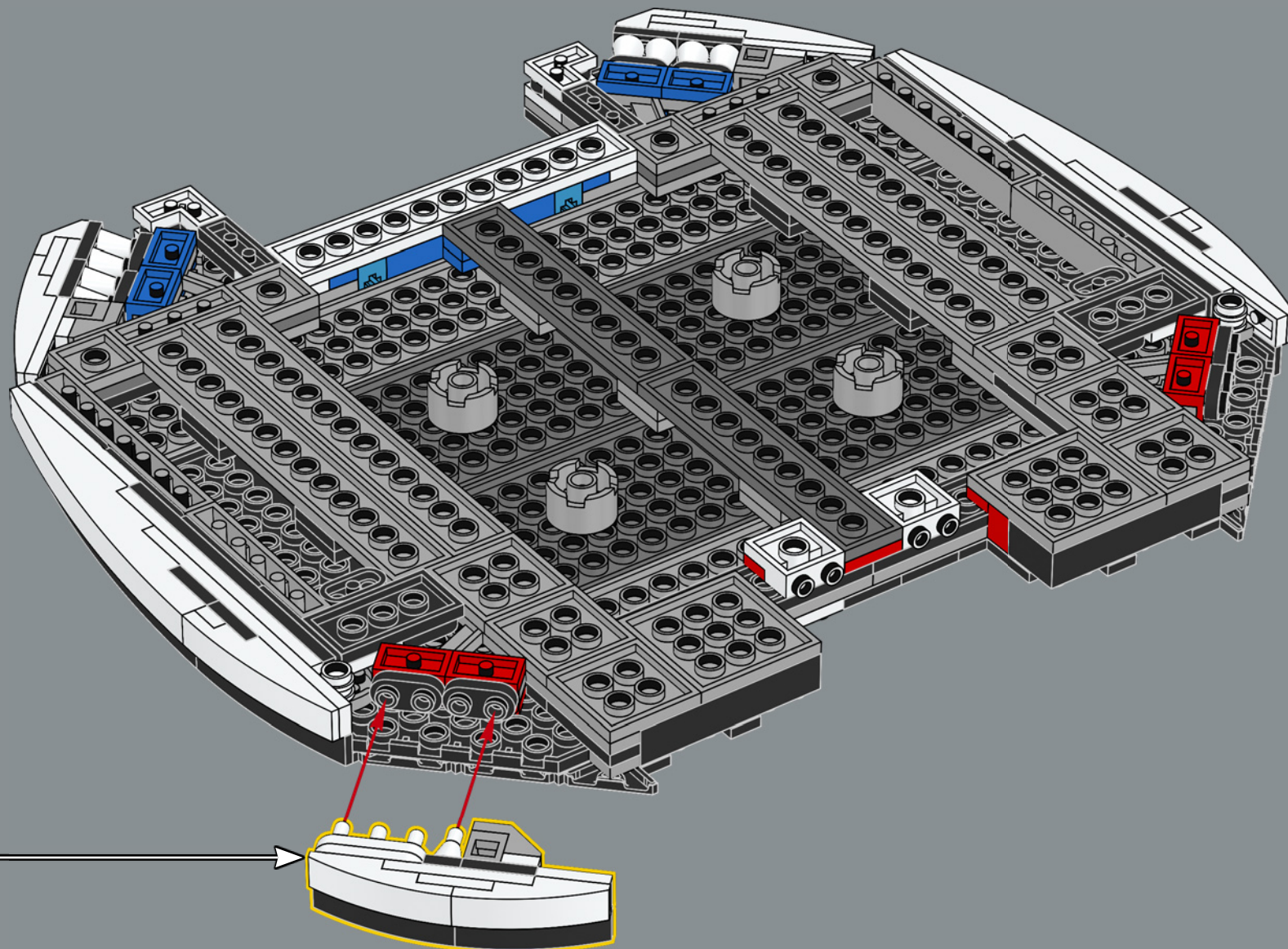

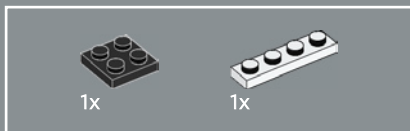

206

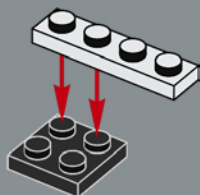

207

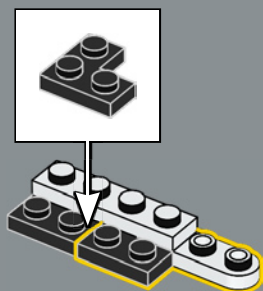

208

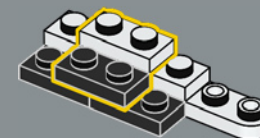

209

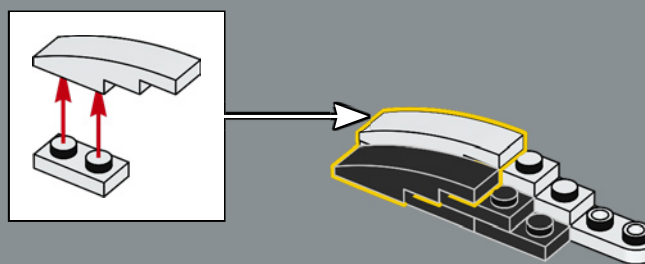

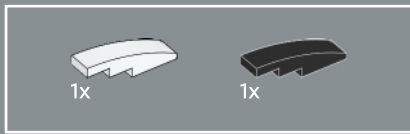

210

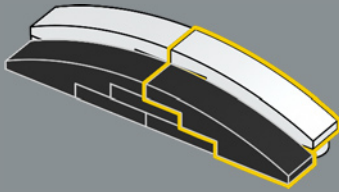

211

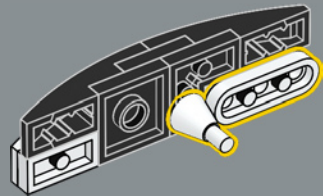

212

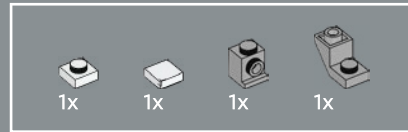
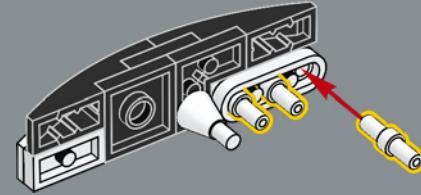

213

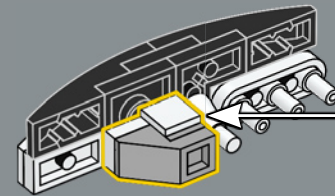
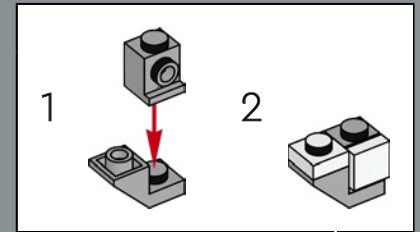

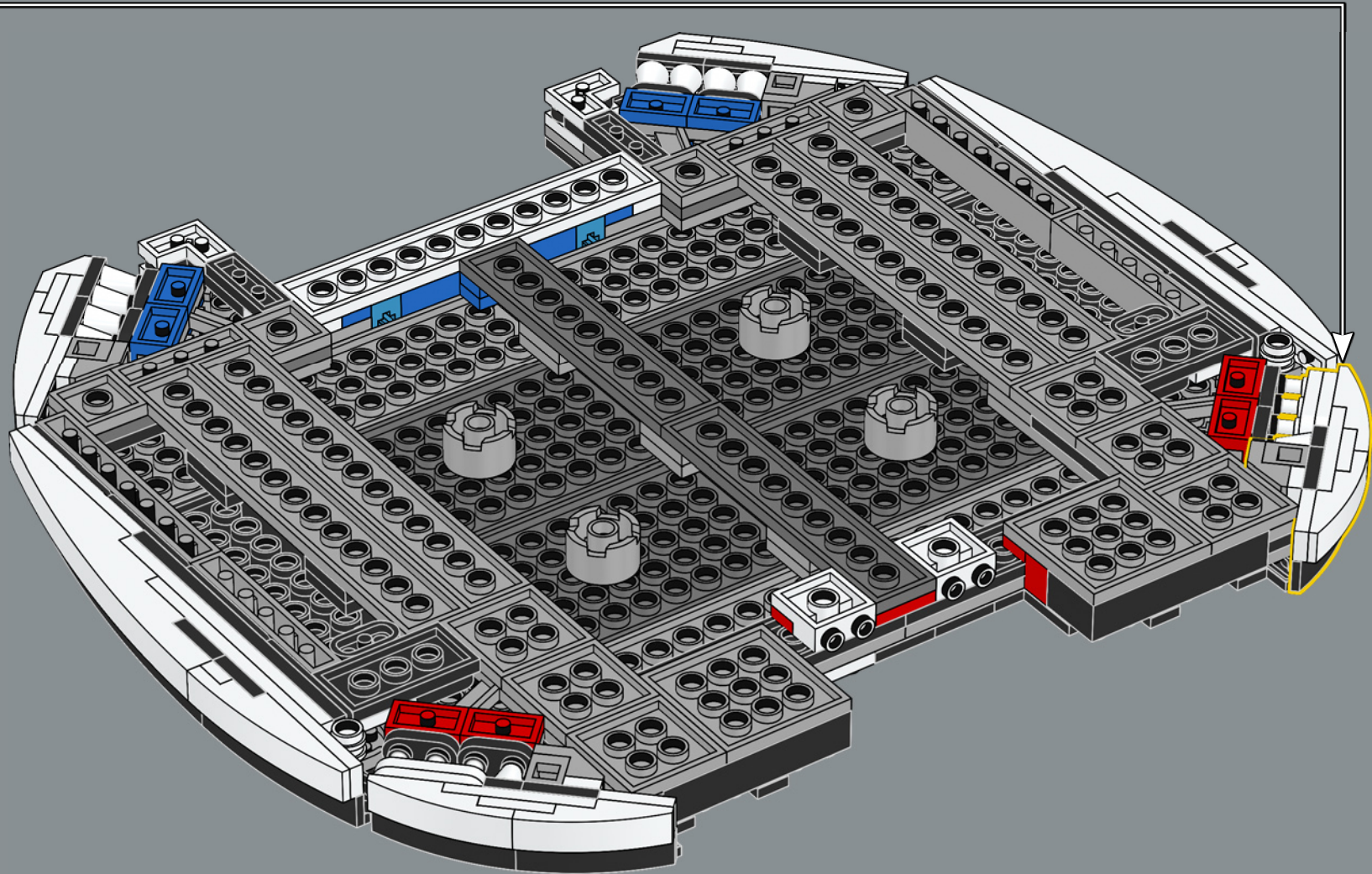

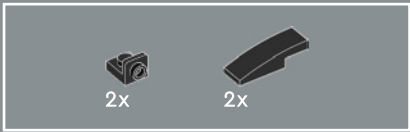

215

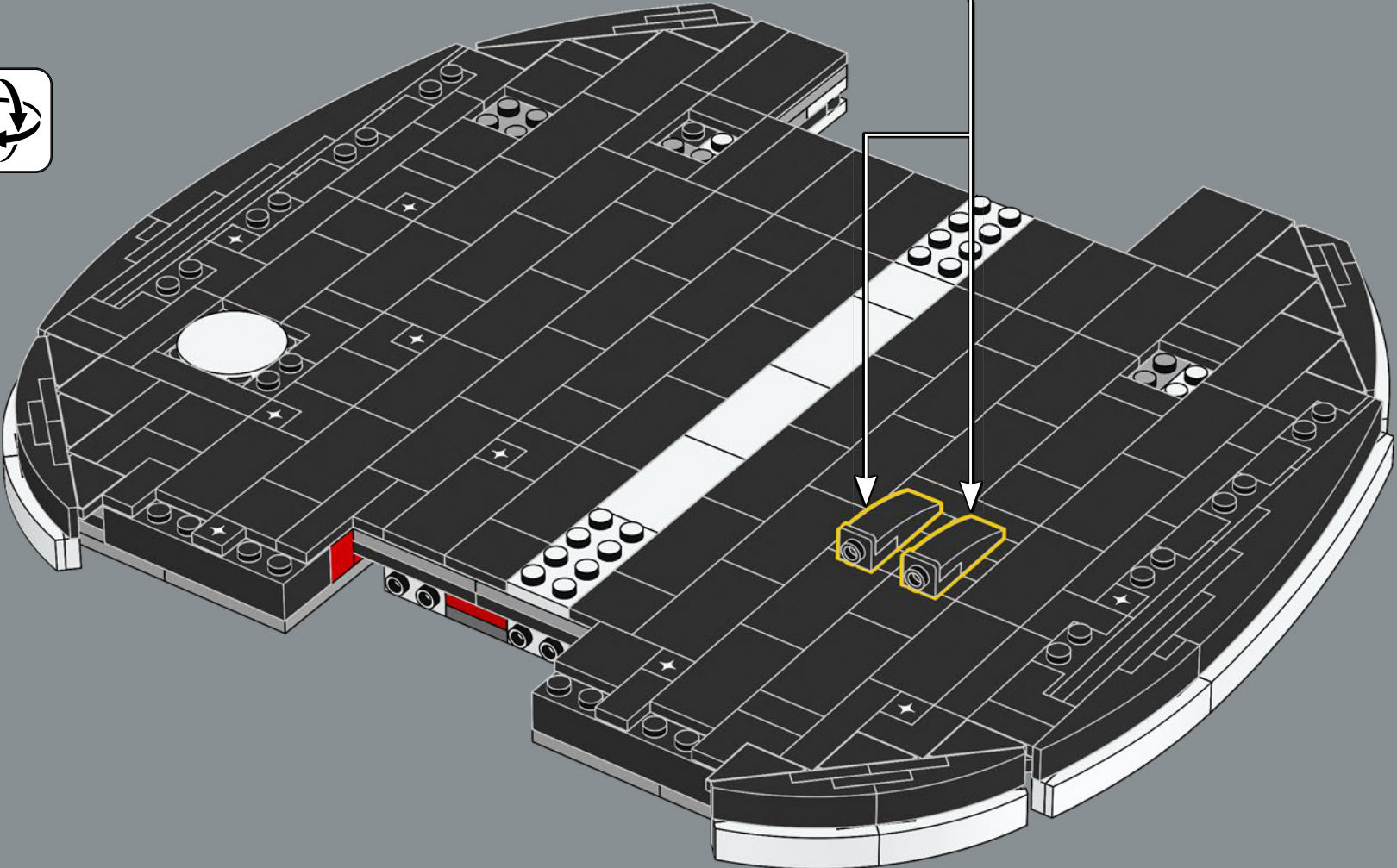
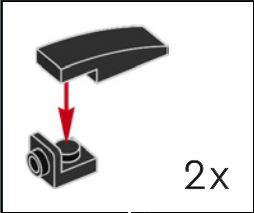

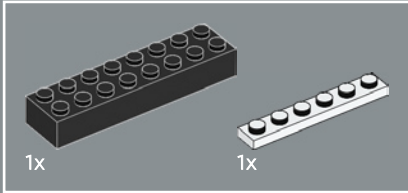
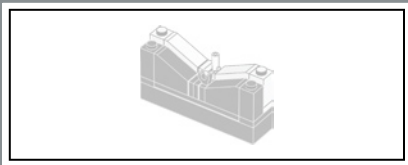

216

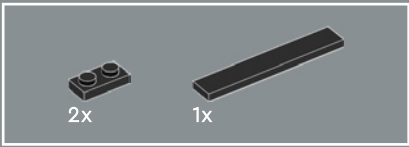
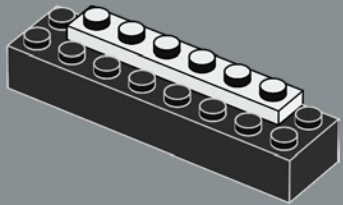

217

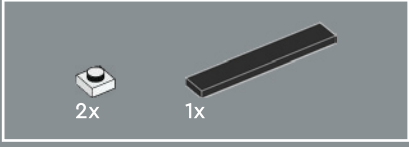
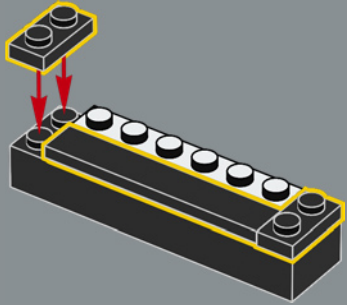

218

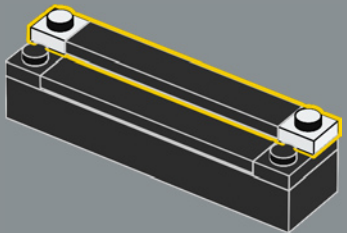



219

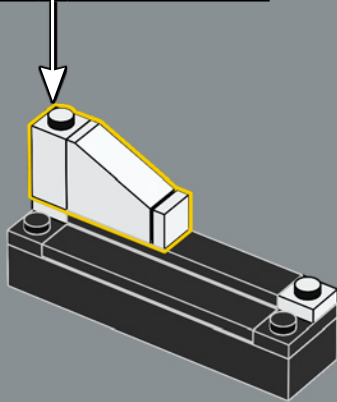
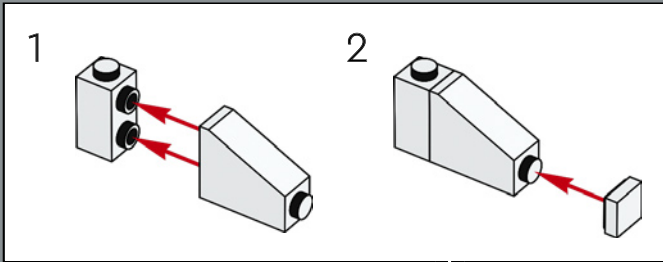

220

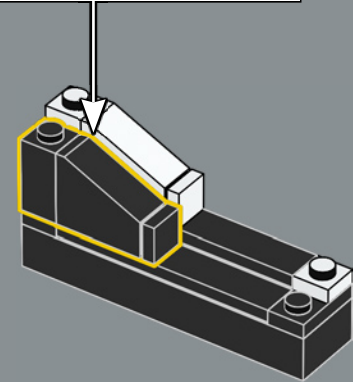
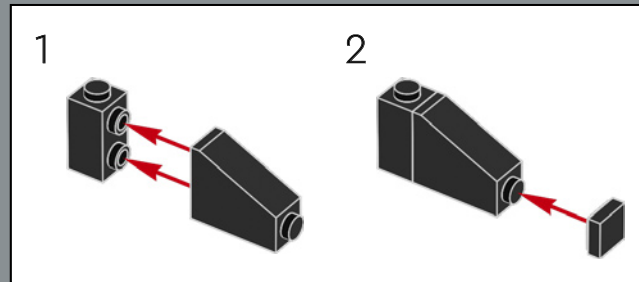

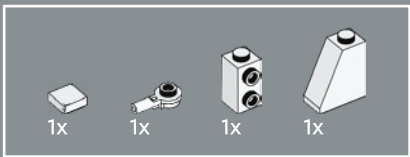

221

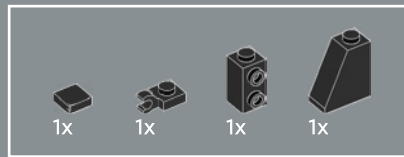
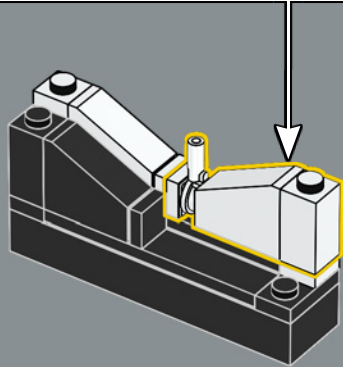
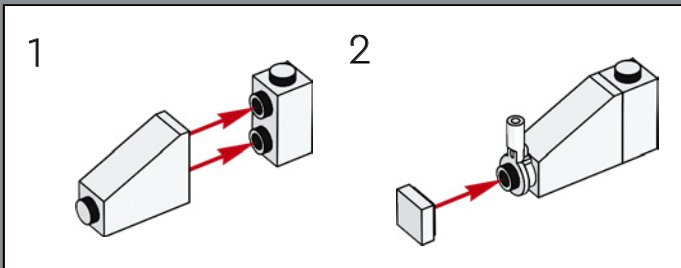

222

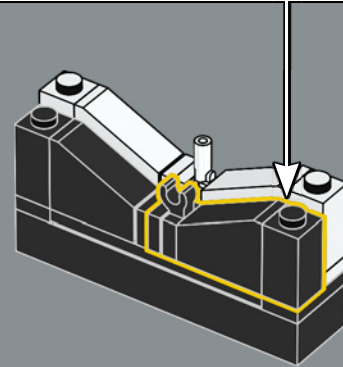
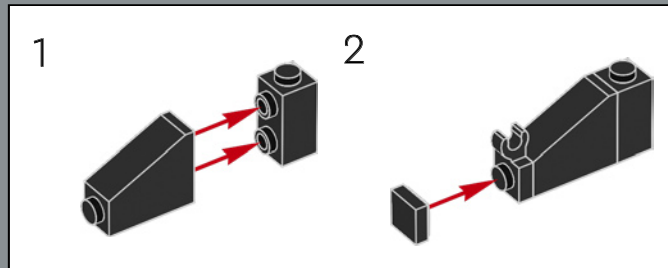

223

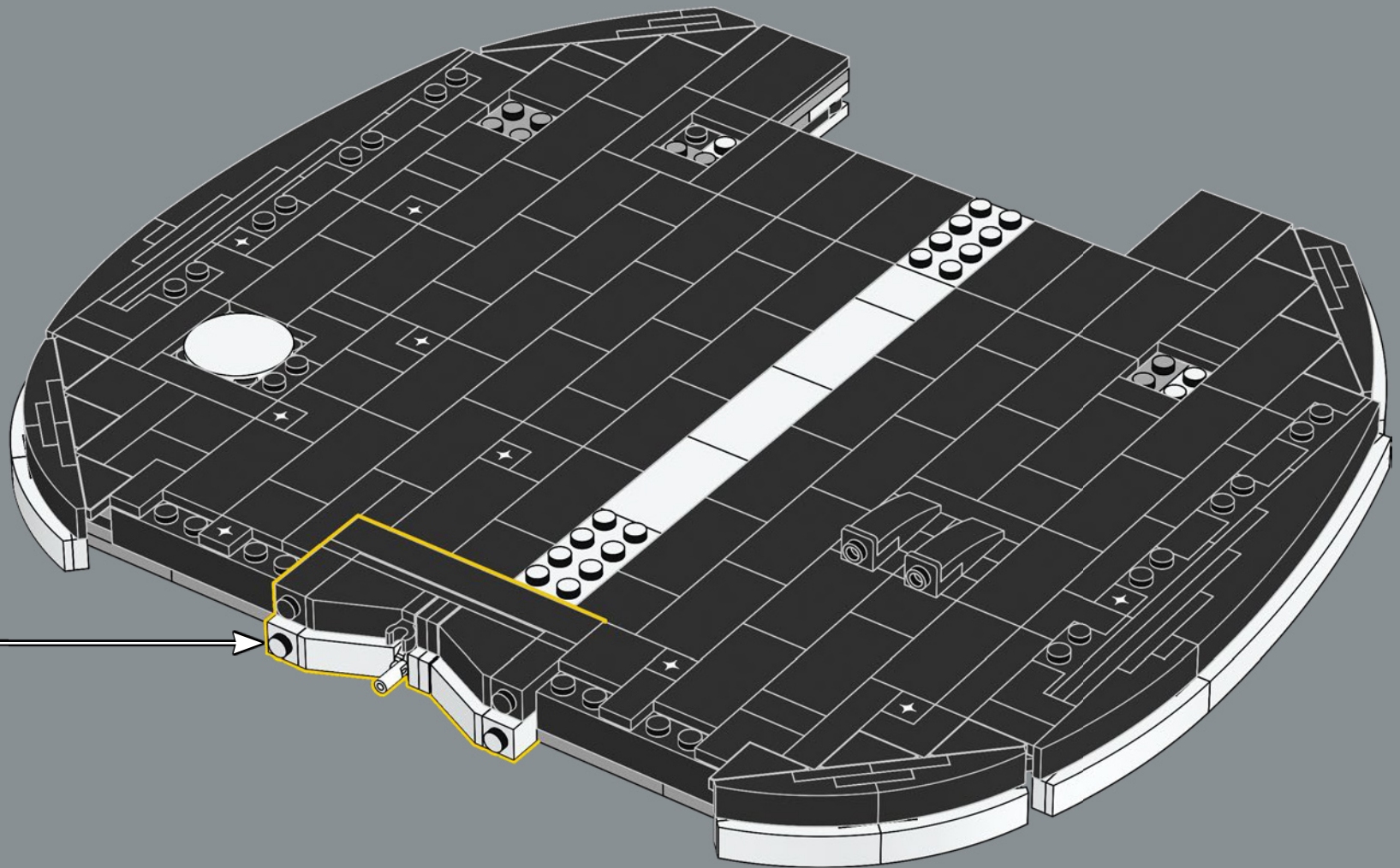

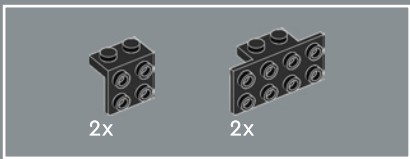

224

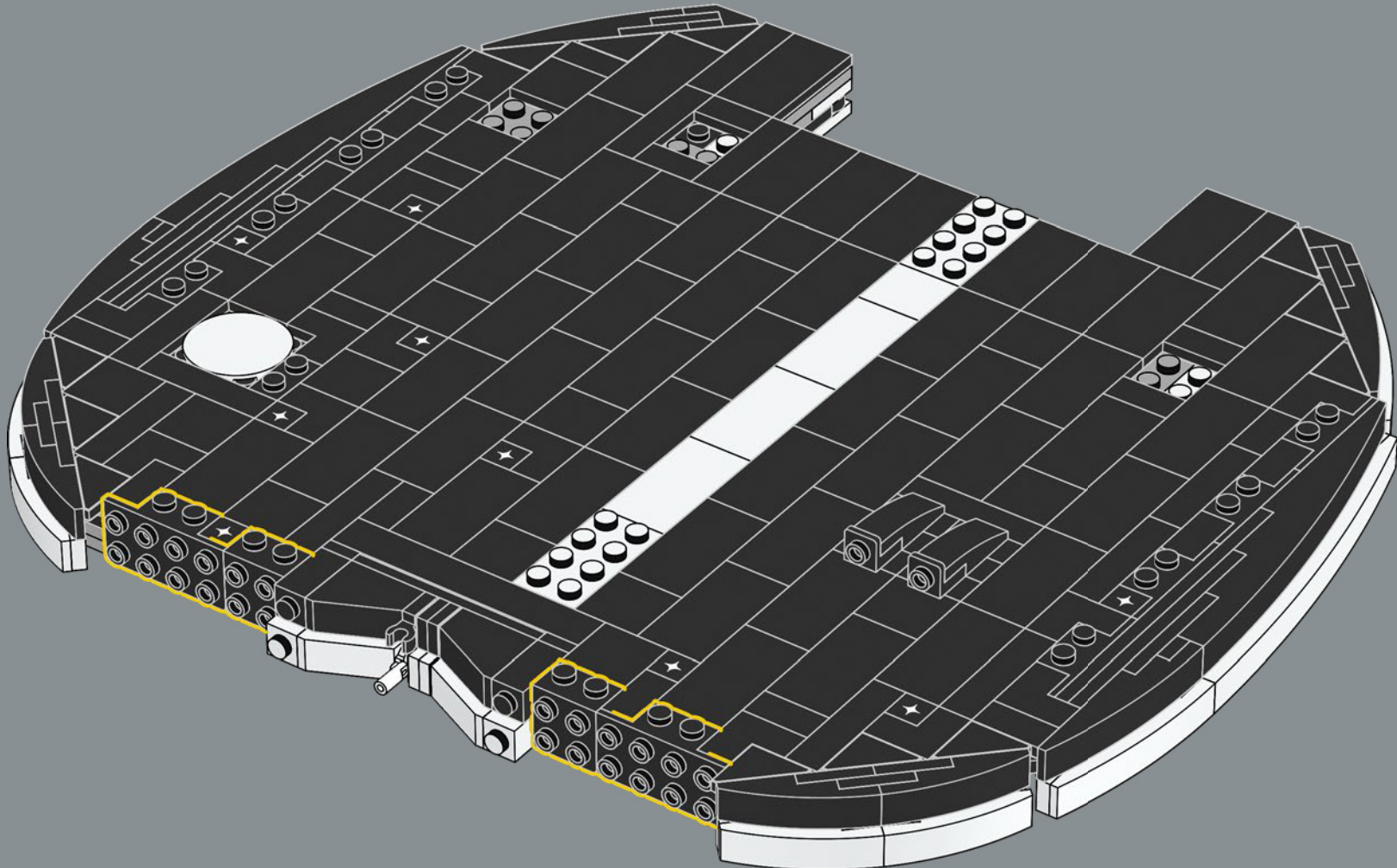

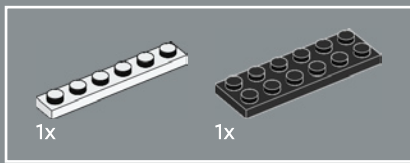

225

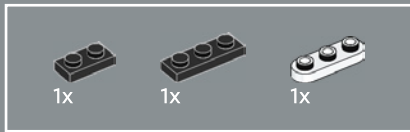
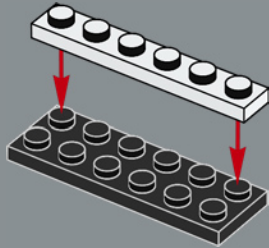

226

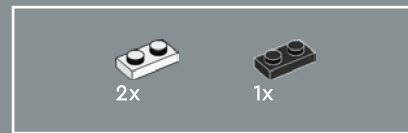
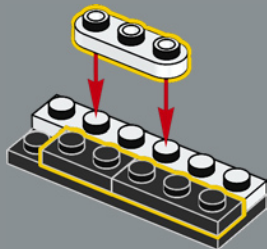

227

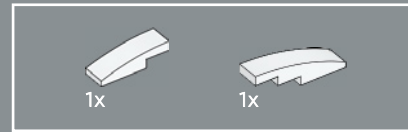
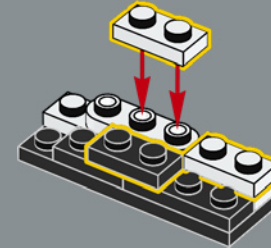

228

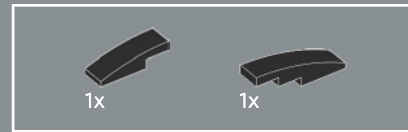
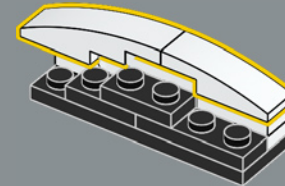

229

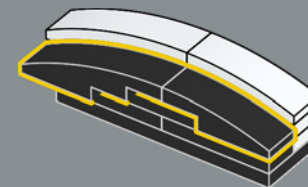

230

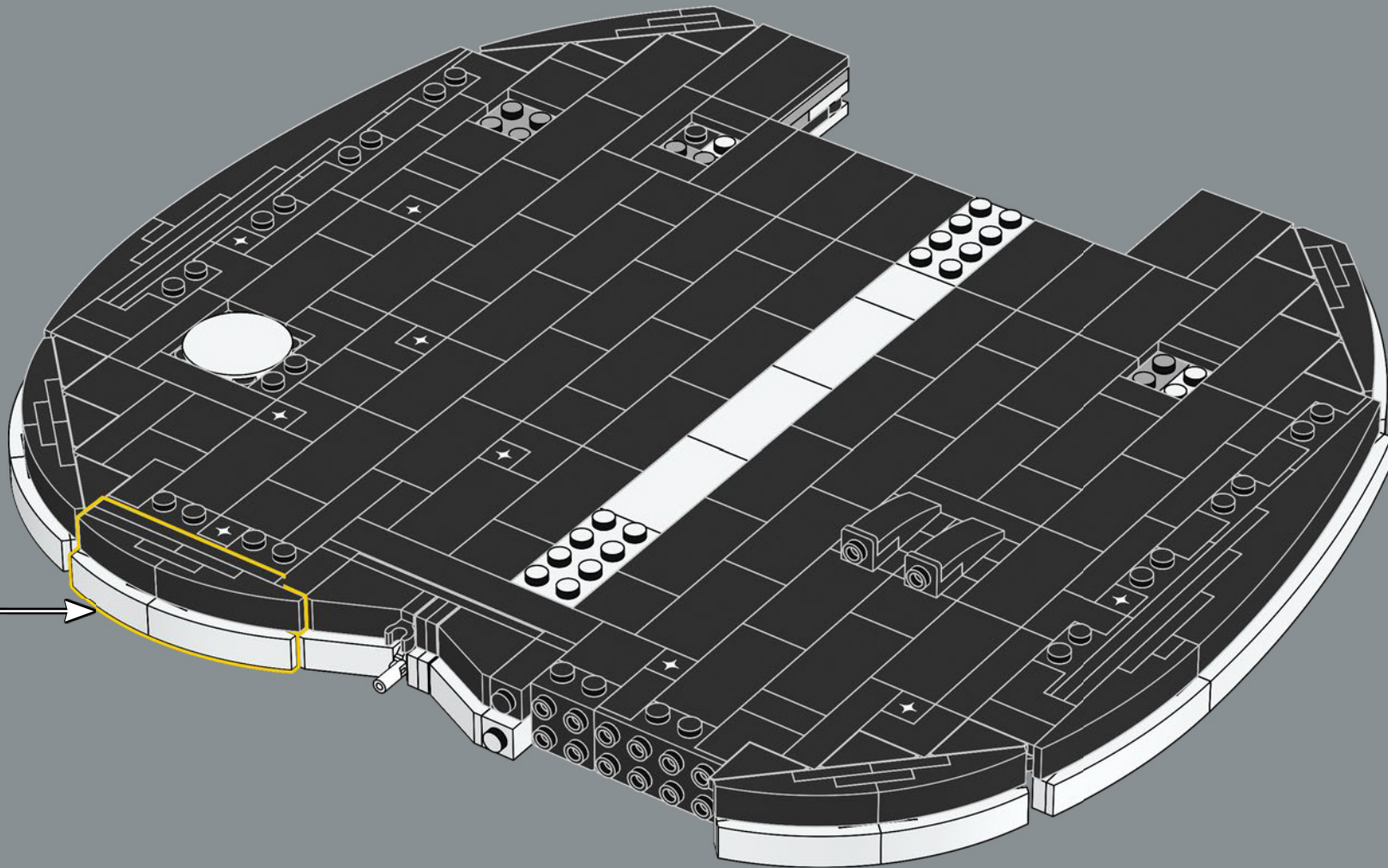

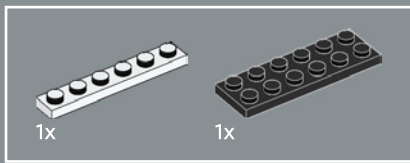

231

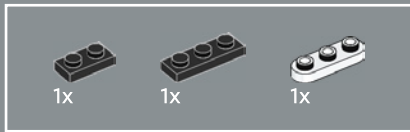
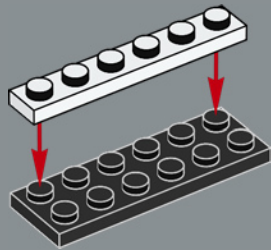

232

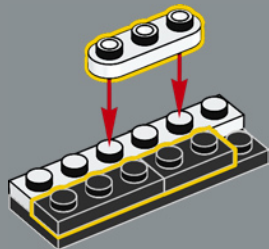

233

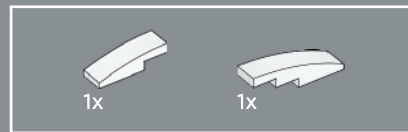
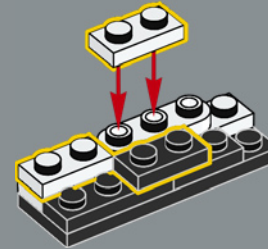

234

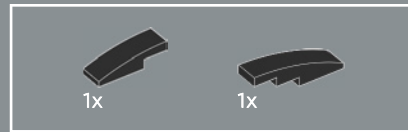
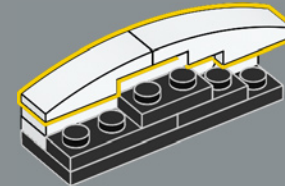

235

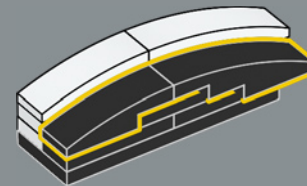

236

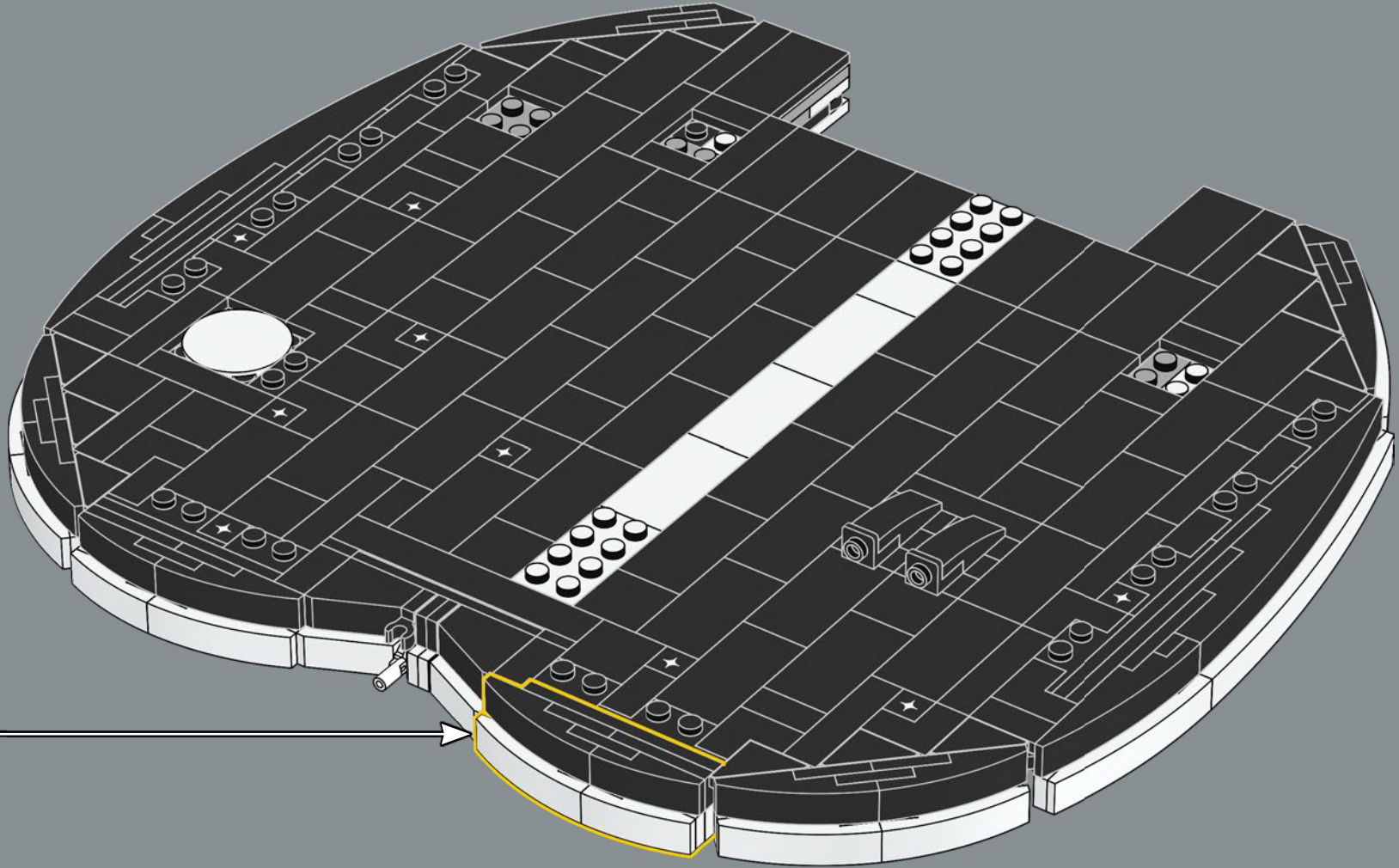



237



This might be the biggest apple in a LEGO® set to date!
We stacked curved elements and used sideways building techniques to capture this silhouette symbol of New York City.

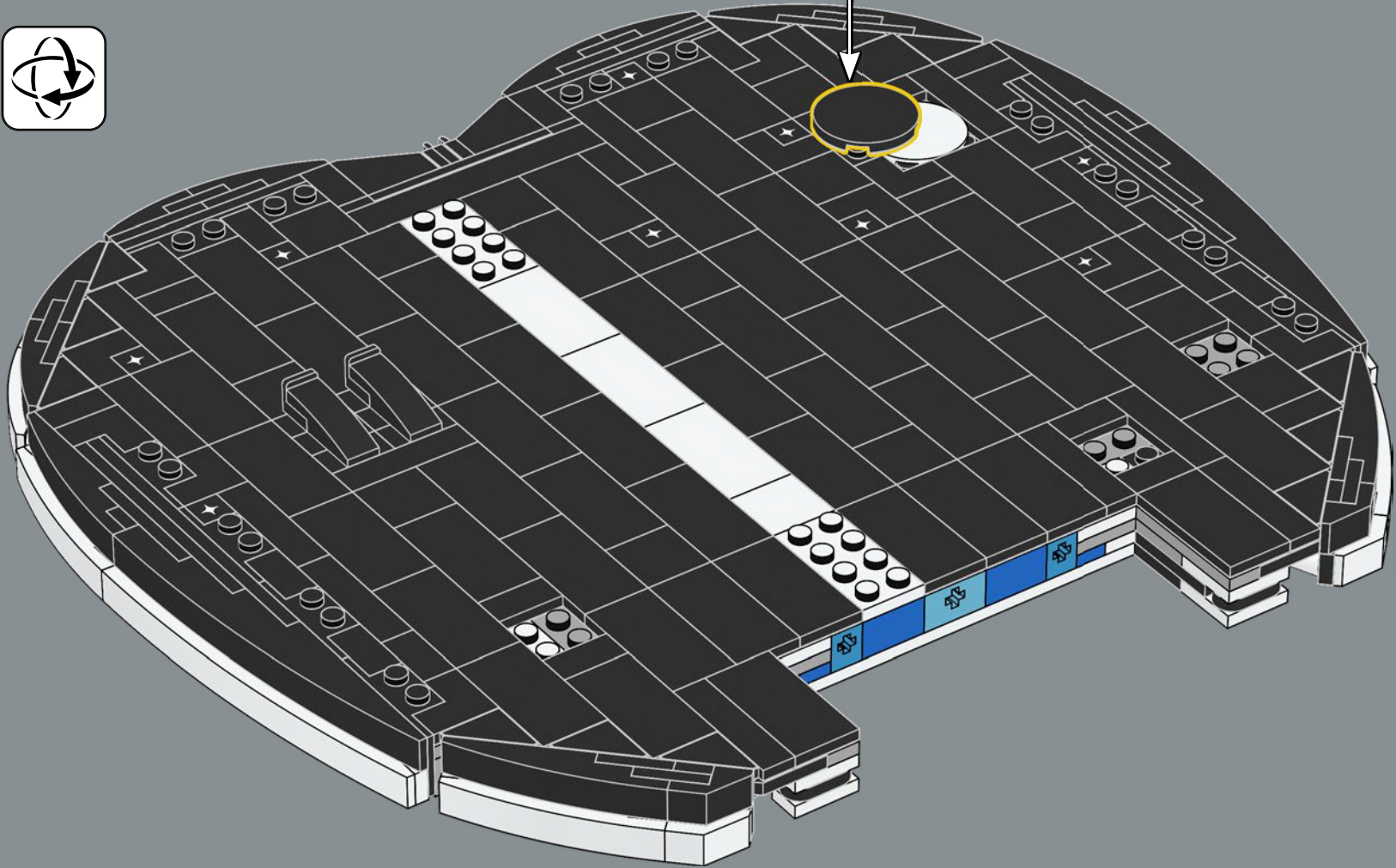

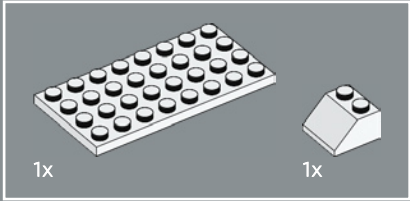
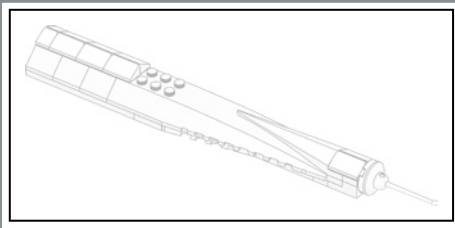

238

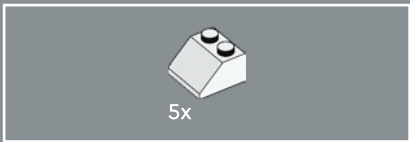
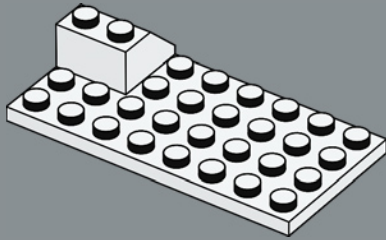

239

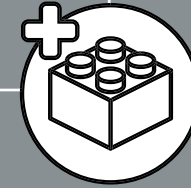
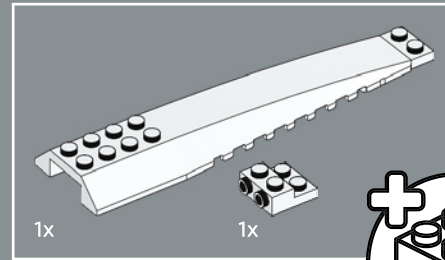
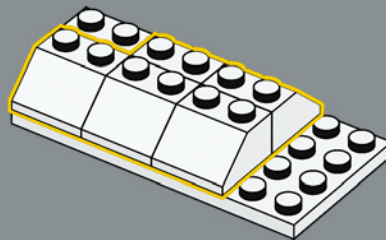

240

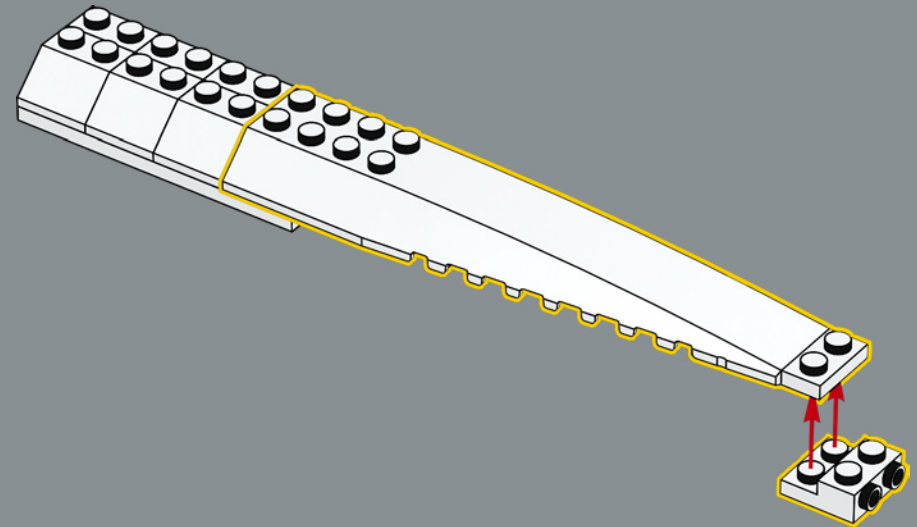

The height of One World Trade Center is 541.3 m (1,776 ft.)
– a nod to the signing of the U.S. Declaration of Independence.

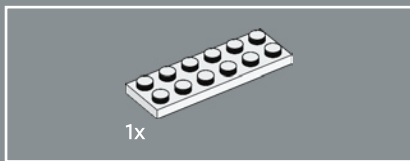

241

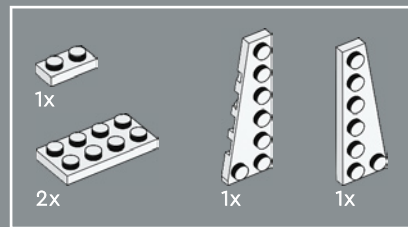
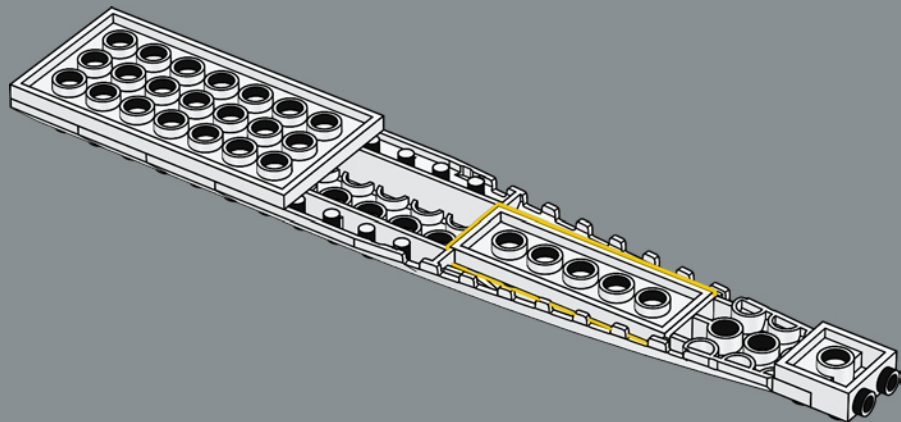

242

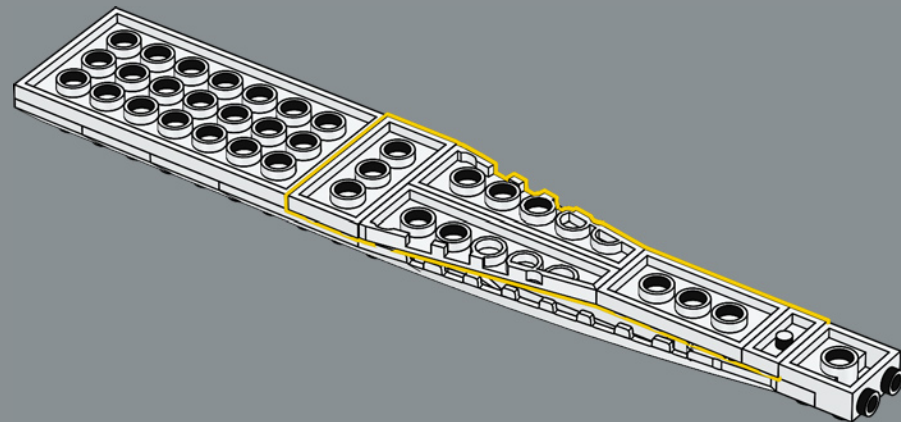

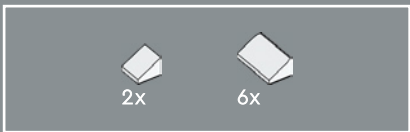

243

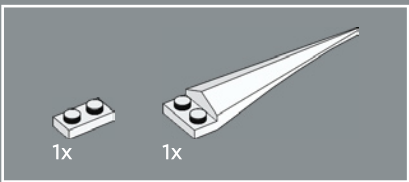
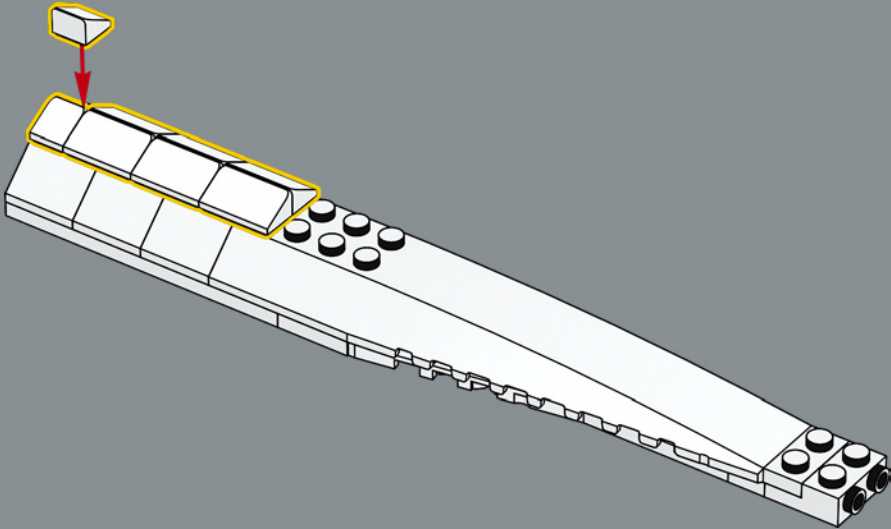

244

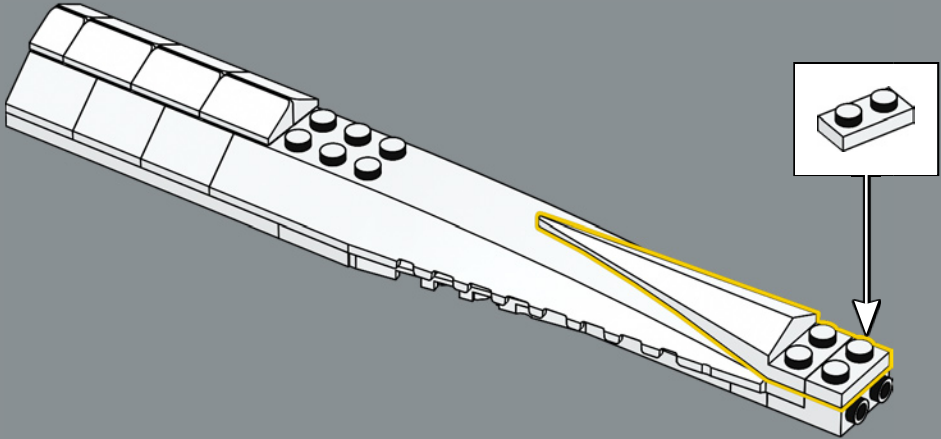



245

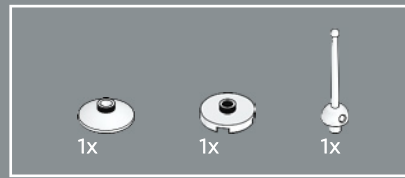
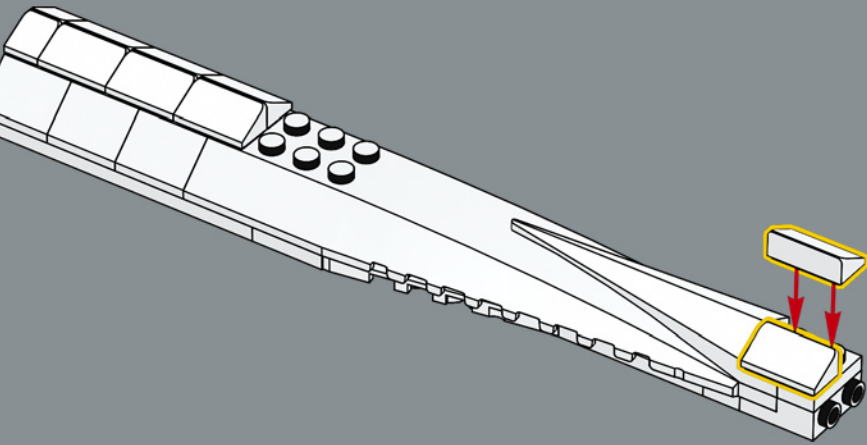

246

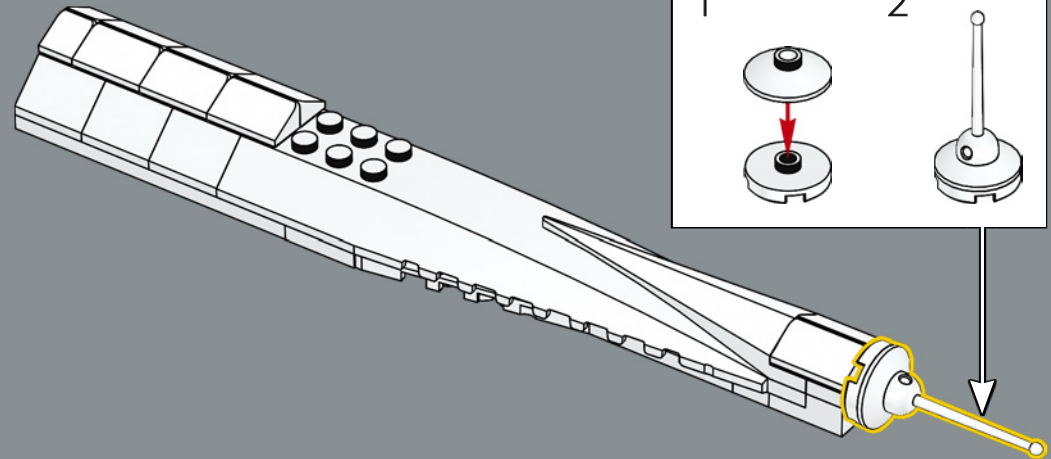

A LEGO® epee sword element creates the antenna on the tallest building in NYC, the One World Trade Center. In real life, the antenna alone is 124.3 m (407.9 ft.) tall.

247

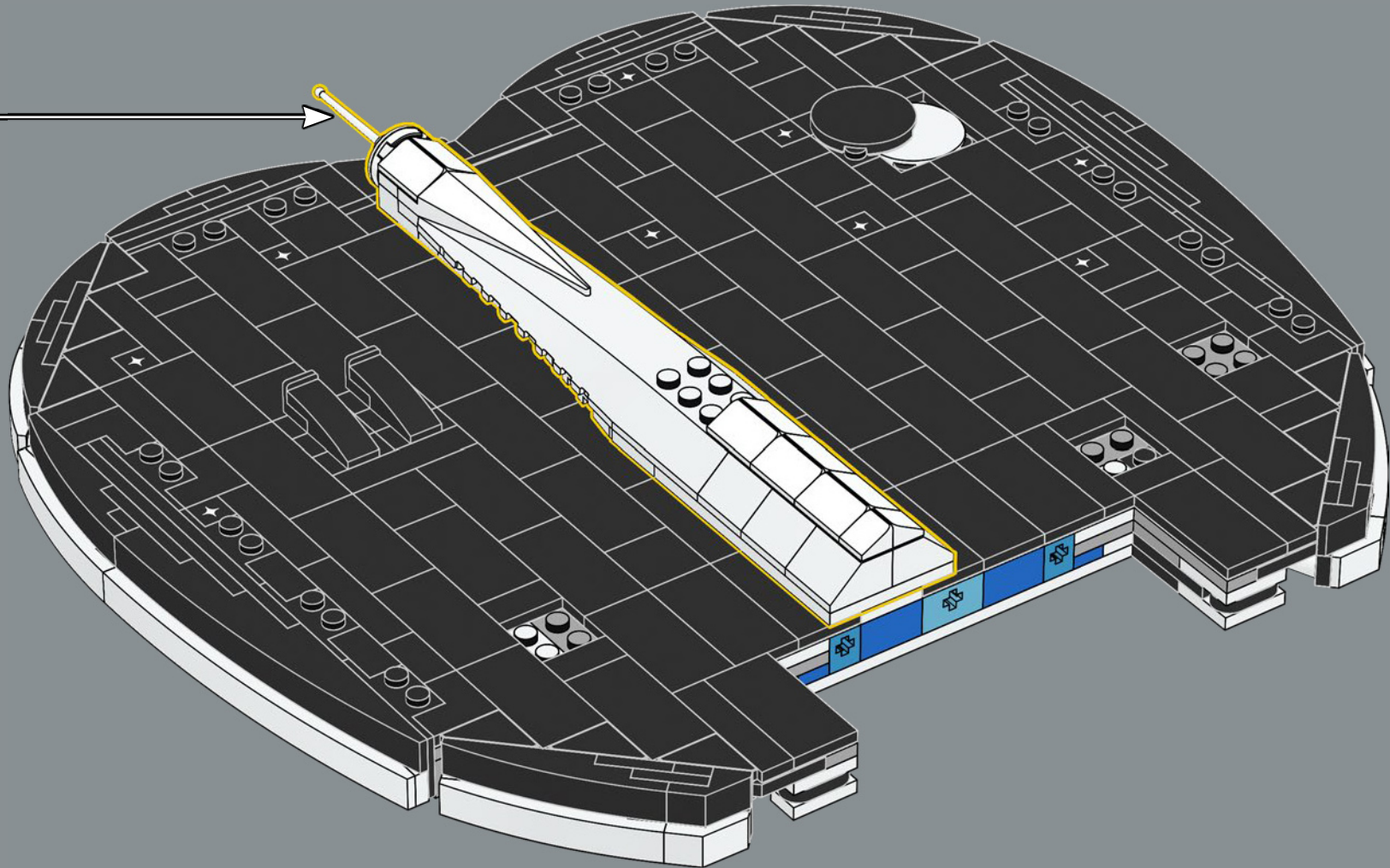



248

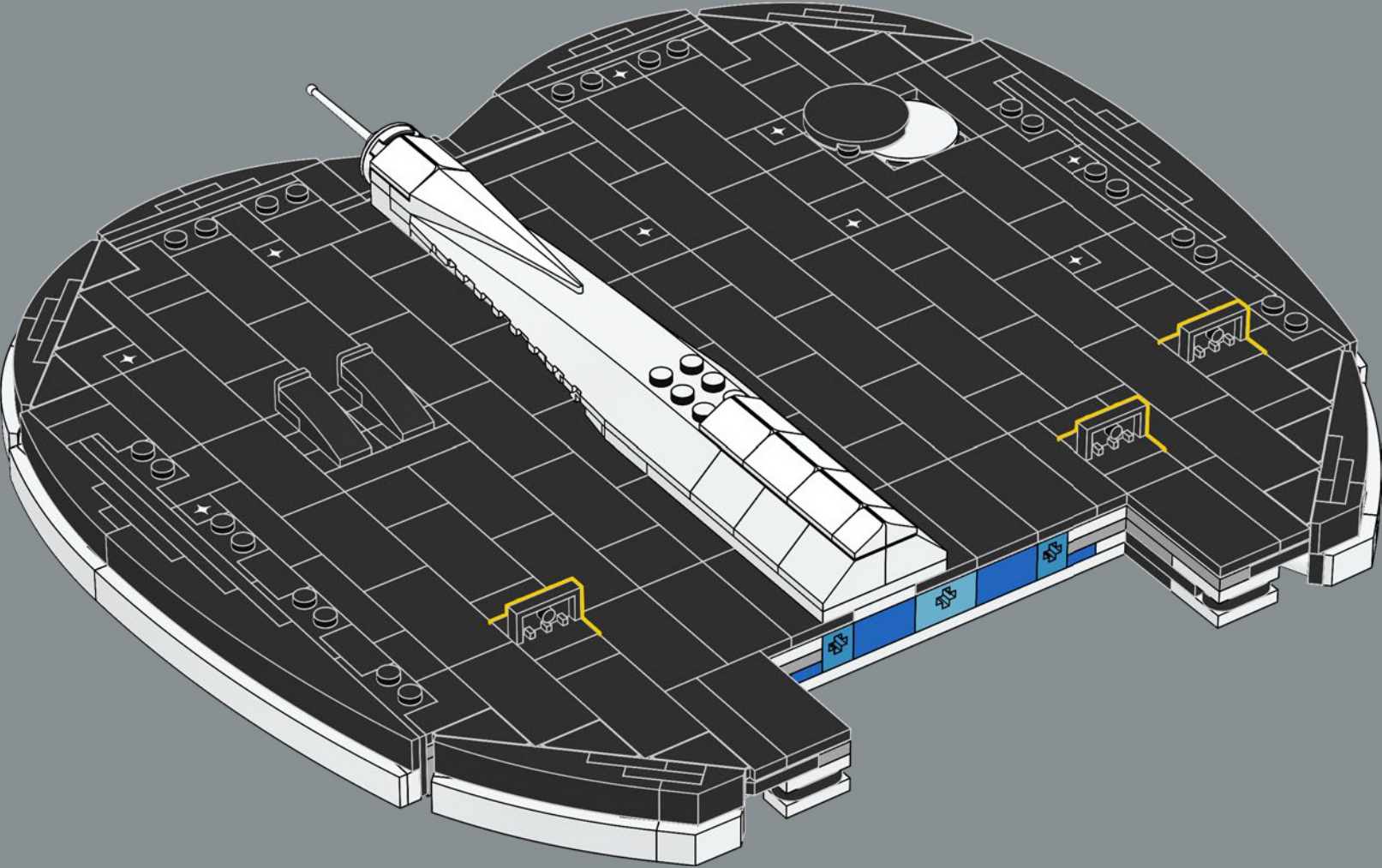

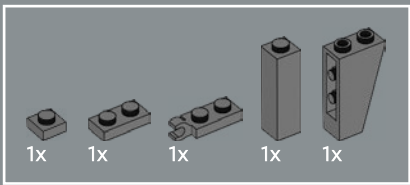

249

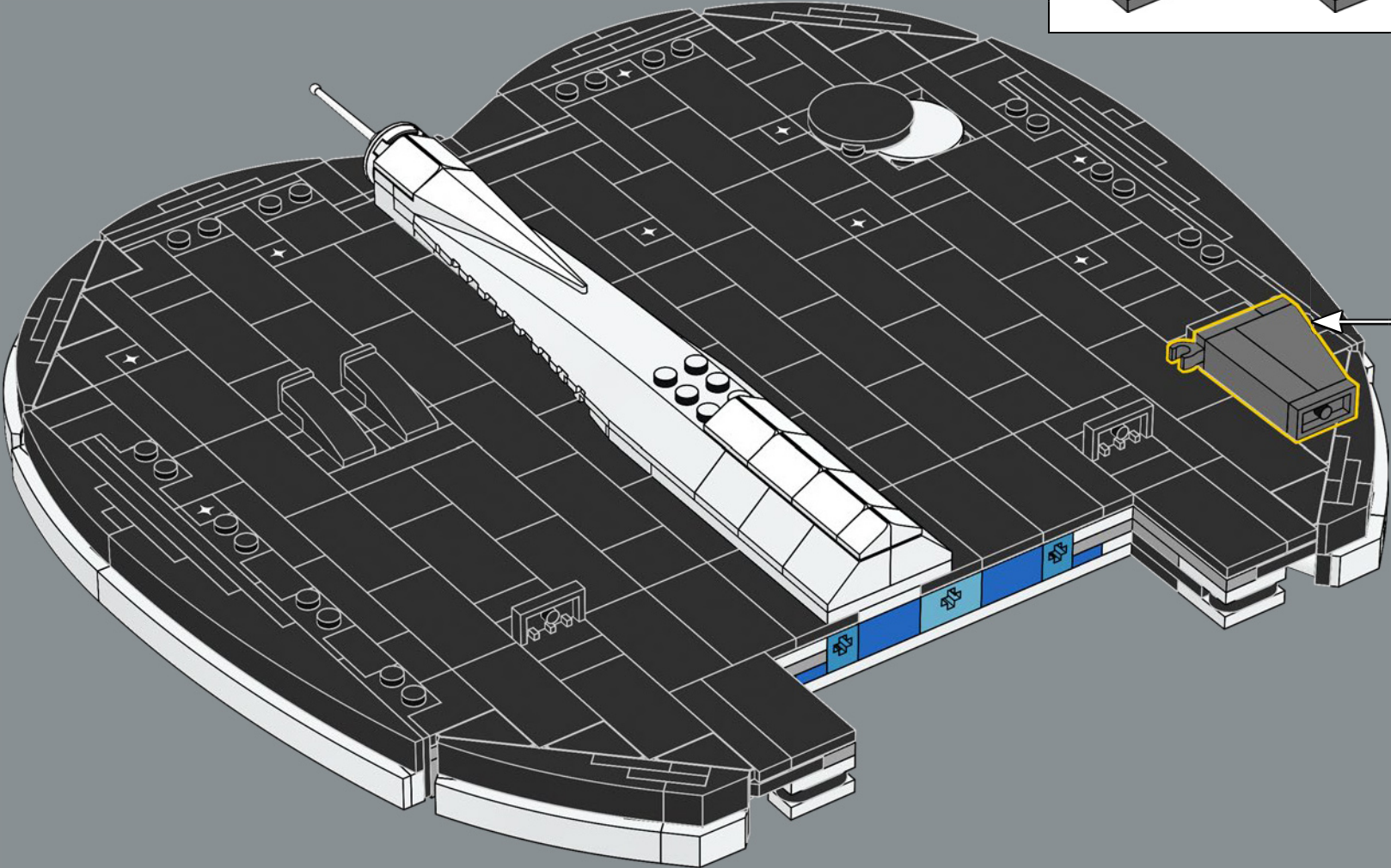
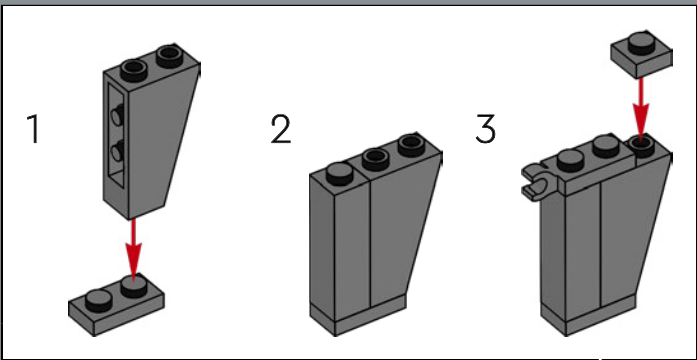

250

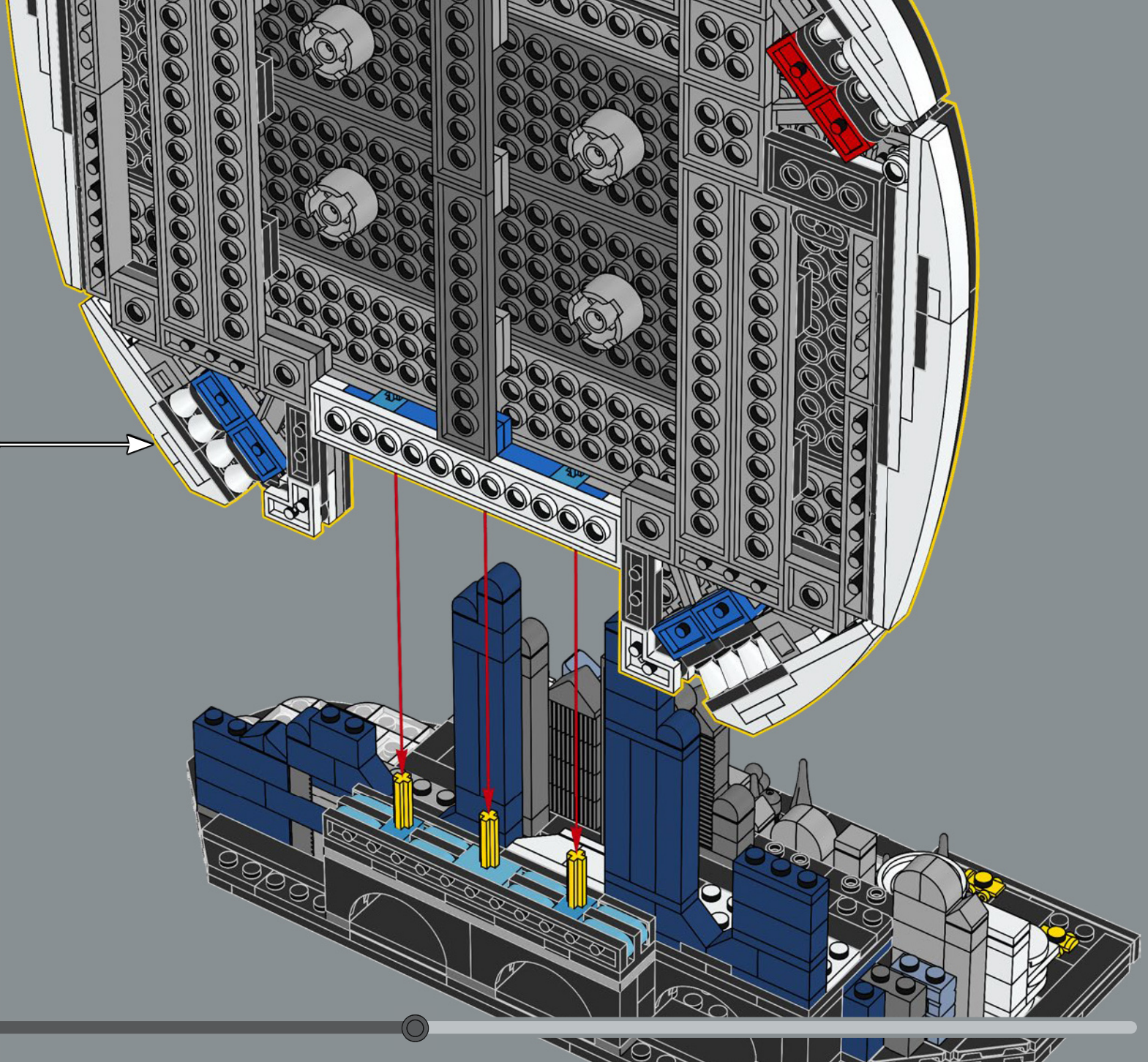

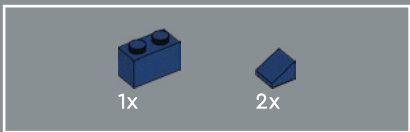

251

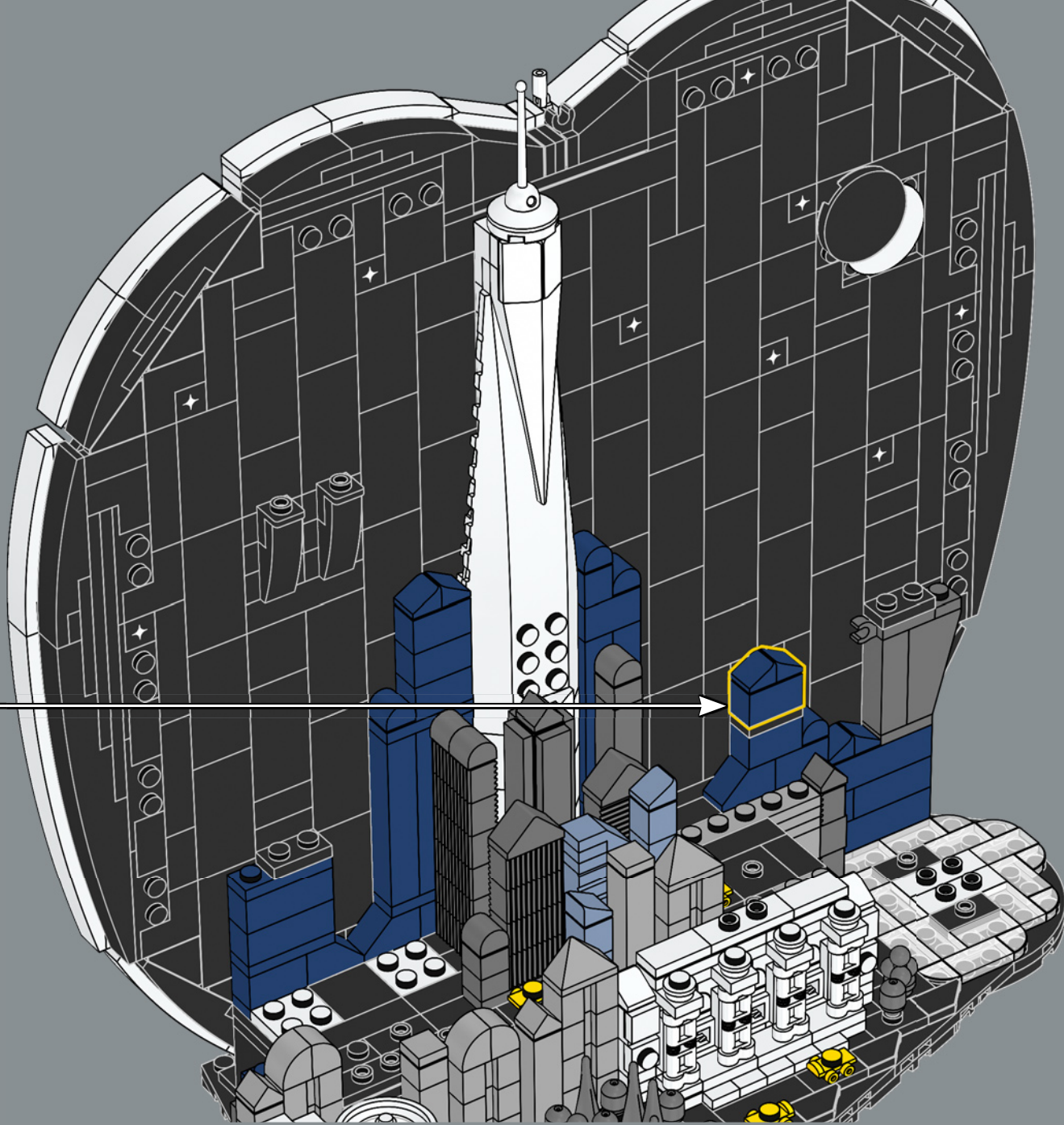
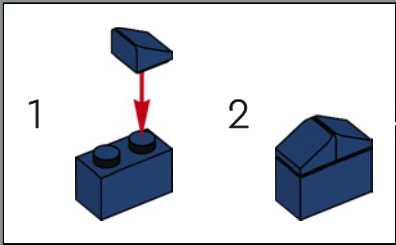

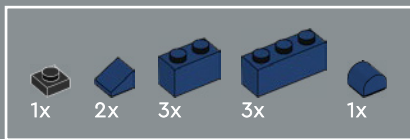

252

1

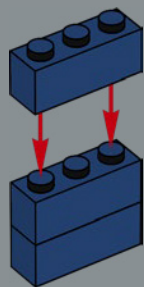

2

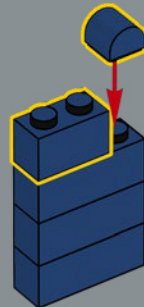

3

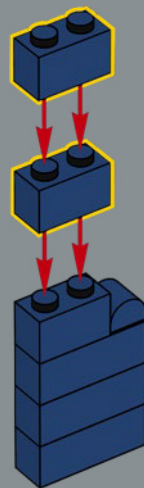

4

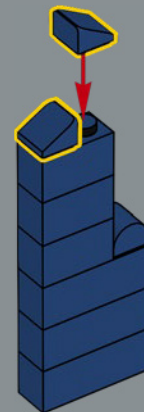

5



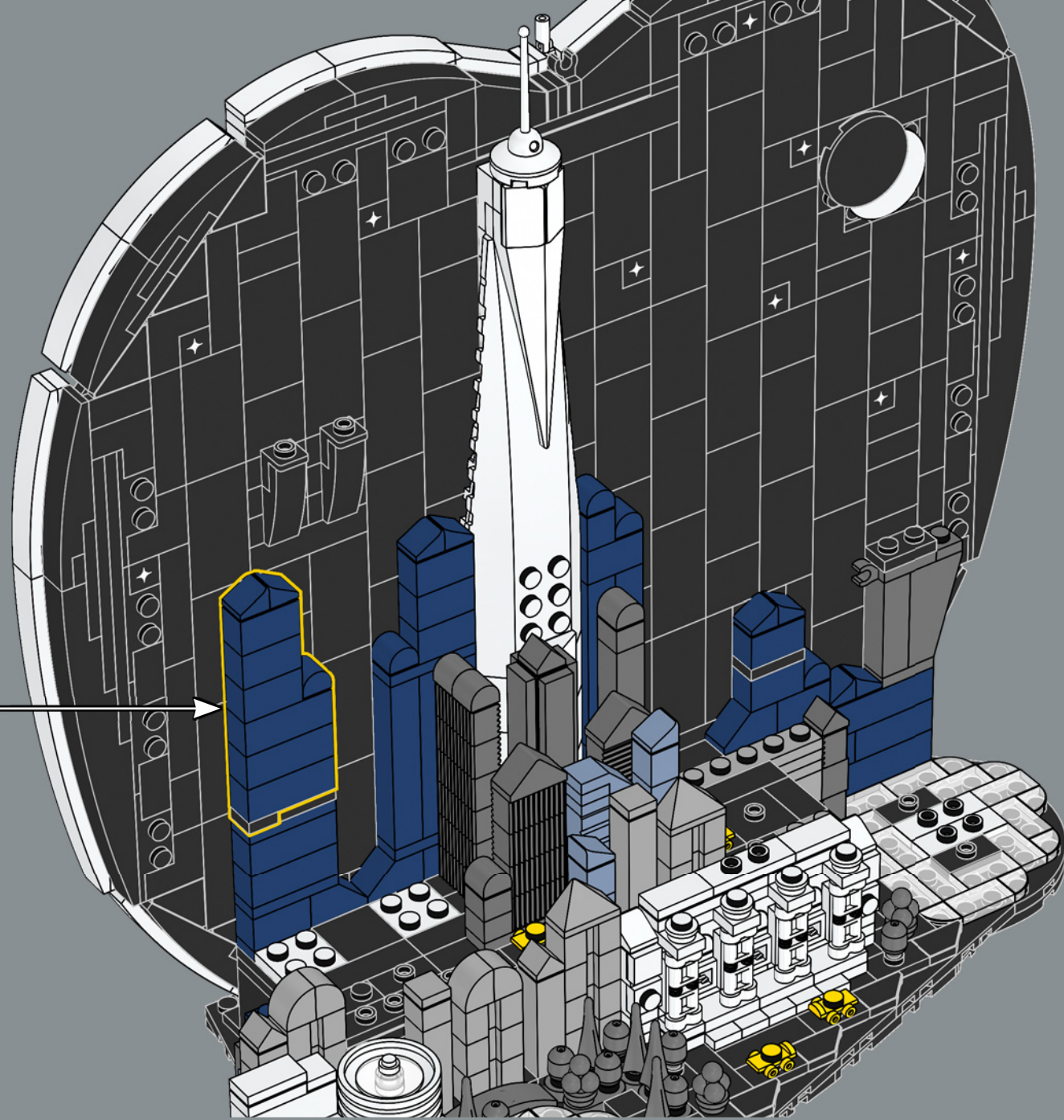

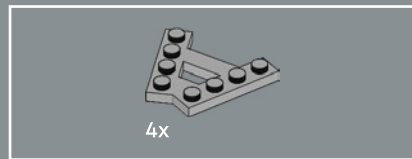

253

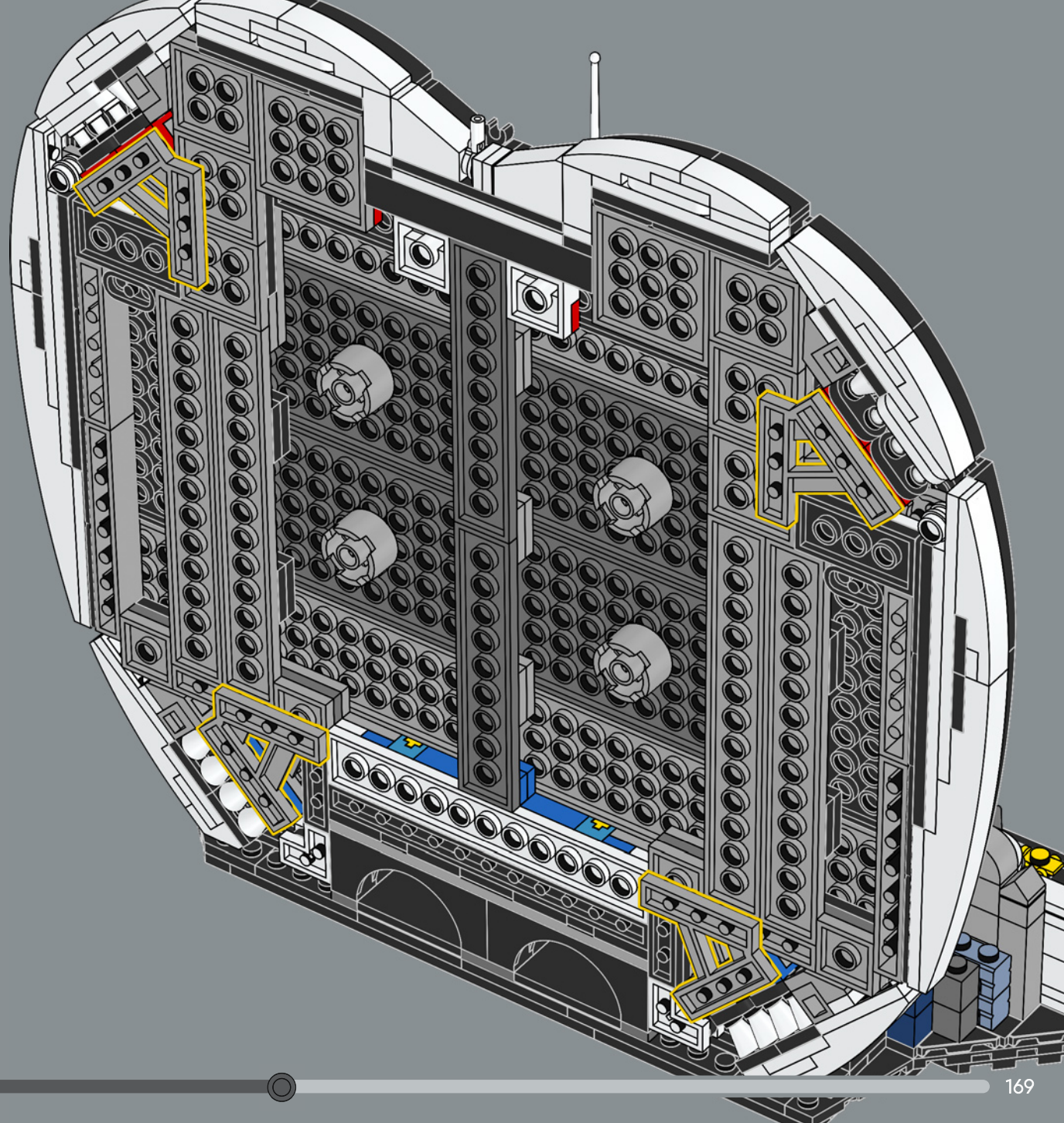

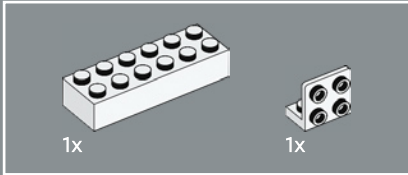
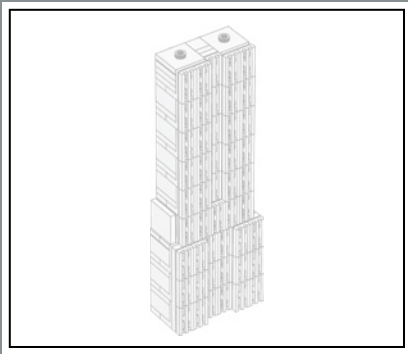

254

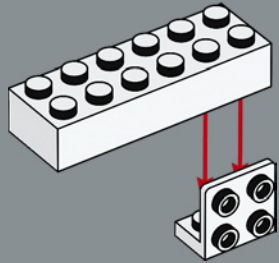

Opened in 1931, the Empire State Building remains an Art Deco icon. As the world's first-ever steel-frame building with over 100 floors, it ruled the New York skyline as the world's tallest for nearly 40 years.

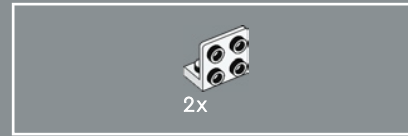

255

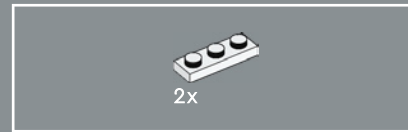
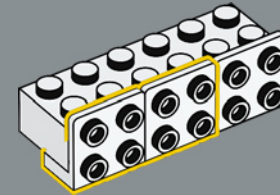

256

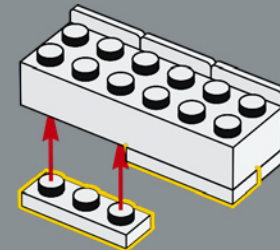

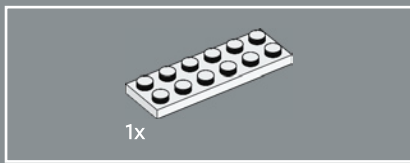

257

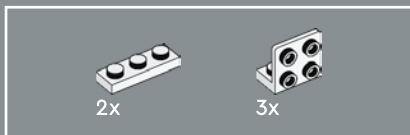
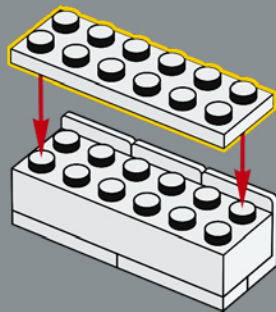

258

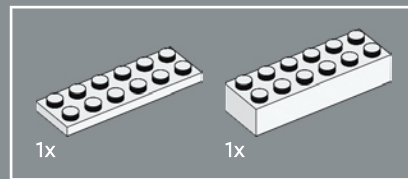
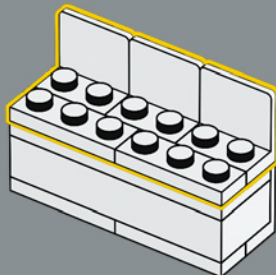

259

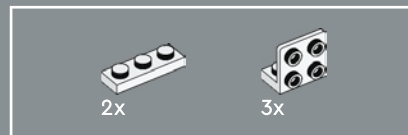
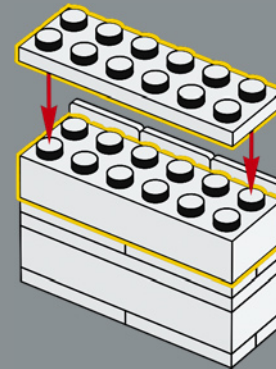

260

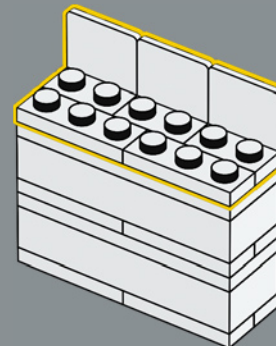

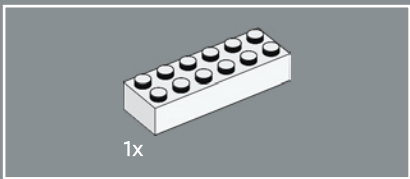

261

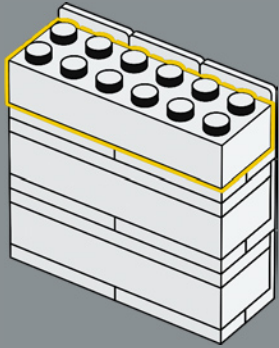

262

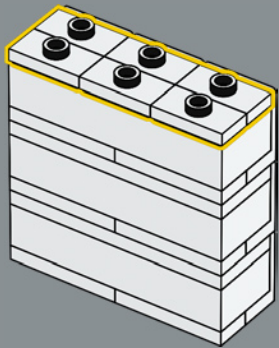

263

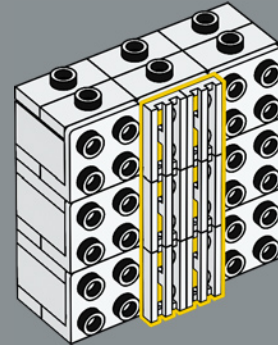

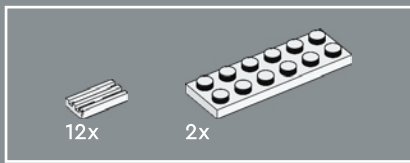

264

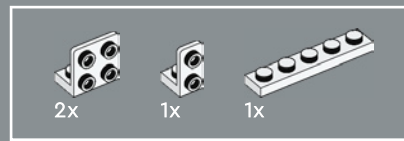
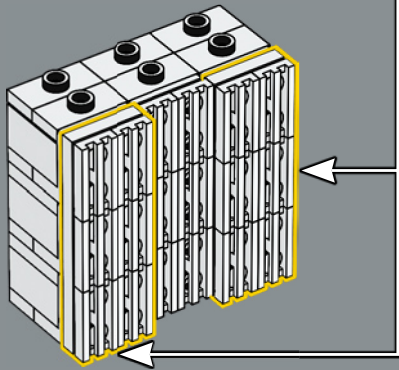
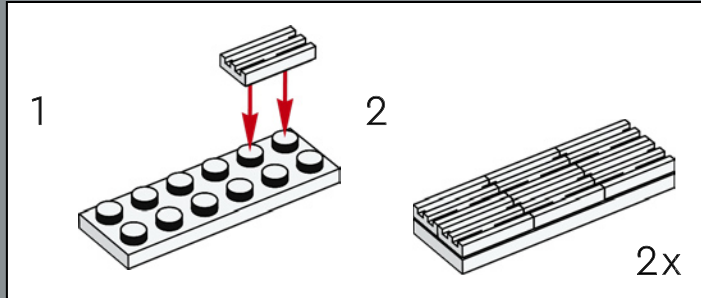

265

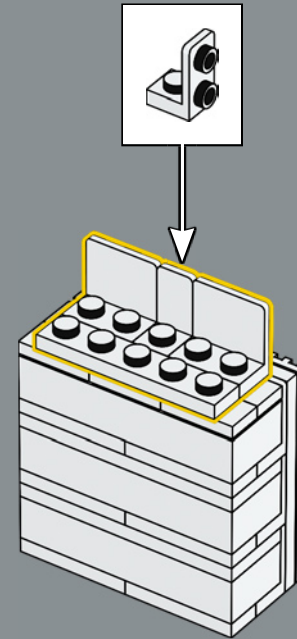

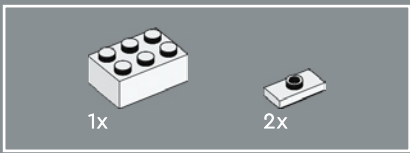

266

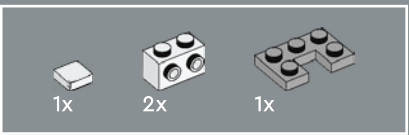
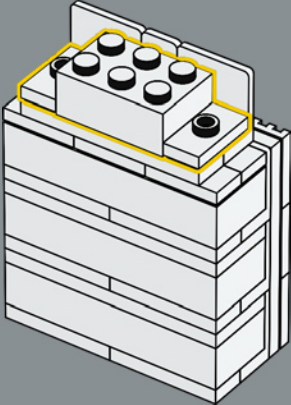

267

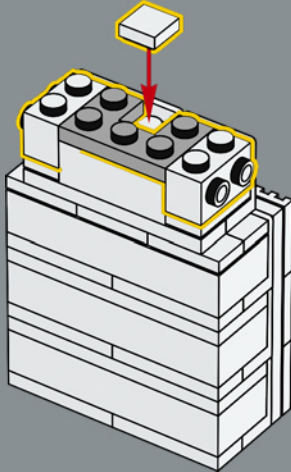

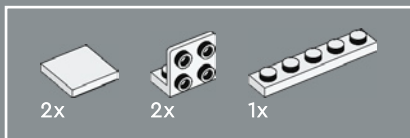

268

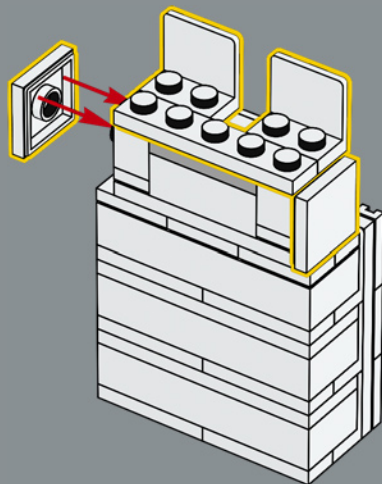

269

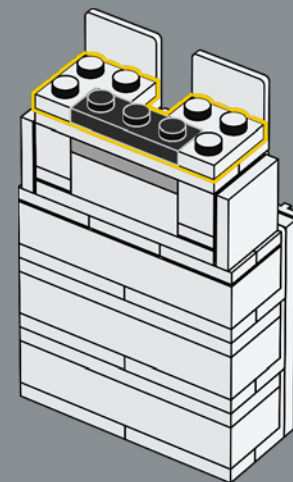

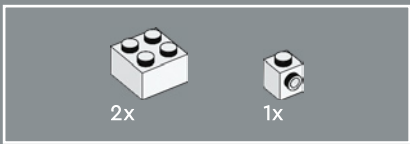

270

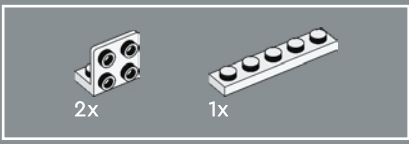
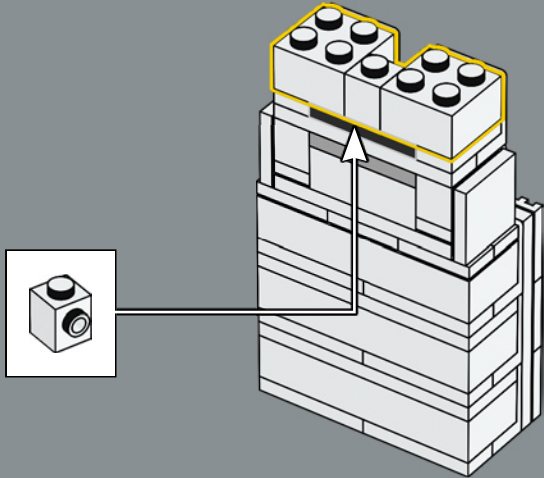

271

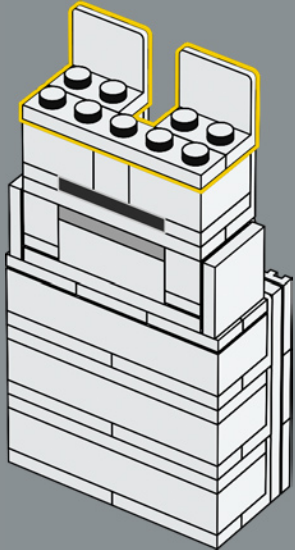

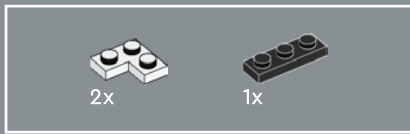

272

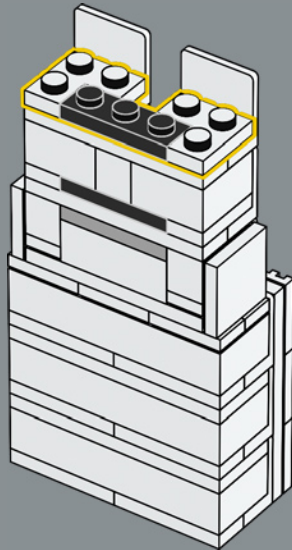

273

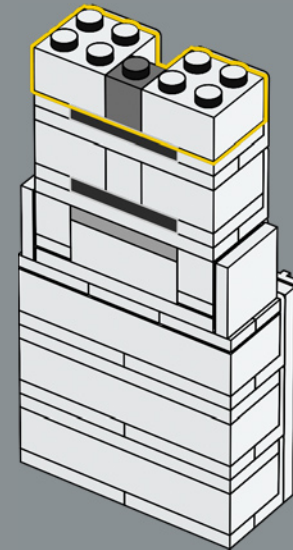

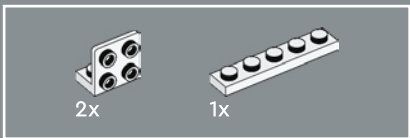

274

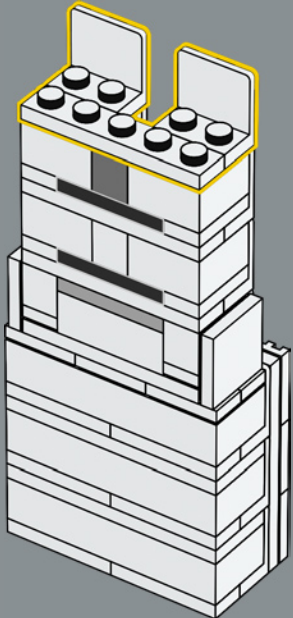

275

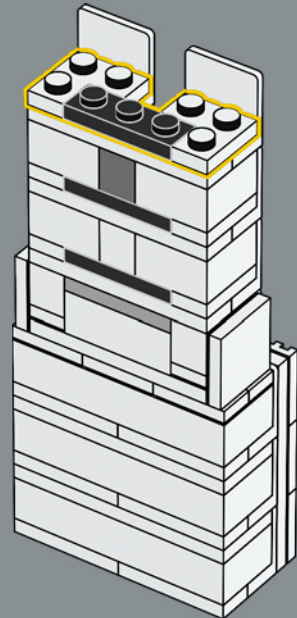

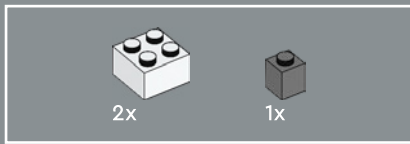

276

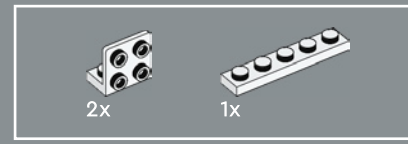
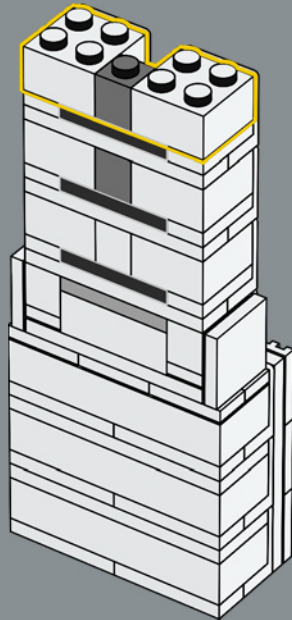

277

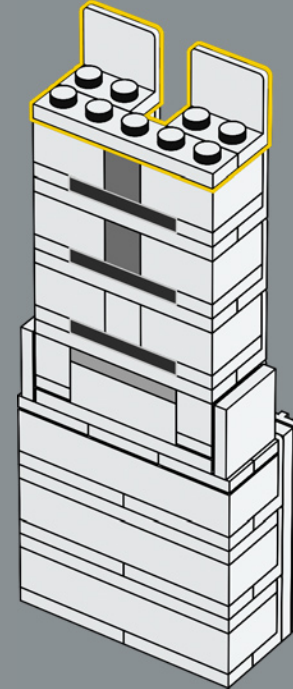

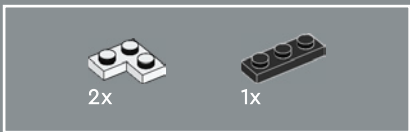

278

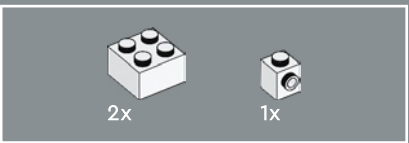
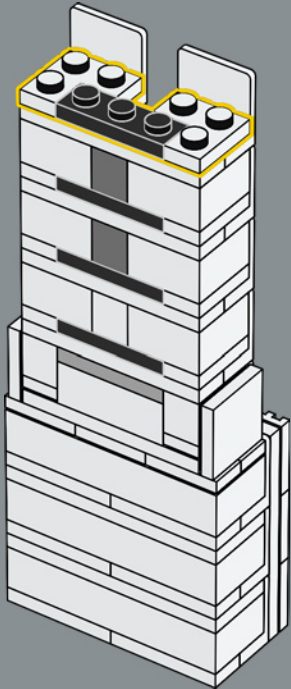

279

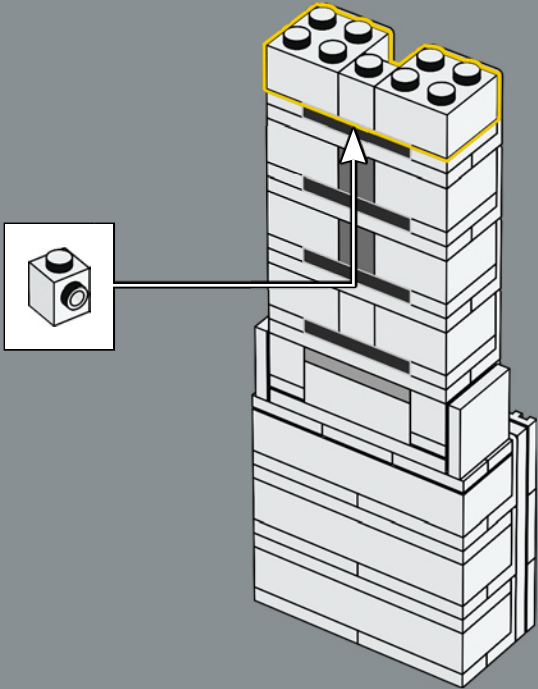

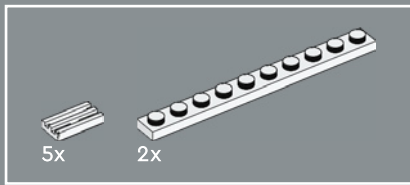

280

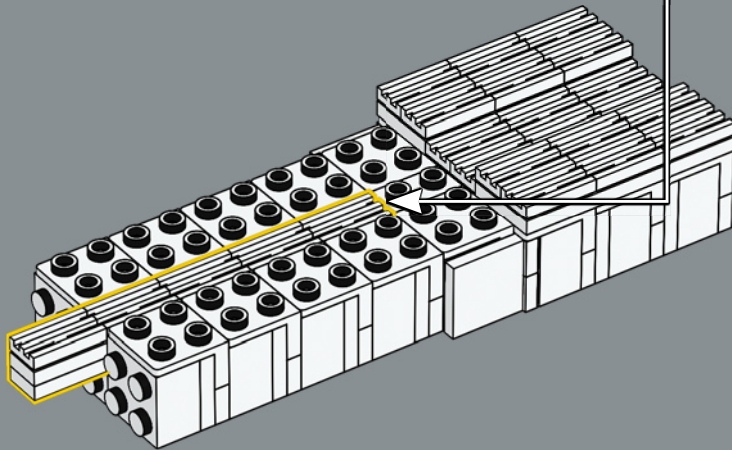
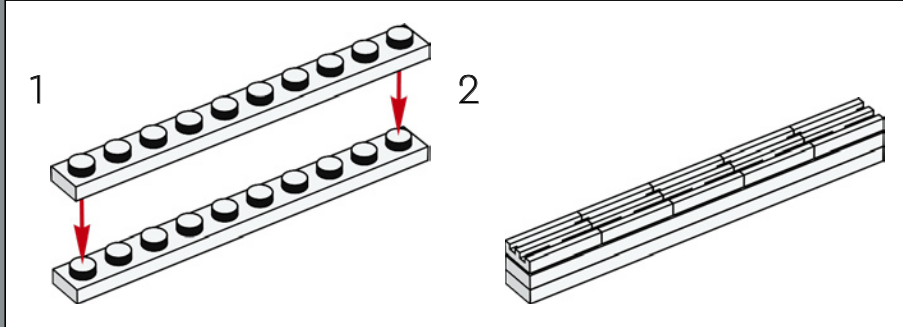

281

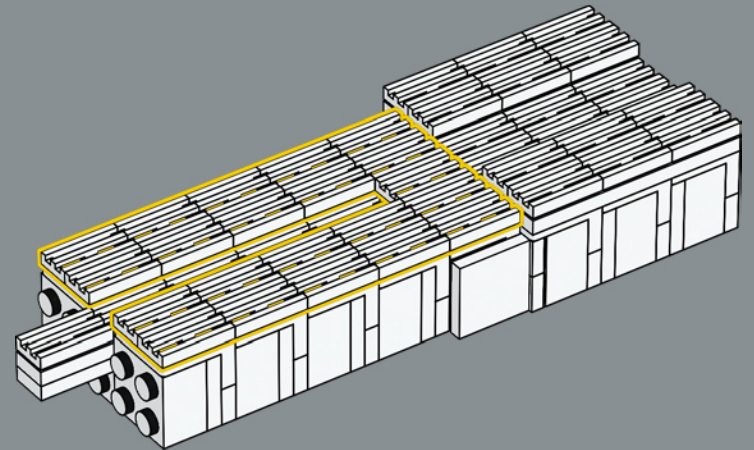

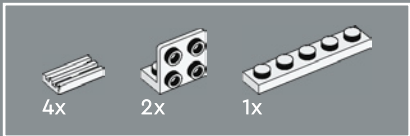

282

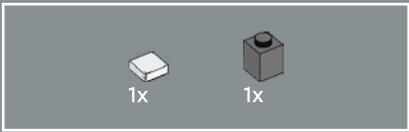
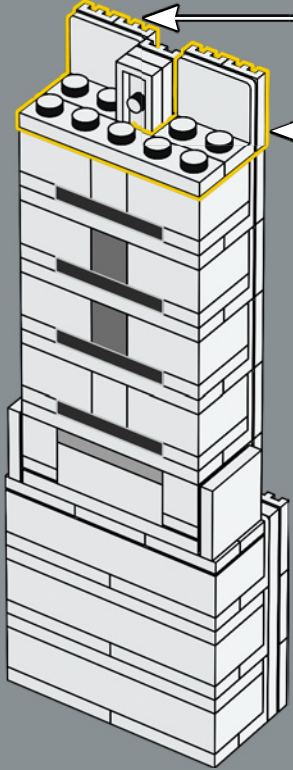
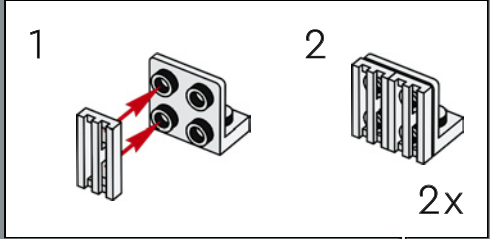

283

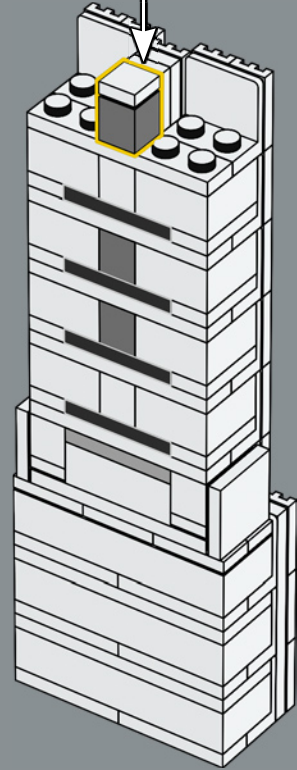
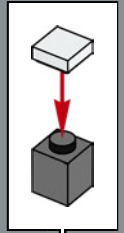

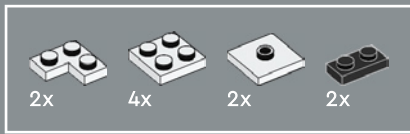

284

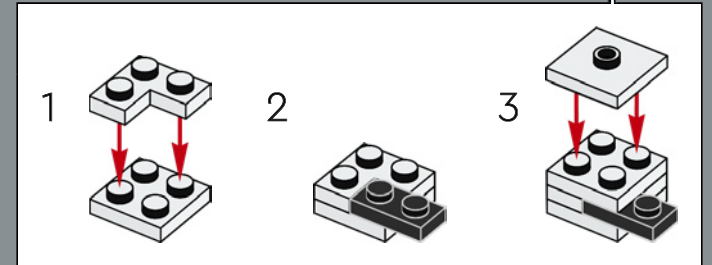
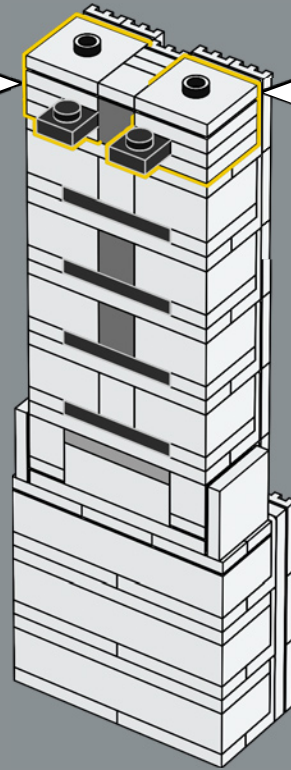
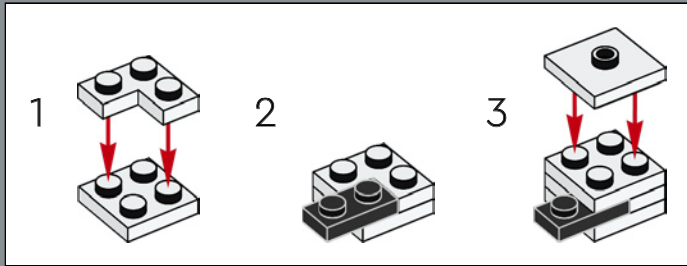

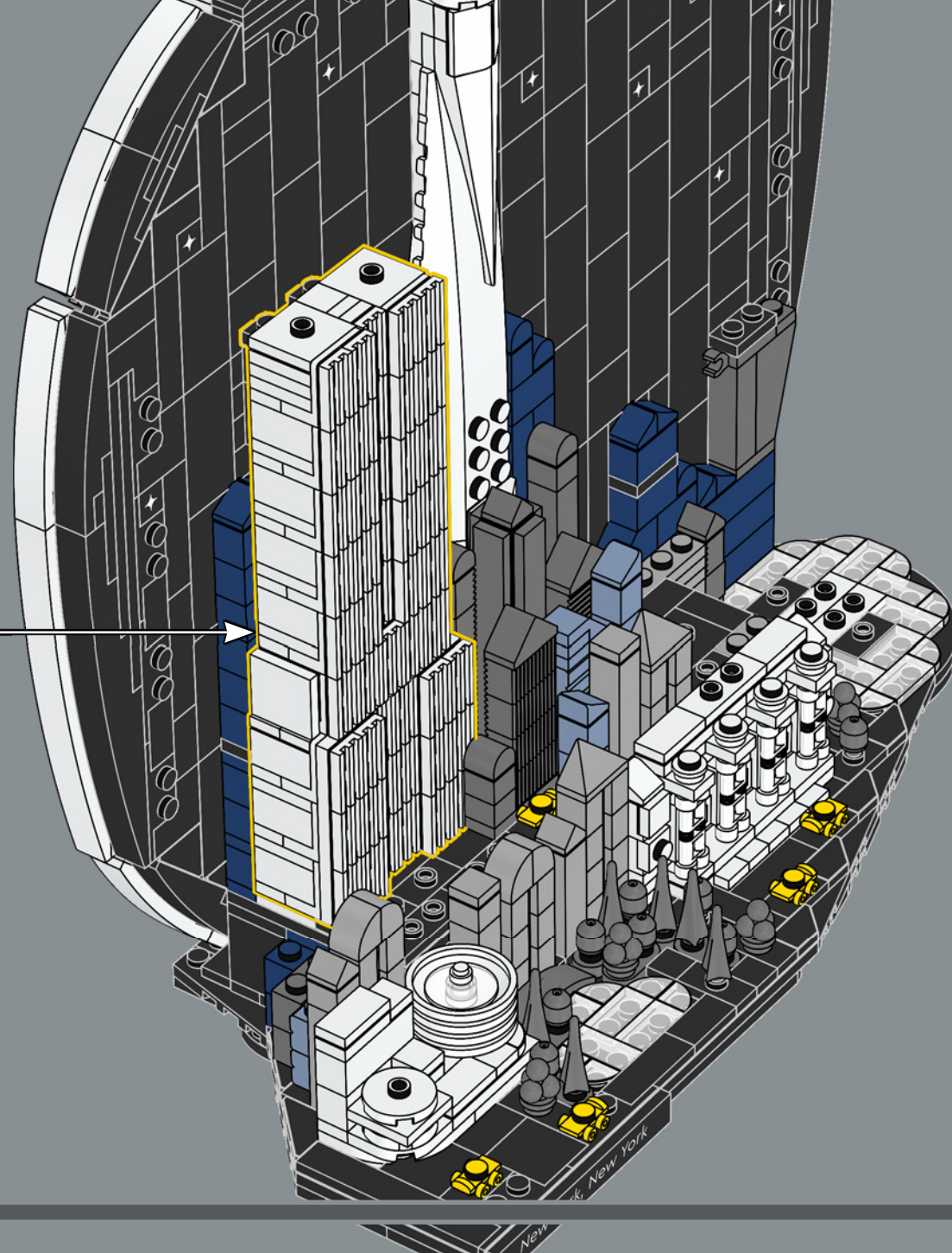

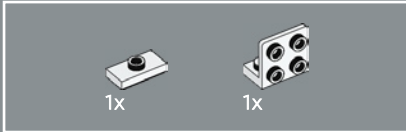
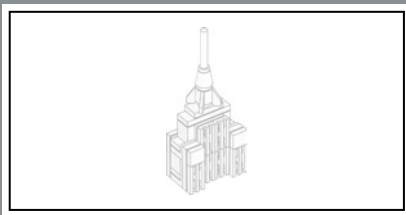

286

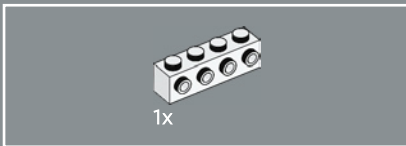
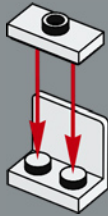

287

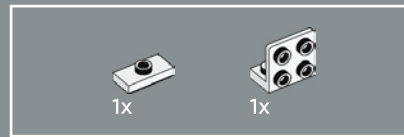
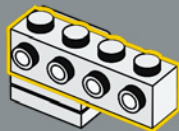

288

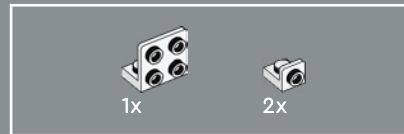
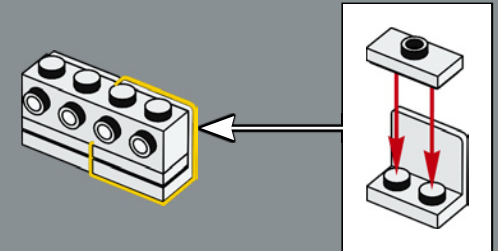

289

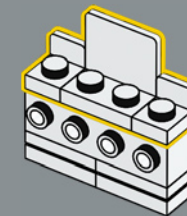



2x

290

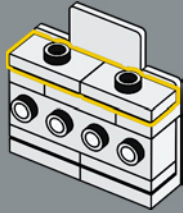

1x



1x

291

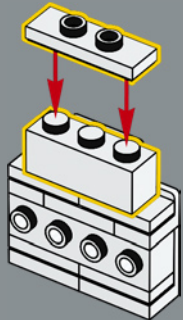

2x

292

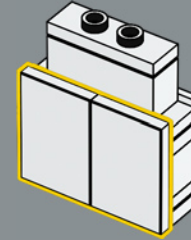

4x

293

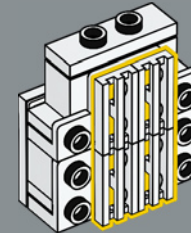

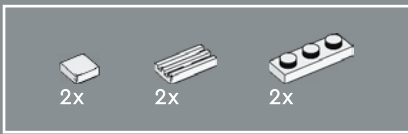

294

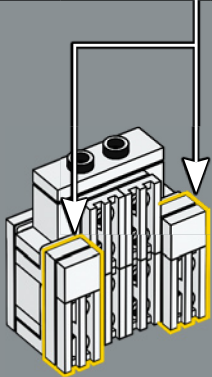
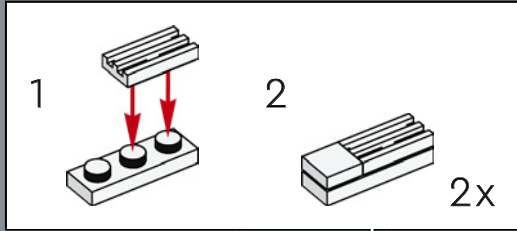

In recent years, the Empire State Building has been through meticulous restorations to preserve its original design and the building's history for generations to come.

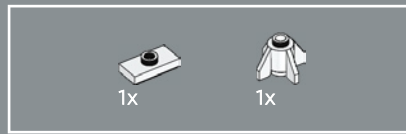

295

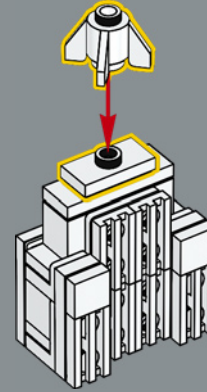

296

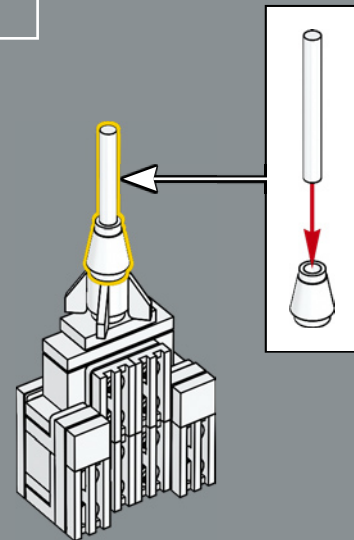

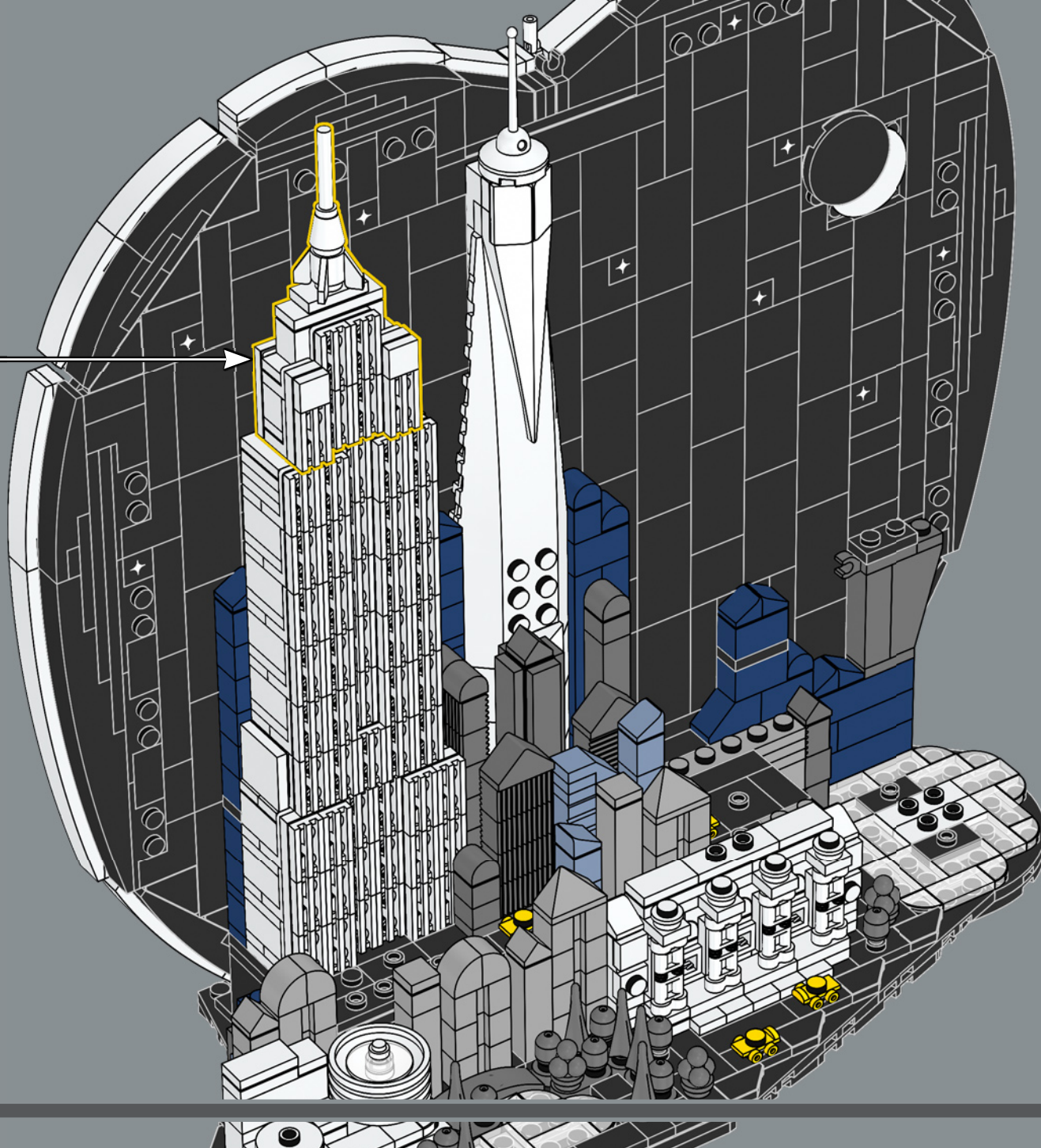

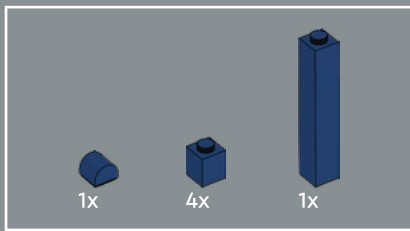

298

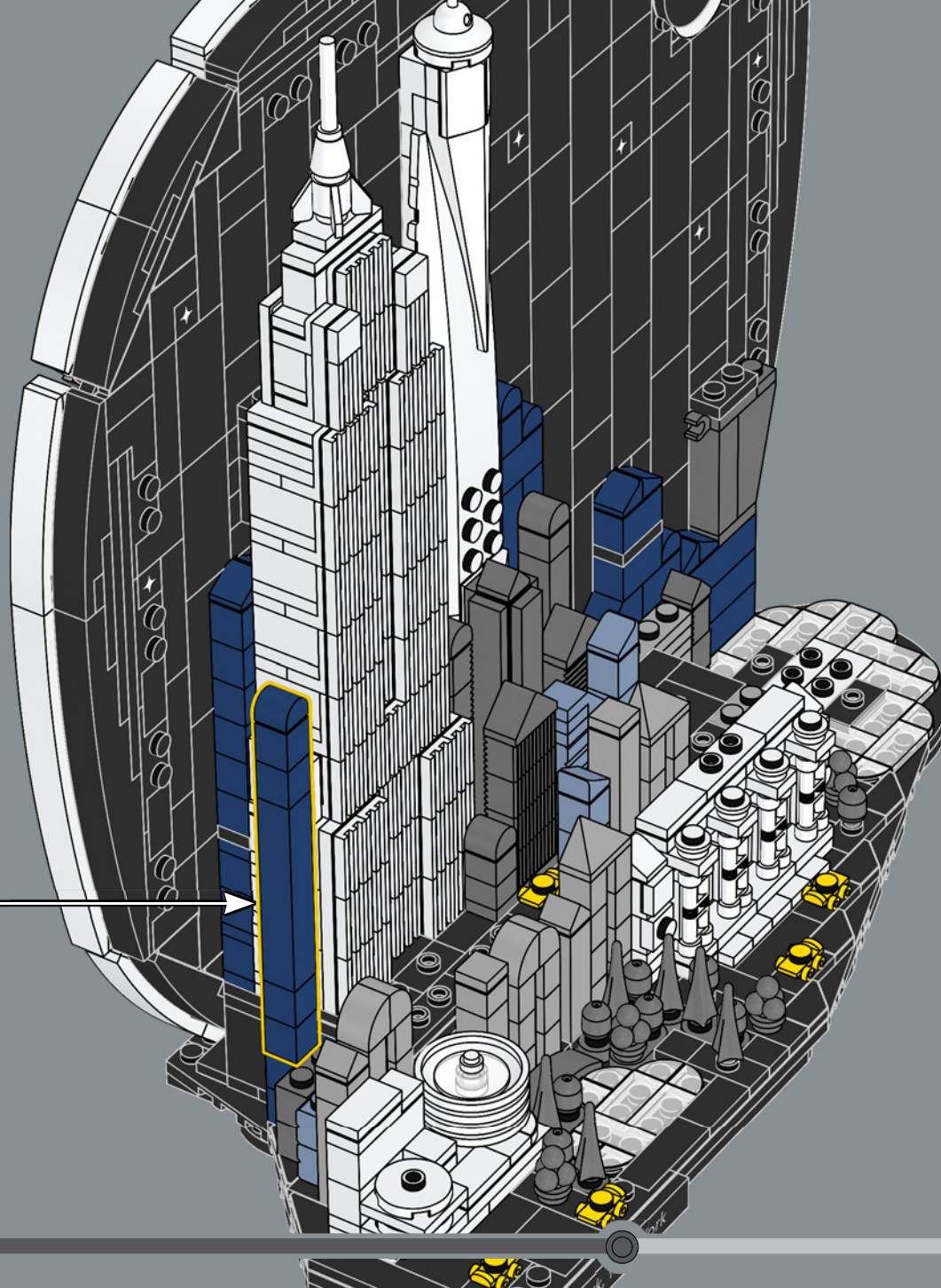
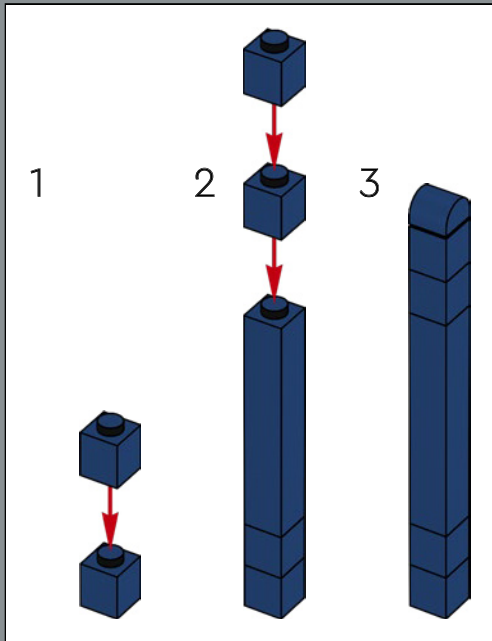

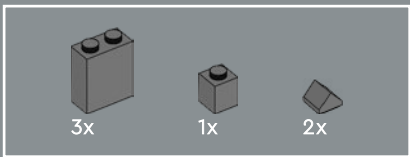

299

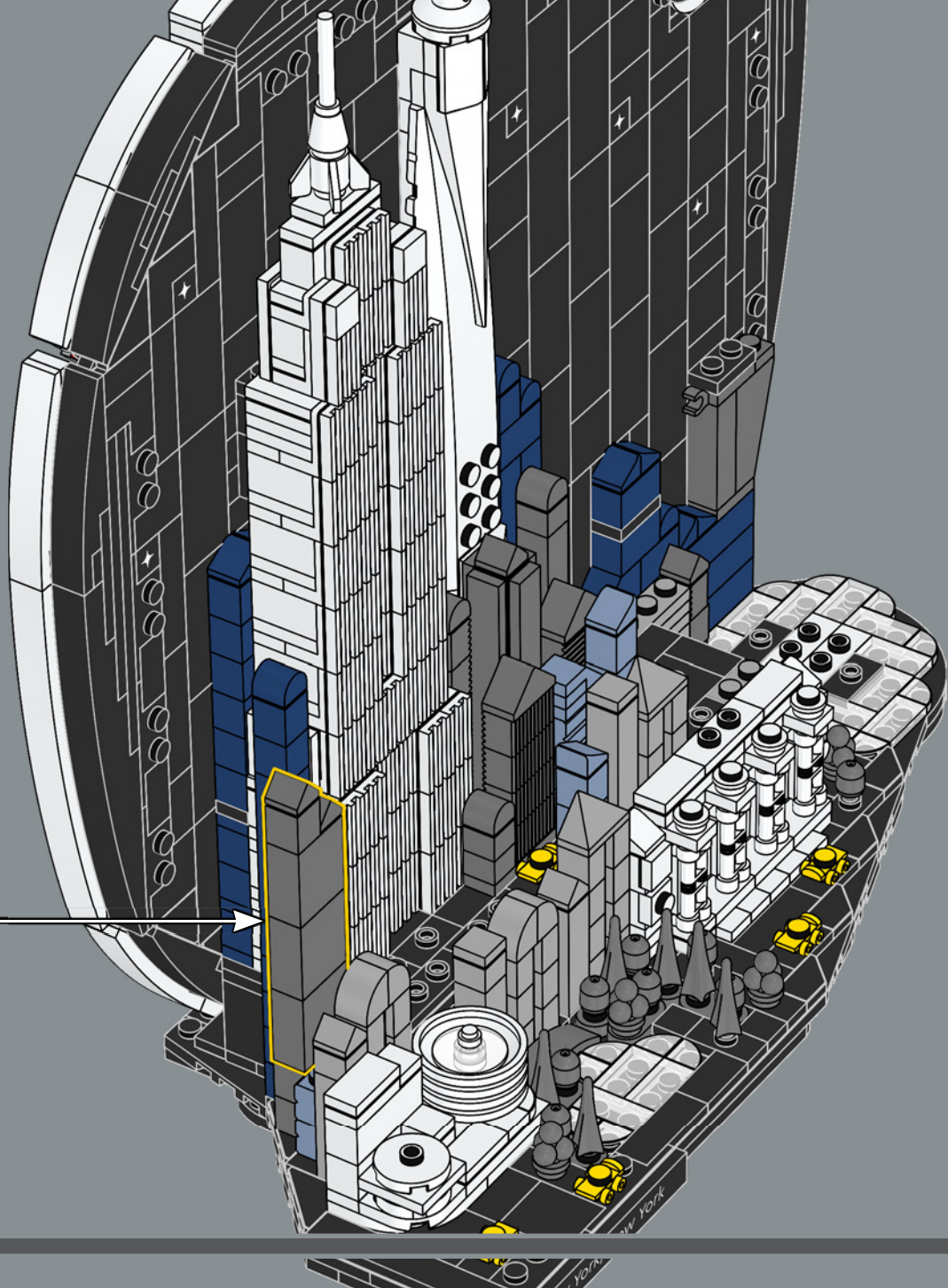
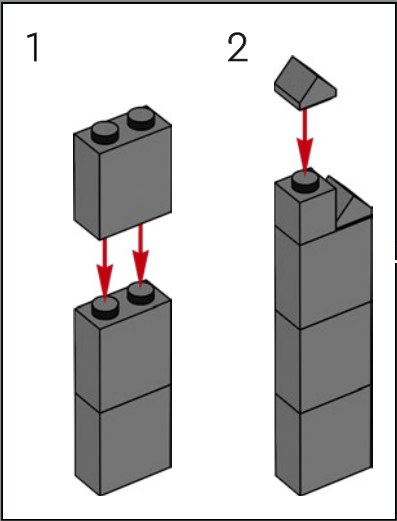

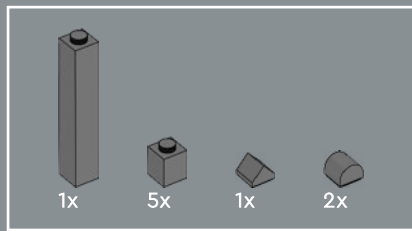

300

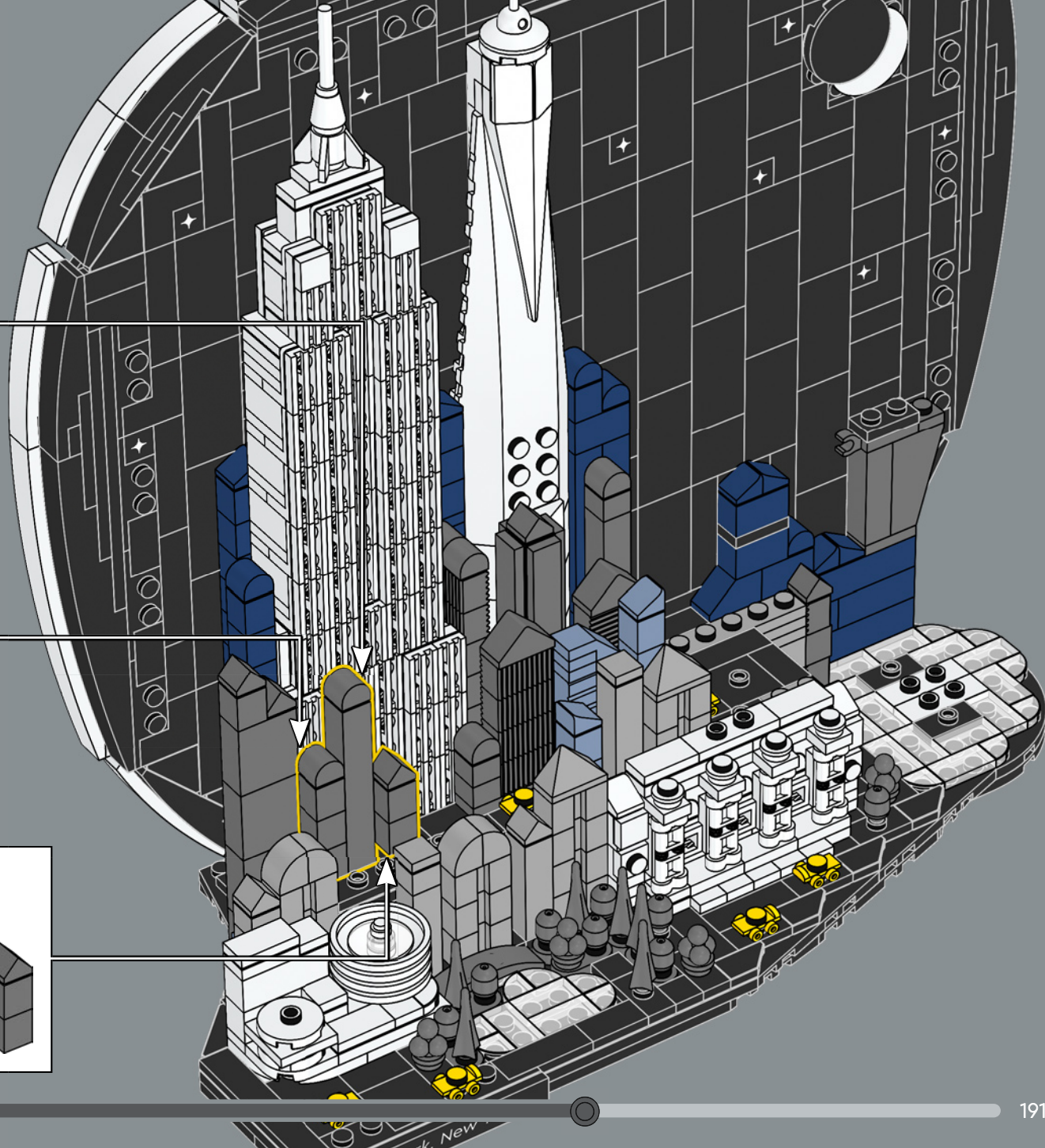
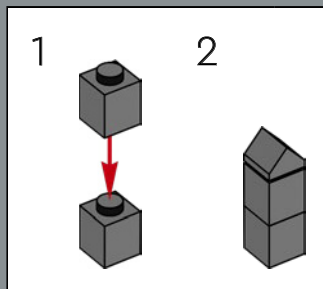
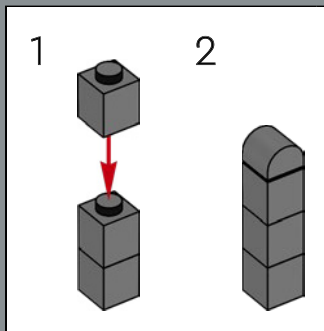
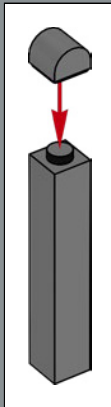



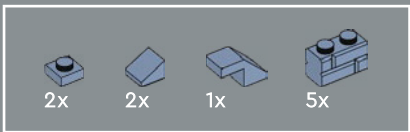

301

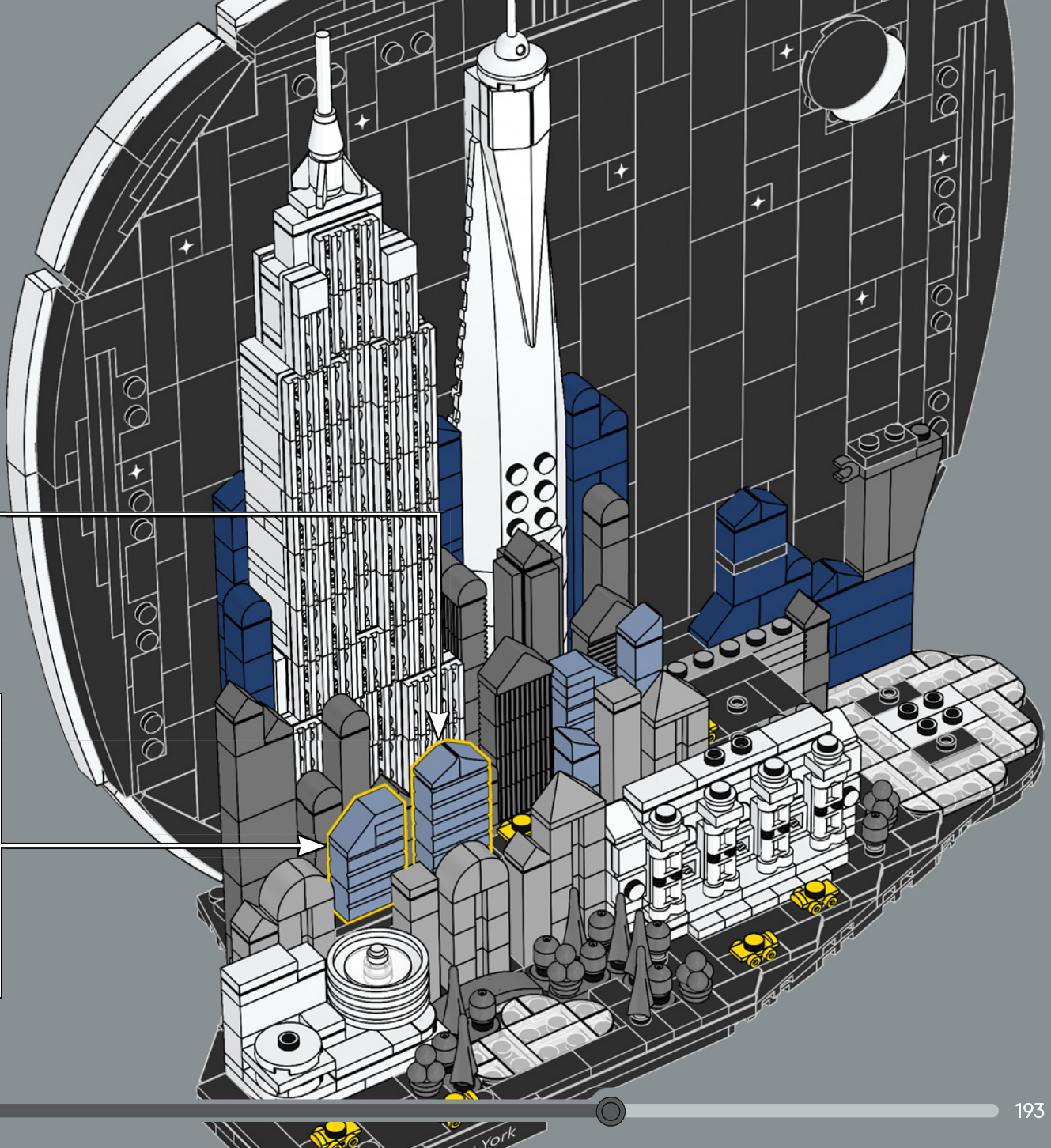
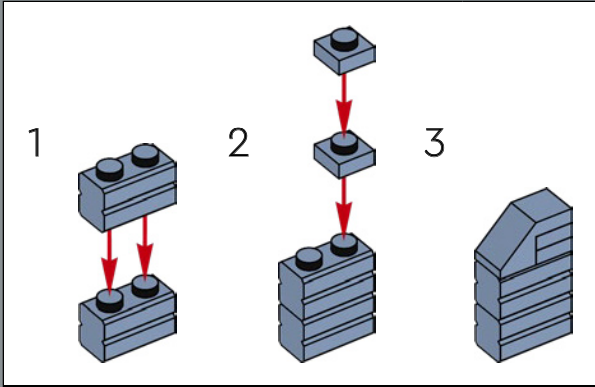
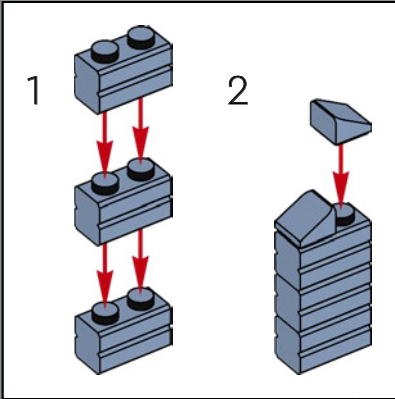

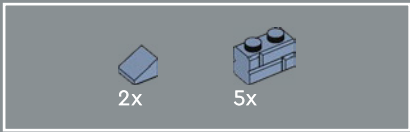

302

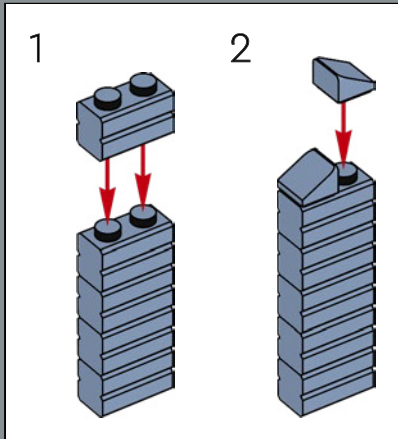
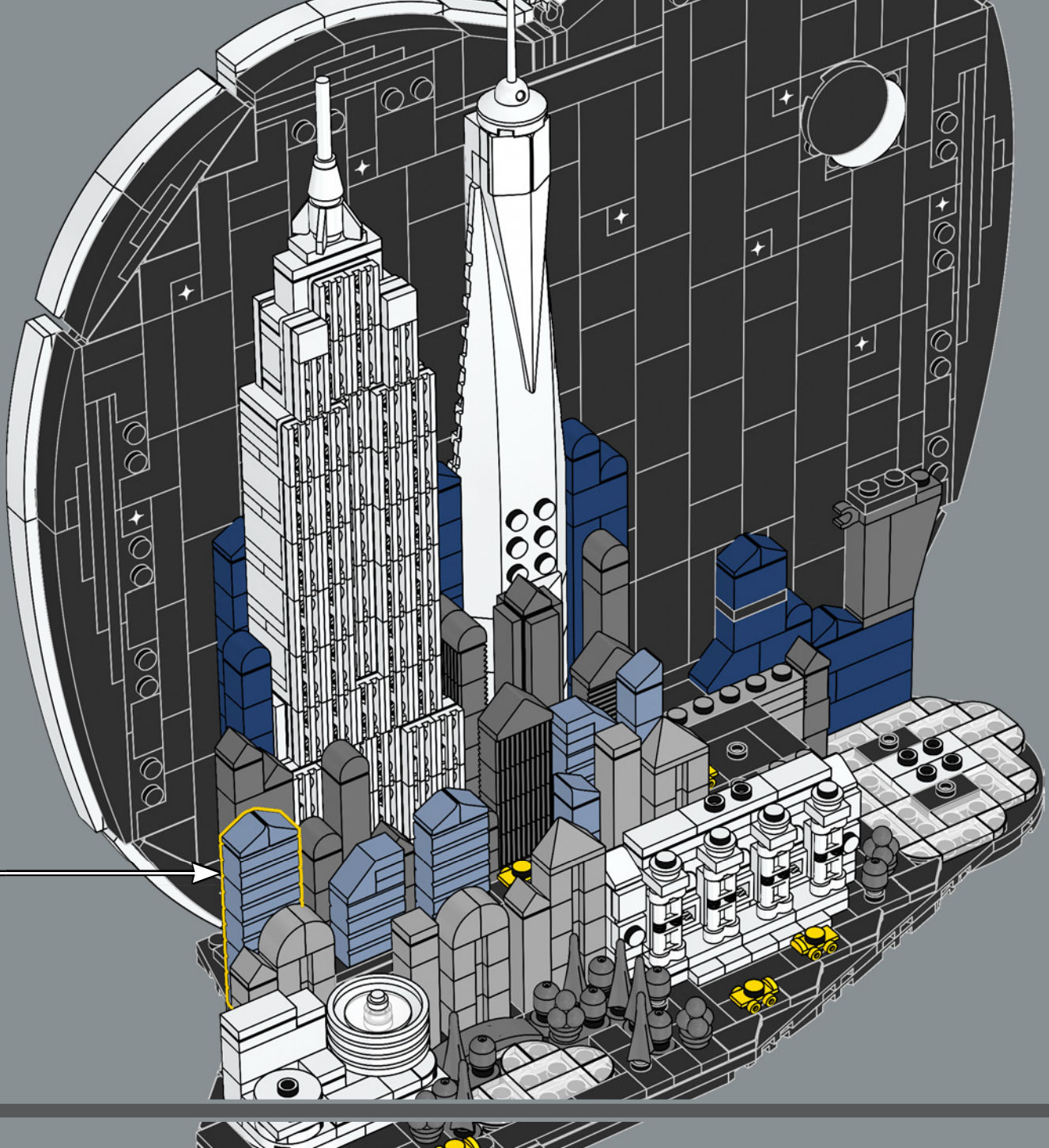



303

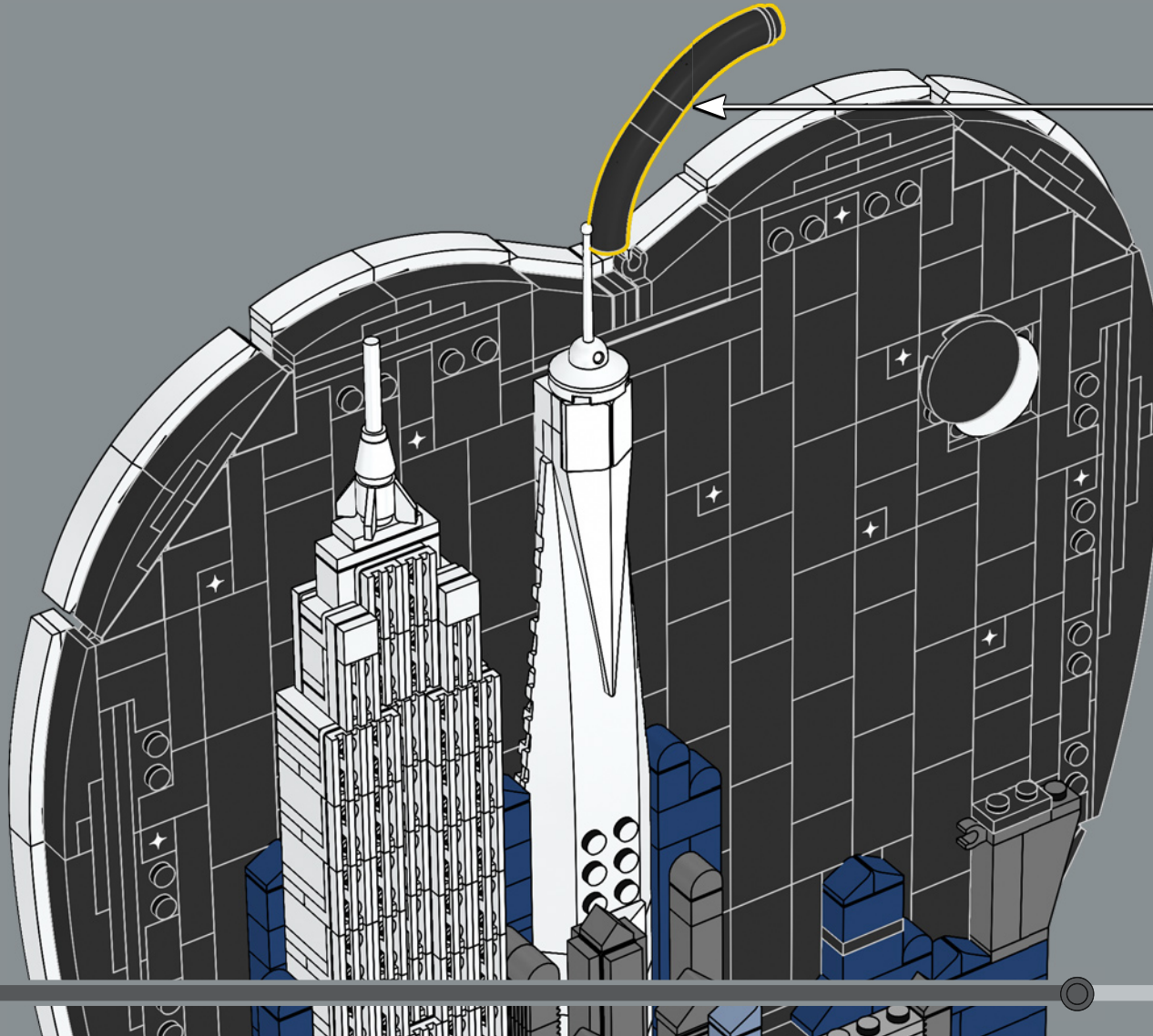
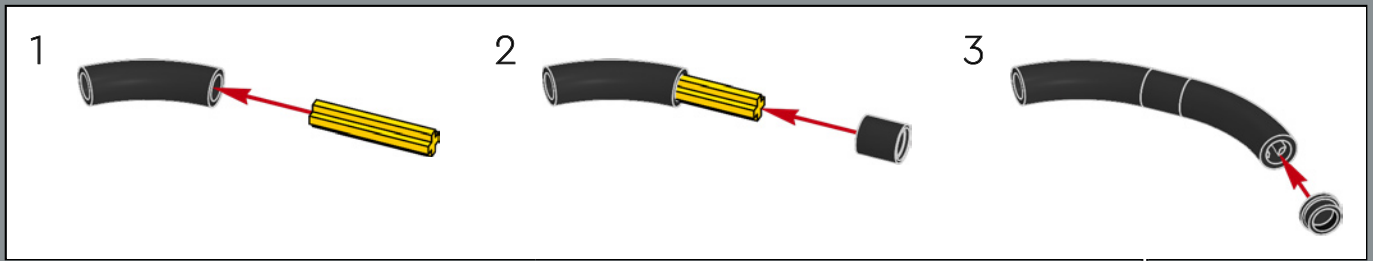

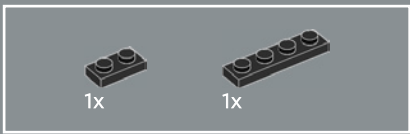

304

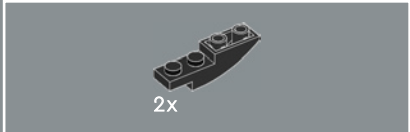
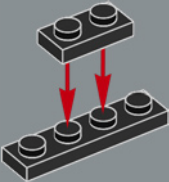

305

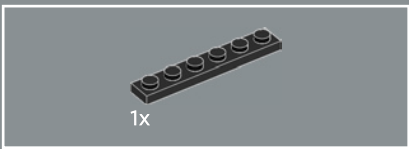
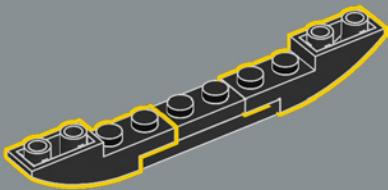

306

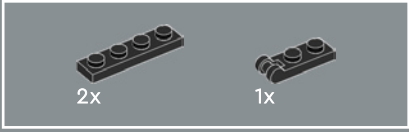
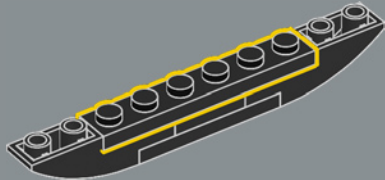

307

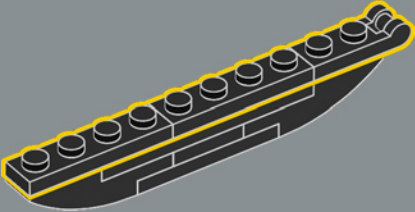

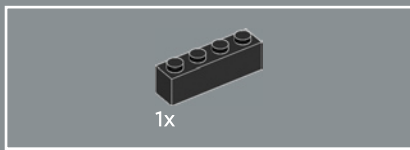

308

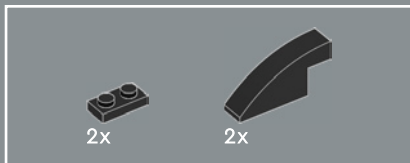
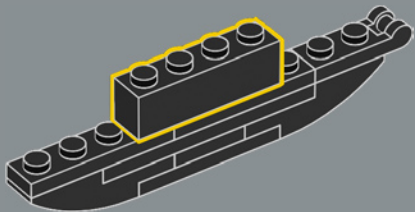

309

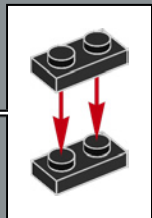
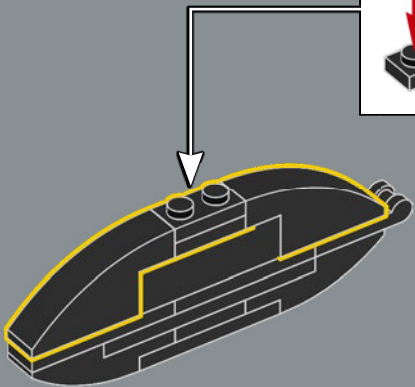

310

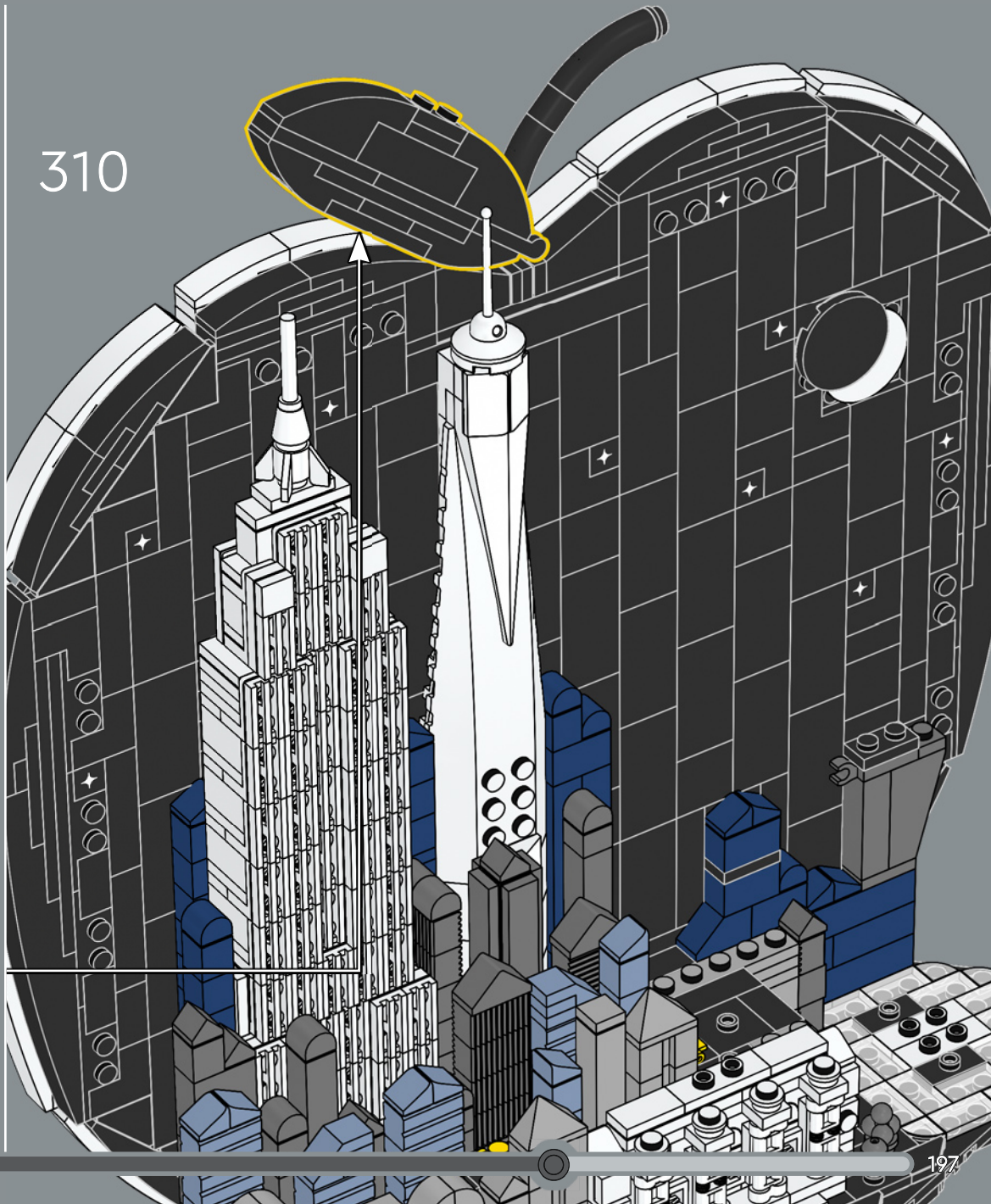

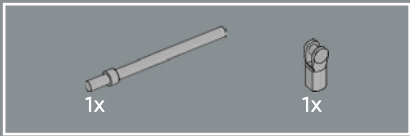

311

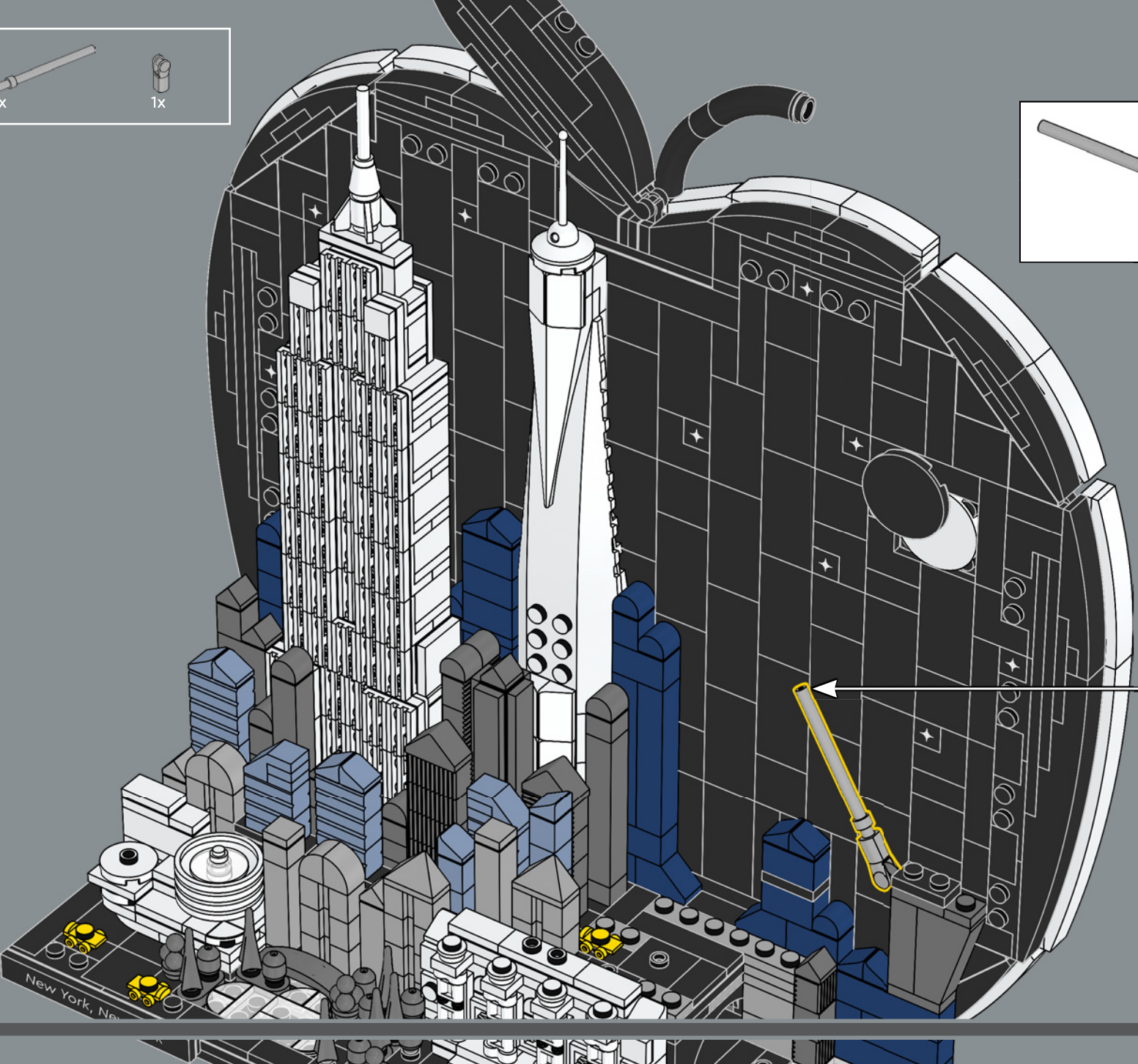
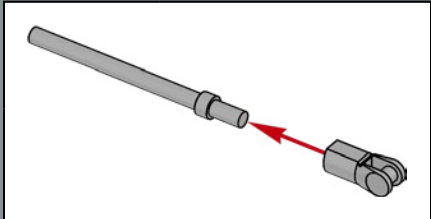

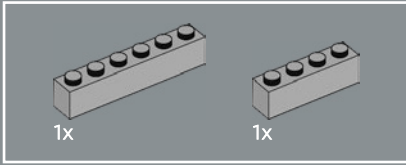
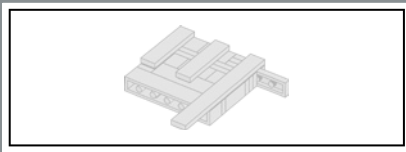

312

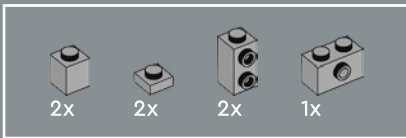
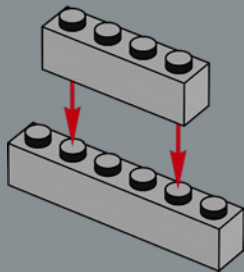

313

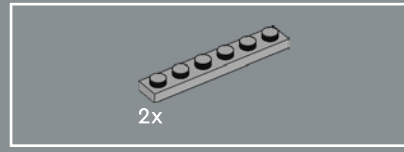
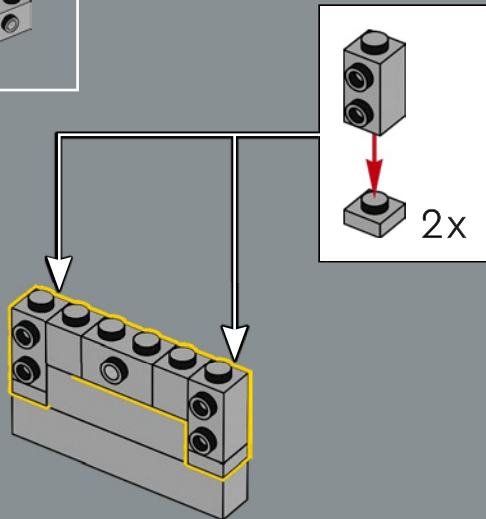

314

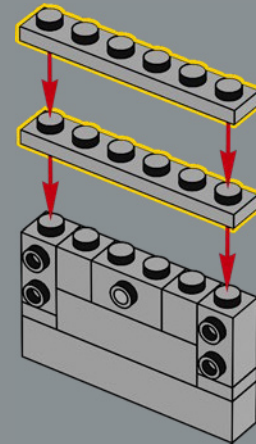

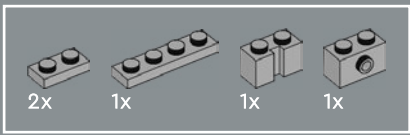

315

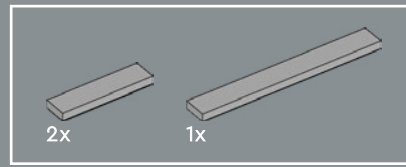
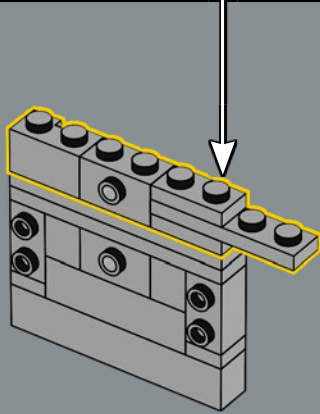
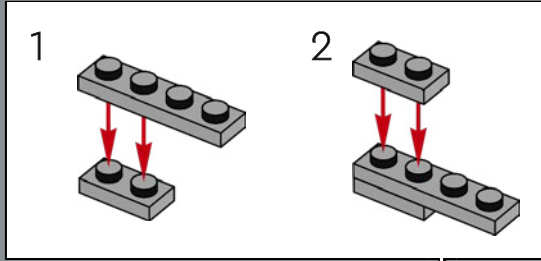

316

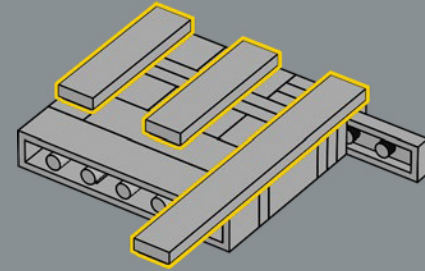

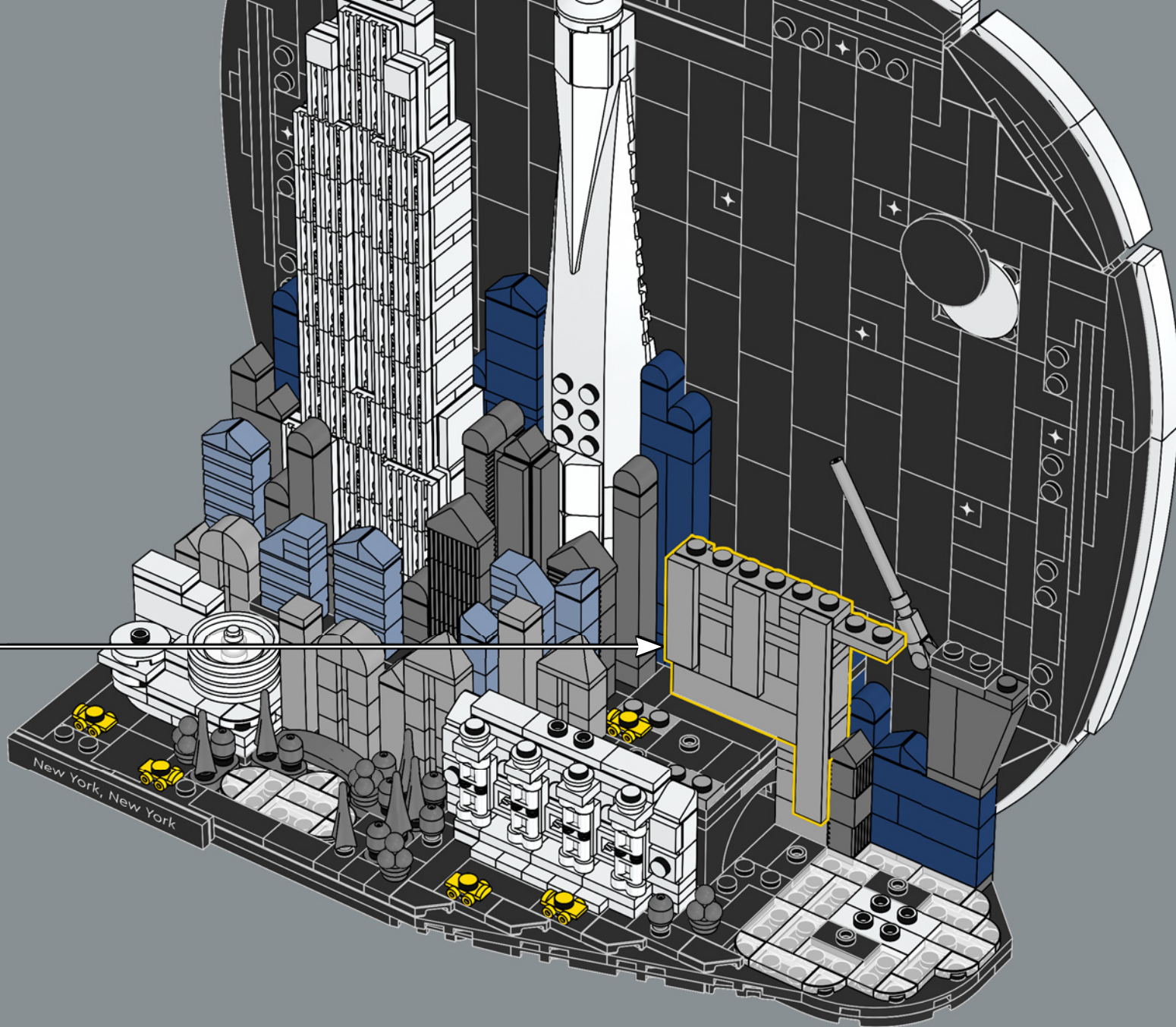

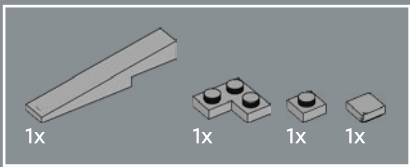

318

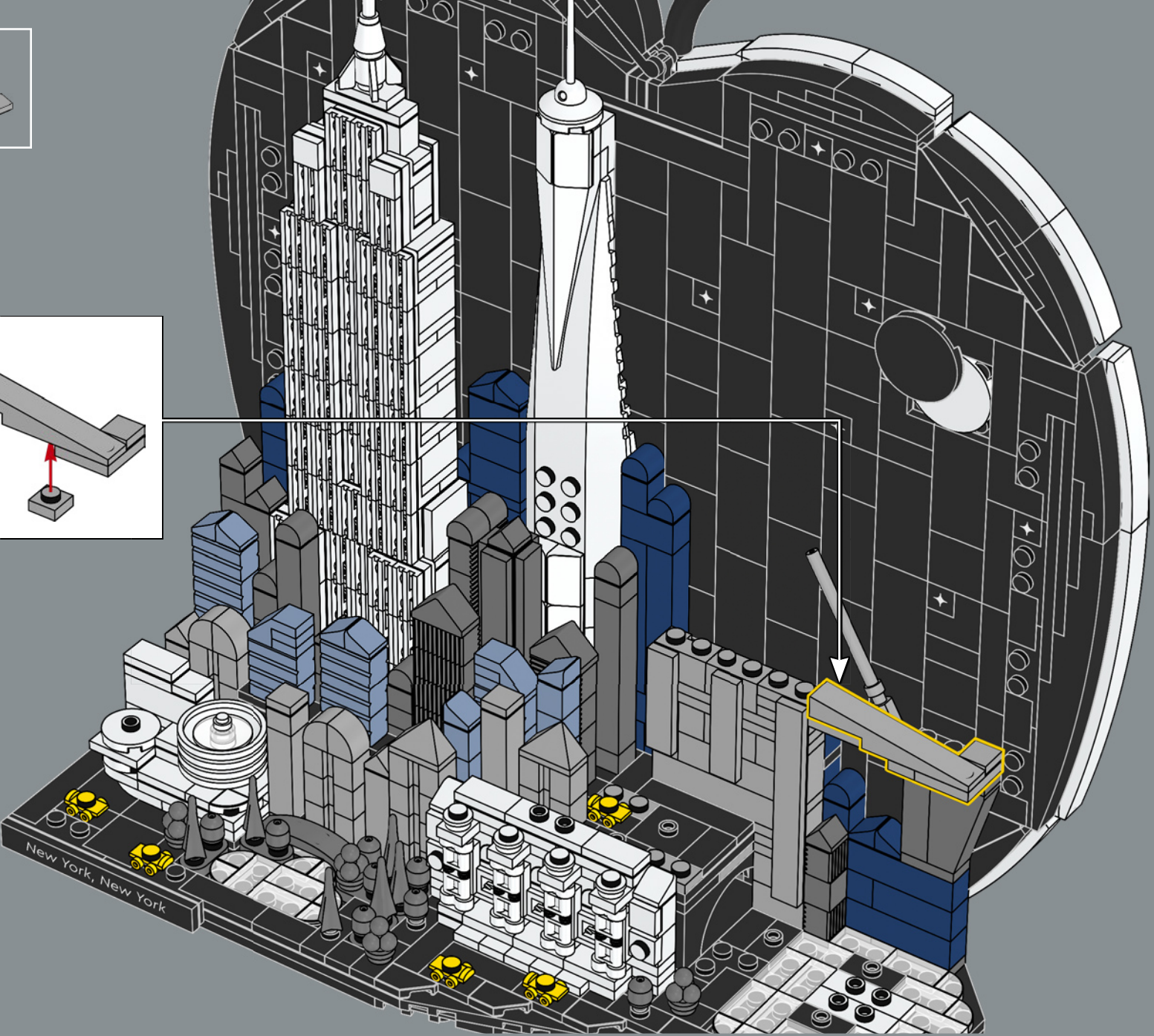
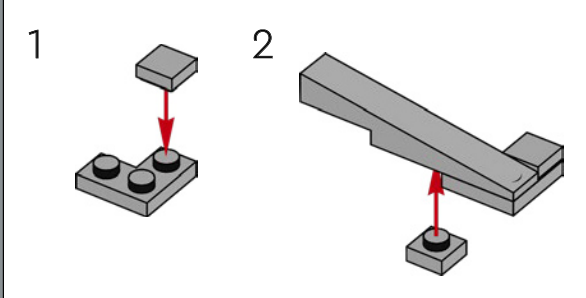



319

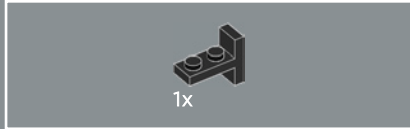

320



321

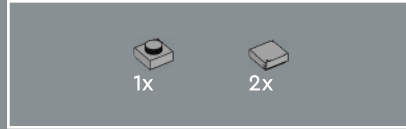
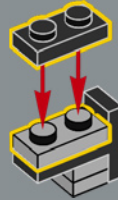

322

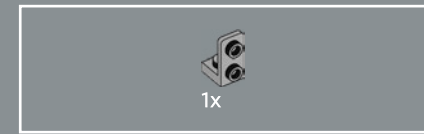
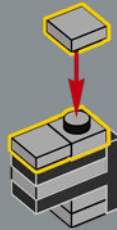

323

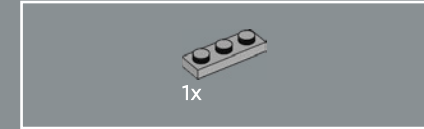
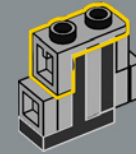

324

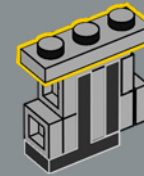

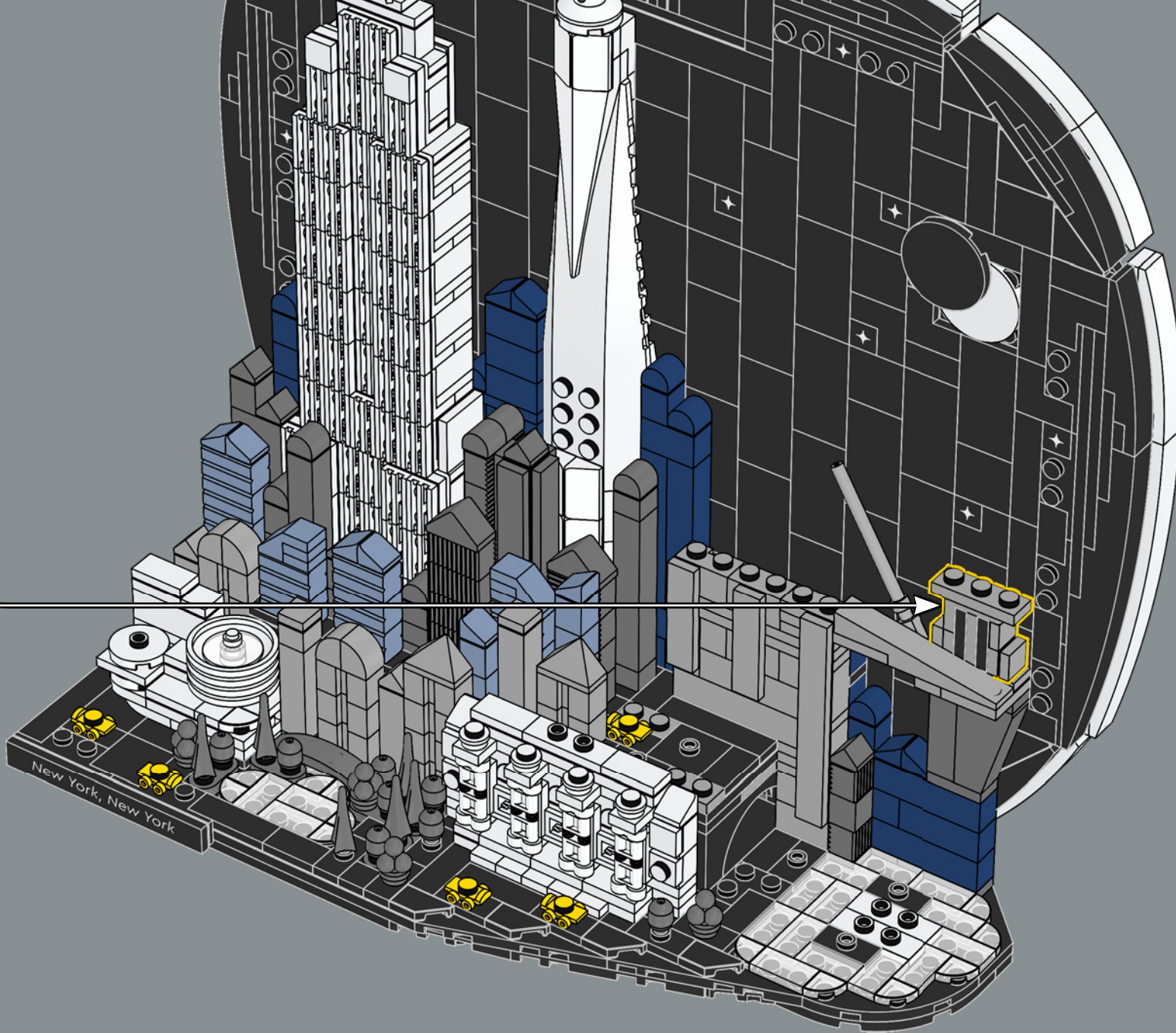

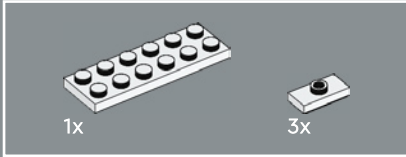
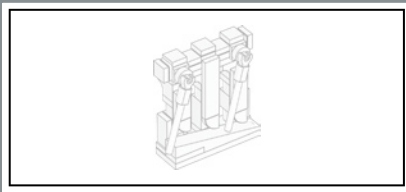

326

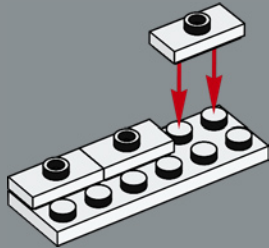

327

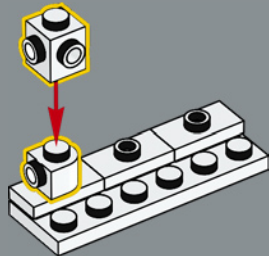

328

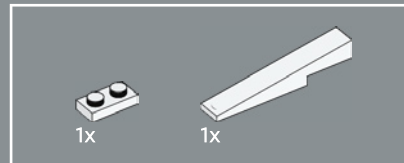
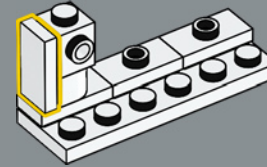

329

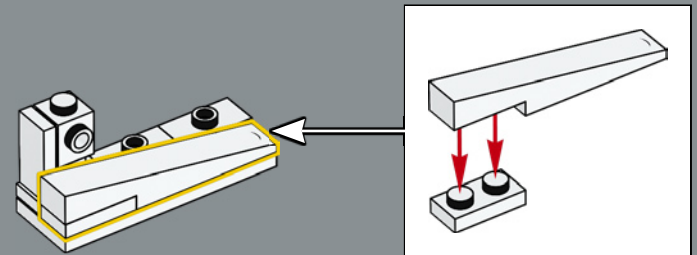

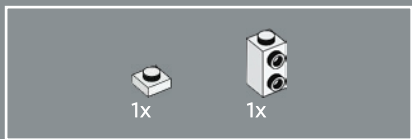

330

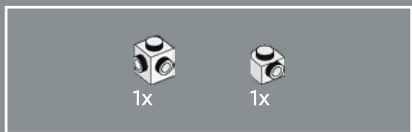
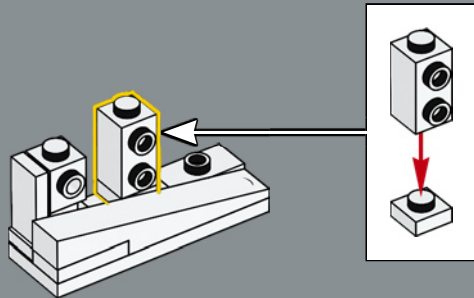

331

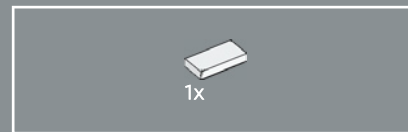
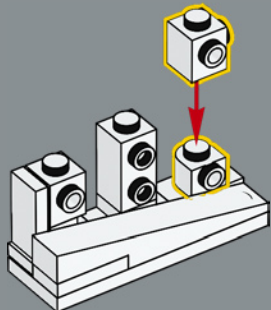

332

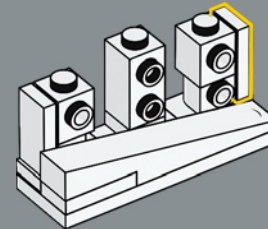

333

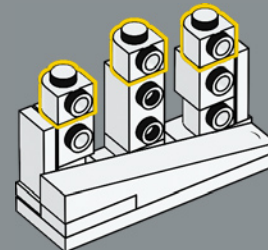



334

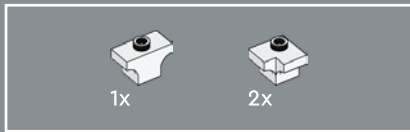
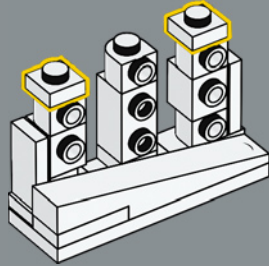

335

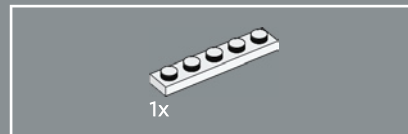
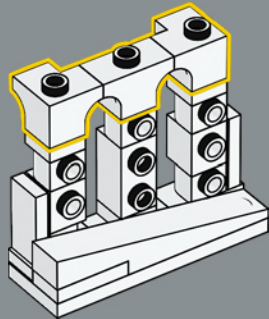

336

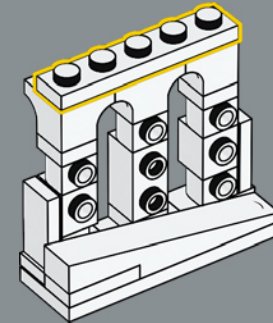

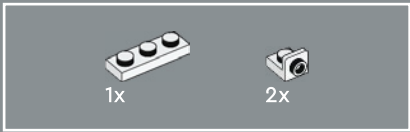

337

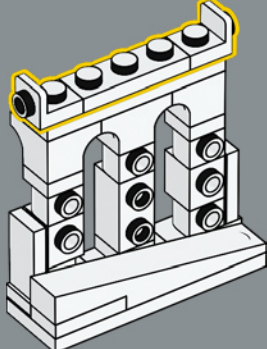

338

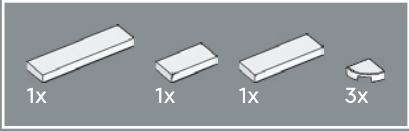
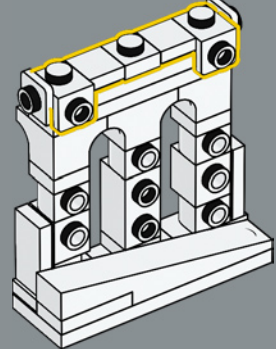

339

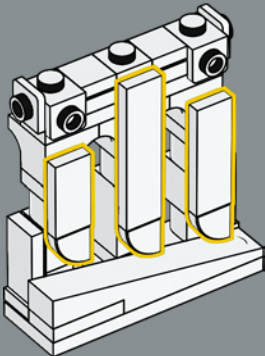



2x

340

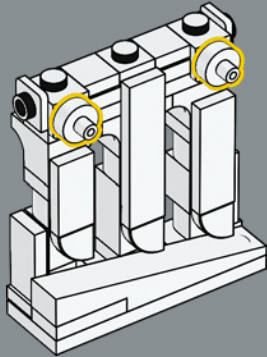

5x

341

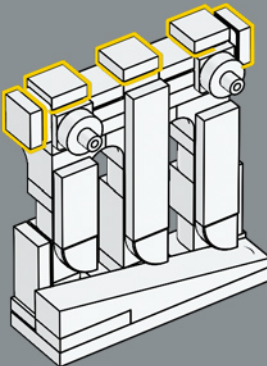

2x



2x

342

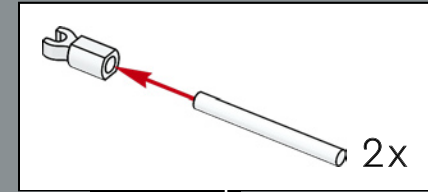

2x

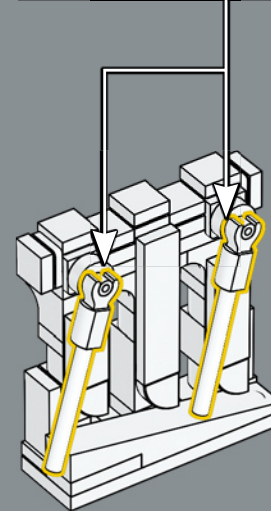

More than 137,000 people cross the Brooklyn Bridge daily by car, foot or bike. (Trucks are not allowed on the bridge.)



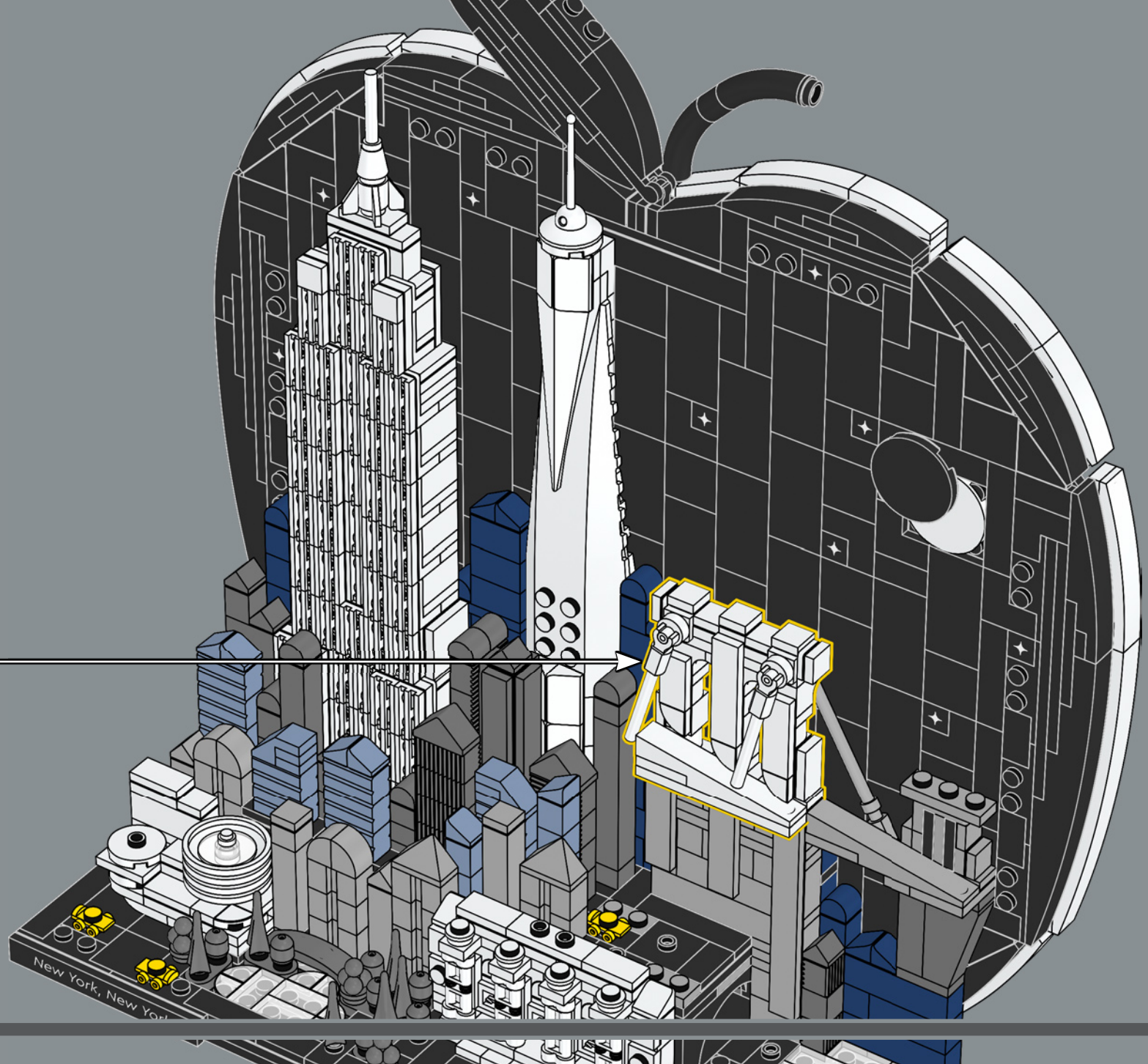

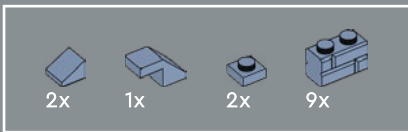

344

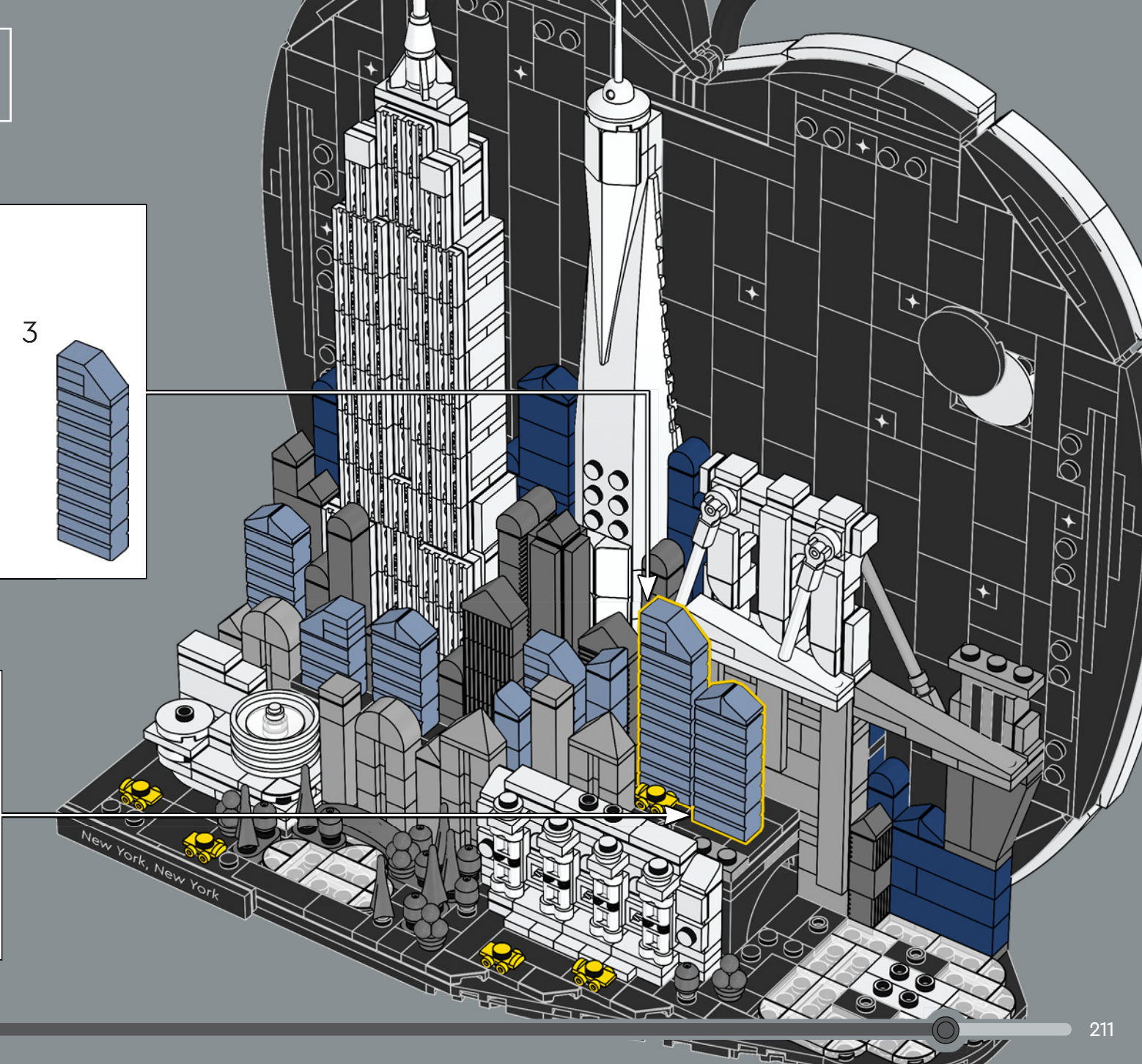
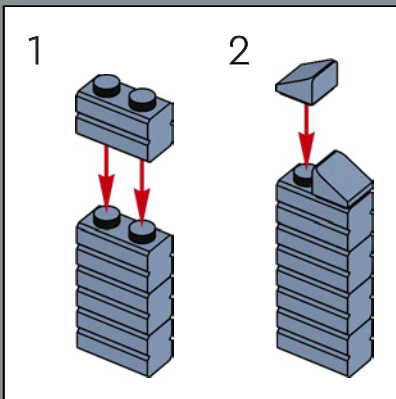
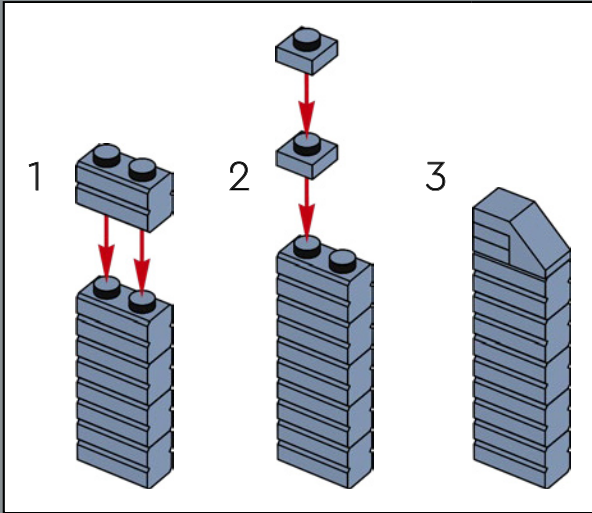

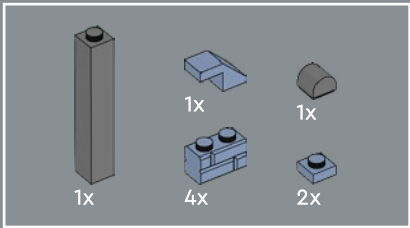

345

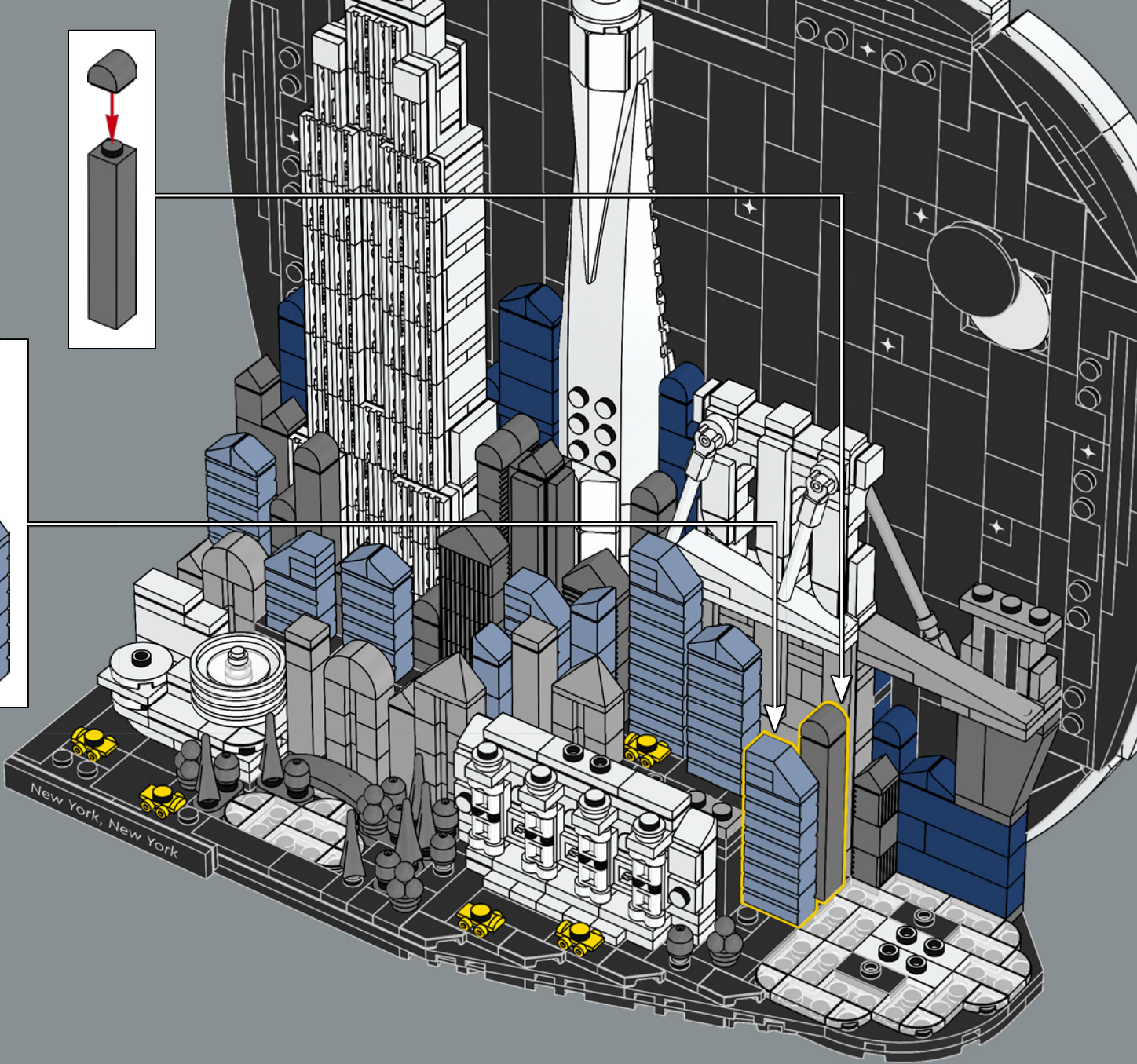
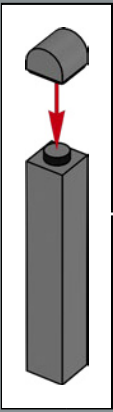
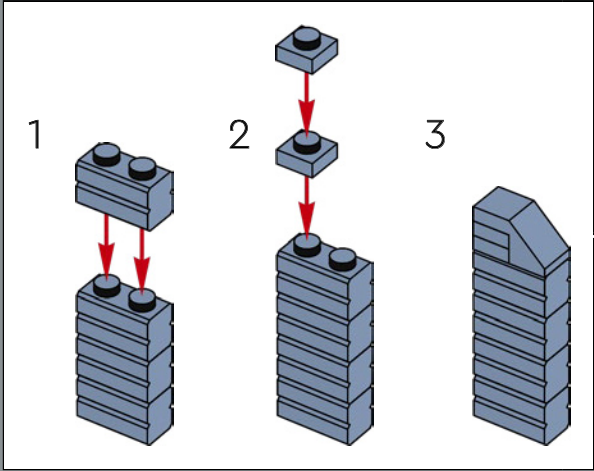

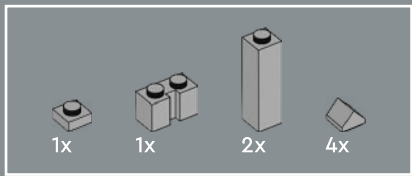

346

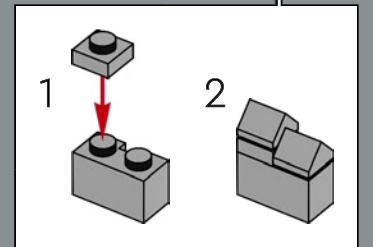
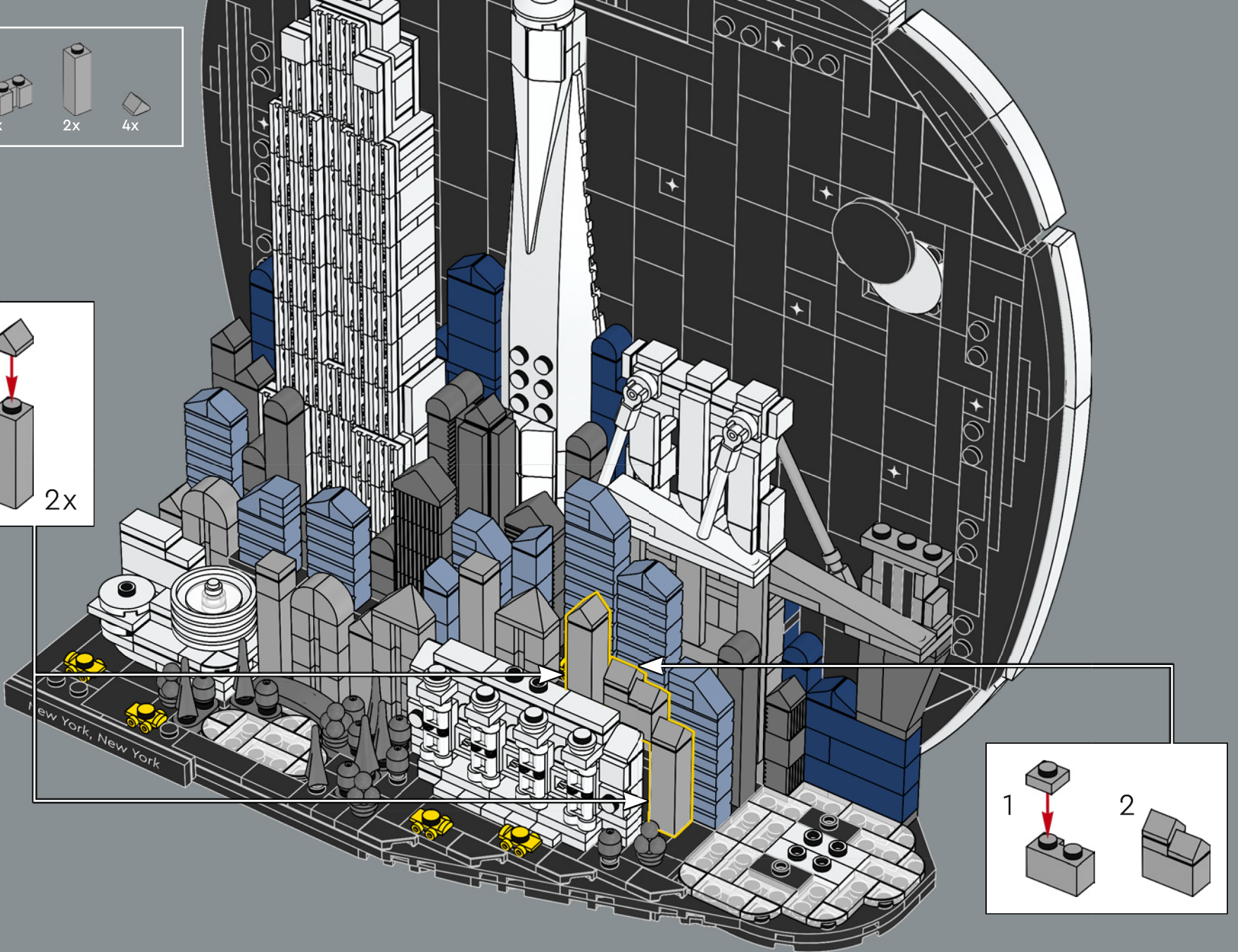
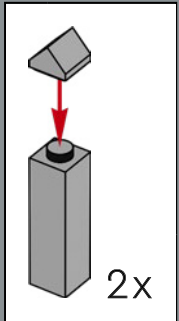

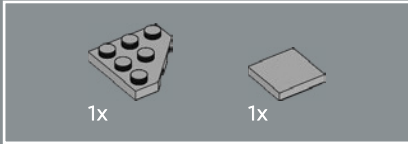

347

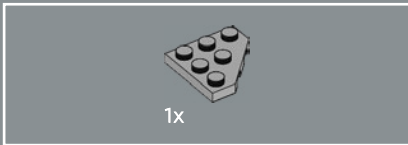
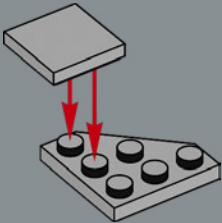

348

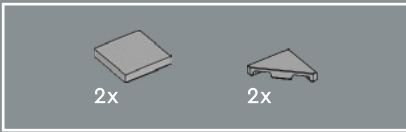
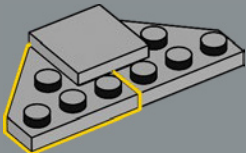

349

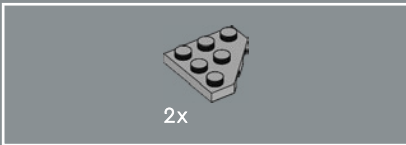
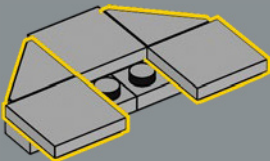

350

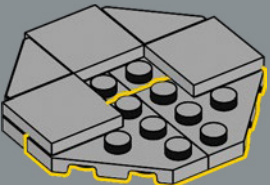

The impressive copper Statue of Liberty stands 92.9 m (305 ft.) tall – around the height of a 22-storey building – from the ground to the peak of the flame.

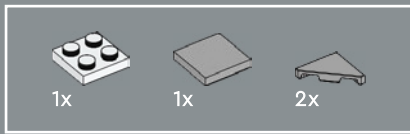

351

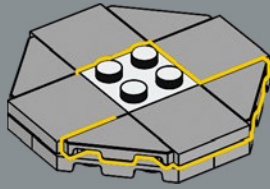

352

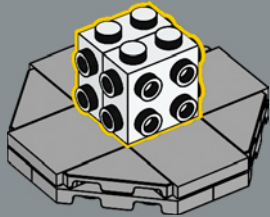

353

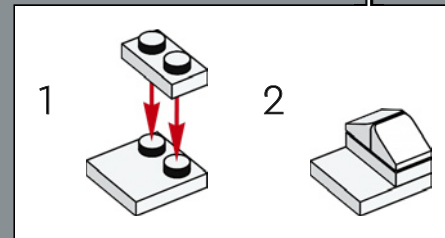
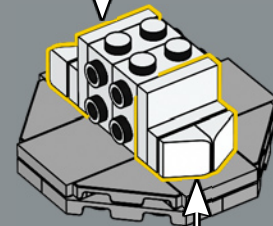
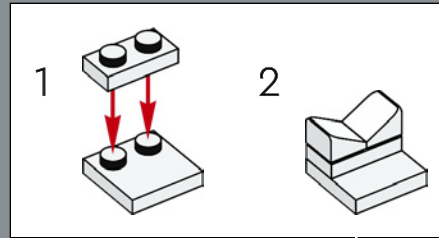



354

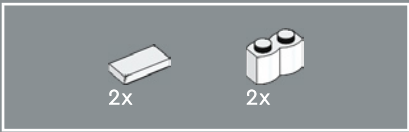
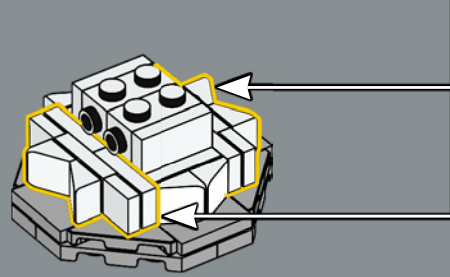
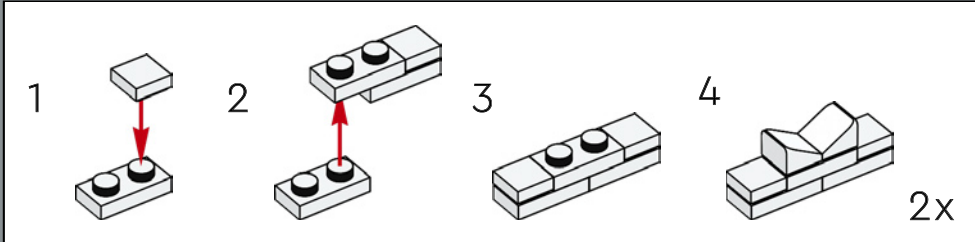

355

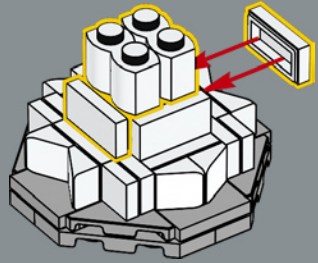



356

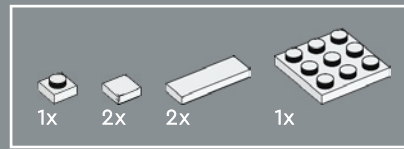
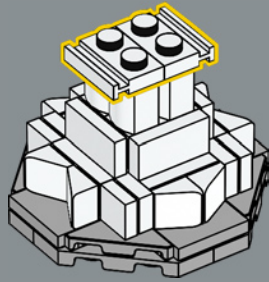

357

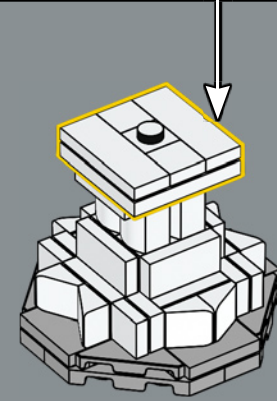
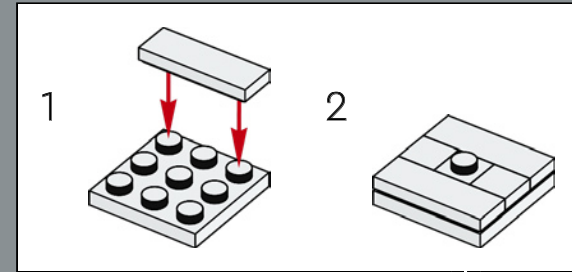

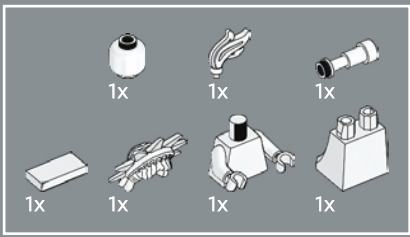

358

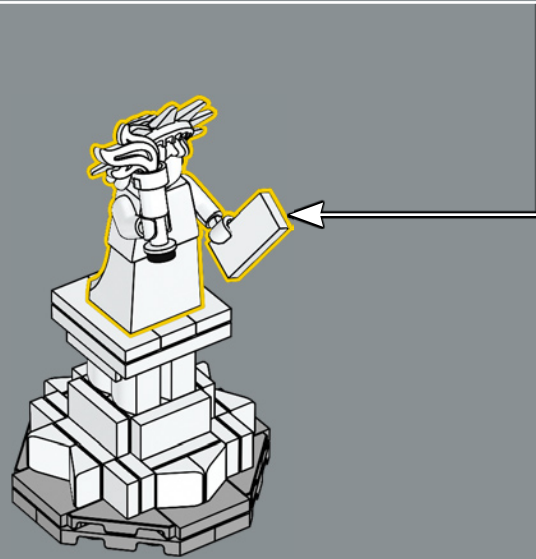
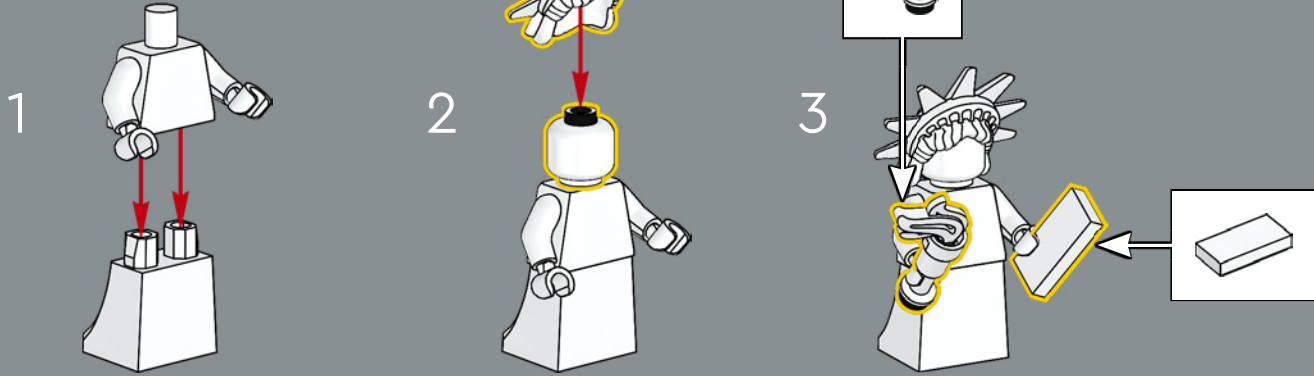

'Lady Liberty' has appeared in LEGO® minifigure form a few times before – the first one was released in 2012.

359

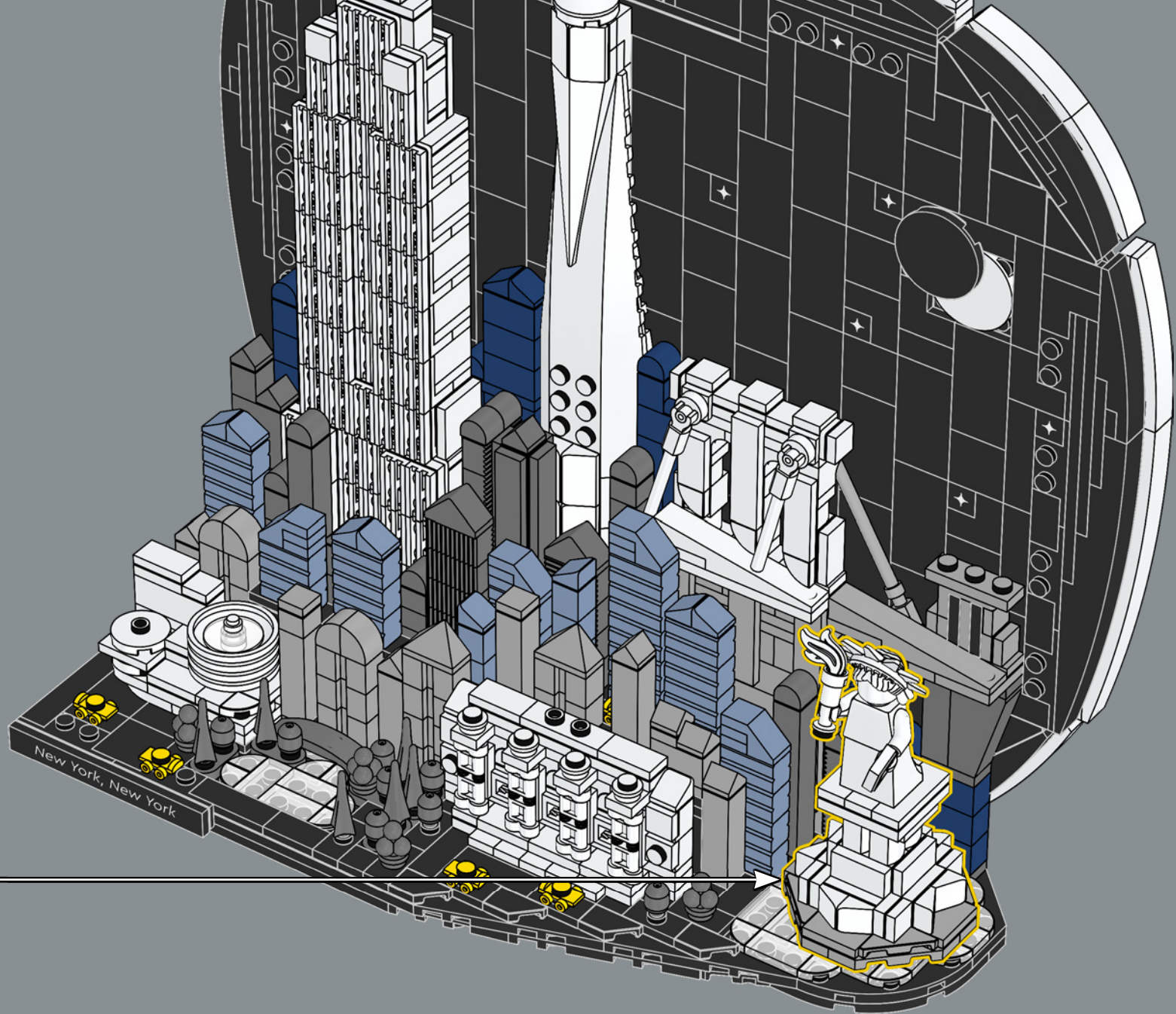

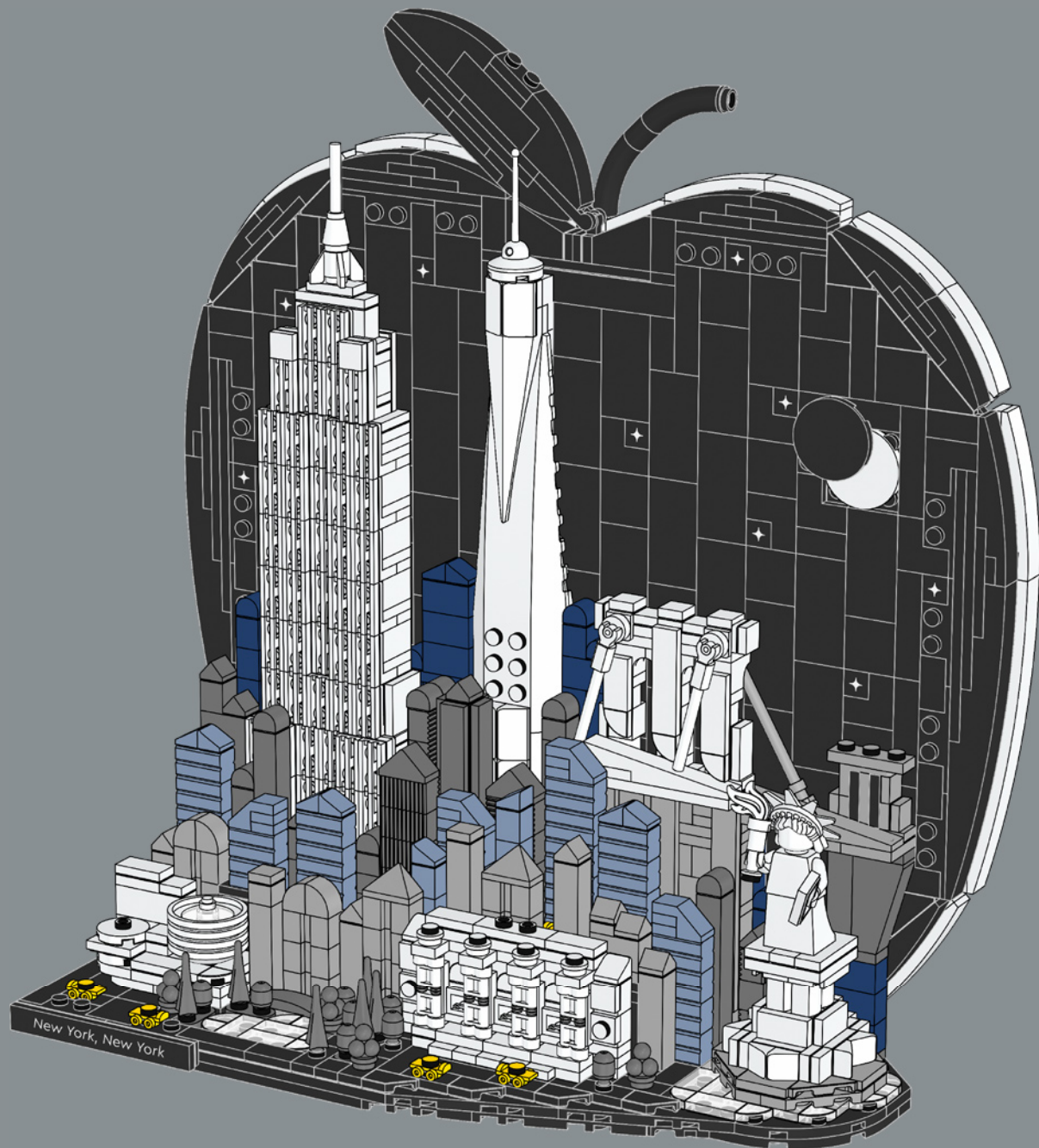

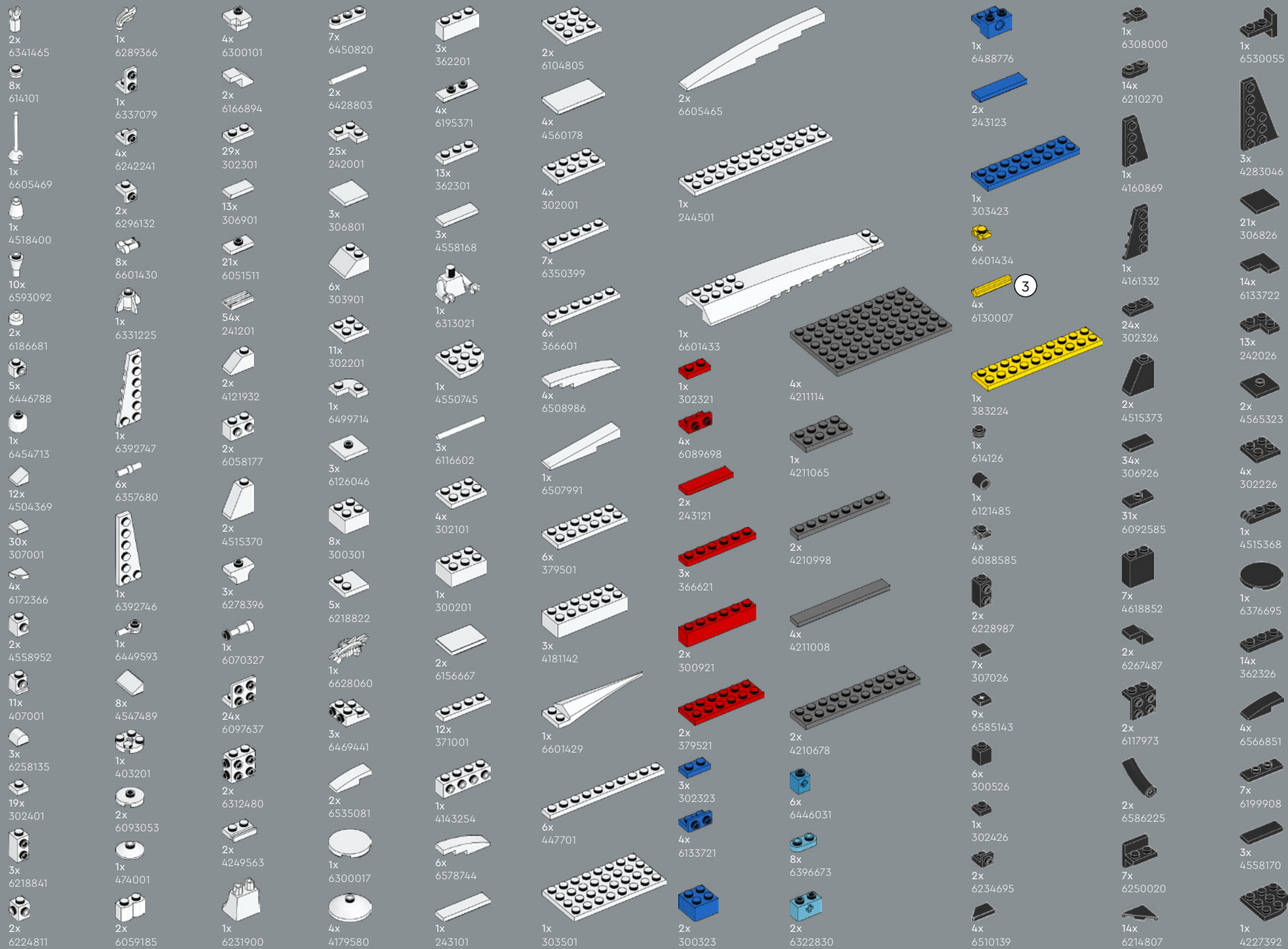

- 10x 6118829
- 2x 6168620
- 1x 4531412
- 6x 6580394
- 18x 243126
- 8x 371026
- 3x 4160025
- 1x 365926
- 1x 301026
- 2x 6039869
- 14x 302026
- 5x 663626
- 4x 6535144
- 5x 6184876
- 1x 366626
- 1x 4243819
- 1x 6101857
- 2x 4181144
- 57x 4560182
- 1x 6585142
- 8x 303226
- 2x 303426
- 1x 6037390
- 1x 395826
- 2x 383226
- 6x 4514845
- 2x 302926
- 2x 6001494
- 2x 6601431
- 1x 4166619
- 1x 6372045
- 5x 346026
- 4x 379526
- 6x 4106977
- 2x 6509390
- 1x 6439175
- 8x 4504374
- 6x 6403899
- 6x 4255413
- 6x 6595205
- 15x 4249891
- 4x 6103405
- 6x 6233955
- 9x 4177735
- 3x 4264569
- 1x 6343976
- 13x 4211399
- 6x 6253436
- 2x 6401023
- 2x 6225242
- 2x 4211389
- 5x 4211415
- 4x 4211476
- 4x 6522869
- 7x 6061702
- 1x 6345639
- 2x 6075075
- 4x 6407767
- 4x 4211526
- 15x 4617170
- 2x 6383177
- 7x 4211398
- 1x 4211388
- 4x 6066097
- 4x 6134378
- 4x 6217876
- 14x 4211397
- 1x 4211387
- 1x 4211353
- 4x 4211413
- 2x 6569357
- 1x 4211429
- 4x 4211361
- 1x 6421522
- 4x 4160560
- 11x 4211445
- 1x 4211394
- 2x 4211356
- 6x 6015347
- 8x 6442144
- 1x 6170418
- 3x 4211393
- 3x 4211438
- 1x 6508016
- 4x 4243797
- 4x 4211452
- 2x 4211392
- 1x 4211481
- 4x 4211402
- 1x 4211401
- 4x 4662161
- 3x 4210690
- 2x 4210700
- 7x 6221607
- 2x 4226221
- 12x 6514469
- 1x 6514246
- 17x 6514223
- 8x 6062686
- 7x 4620077
- 8x 6257079
- 4x 6248952
- 28x 6417947
- 1x 383228
- 2x 302028
- 8x 6344216
- 16x 4210636
- 6x 6269969
- 9x 4211063
- 4x 6601435
- 3x 4210978
- 4x 6092572
- 10x 4211098
- 5x 6262021
- 7x 6333129
- 1x 4210719
- 5x 6388133
- 1x 4648256
- 1x 4500975
- 1x 6336990
- 2x 4211104
- 5x 4211133
- 1x 4648256
- 1x 6240515



[LEGO.com/service](https://www.LEGO.com/service)



YOU COULD
WIN



**YOU COULD
WIN**

Your feedback will help shape the future development of this product series.

Visit:

**DU KÖNNTEST
GEWINNEN**

Dein Feedback trägt zur Weiterentwicklung dieser Produktreihe bei.

Geh auf:

**VOUS POURRIEZ
GAGNER**

Vos commentaires nous aideront à concevoir les futurs produits de cette gamme.

Visitez :

**POTRESTI
VINCERE TU**

La tua opinione ci aiuterà a migliorare la creazione futura di questa linea di prodotti.

Visita:

**PUEDES
GANAR**

Tu opinión contribuirá al futuro de esta serie de productos.

Visita:

轻松获奖

您的反馈将有助于我们在今后改进本产品系列。

请访问:

LEGO.com/productfeedback

You also have the chance to win a LEGO® set.

Terms and conditions apply.*

Außerdem hast du die Chance, ein LEGO® Set zu gewinnen.

Es gelten die Teilnahmebedingungen.*

Vous pourriez également gagner un ensemble LEGO®.

Des conditions s'appliquent.*

Hai anche la possibilità di vincere un set LEGO®.

Termini e condizioni sono applicabili.*

También tienes la oportunidad de ganar un set LEGO®.

Aplican términos y condiciones.*

您还有机会赢取乐高®套装。

条款和条件适用。*

*LEGO.com/productfeedback-terms

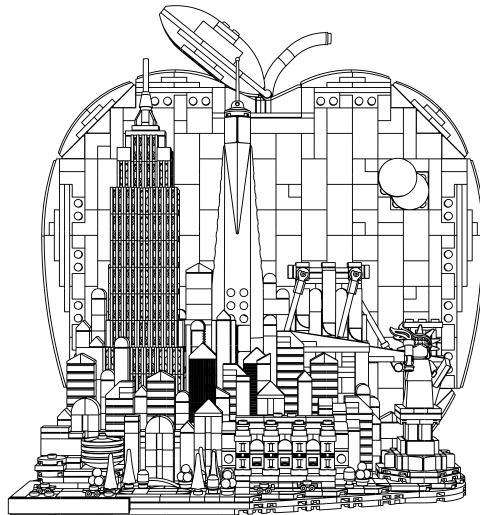

LEGO and the LEGO logo are trademarks of the LEGO Group. ©2026 The LEGO Group.

The EMPIRE STATE BUILDING name and image are registered trademarks and used with permission.

The name and building image of the Solomon R. Guggenheim Museum are trademarks of the Solomon R. Guggenheim Foundation. Used with permission.

® /™ /© Frank Lloyd Wright Foundation. All Rights Reserved.

One World Trade Center building design is a copyright of WTC Tower 1 LLC. Used under license.

Adam Reed Tucker is the co-developer of the LEGO® Architecture product line.