

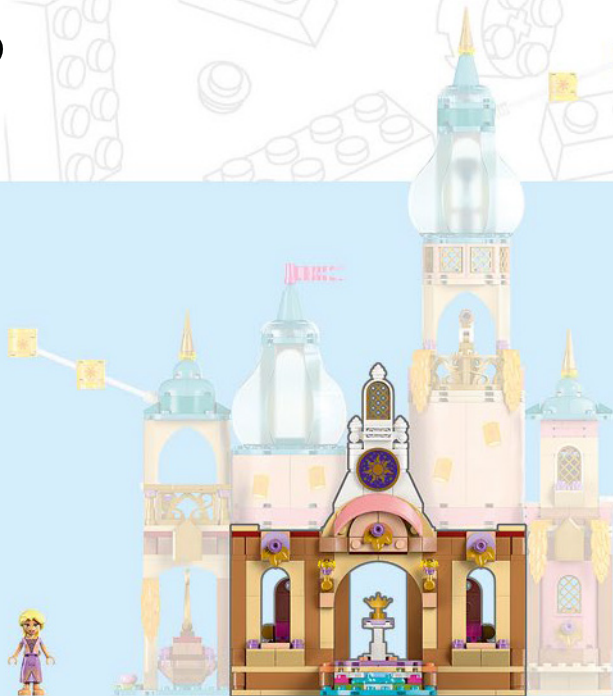

Disney

43297



WARNING: CHOKING HAZARD.
Toy contains small parts and a small ball.
Not for children under 3 years.





Get excited about our new packaging!

We're switching from plastic to paper-based packaging. That's why you might find a mix of paper and plastic in our boxes!

Nos nouveaux emballages vous emballeront !

Nous passons des emballages en plastique aux emballages à base de papier. C'est pourquoi vous pourriez trouver un mélange de papier et de plastique dans nos boîtes !

¡Te presentamos nuestros nuevos empaques!

Estamos sustituyendo las bolsas de plástico por bolsas con base de papel. ¡Por eso, puedes encontrar una mezcla de papel y de plástico en nuestras cajas!

[LEGO.com/sustainable-packaging](https://www.lego.com/sustainable-packaging)

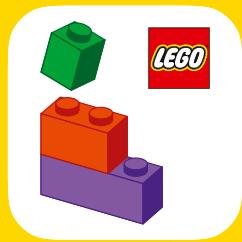

LEGO® Builder



BUILDER



Apple and the Apple logo are trademarks of Apple Inc., registered in the U.S. and other countries and regions. App Store is a service mark of Apple Inc. Google Play and the Google Play logo are trademarks of Google LLC. Tencent and the Tencent logo are trademarks of Tencent Inc.

LEGO.com/devicecheck

EN Ask parents' permission before going online | DE Eltern um Erlaubnis bitten, bevor du online gehst | FR Demande l'autorisation d'un parent avant d'aller en ligne | IT Chiedi il permesso ai tuoi genitori prima di andare online | ES Pídeles permiso a tus papás antes de conectarte a Internet | PT Pede autorização aos teus pais antes de ficares online | ZH 上网前应先征得父母的同意 | PL Poproś rodziców o zgodę, zanim wejdiesz do Internetu | CS Než půjdeš na internet, požádej rodiče o svolení | SK Skôr než pôjdeš na internet, vypýtaj si povolenie od rodičov | HU Kérj szülői engedélyt, mielőtt online csatlakoznál! | UA Запитуйте дозволу батьків, перш ніж користуватися інтернетом | RO cere permisiunea părinților înainte de a te conecta online | BG Поискайте разрешение от родител, преди да влезете онлайн | LV Pirms došanās tiešsaistē palūdz atļauju vecākiem | ET Enne Interneti kasutamist küsi vanematelt luba | LT Prieš prisijungdami prie interneto, atsiklauskite tėvų | TR İnternete girmeden önce anne babandan izin iste

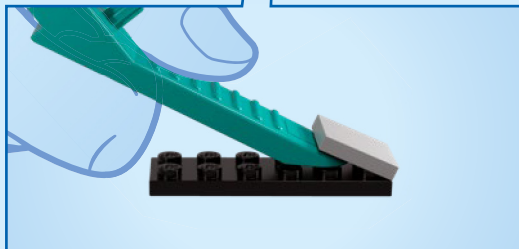
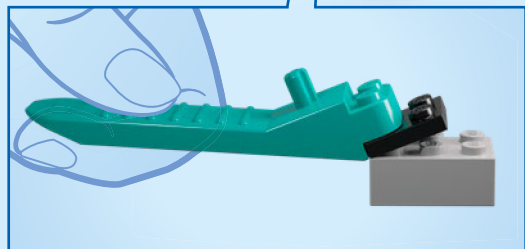
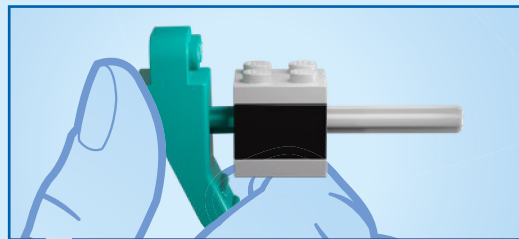
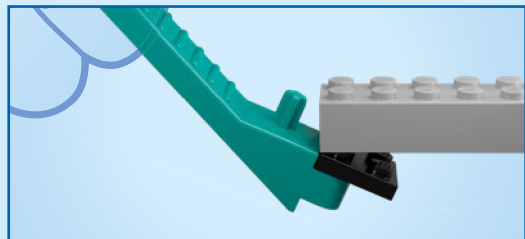



AVERTISSEMENT :
RISQUE D'ÉTOUFFEMENT.
Le jouet contient des petites
pièces ainsi qu'une petite boule.
Il ne convient pas aux enfants
de moins de 3 ans.



ADVERTENCIA:
PELIGRO DE ASFIXIA.
Juguete que contiene partes
pequeñas y una pelota
pequeña. No recomendado
para niños menores de 3 años.



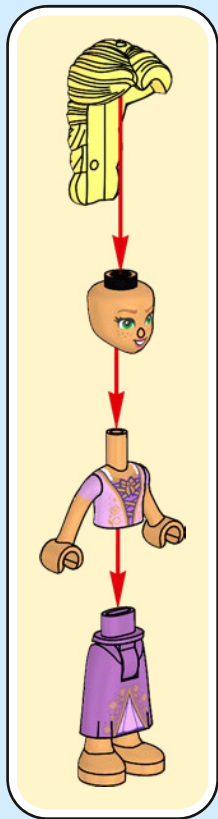

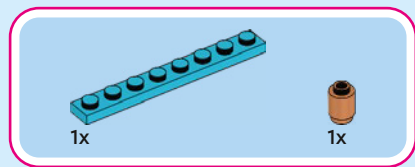

1

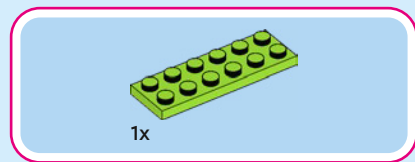
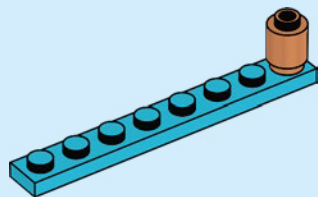

2

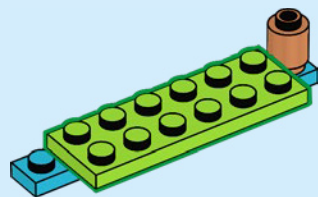

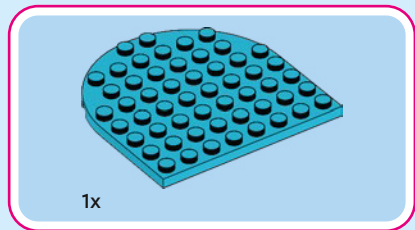

3

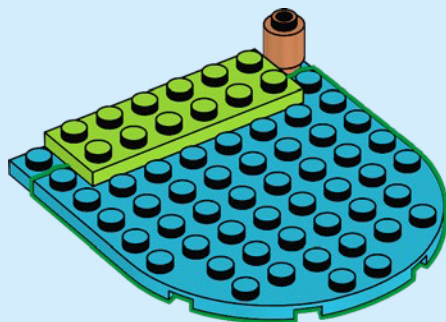



2x



2x

4

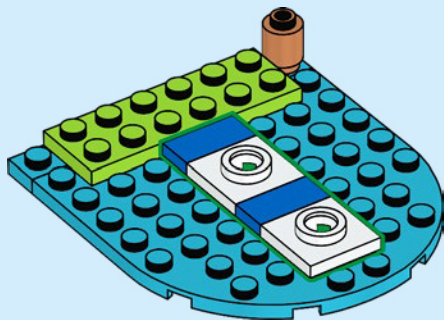

1x



2x

5

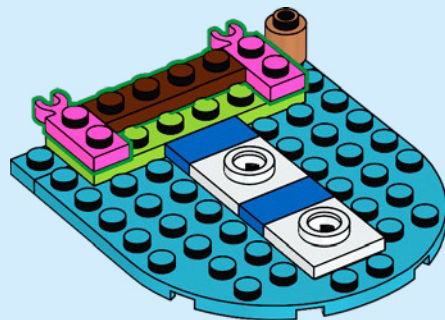



1x

6

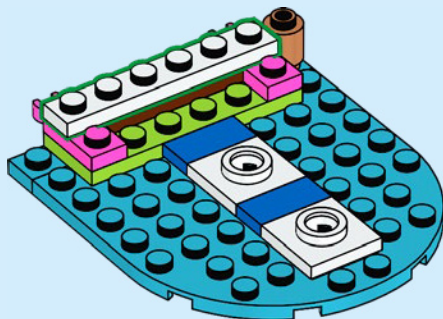



1x

7

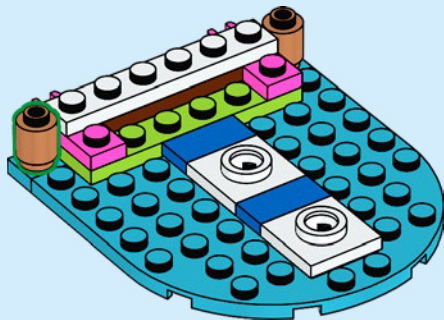

2x

8

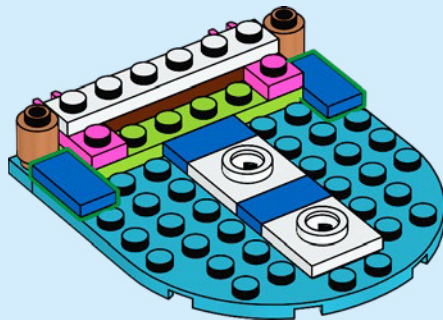



2x

9

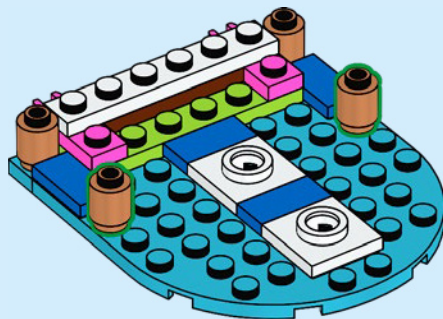

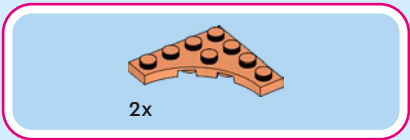

10

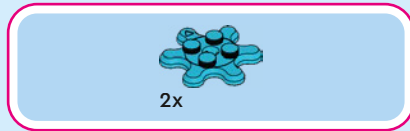
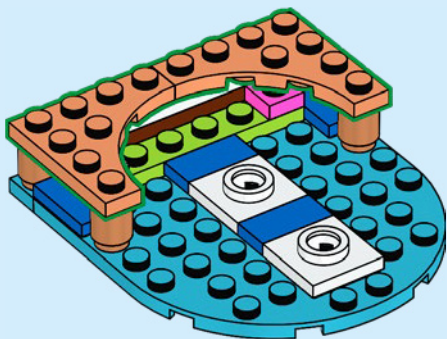

11

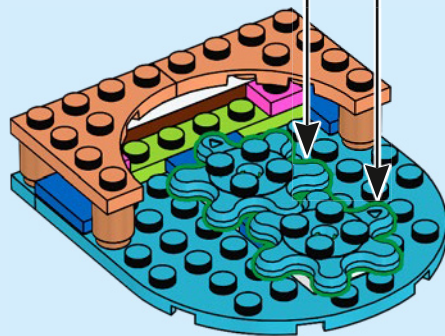



1x

12

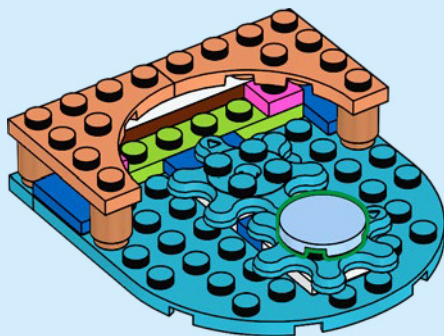

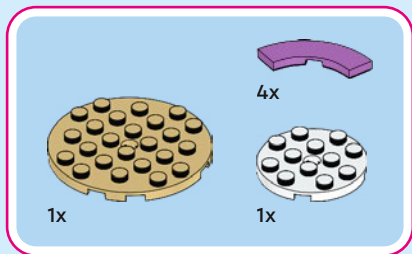

13

1

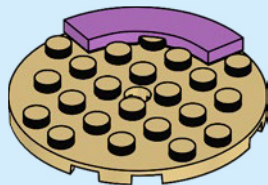

2

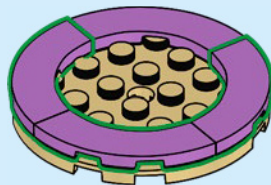

3

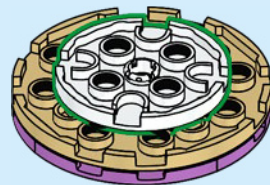
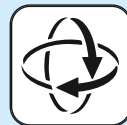

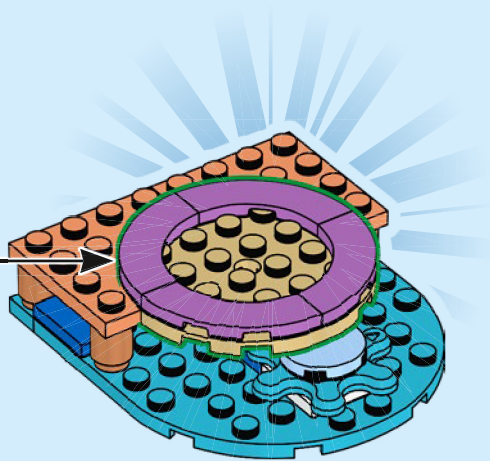



4x

14

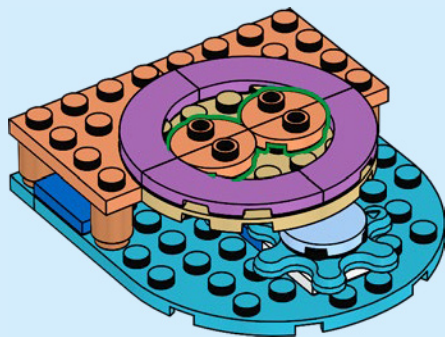

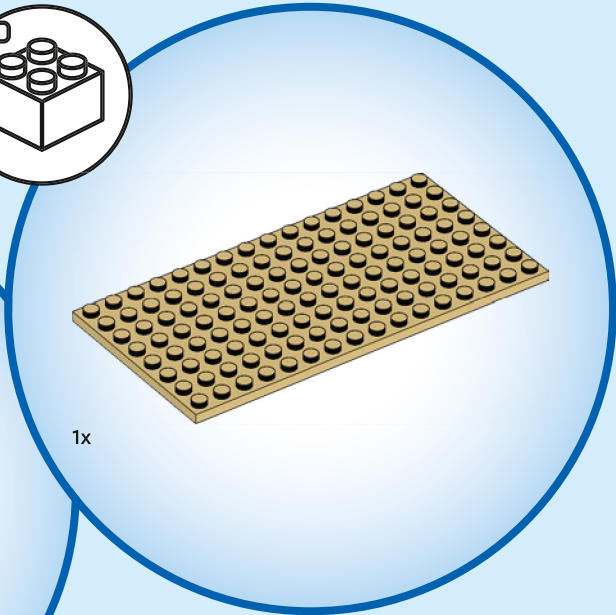
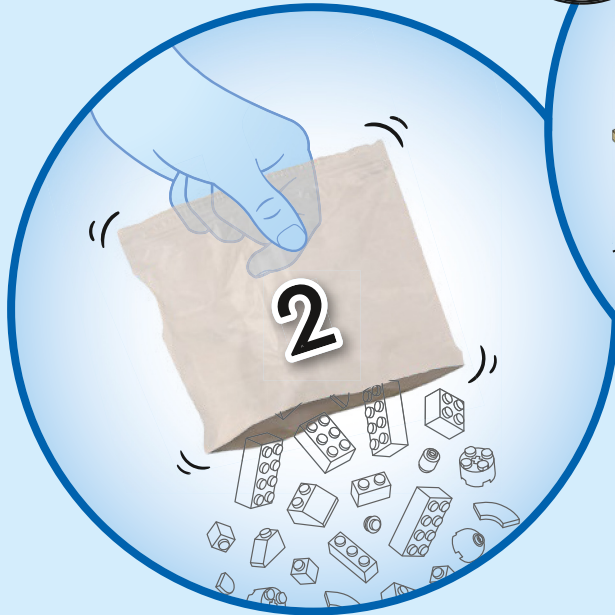
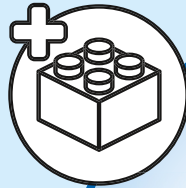

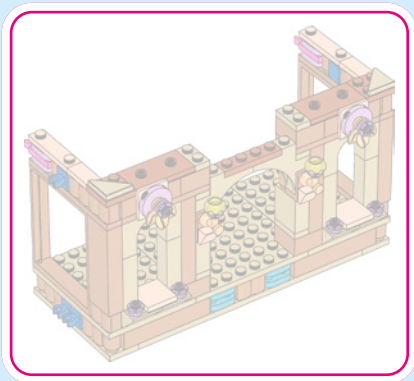

15

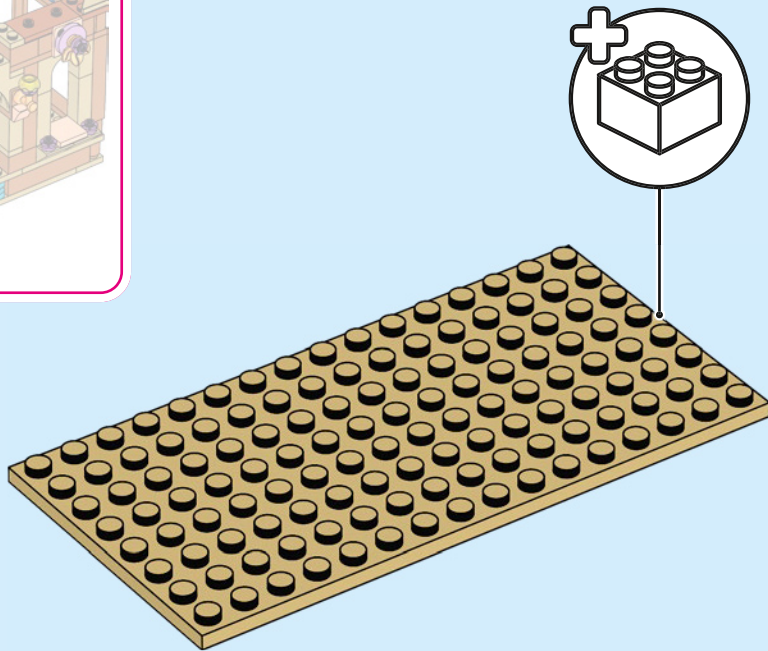

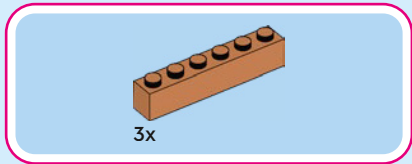

16

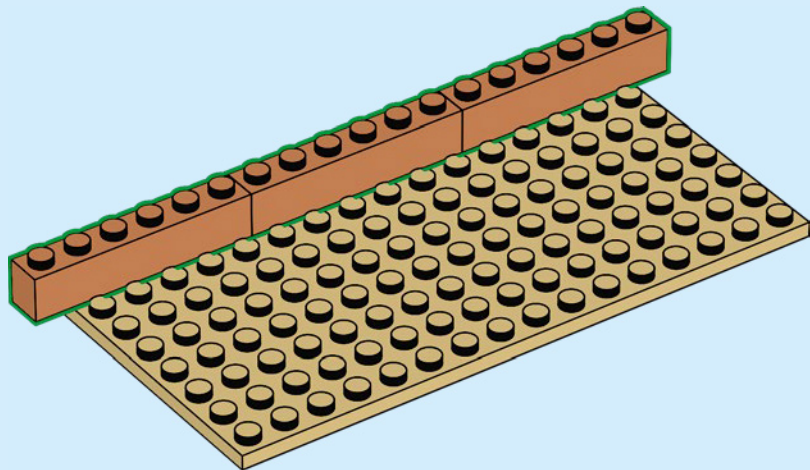

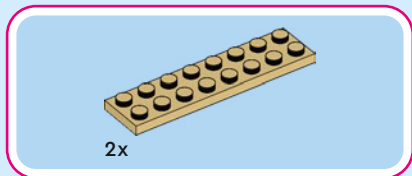

17

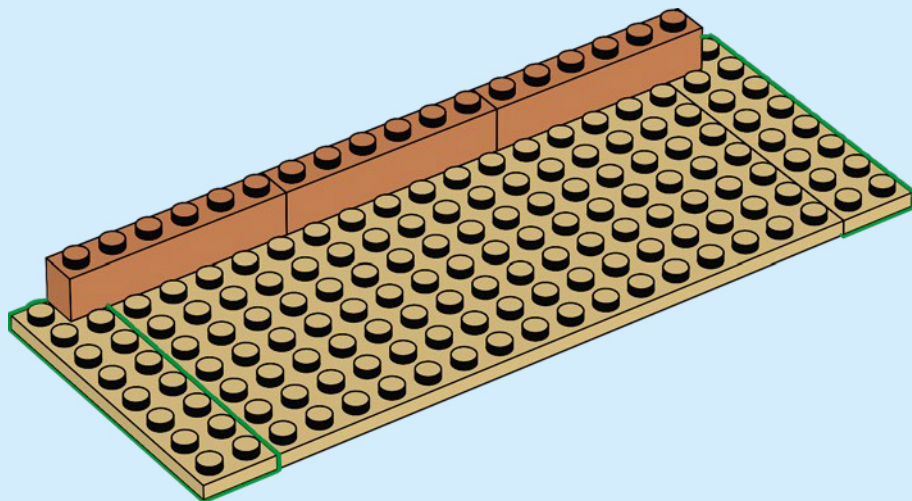



2x

18

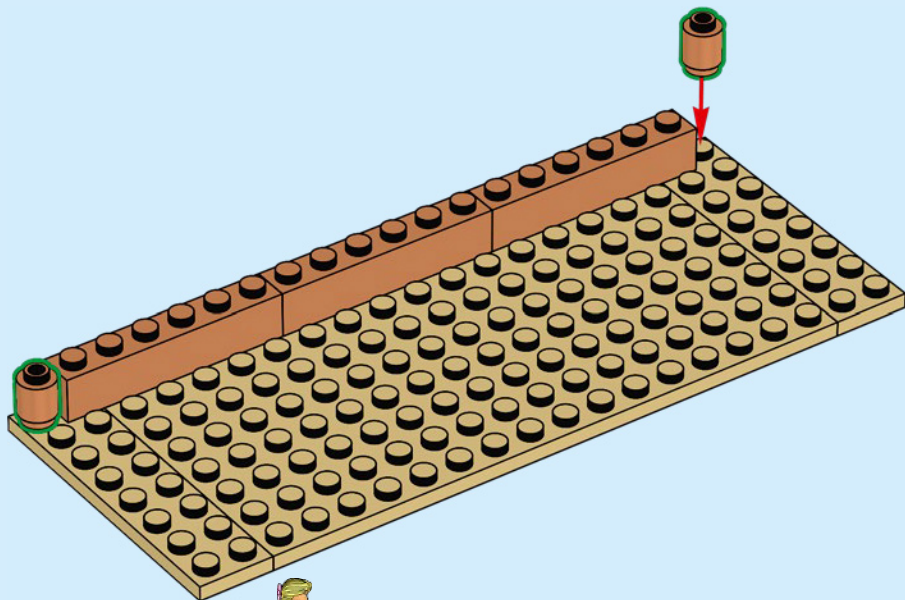



2x

19

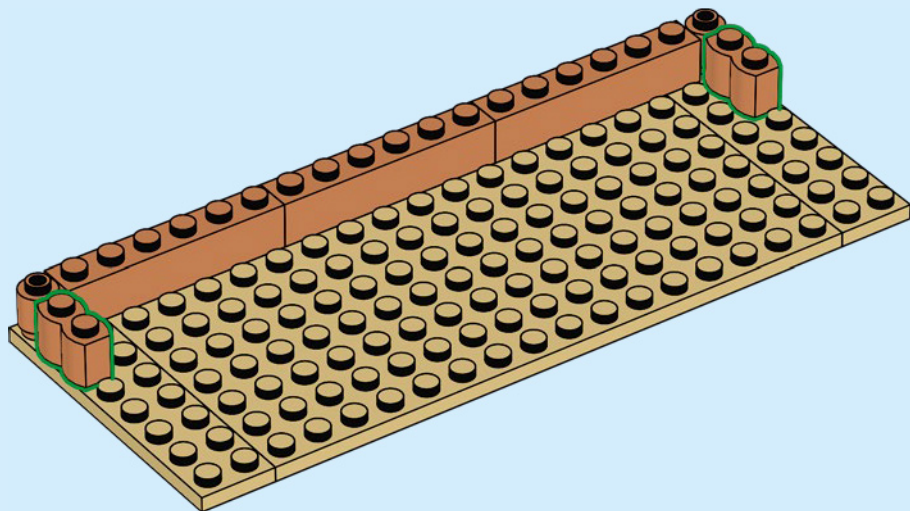



4x

20

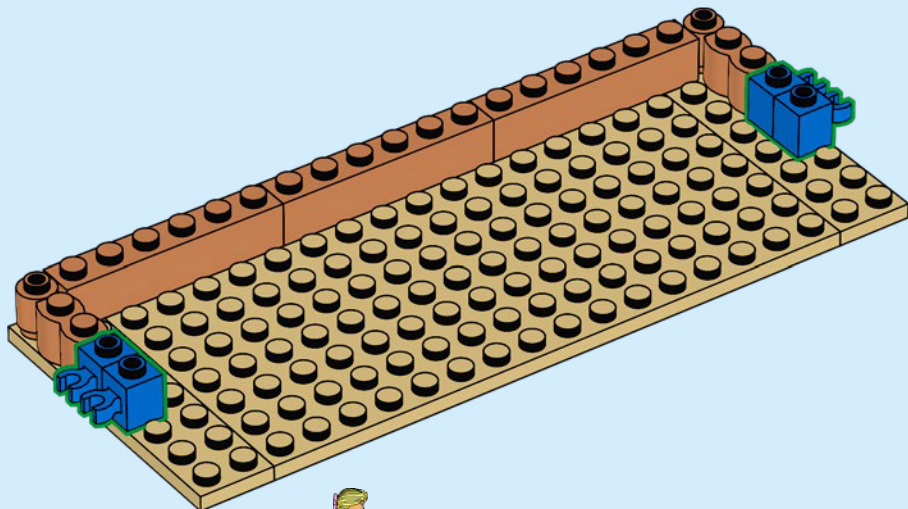



2x



2x

21

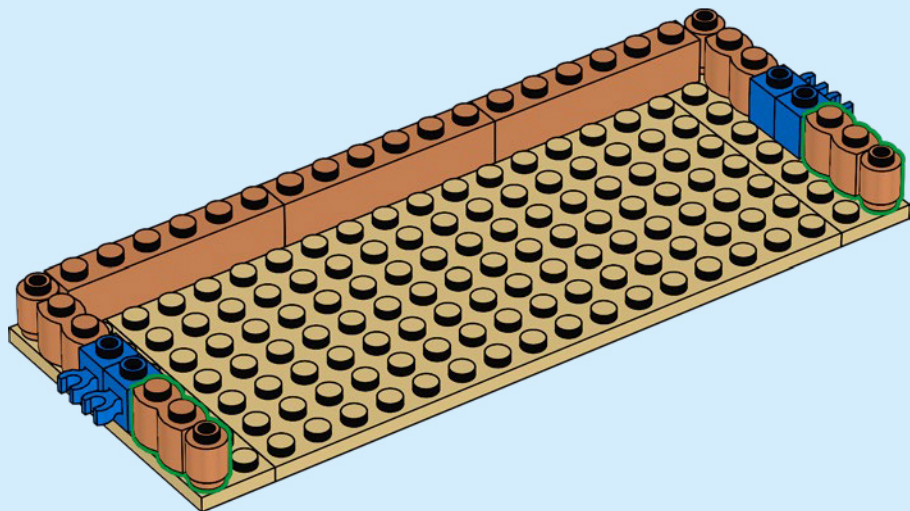

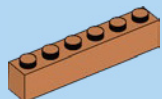

2x

22

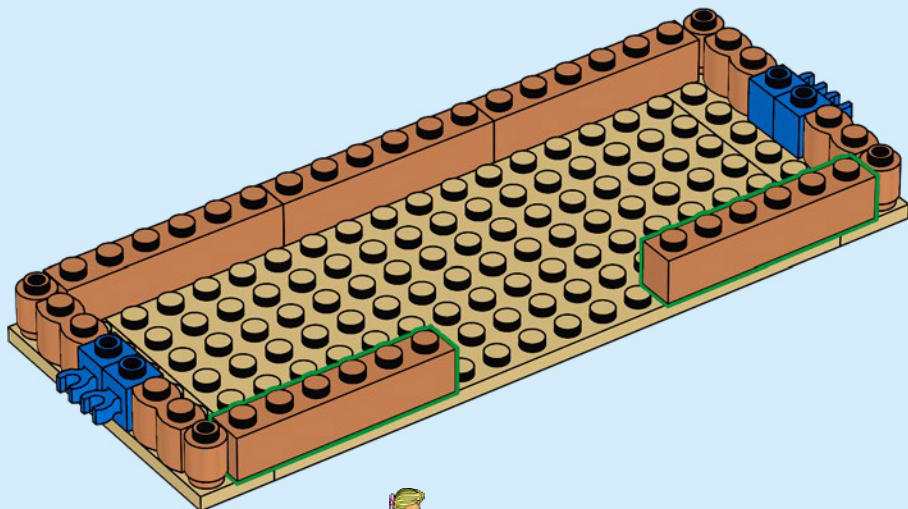



1x



2x

23

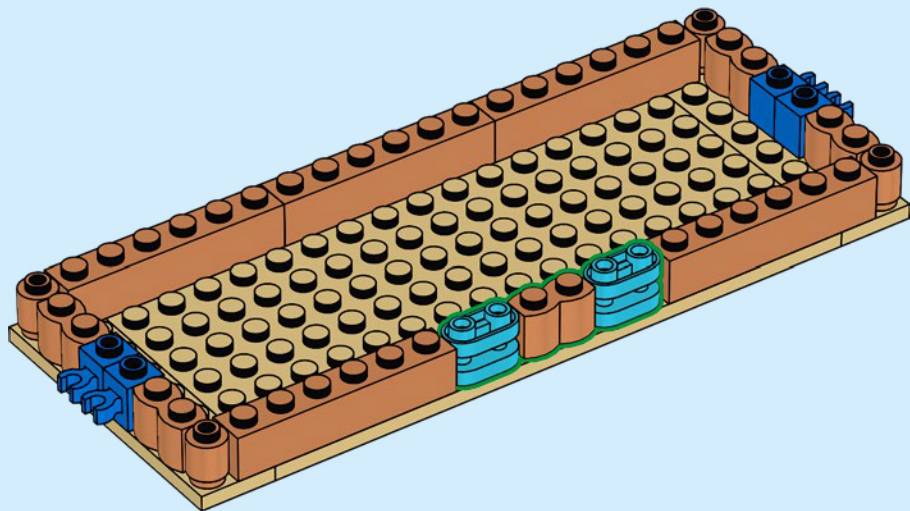

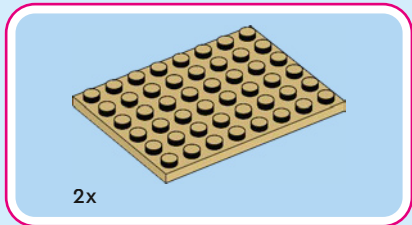

24

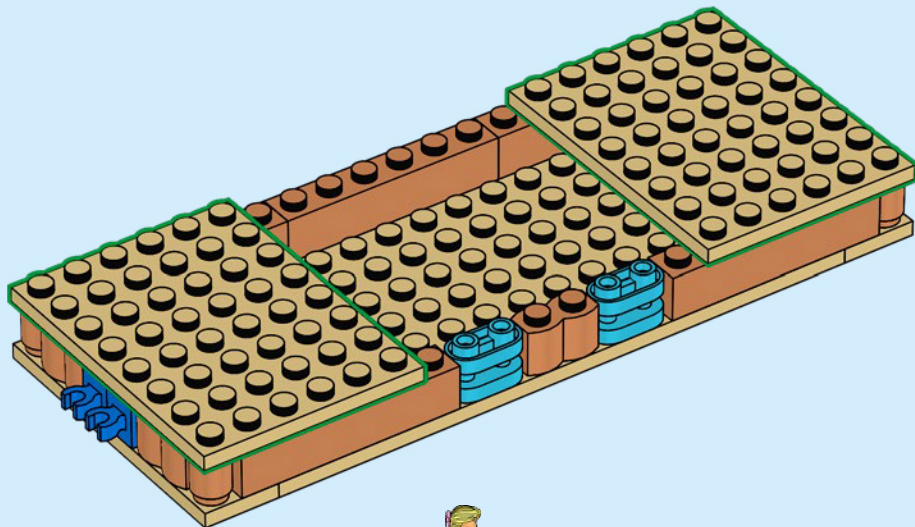

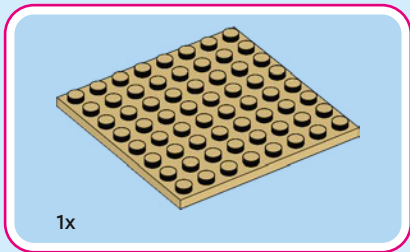

25

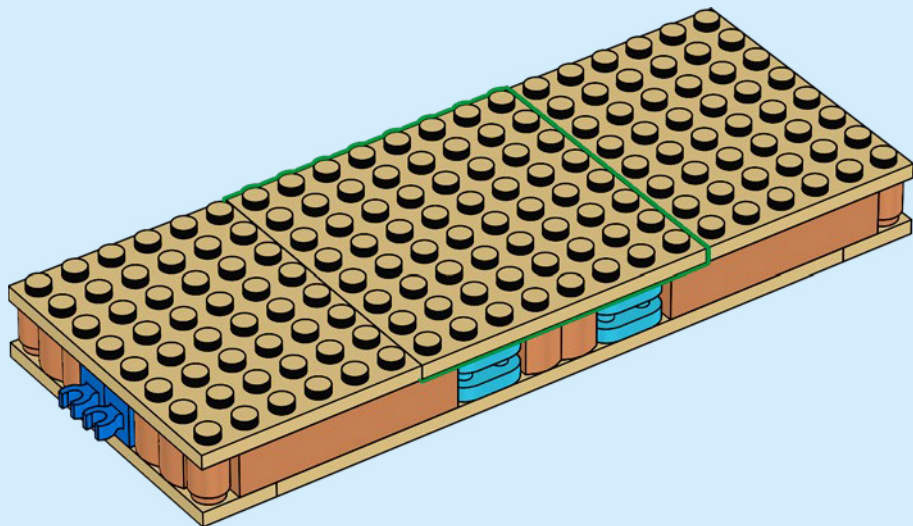



2x

26

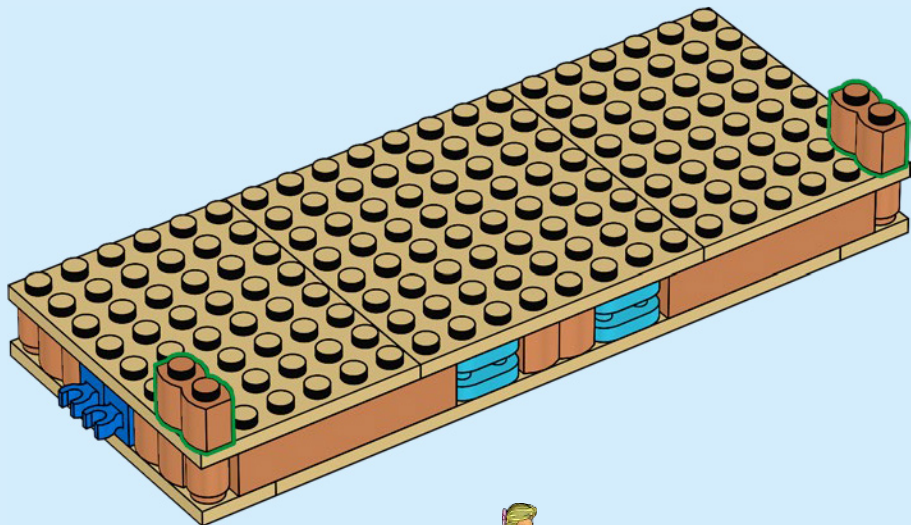



4x

27

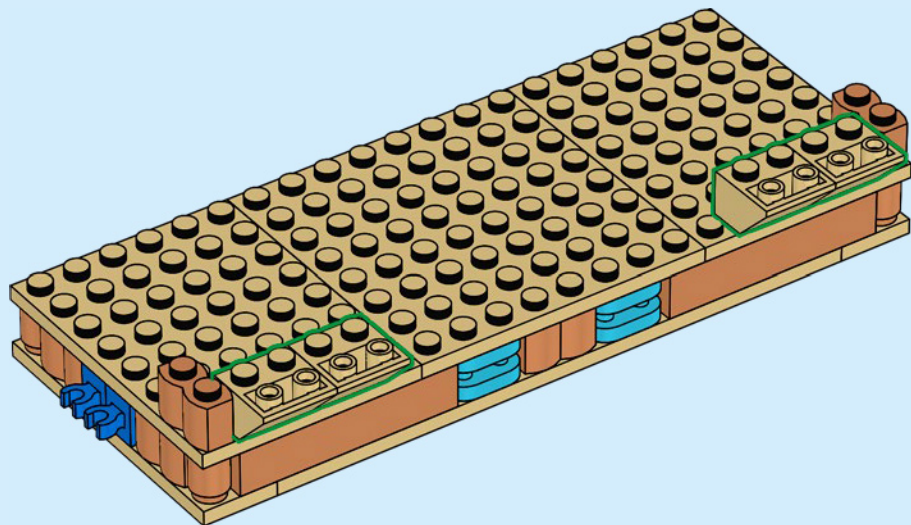



2x

28

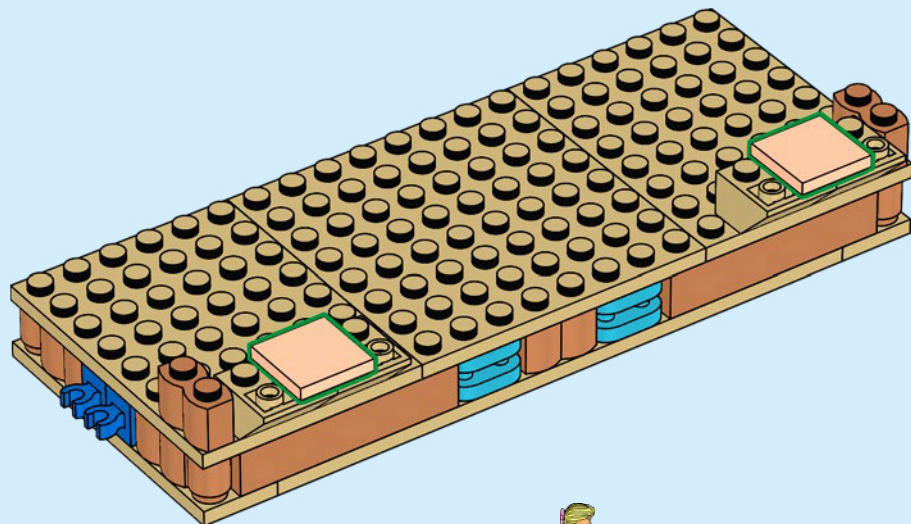

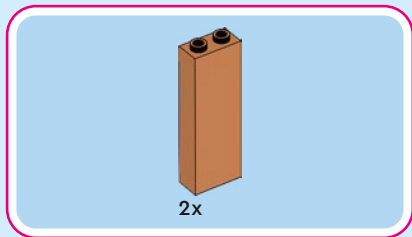

29

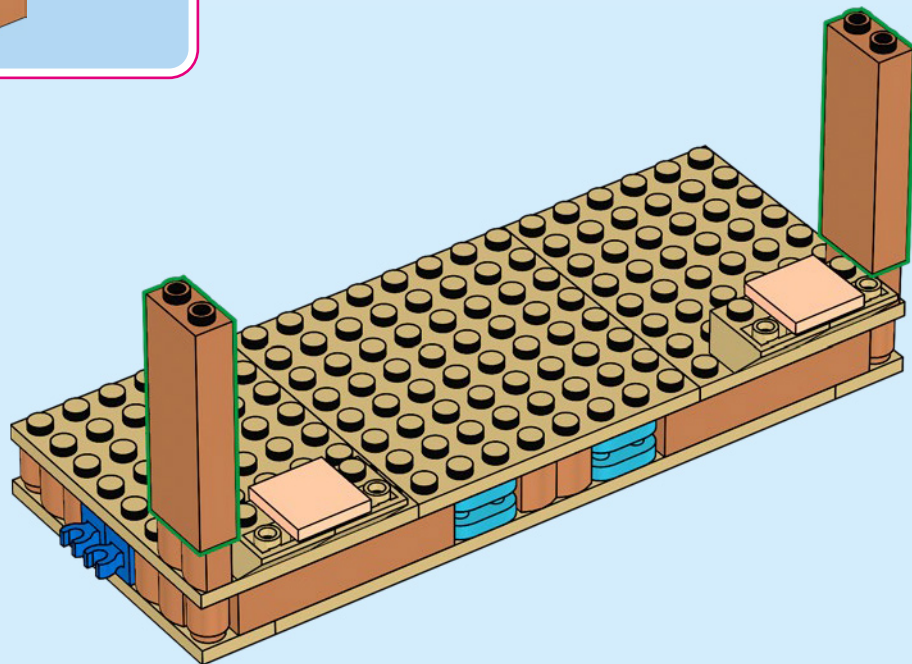

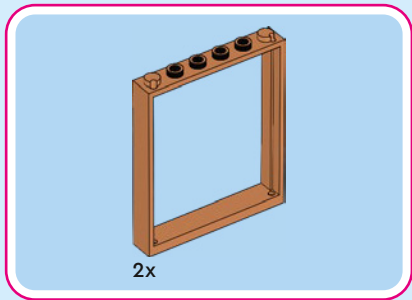

2x

30

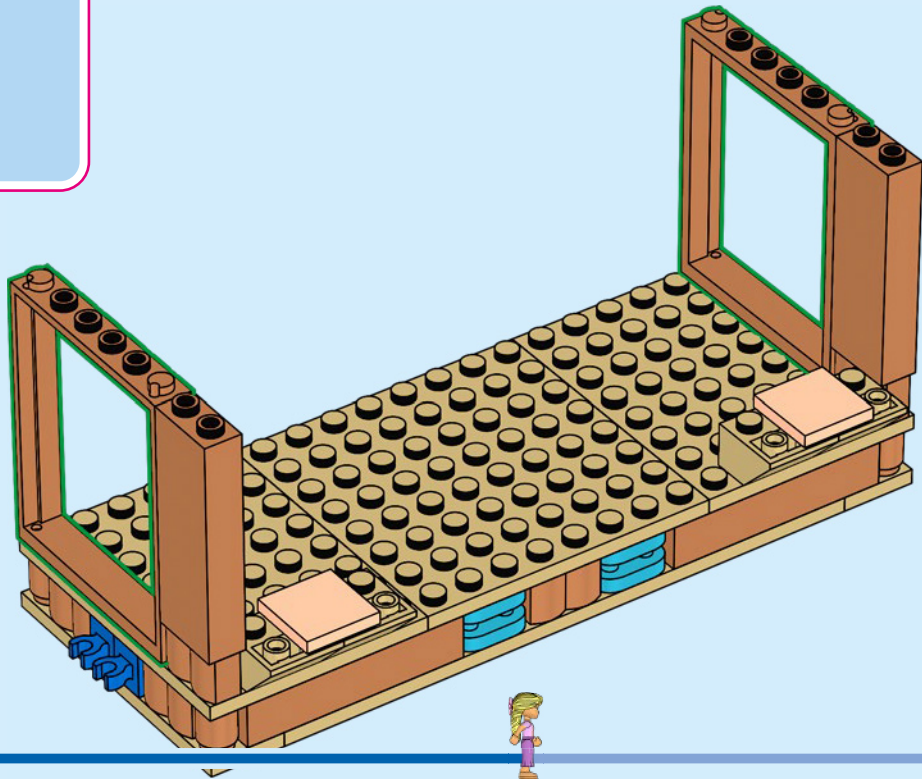

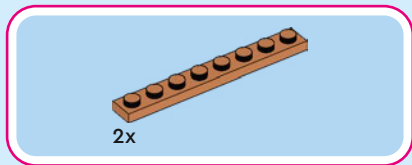

31

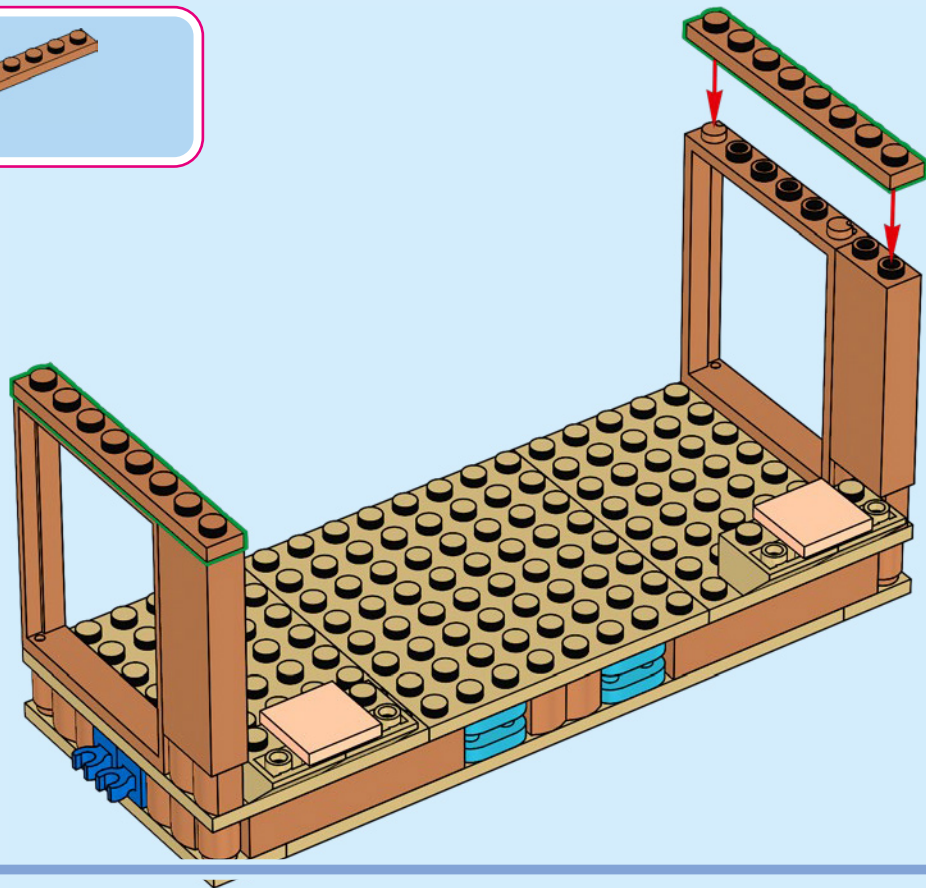



4x

32

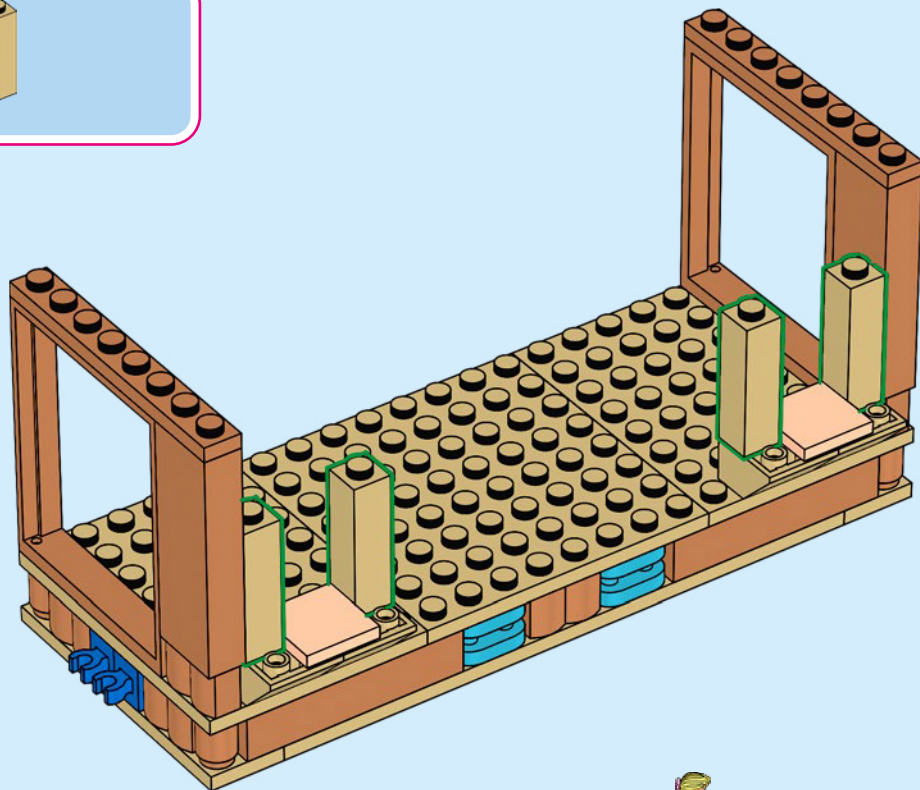

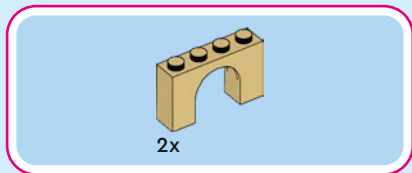

33

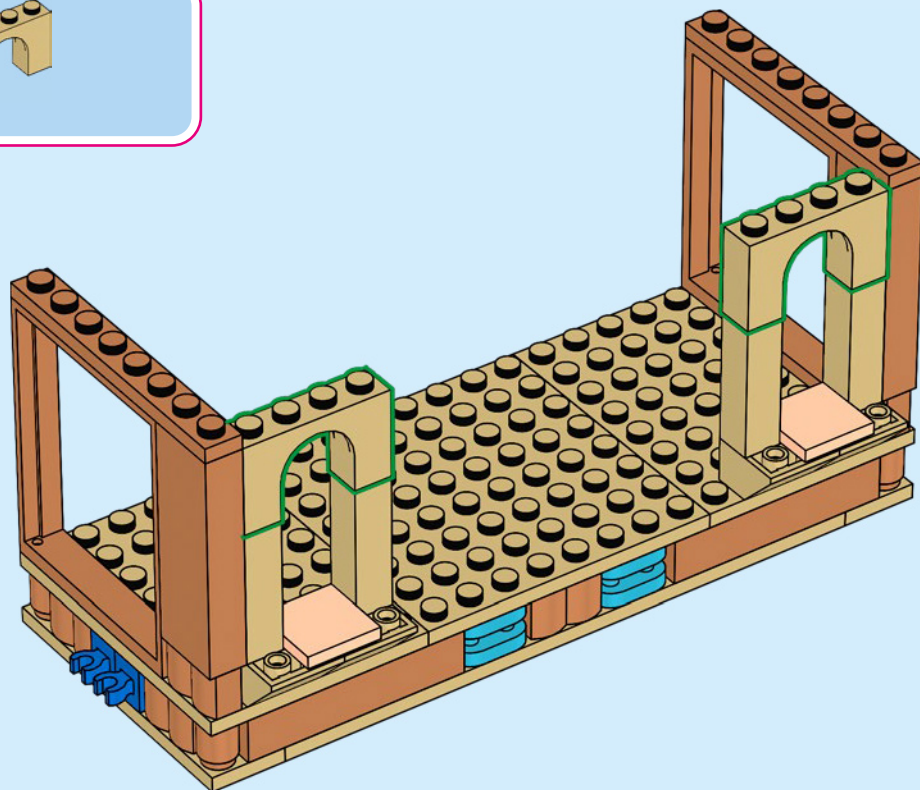

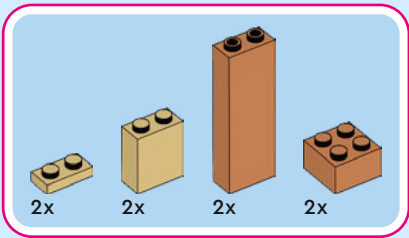
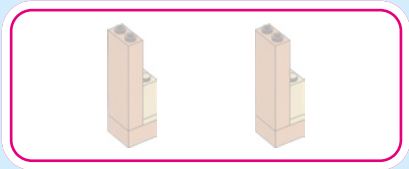

34

1

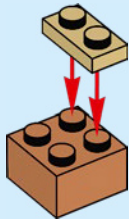

2

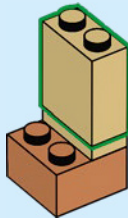

3

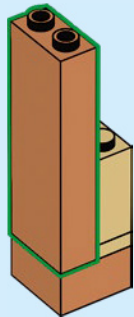

2x



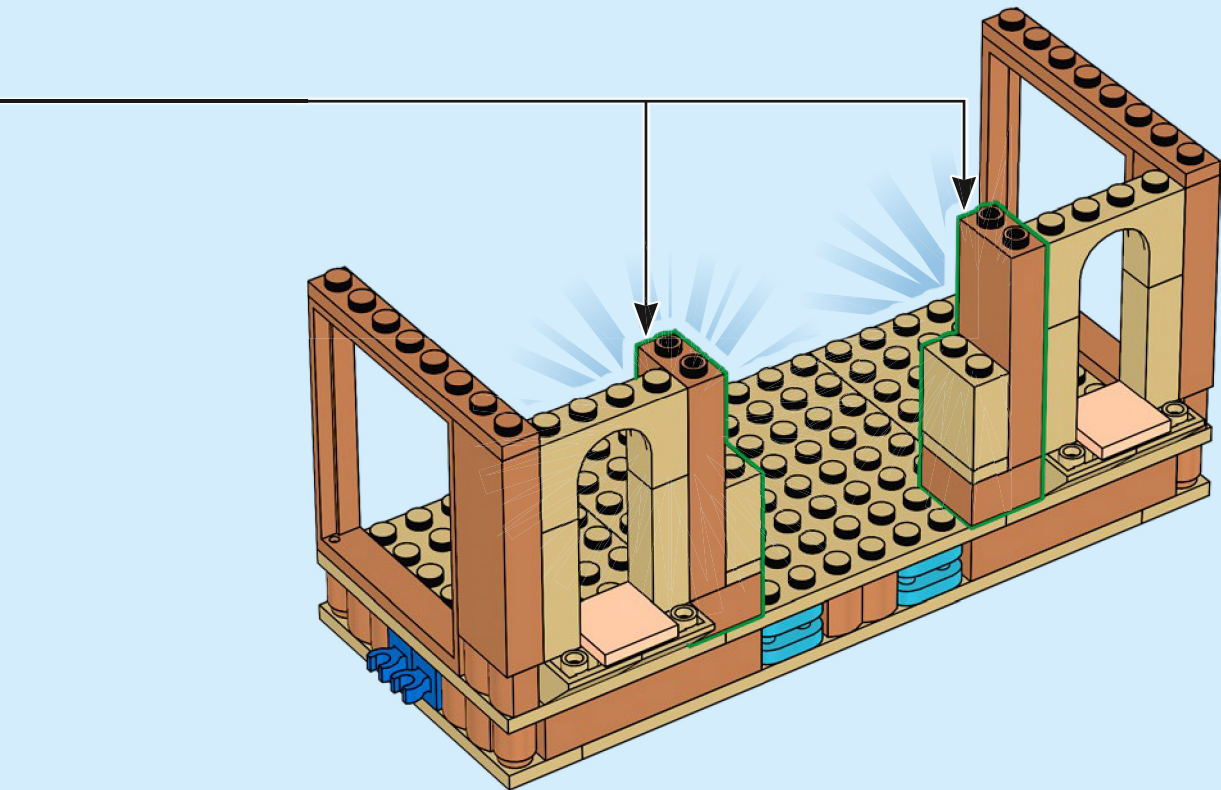



2x

35

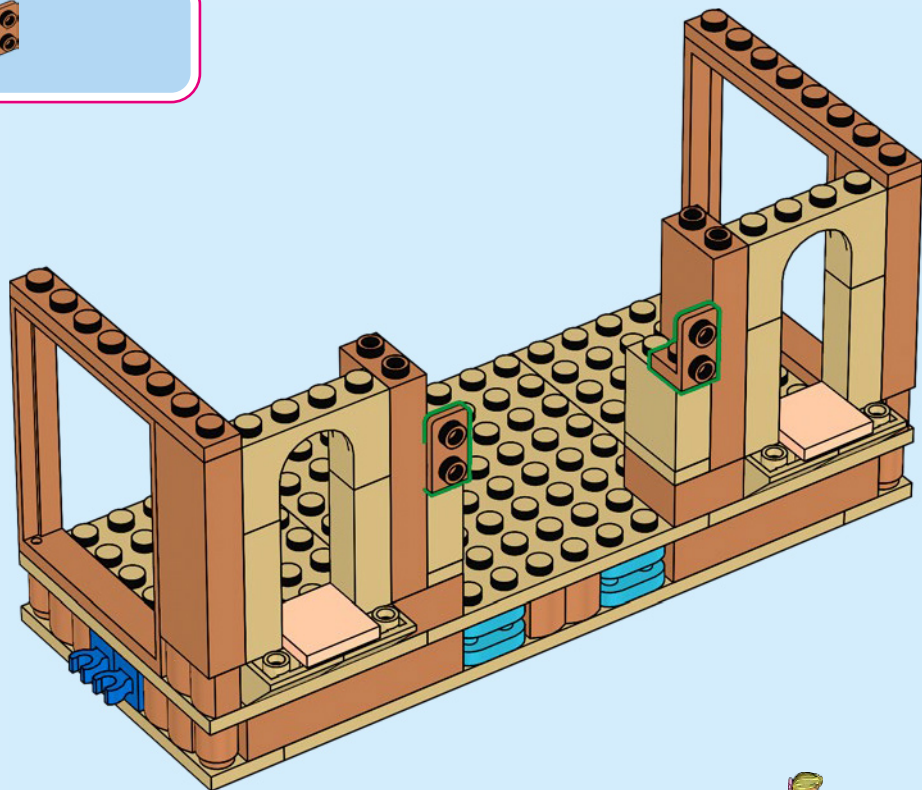

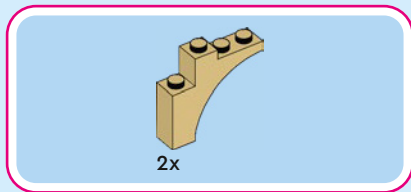

36

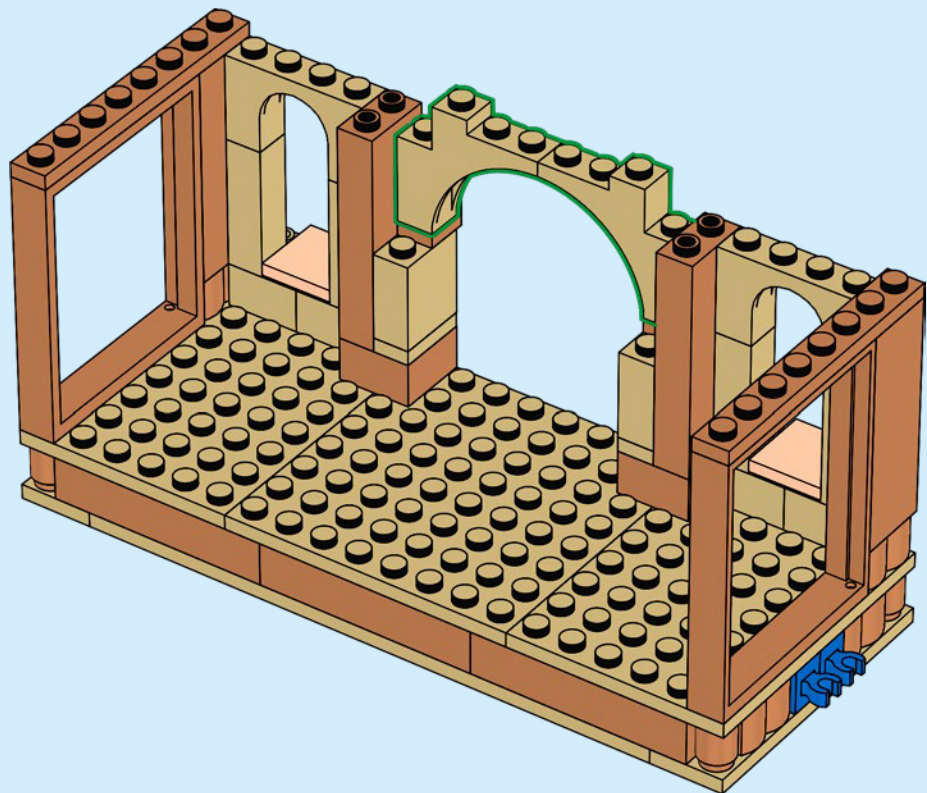



1x

37

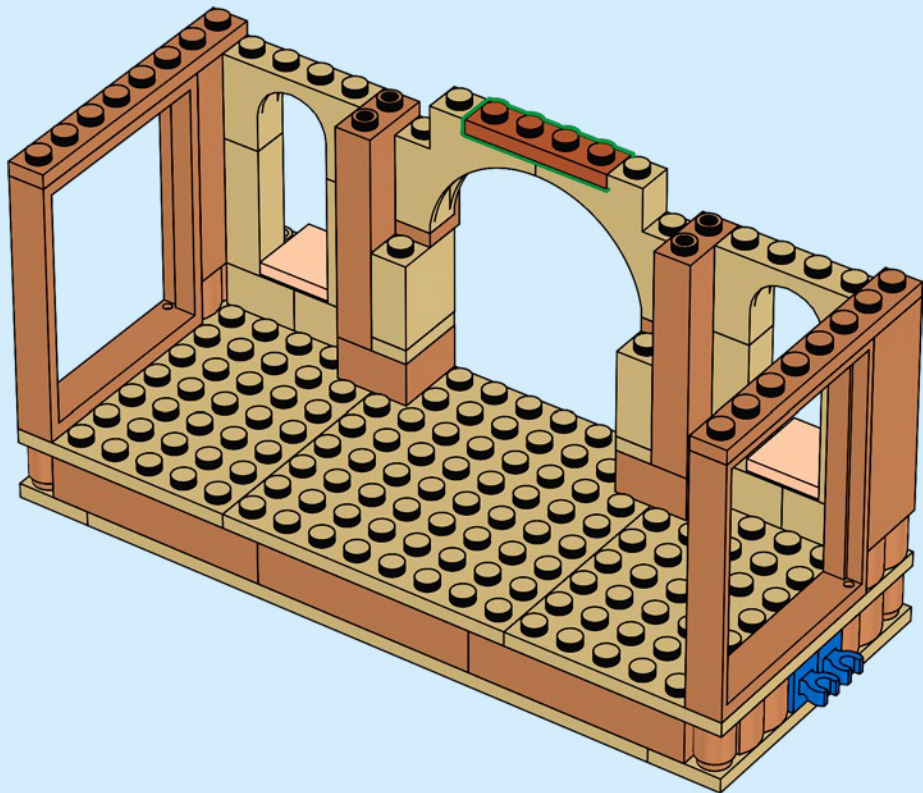



2x



4x

38

1



2



2x

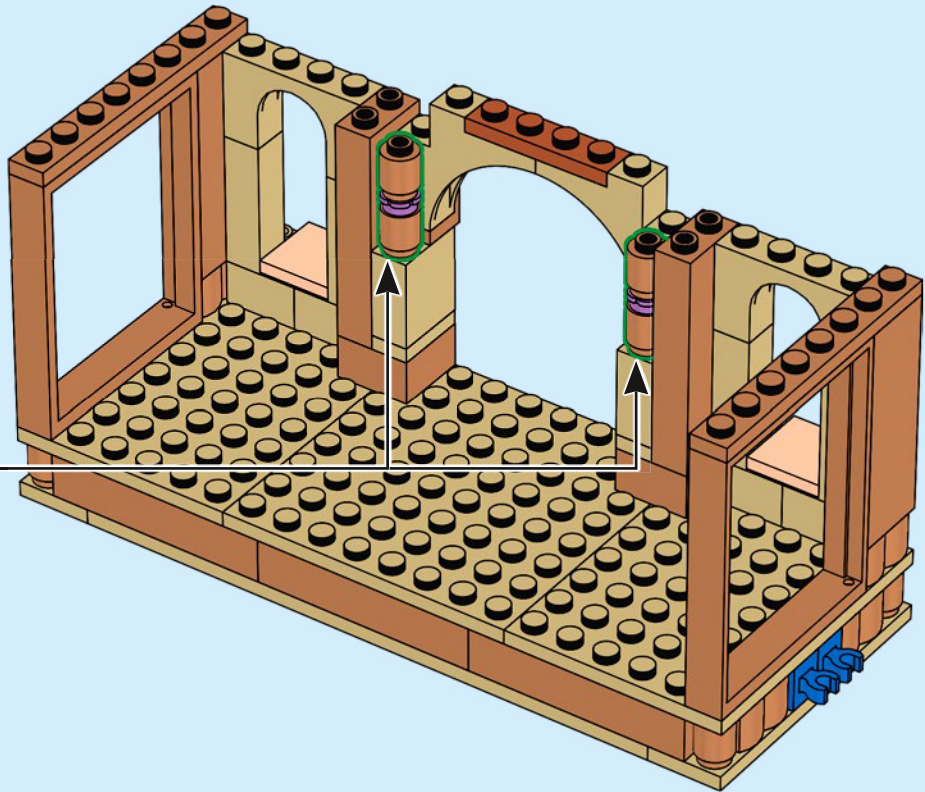



2x

39



2x

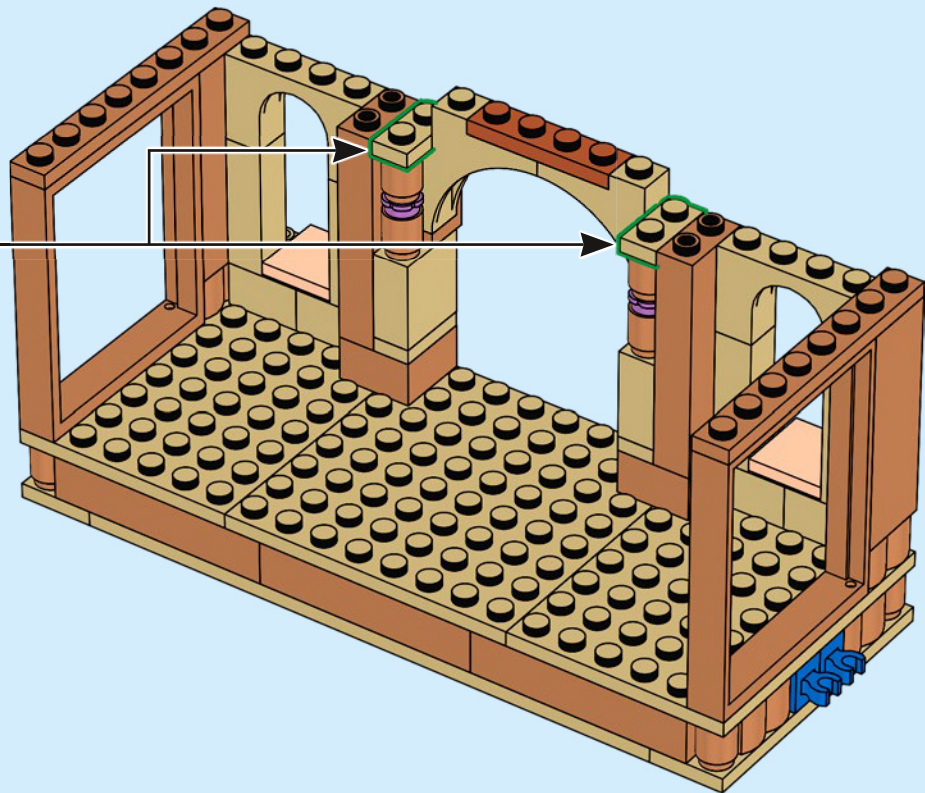



2x

40

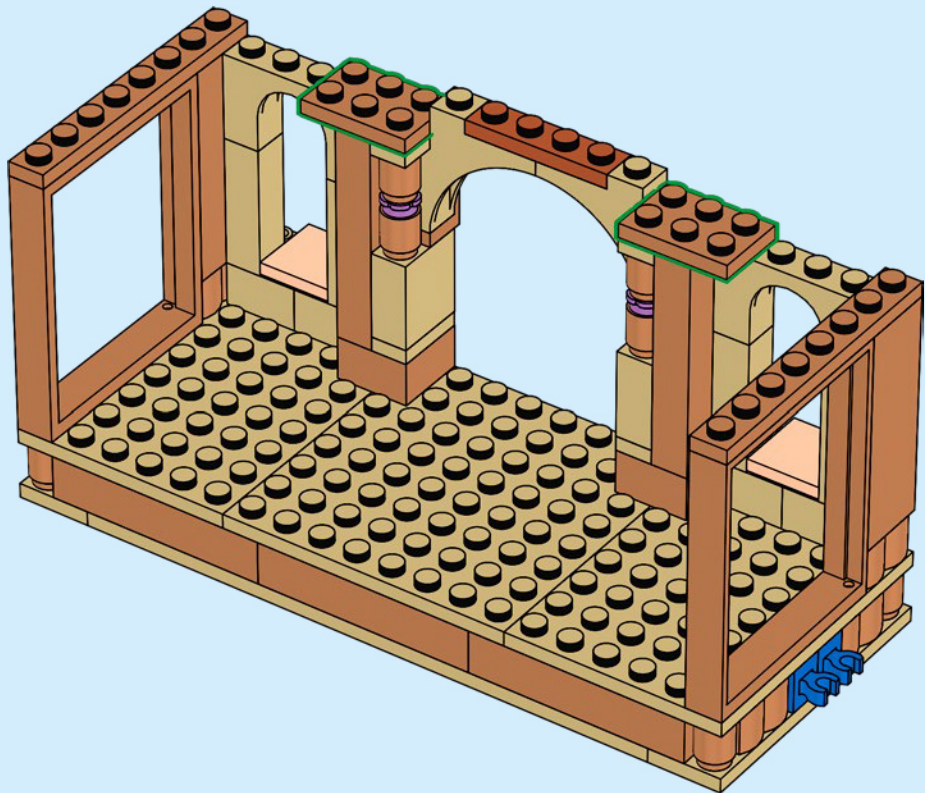

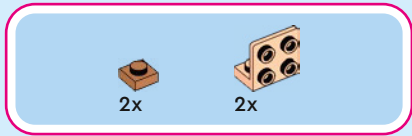

41

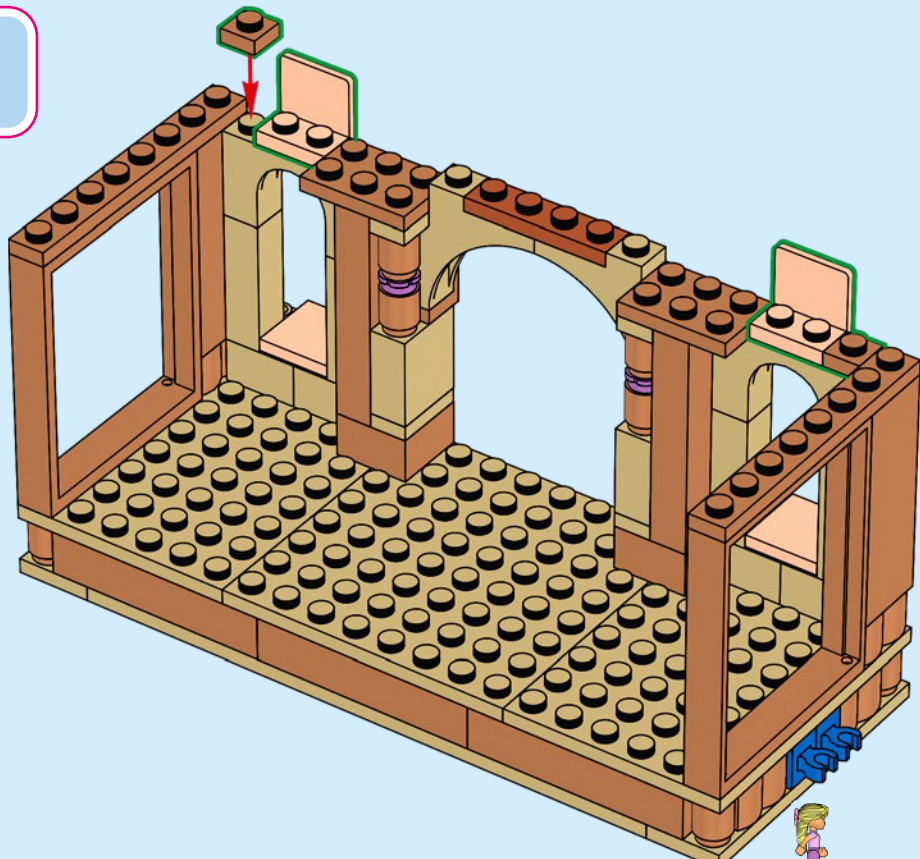



2x

42

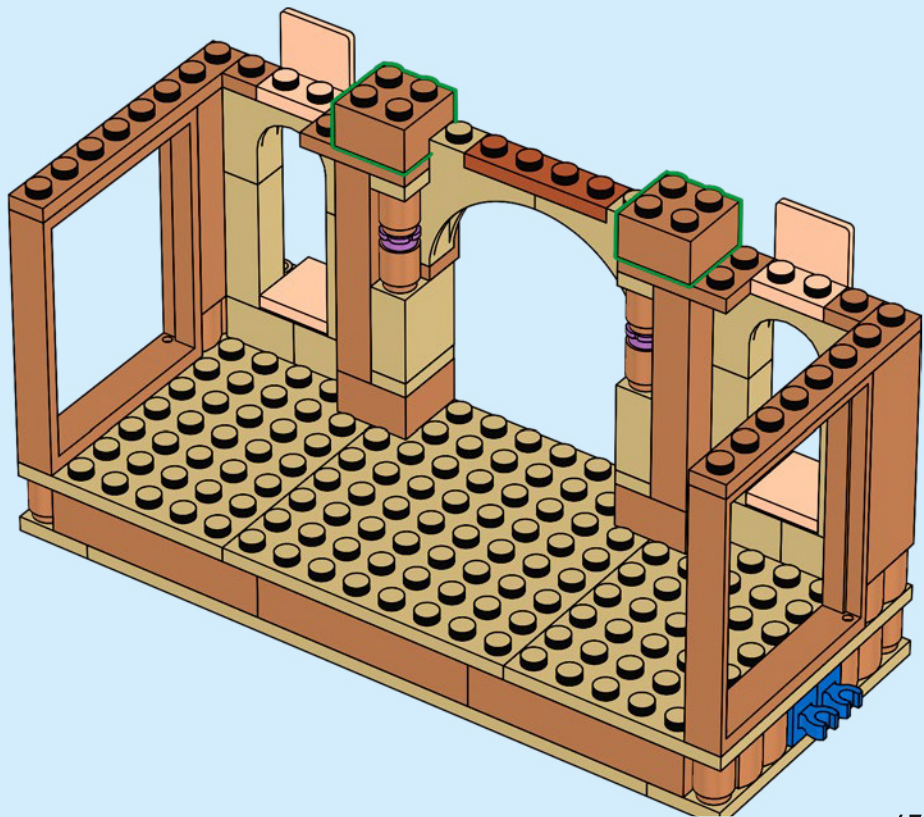



4x

43

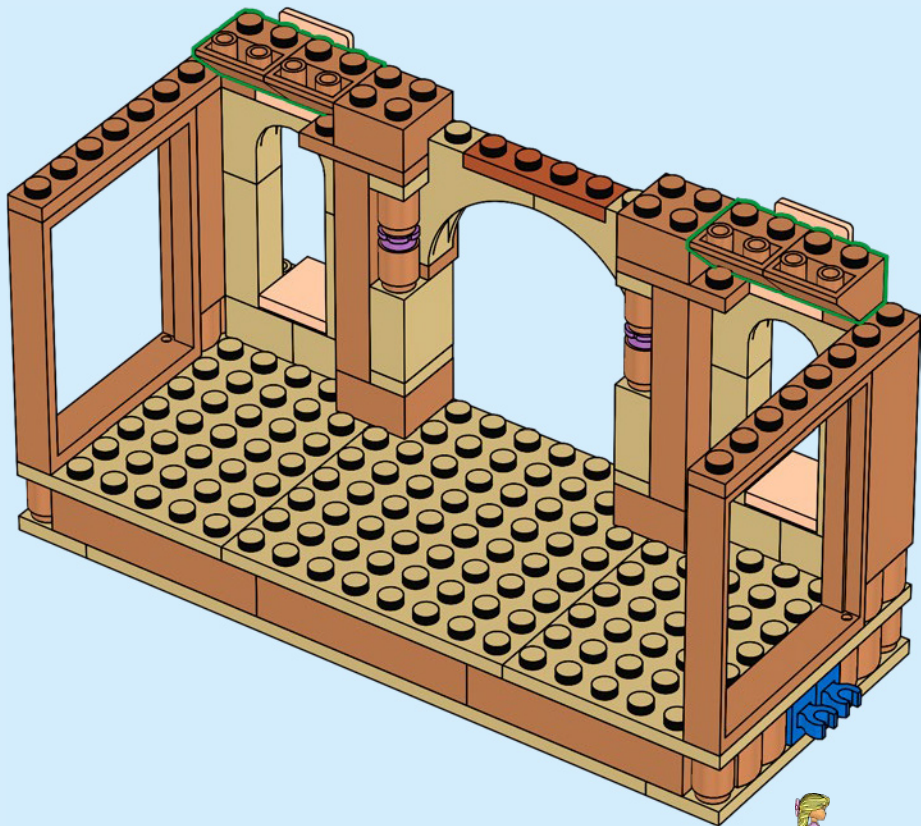



4x

44

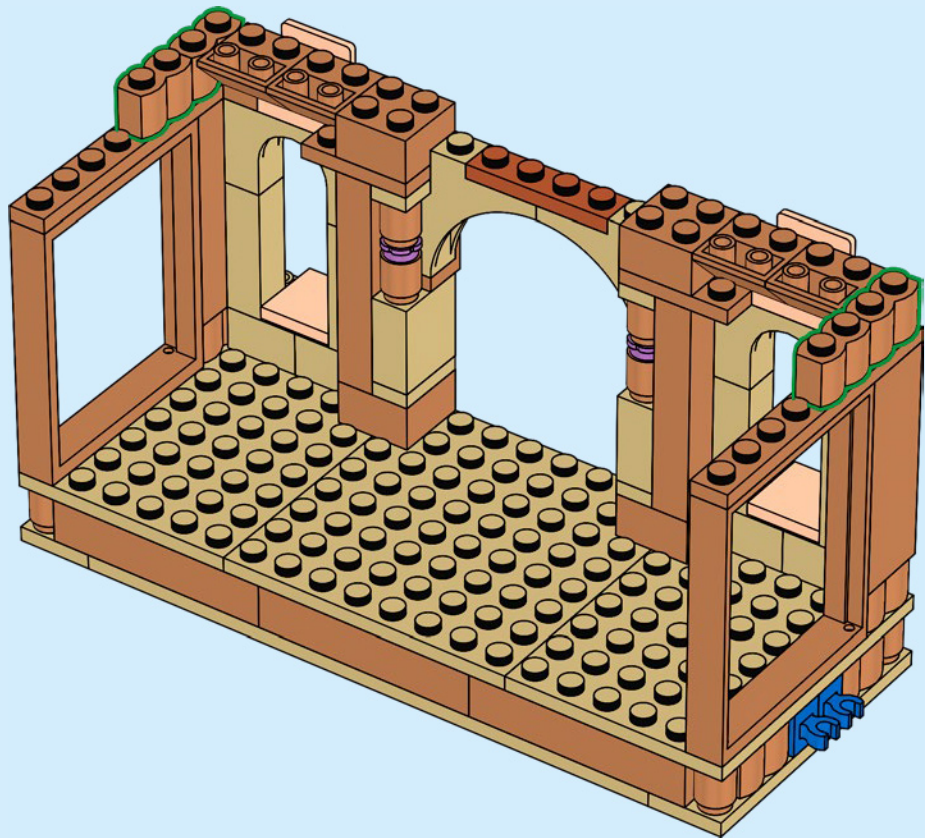



2x



2x

45

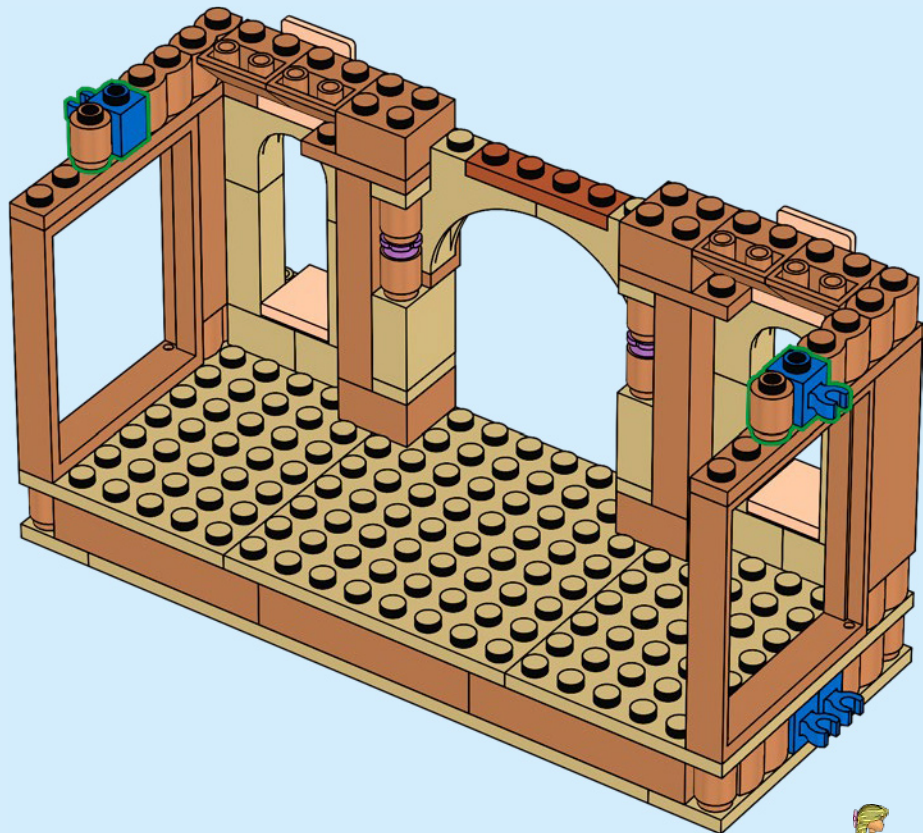



2x



4x

46

1



2



2x

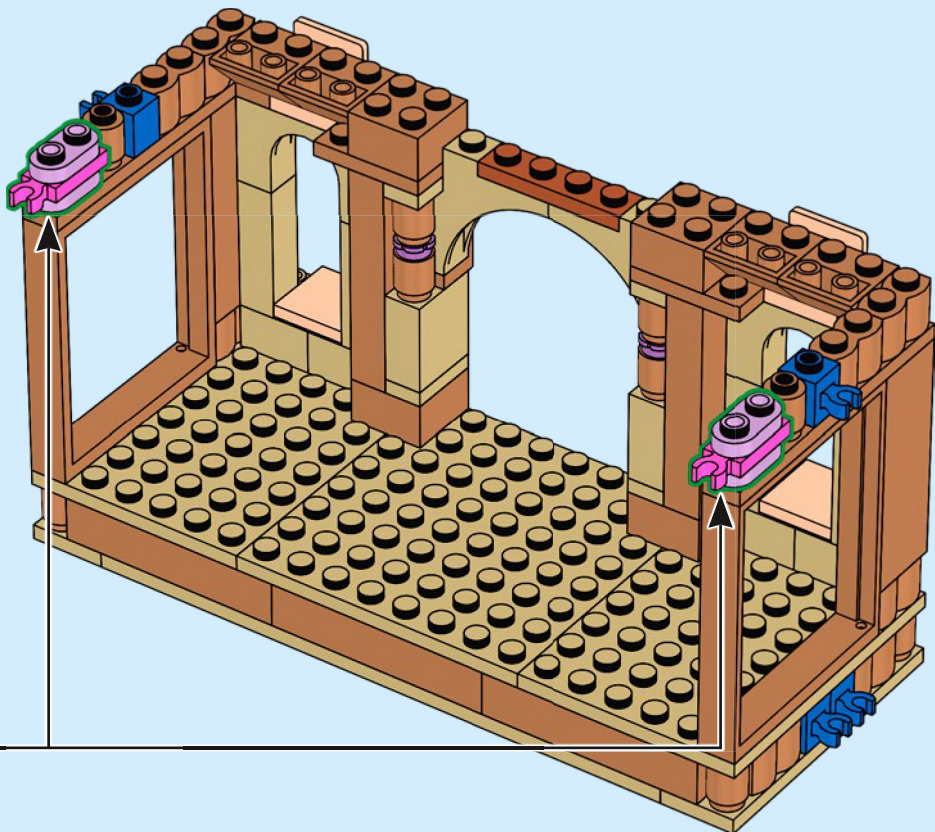



2x

47

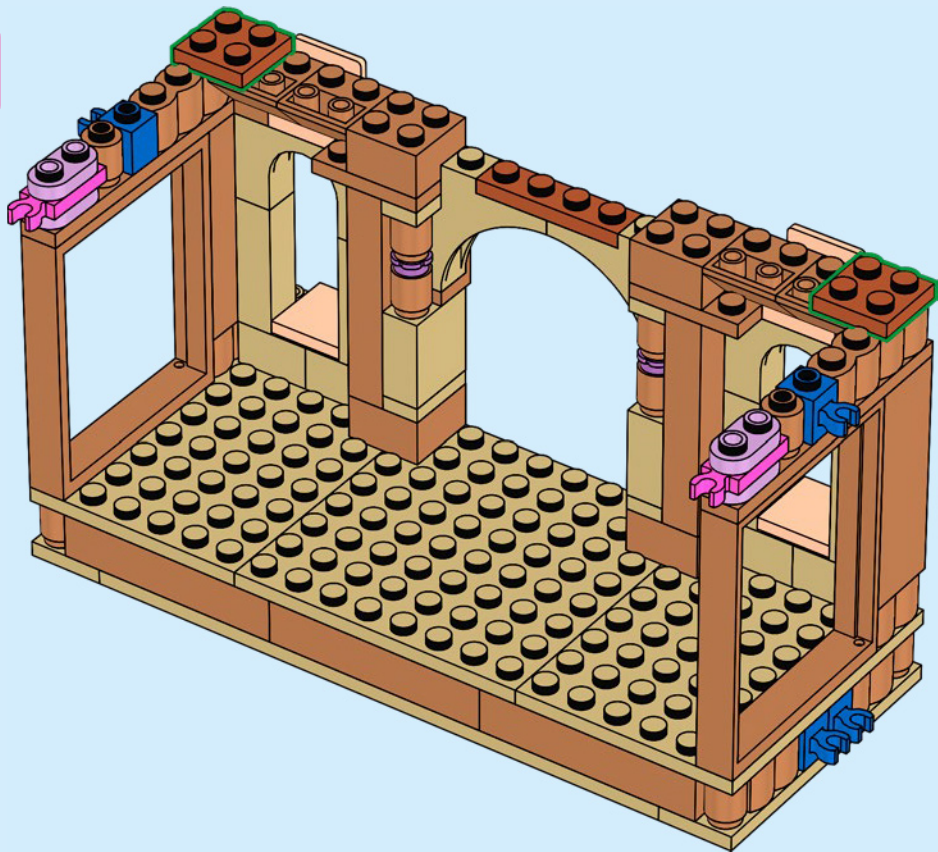

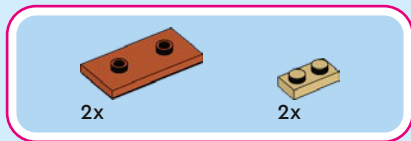

48

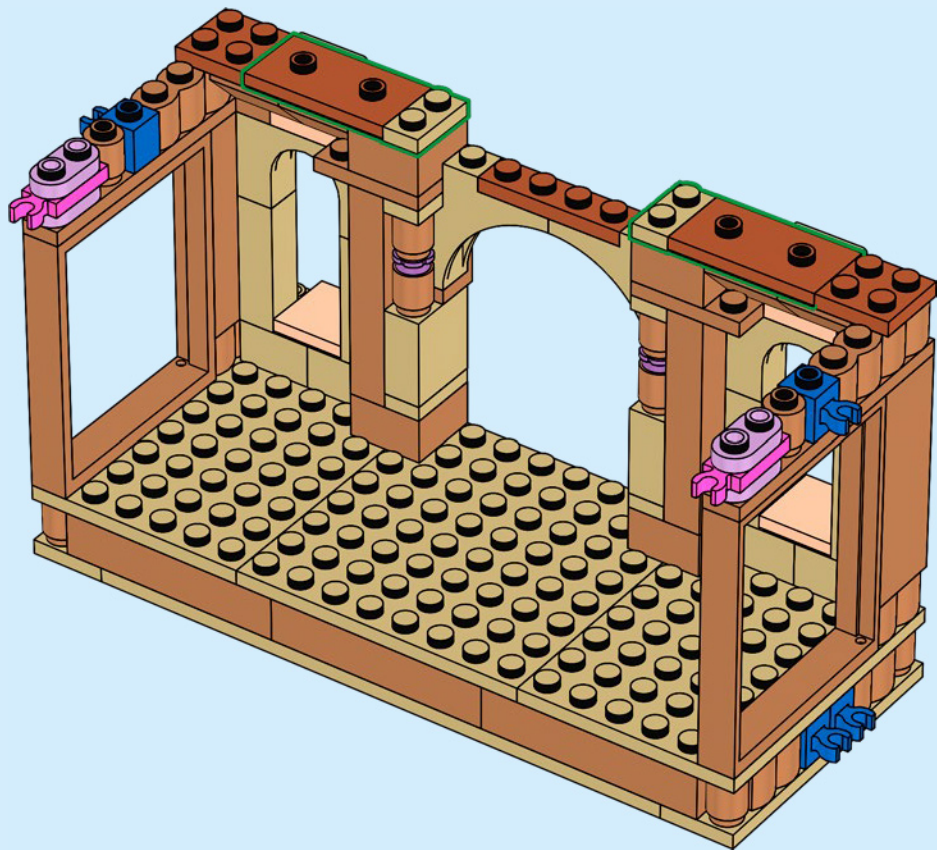

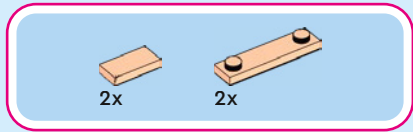

49

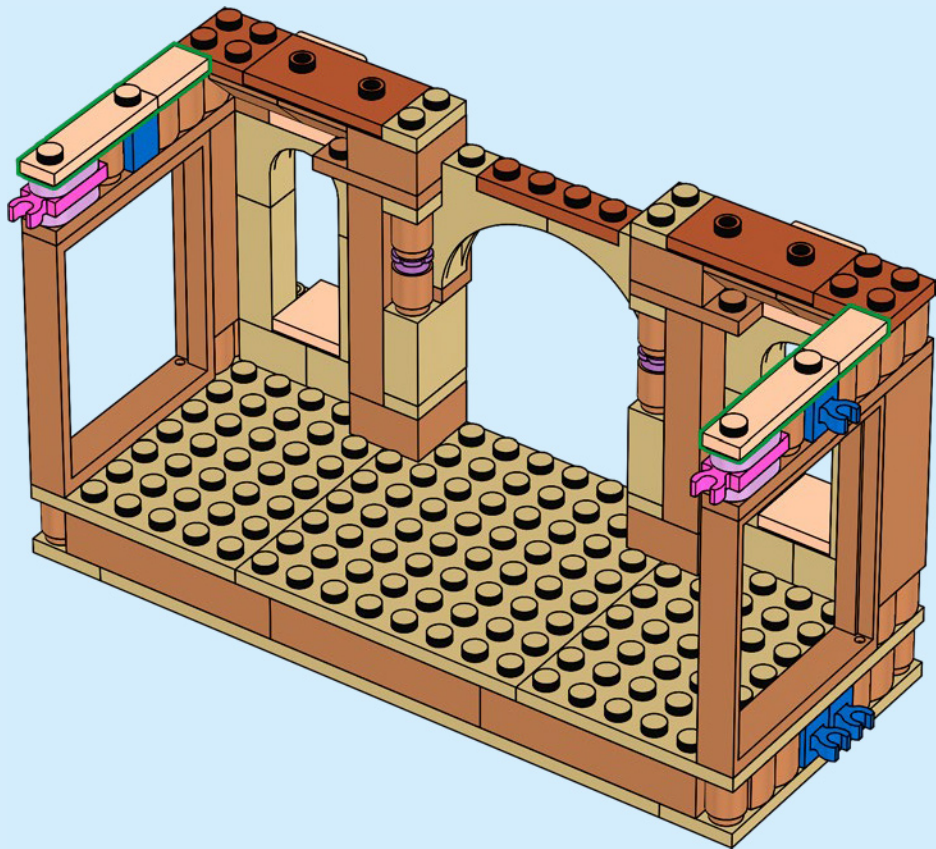



2x

50

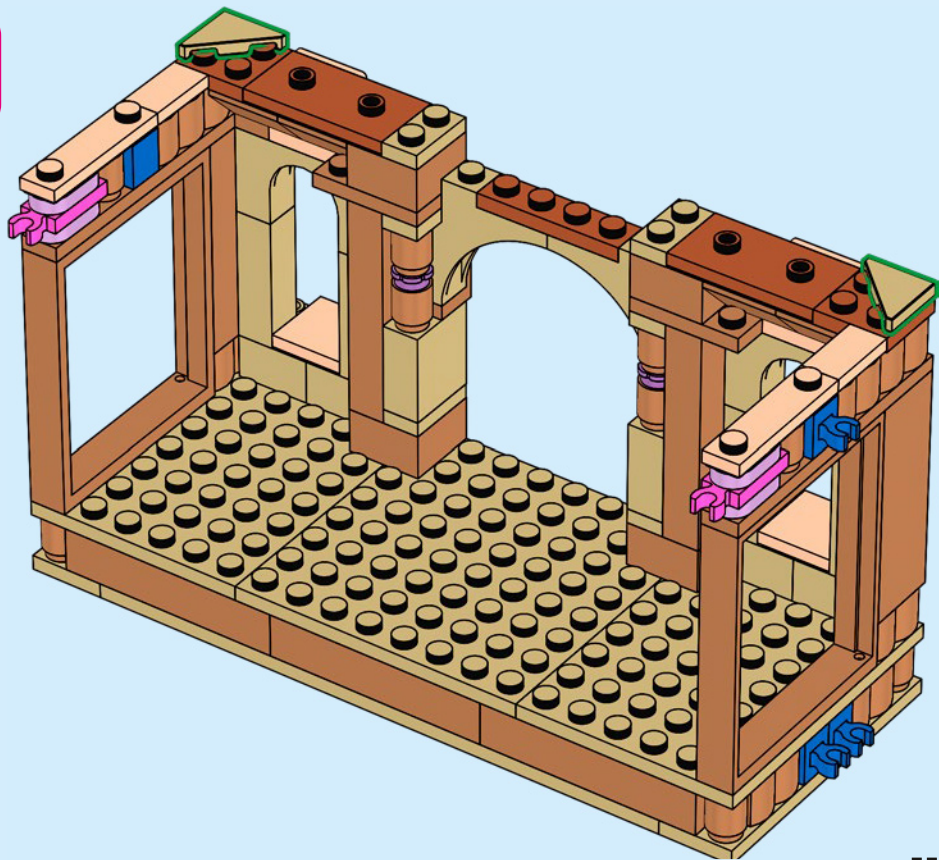



2x

51

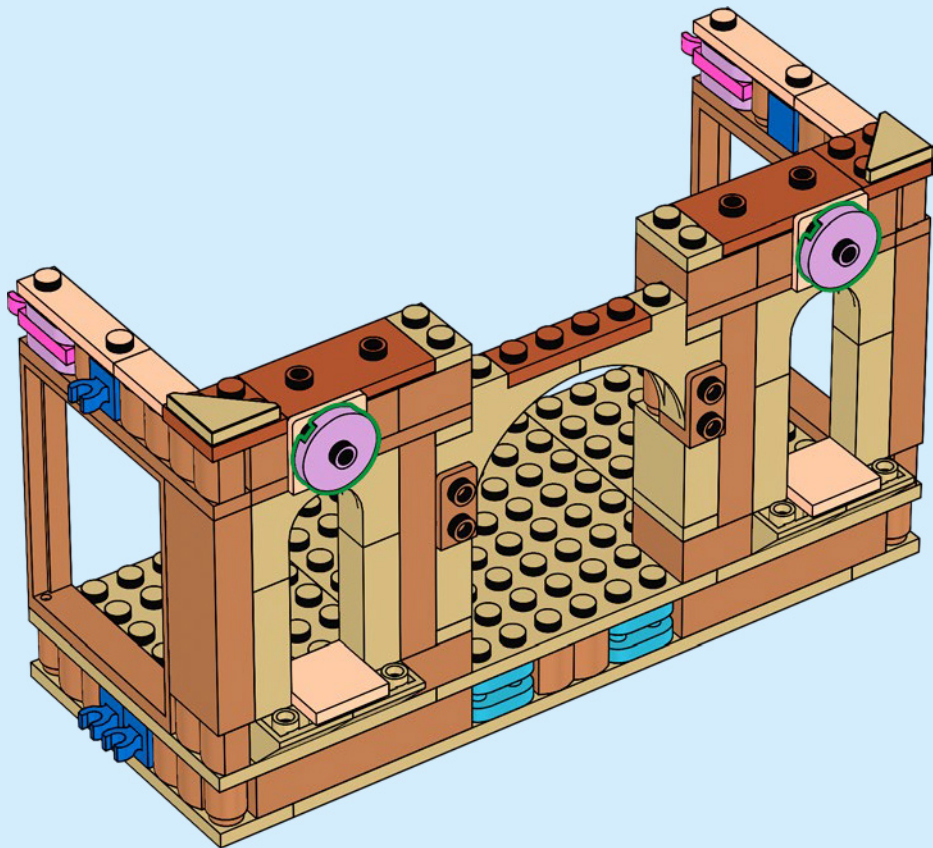
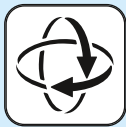



4x

52

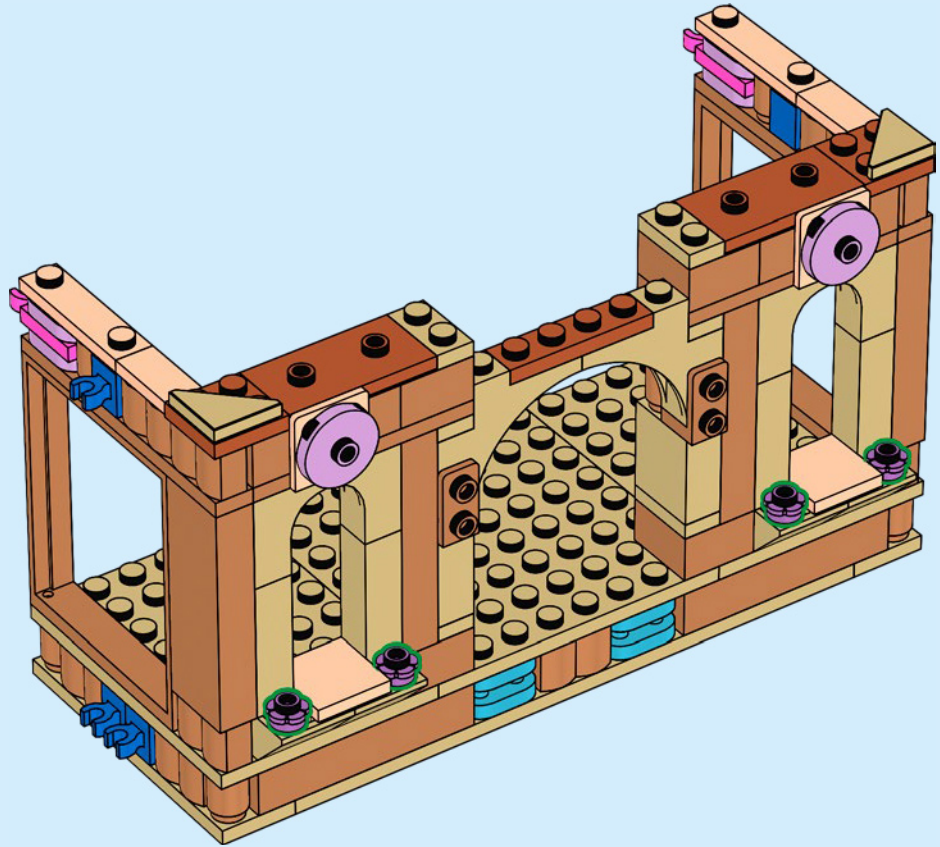



2x



2x

53

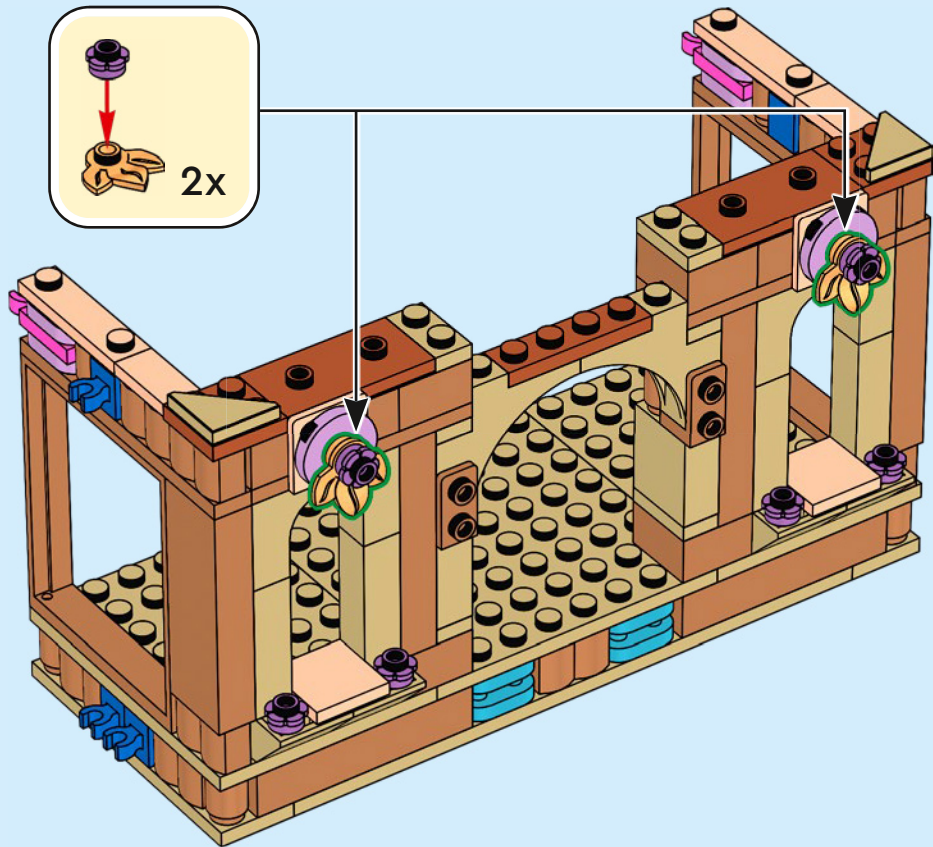
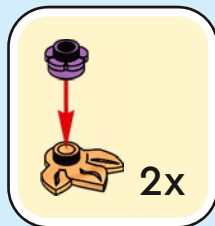



2x

54

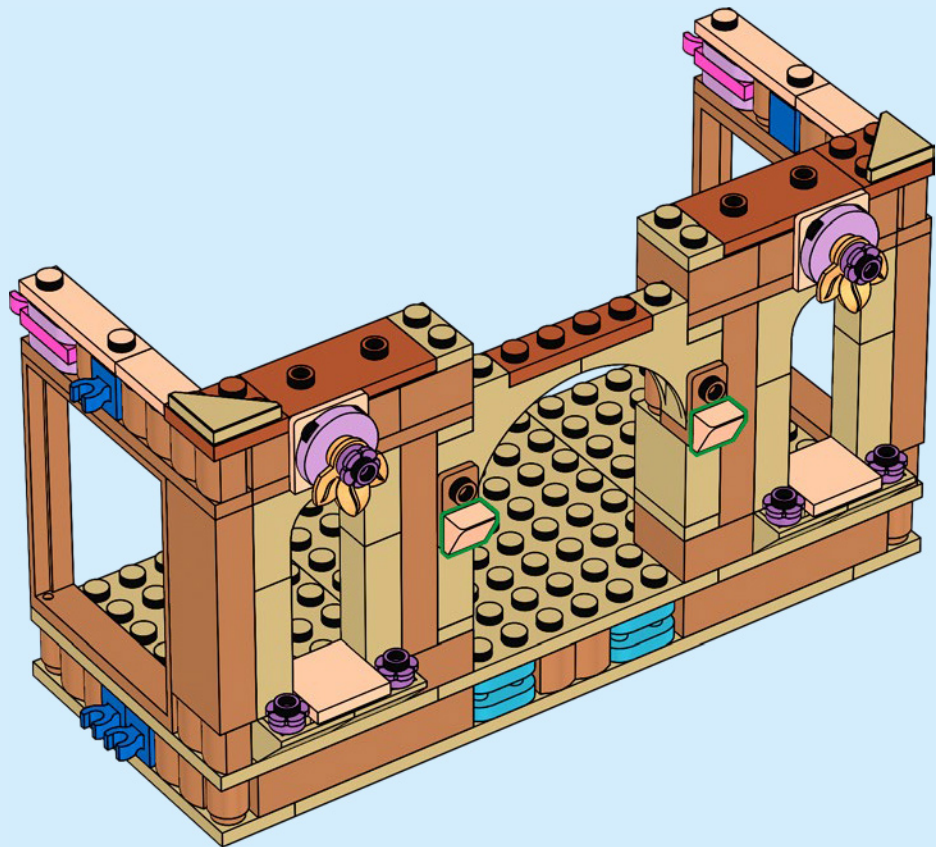

2x 2x 2x

55

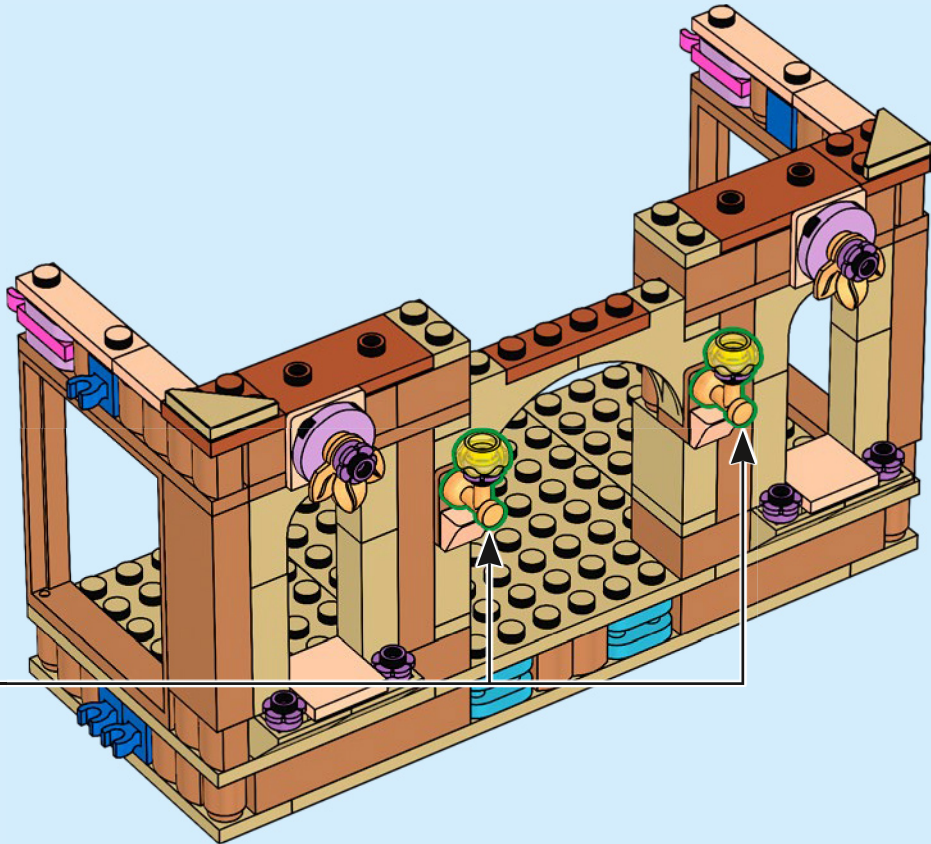

1 2 2x

56

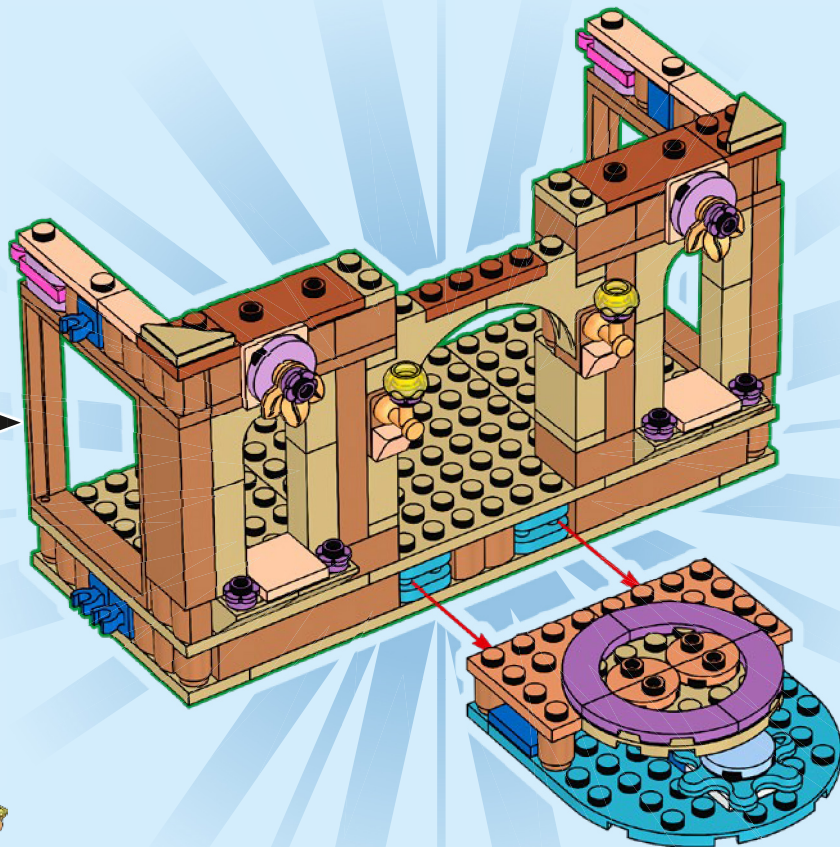





2x

57

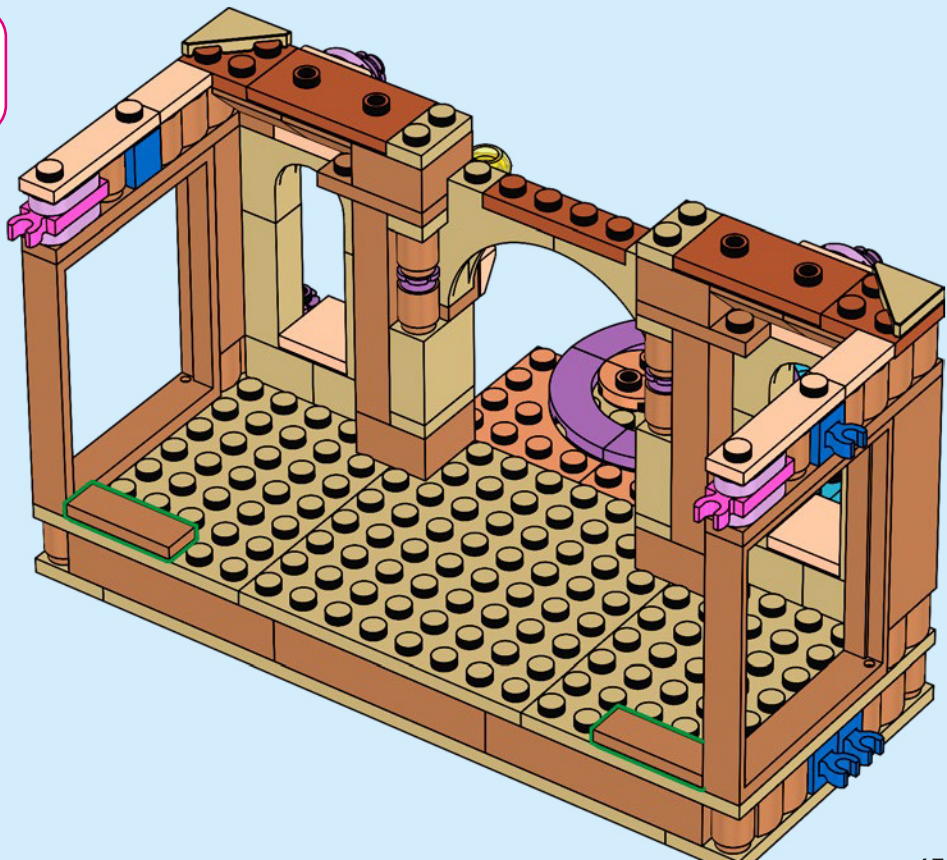



2x



2x

58

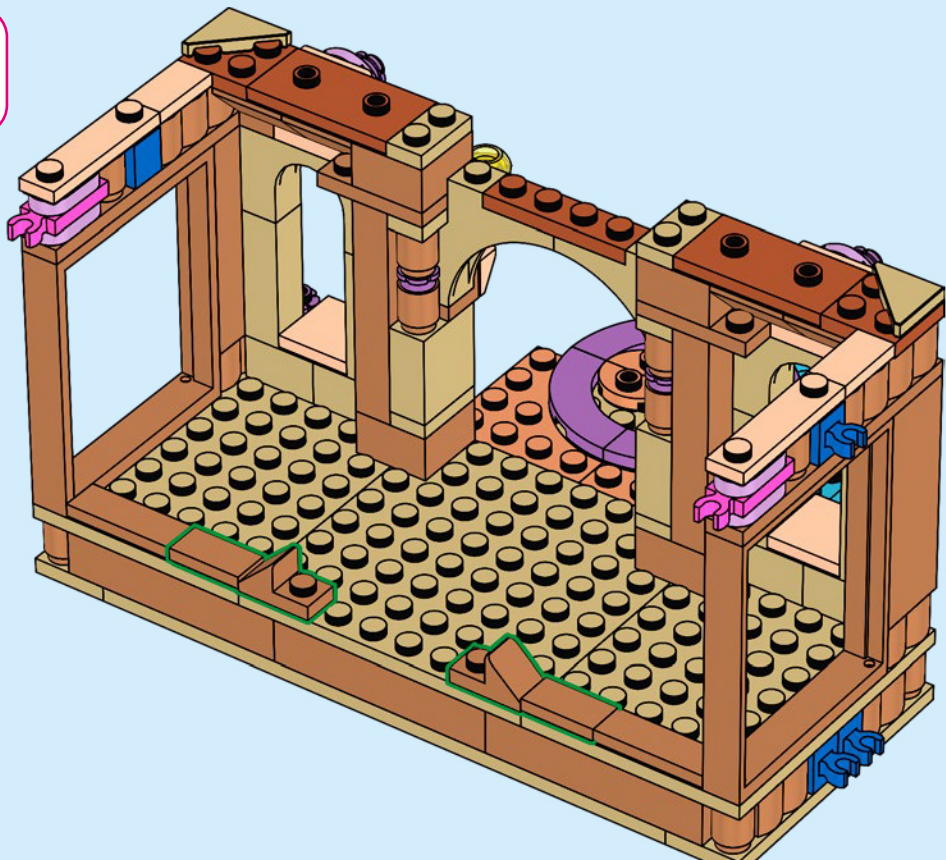



4x

59

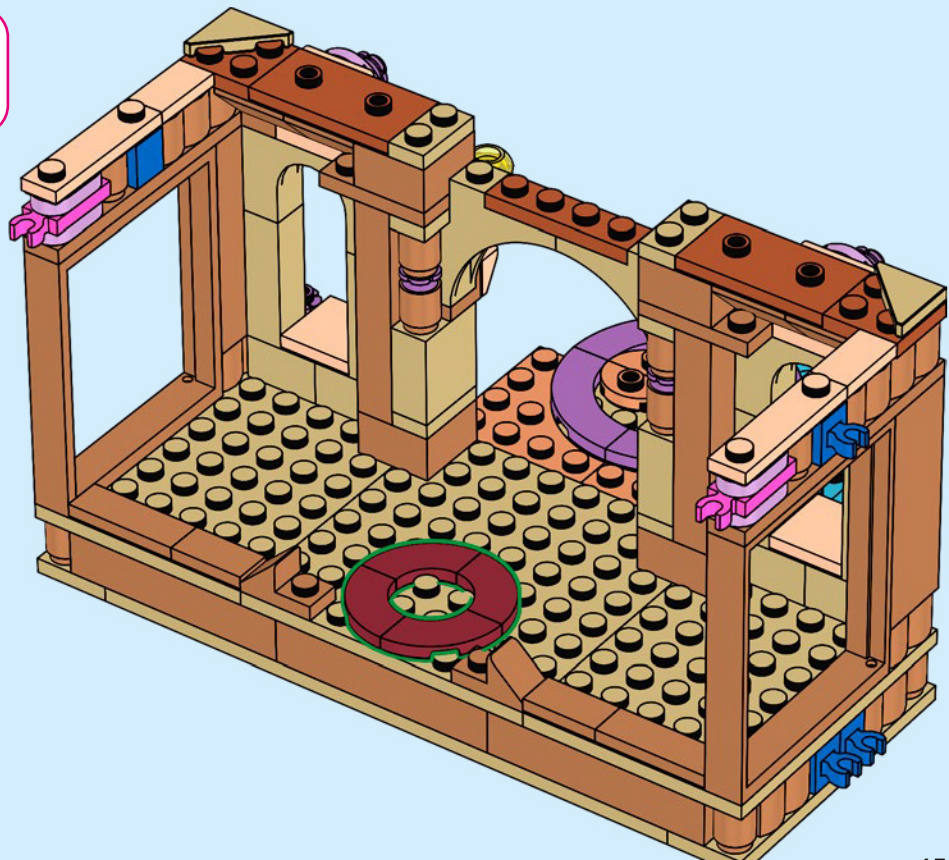



1x

60

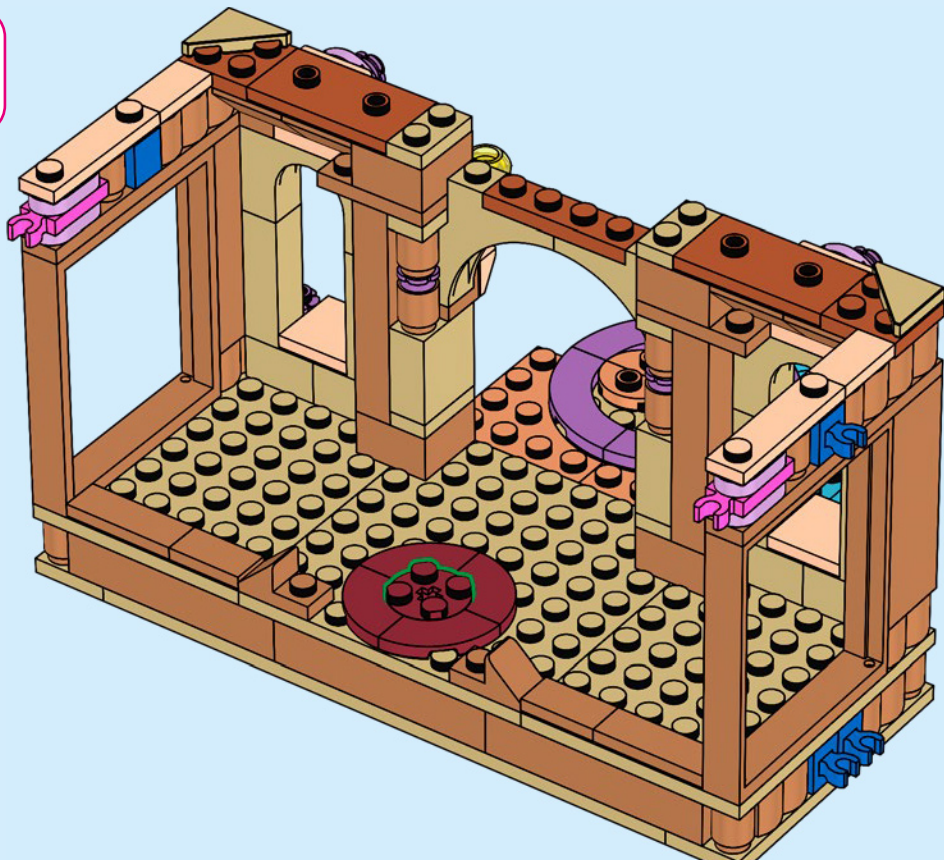

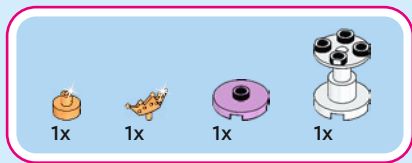

61

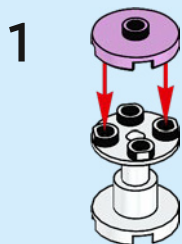

2



3

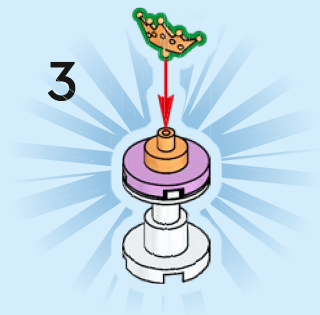

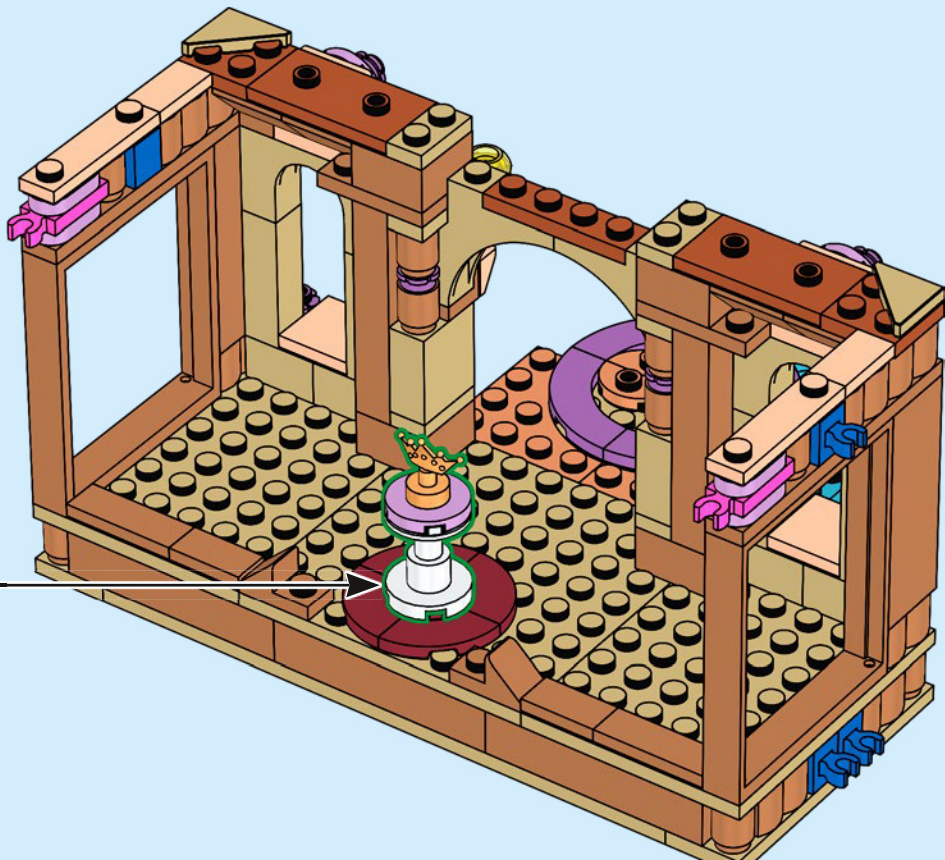



2x

62





63

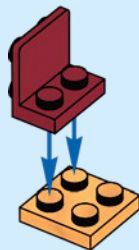

1x

64

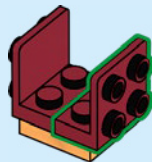



2x

65

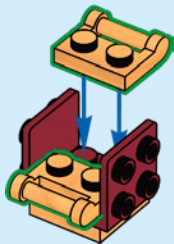

1x

66

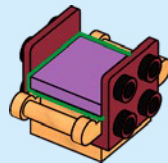



2x

67

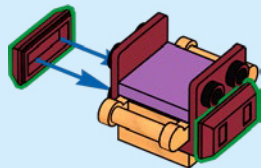

2x

68

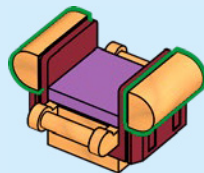

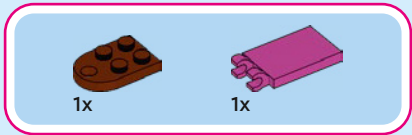

69

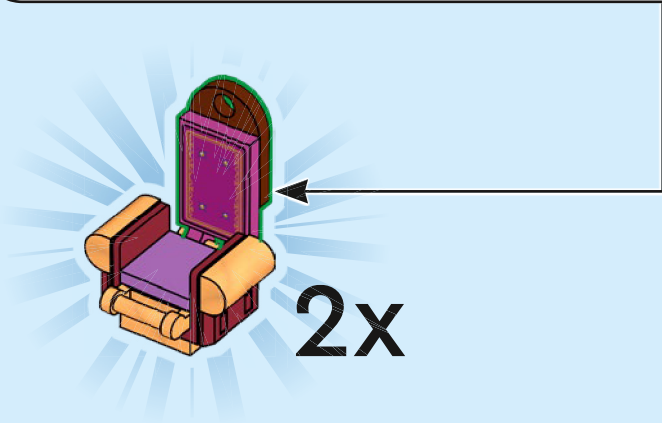
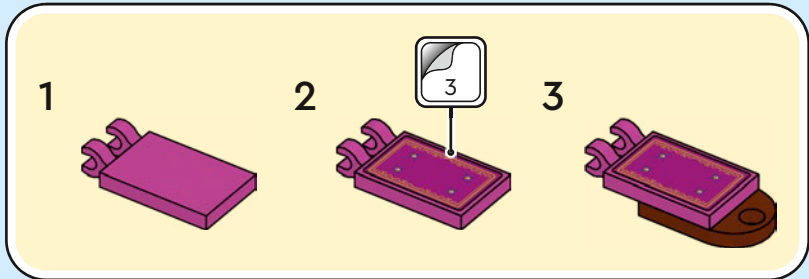

70

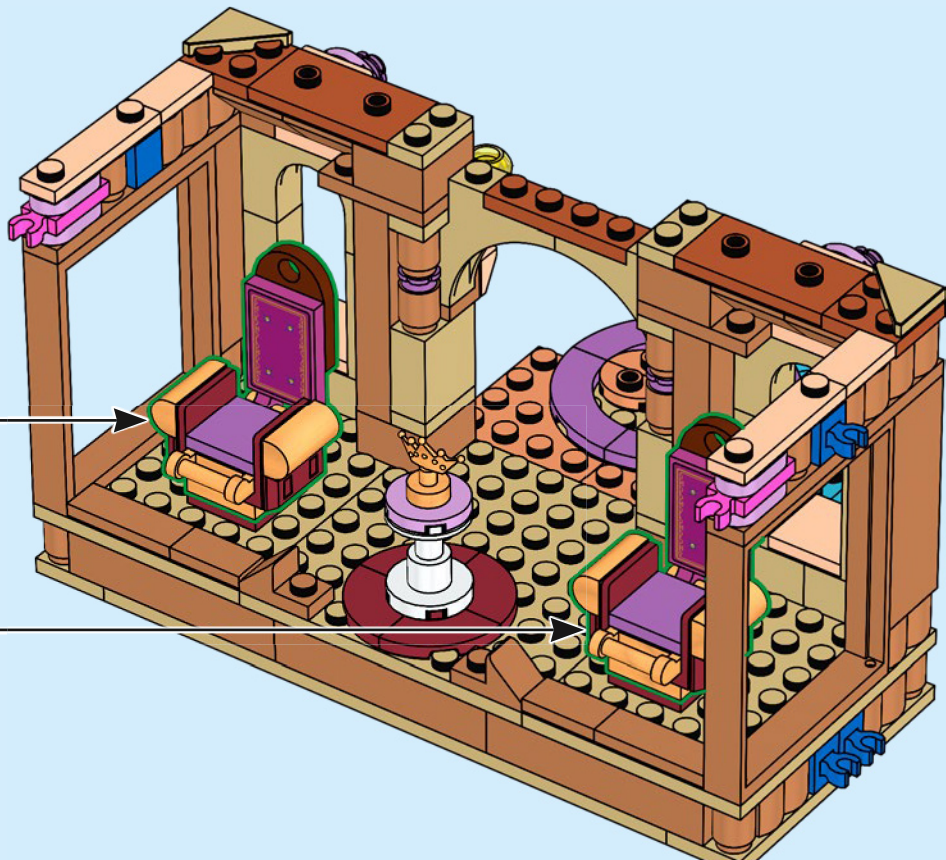

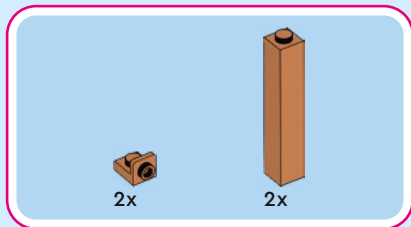

71

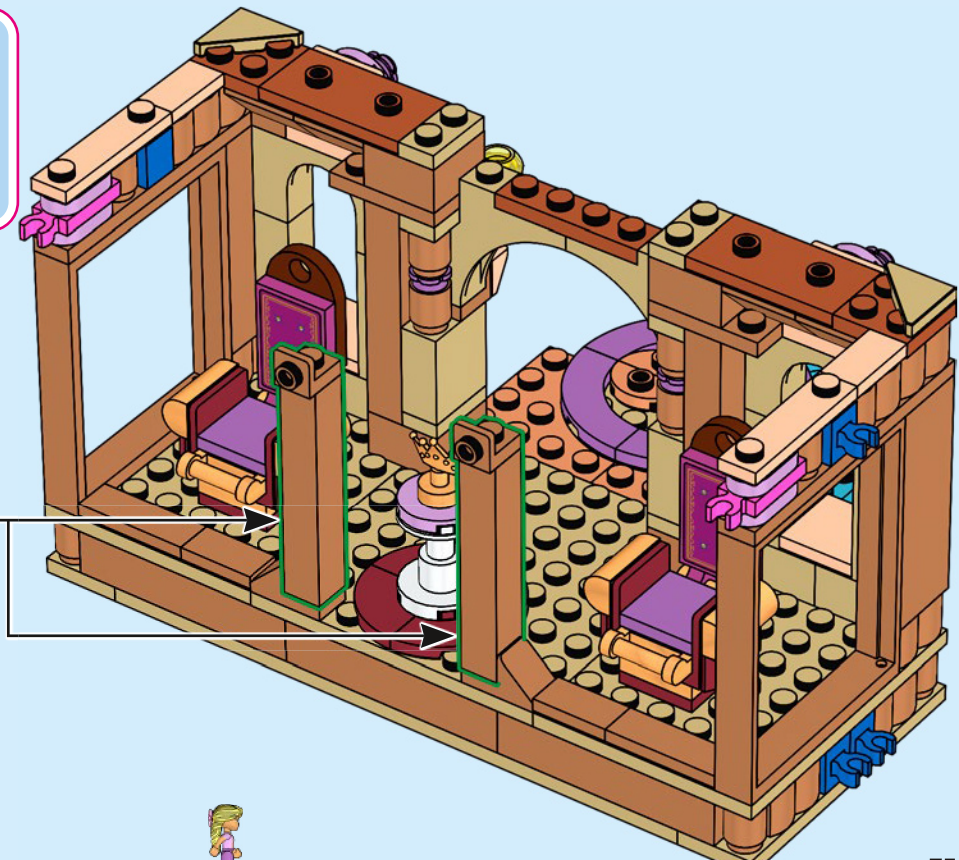
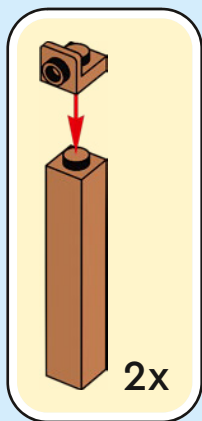



1x

72

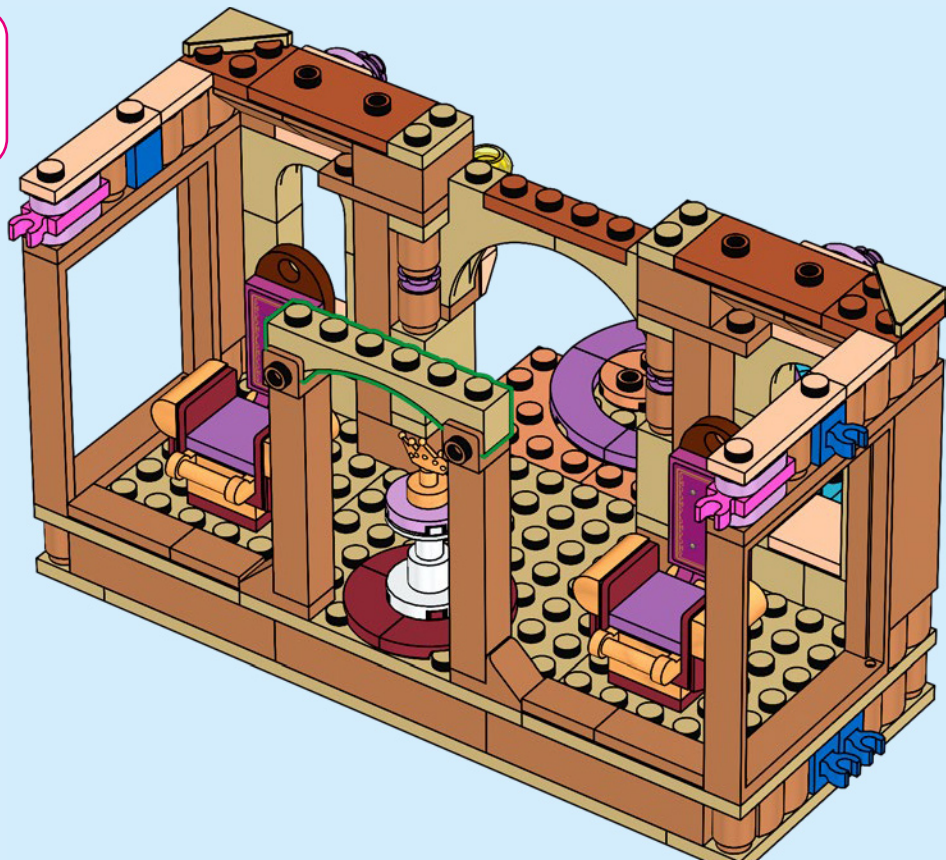

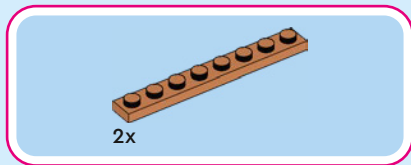

73

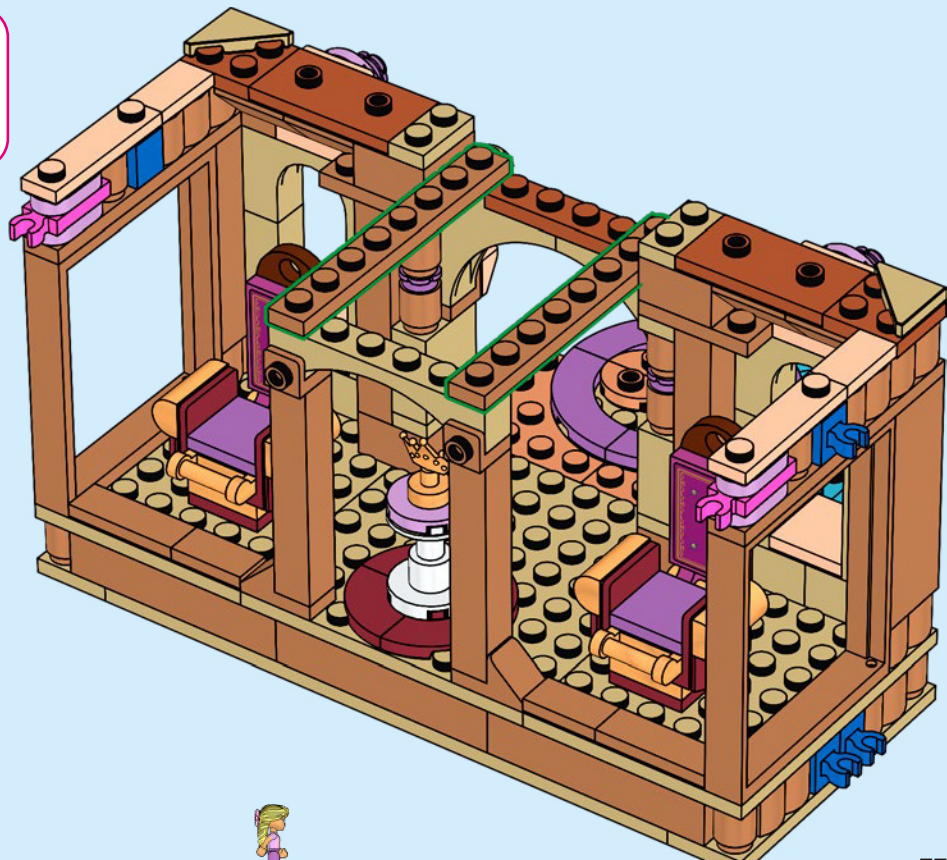

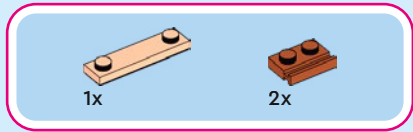

74

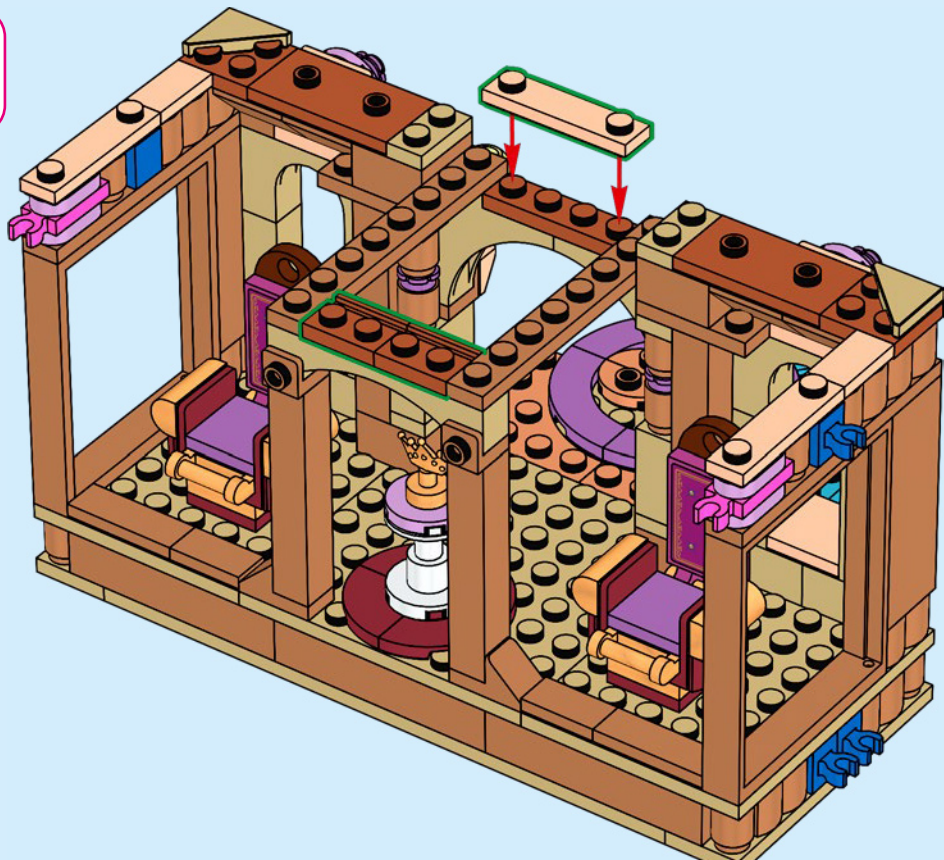

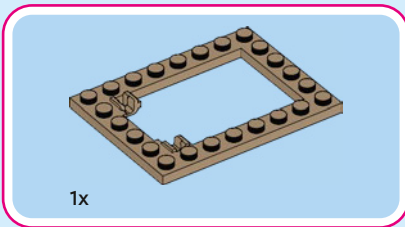
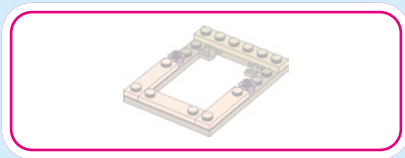

75

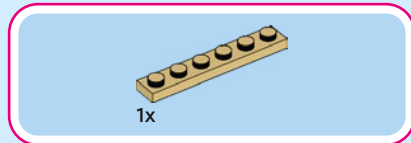
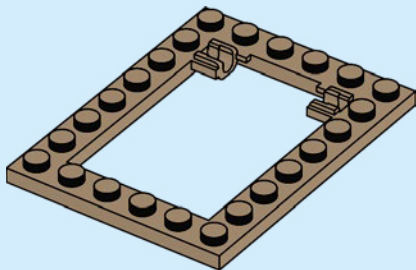

76

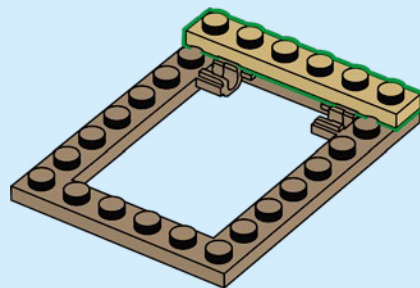



3x

77

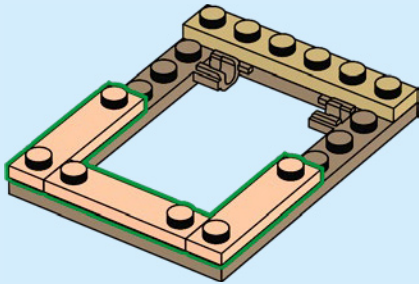

2x

78

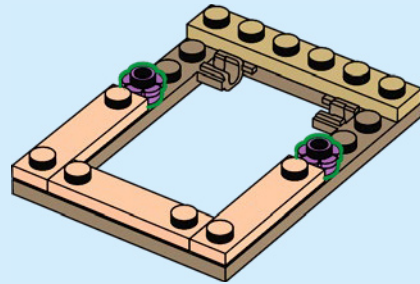

79

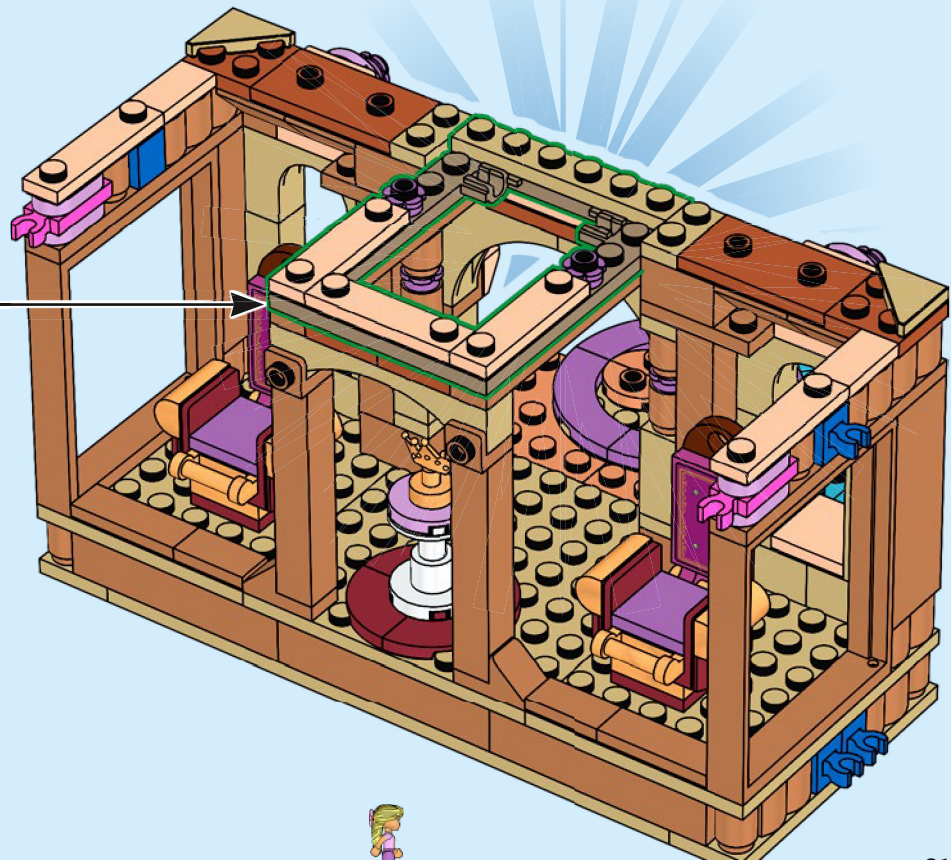

2x 2x 2x

80

1 2

2x

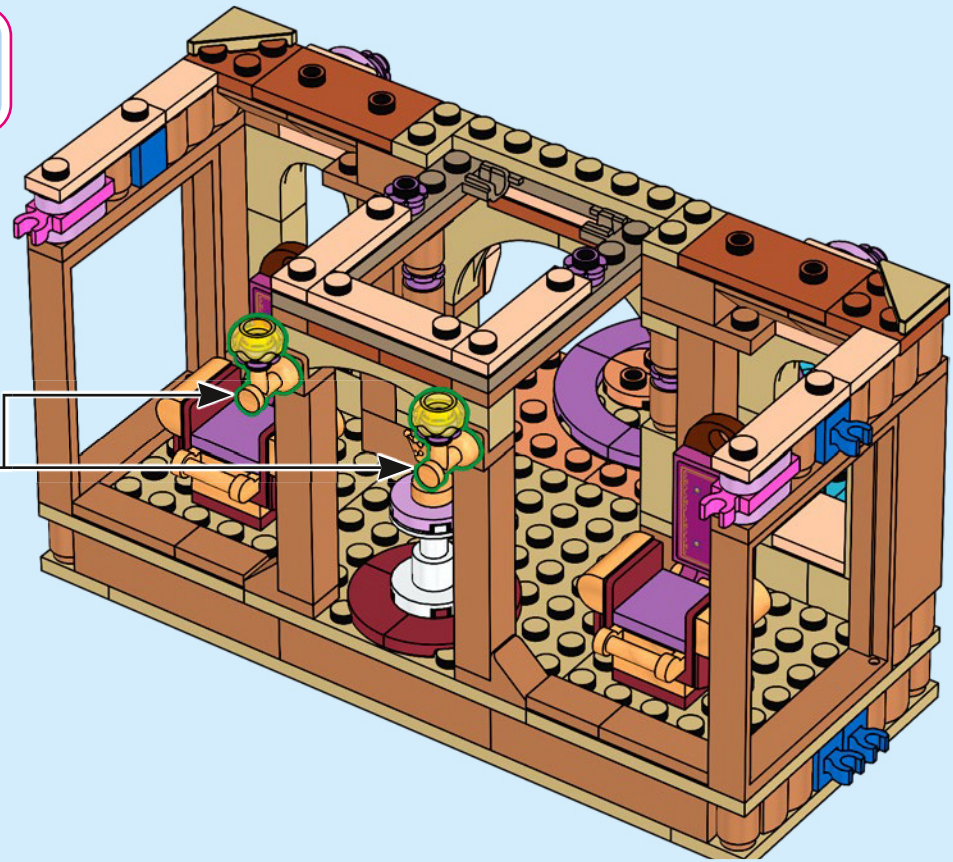

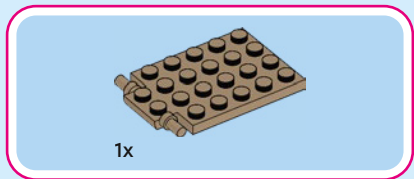

81

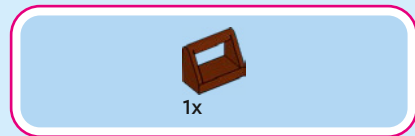
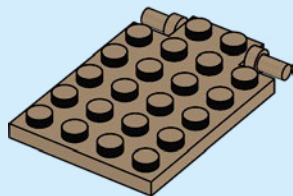

82

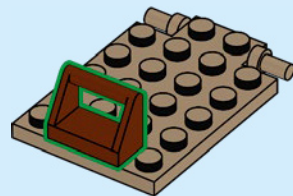

83

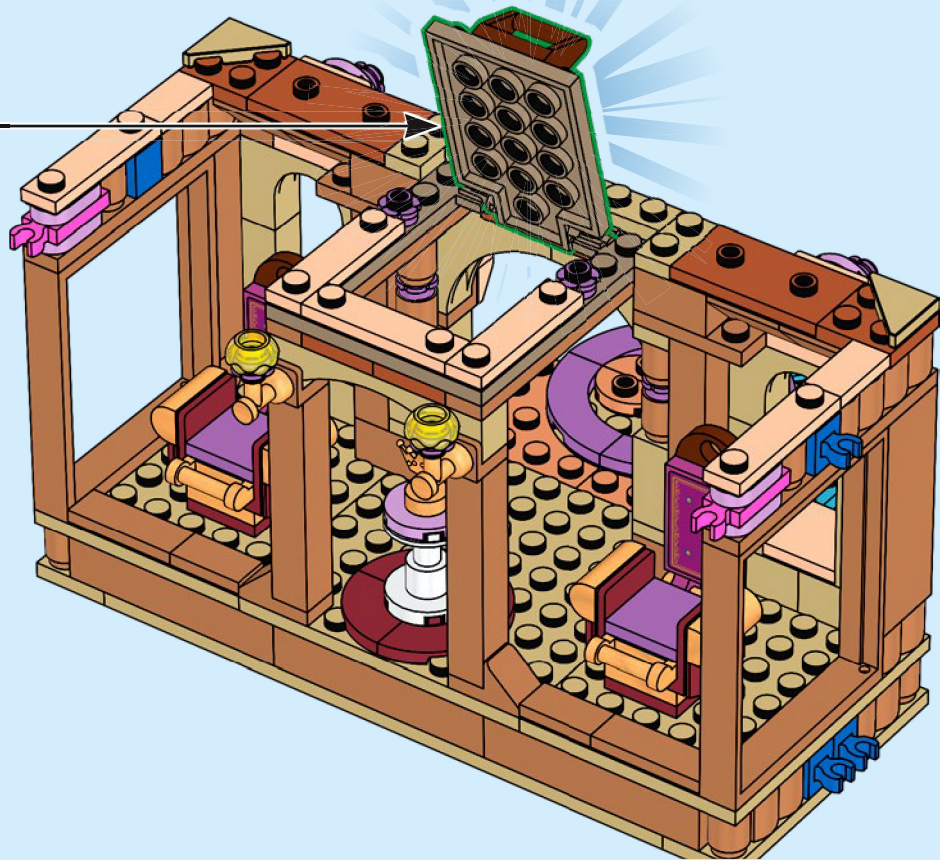

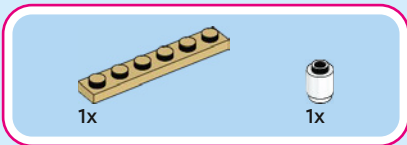

84

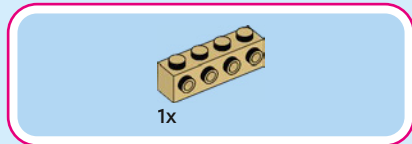
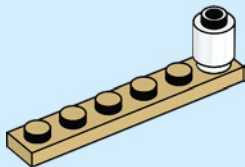

85

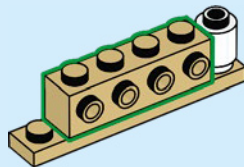



1x



1x

86

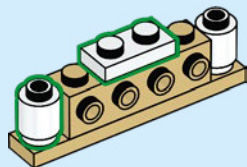

1x



2x

87

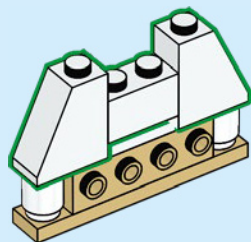



1x

88

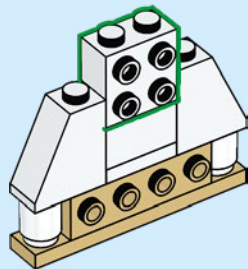

2x

89

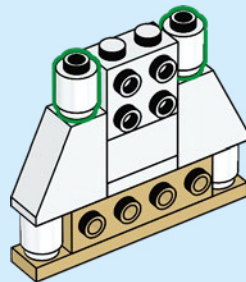



1x

90

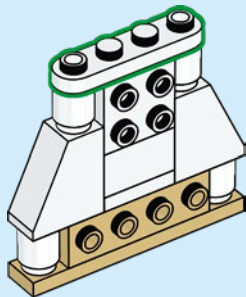

2x

91

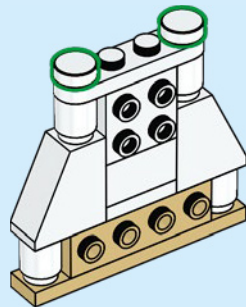



2x

92

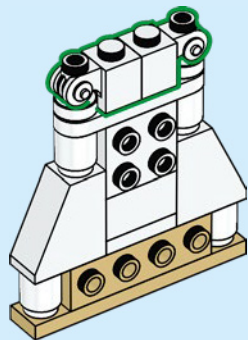

1x

93

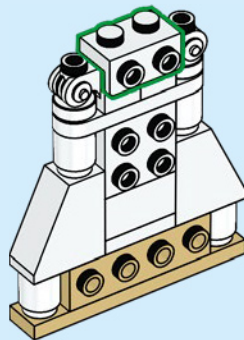



2x

94

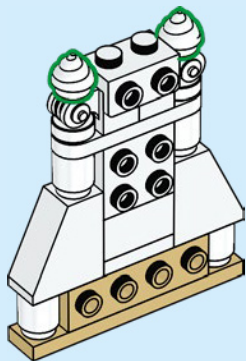

1x



1x



1x

95

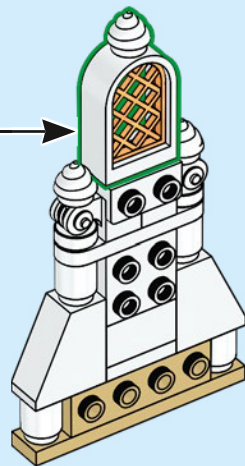
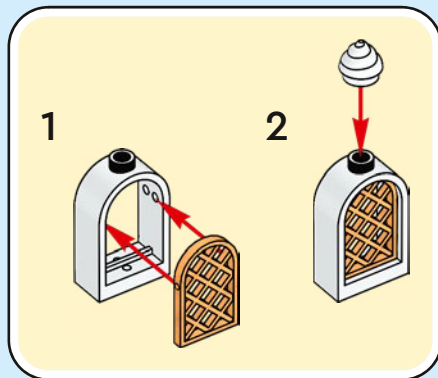



1x

96

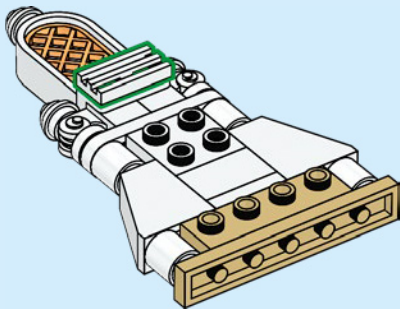

1x

97

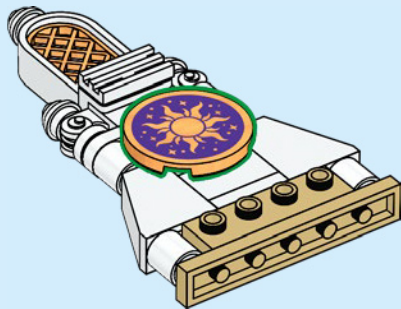

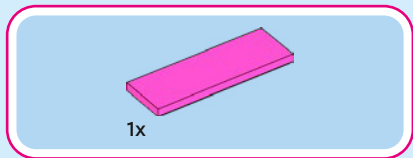

98

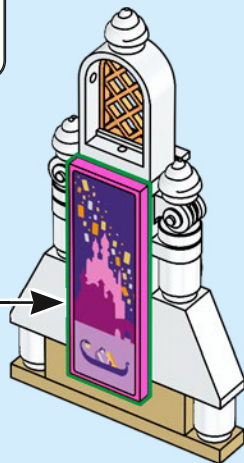
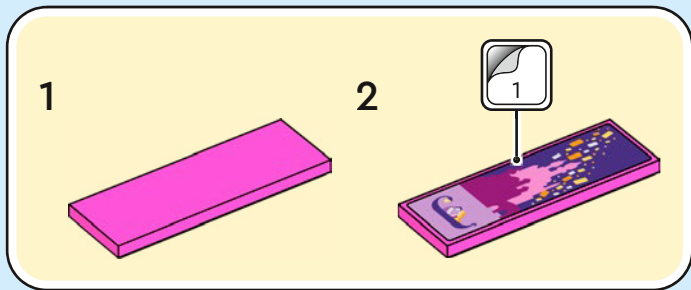

99

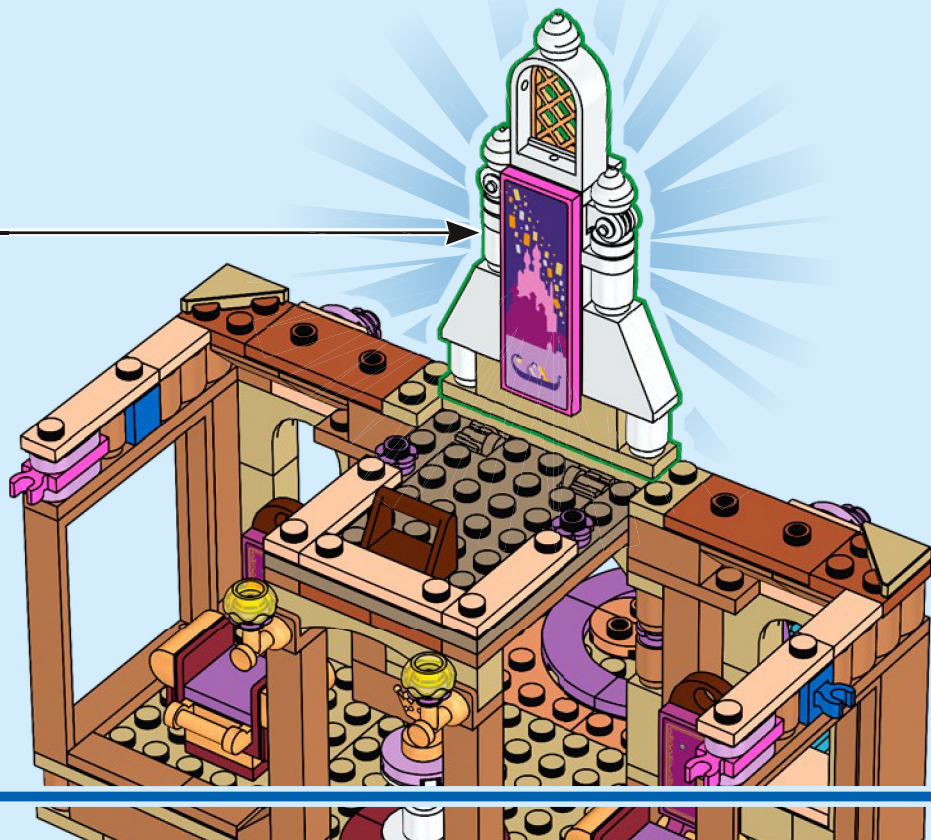



1x

100

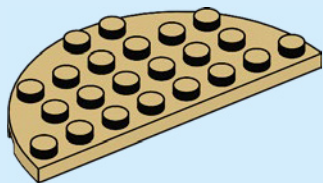

2x

101

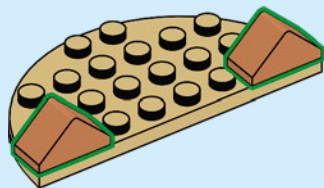

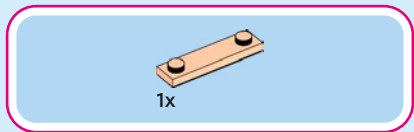

102

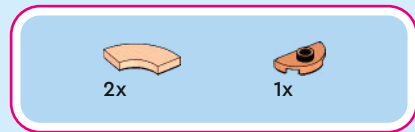
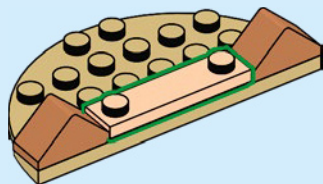

103

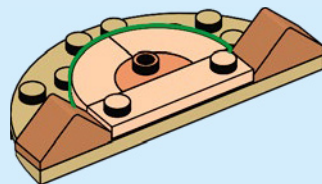

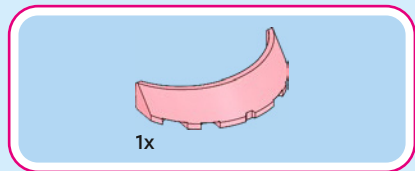

104

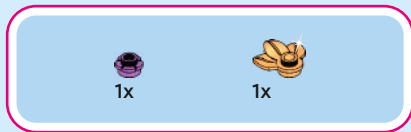
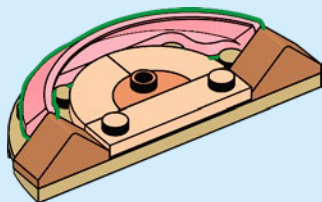

105

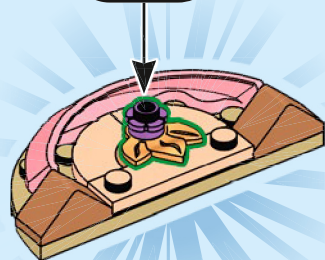
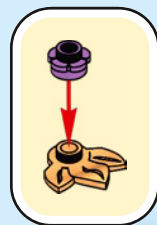

106



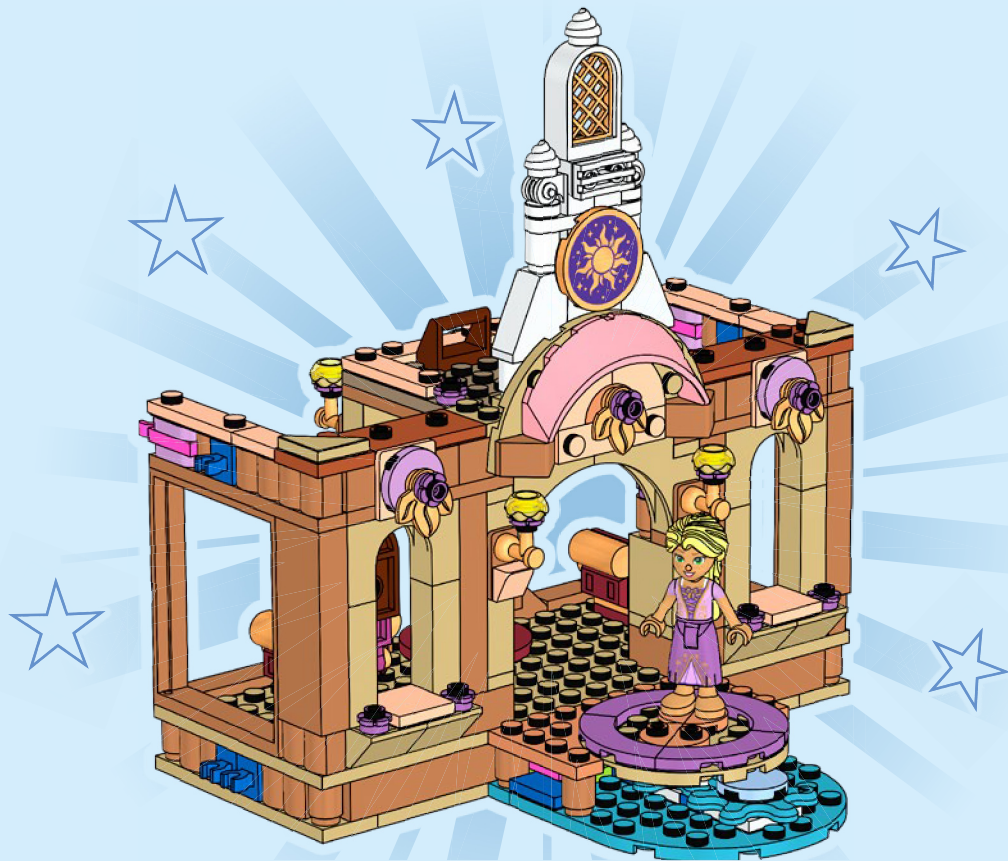

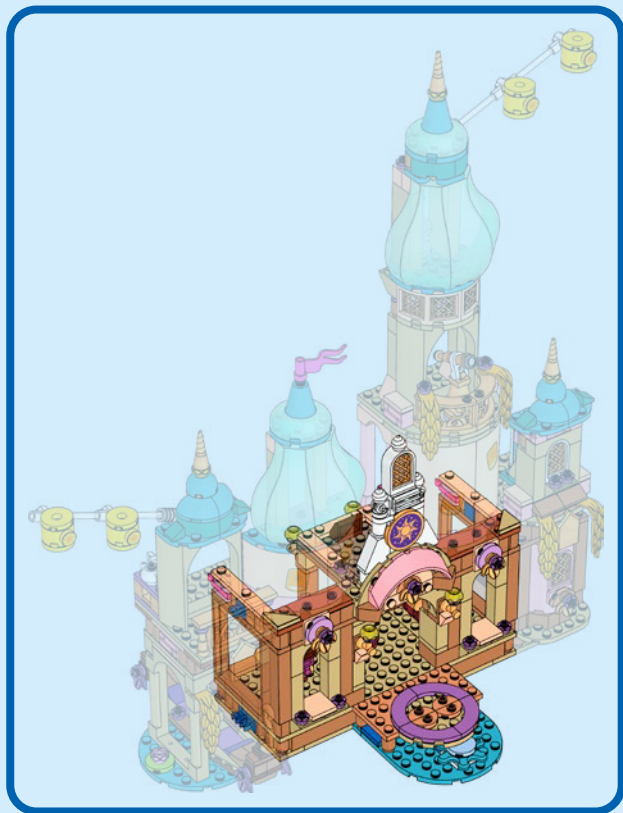



LEGO and the LEGO logo are trademarks of the/son des marques de commerce du/son marcas registradas de LEGO Group. ©2026 The LEGO Group.

© Disney

 6651455