

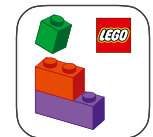

11505



Available in English
In deutscher Sprache verfügbar
Disponibles en français
Disponibile in italiano
Disponible en español
提供中文版本



LEGO® Builder

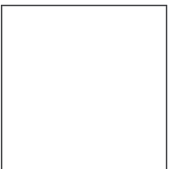



LEGO.com/sustainable-packaging



FR
**DONNEZ
OU
RECYCLEZ**



ASSOCIATION

OU



MAGASIN

OU



DÉCHÈTERIE

Adresses sur quefairedemesdechets.fr



BUILDER



Apple and the Apple logo are trademarks of Apple Inc., registered in the U.S. and other countries and regions. App Store is a service mark of Apple Inc. Google Play and the Google Play logo are trademarks of Google LLC. Tencent and the Tencent logo are trademarks of Tencent Inc.

LEGO.com/devicecheck

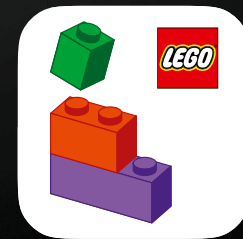

LEGO® Builder



SIMPLE, WILD EXISTENCE

When you explore nature with a curious mindset, you inevitably feel a sense of duality in the change of seasons. Decay coexists in perfect harmony with new life. This LEGO® built ecosystem captures a magical slice of a forest floor at the edge of a Northern European woodland, at the transition from summer to autumn. Imagine a bountiful foraging trip, where you get to explore a rich variety of fungi and autumn crocuses. While such a dense collection of species might be improbable in nature, we wanted to create a visually captivating – and theoretically plausible – scene. Every element is designed with care to balance realism with a whimsical charm.

The LEGO® Botanicals Design Team





Colchicum autumnale

AUTUMN CROCUS

Unlike its spring cousin, this pink-and-purple crocus belongs to the Colchicaceae family and blooms in the autumn. Elegant and graceful, yet toxic, it thrives in grasslands and woodlands in Europe and Asia.



Pteridium aquilinum

BRACKEN

One of the most common plants in the world, it thrives in sun or shade, grasslands or busy areas. With fronds that grow up to 1 m (3 ft.), it's a popular and decorative garden display.



Mycena galericulata

COMMON BONNET

This delicate, bell-capped clusterer is found on fallen logs and stumps in damp areas and mixed woods. Known for its beautiful, enchanting appearance, it has inspired artists throughout the ages.



Pleurotus ostreatus

OYSTER MUSHROOM

Look for these popular shell-like caps with decurrent gills and short – or absent – stems on decaying wood in forests or even urban areas. They are typically white or grey and can grow up to 25 cm (9.8 in.) wide.



Cantharellus cibarius

GOLDEN CHANTERELLE

Chanterelles flare their golden trumpets with blunt, forked ridges in place of gills. Notoriously elusive, foragers often carefully guard their locations and treasure them as an exquisite delicacy.



Amanita muscaria

FLY AGARIC

With a glossy red-orange cap flecked with white, the fly agaric adds a vibrant splash of colour in European winters, often found beneath birch, pine and spruce. When seen in the wild, handle with care!



Inocybe hirtella

MARZIPAN FIBRECAP

Despite its name and its fibrous cap with an almond-like scent, this mushroom is best when admired from a safe distance! Found in grassy areas, it provides sugars and nutrients to surrounding trees.



Geastrum triplex

COLLARED EARTHSTAR

Look for this spectacular mushroom in woods and grasslands. From a round, spore-filled body, it opens its star-shaped arms to release its spores in a veritable miniature fireworks display!



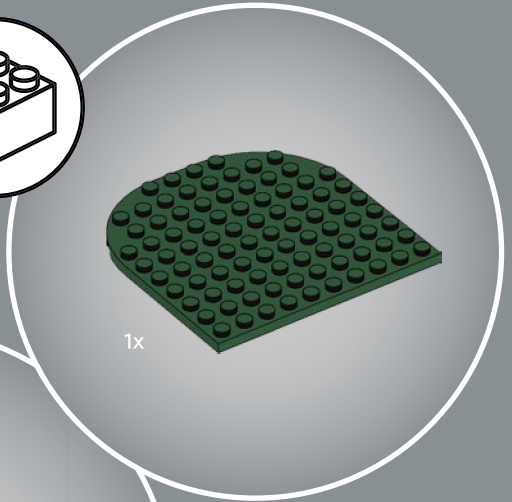
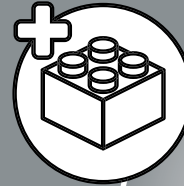
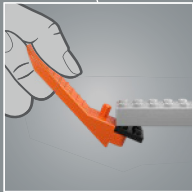
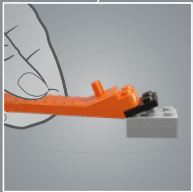
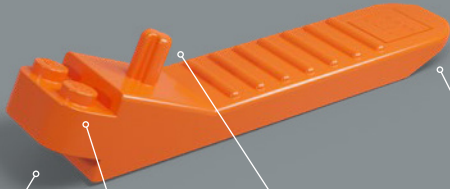

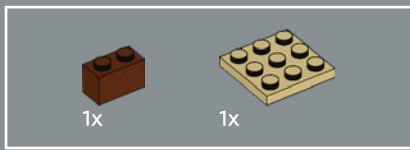

1

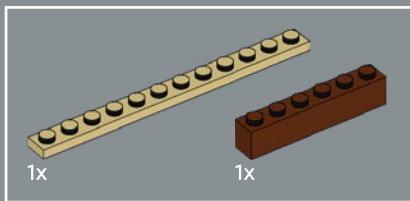
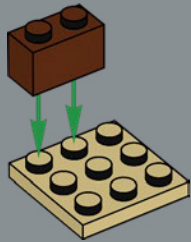

2

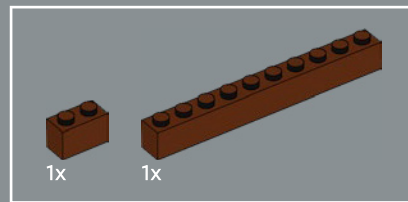
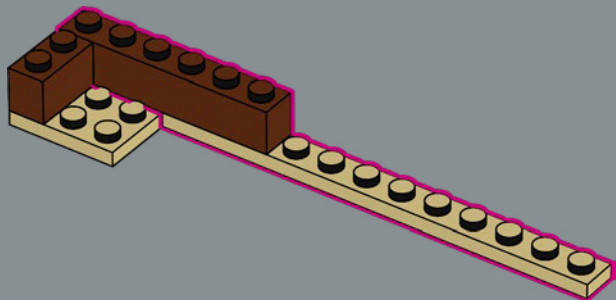

3

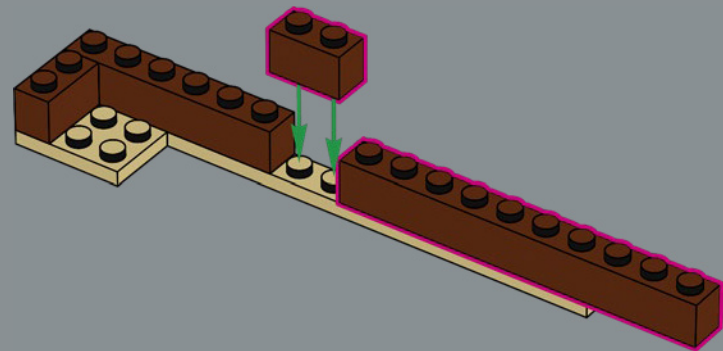

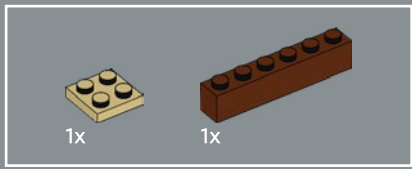

4

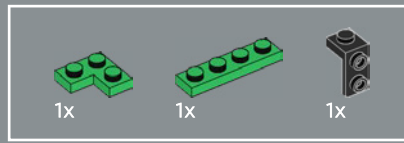
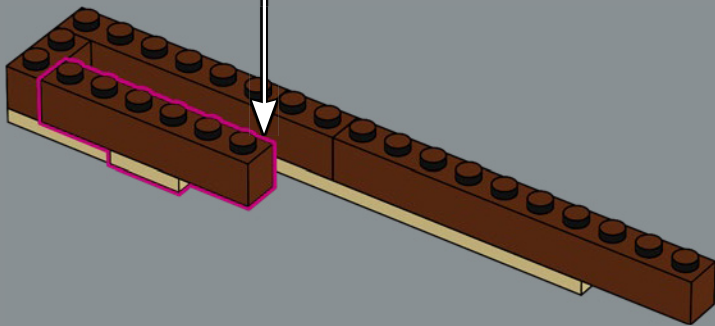
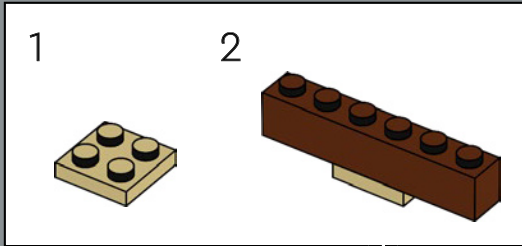

5

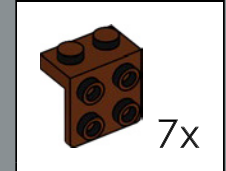
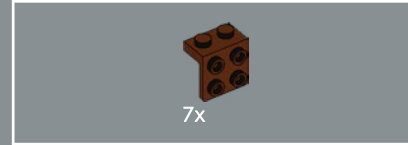
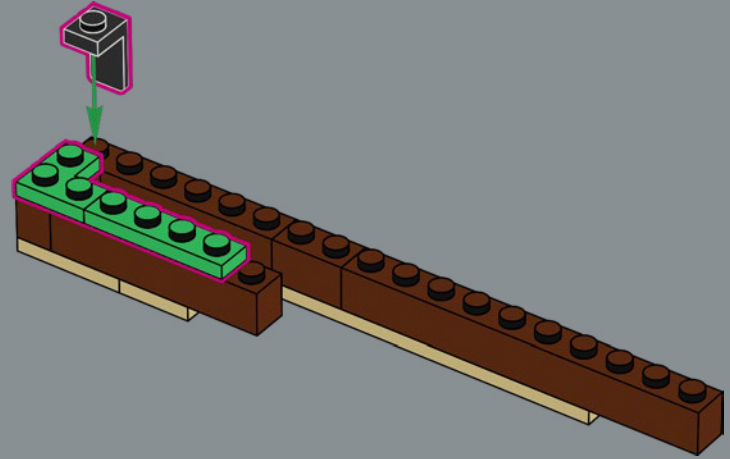

6

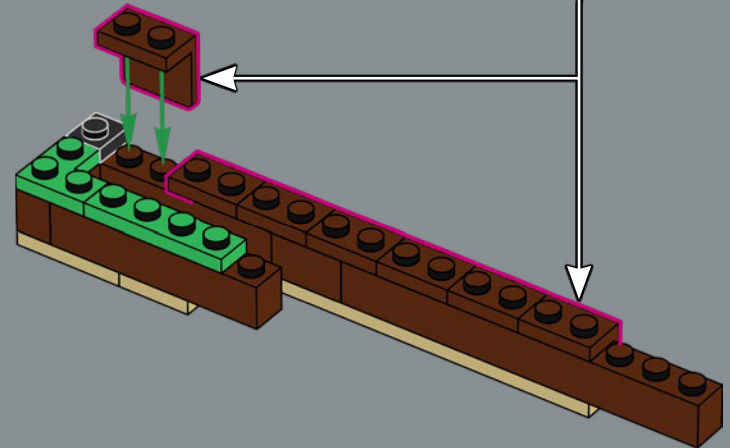

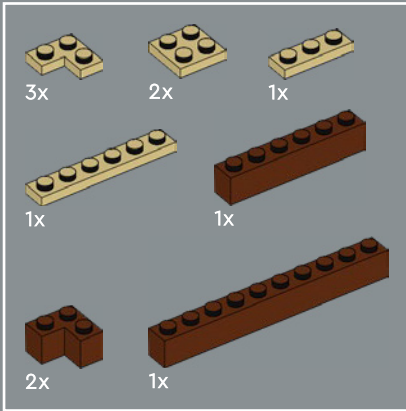
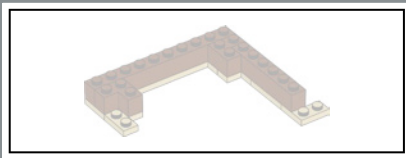

7

1

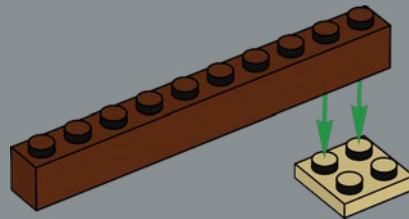

2

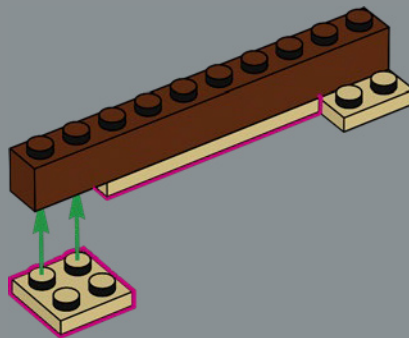

3

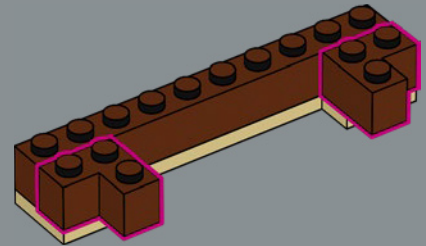

4

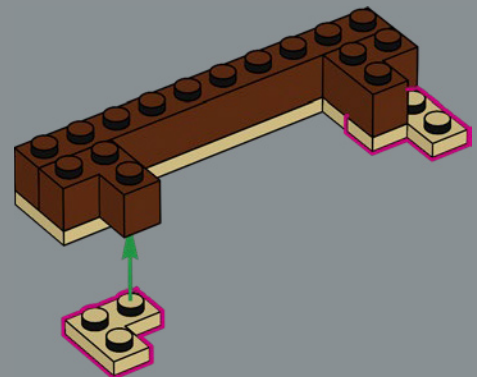

5

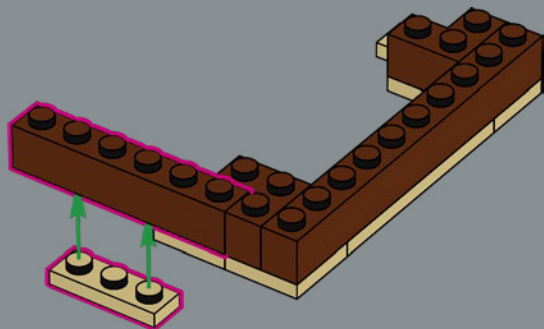

6

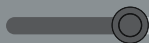
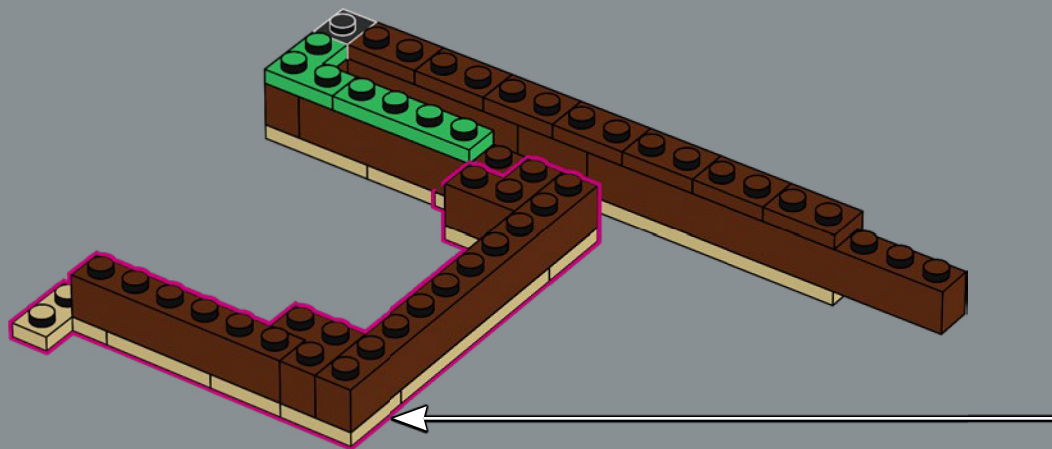
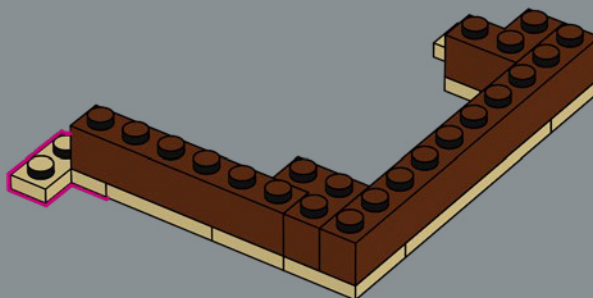

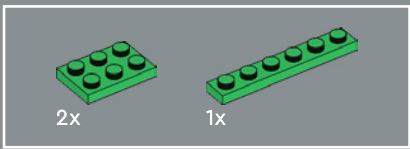

8

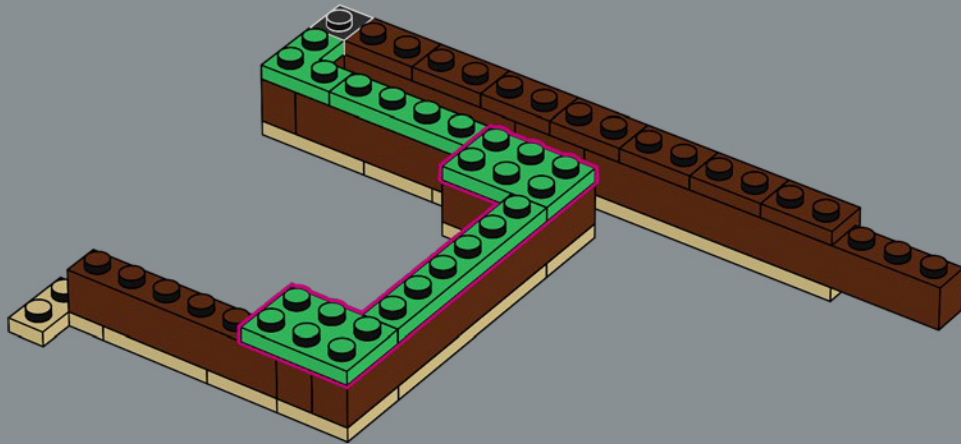

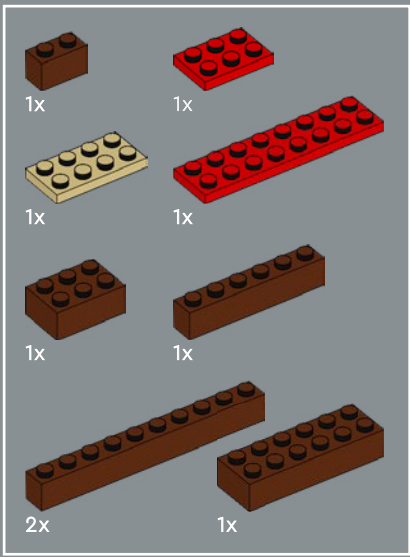

9

1

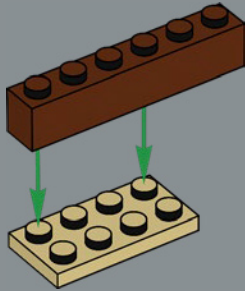

2

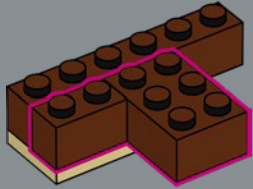

3

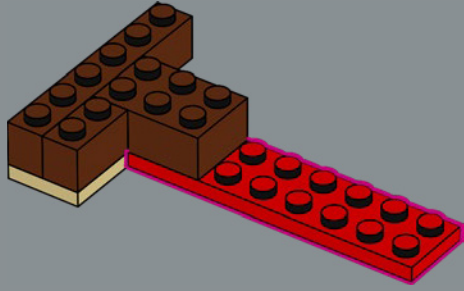

4

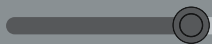
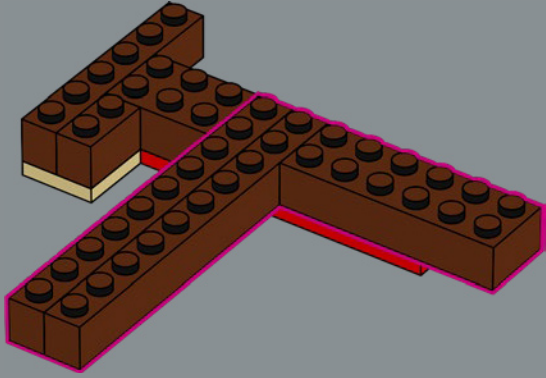

5

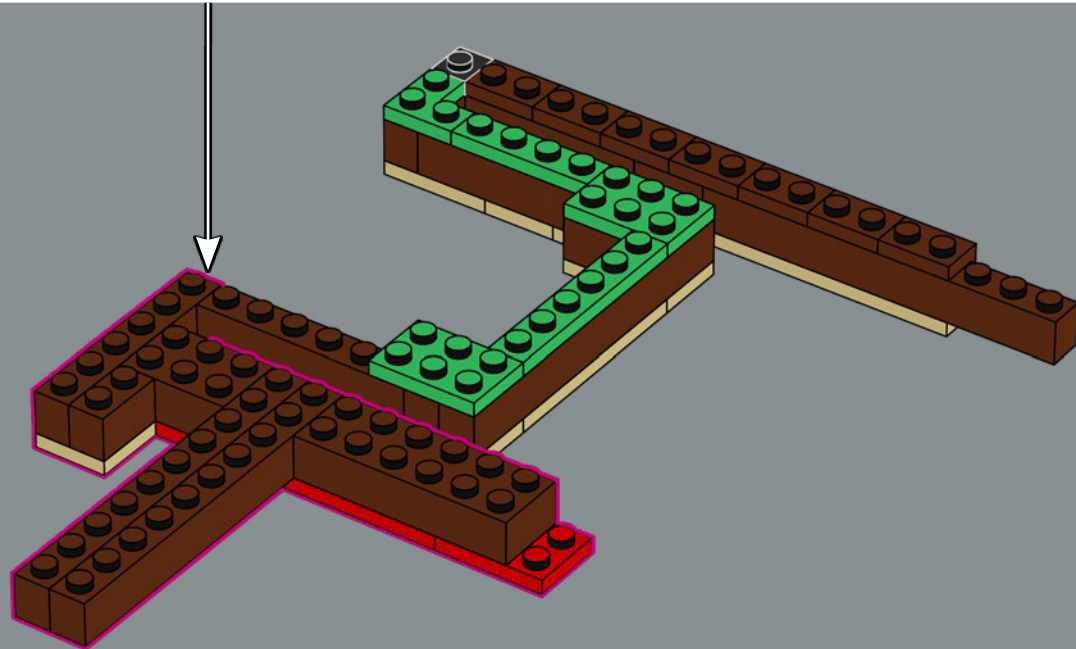
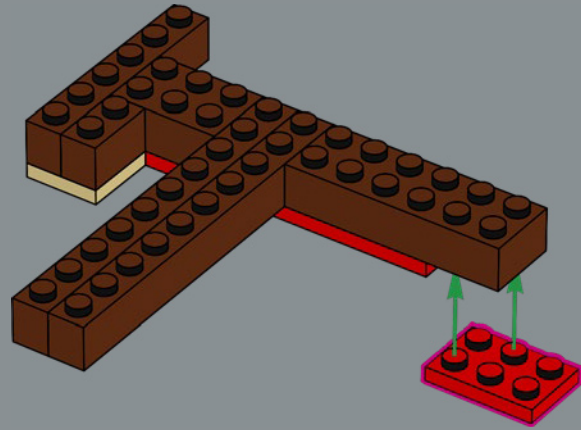

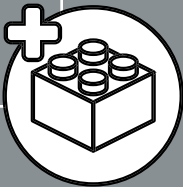
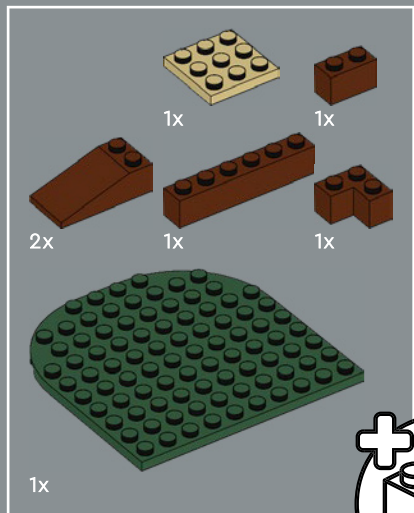

10

1

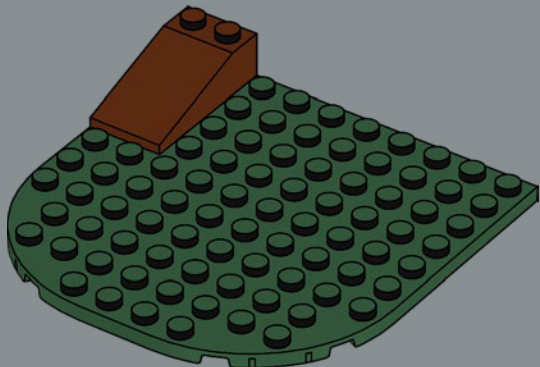

2

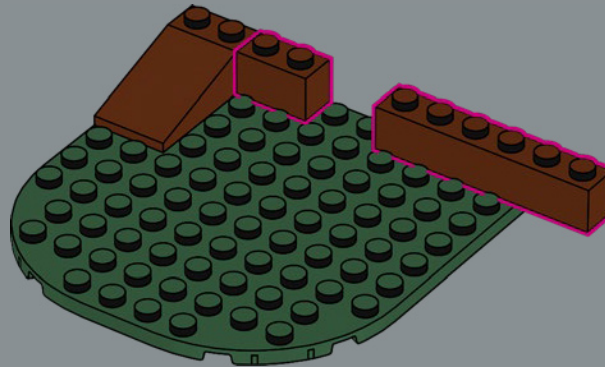

3

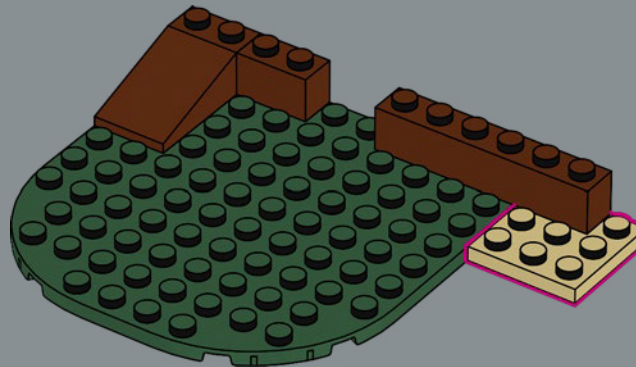

4

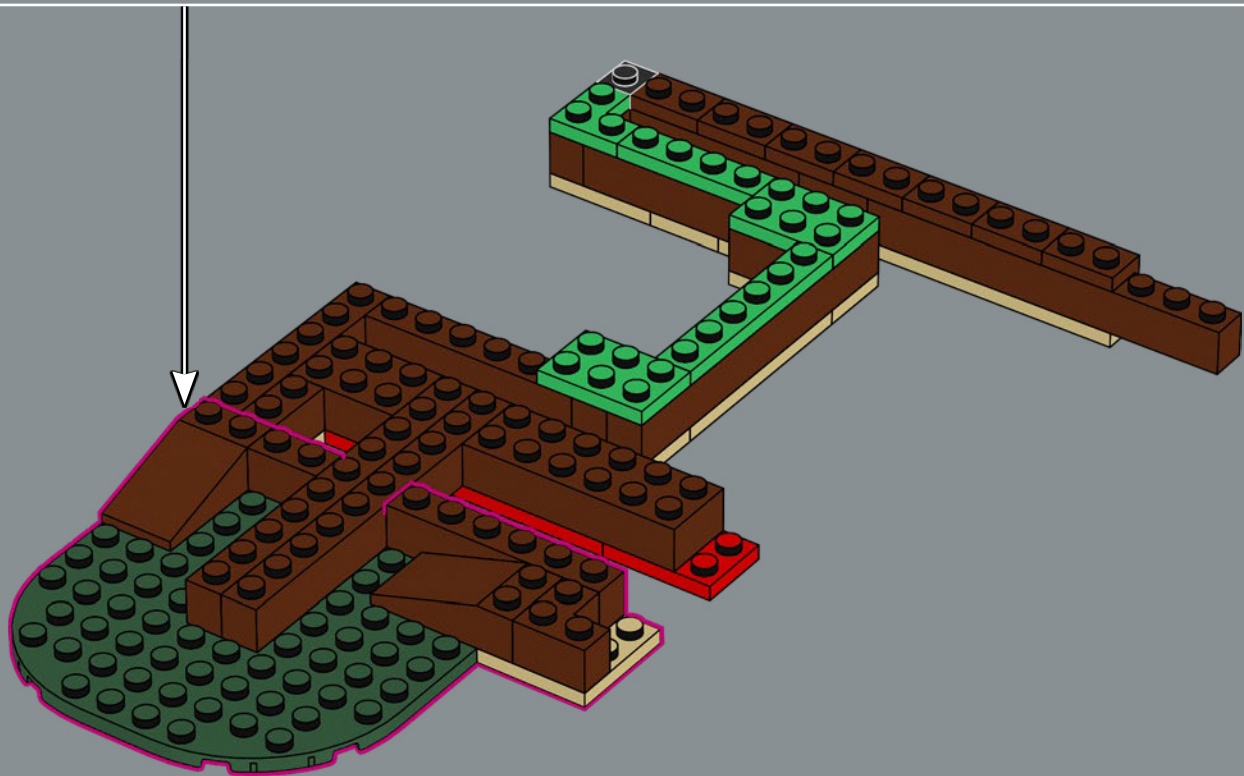
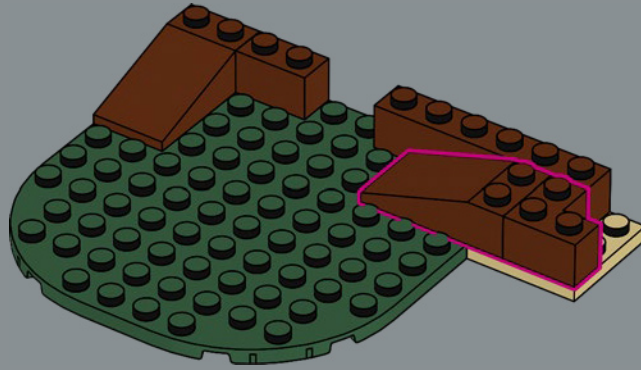

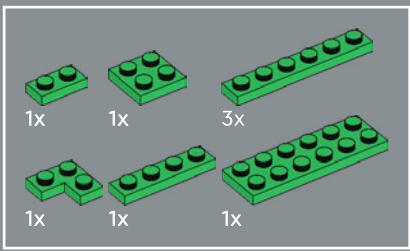

11

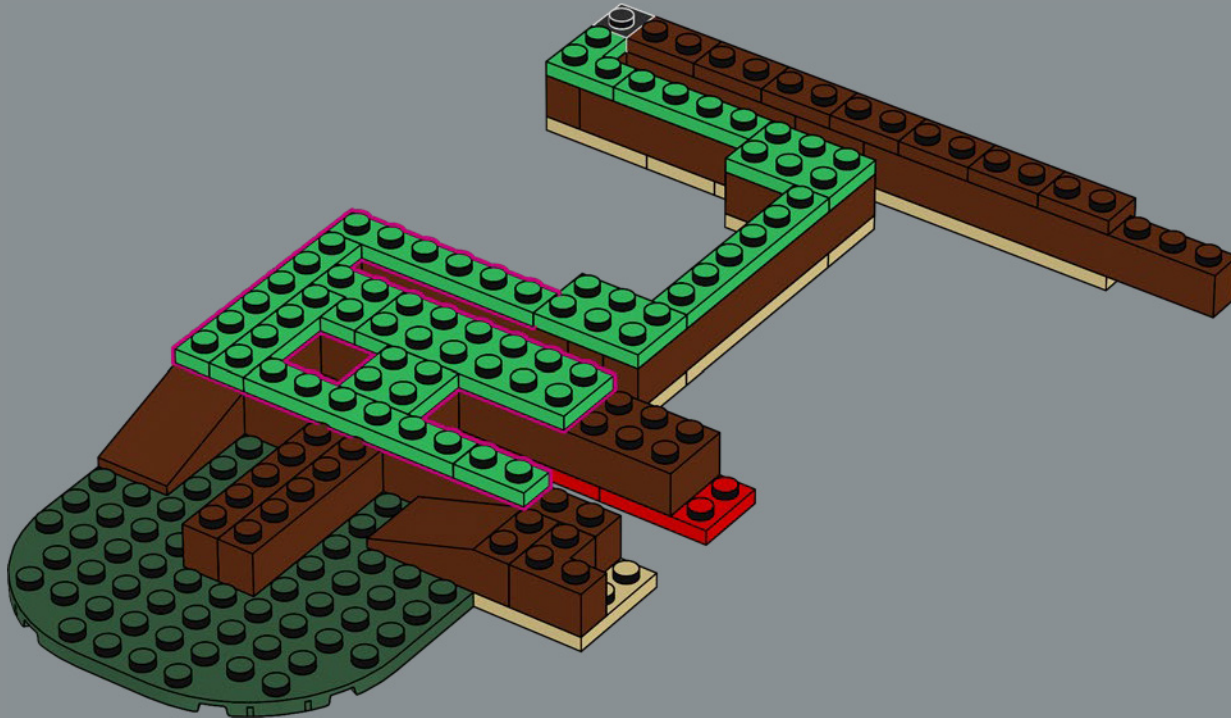

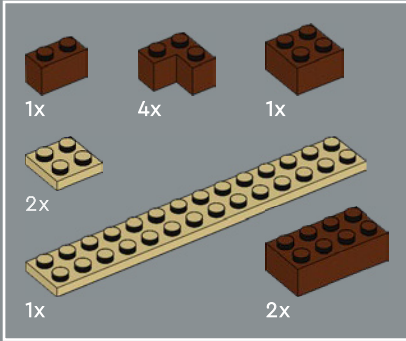
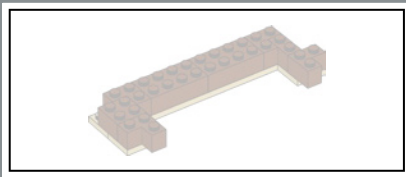

12

1

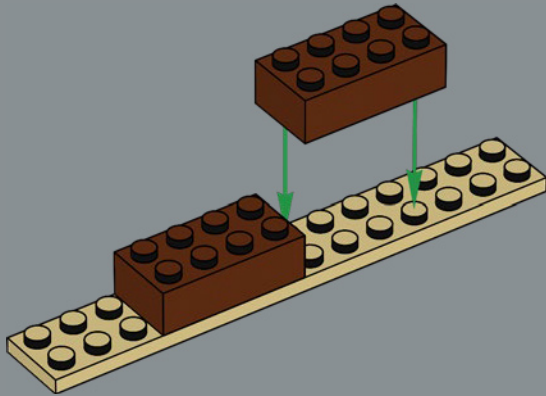

2

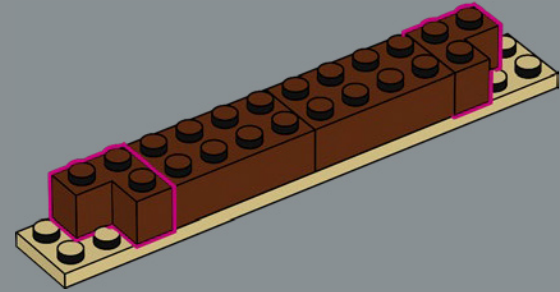

3

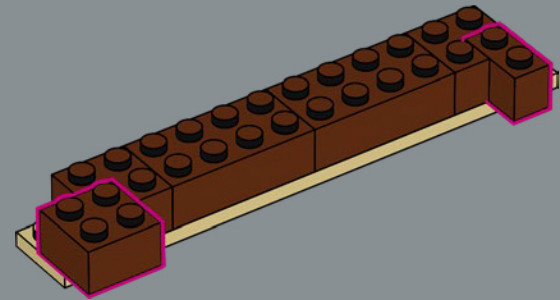

4

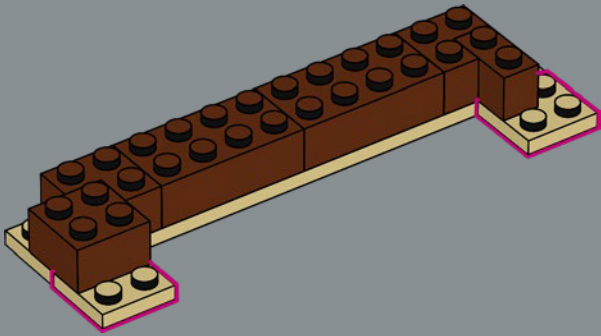

5

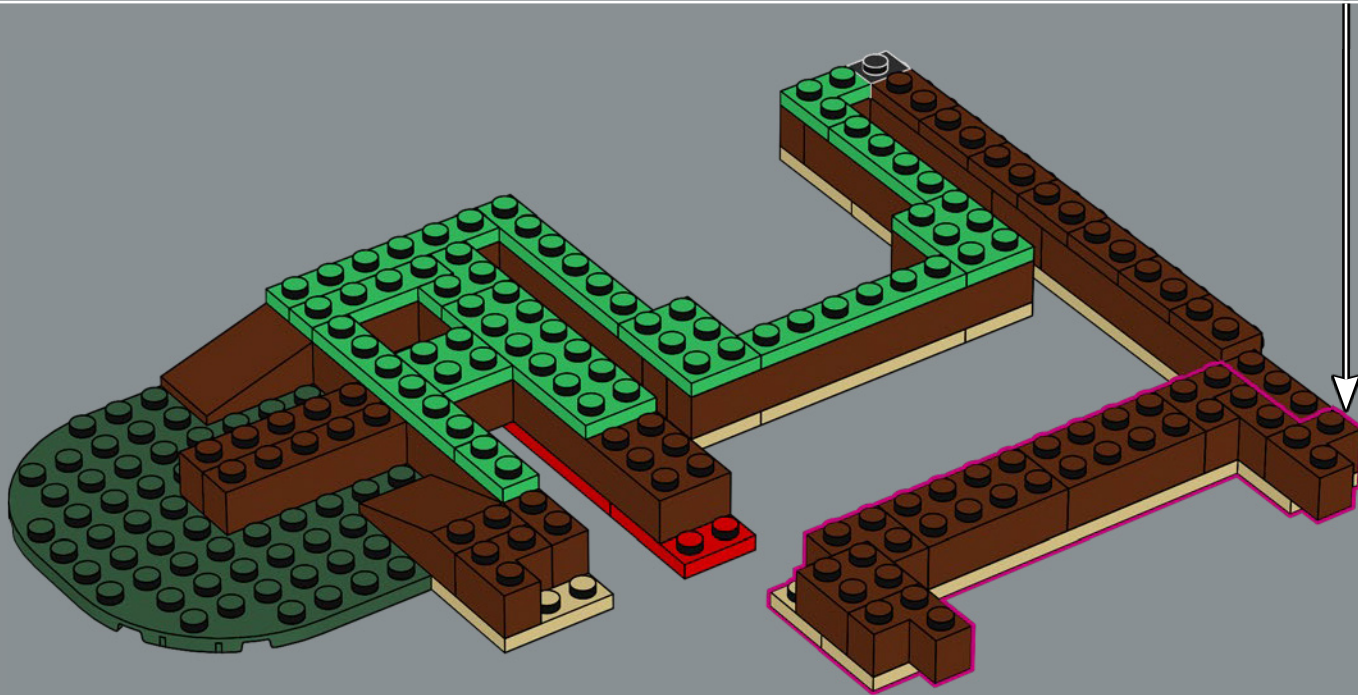
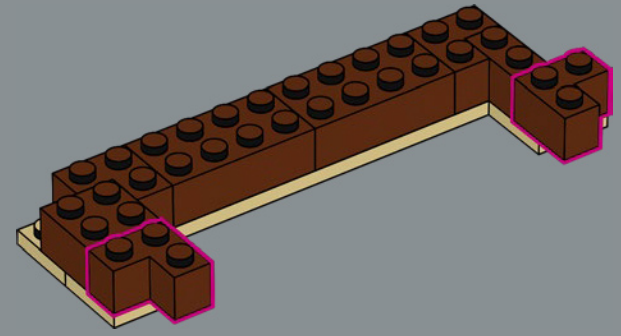

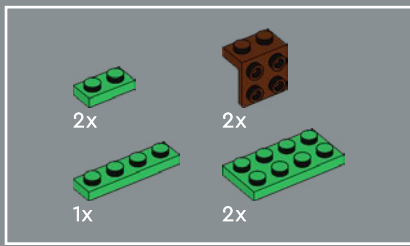

13

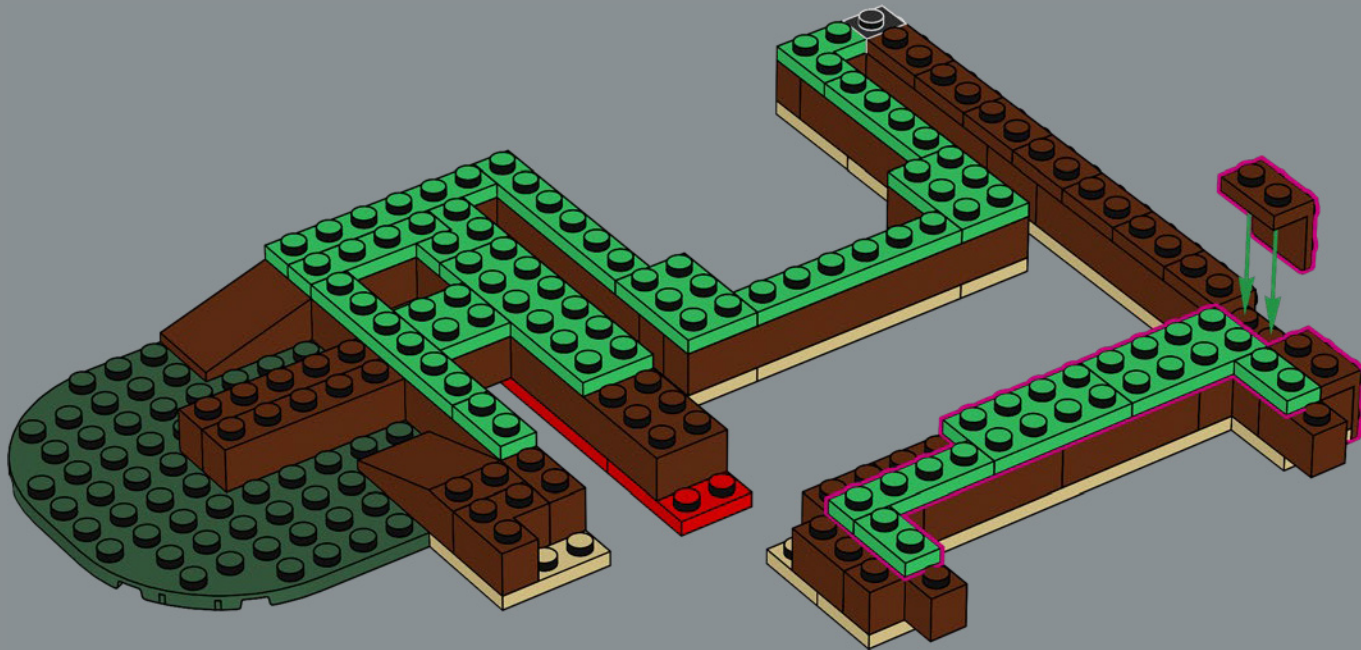

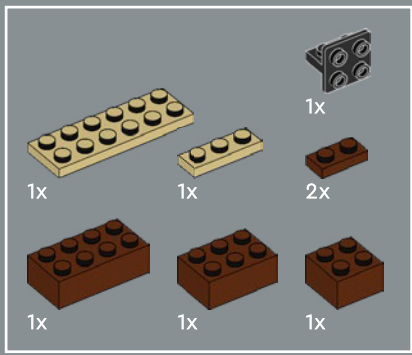

14

1

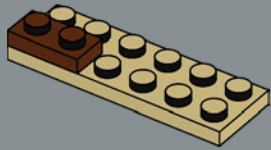

2

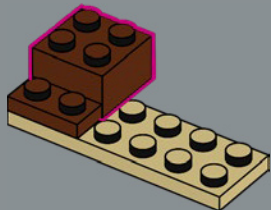

3

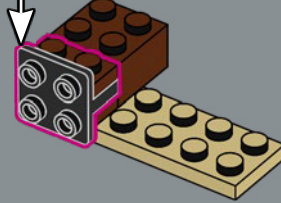
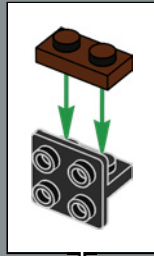

4

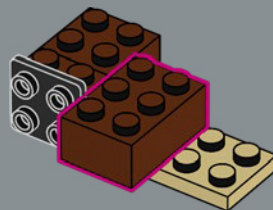

5

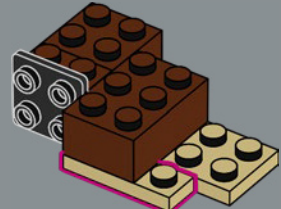

6

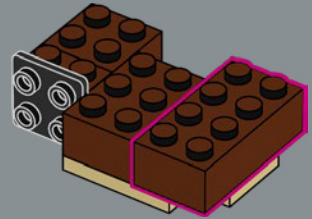

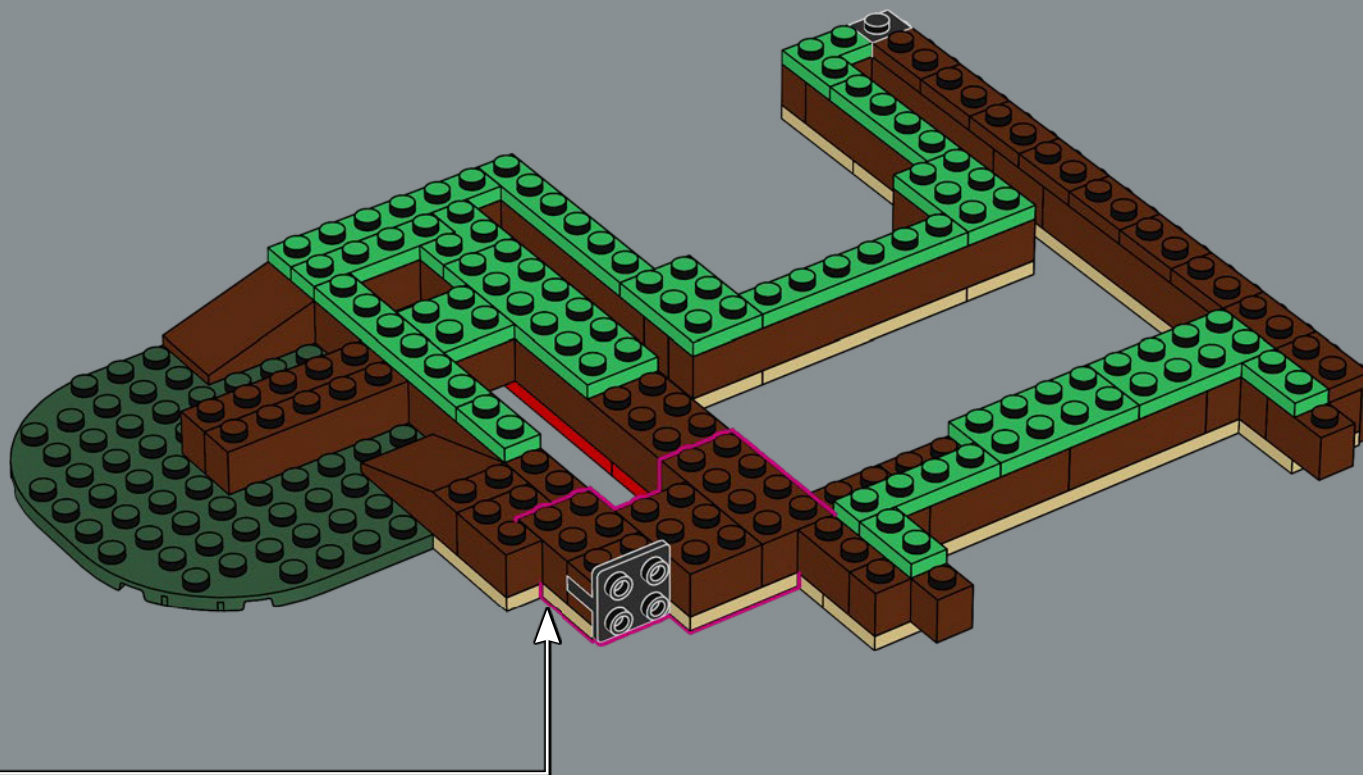

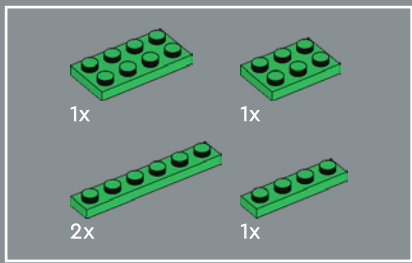

15

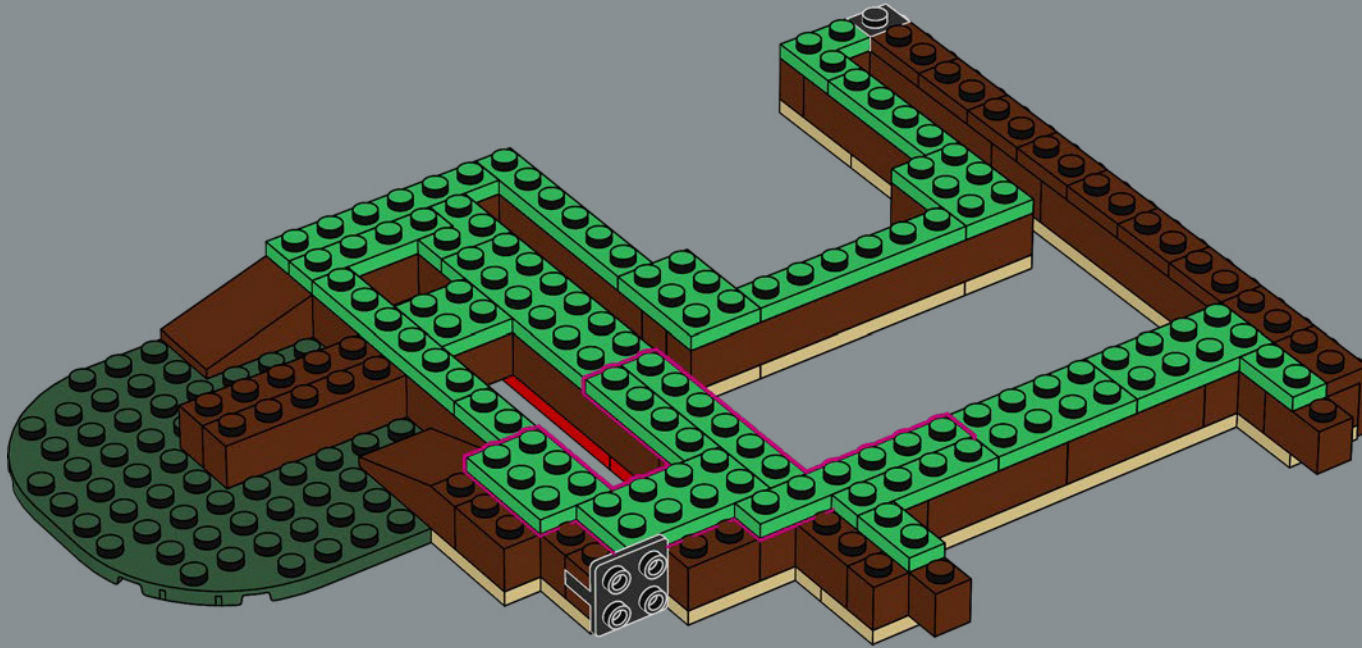

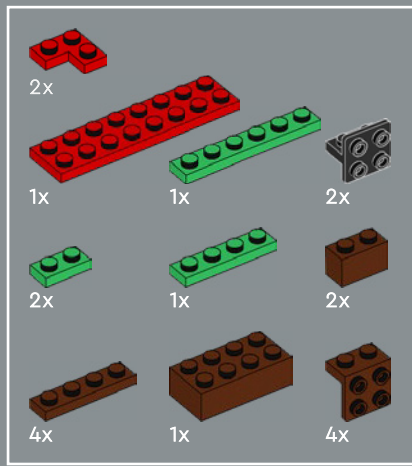

16

1

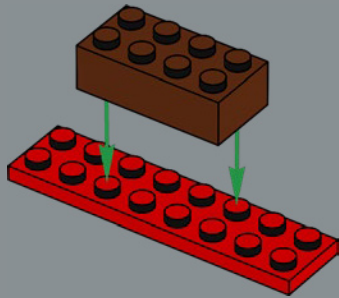

2

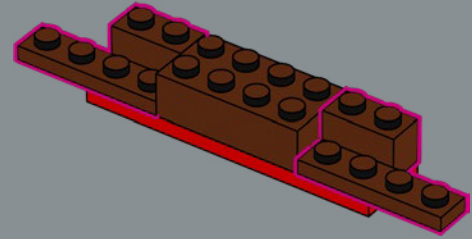

3

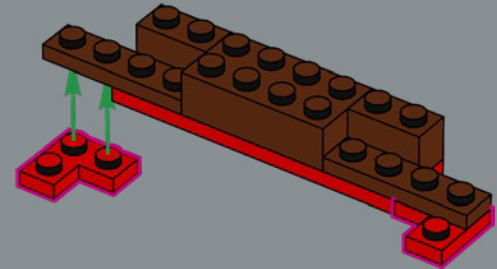

4

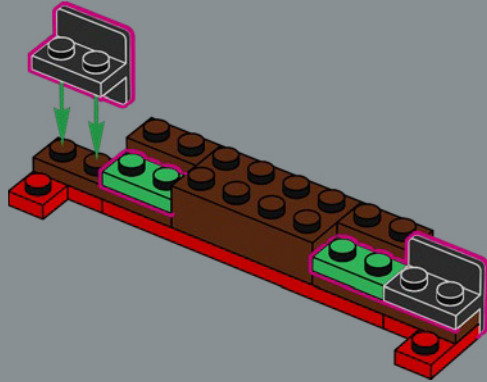

5

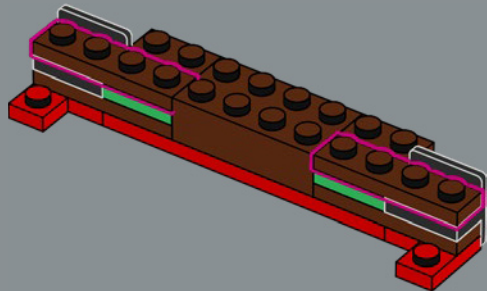

6

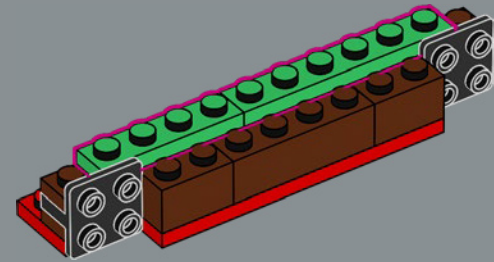

7

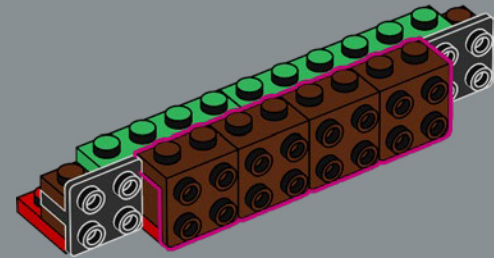

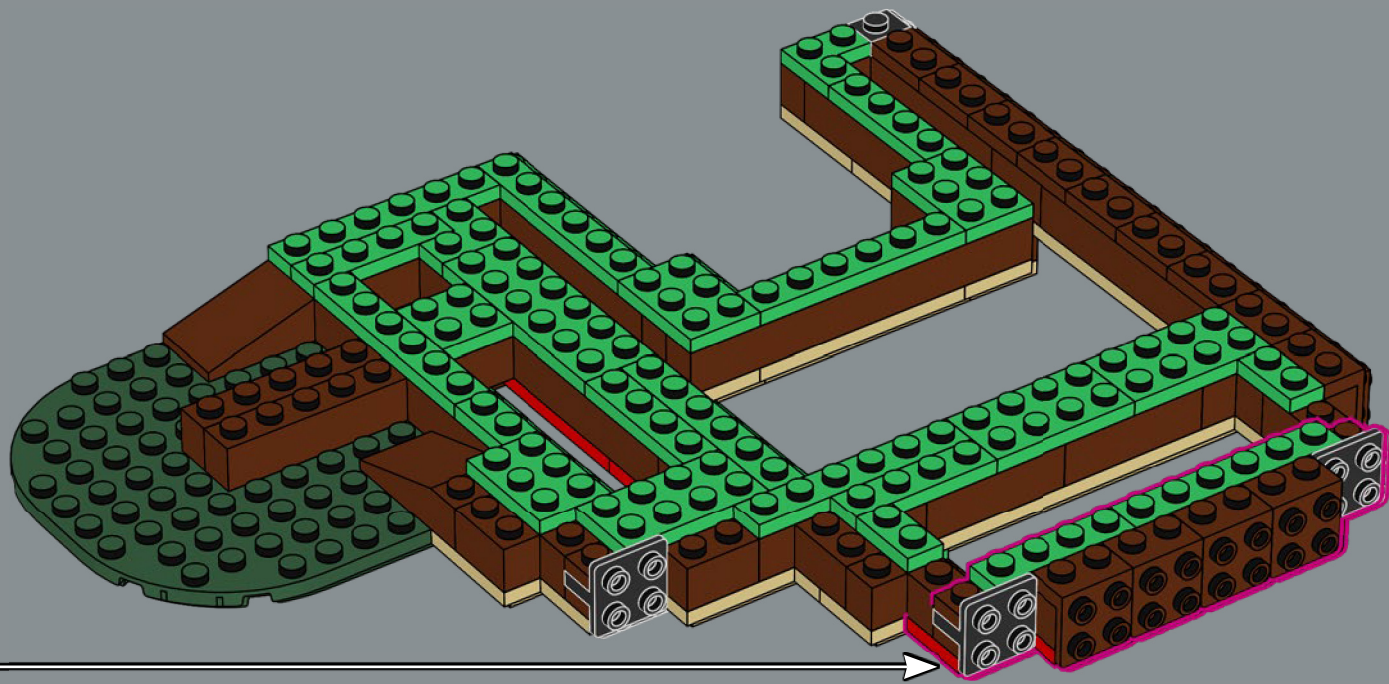



17

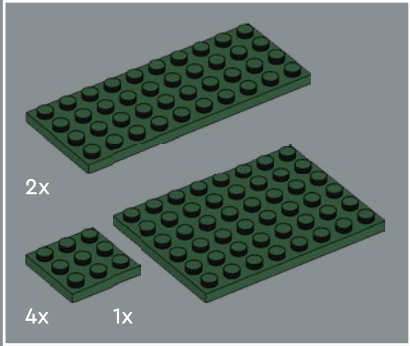
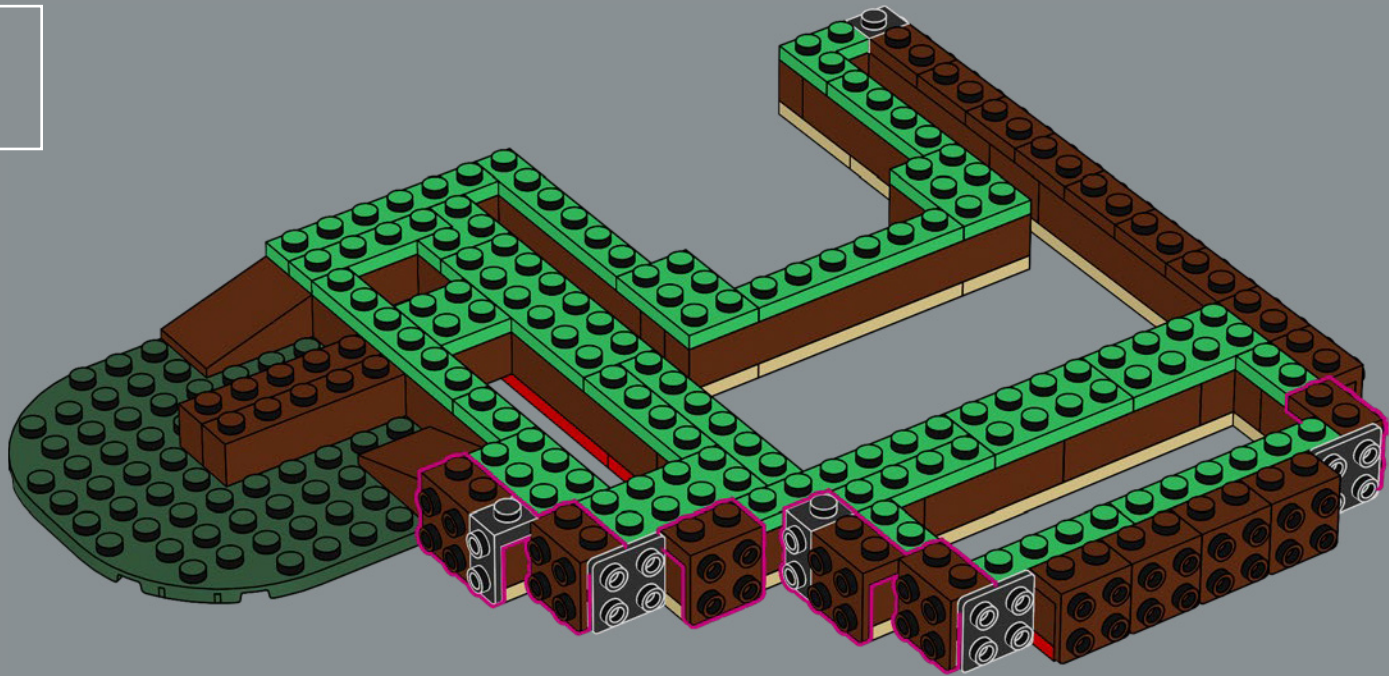

18

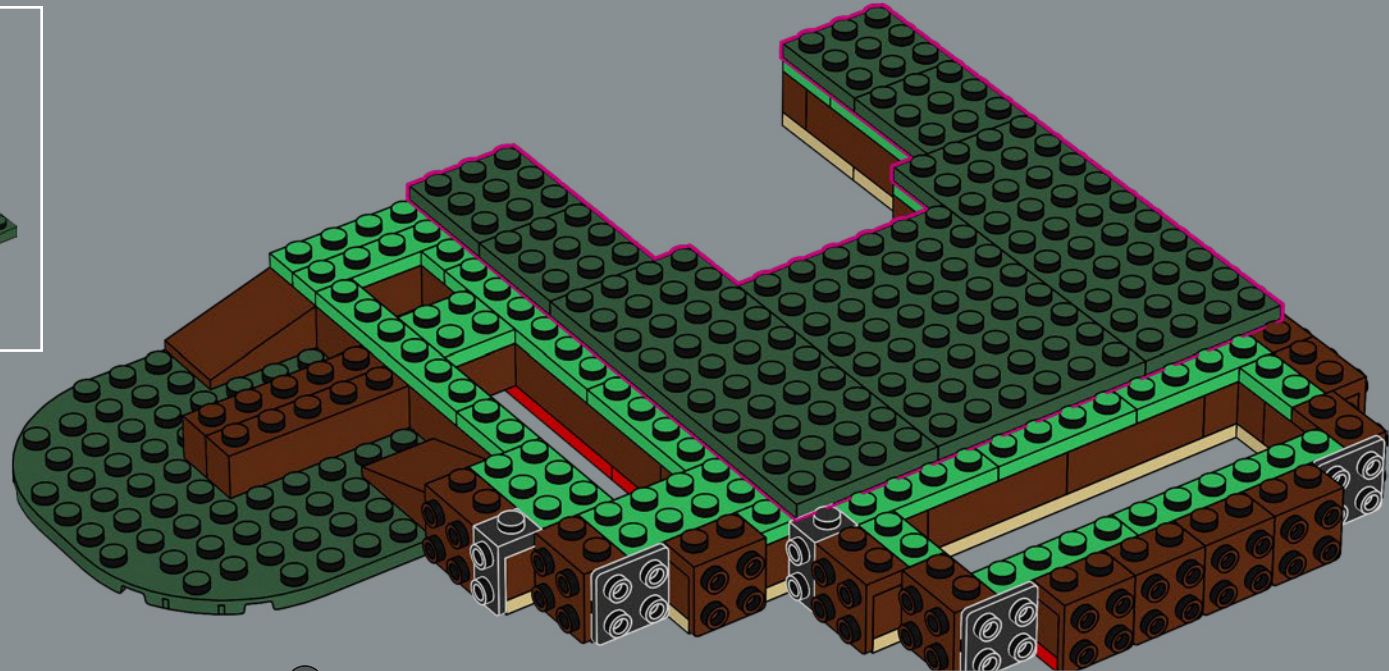

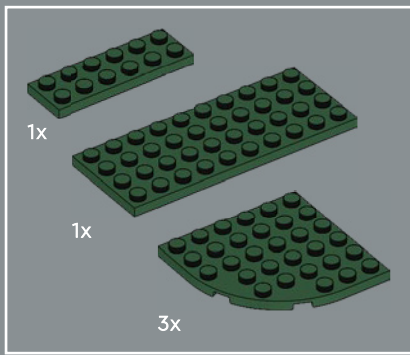

19

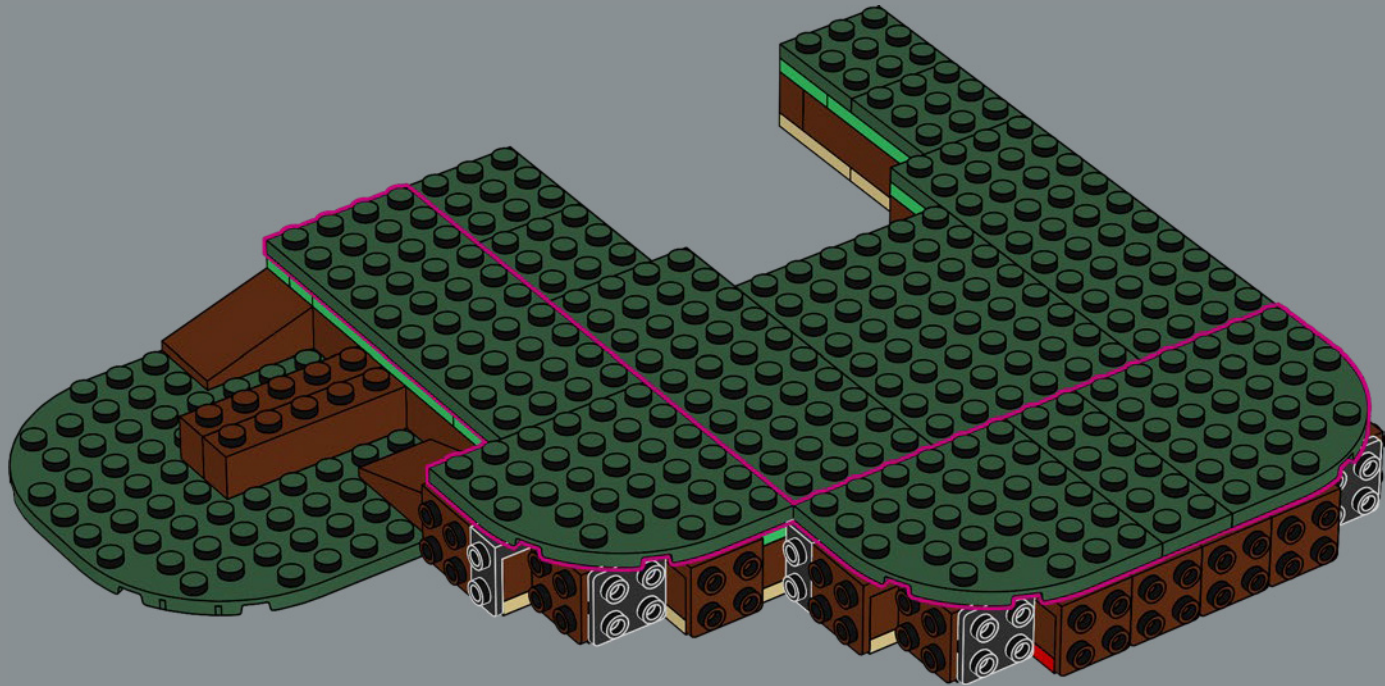

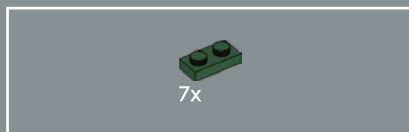

20

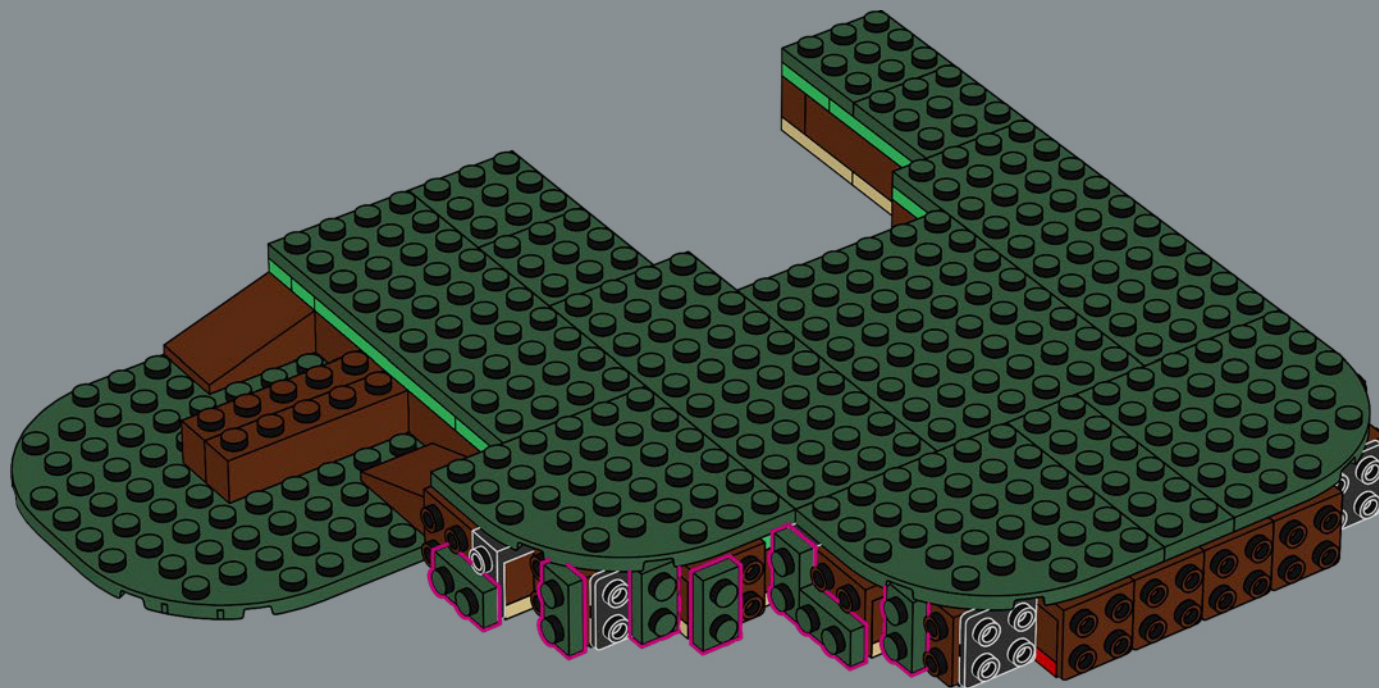



21

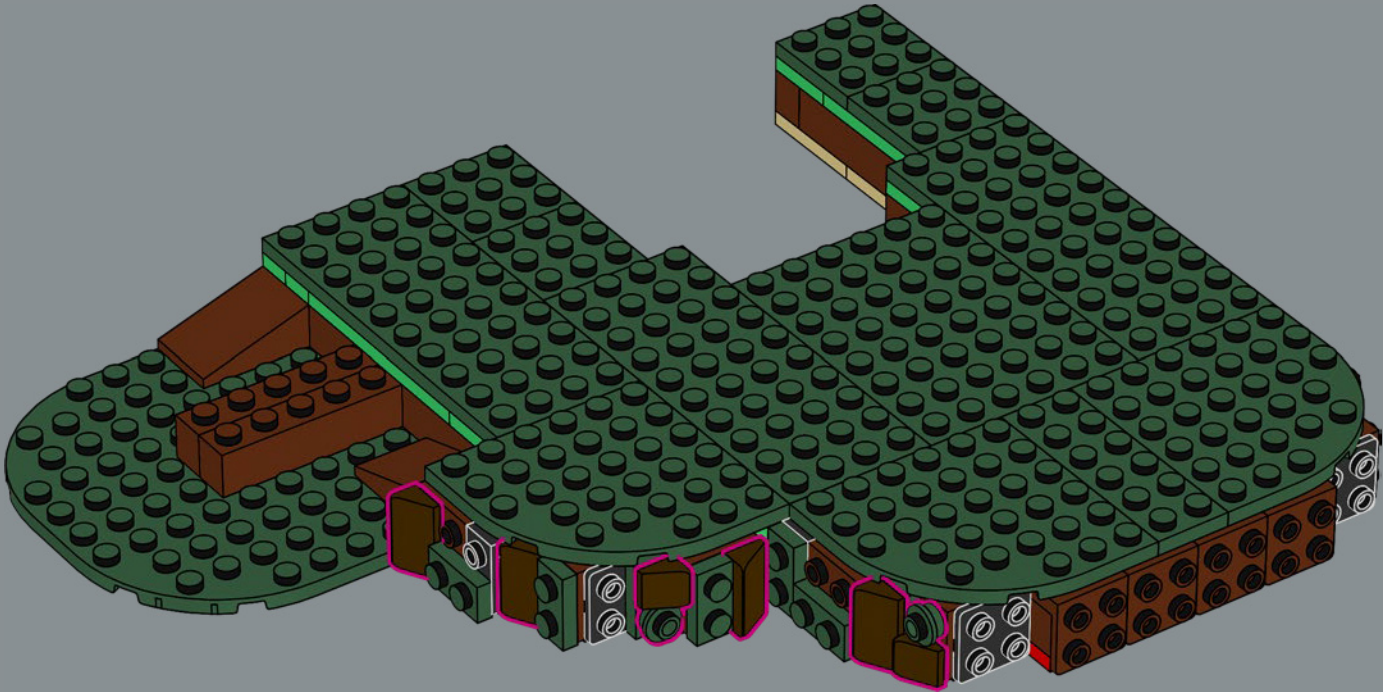



22

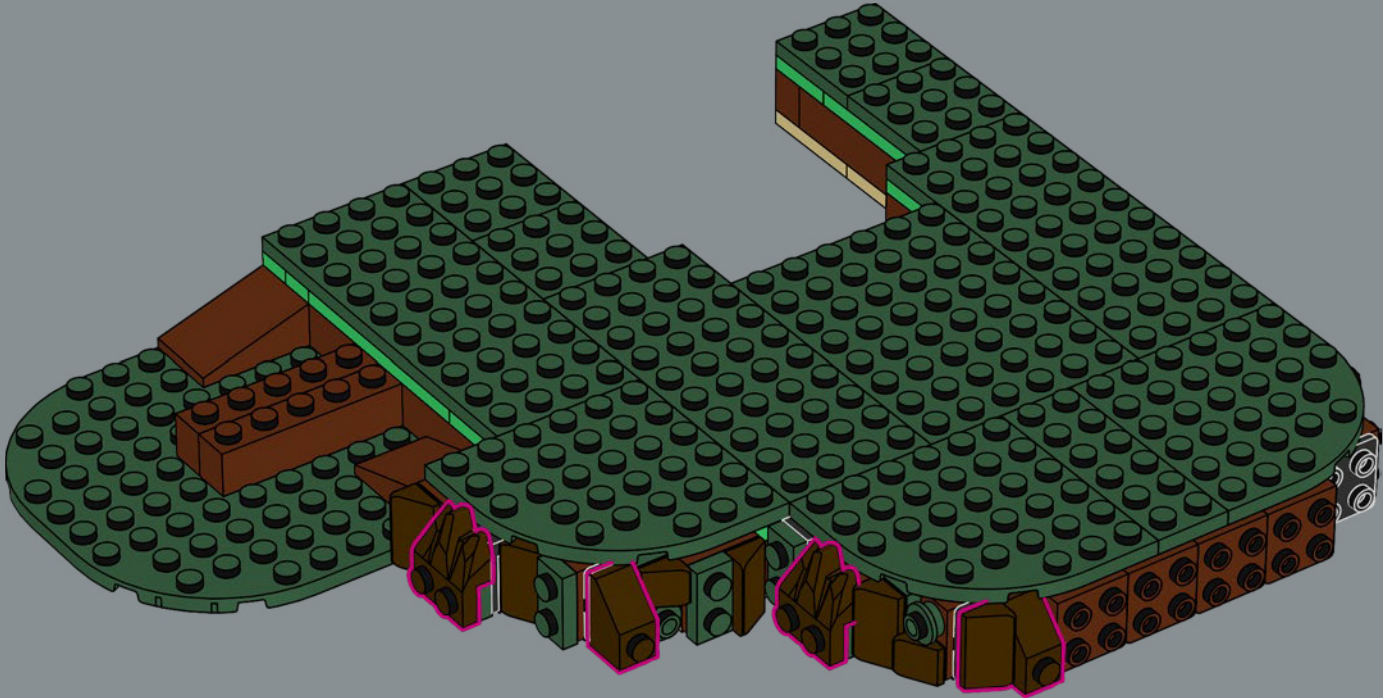

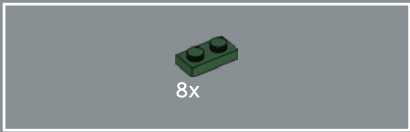

23

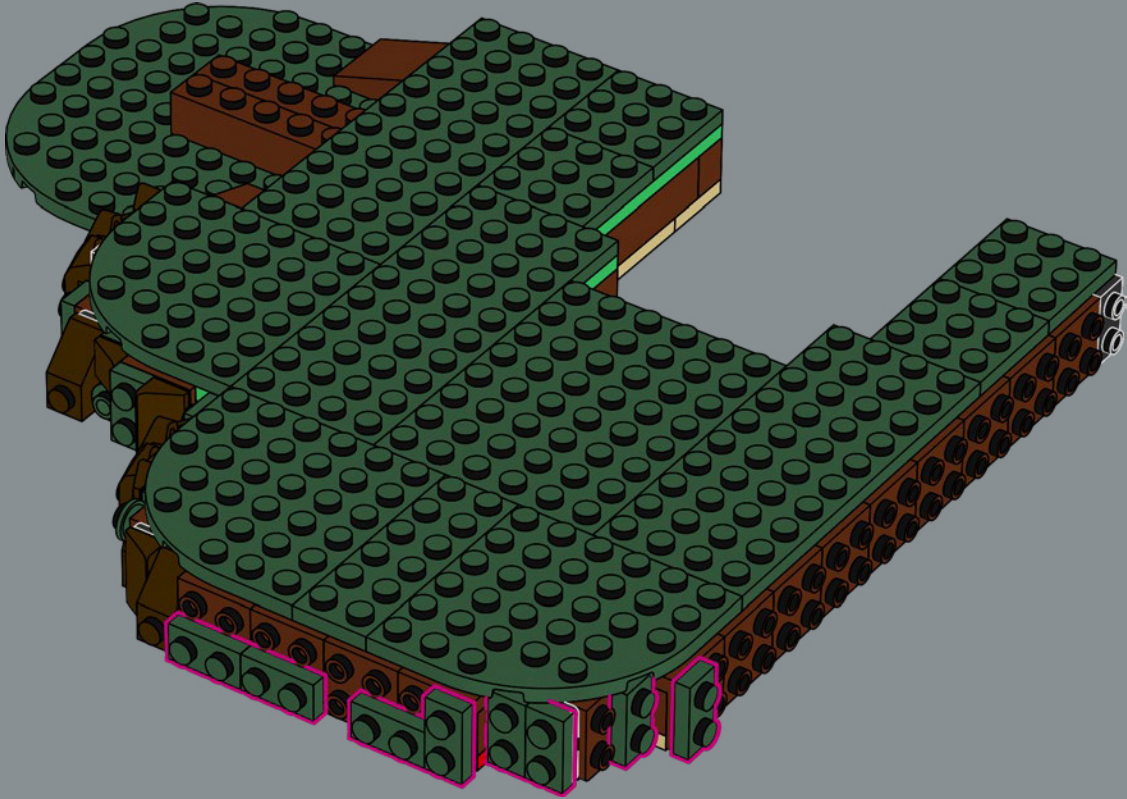

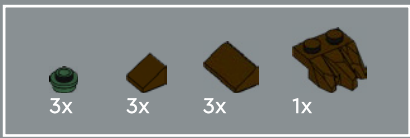

24

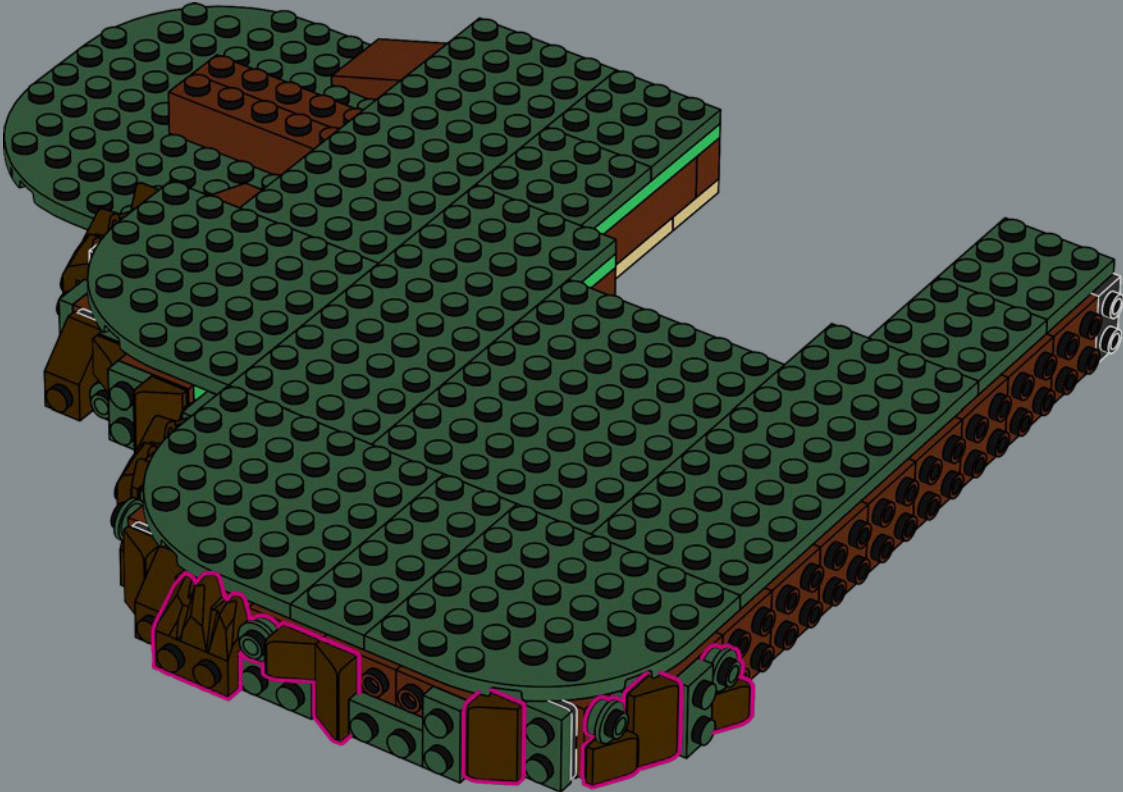



25

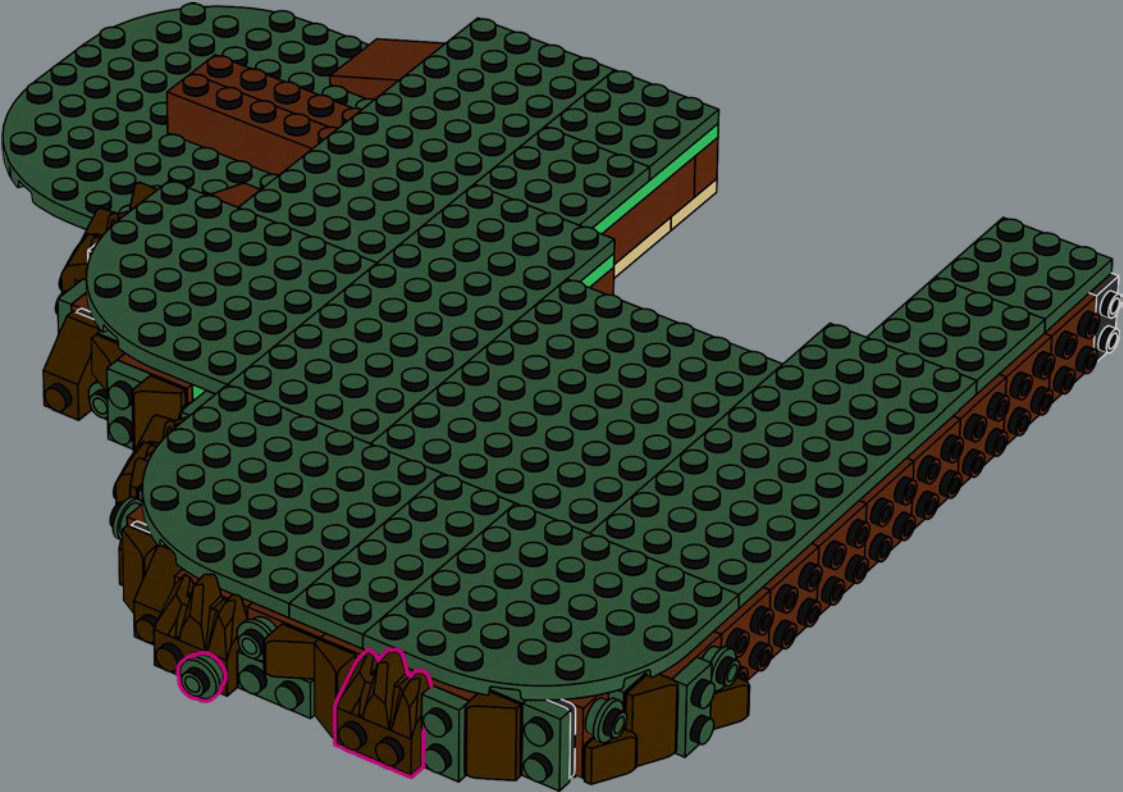

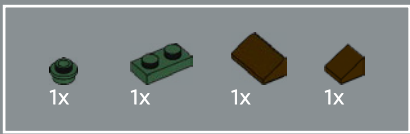

26

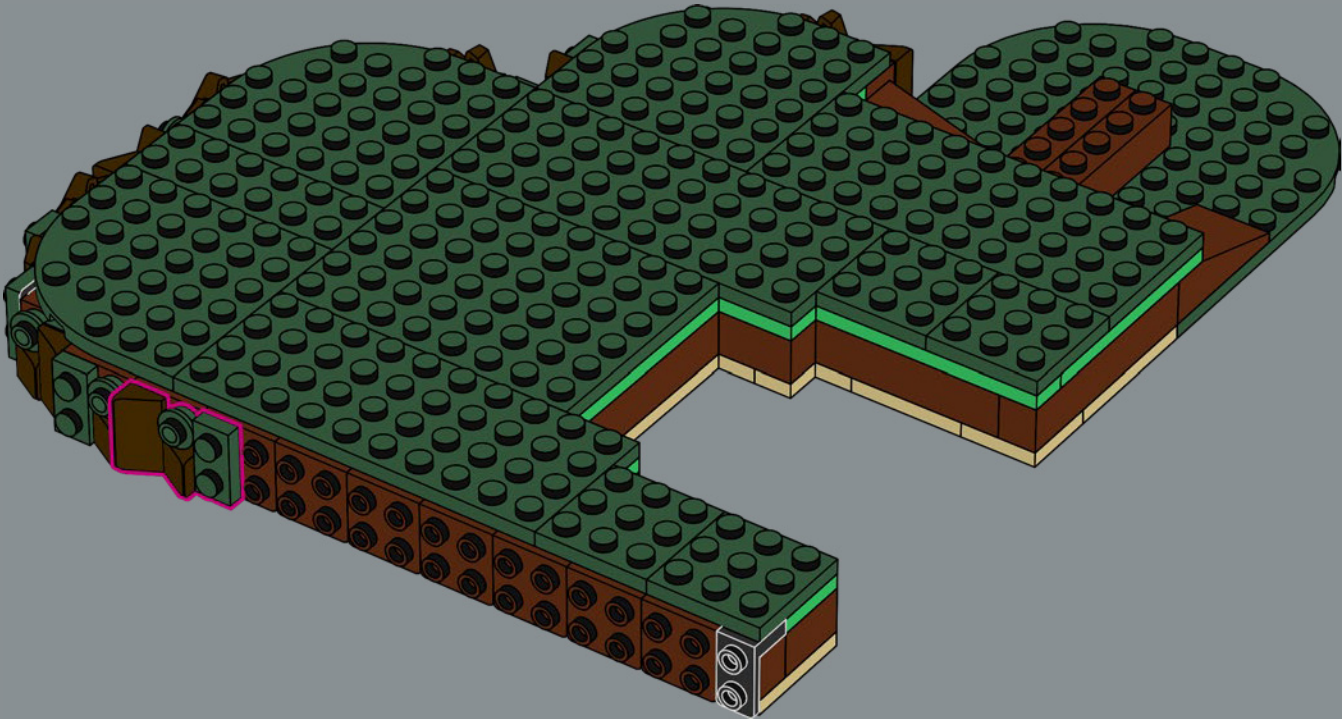

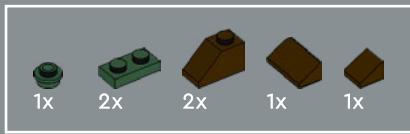

27



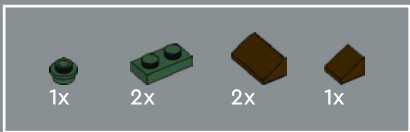

28

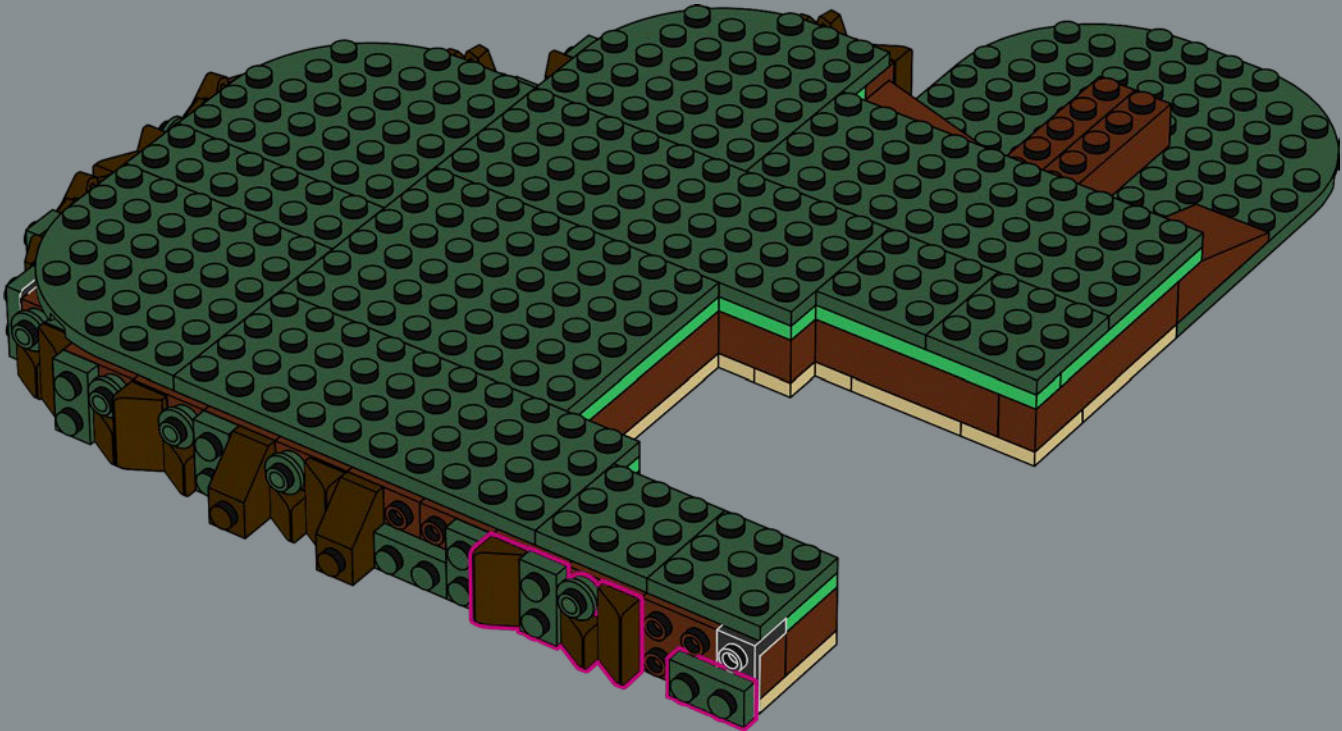

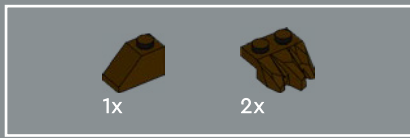

29

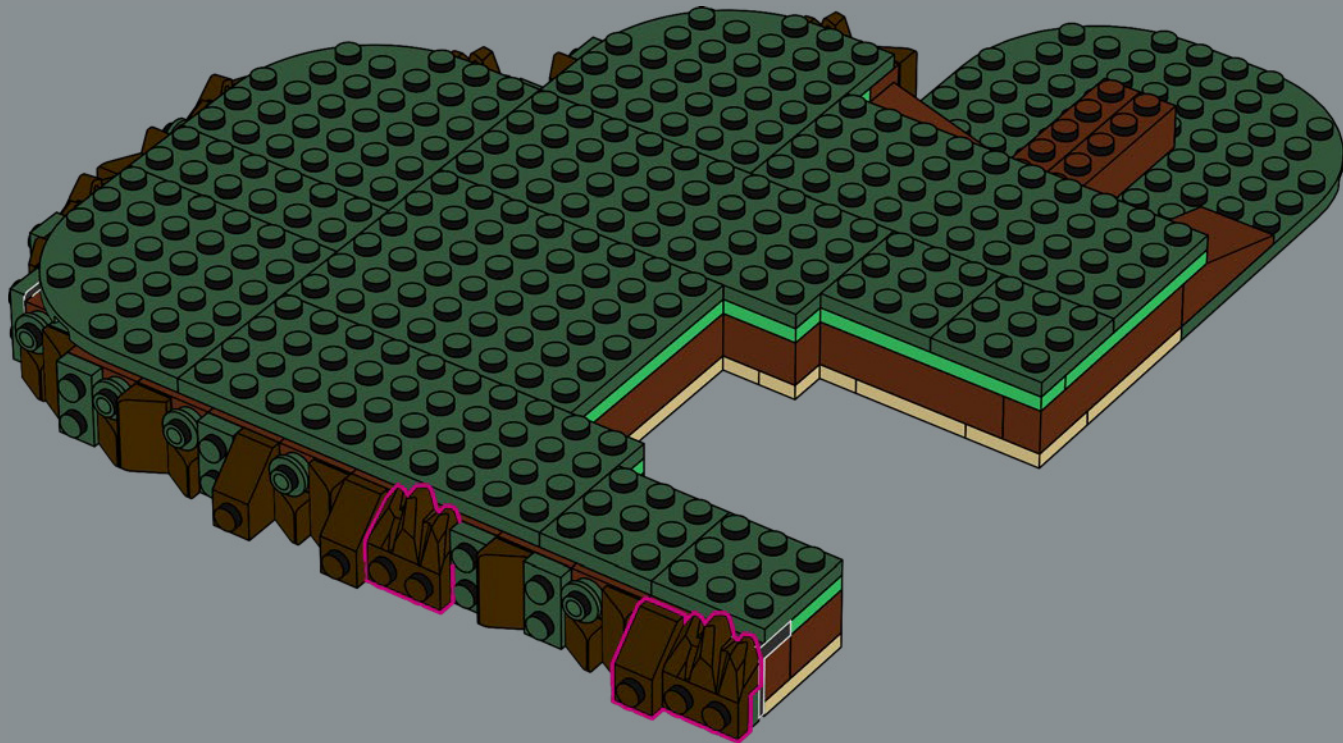

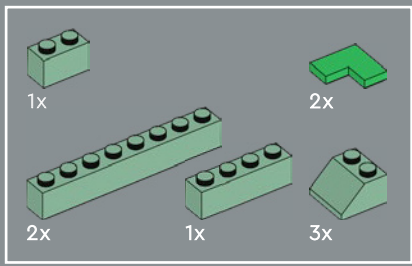

30

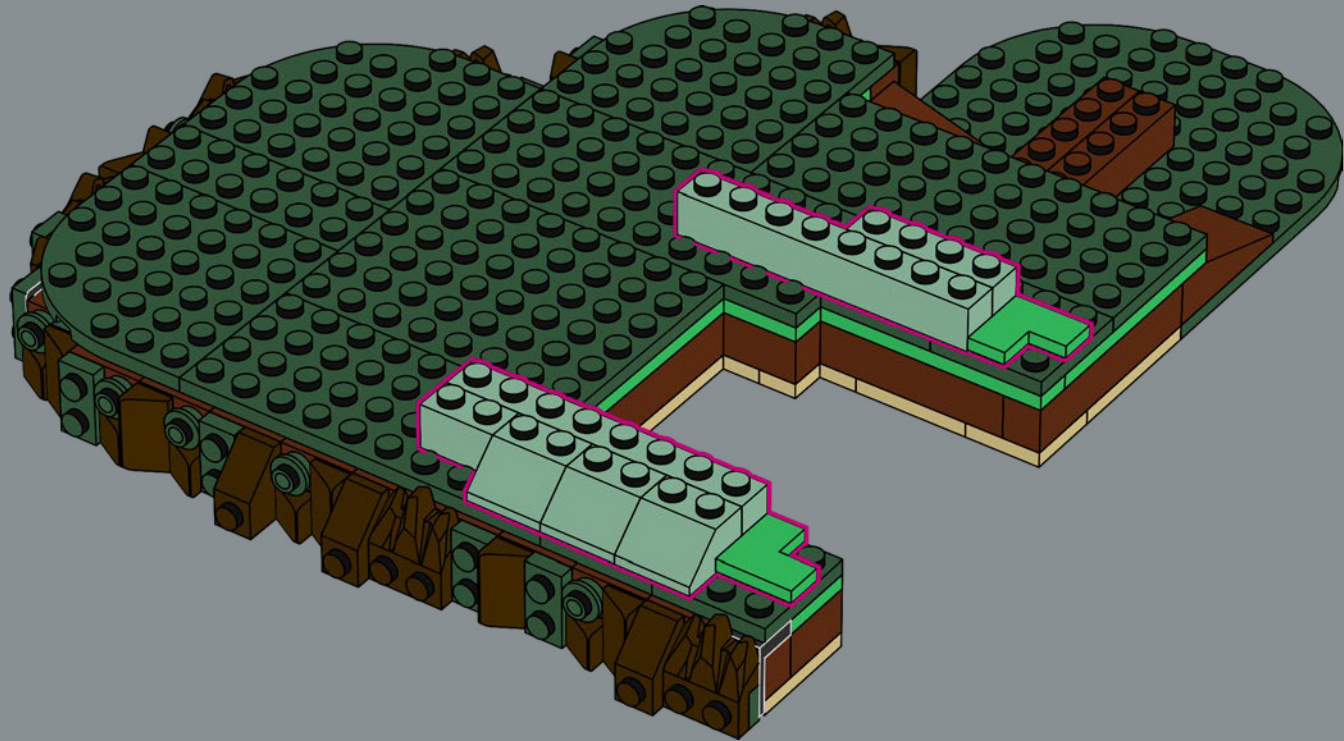

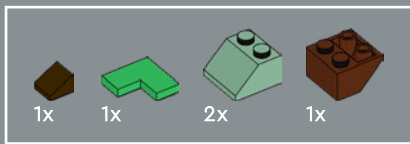

31

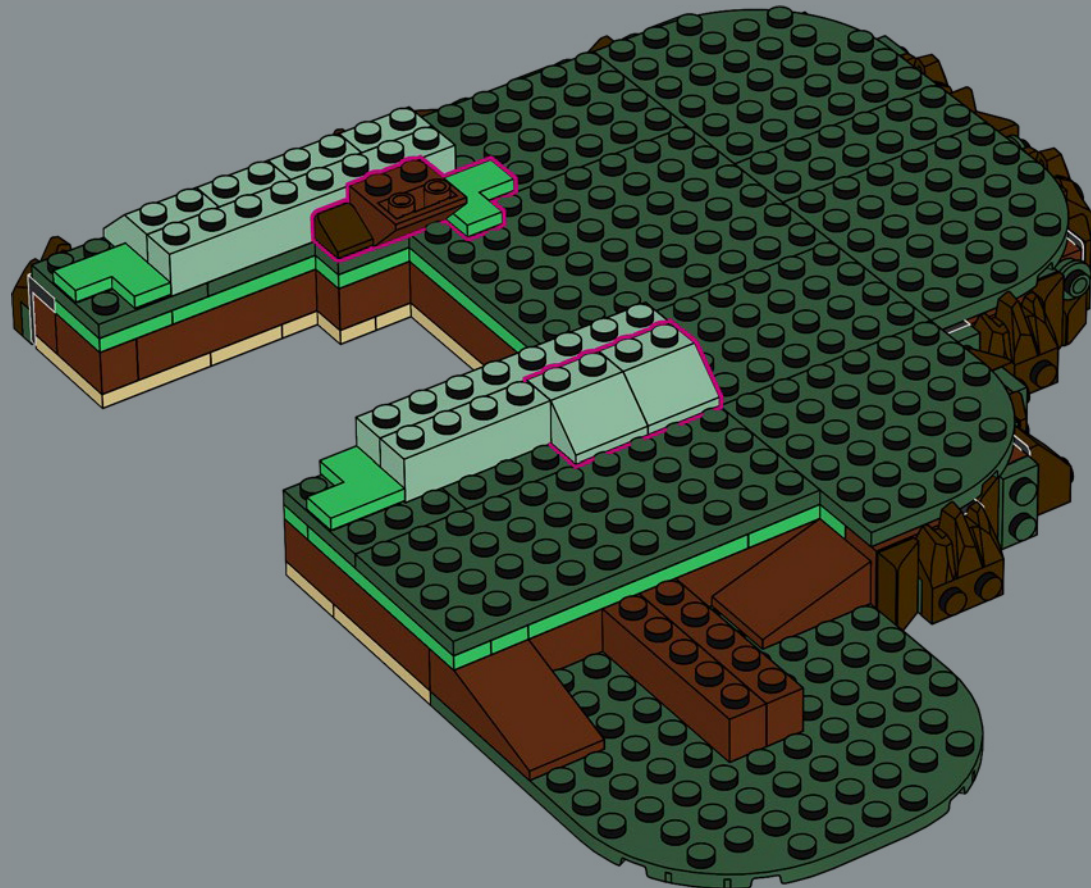

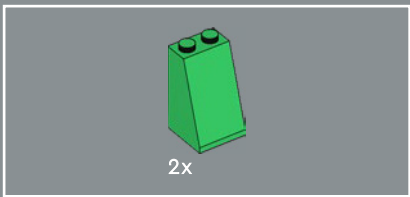

32

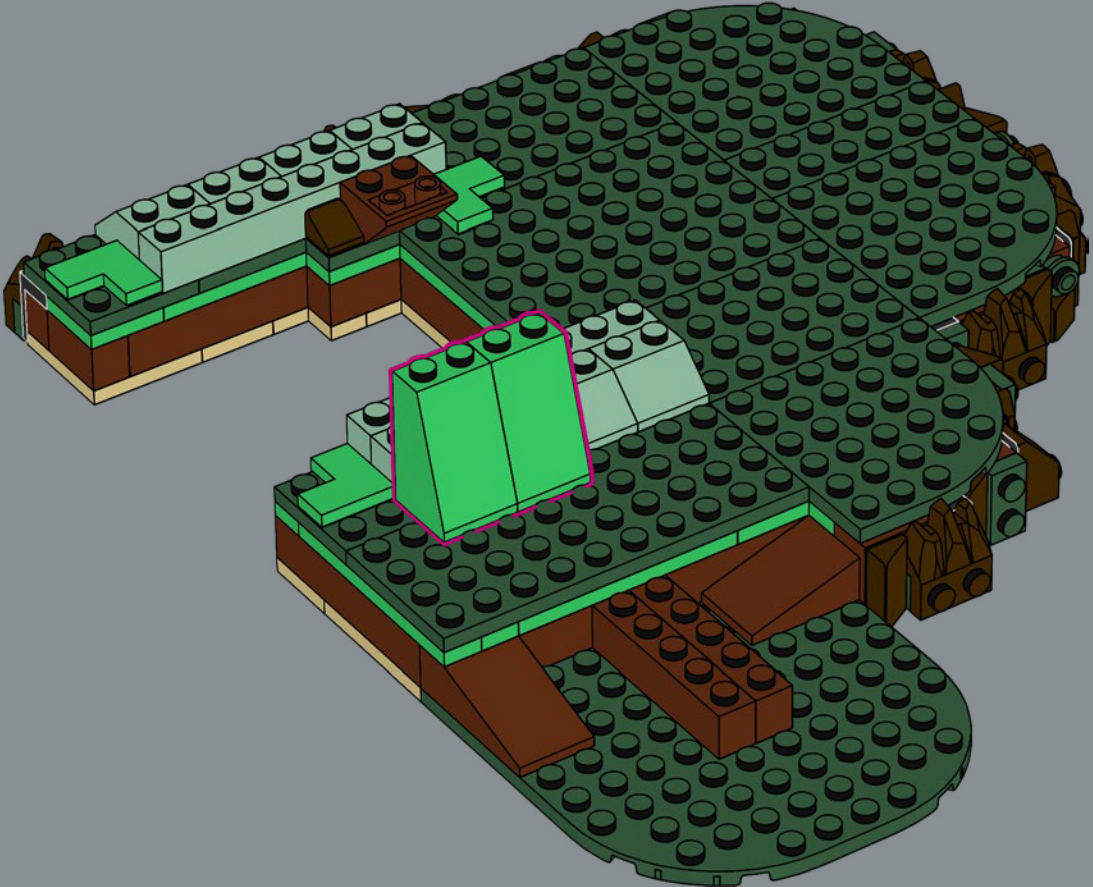

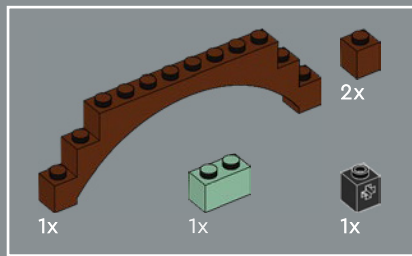

33

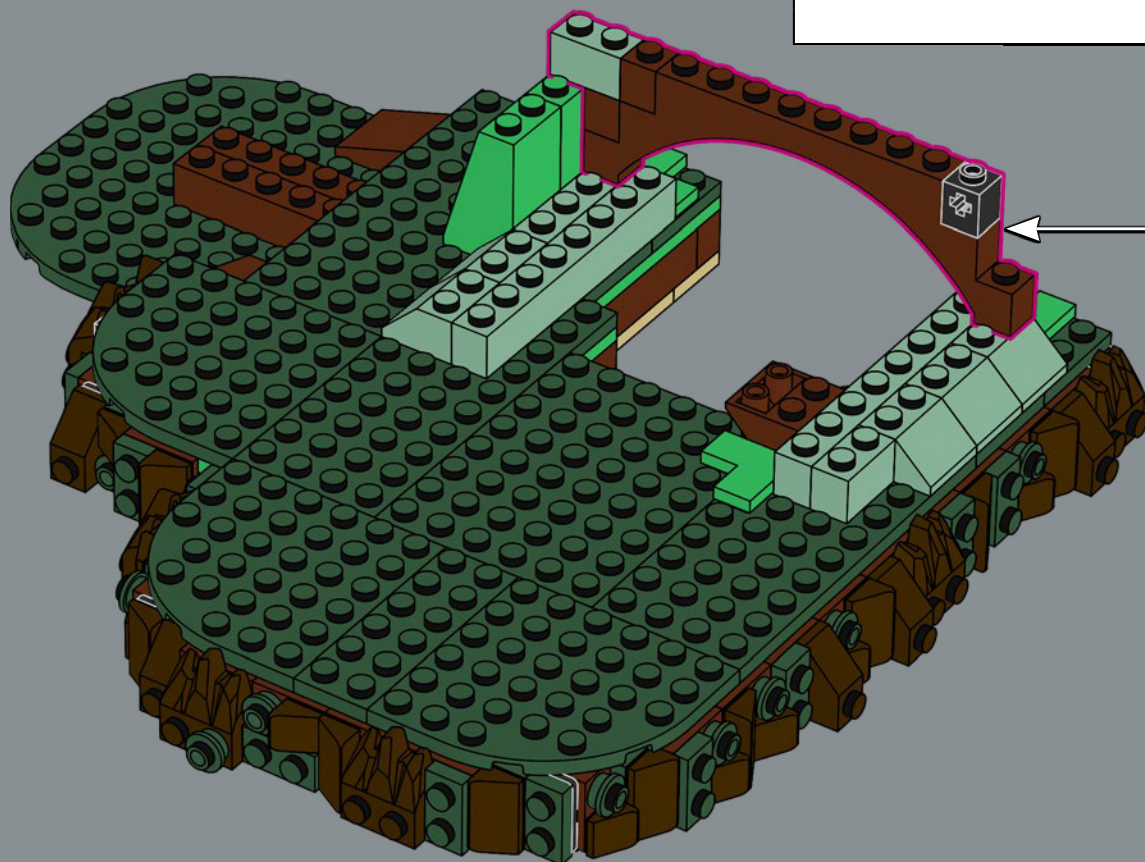
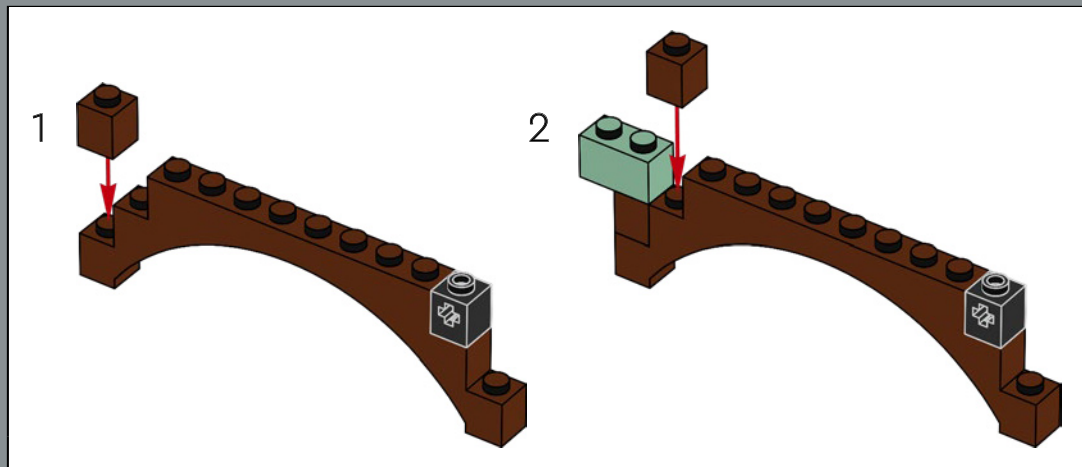

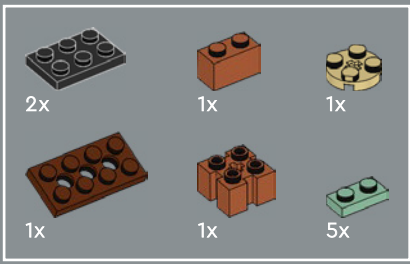

34

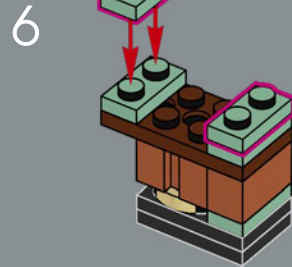
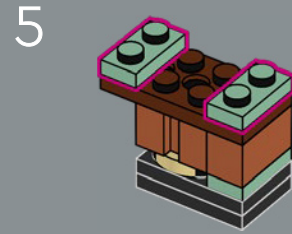
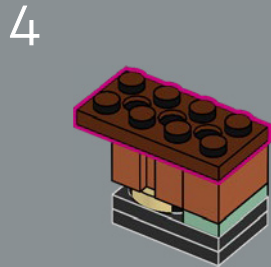
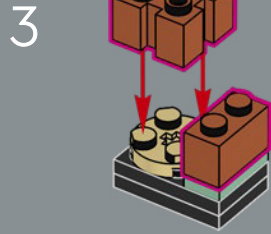
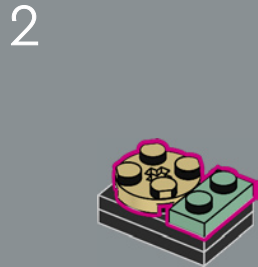
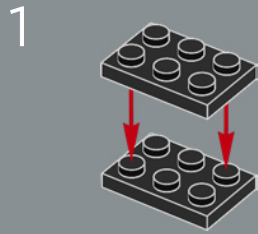



35

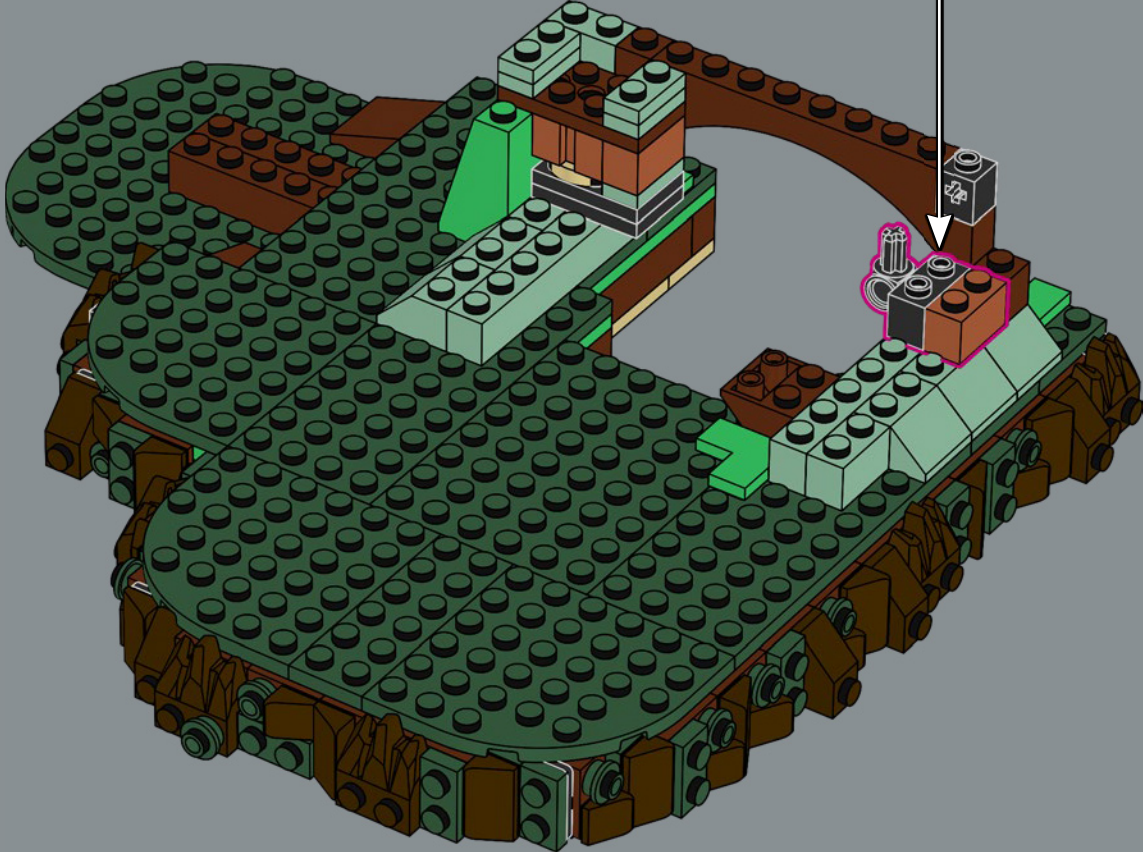
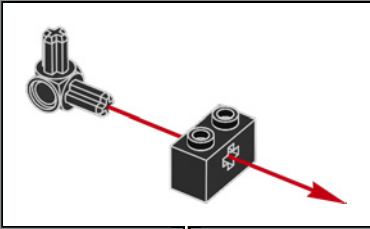



36

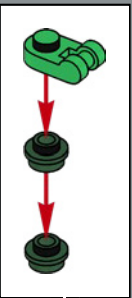
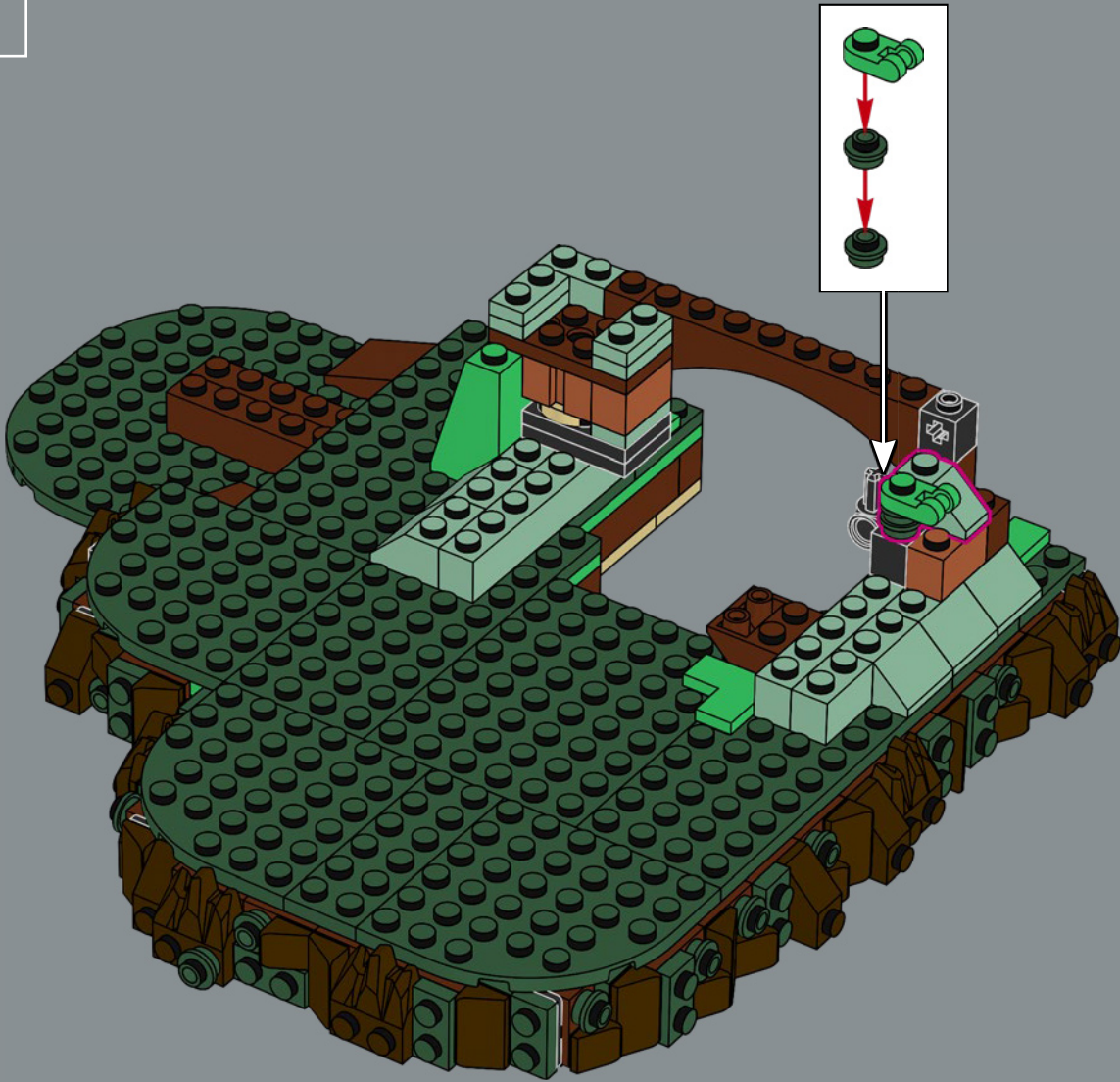

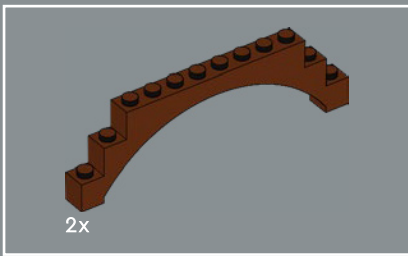

37

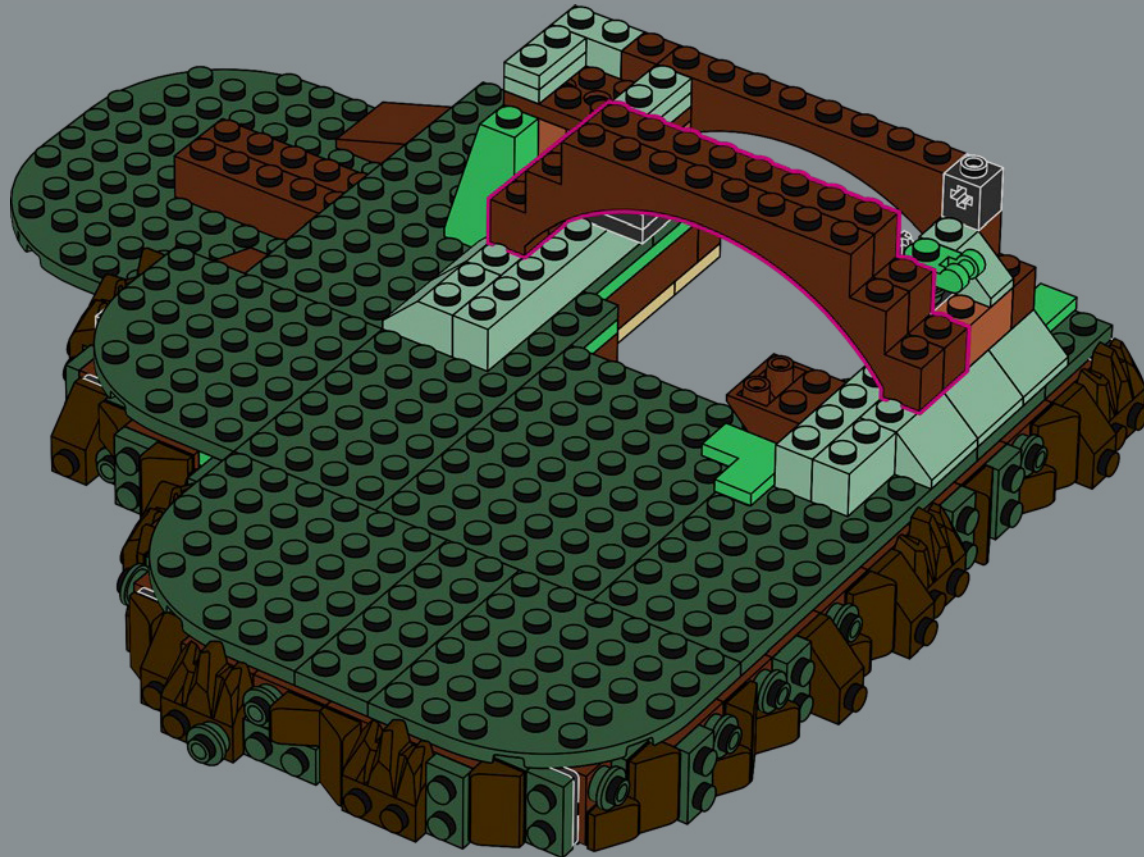



2x

38

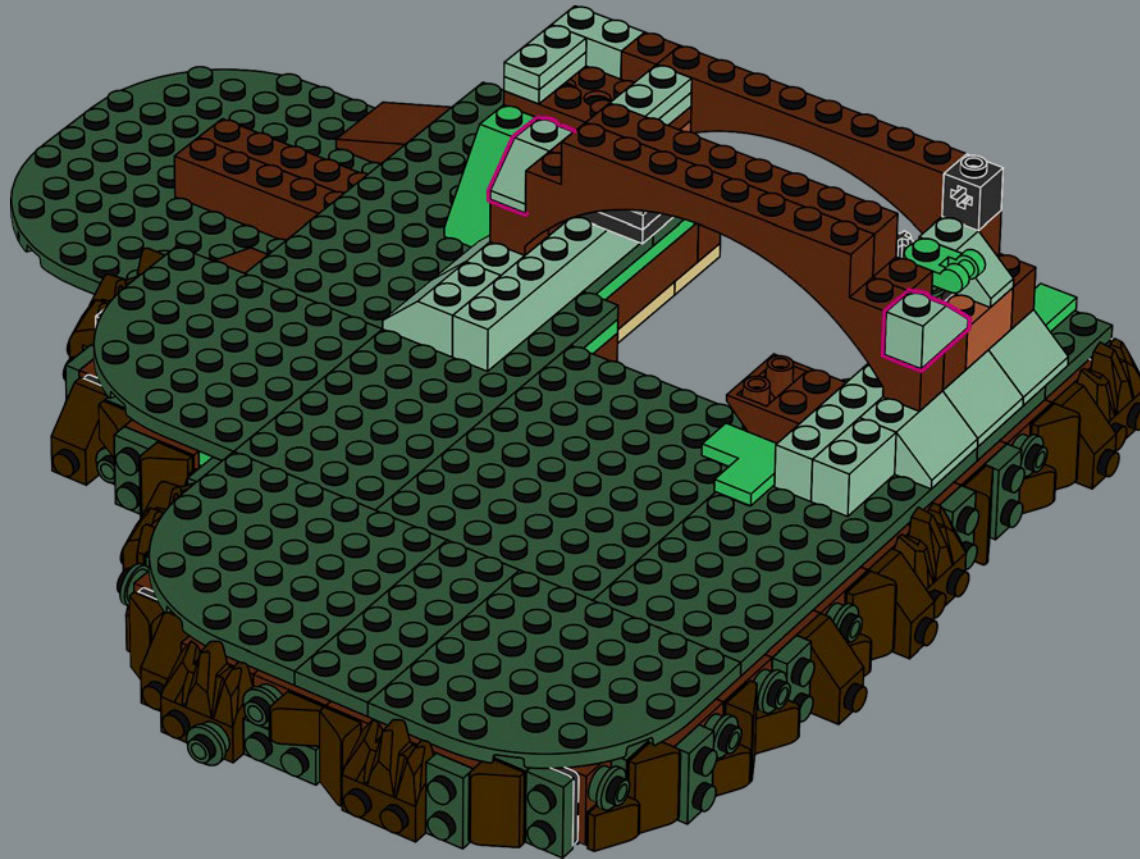

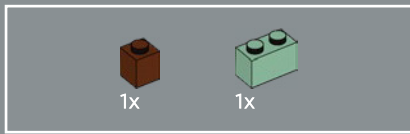

39

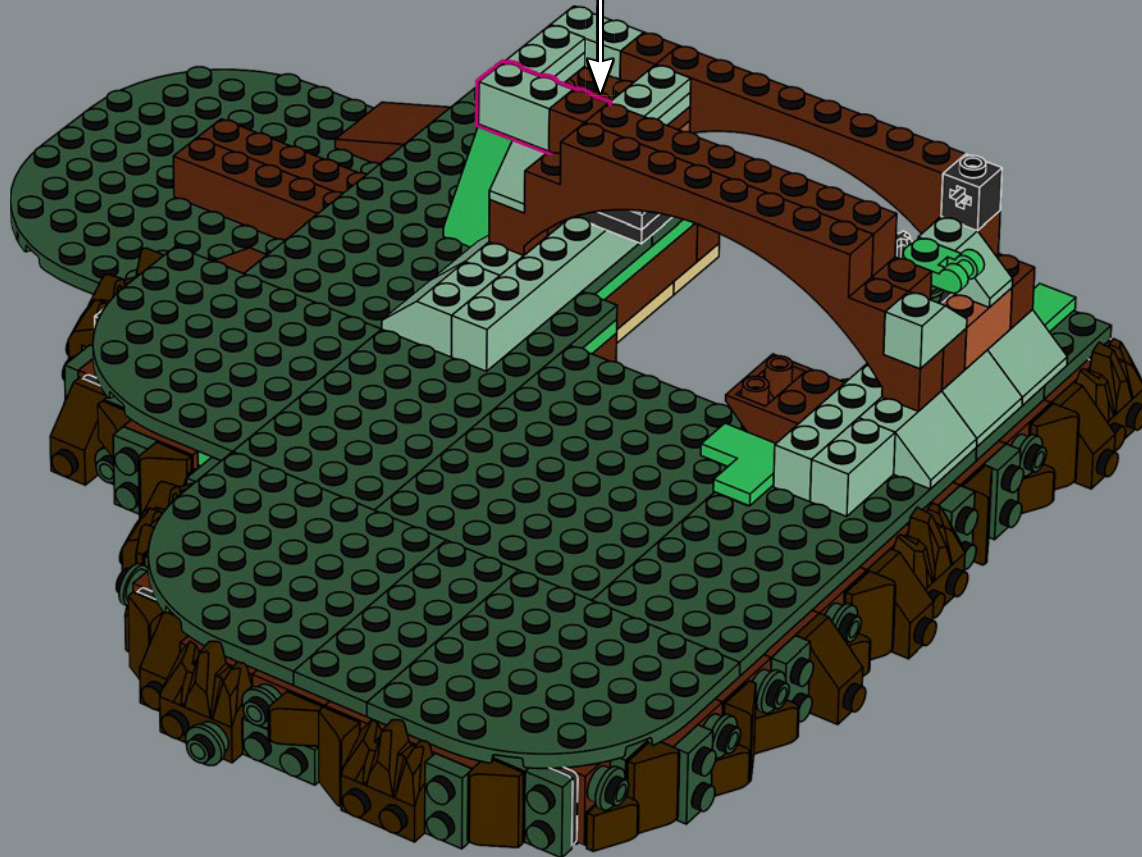
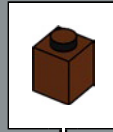

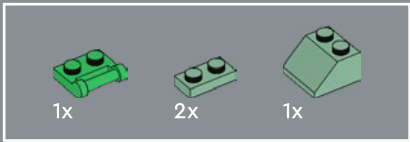

40

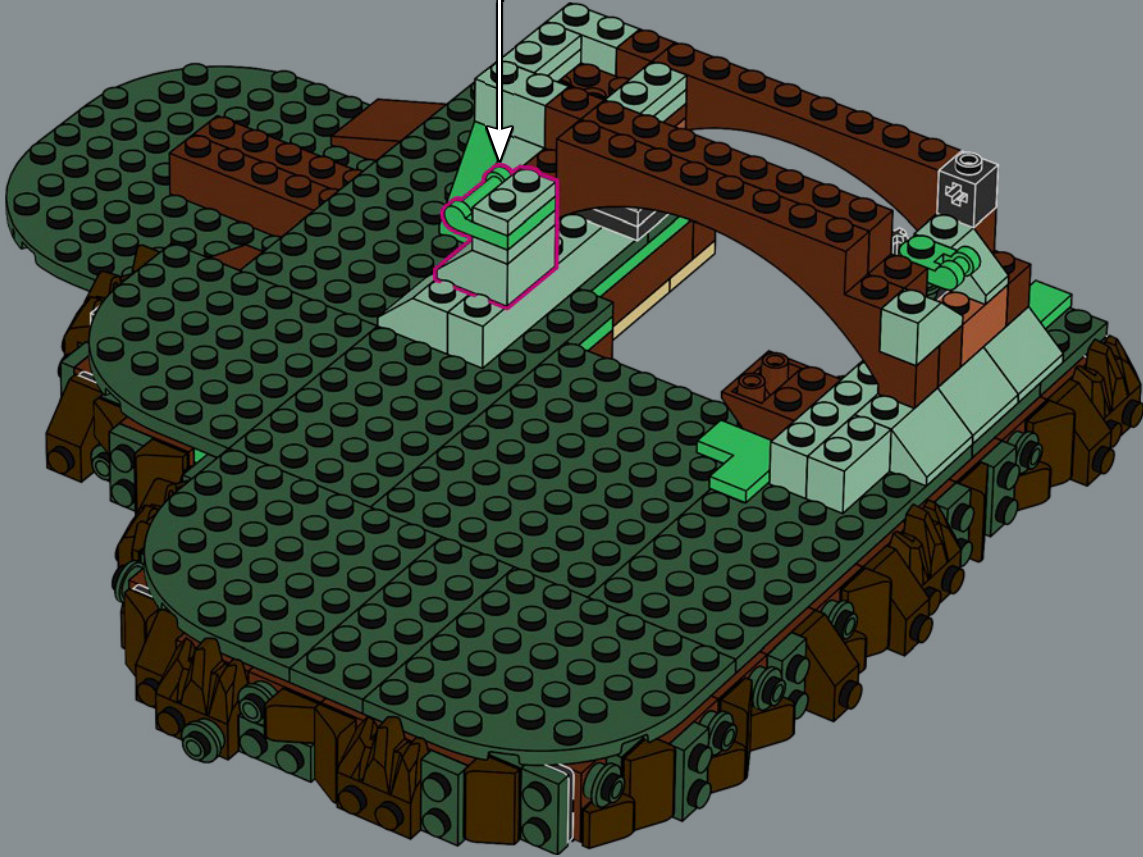
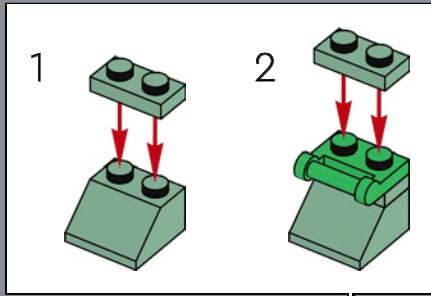

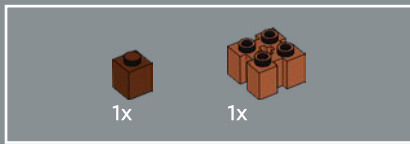

41

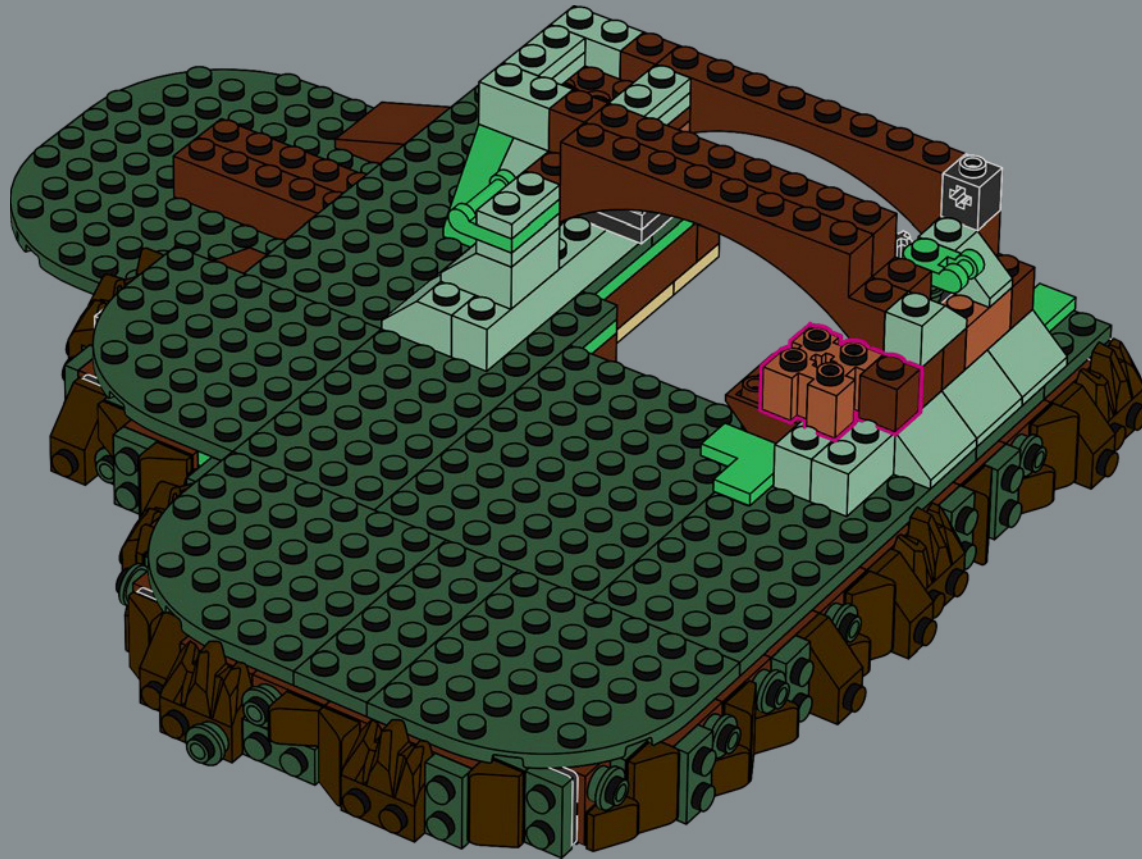

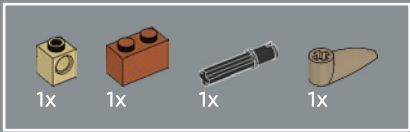

42

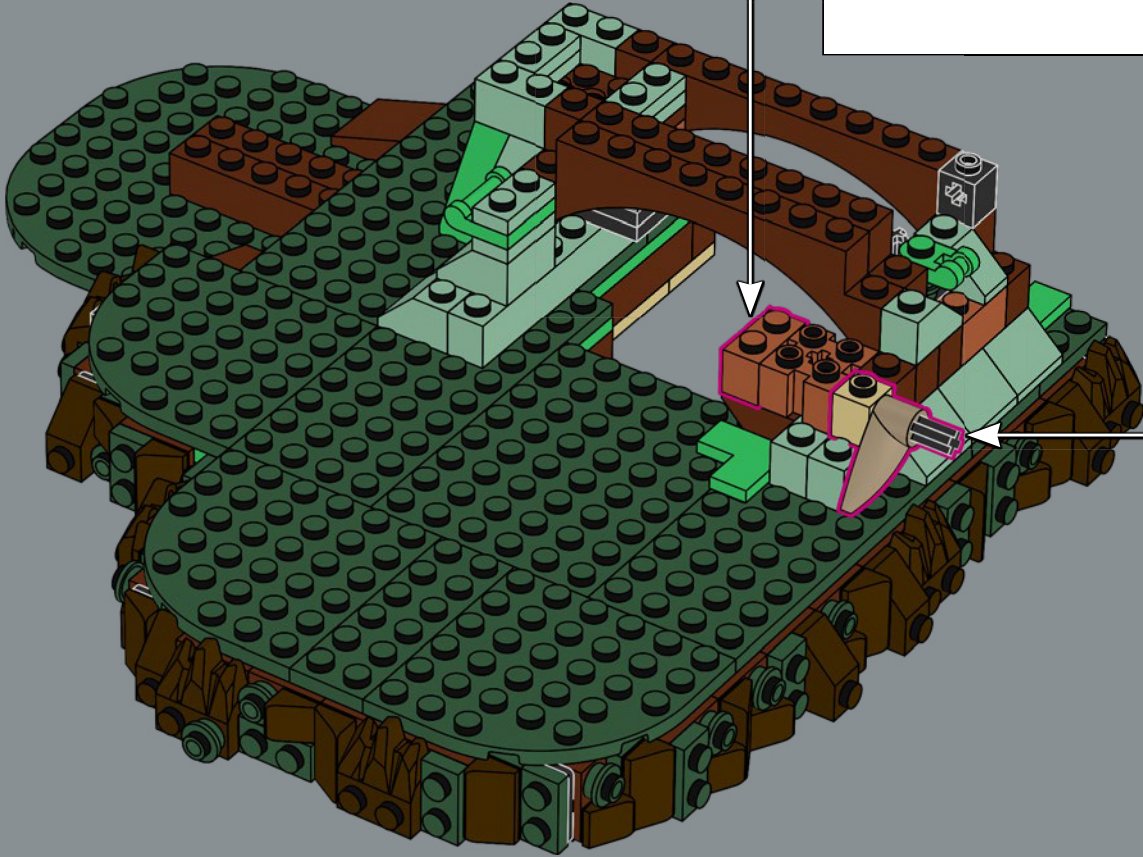
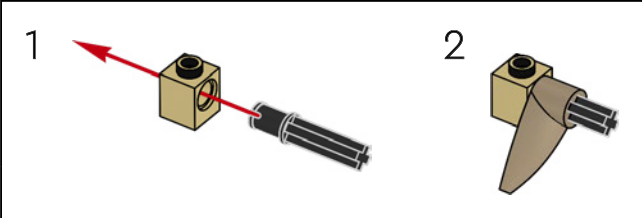
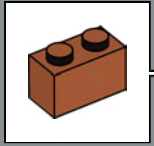

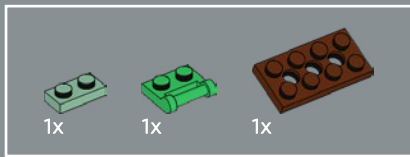

43

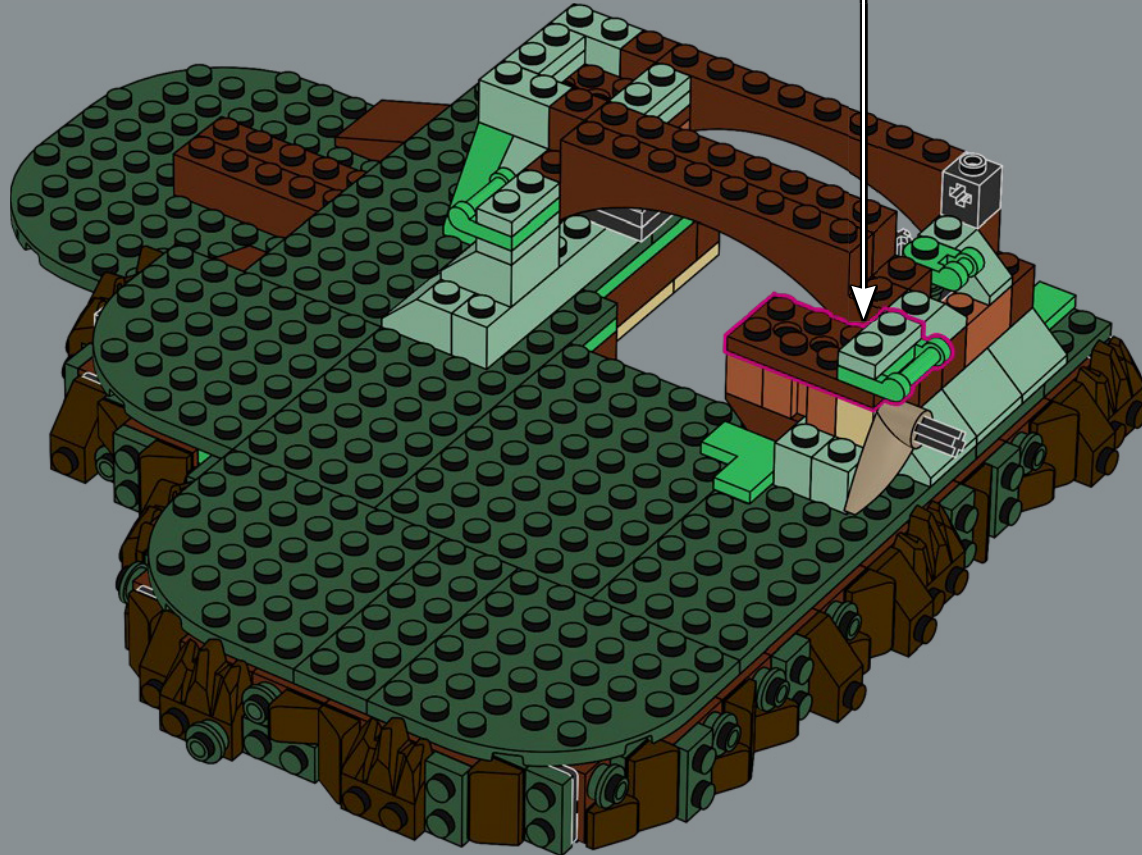
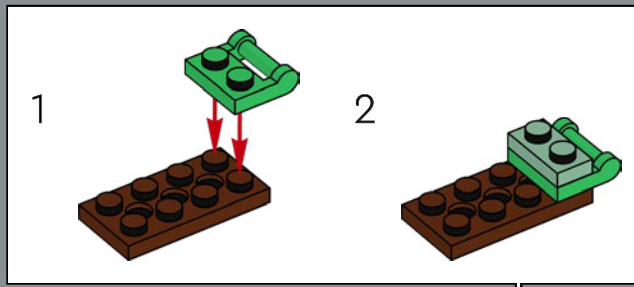

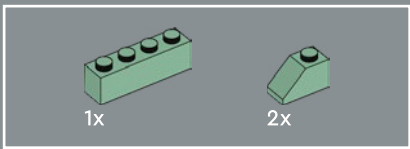

44

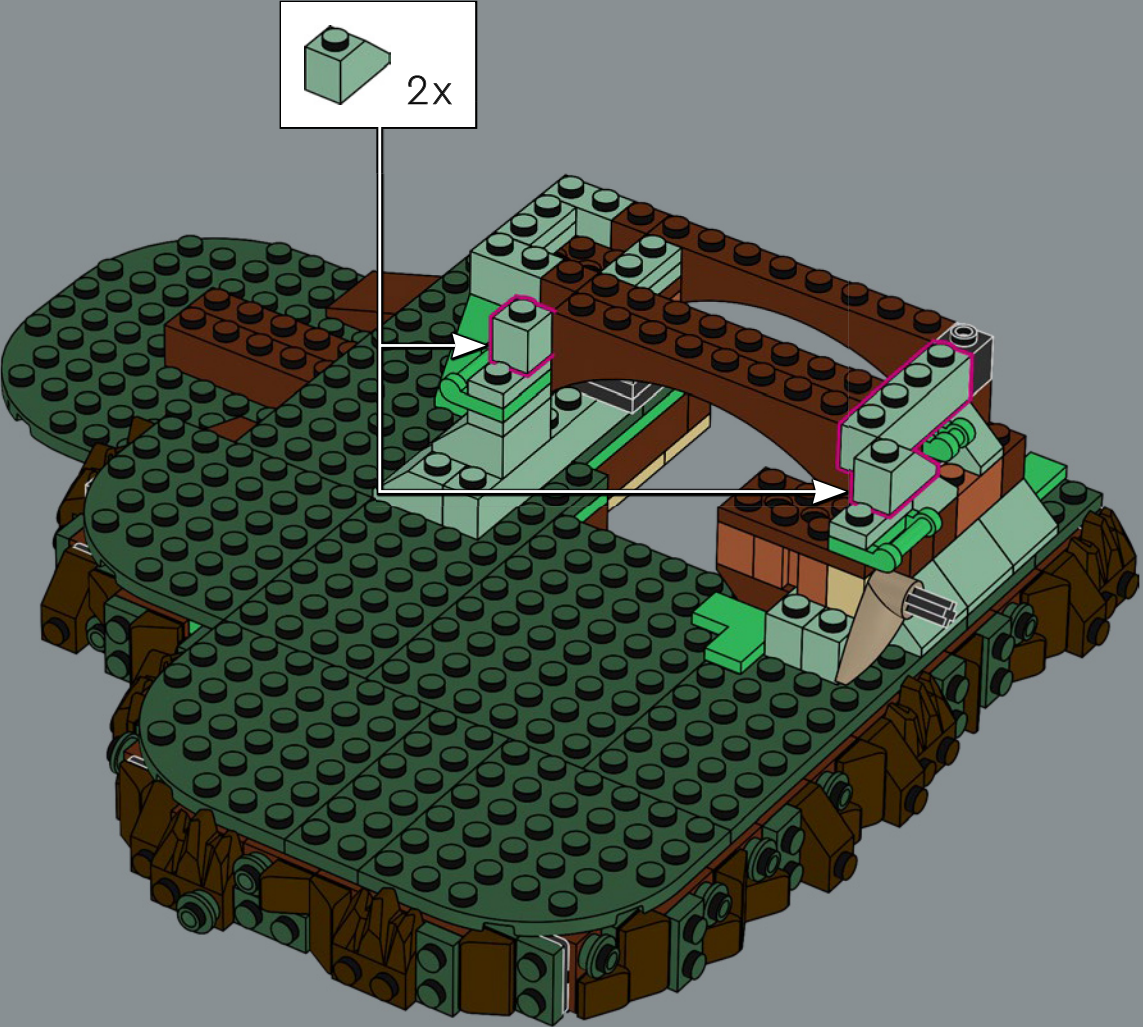

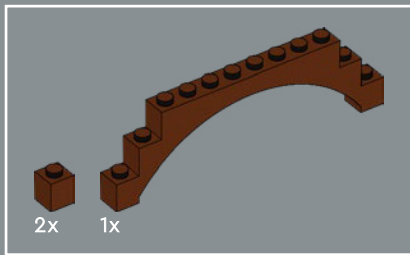

45

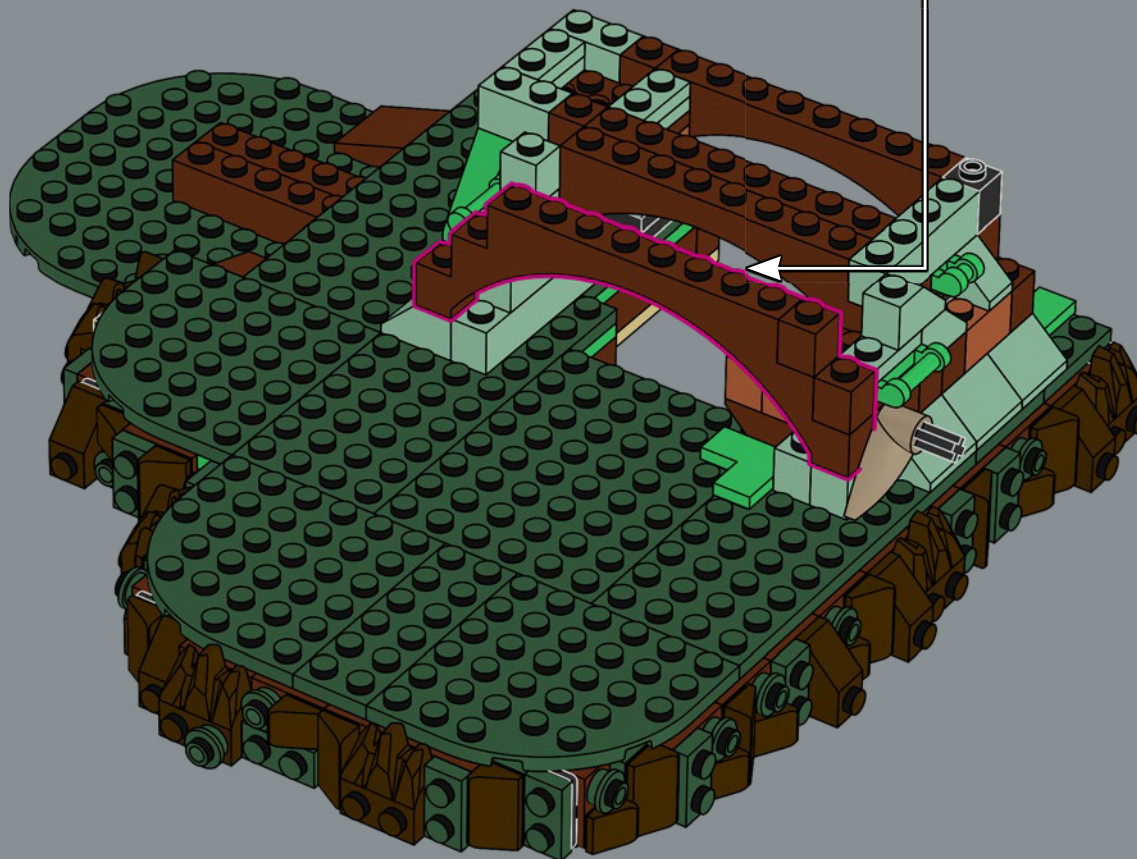
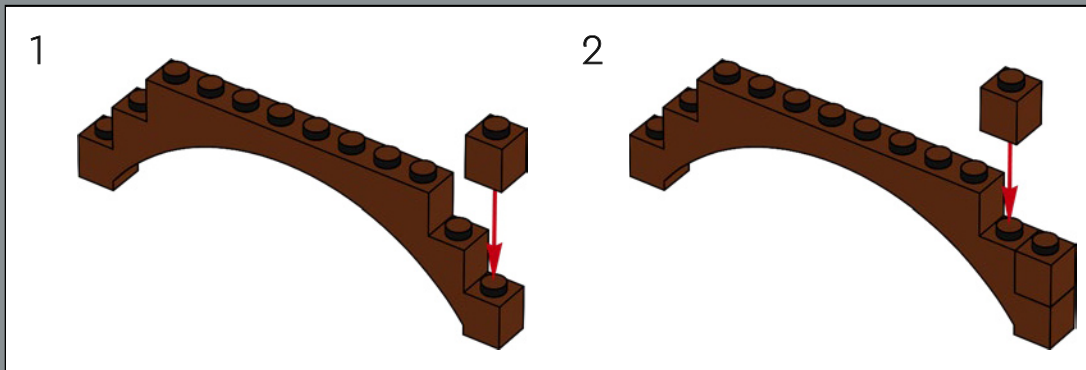



2x

46

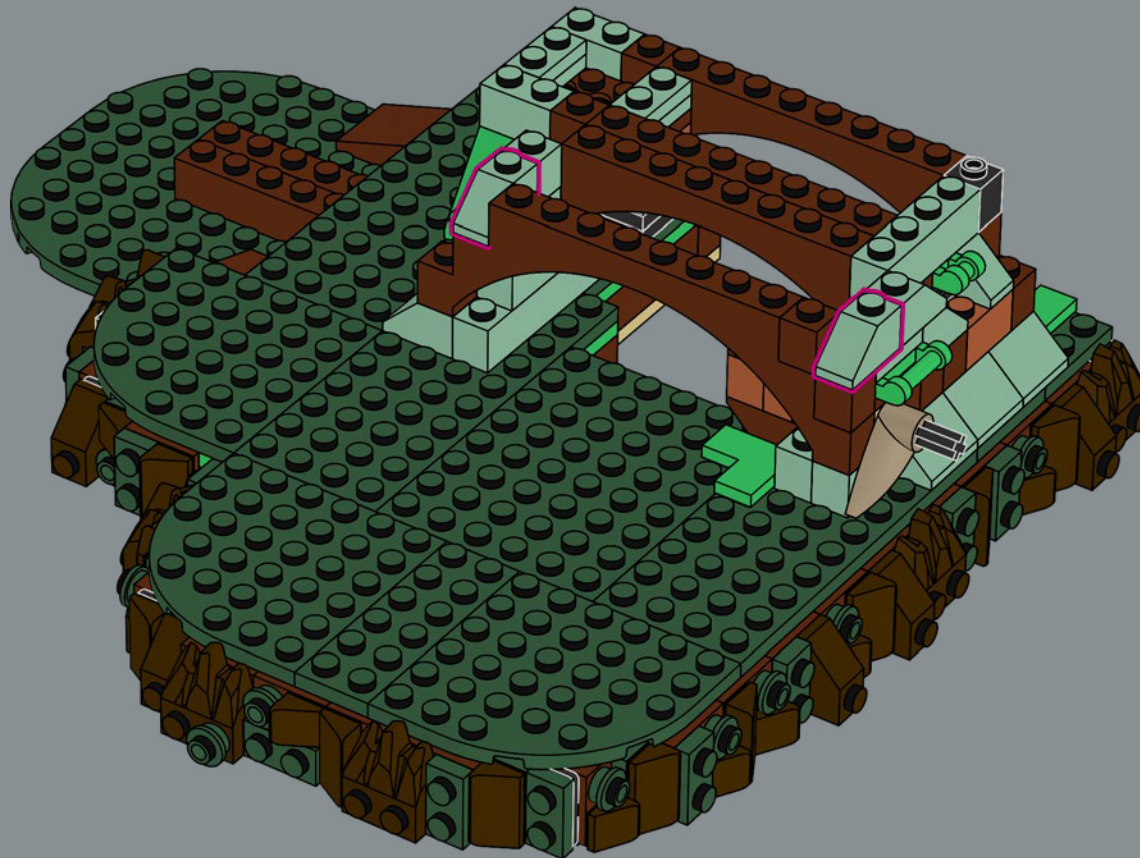

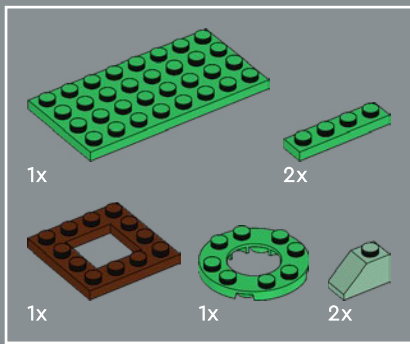

47



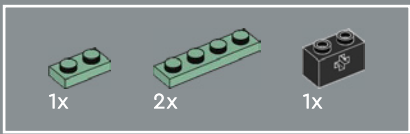

48



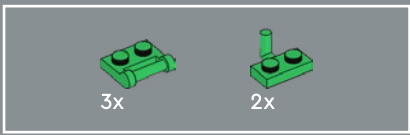

49

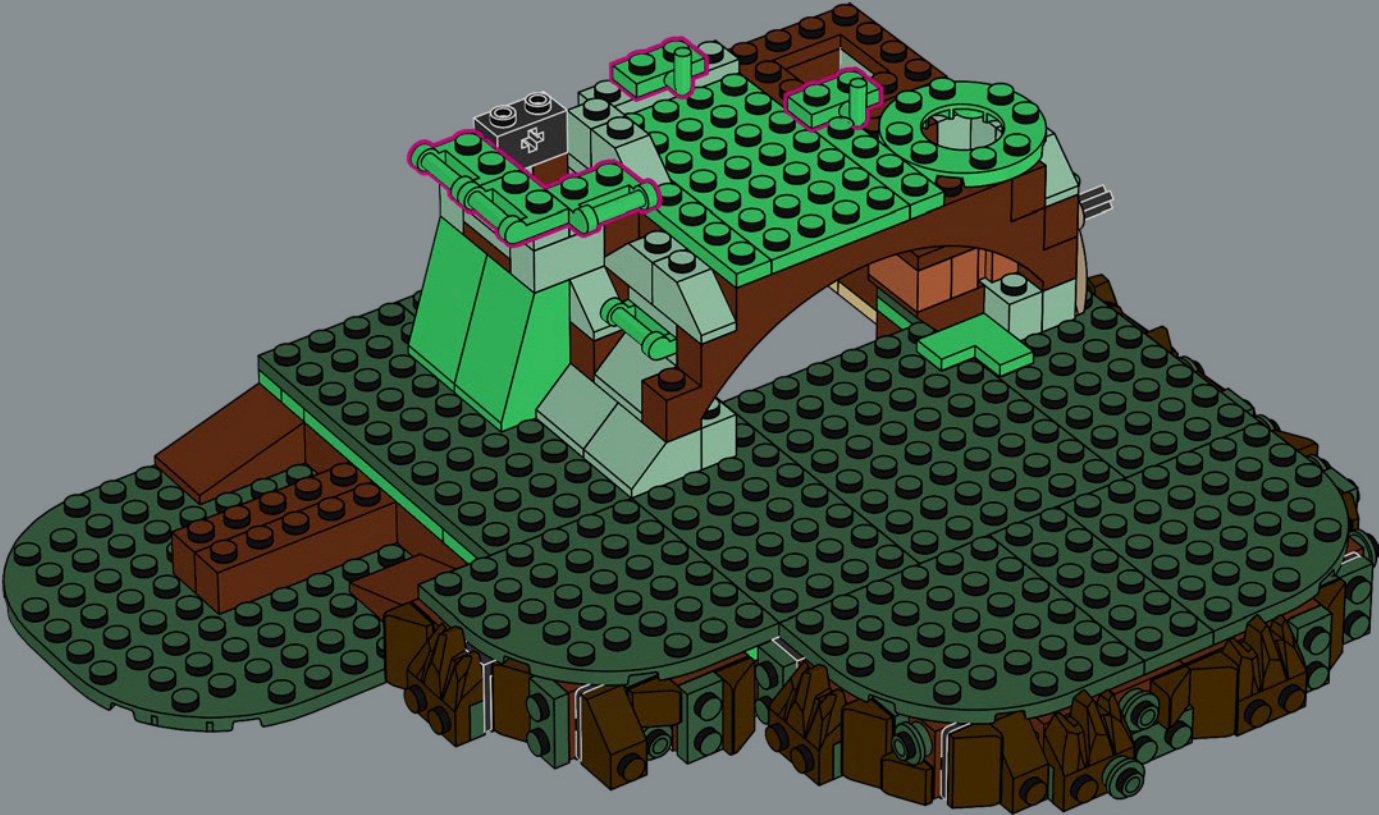

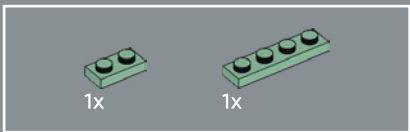

50



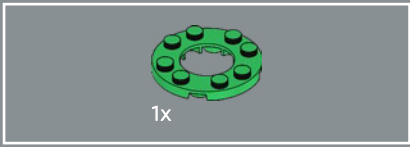

51



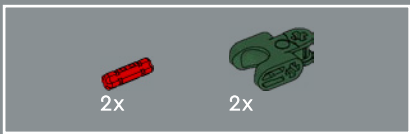

52

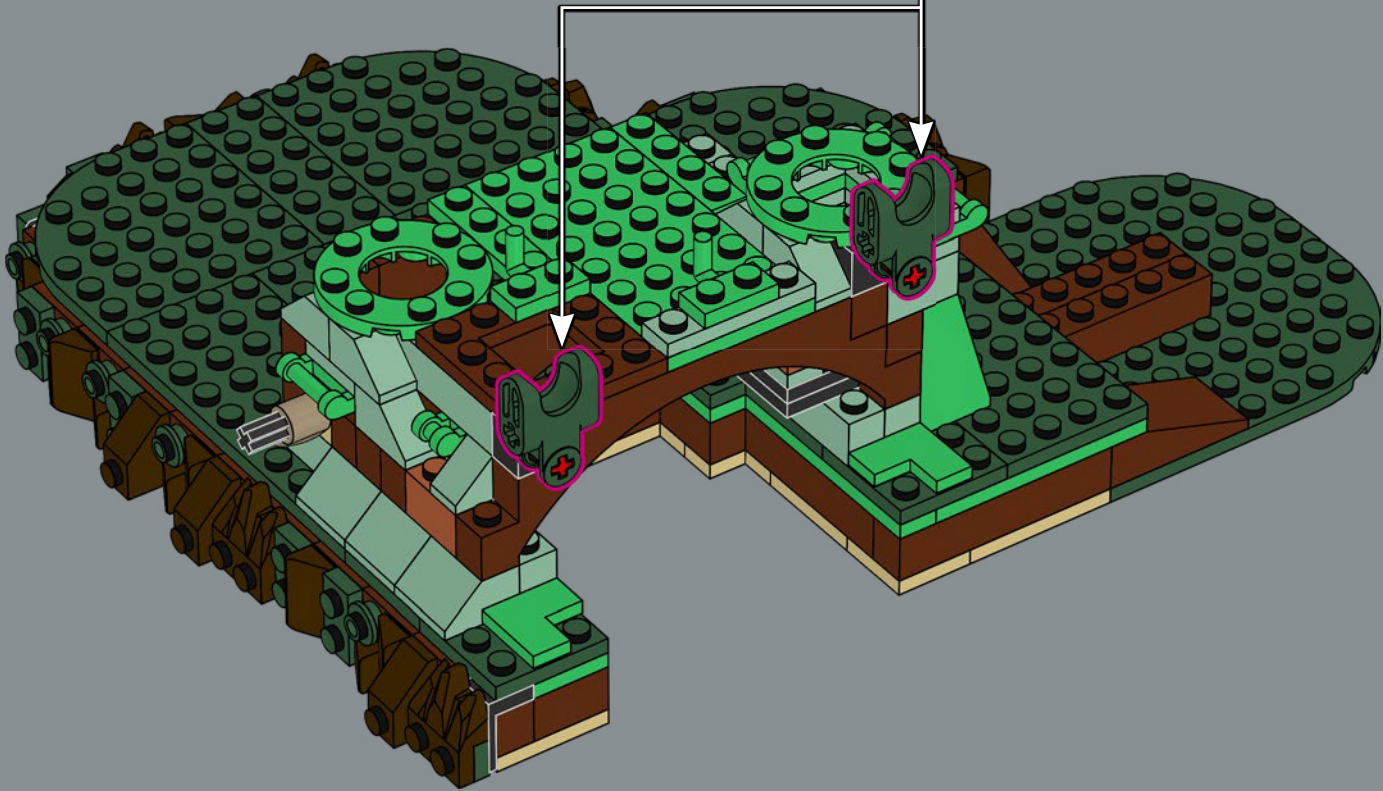
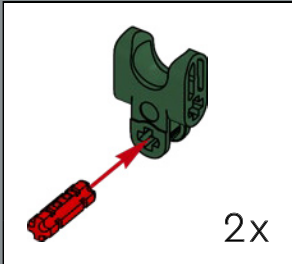

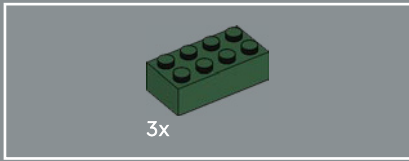

53

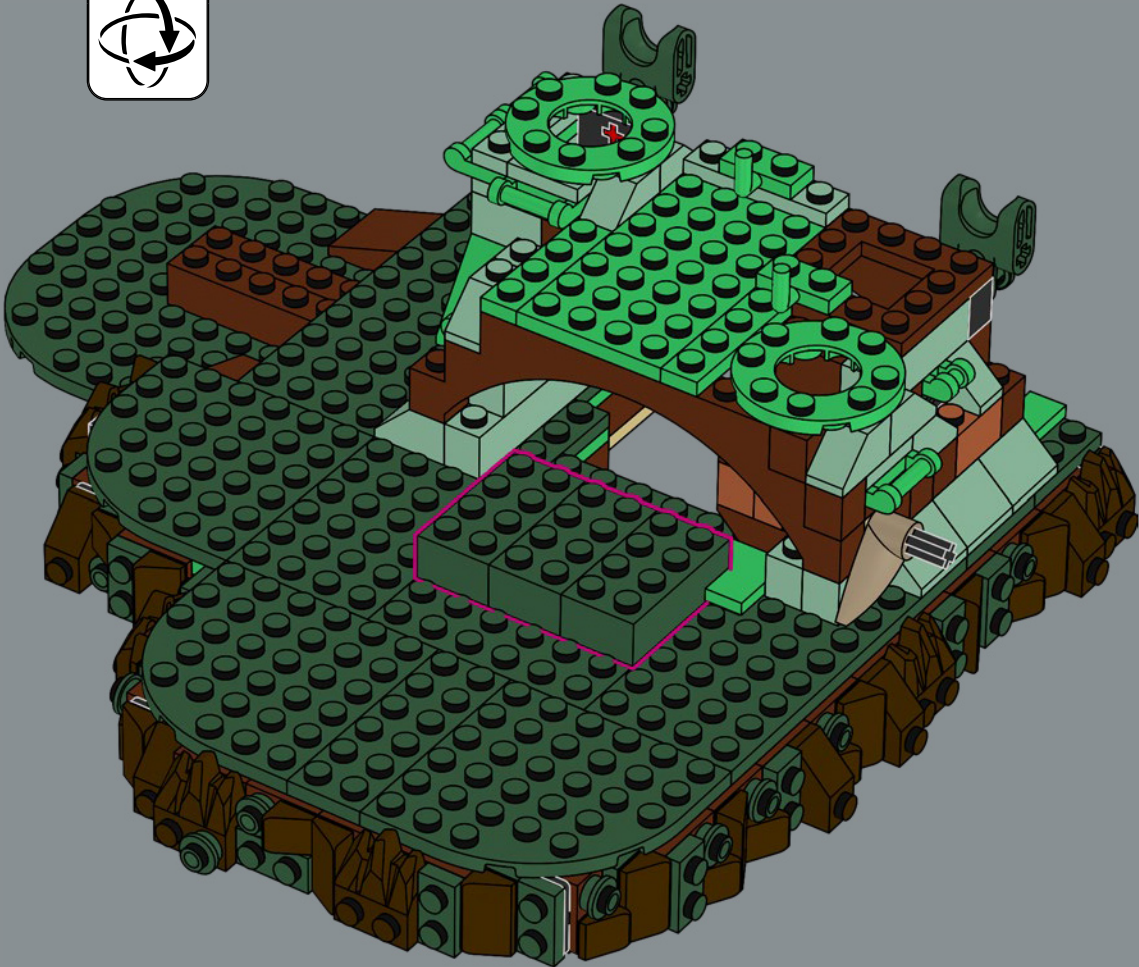

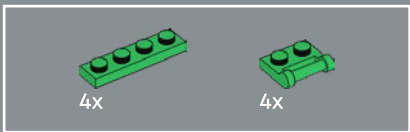

54



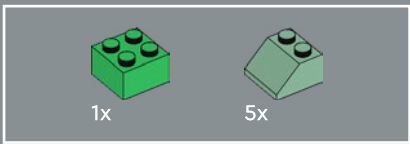

55

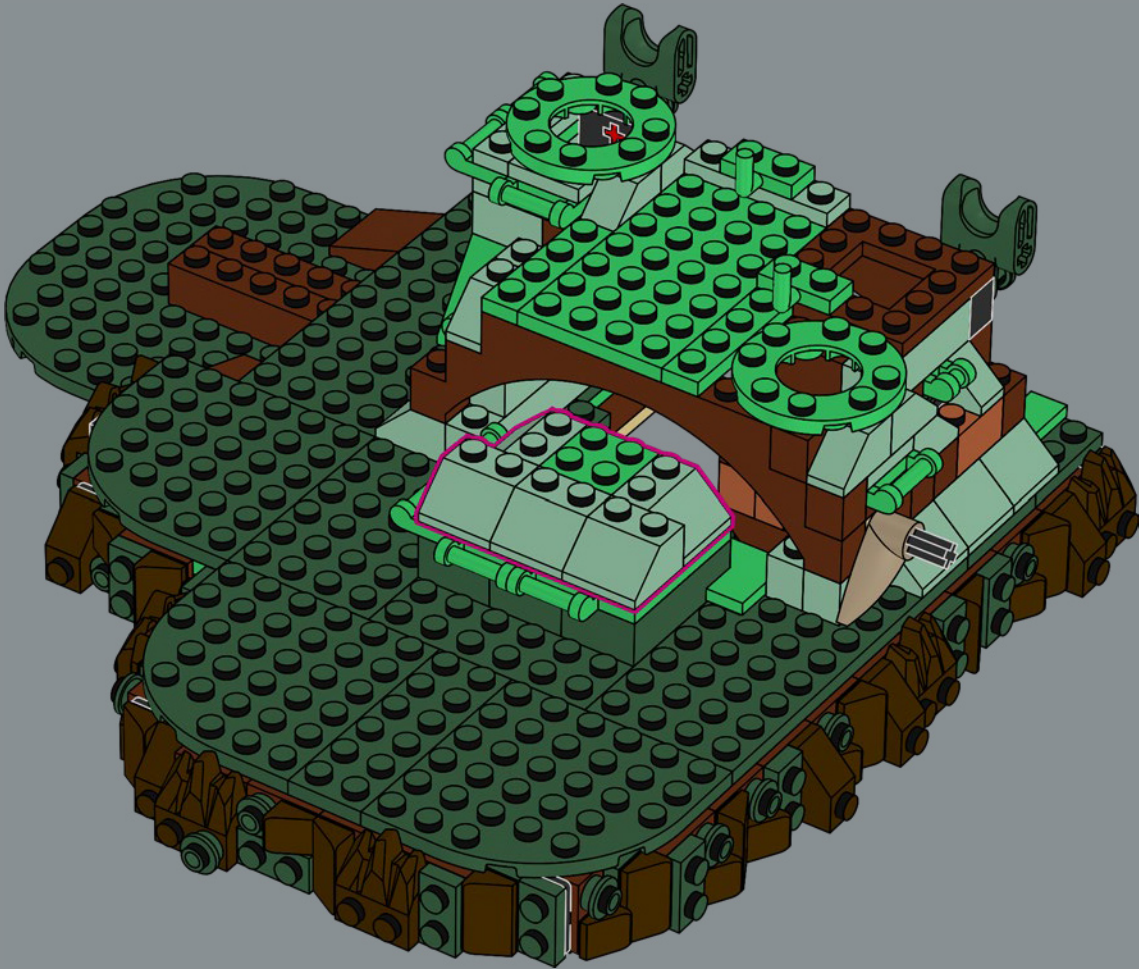

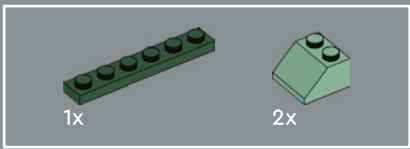

56



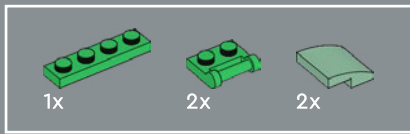

57

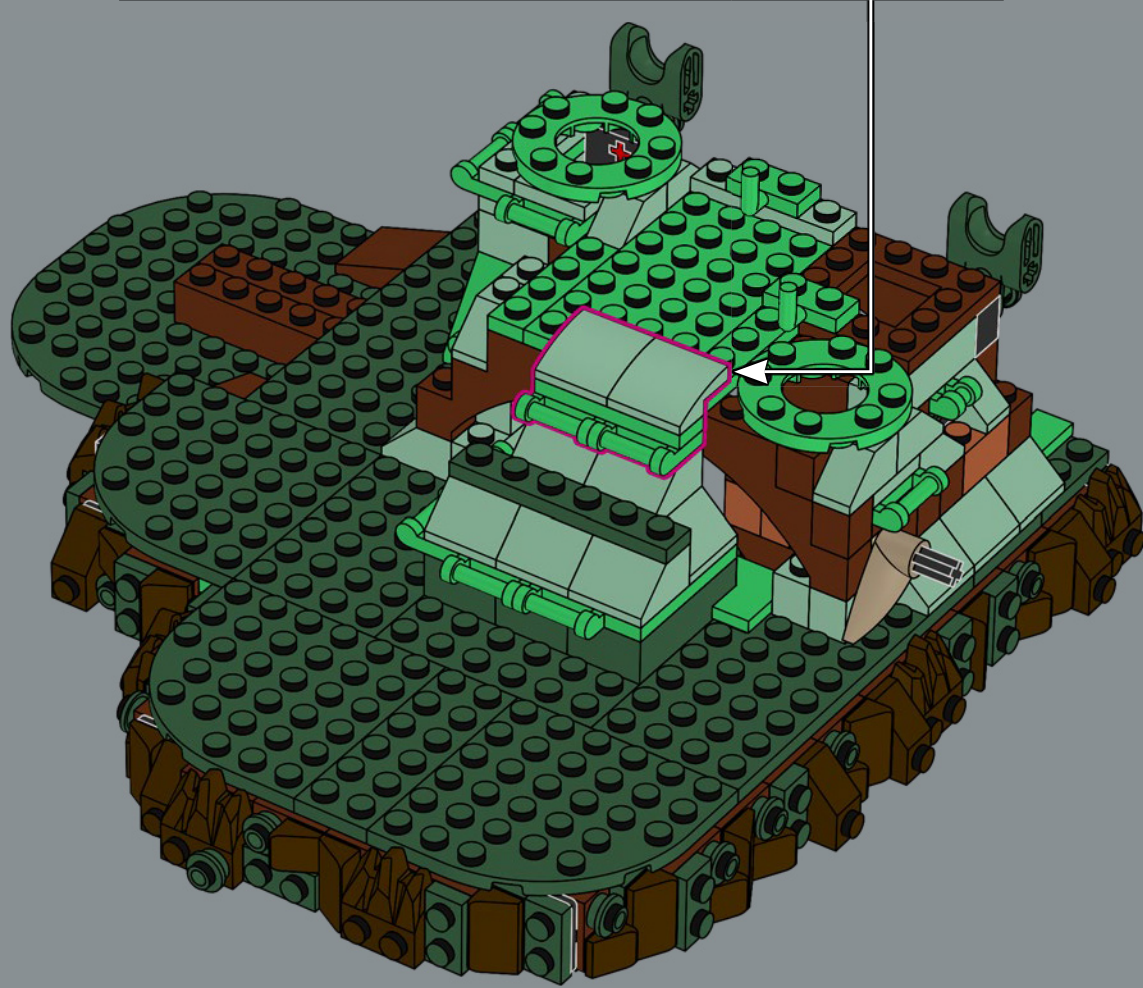
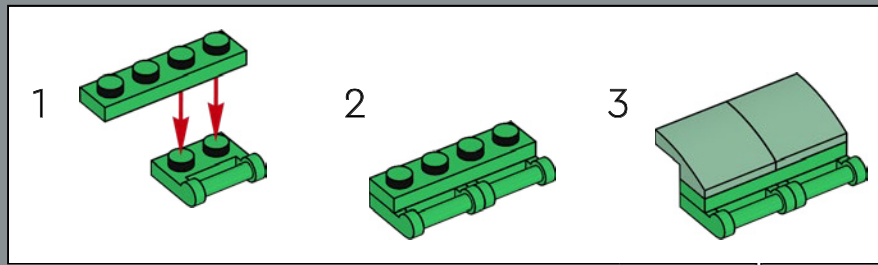



5x

58

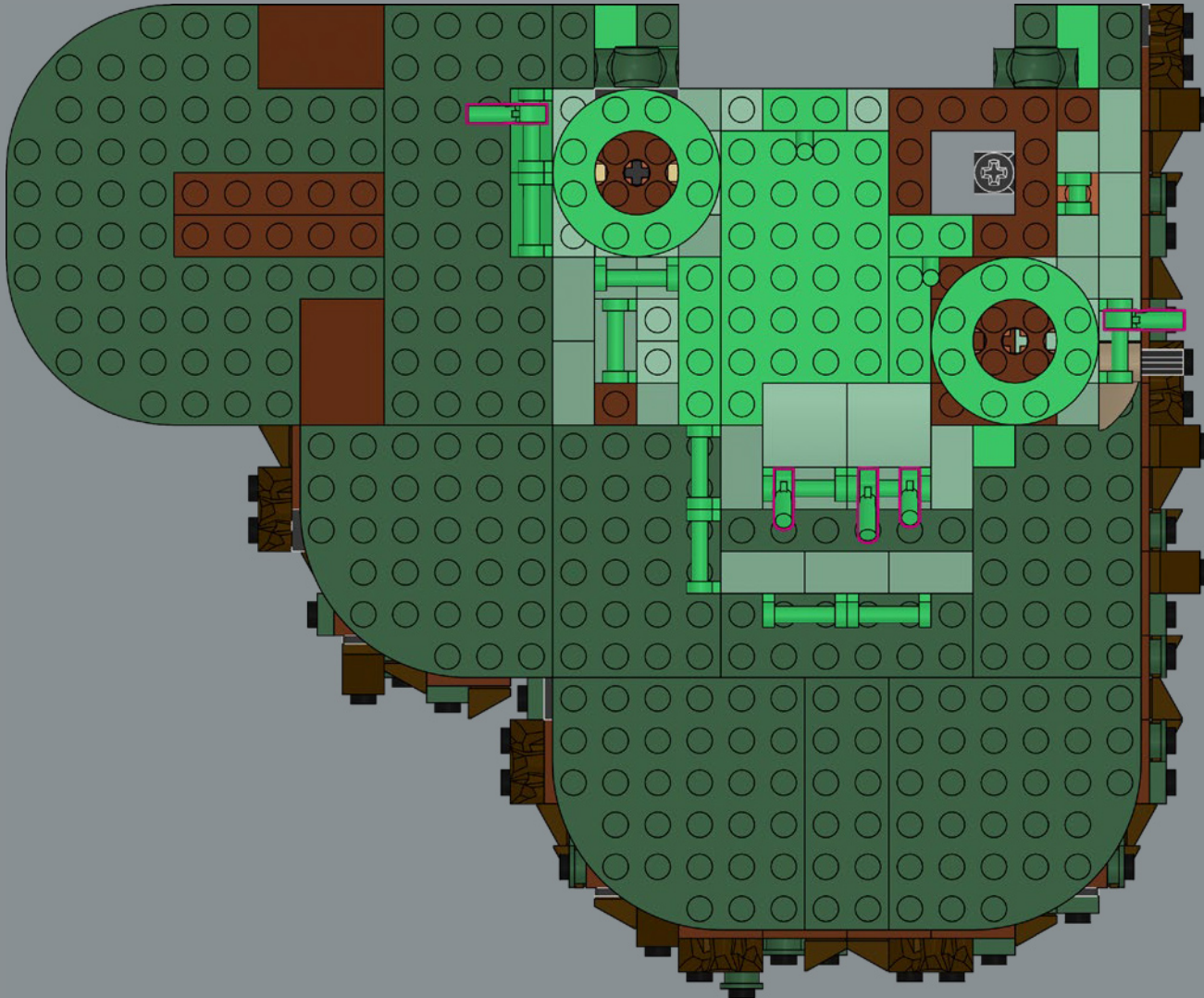



59

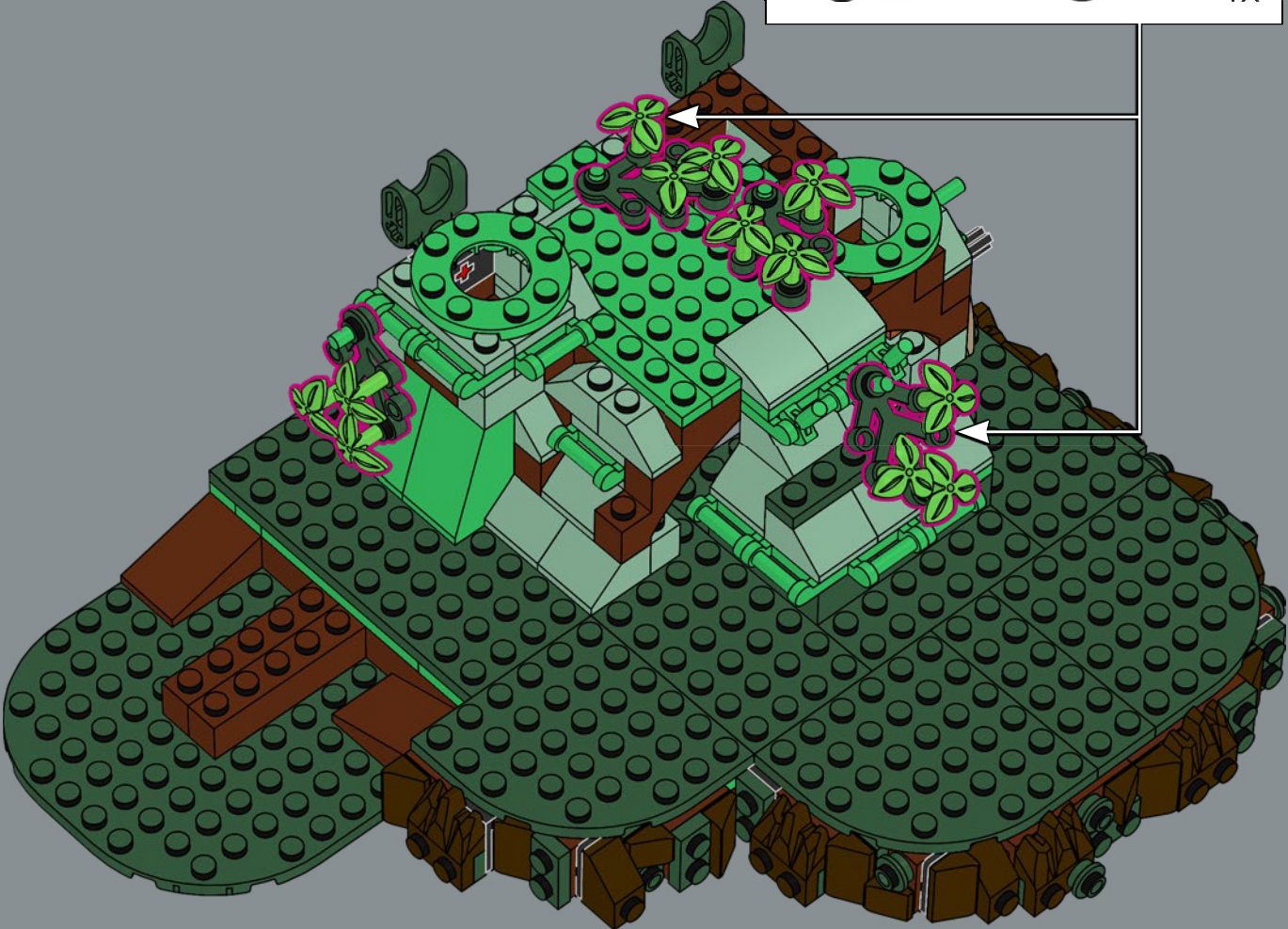
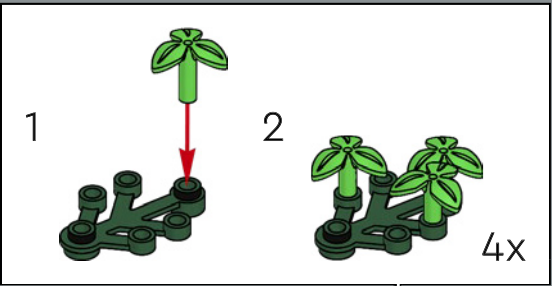



60

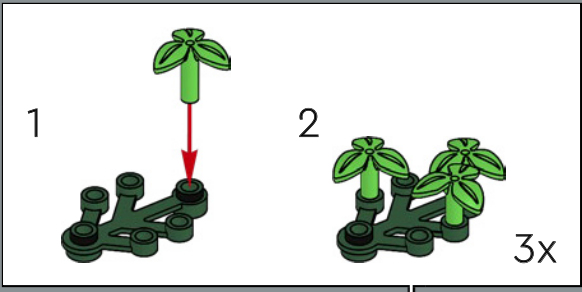



5x

61

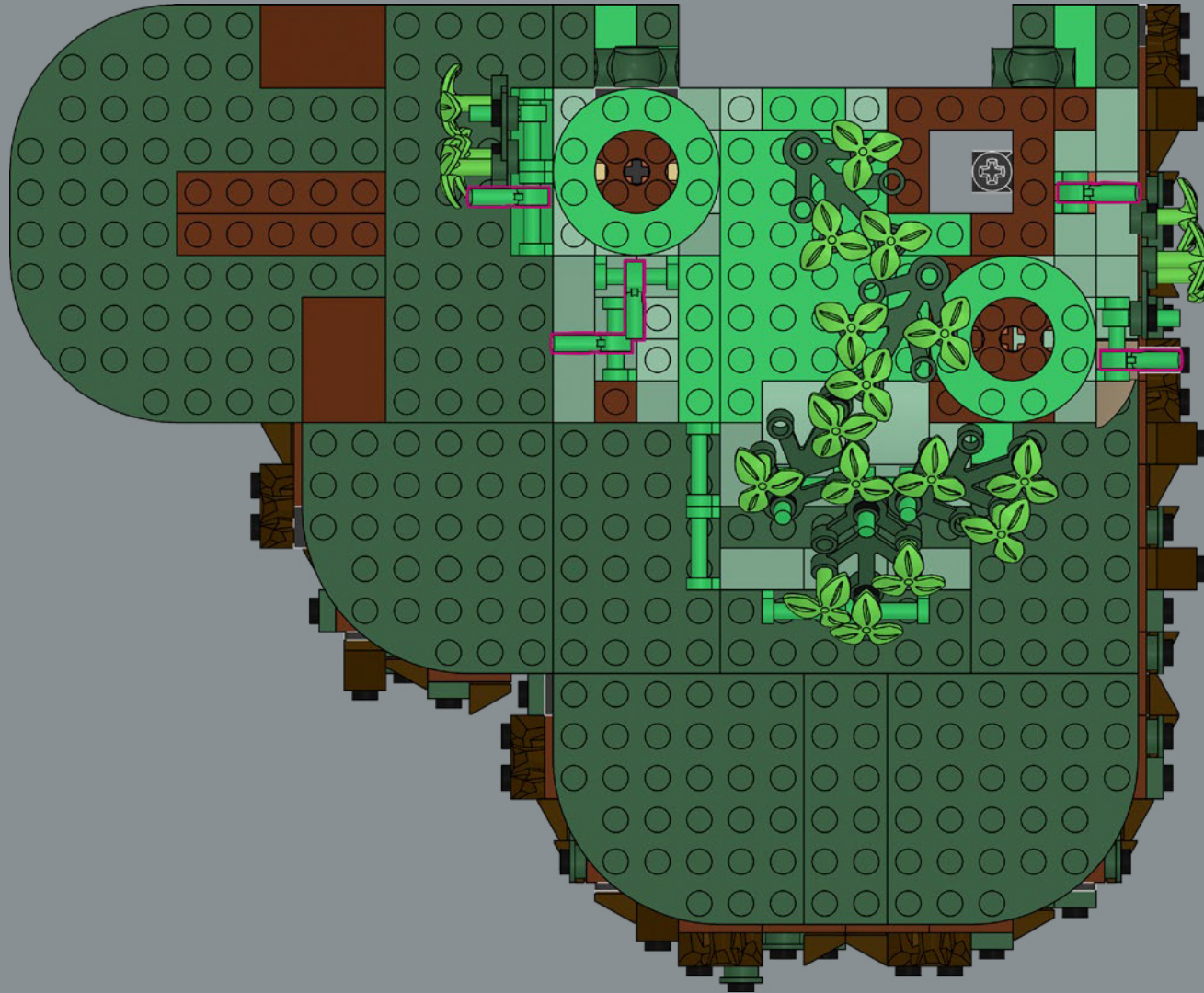



62

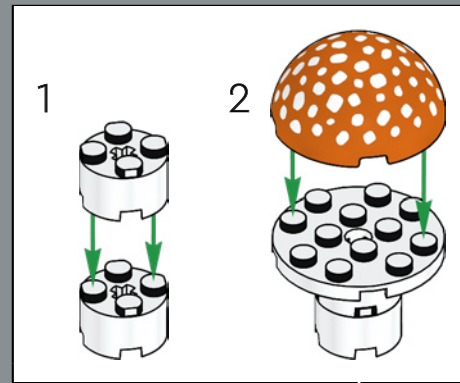

A new decoration makes the fly agaric tops shine with bright bursts of colour.



63



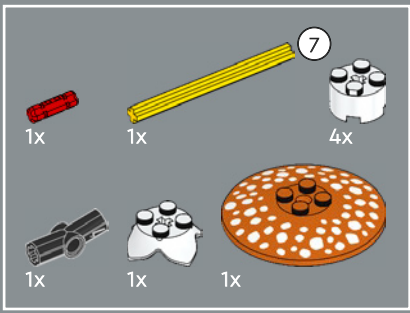

64

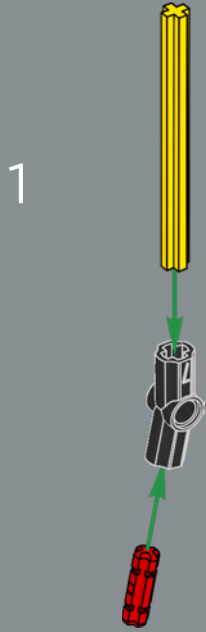

2

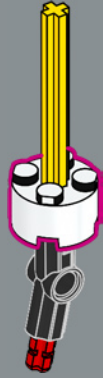

3

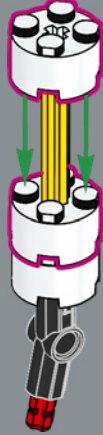

4

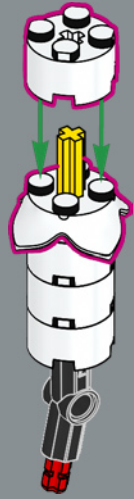

5





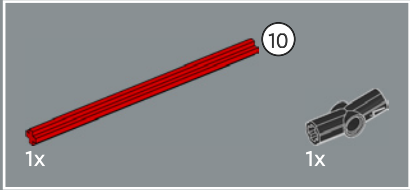
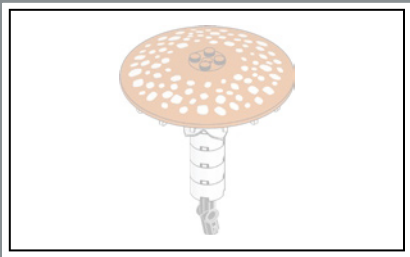

65

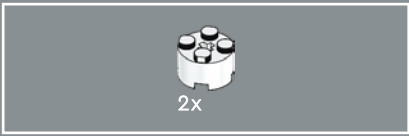

66

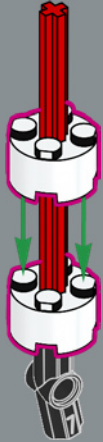

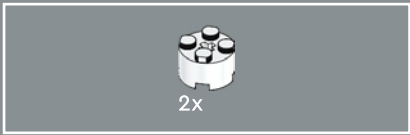

67

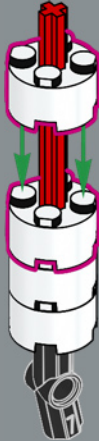

68

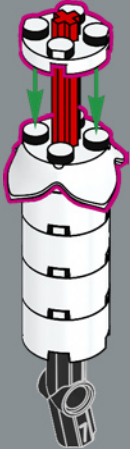

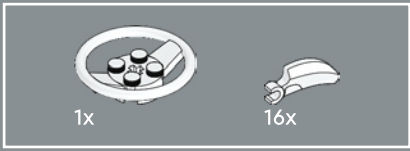

69

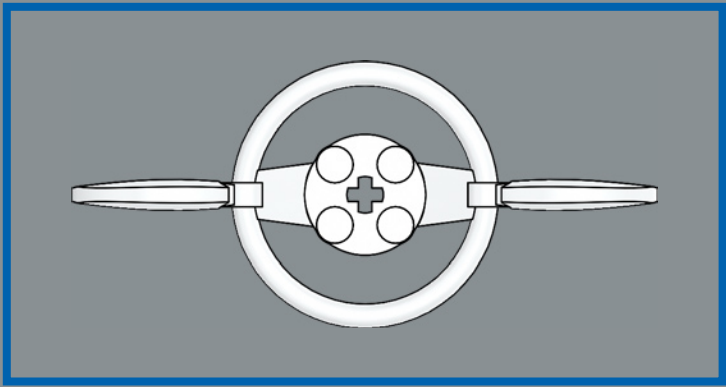

1

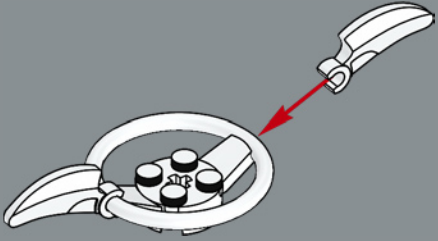

2

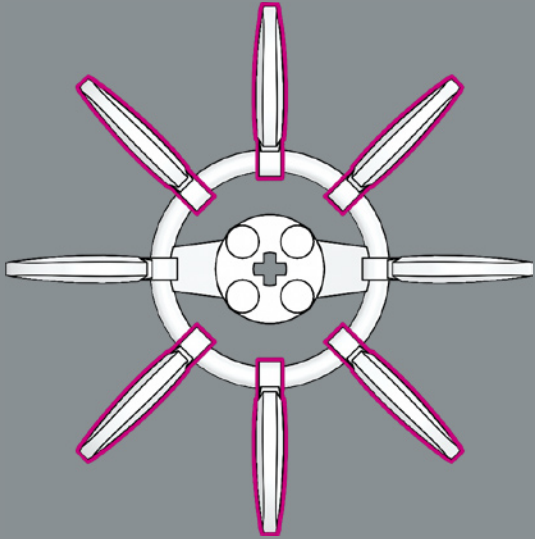

3

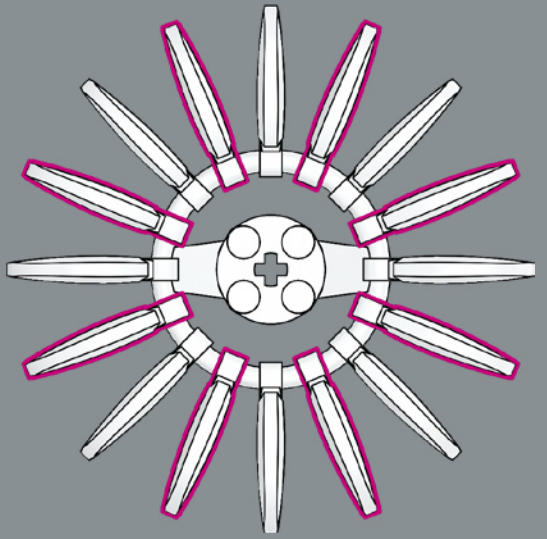

Claw elements can be used for much more than LEGO® animals and creatures. Here, they make up the gills under the large fly agaric mushrooms.

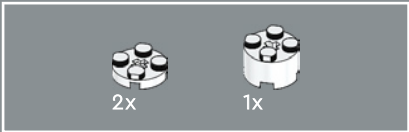

70

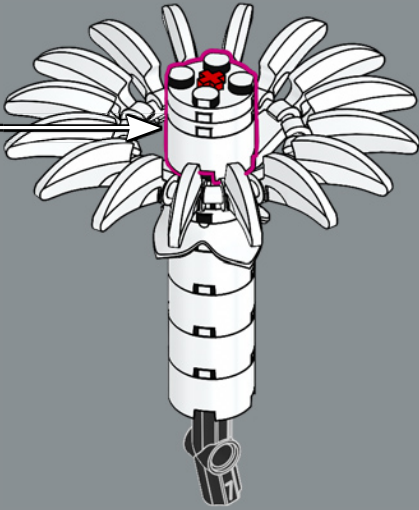
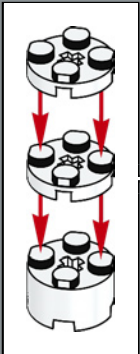
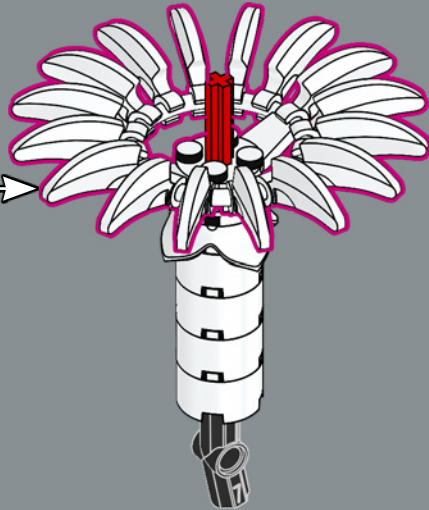

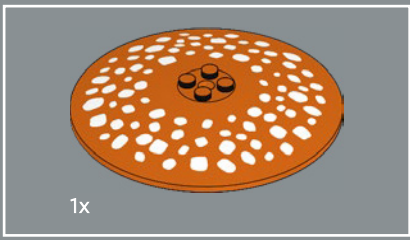

71



72





73



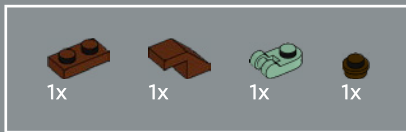

74

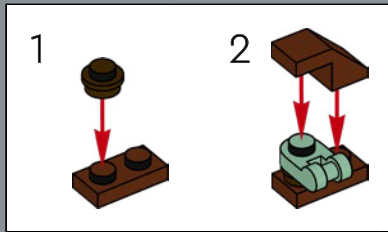



4x

75





76

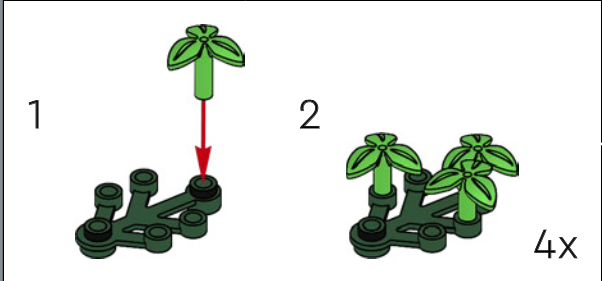



77

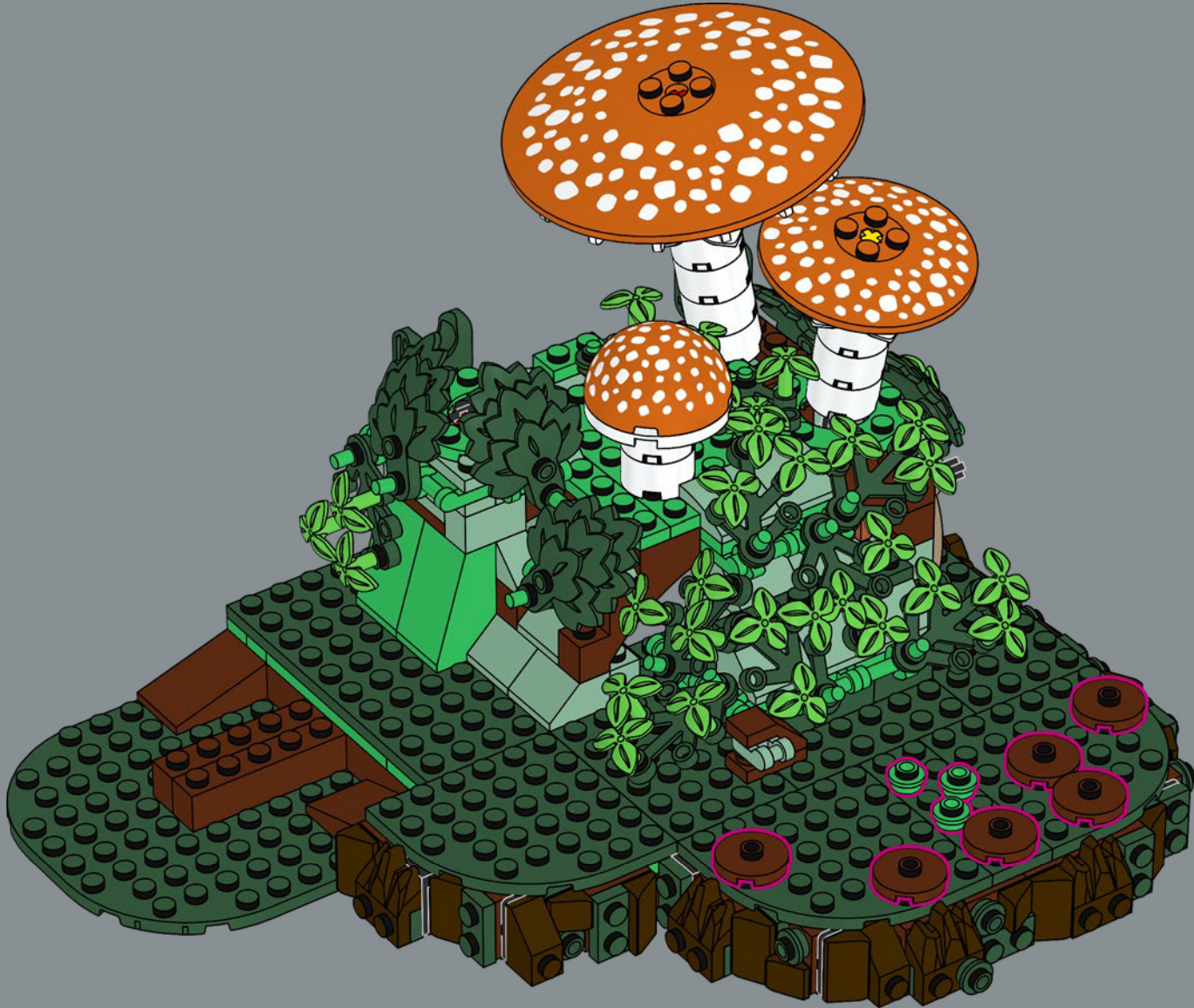

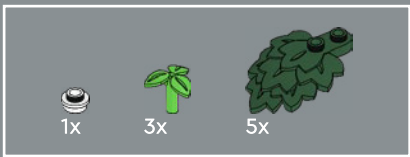

78





79



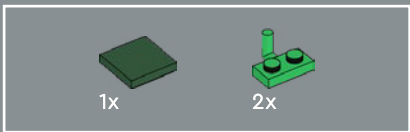

80

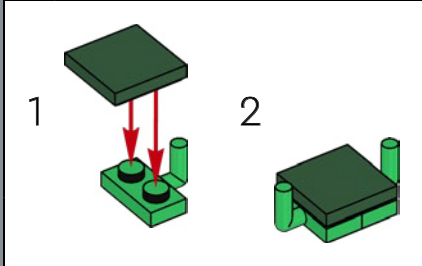

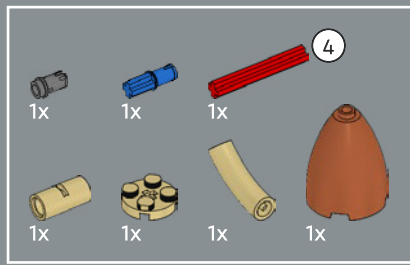

81

1



2

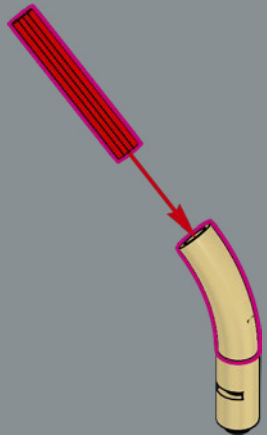

3

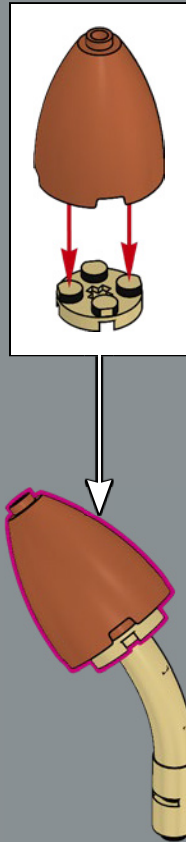

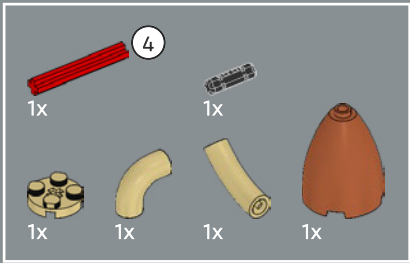

82

1

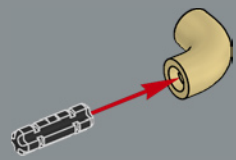

2

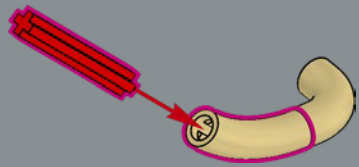

3

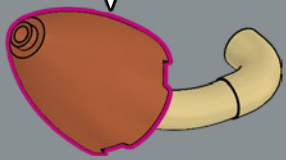
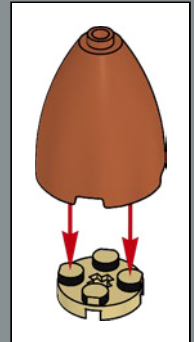

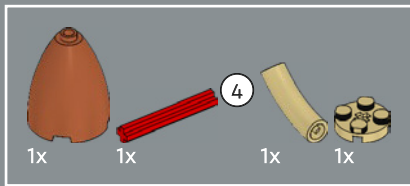

83

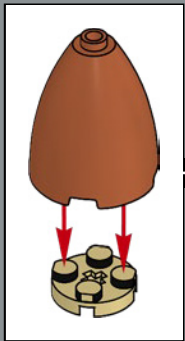
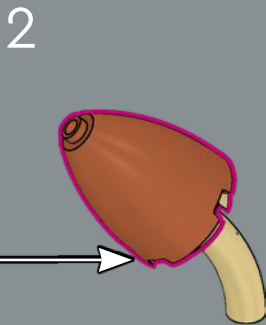
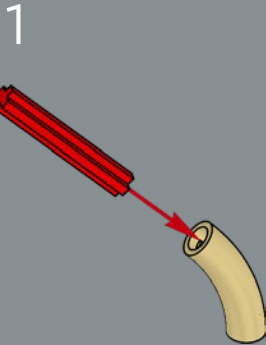

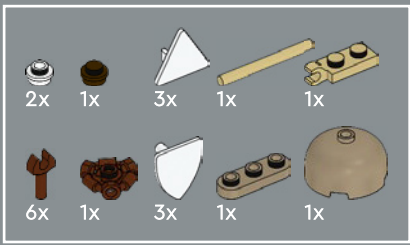

84

1

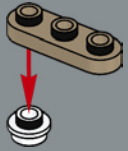

2

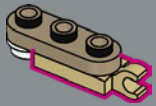

3

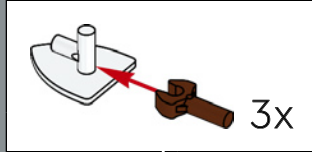
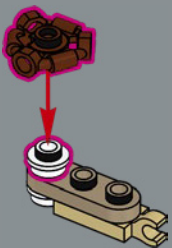

4

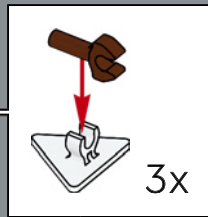
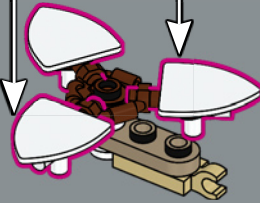

5

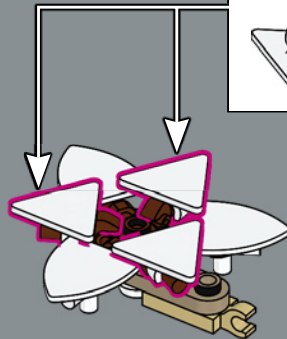

When recreating whimsical shapes, all sorts of LEGO® elements come into play. For the collared earthstar's characteristic form, we combined triangular street signs with minifigure shield elements.

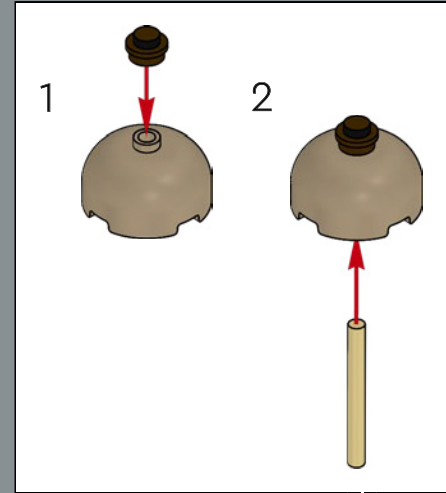

6

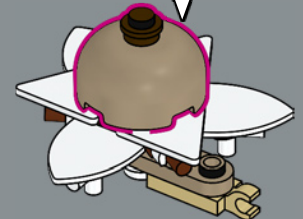



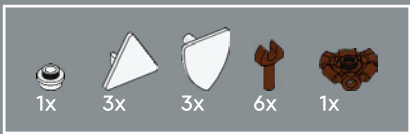

85

1

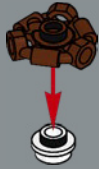

2

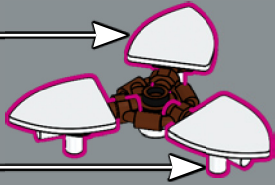
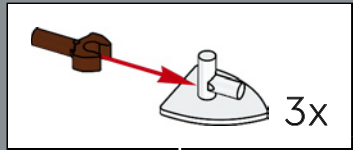

3

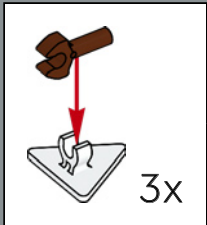

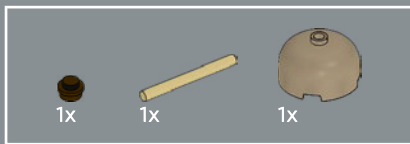

86

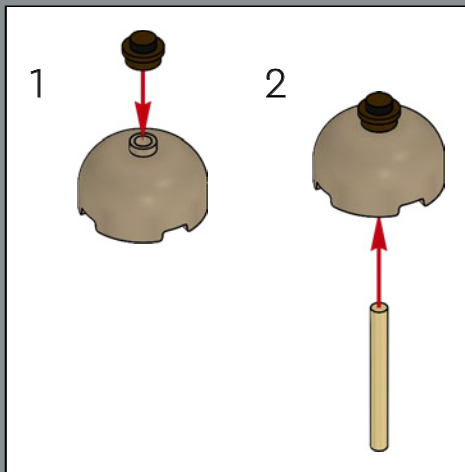

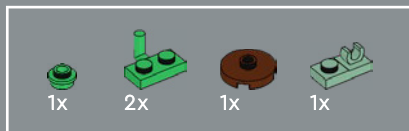

87



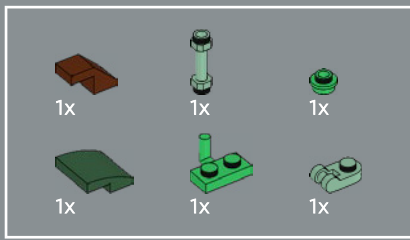

88

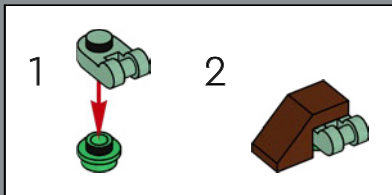
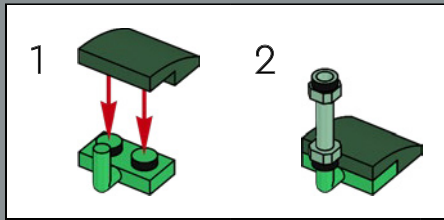

The stamens in the crocuses get an almost regal glow with these LEGO® minifigure crowns.

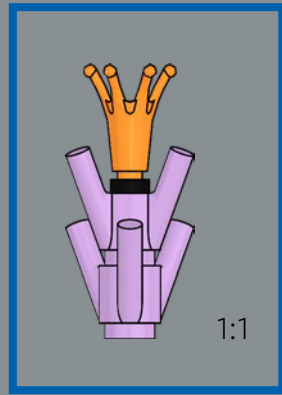
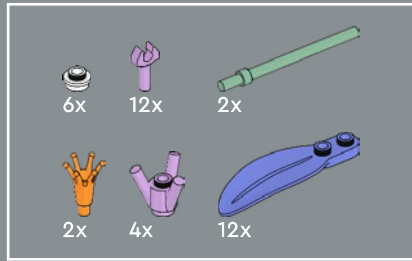
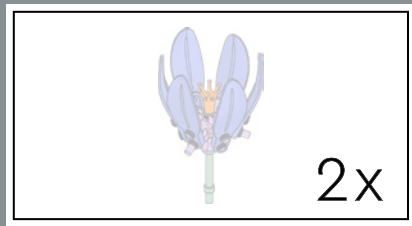

89

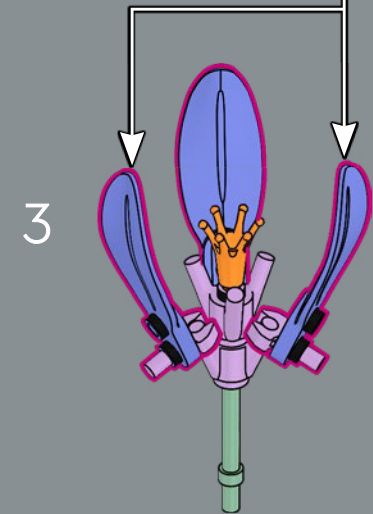
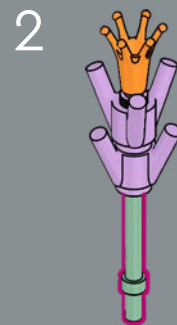
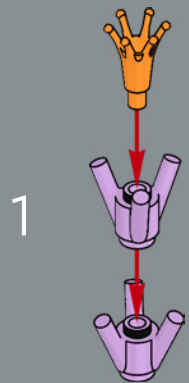
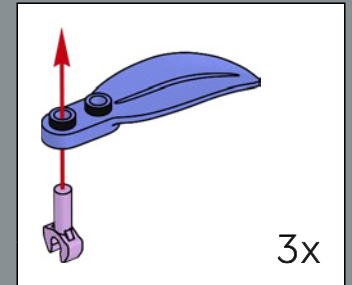

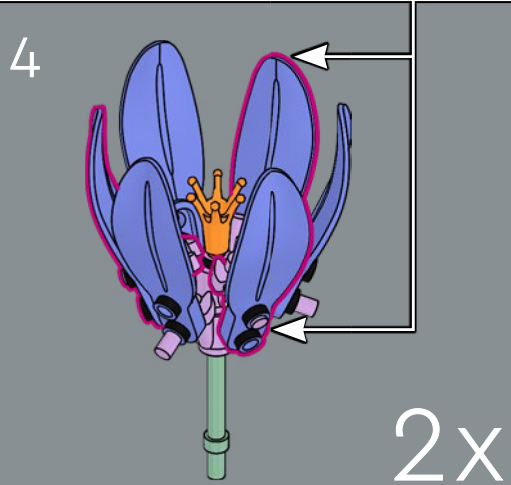
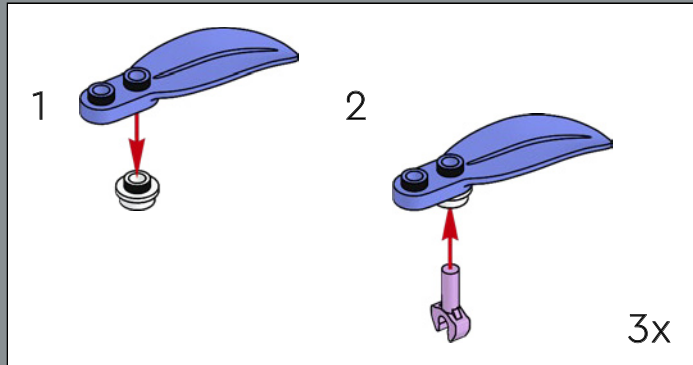

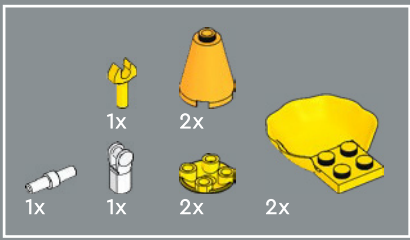

90

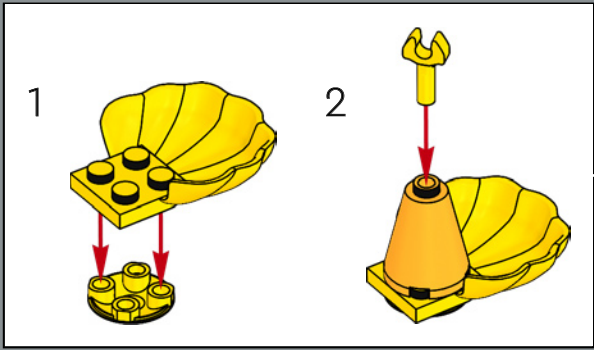
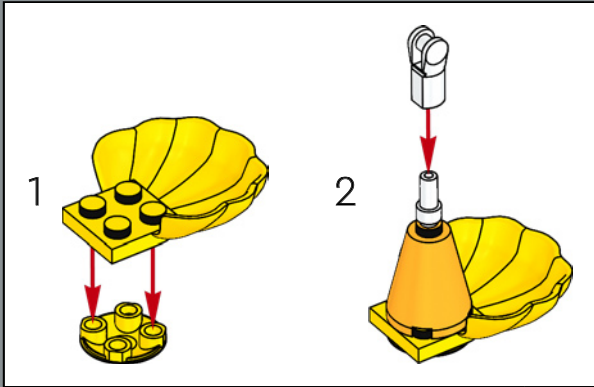

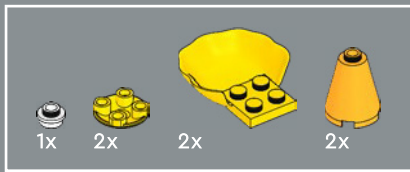

91

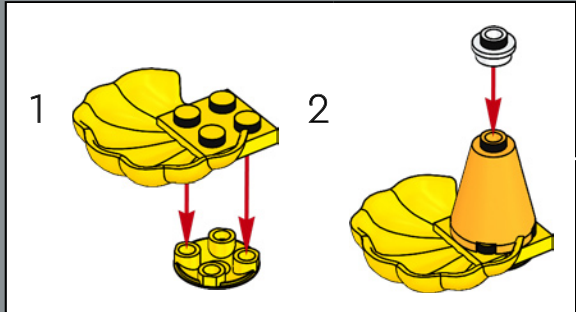
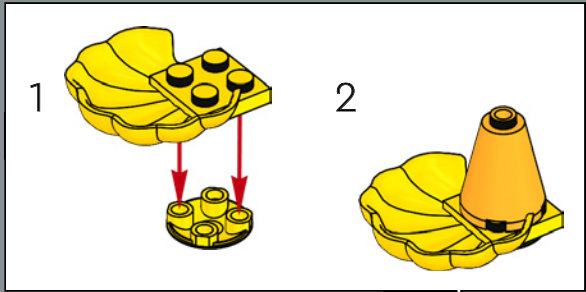

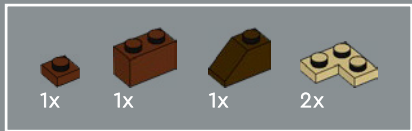

92





93





94





95





96



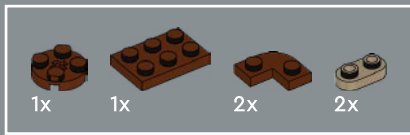

97



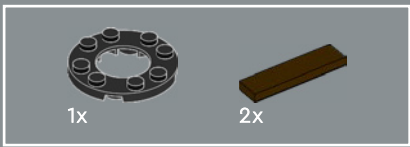

98



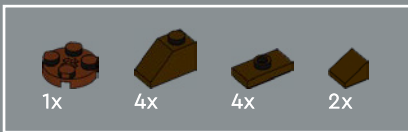

99

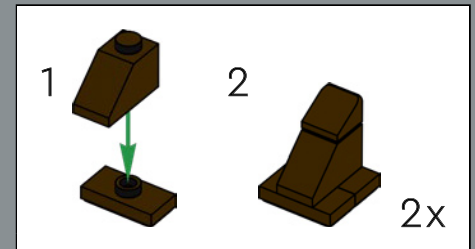



1x

100





101

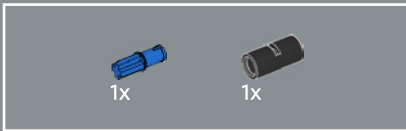
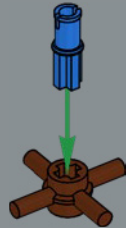

102

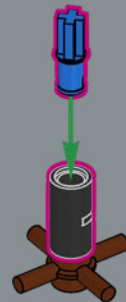

103

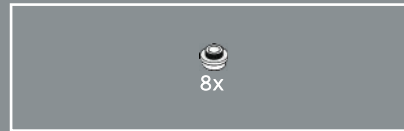

104

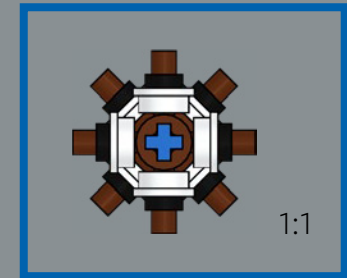



105

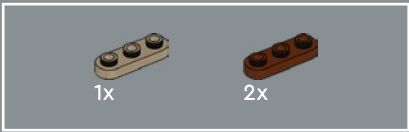
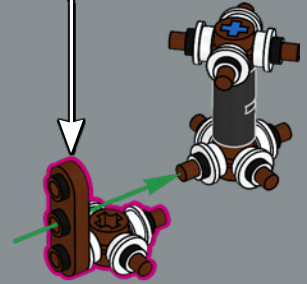
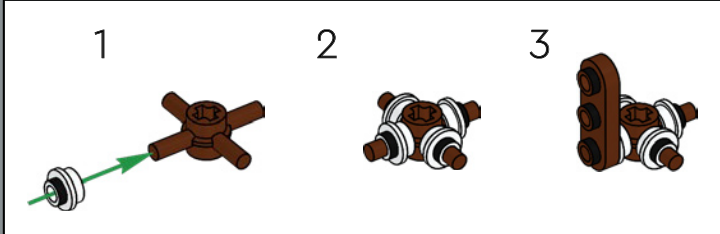

106

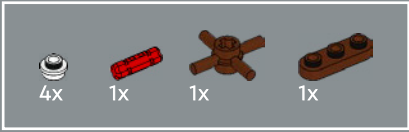
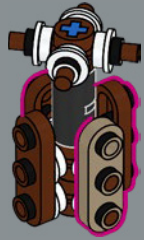

107

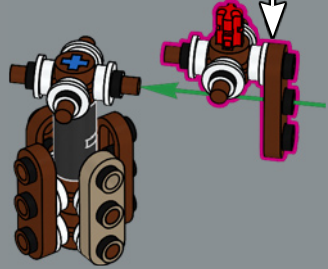
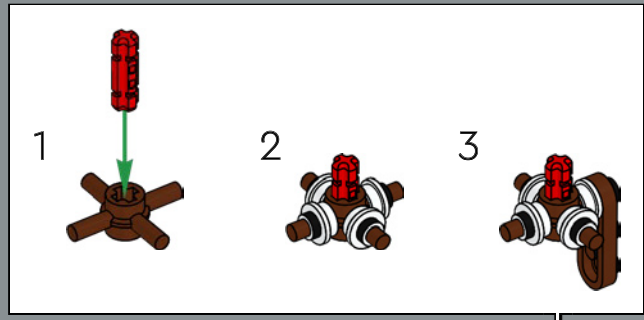



108

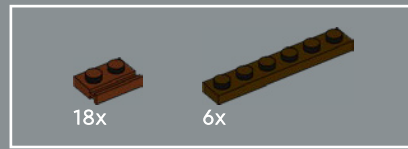
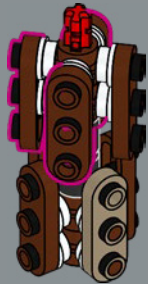

109

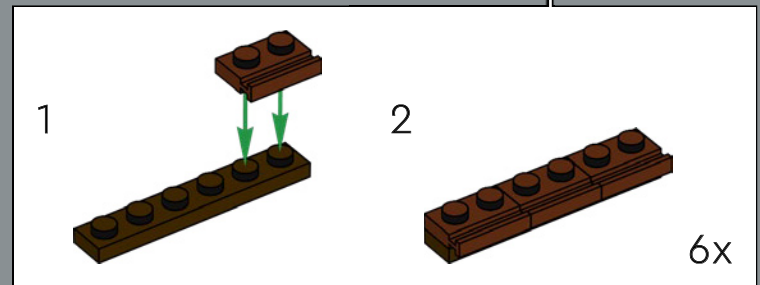
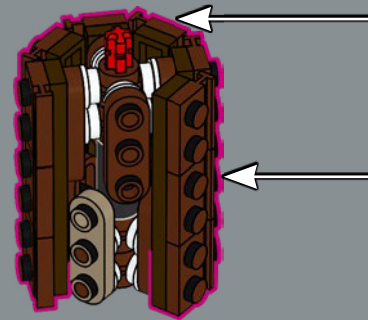
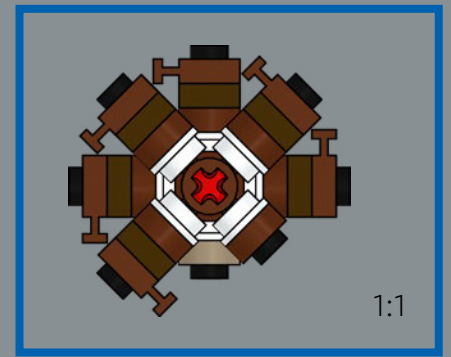

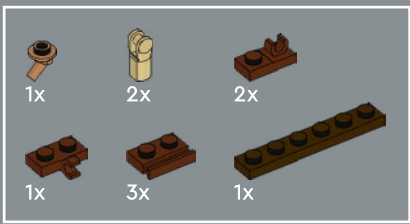

110

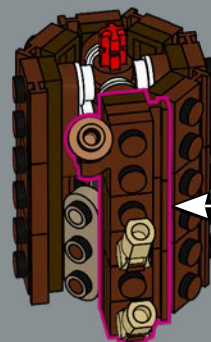
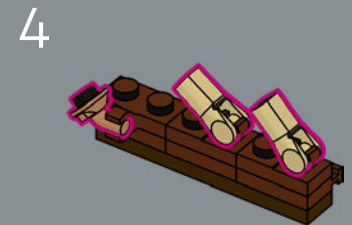
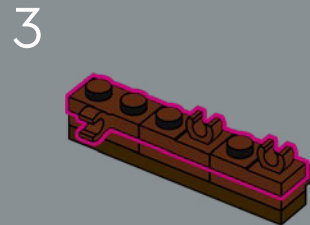
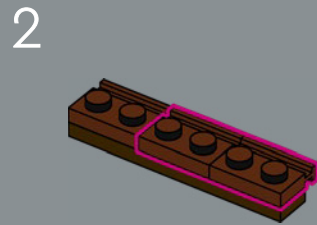
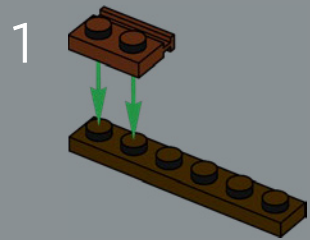

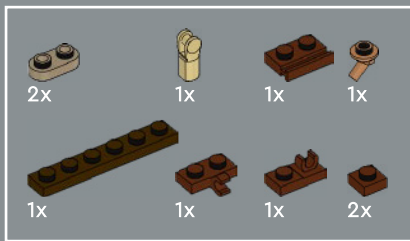

111

1

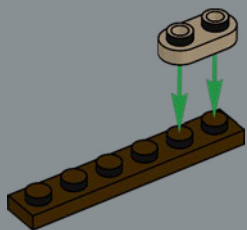

2

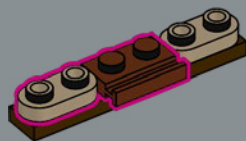

3

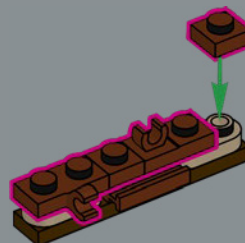

4

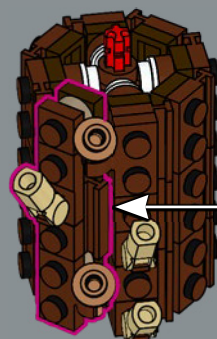
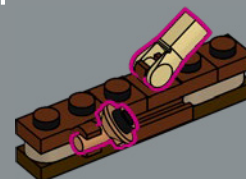

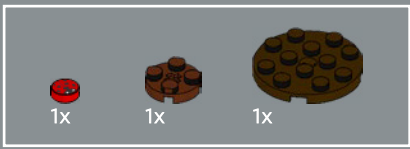

112

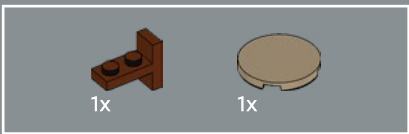
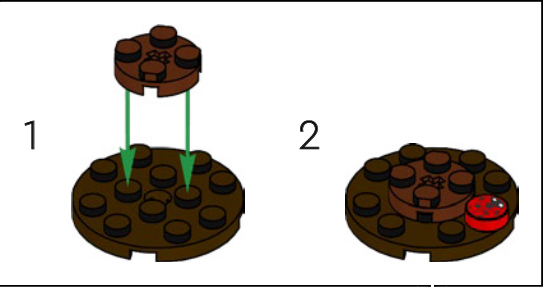

113

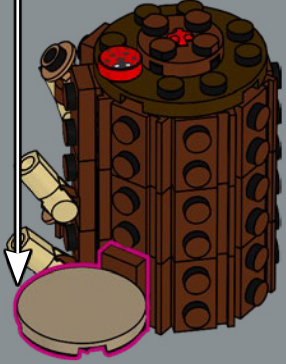
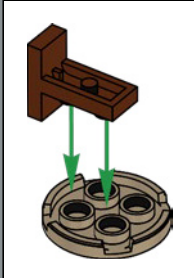



114

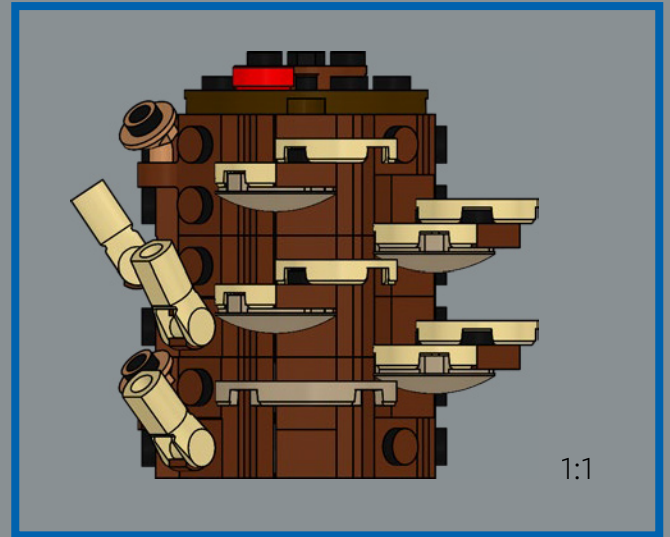
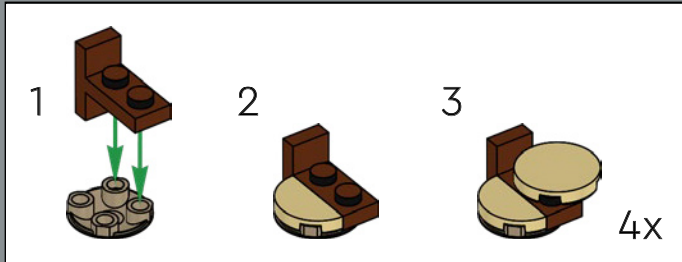



The common bonnet, with its delicate cap and slender stem, looks like it's been plucked straight from the pages of a fairytale – their tops are made with LEGO® dwarf minifigure hats.



116

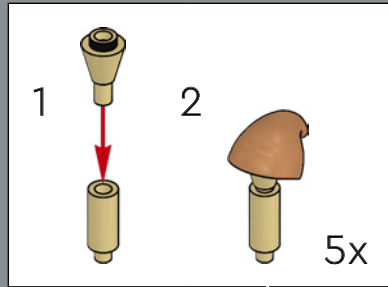

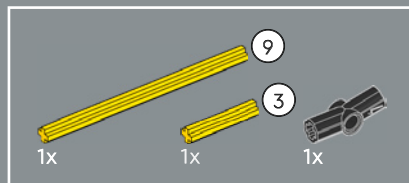
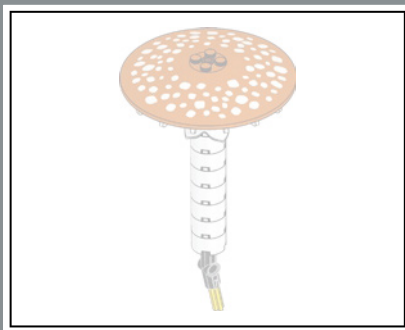

117

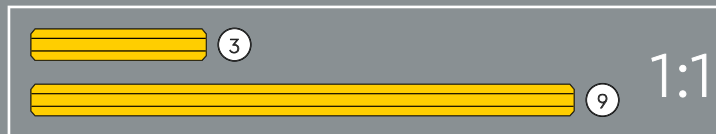
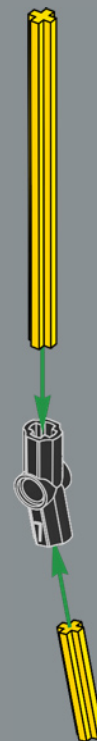

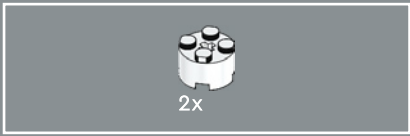

118

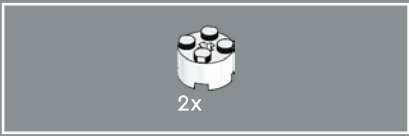
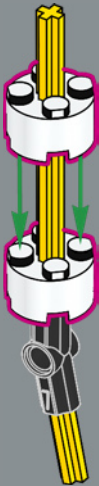

119

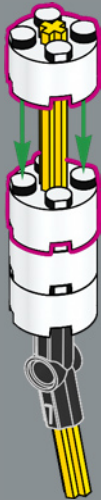



2x

120

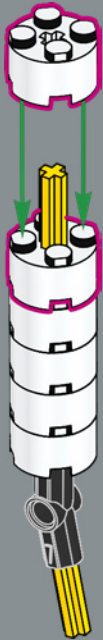

1x



1x



1x

121

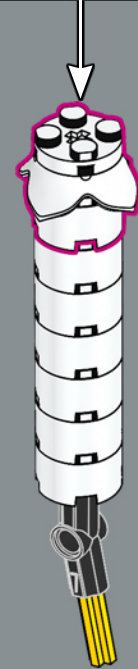
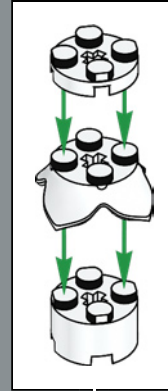

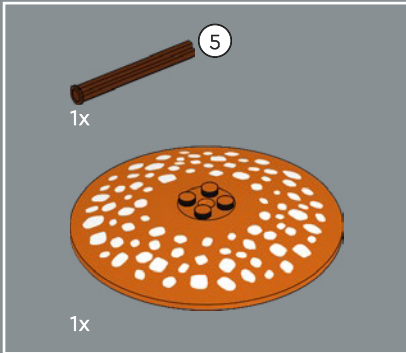
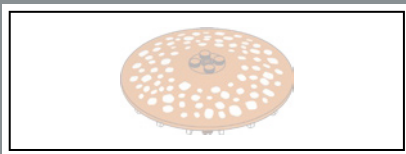

122

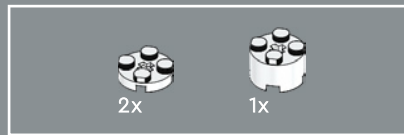
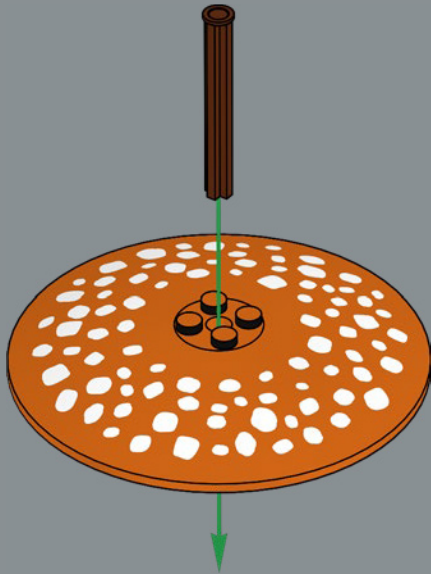

123

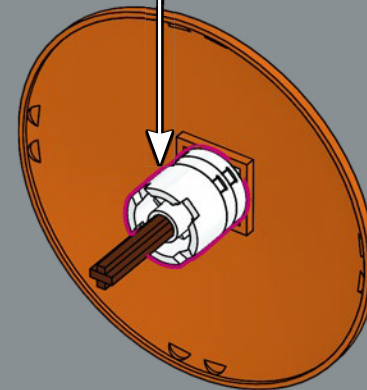
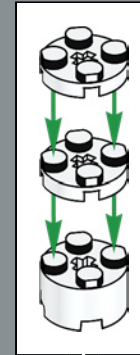

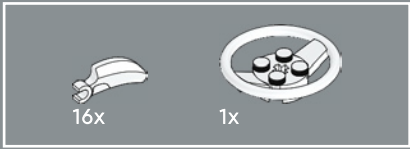
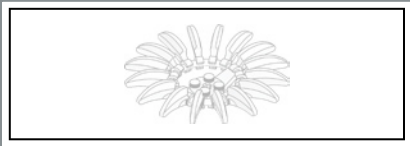

124

1

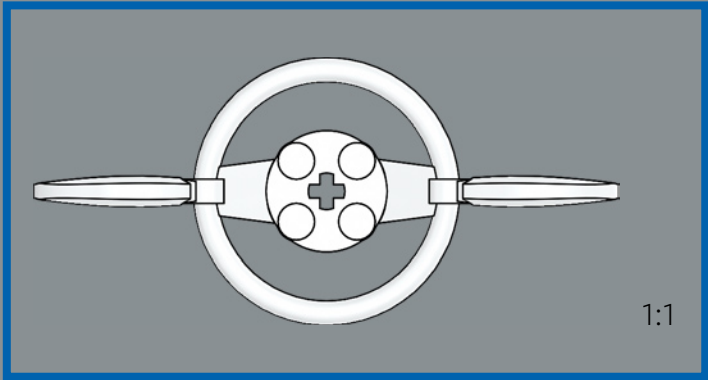
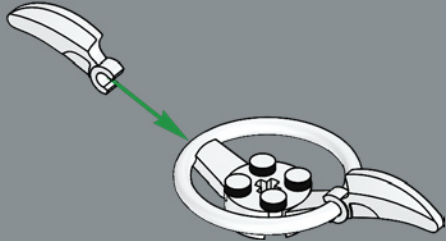

1:1

2

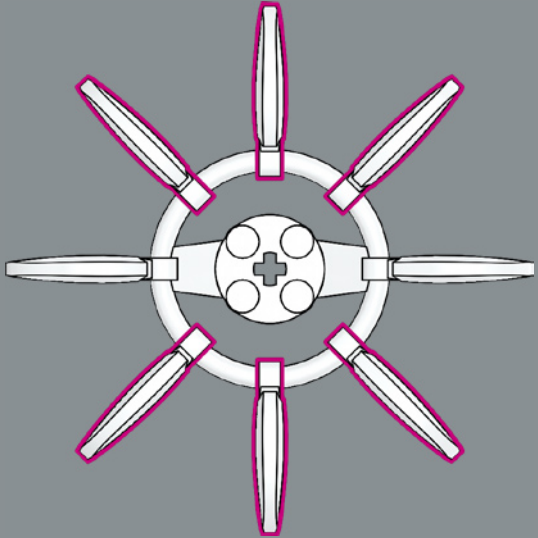

3

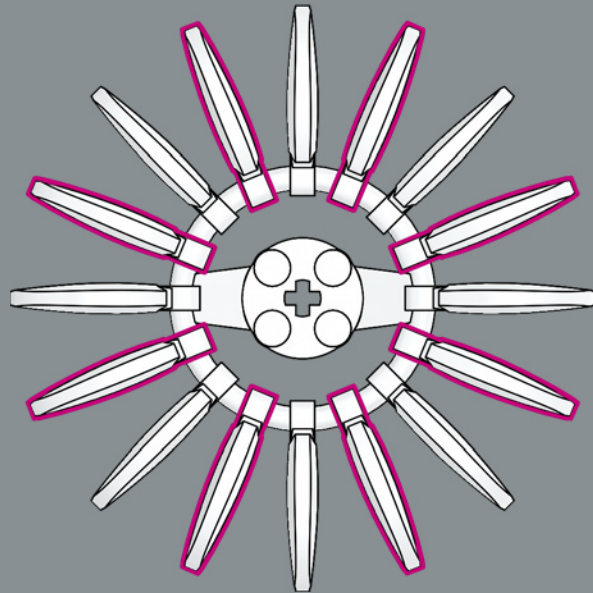

125

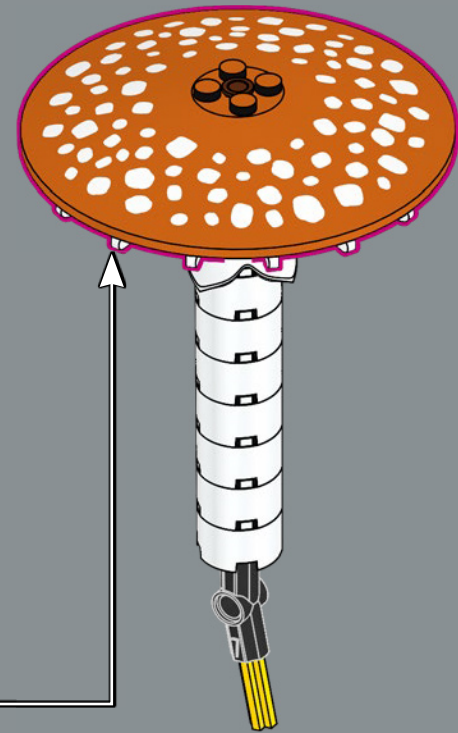



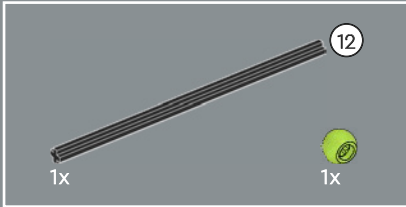
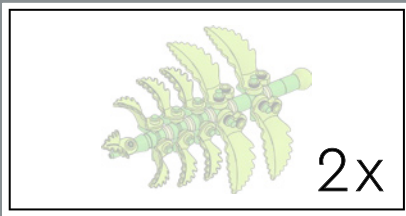

127

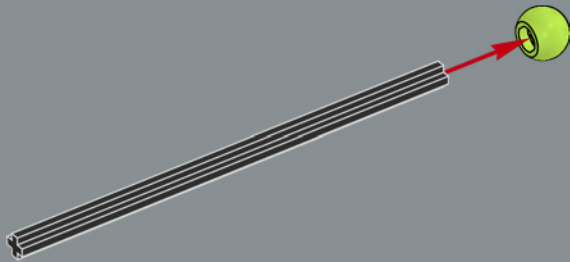

128

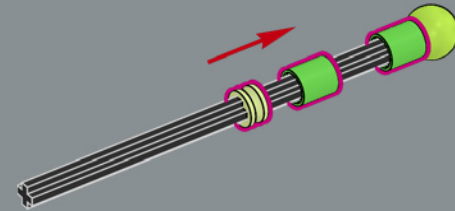

129

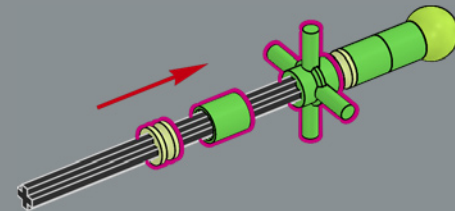



130

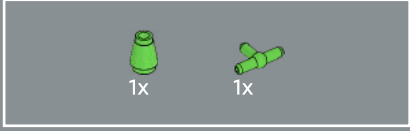
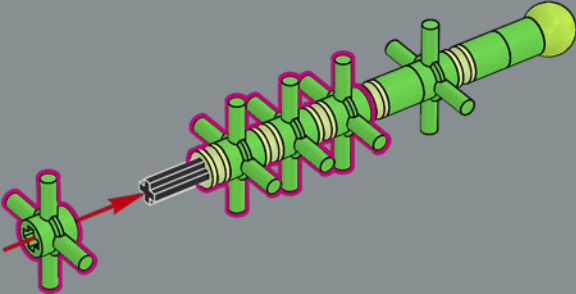

131

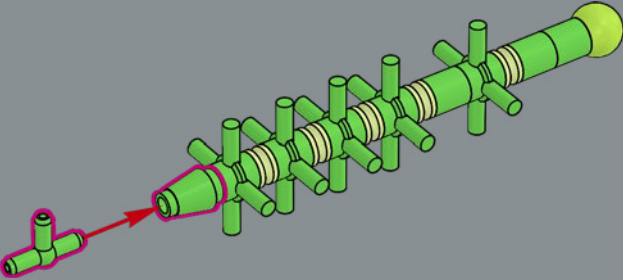

132

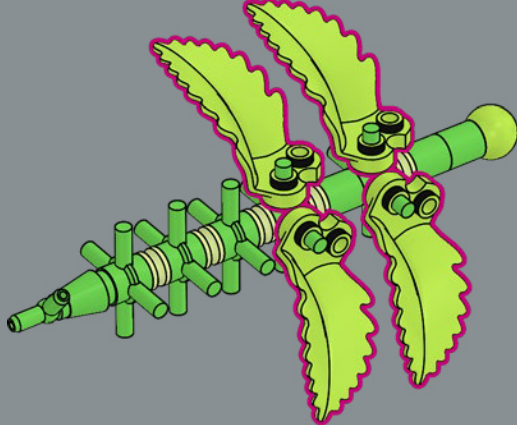

133

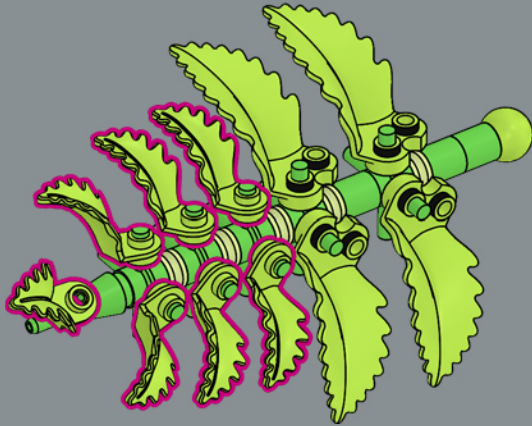

2x





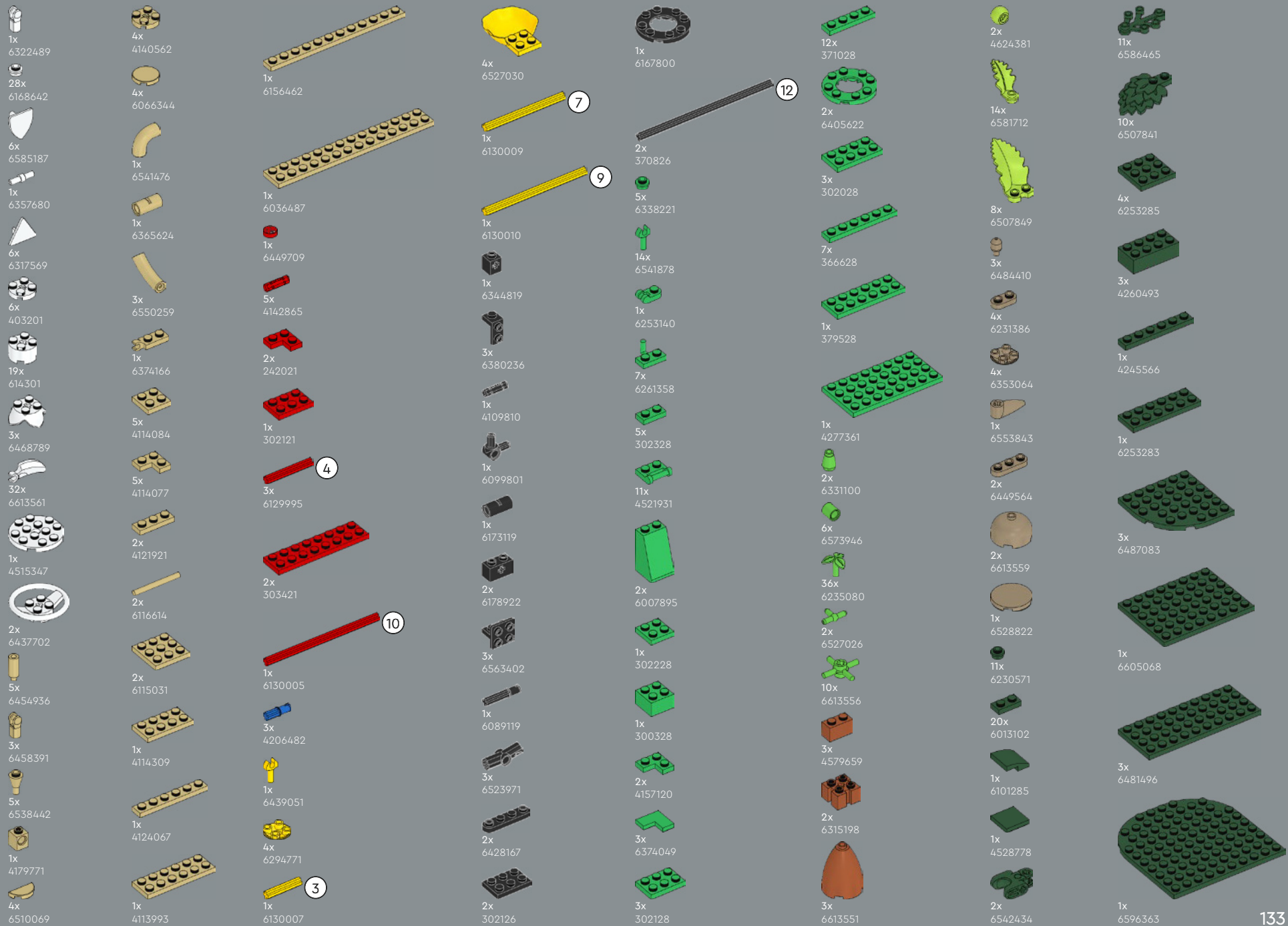



2x
6527031

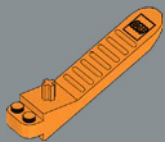

1x
6240515



2x
6510192



5x
6613562



4x
6613560



10x
6553342



1x
6474604



2x
6278550



1x
6360075



10x
4655080



[LEGO.com/service](https://www.LEGO.com/service)



9x
6083976



3x
4616581



13x
6083972



2x
4521947



2x
6080431



3x
6100234

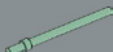

2x
6474602



2x
6577789

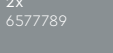

12x
6614067



12x
6614067



2x
6551408



4x
6559515



12x
6439053



6x
4211242



4x
4221744



3x
4211159



7x
6102360



3x
4211150



2x
6313124



3x
6608792



2x
6608792



19x
6117976



1x
6425510



2x
6226436



22x
4645103



2x
6273865



5x
6502370



9x
6551600



4x
6316697



7x
4211200



2x
4211210



4x
4211210



2x
4211210



1x
6425510



2x
4225869



12x
6127366



2x
6492629



4x
6526059



8x
4211149



2x
4216668



3x
4211189



4x
4211190



1x
6395635



3x
6315780



11x
6259071



6x
6568024



12x
6127366



1x
6623716



1x
6623718



1x
6159763



5x
4211193

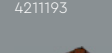

1x
6070442



1x
4216615



4x
6469351



4x
6246843



1x
6395635



3x
6315780

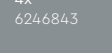

11x
6259071

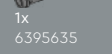

6x
6568024

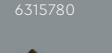

12x
6127366

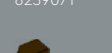

1x
6623716



2x
6623716



10x
4518557



4x
6404033



6x
6353396



2x
6179803



2x
6313874



1x
6005030



8x
6223039



12x
6439052



1x
6623718



1x
6623717



2x
6623716



2x
6623716



2x
6623716



YOU COULD
WIN



**YOU COULD
WIN**

Your feedback will help shape the future development of this product series.

Visit:

**DU KÖNNTEST
GEWINNEN**

Dein Feedback trägt zur Weiterentwicklung dieser Produktreihe bei.

Geh auf:

**VOUS POURRIEZ
GAGNER**

Vos commentaires nous aideront à concevoir les futurs produits de cette gamme.

Visitez :

**POTRESTI
VINCERE TU**

La tua opinione ci aiuterà a migliorare la creazione futura di questa linea di prodotti.

Visita:

**PUEDES
GANAR**

Tu opinión contribuirá al futuro de esta serie de productos.

Visita:

轻松获奖

您的反馈将有助于我们在今后改进本产品系列。

请访问:

LEGO.com/productfeedback

You also have the chance to win a LEGO® set.

Terms and conditions apply.*

Außerdem hast du die Chance, ein LEGO® Set zu gewinnen.

Es gelten die Teilnahmebedingungen.*

Vous pourriez également gagner un ensemble LEGO®.

Des conditions s'appliquent.*

Hai anche la possibilità di vincere un set LEGO®.

Termini e condizioni sono applicabili.*

También tienes la oportunidad de ganar un set LEGO®.

Aplican términos y condiciones.*

您还有机会赢取乐高®套装。

条款和条件适用。*

*LEGO.com/productfeedback-terms

LEGO and the LEGO logo are trademarks of the LEGO Group.
©2026 The LEGO Group.

 6650753

