



CITY

60512



LEGO® Builder



Get excited about our new packaging!

We're switching from plastic to paper-based packaging. That's why you might find a mix of paper and plastic in our boxes!

Nos nouveaux emballages vous emballeront !

Nous passons des emballages en plastique aux emballages à base de papier. C'est pourquoi vous pourriez trouver un mélange de papier et de plastique dans nos boîtes !

¡Te presentamos nuestros nuevos empaques!

Estamos sustituyendo las bolsas de plástico por bolsas con base de papel. ¡Por eso, puedes encontrar una mezcla de papel y de plástico en nuestras cajas!

[LEGO.com/sustainable-packaging](https://www.lego.com/sustainable-packaging)

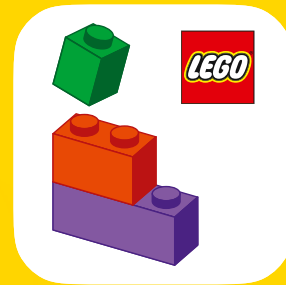

LEGO® Builder



BUILDER



Apple and the Apple logo are trademarks of Apple Inc., registered in the U.S. and other countries and regions. App Store is a service mark of Apple Inc. Google Play and the Google Play logo are trademarks of Google LLC. Tencent and the Tencent logo are trademarks of Tencent Inc.

LEGO.com/devicecheck

EN Ask parents' permission before going online | **DE** Eltern um Erlaubnis bitten, bevor du online gehst | **FR** Demande l'autorisation d'un parent avant d'aller en ligne | **IT** Chiedi il permesso ai tuoi genitori prima di andare online | **ES** Pídeles permiso a tus papás antes de conectarte a Internet | **PT** Pede autorização aos teus pais antes de ficares online | **ZH** 上网前应先征得父母的同意 | **PL** Poproś rodziców o zgodę, zanim wejdiesz do Internetu | **CS** Než půjdeš na internet, požádej rodiče o svolení | **SK** Skôr než pôjdeš na internet, vypýtaj si povolenie od rodičov | **HU** Kérj szülői engedélyt, mielőtt online csatlakoznál! | **UA** Запитуйте дозволу батьків, перш ніж користуватися інтернетом | **RO** Cere permisiunea părinților înainte de a te conecta online | **BG** Поискайте разрешение от родител, преди да влезете онлайн | **LV** Pirms došanās tiešsaistē palūdz atļauju vecākiem | **ET** Enne Interneti kasutamist küsi vanematelt luba | **LT** Prieš prisijungdami prie interneto, atsiklauskite tėvų | **TR** İnternete girmeden önce anne babandan izin iste



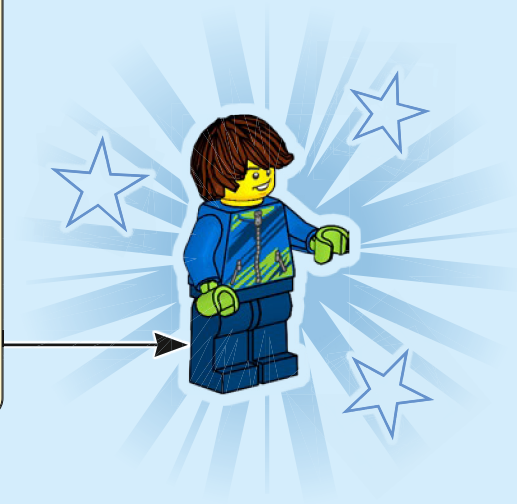
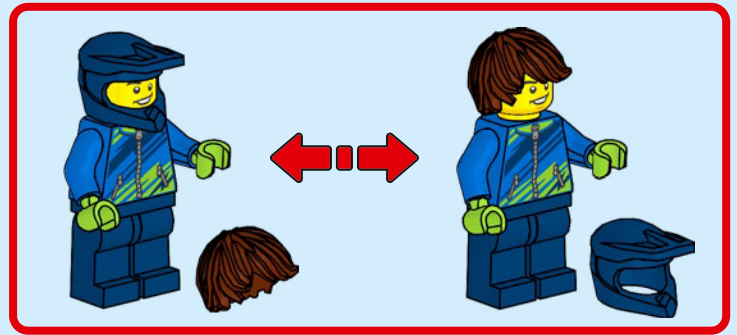
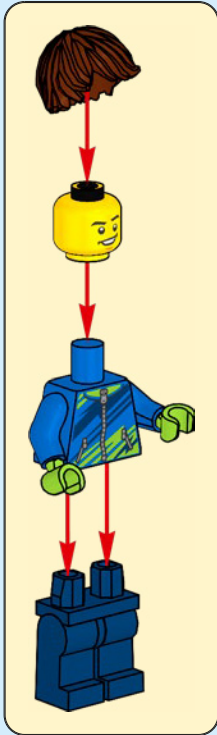

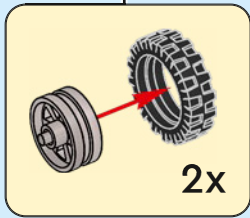
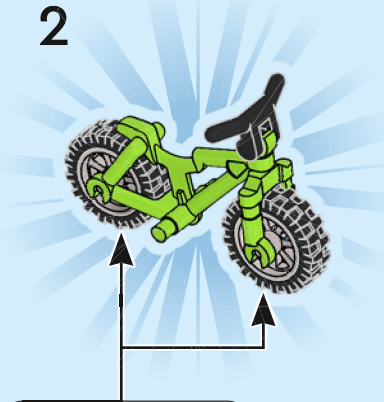
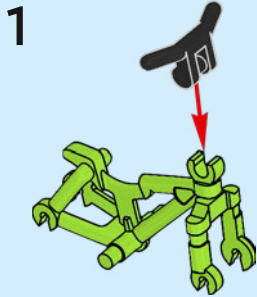
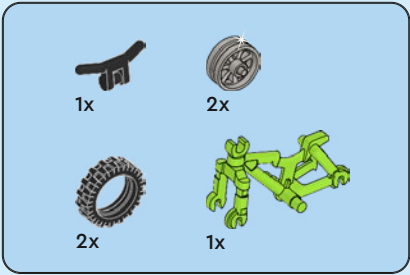

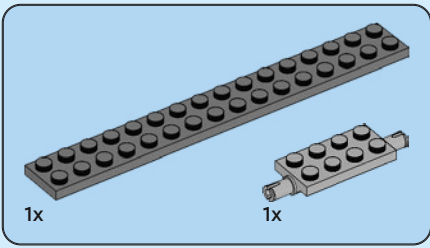

1

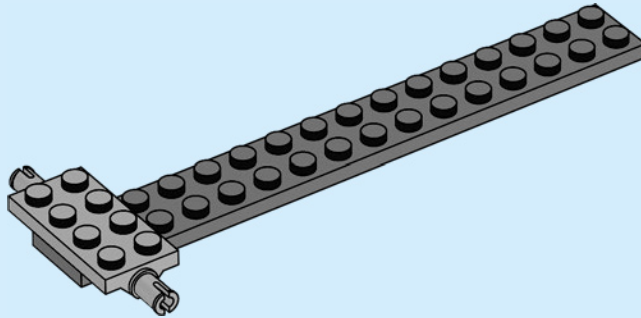



2x



2x

2

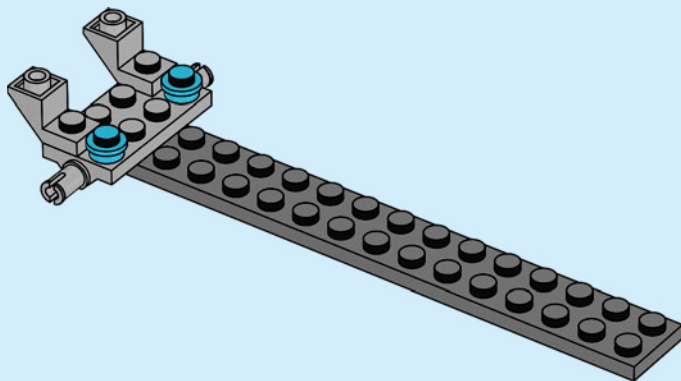

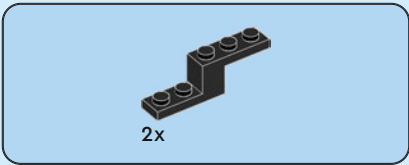

3

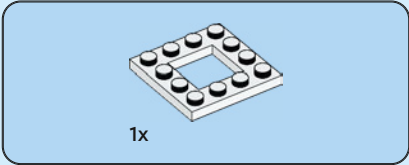
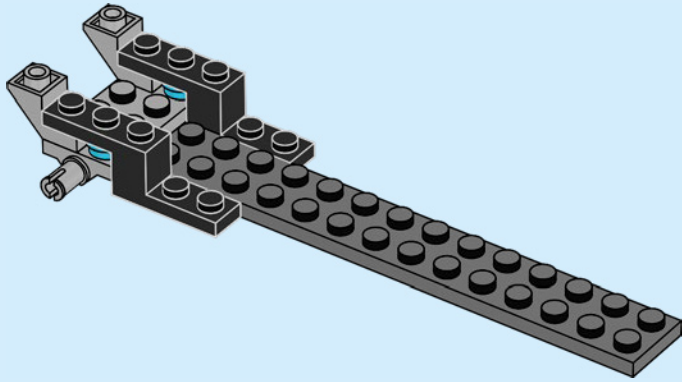

4

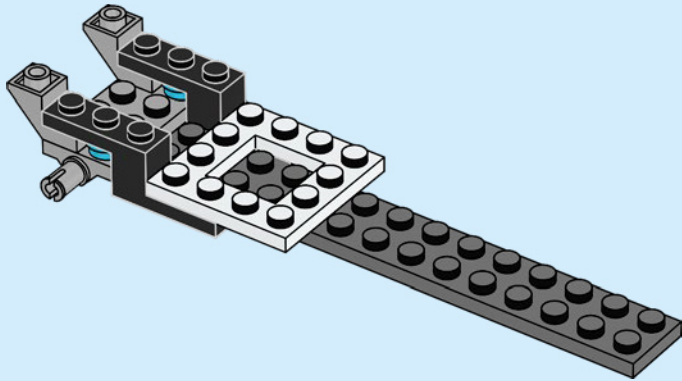

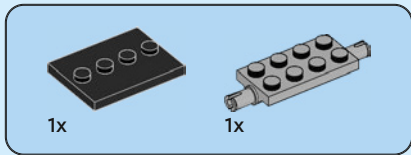

5

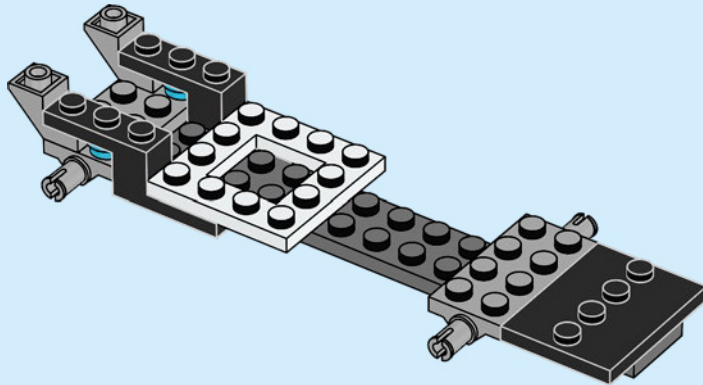

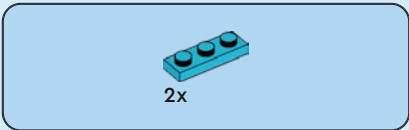

6

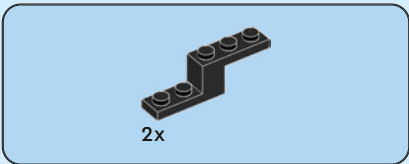
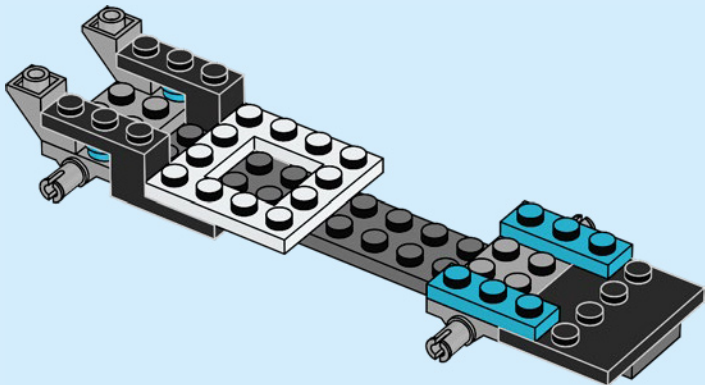

7

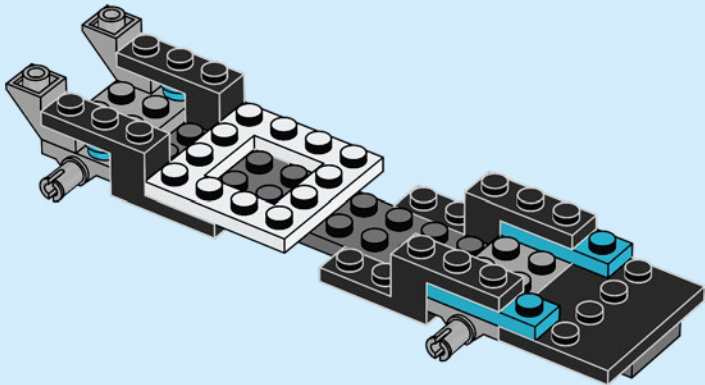



2x

8

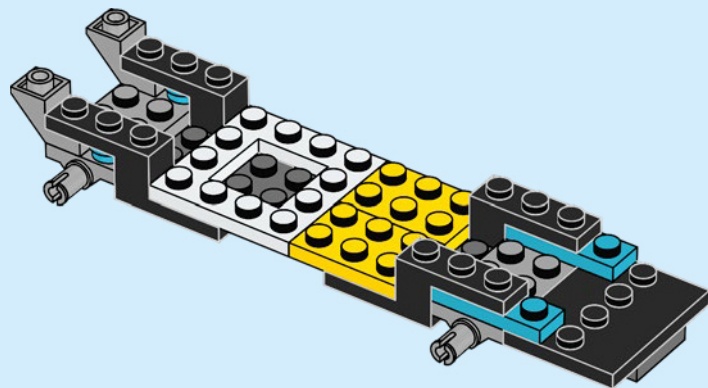

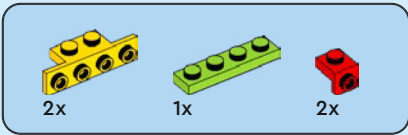

9

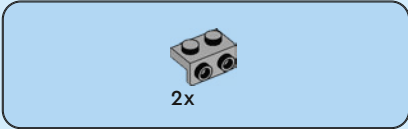
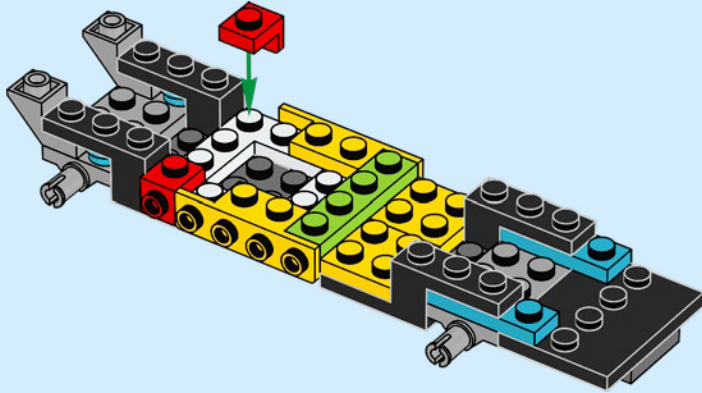

10

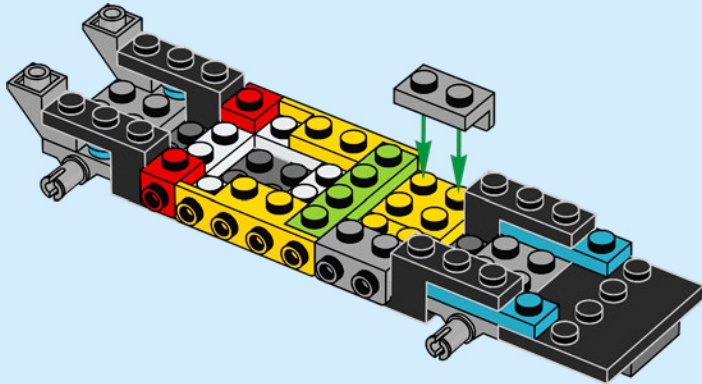

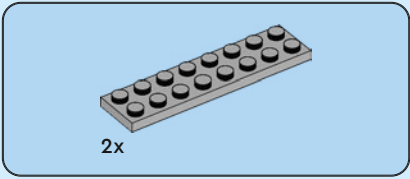

11

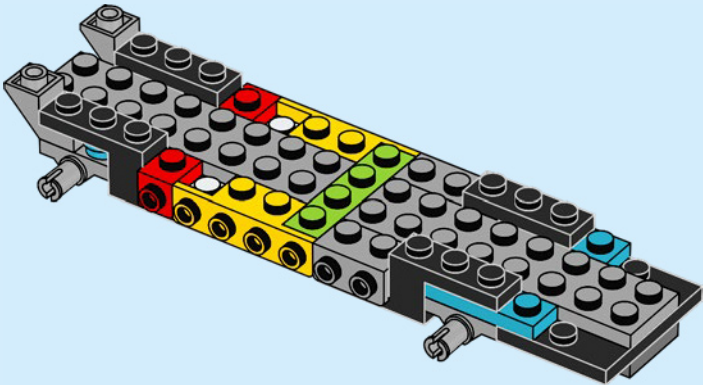

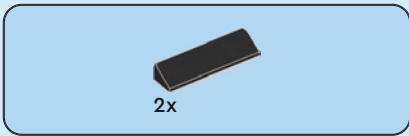

12

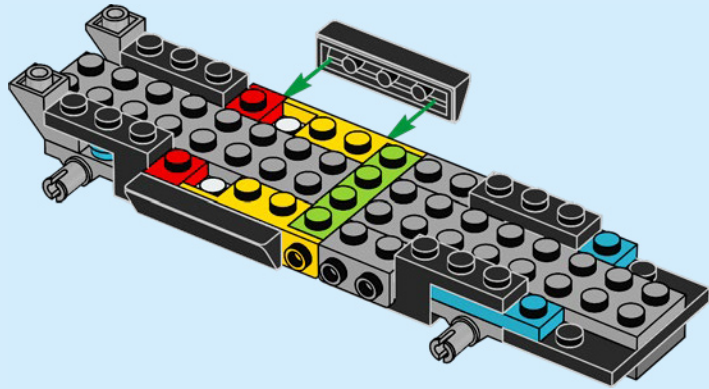

13

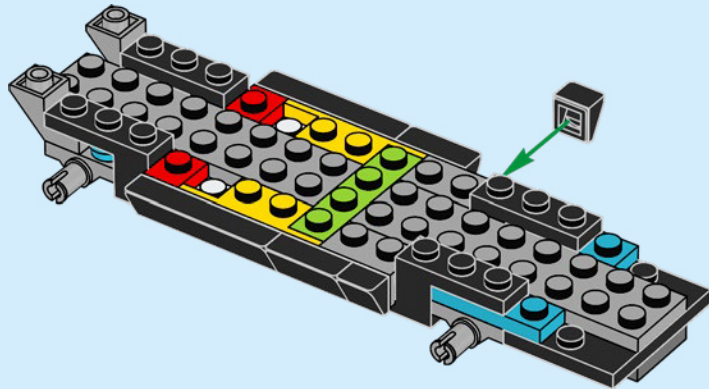

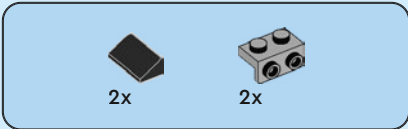

14

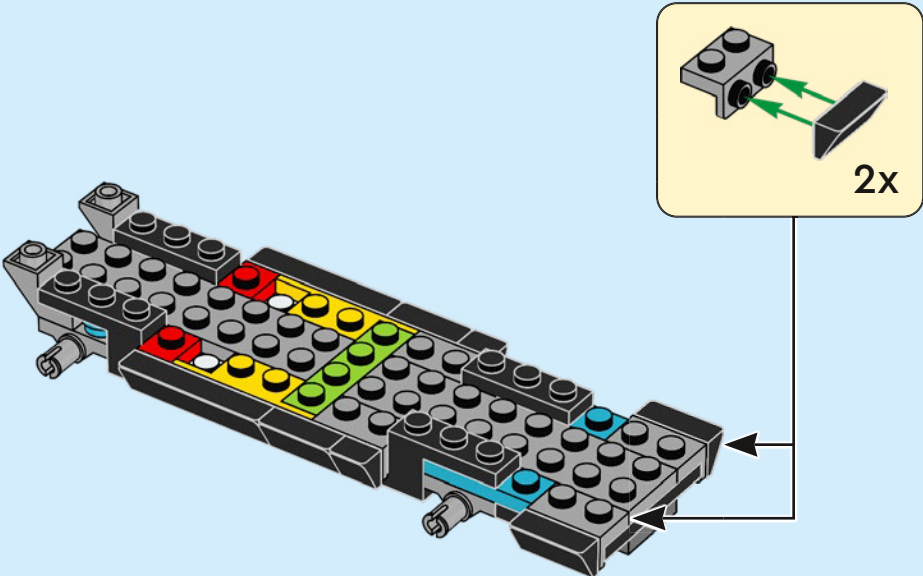



1x

15

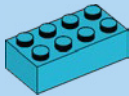
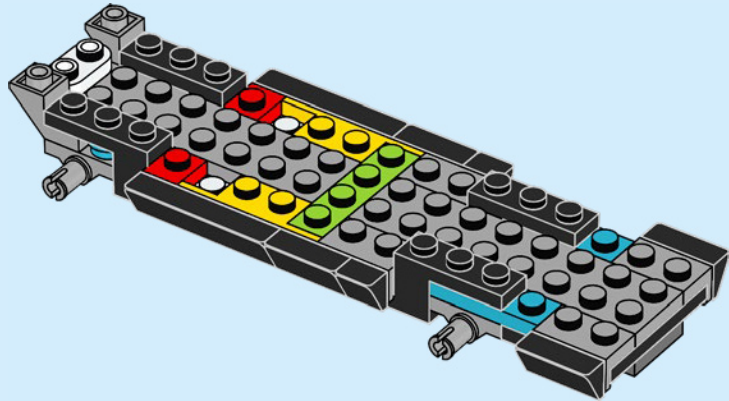

1x

16

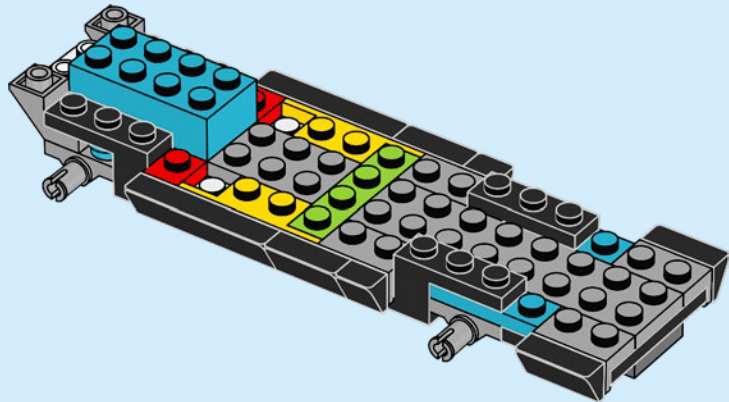



2x

17

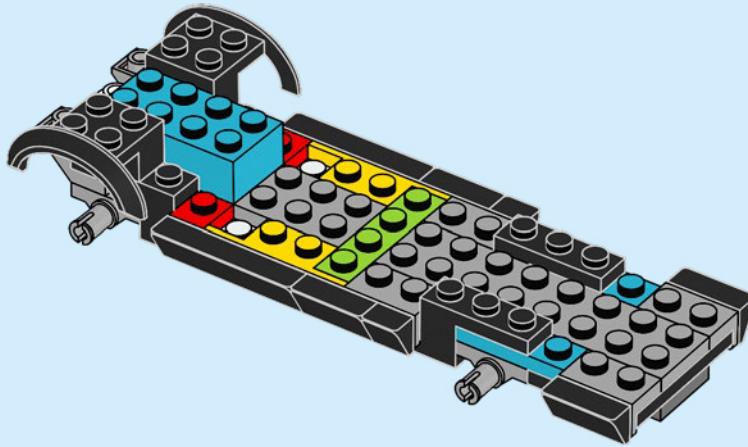



2x



2x

18

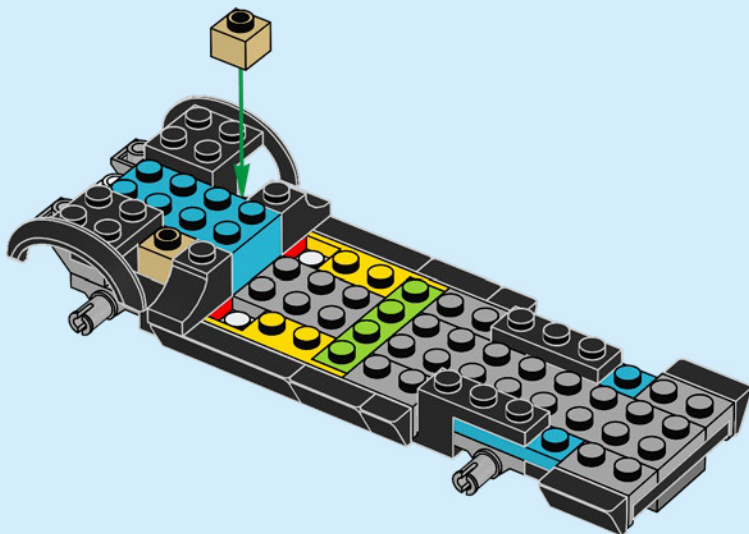

1x



2x

19

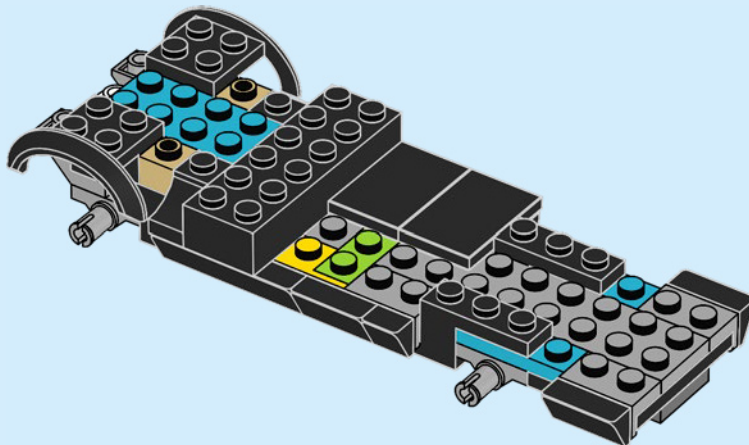



1x



1x

20

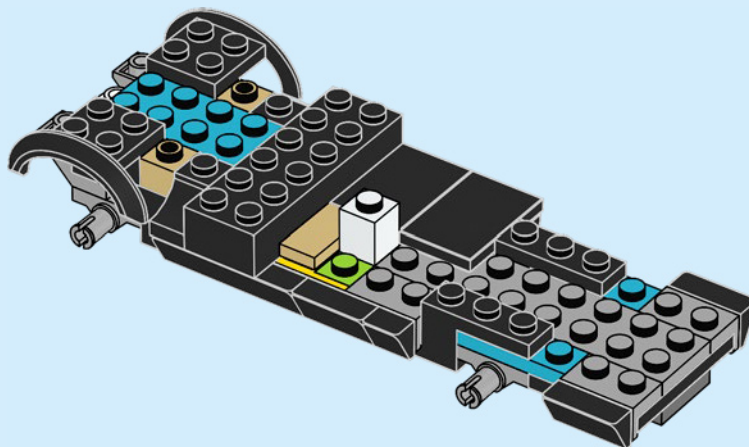

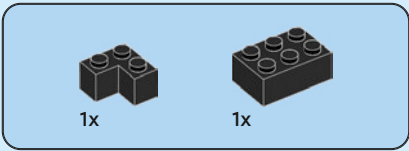

21

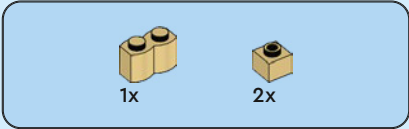
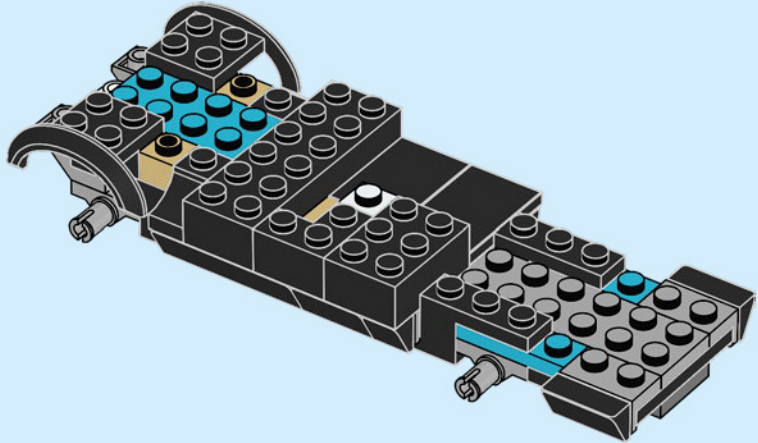

22

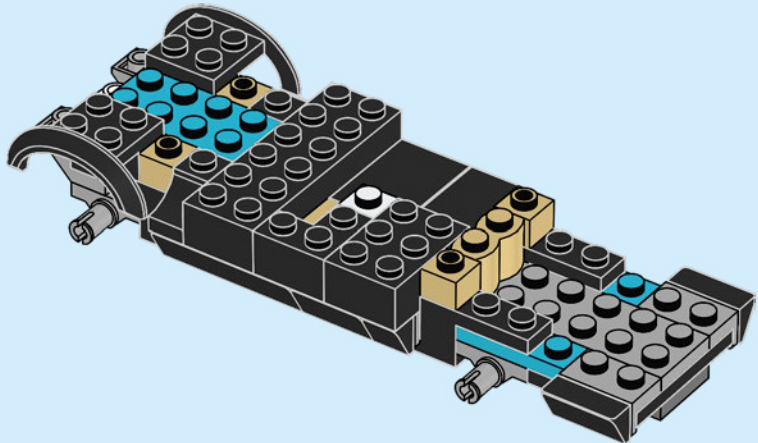



2x

23

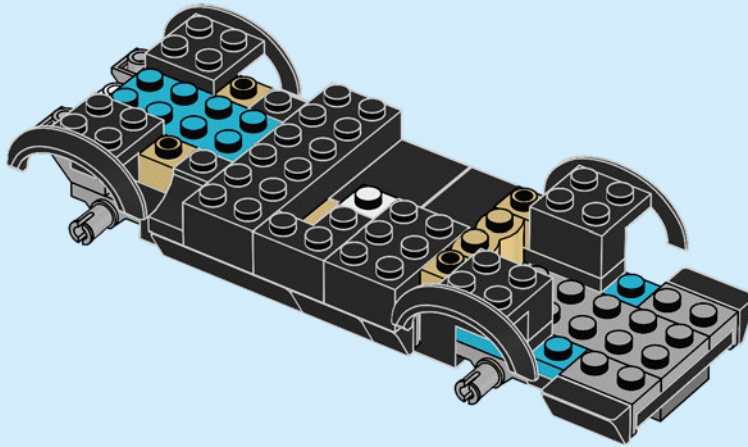



2x

24

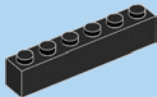
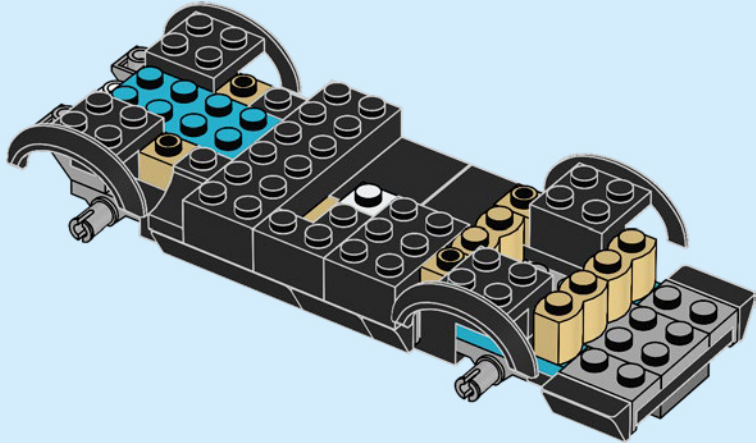

1x

25

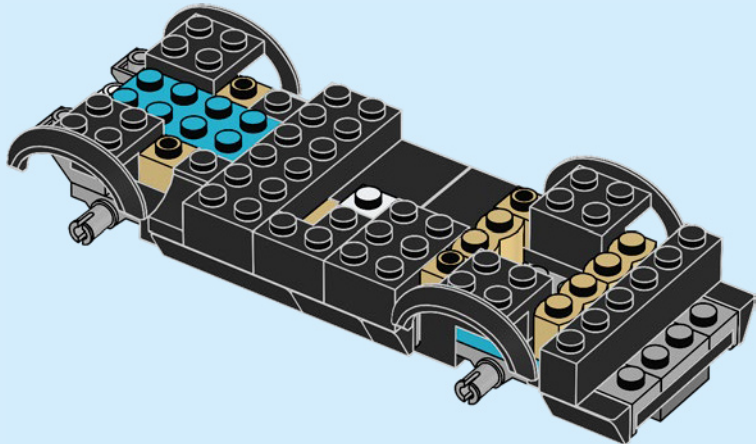



1x

26

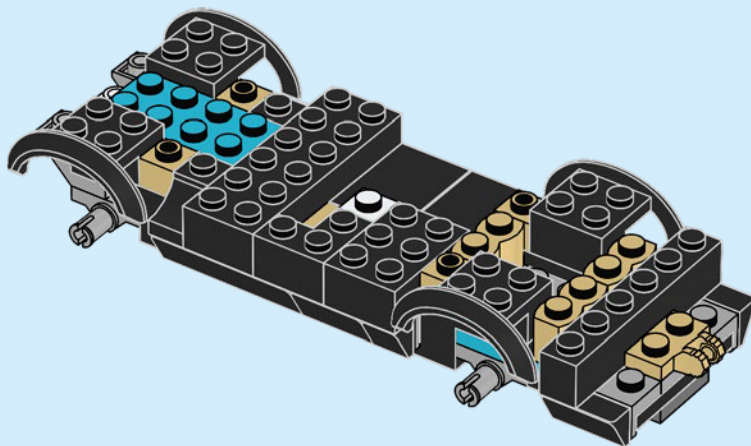



2x

27

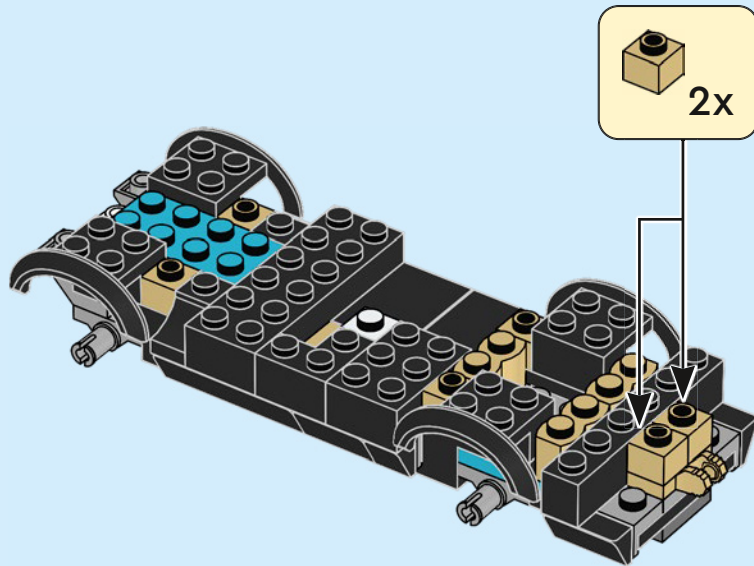



28

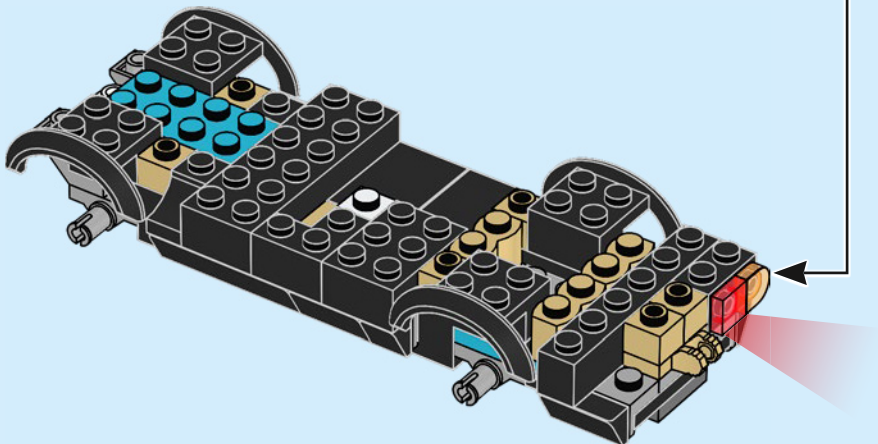
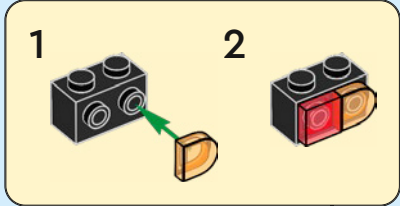



29

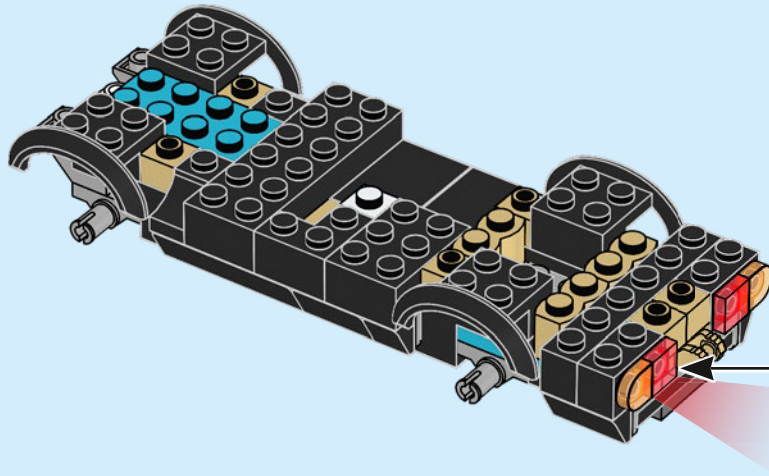
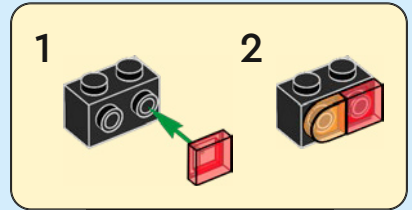



2x

30

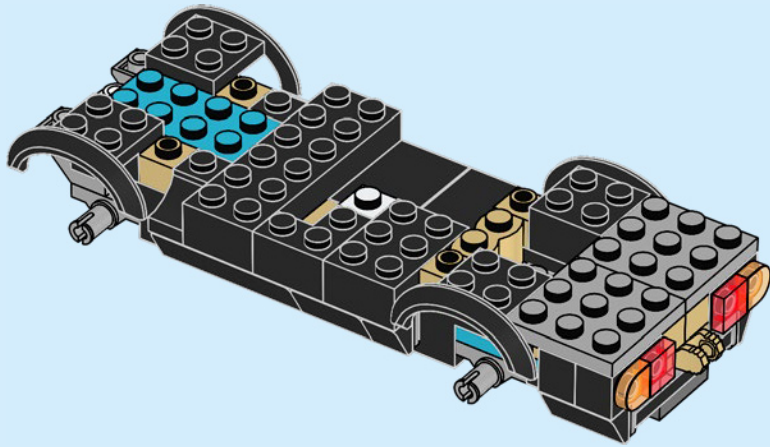

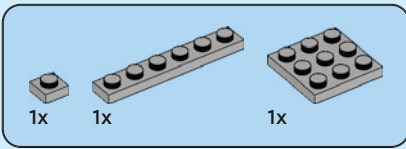

31

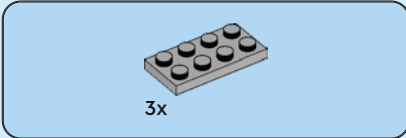
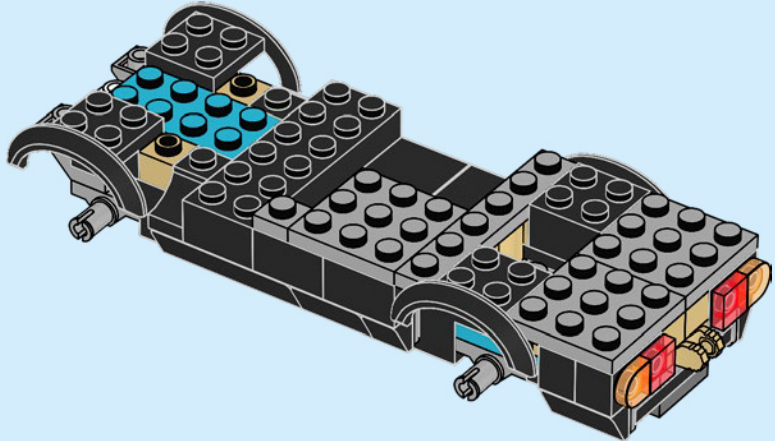

32

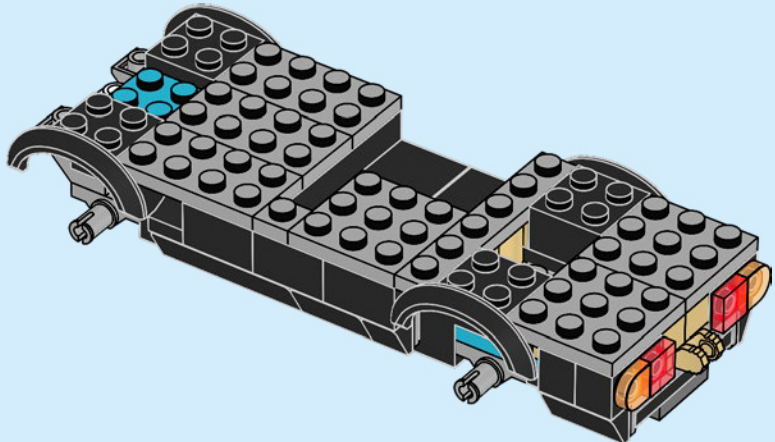

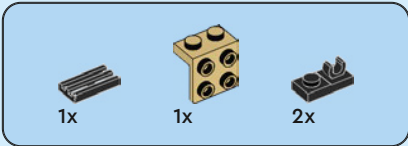

33

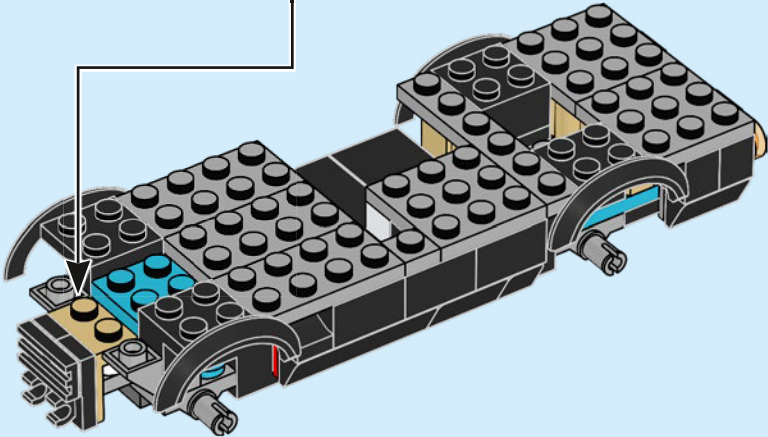
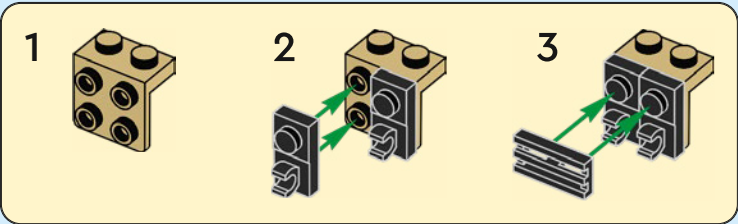



2x

34

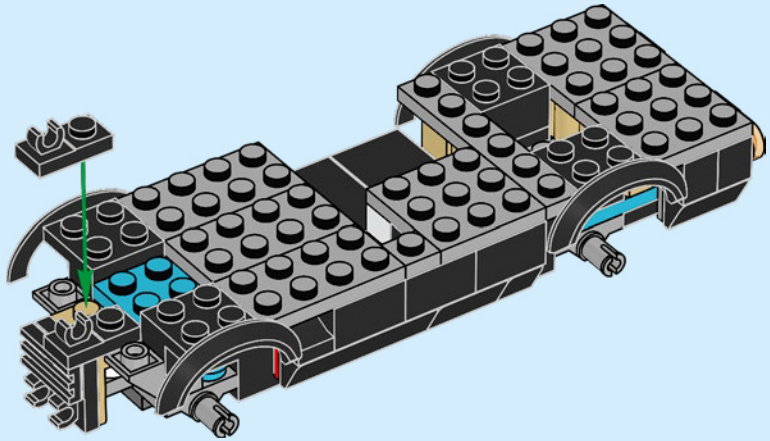

1x

35

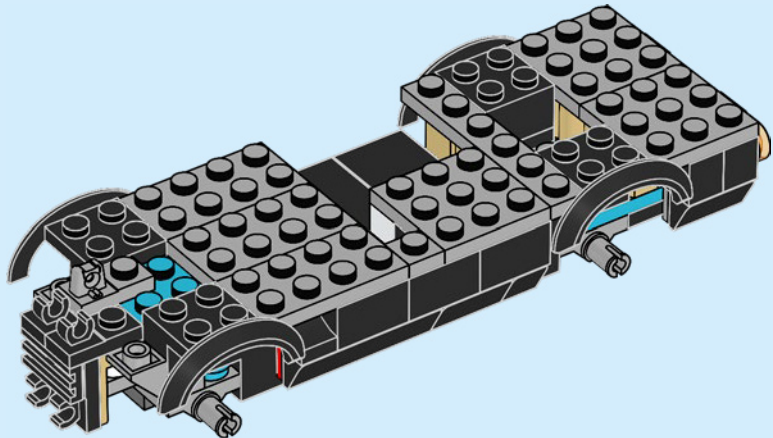



1x



1x

36

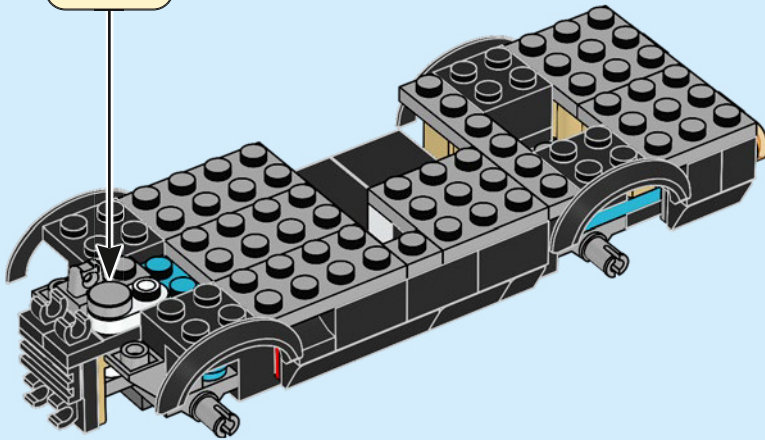
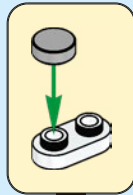



1x

37

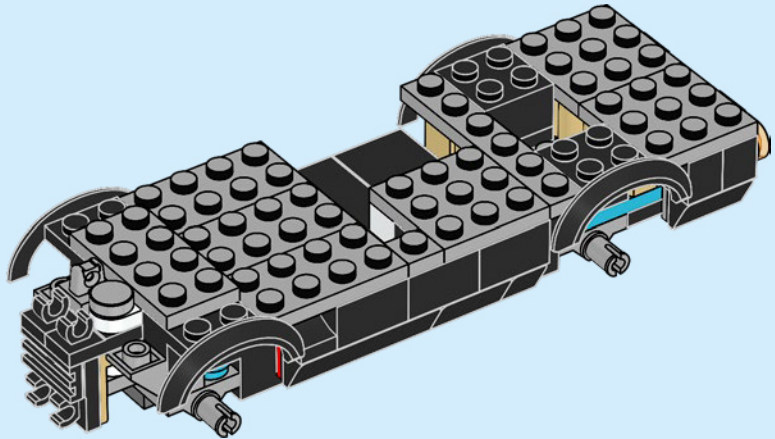

2x



2x

38

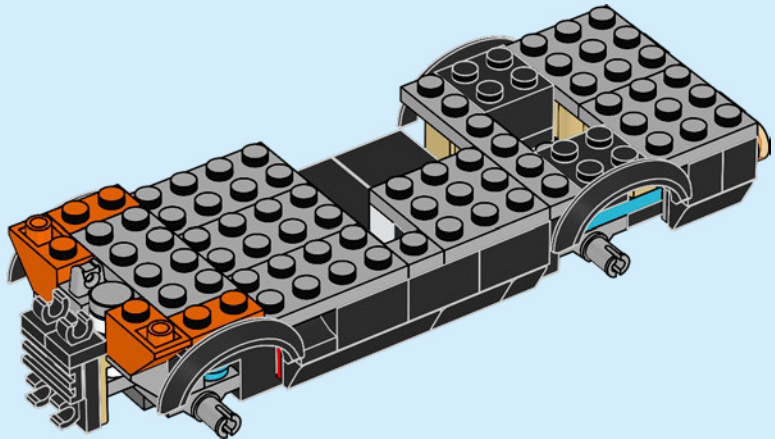

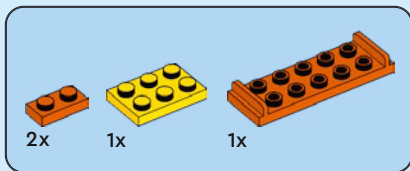

39

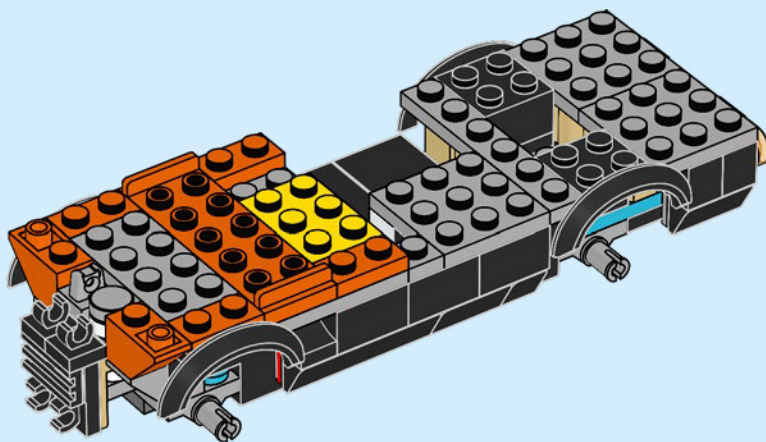

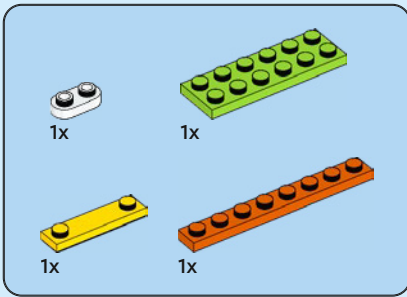

40

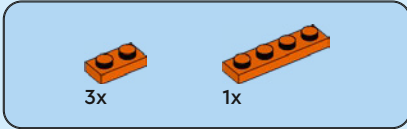
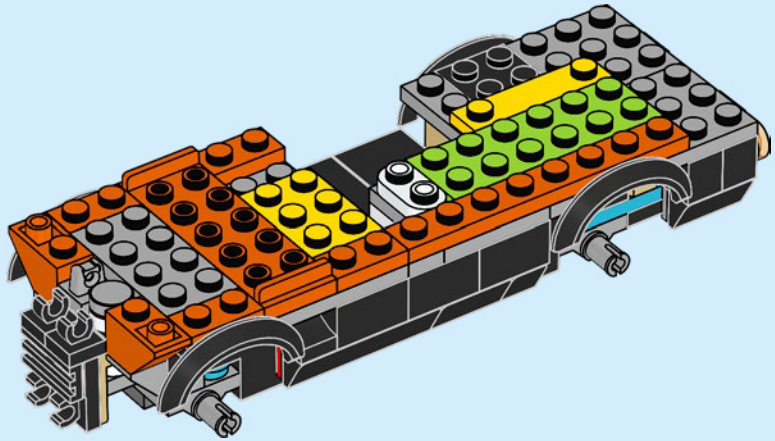

41

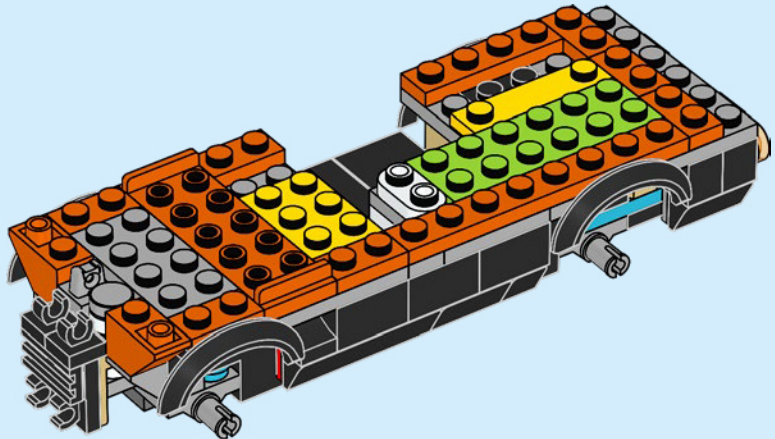



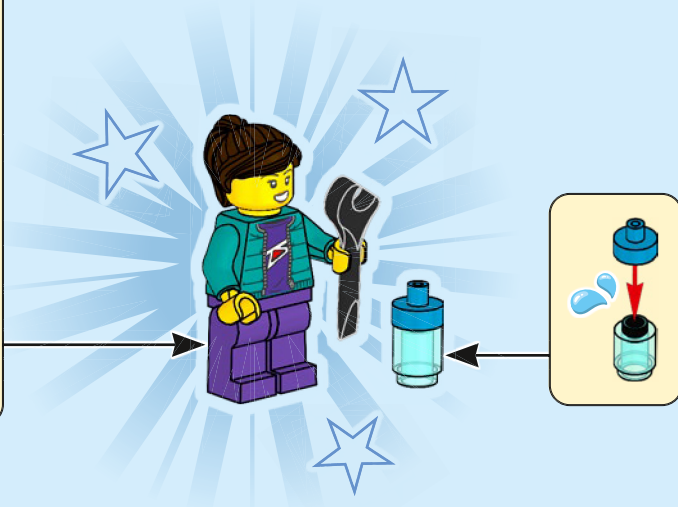
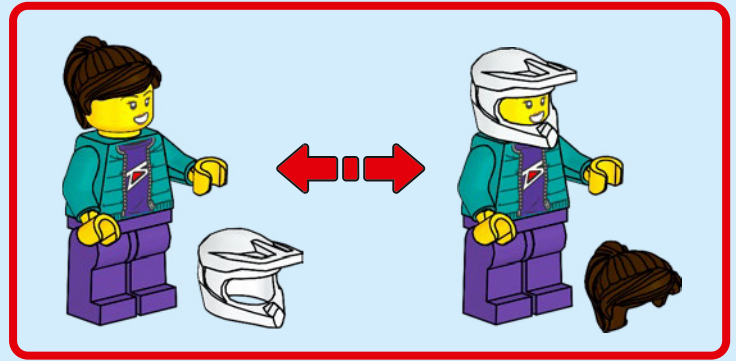
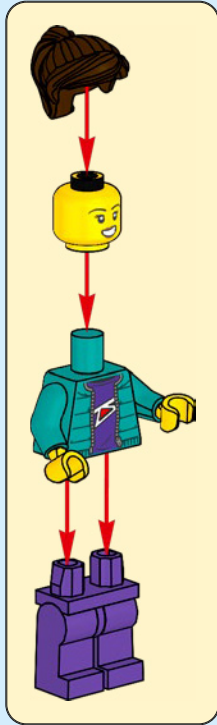

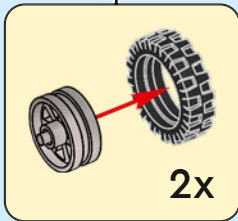
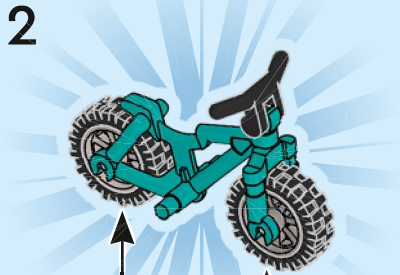
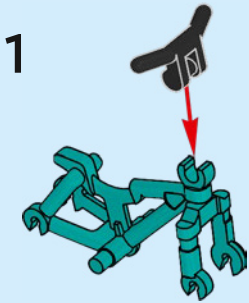
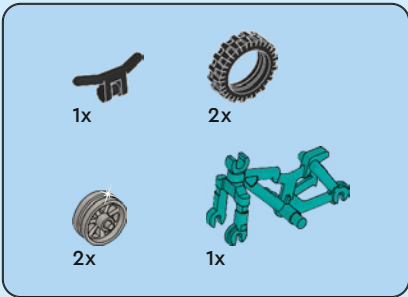

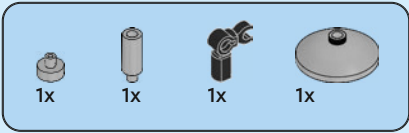

1

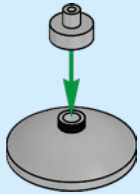

2

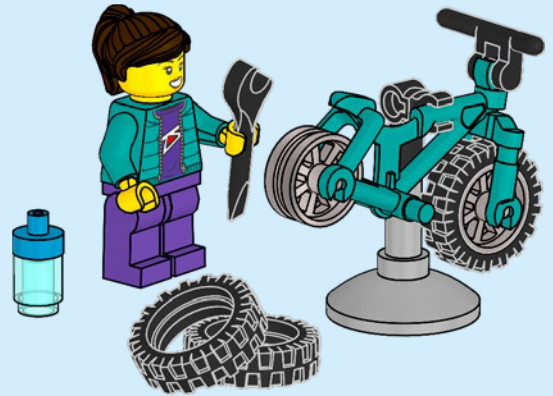
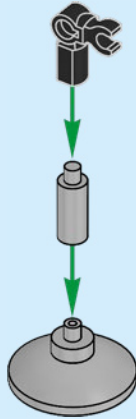

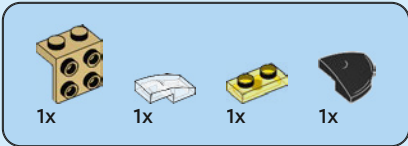

42

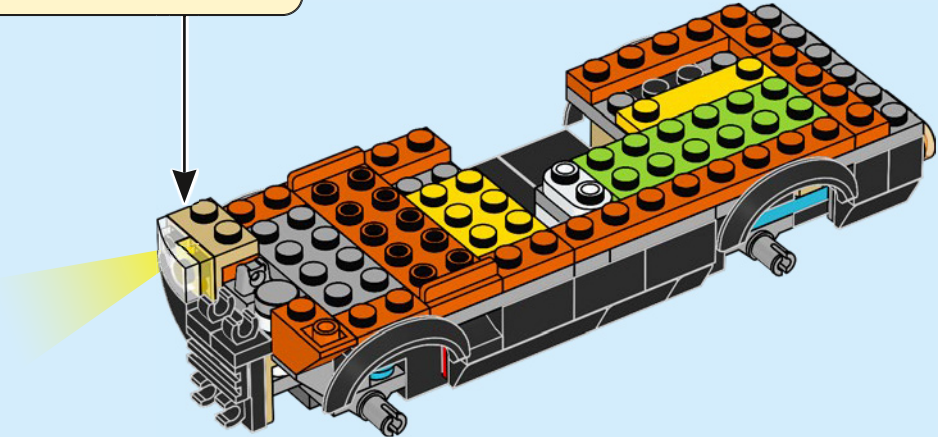
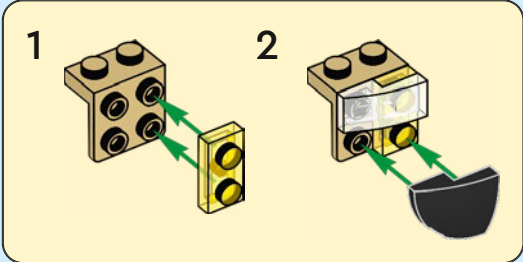

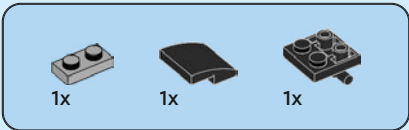

43

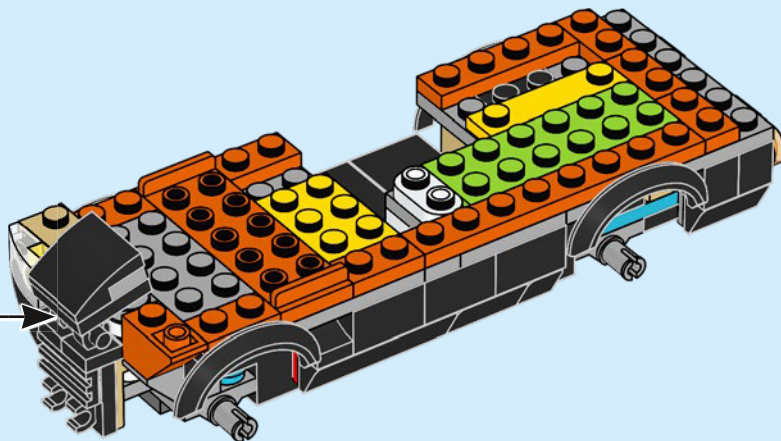
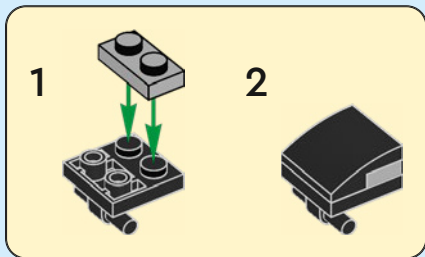

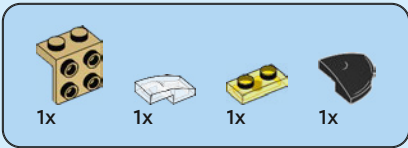

44

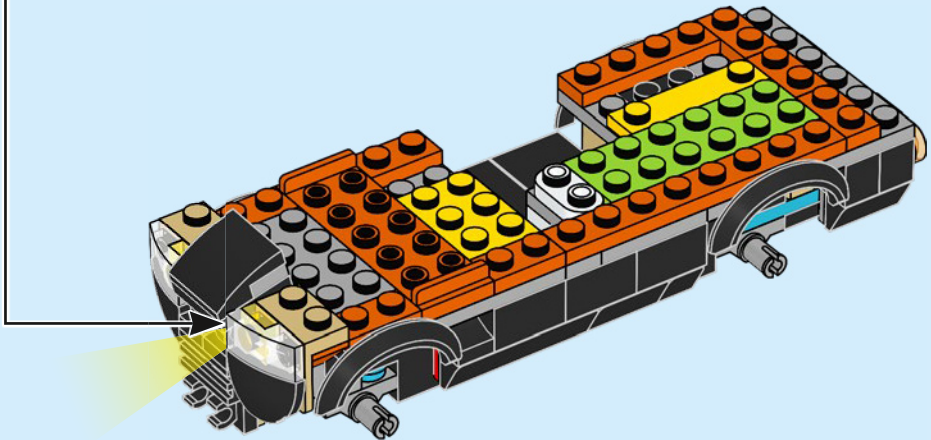
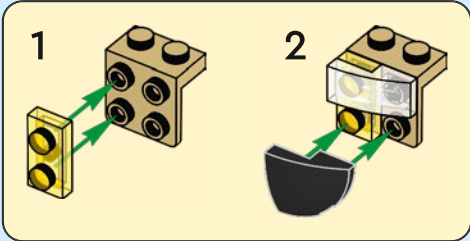

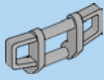

1x

45

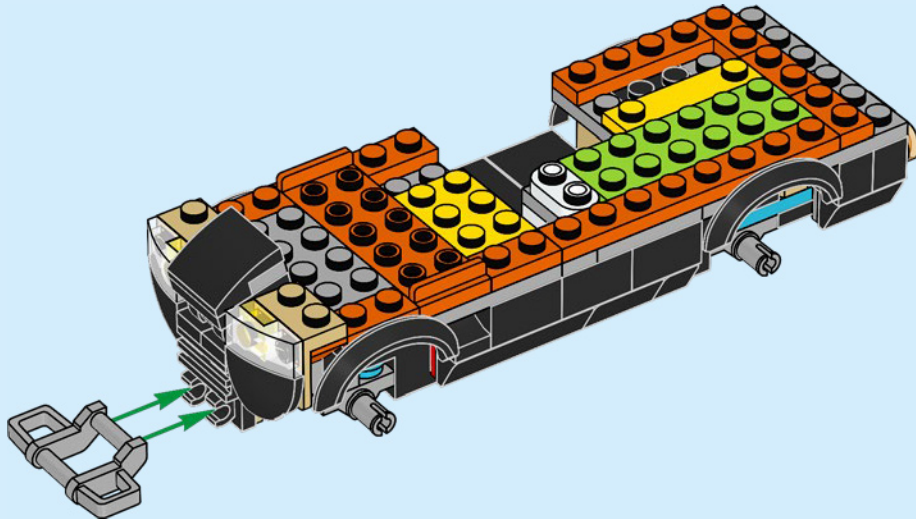

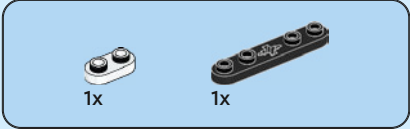
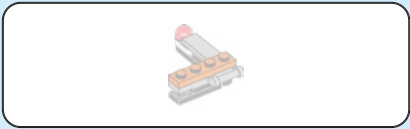

46

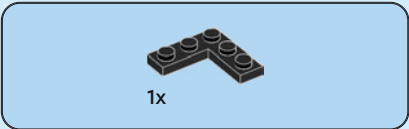
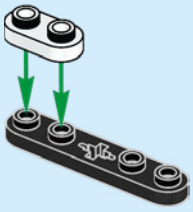

47

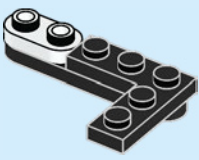



1x

48

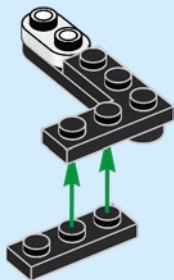

1x

49

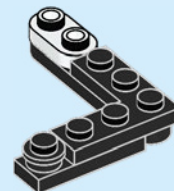

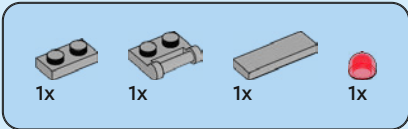

50

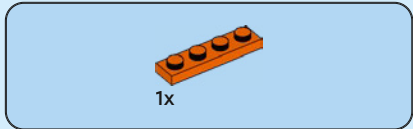
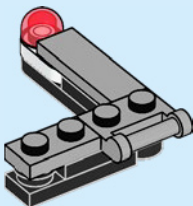

51

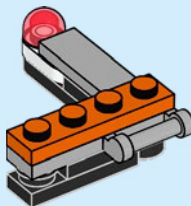

52

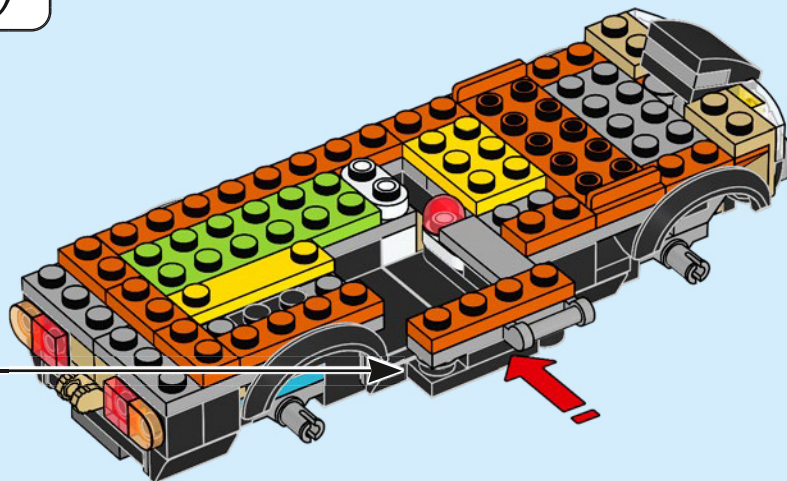

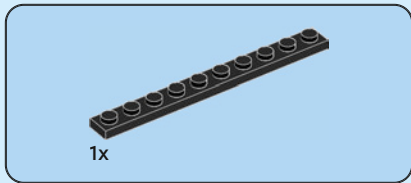

53

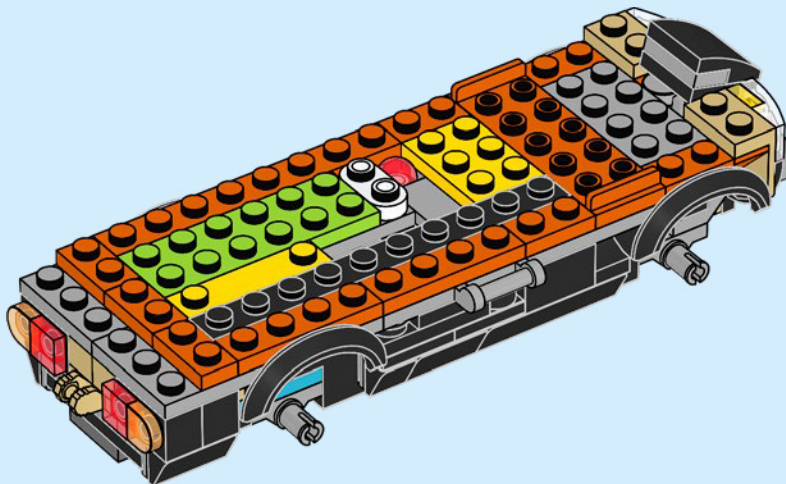

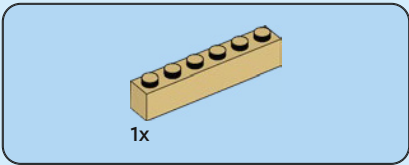

54

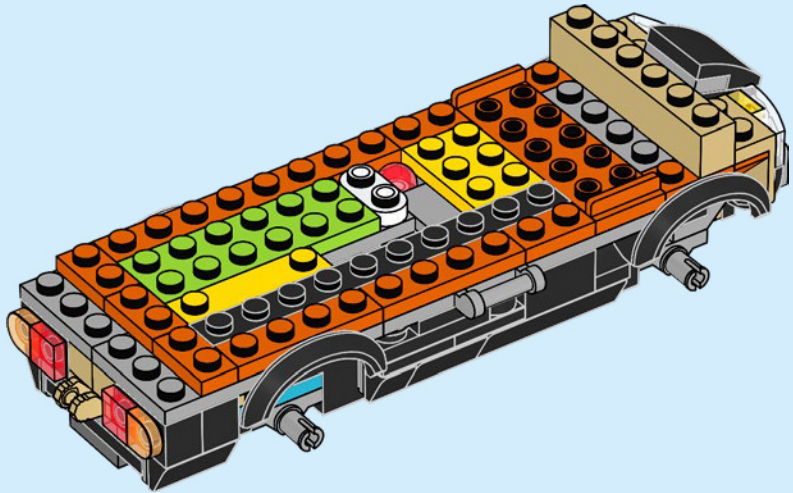

55

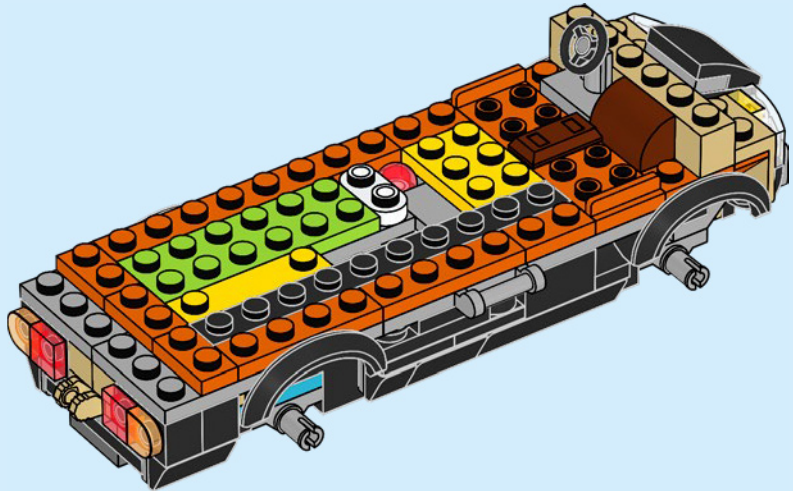



1x



1x

56

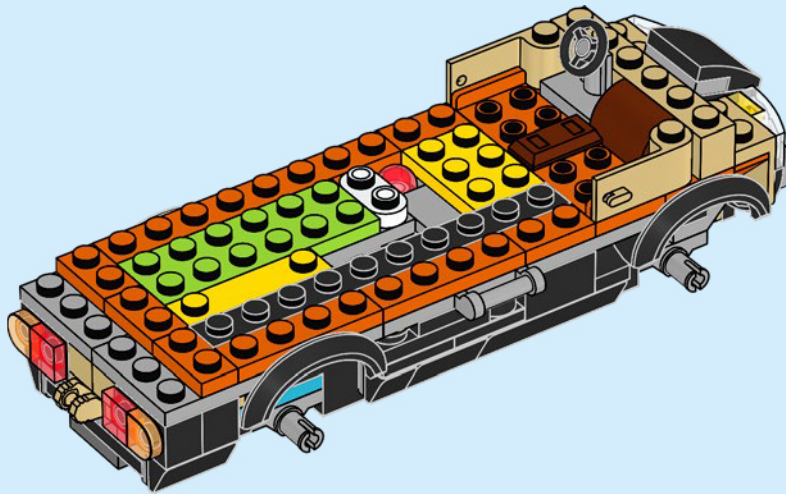



2x



2x

57

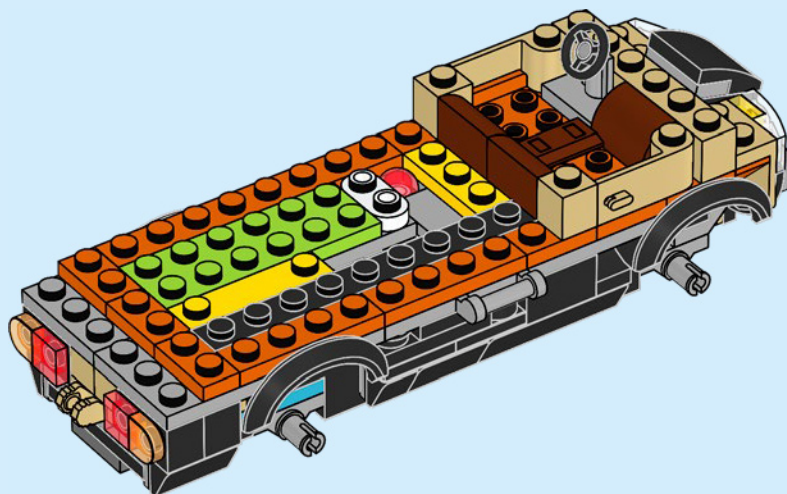

1x



1x



1x

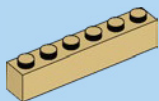

1x

58

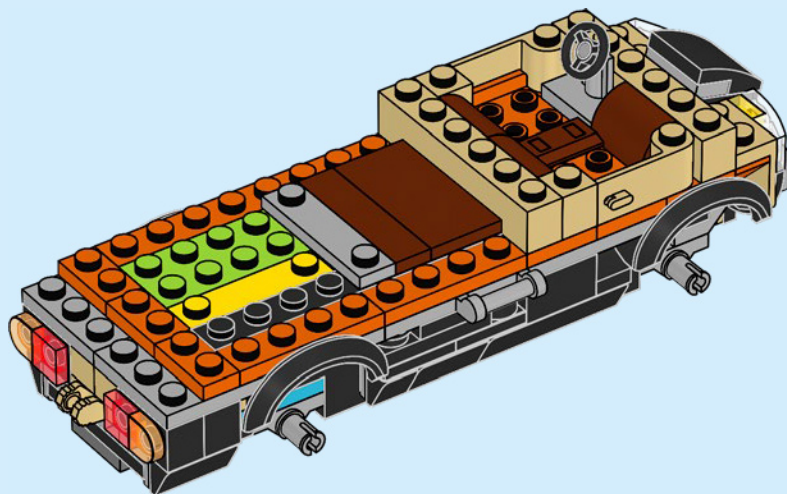

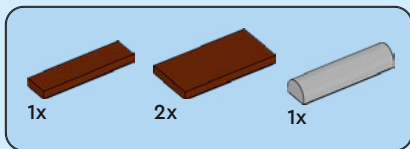

59

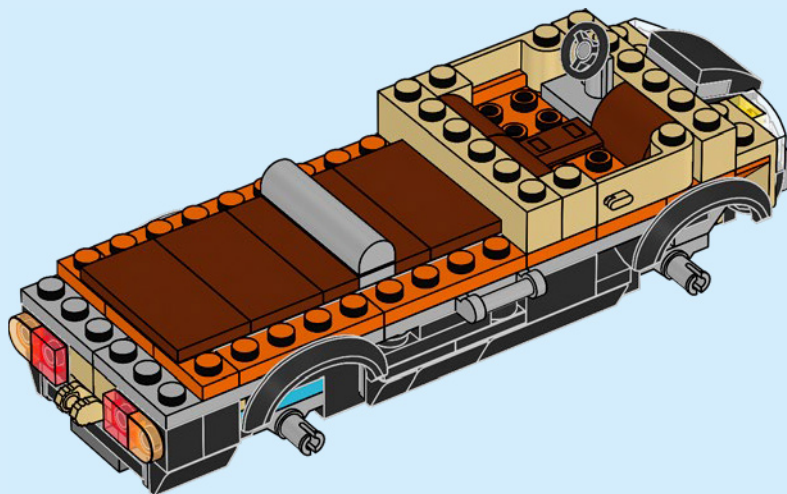

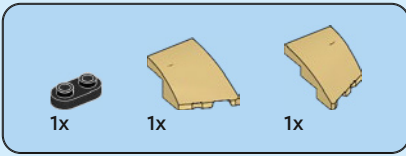

60

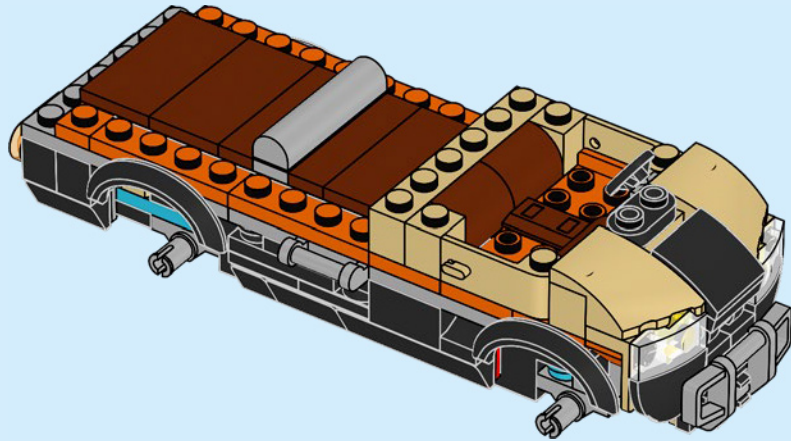



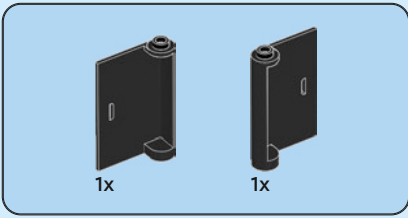

61

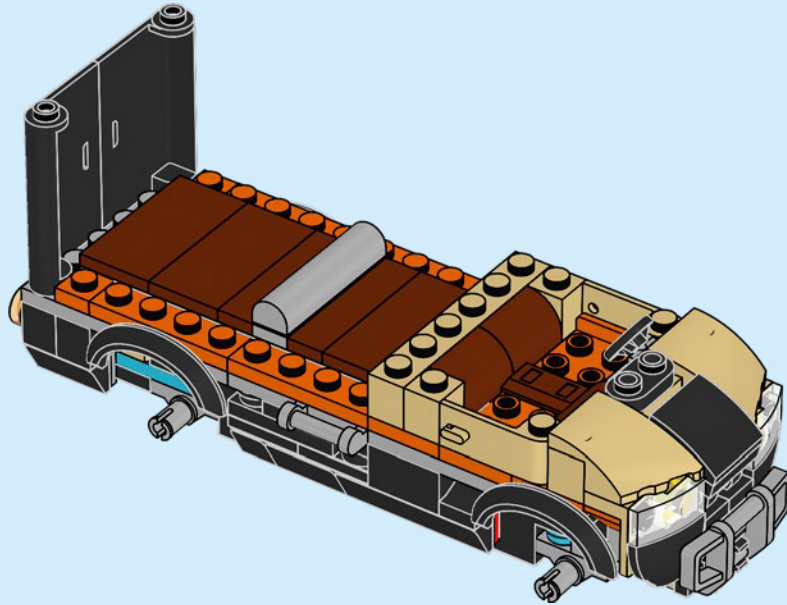

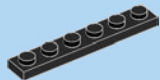

1x

62

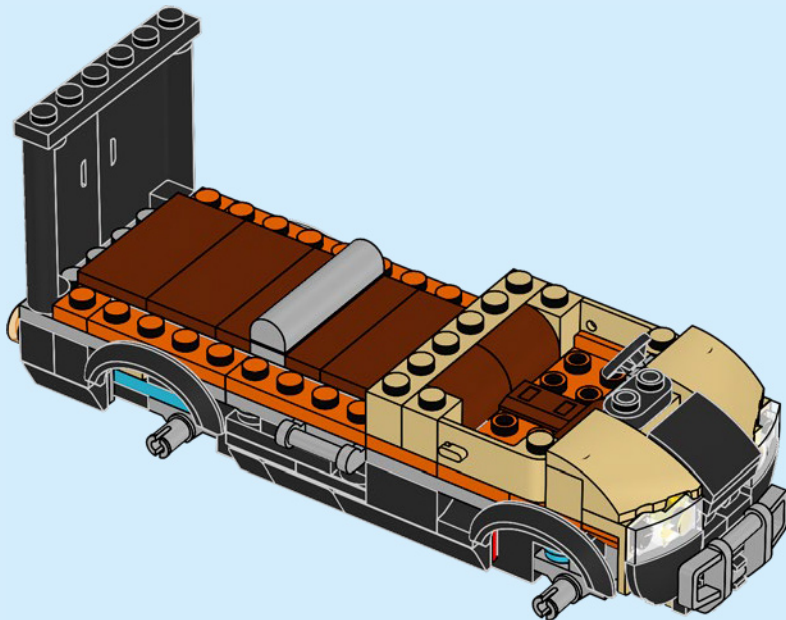



2x

63

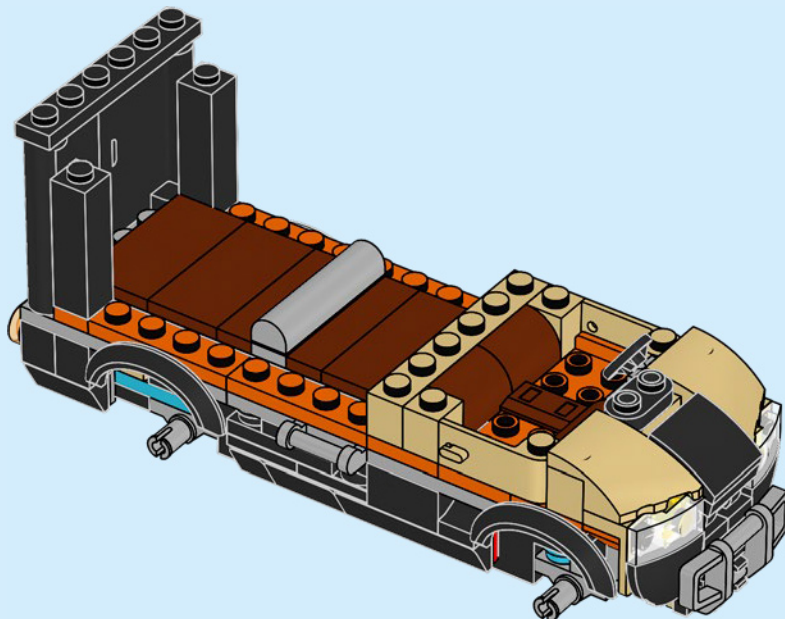

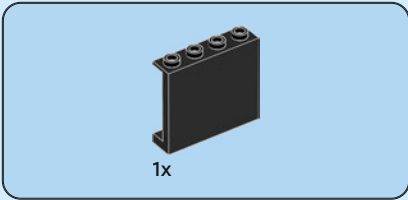

64

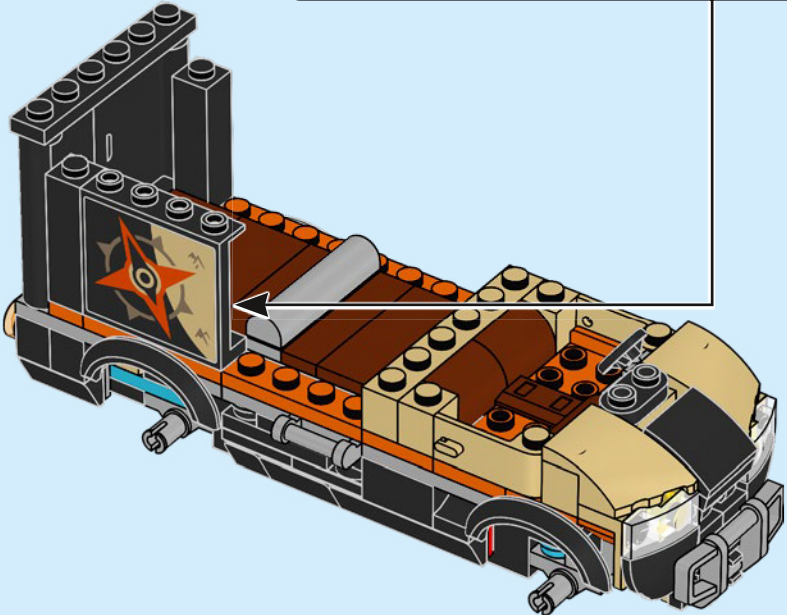
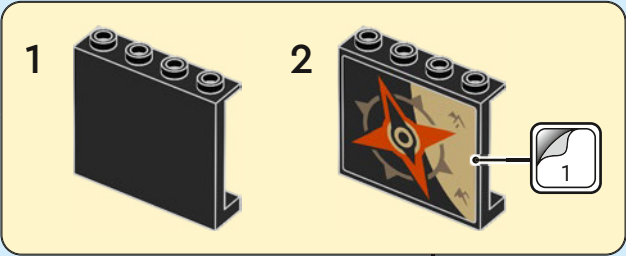



1x



1x

65

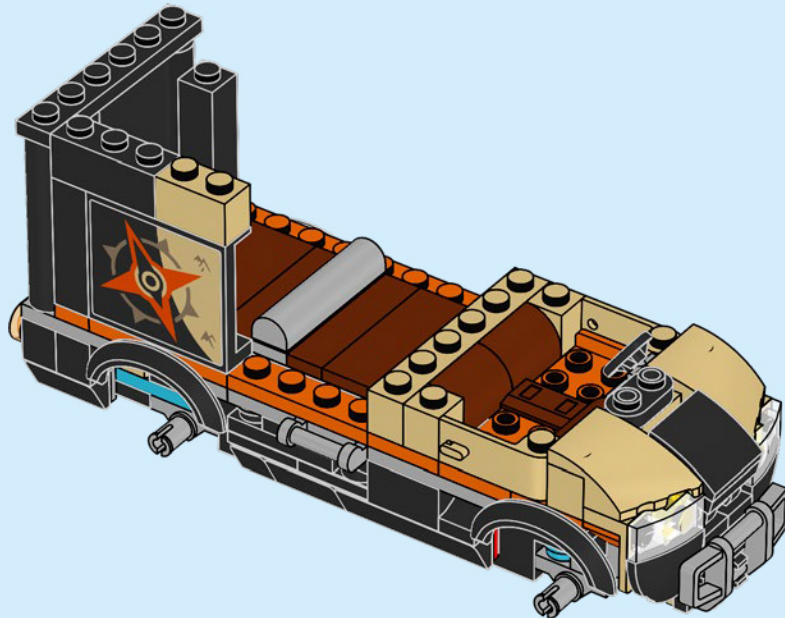

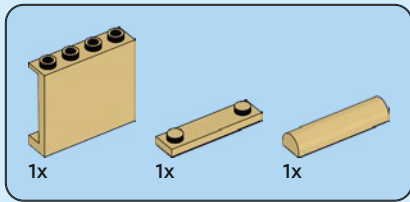

66

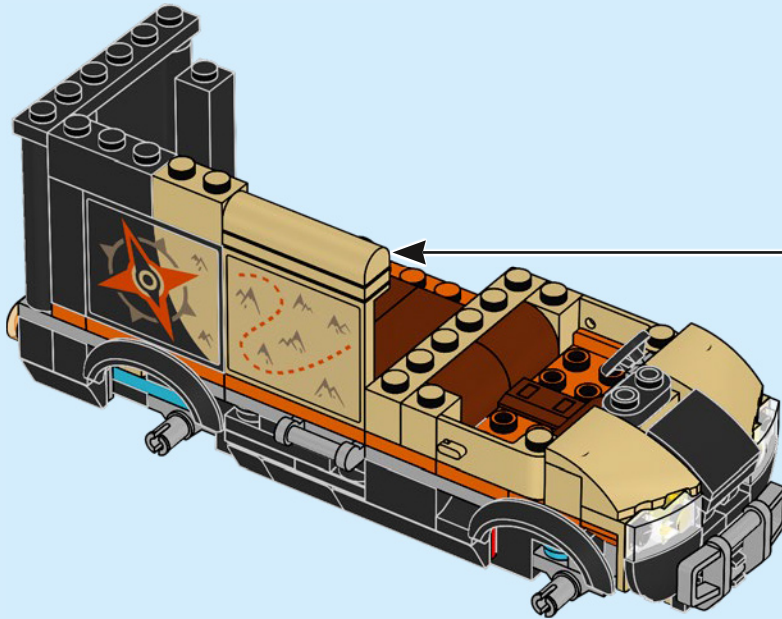
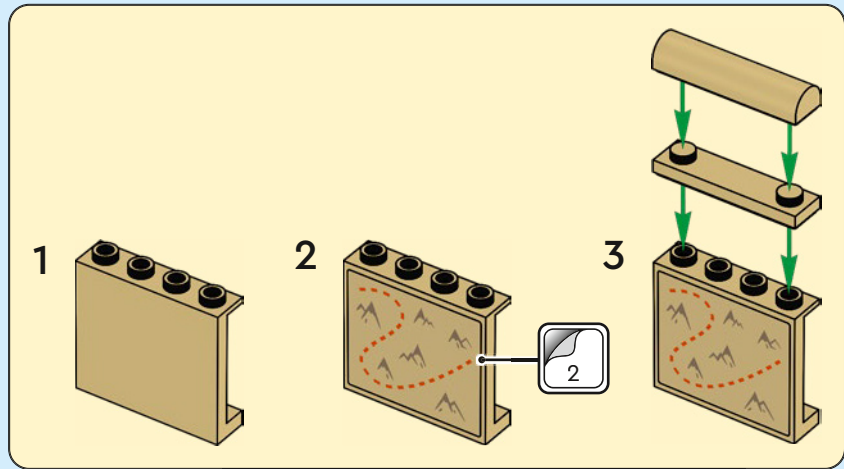



2x

67

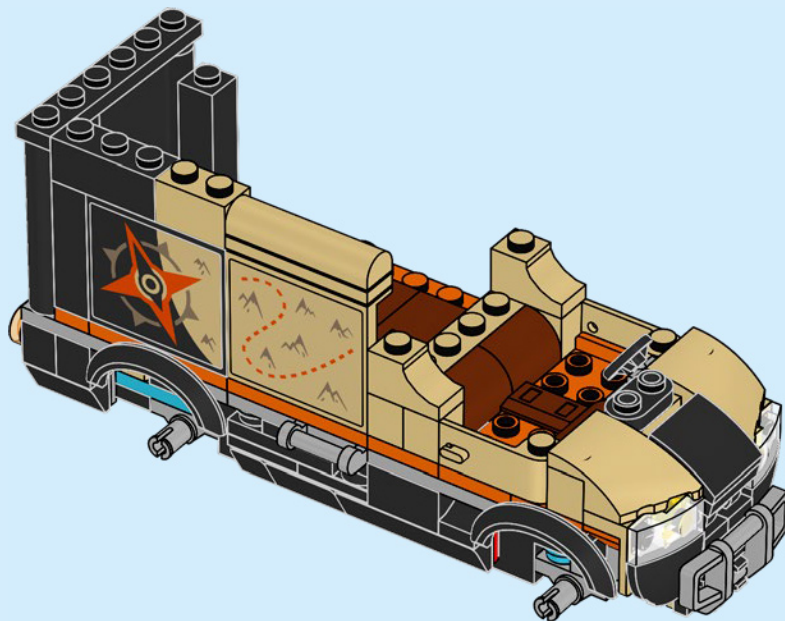

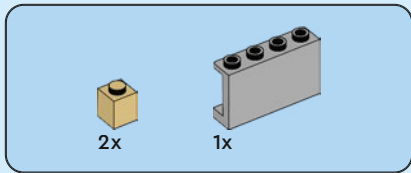

68

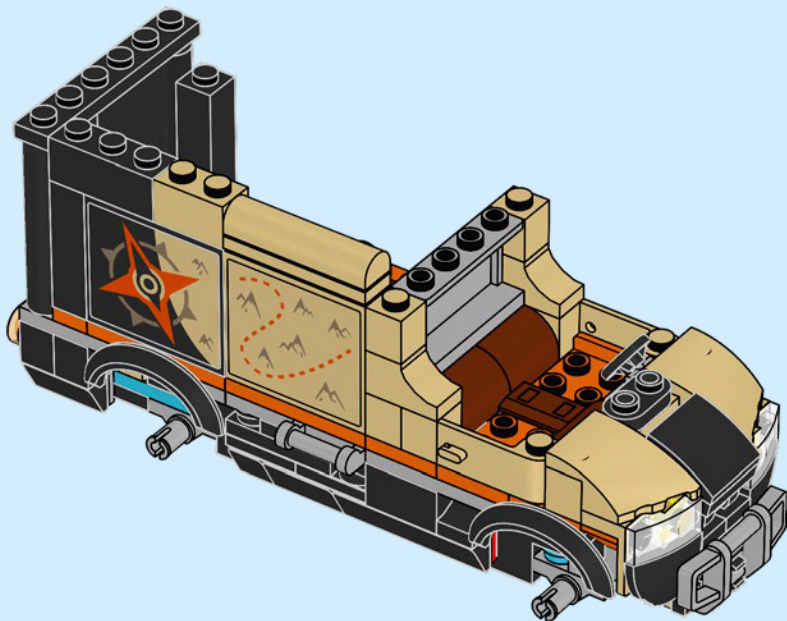



2x



1x

69

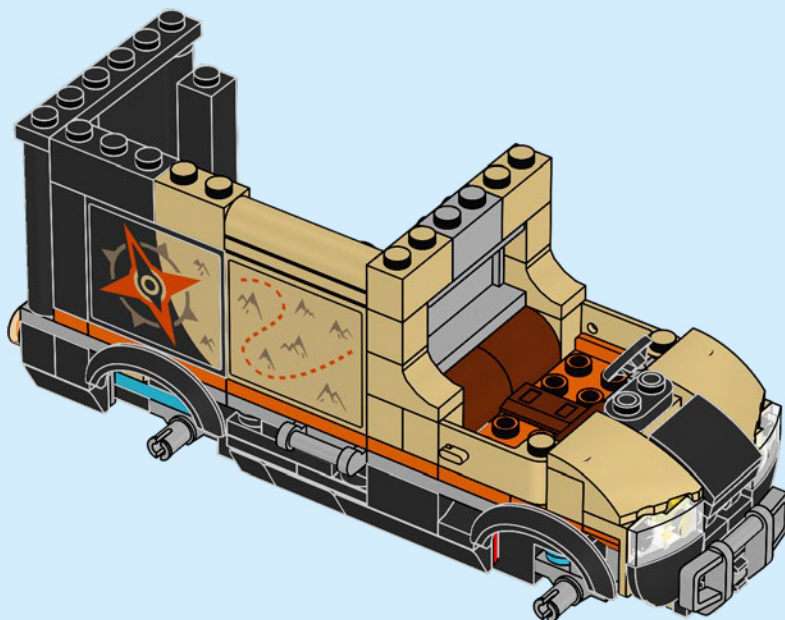



1x

70

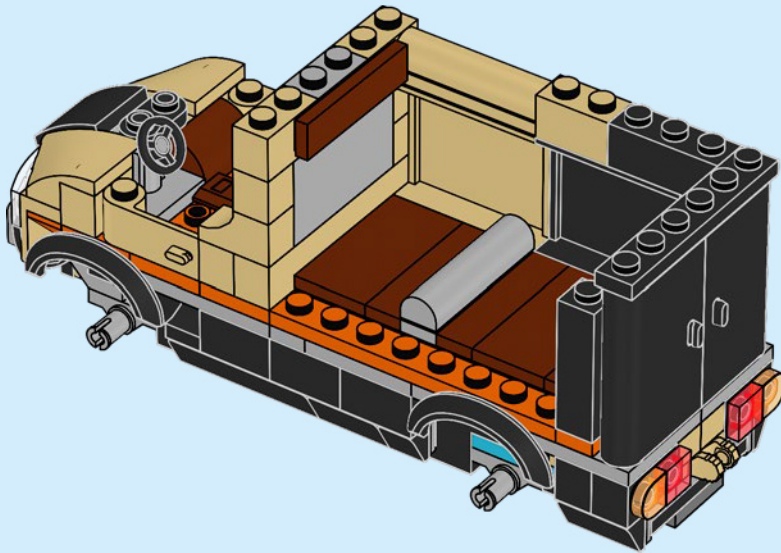

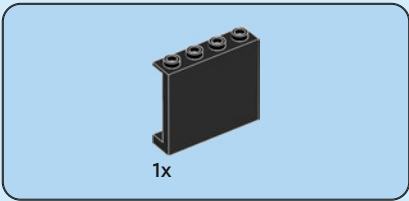

71

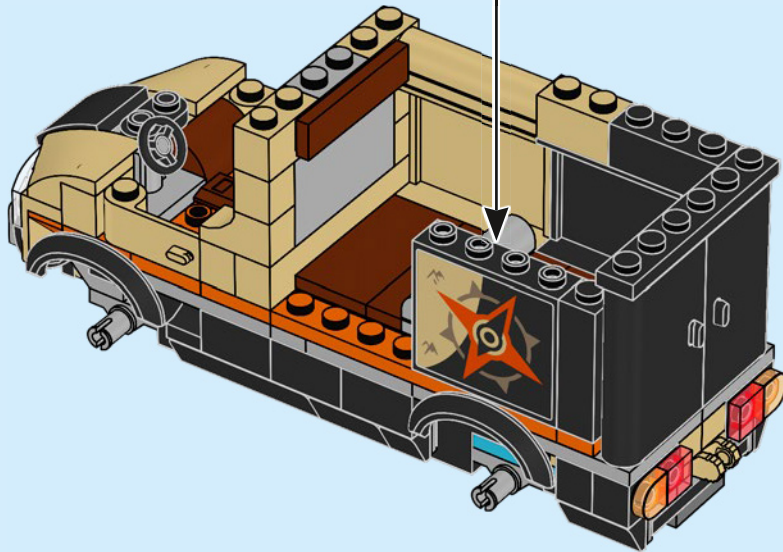
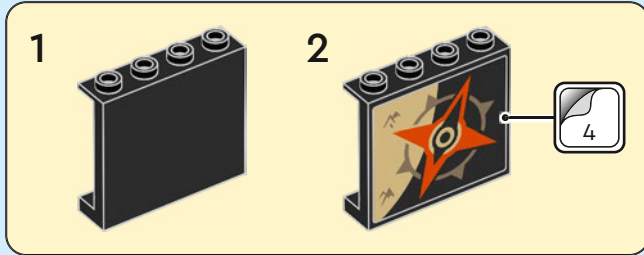

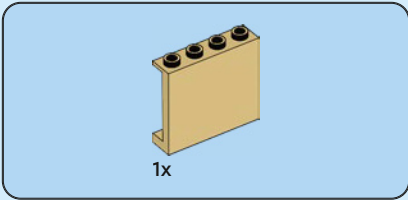

72

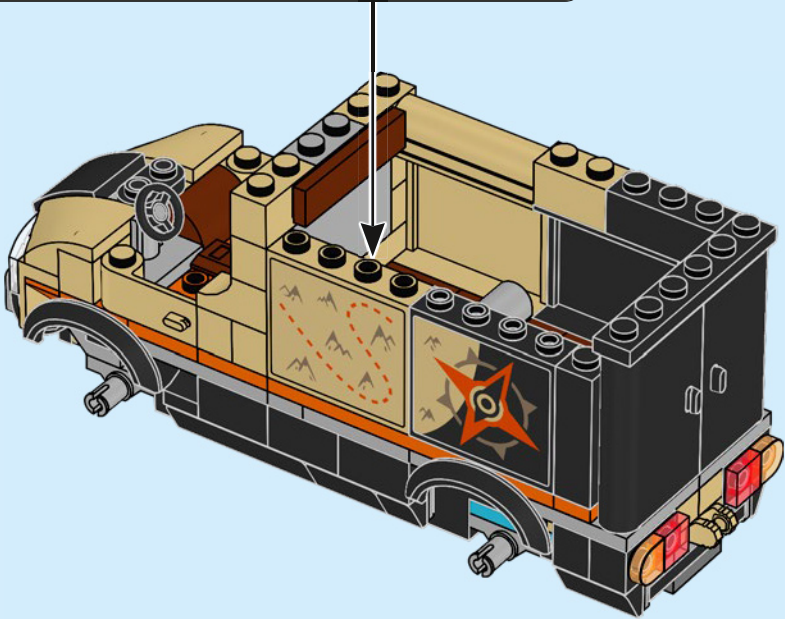
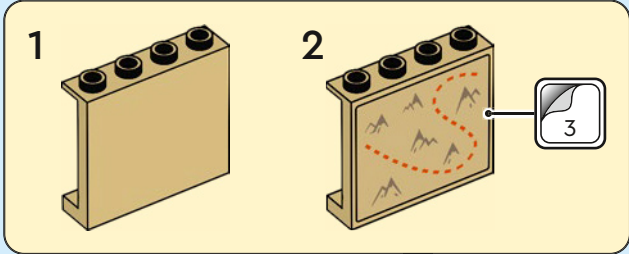

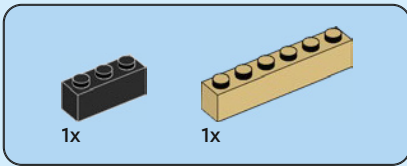

73

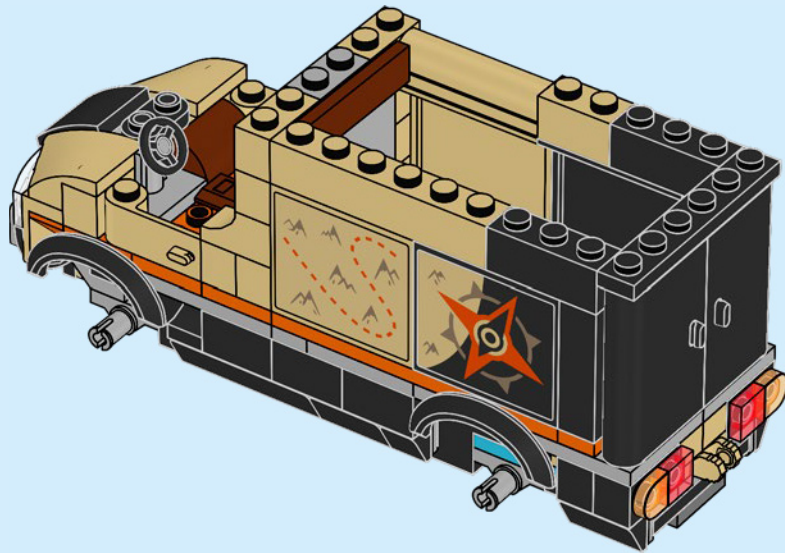

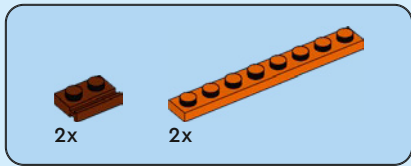

74

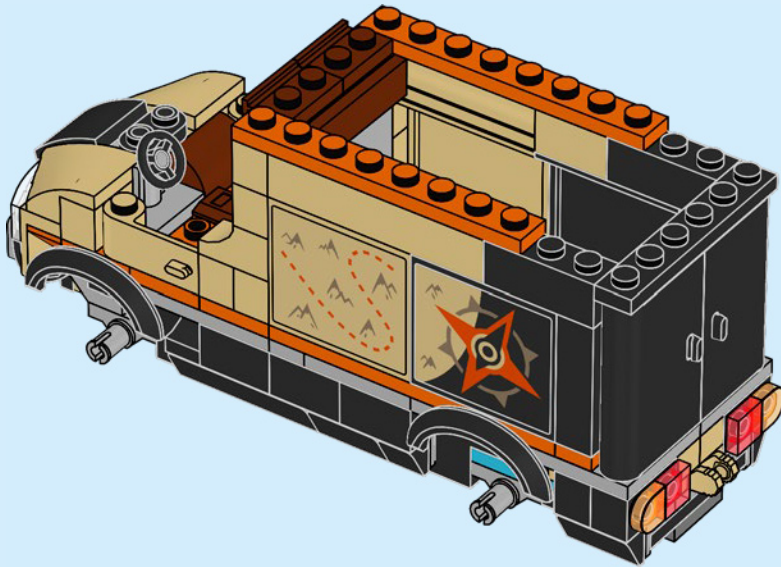



2x



2x

75

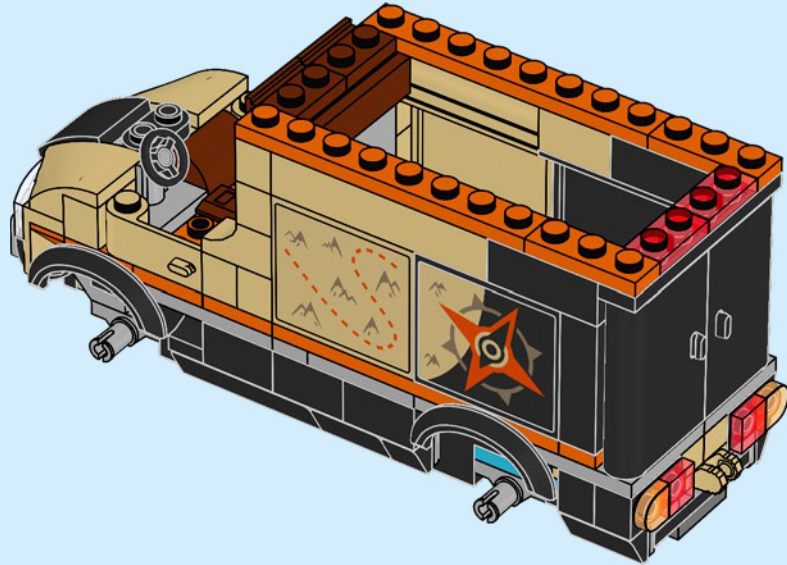

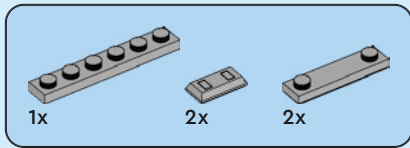

76

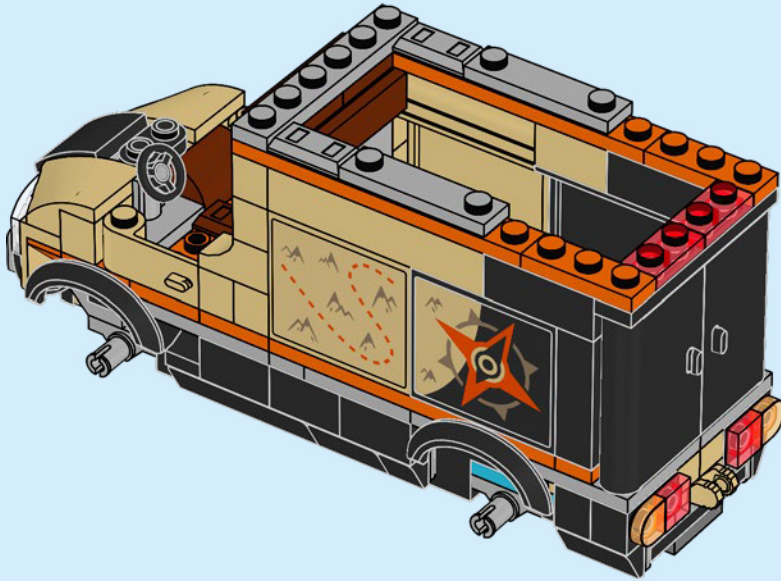



4x

77

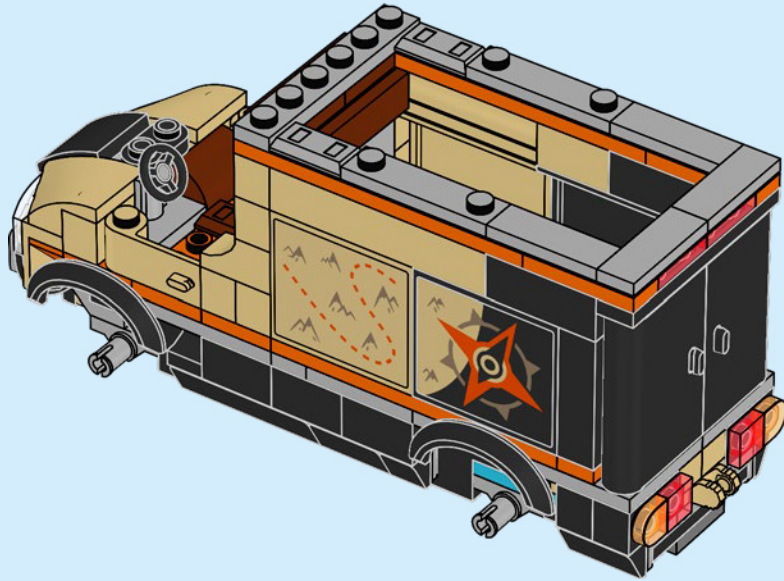

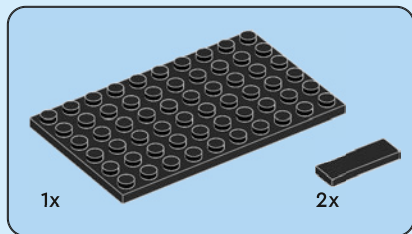

78

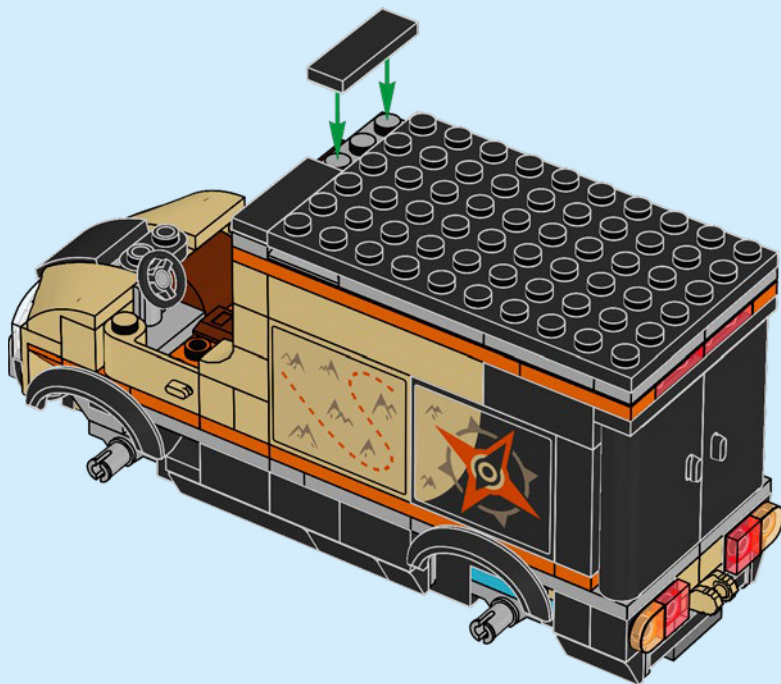



2x

79

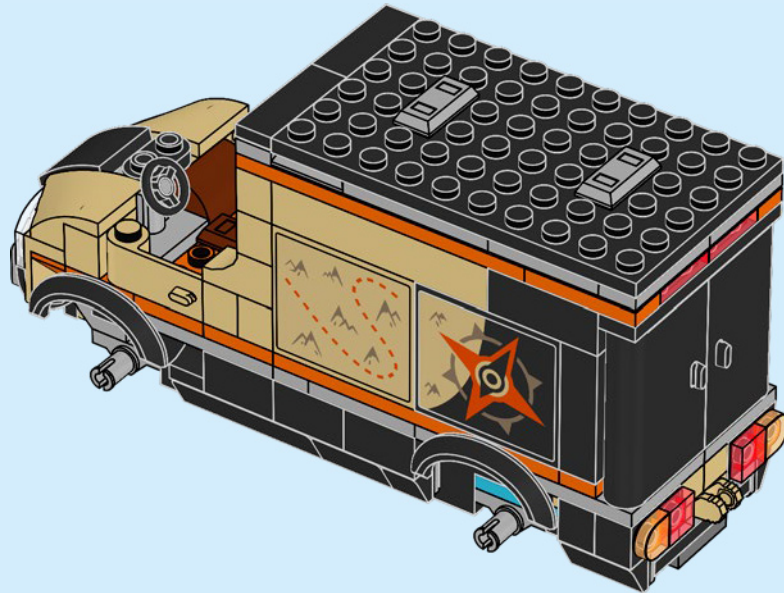



2x



2x

80

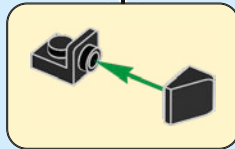
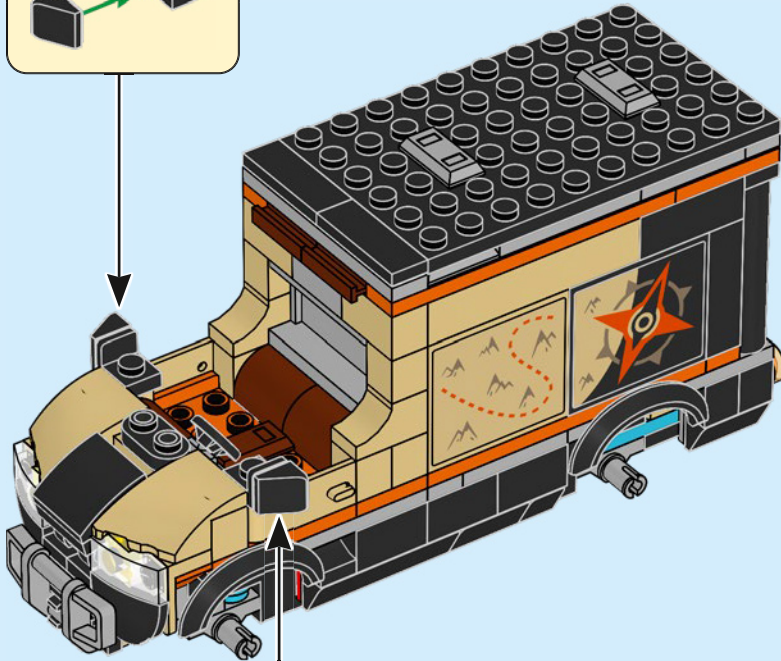
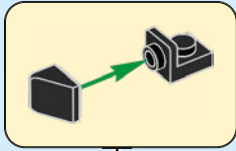

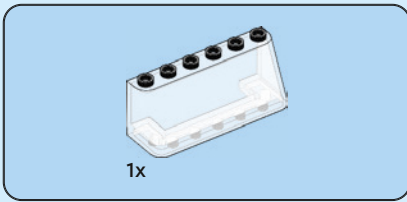

81

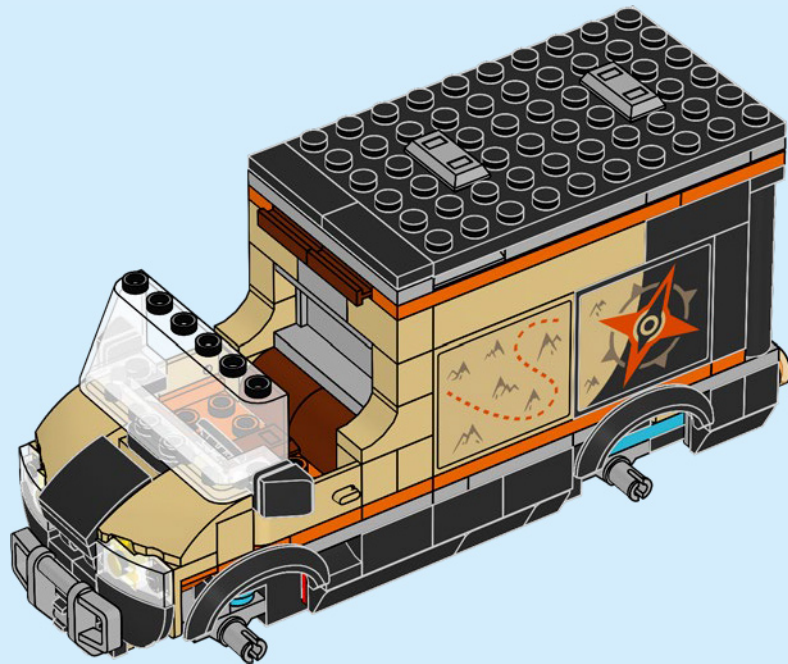

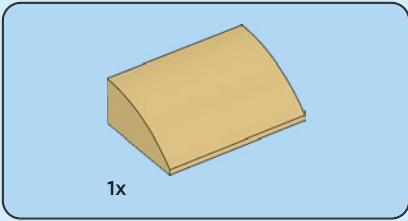

82

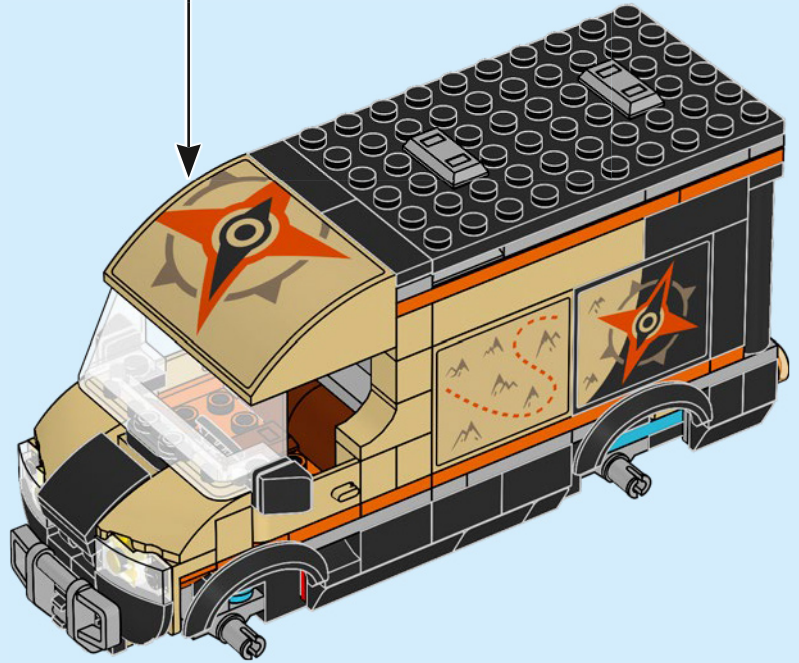
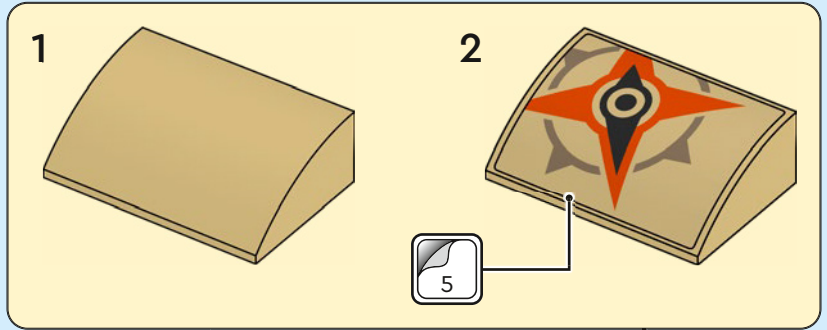



1x

83

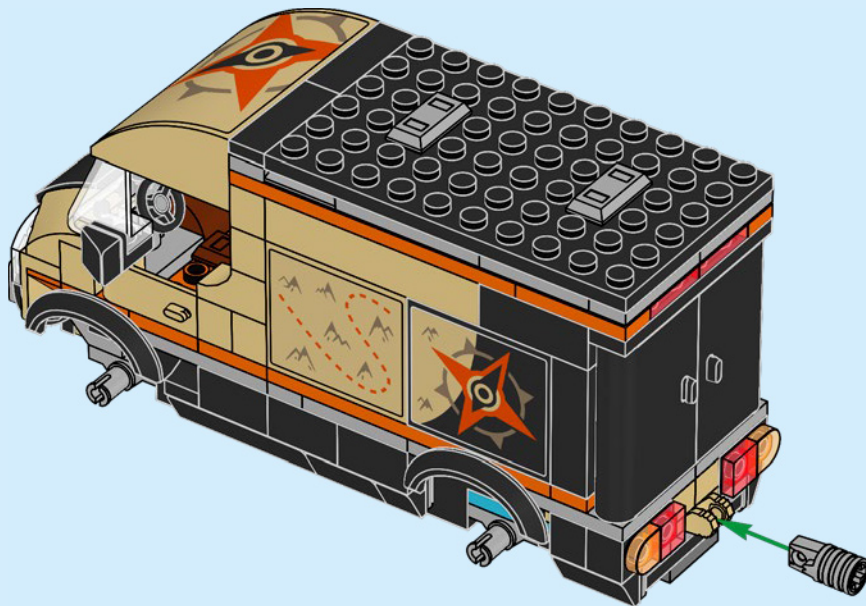

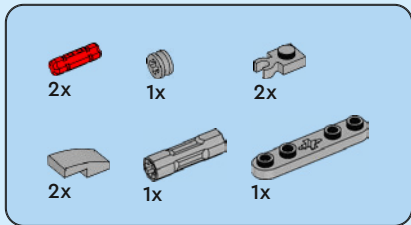

84

1

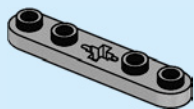

2

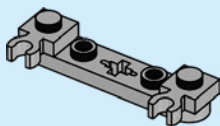

3

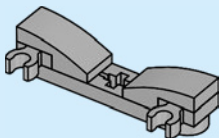

4

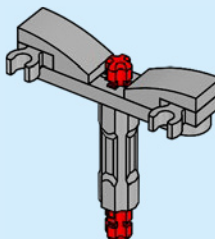

5

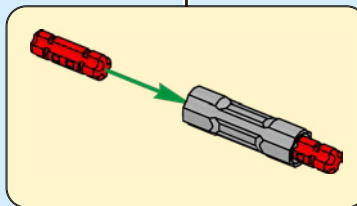
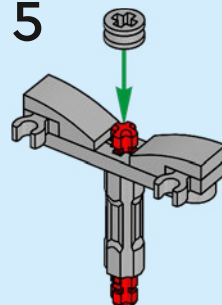

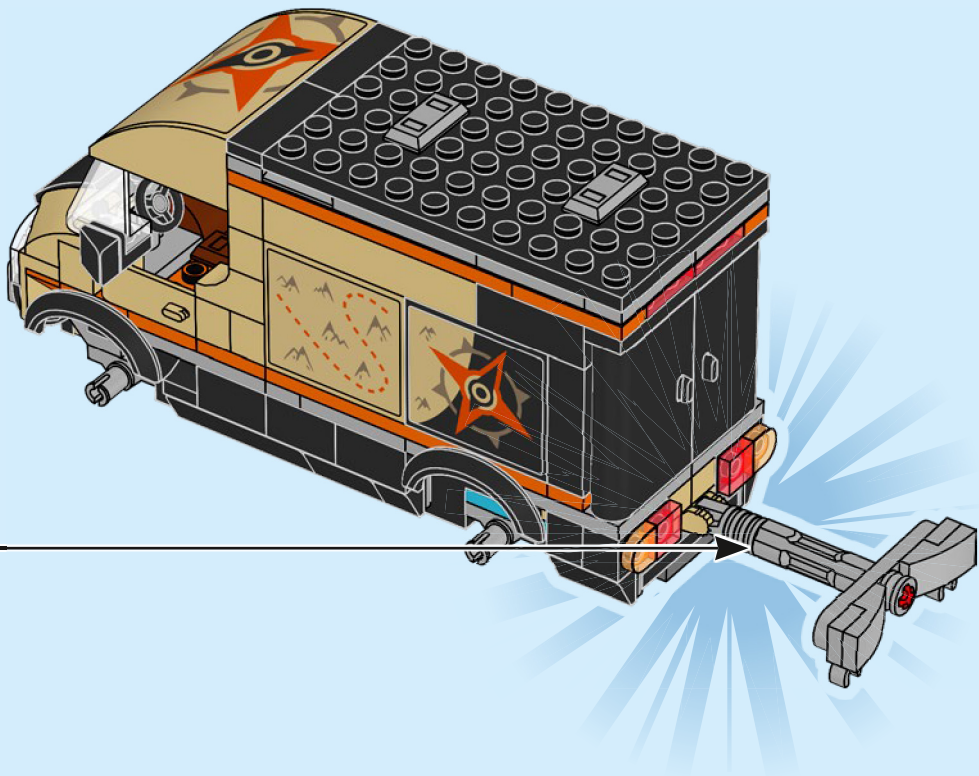

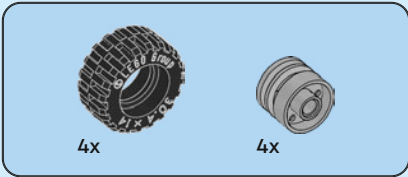

85

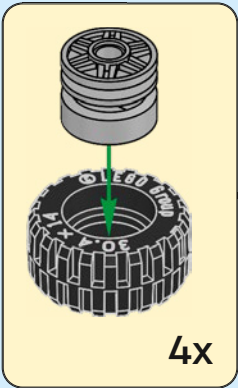
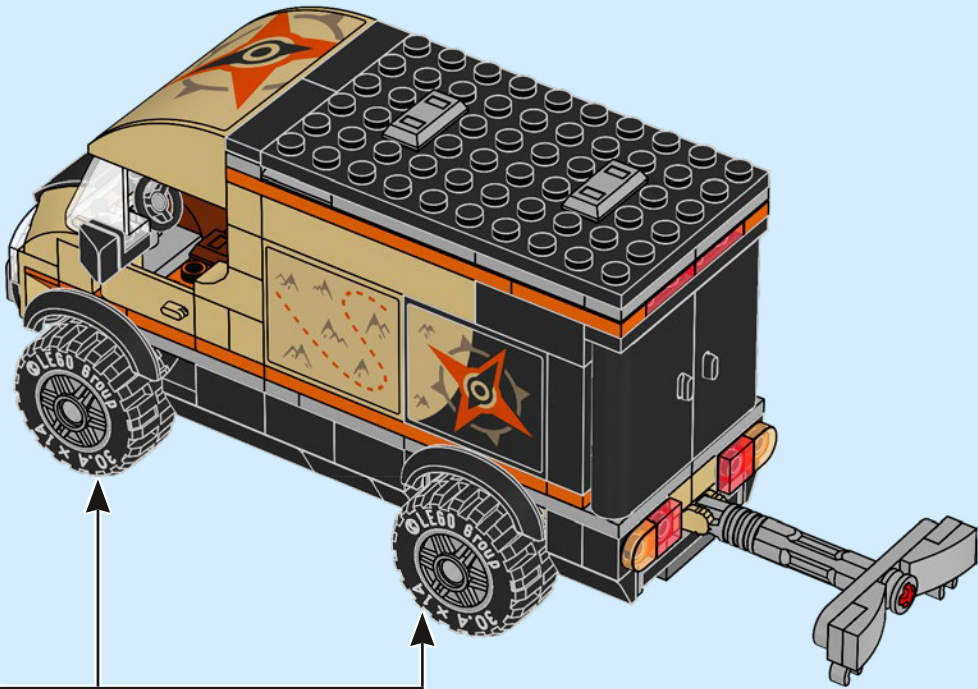

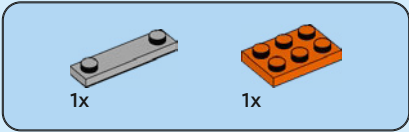
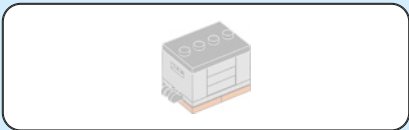

86

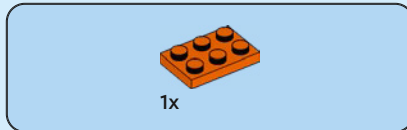
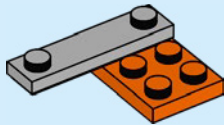

87

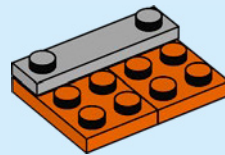

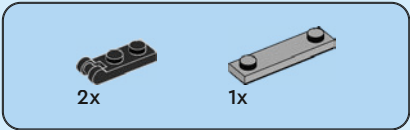

88

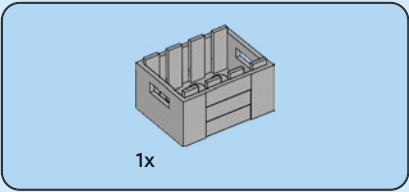
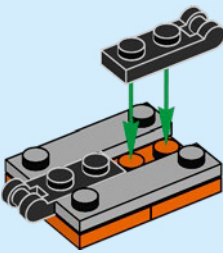

89

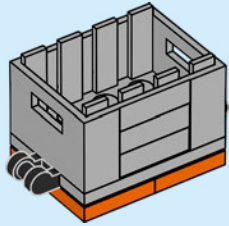

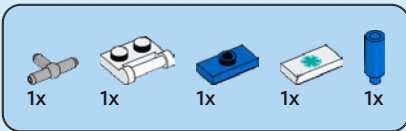

90

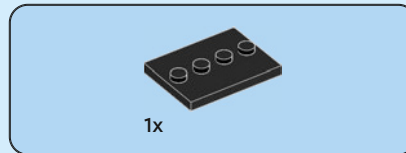
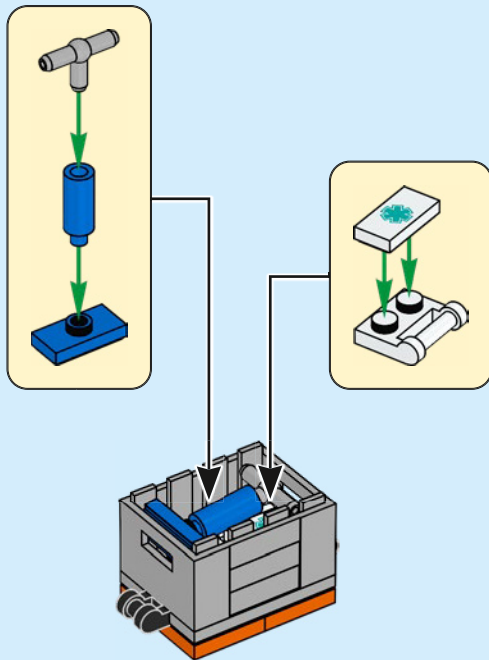

91

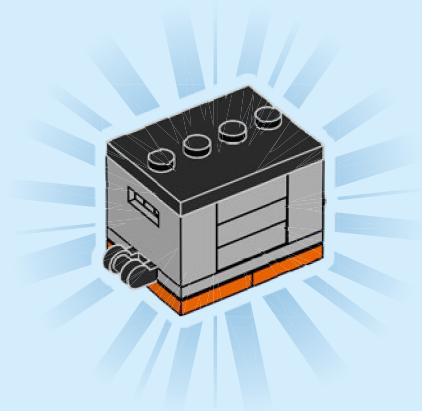

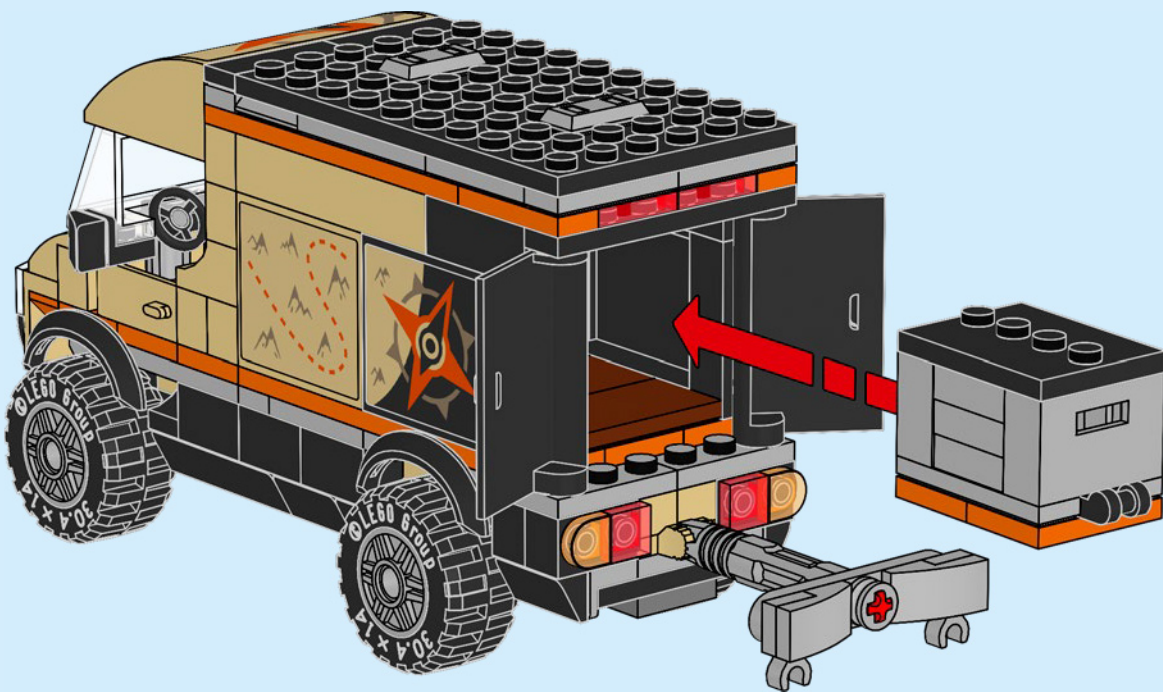

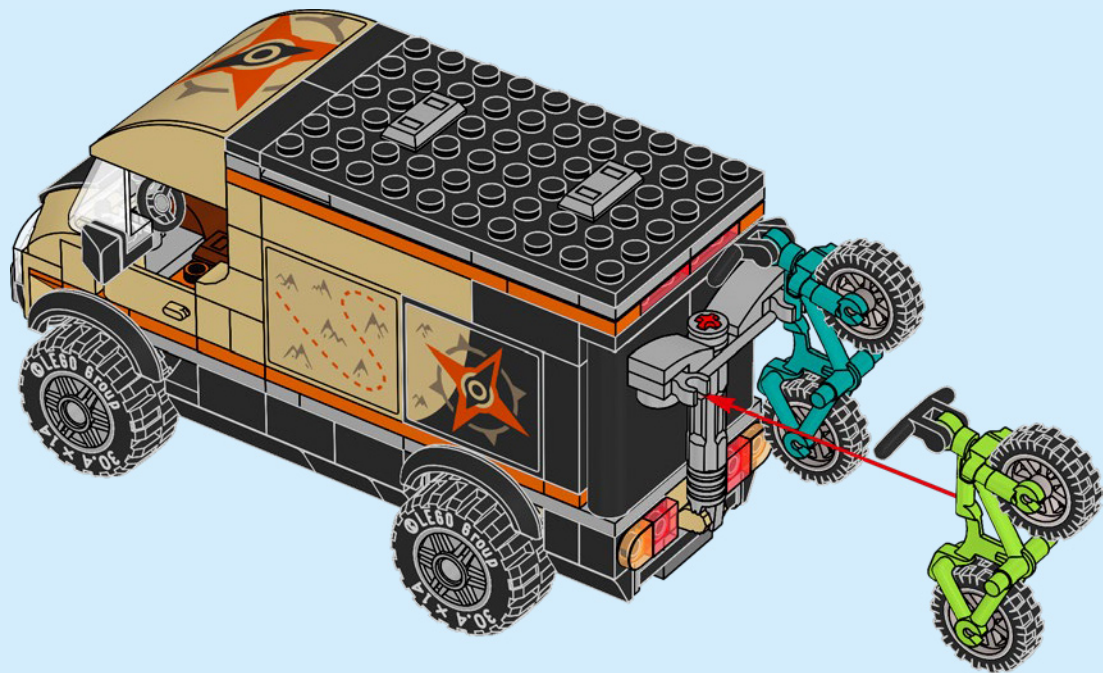

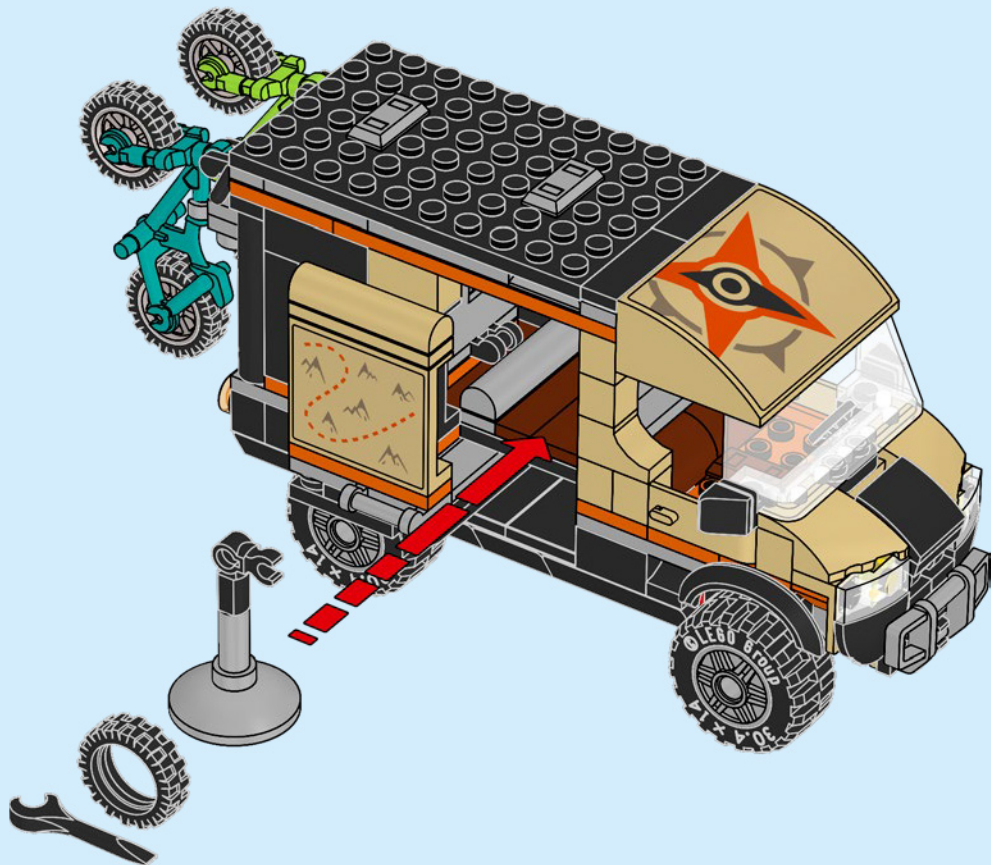

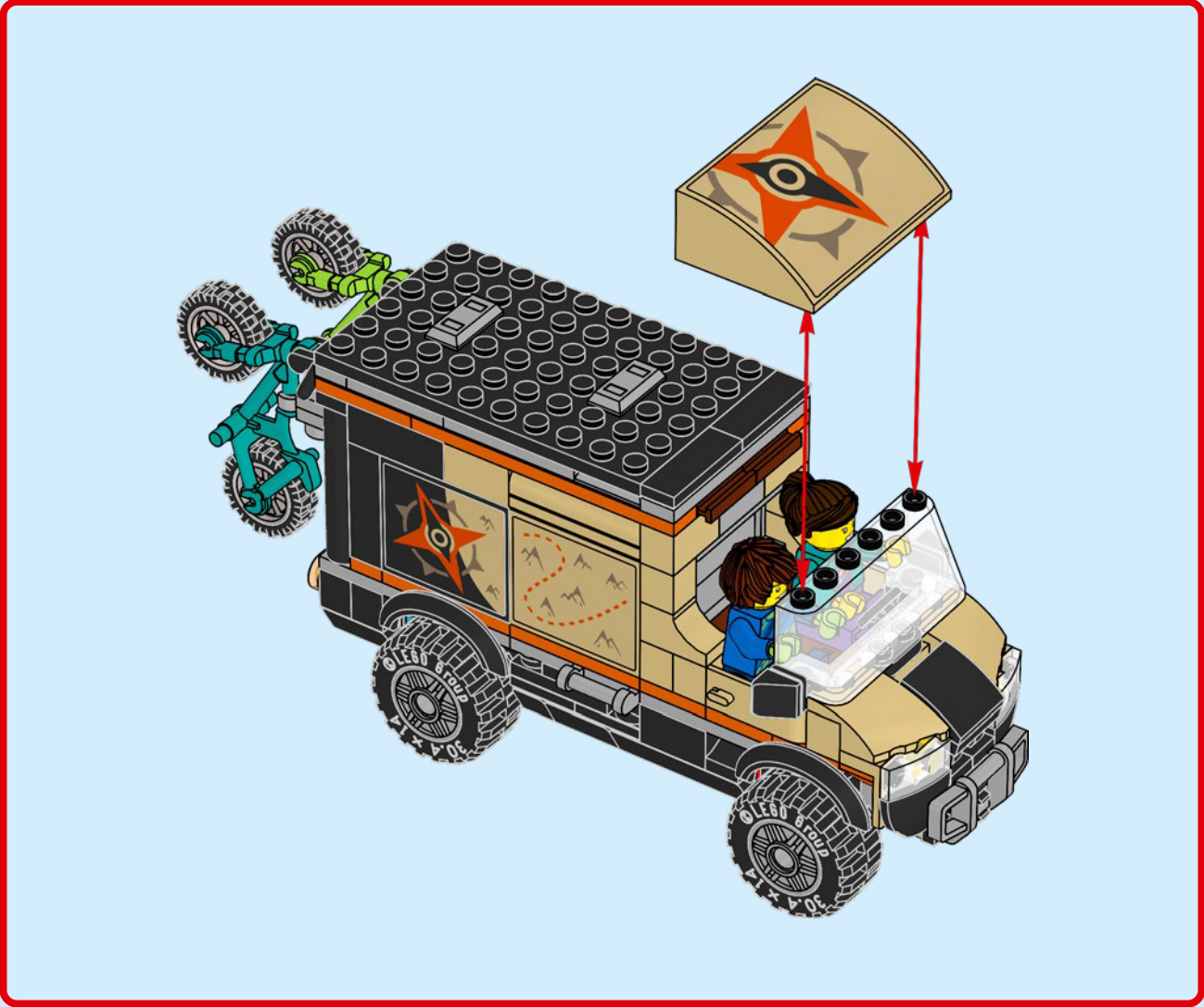





CITY

60494



60492



60497



60480



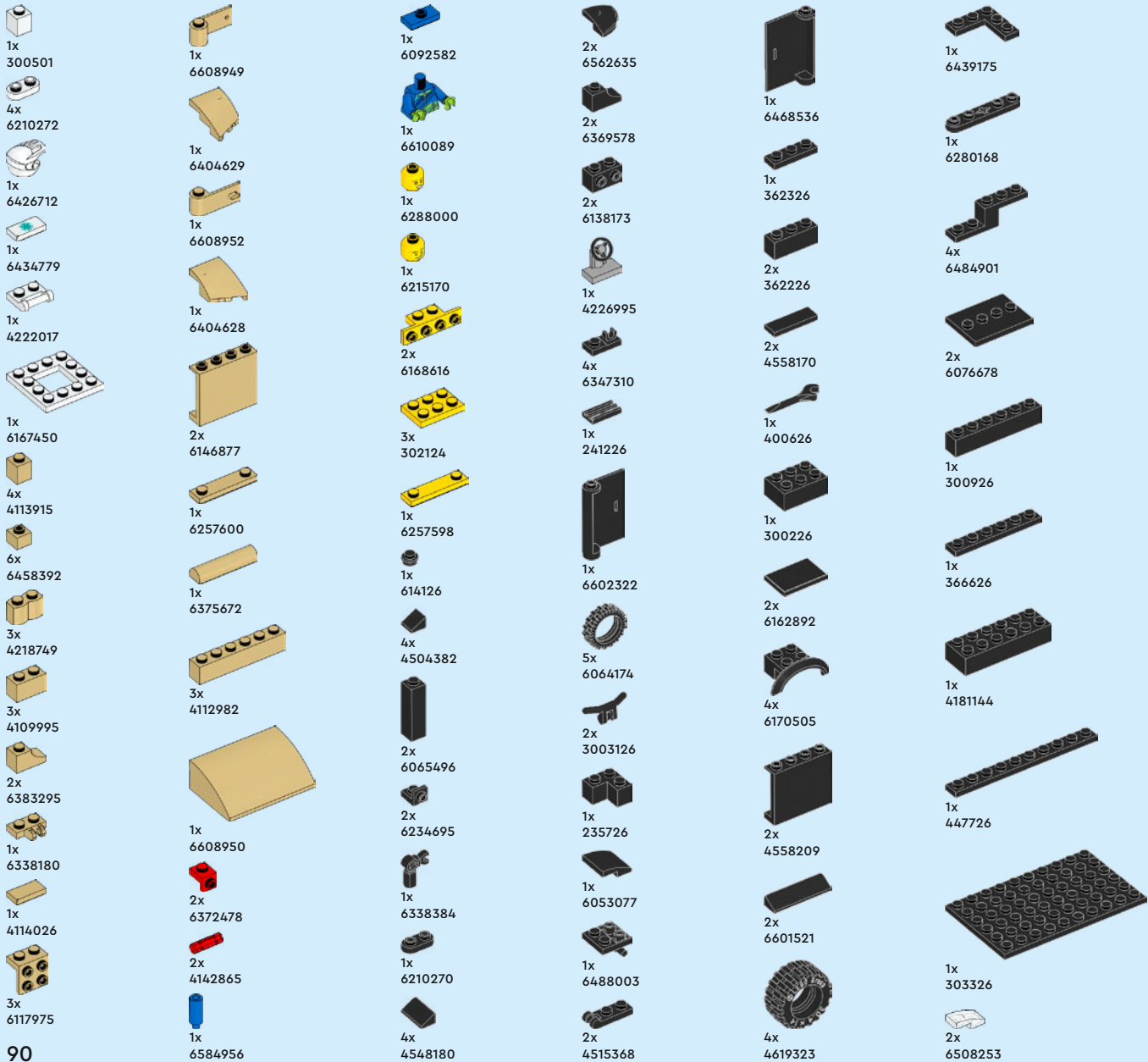

1x
6207255

2x
6507959

1x
6491486

1x
6261744

3x
6311210

2x
4645103

3x
4211194

3x
4579690

1x
6436421

1x
6271165

1x
6284071

1x
6258831

1x
4211399

1x
6265704

1x
4211508

2x
6296894

2x
6407767

2x
4211398

1x
6015344

4x
6134378

1x
6265694

2x
6028813

4x
4654582

1x
4244627

4x
6109684

1x
6070564

1x
6273212

5x
4558169

1x
6608948

5x
6257593

1x
6402876

1x
6061675

3x
6015347

1x
6549304

4x
4211395

1x
6108560

2x
6408542

2x
4211438

2x
4211406

1x
6564868

2x
6581817

2x
6514003

1x
6514238

2x
6514002

1x
6310580

1x
6603898

1x
4187743

1x
6608945

1x
4621548

1x
4210796

1x
4586410

1x
4162916

1x
6093516

4x
6413492

1x
6223733

2x
6102986

2x
6119107

1x
4625629

1x
6510175

1x
6608946

3x
6467485

7x
6466720

2x
6584054

2x
6567216

2x
6584052

2x
6469089



 [LEGO.com/service](https://www.LEGO.com/service)

YOU COULD **WIN**



Scan this QR code or go to **LEGO.COM/PRODUCTFEEDBACK** and give us your short feedback about this LEGO® set for a chance to win a cool LEGO prize.

Terms and Conditions apply*

EN: YOU COULD WIN. Terms and Conditions apply* **DE: Du könntest GEWINNEN.** Es gelten die Teilnahmebedingungen* **FR: TU POURRAIS GAGNER.** Des conditions s'appliquent* **IT: Potresti VINCERE tu.** Termini e condizioni sono applicabili* **ES: PUEDES GANAR.** Aplican términos y condiciones* **PT: PODERÁ GANHAR.** Aplicam-se Termos e Condições* **ZH: 轻松获奖. 条款和条件适用*** **PL: Szansa na WYGRANĄ.** Obowiązuje regulamin* **CS: Máte šanci VYHRÁT.** Platí všeobecné smluvní podmínky* **SK: Máte šancu VYHRÁŤ.** Platia všeobecné zmluvné podmienky* **HU: TE IS NYERHETSZ!** Felhasználási feltételek érvényesek* **UA: ВИ МОЖЕТЕ ВИГРАТИ.** Застосовуються загальні положення та умови* **RO: Ai putea CÂȘTIGA.** Se aplică termenii și condiții* **BG: Можете да СПЕЧЕЛИТЕ.** Има определени правила и условия* **LV: Tu vari LAIMĒT.** Ir spēkā noteikumi un nosacījumi.* **ET: Sul on võimalus VÕITA.** Kehtivad tingimused* **LT: Jūs galite LAIMĖTI.** Taikomos sąlygos* **TR: KAZANABİLİRSİN.** Şartlar ve Koşullar geçerlidir*

*[LEGO.com/productfeedback-terms](https://www.lego.com/productfeedback-terms)