



CITY

60512



LEGO® Builder



LEGO.com/sustainable-packaging



FR

DONNEZ
OU
RECYCLEZ



OU



OU



ASSOCIATION

MAGASIN

DÉCHÈTERIE

Adresses sur quefairedemesdechets.fr

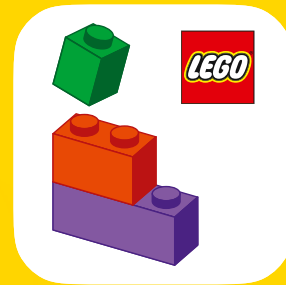

LEGO® Builder



BUILDER



Apple and the Apple logo are trademarks of Apple Inc., registered in the U.S. and other countries and regions. App Store is a service mark of Apple Inc. Google Play and the Google Play logo are trademarks of Google LLC. Tencent and the Tencent logo are trademarks of Tencent Inc.

LEGO.com/devicecheck

EN Ask parents' permission before going online | **DE** Eltern um Erlaubnis bitten, bevor du online gehst | **FR** Demande l'autorisation d'un parent avant d'aller en ligne | **IT** Chiedi il permesso ai tuoi genitori prima di andare online | **ES** Pídeles permiso a tus papás antes de conectarte a Internet | **PT** Pede autorização aos teus pais antes de ficares online | **ZH** 上网前应先征得父母的同意 | **PL** Poproś rodziców o zgodę, zanim wejdiesz do Internetu | **CS** Než půjdeš na internet, požádej rodiče o svolení | **SK** Skôr než pôjdeš na internet, vypýtaj si povolenie od rodičov | **HU** Kérj szülői engedélyt, mielőtt online csatlakoznál! | **UA** Запитуйте дозволу батьків, перш ніж користуватися інтернетом | **RO** Cere permisiunea părinților înainte de a te conecta online | **BG** Поискайте разрешение от родител, преди да влезете онлайн | **LV** Pirms došanās tiešsaistē palūdz atļauju vecākiem | **ET** Enne Interneti kasutamist küsi vanematelt luba | **LT** Prieš prisijungdami prie interneto, atsiklauskite tėvų | **TR** İnternete girmeden önce anne babadan izin iste



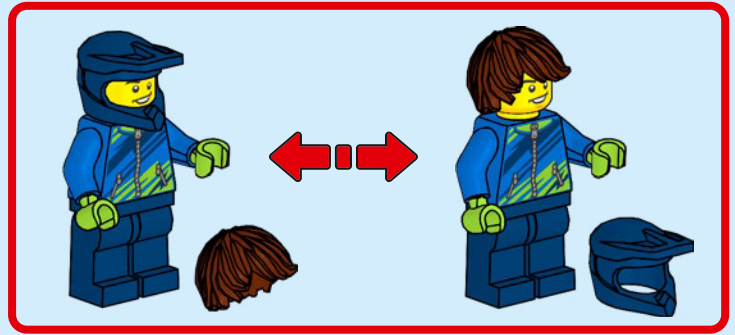
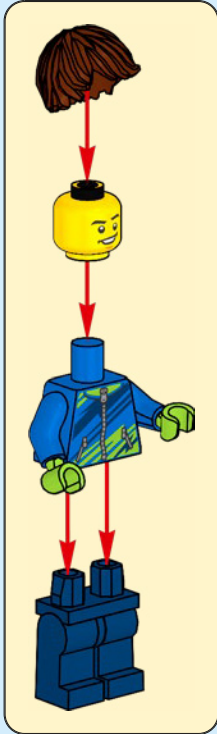

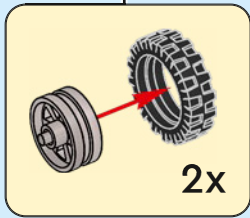
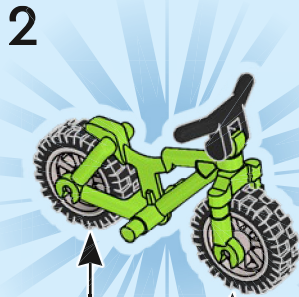
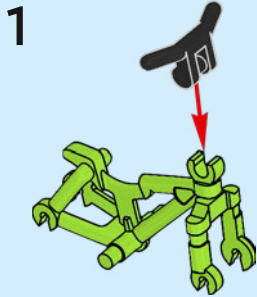
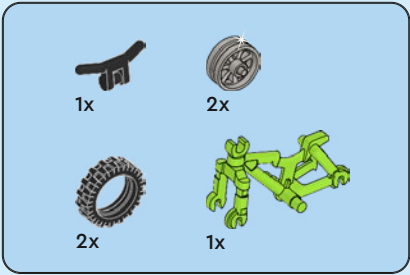

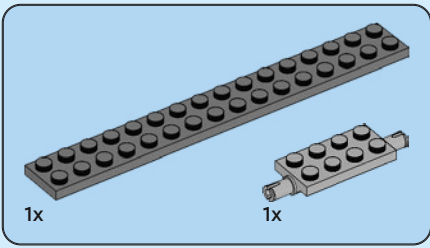

1

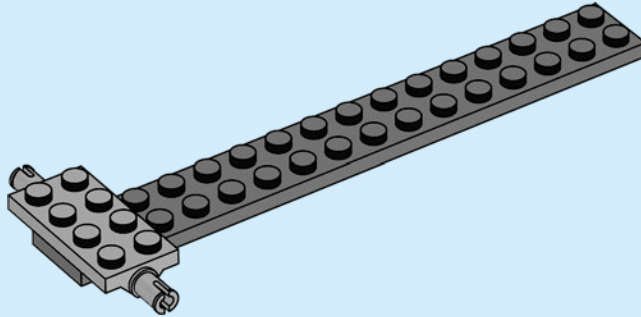



2x



2x

2

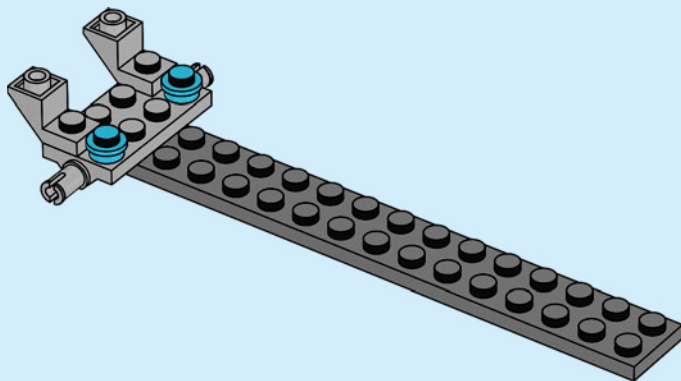

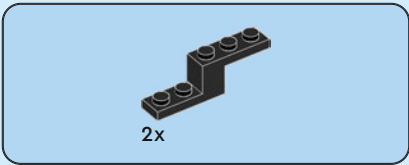

3

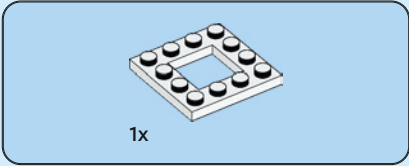
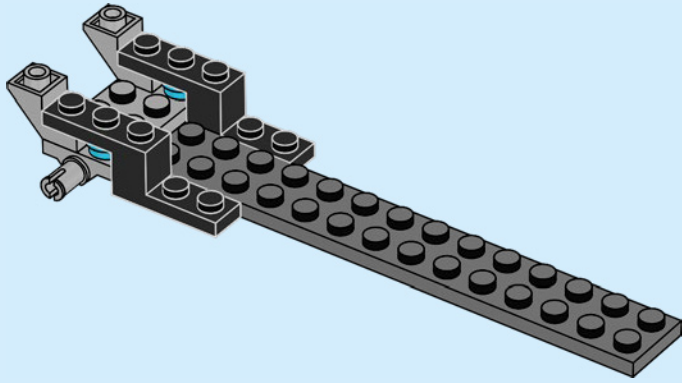

4

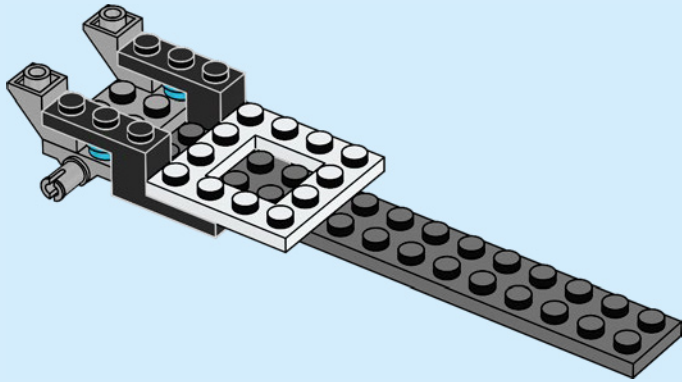

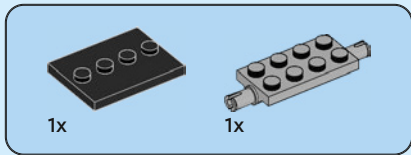

5

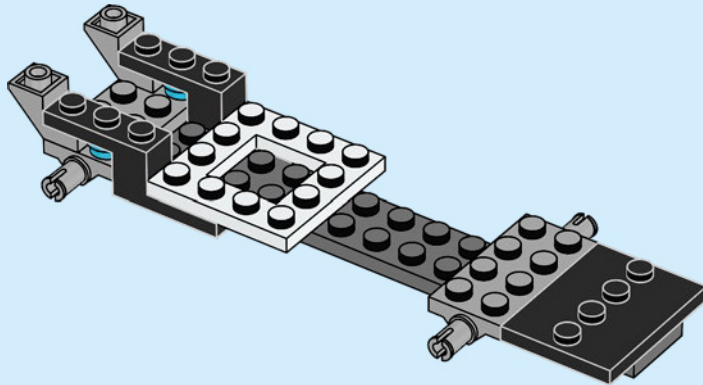



2x

8

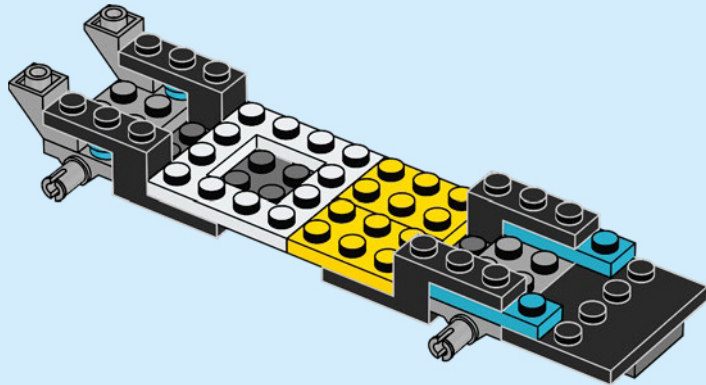

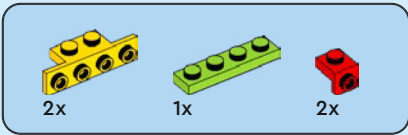

9

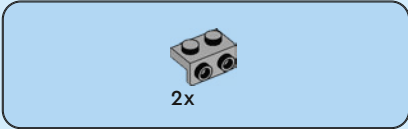
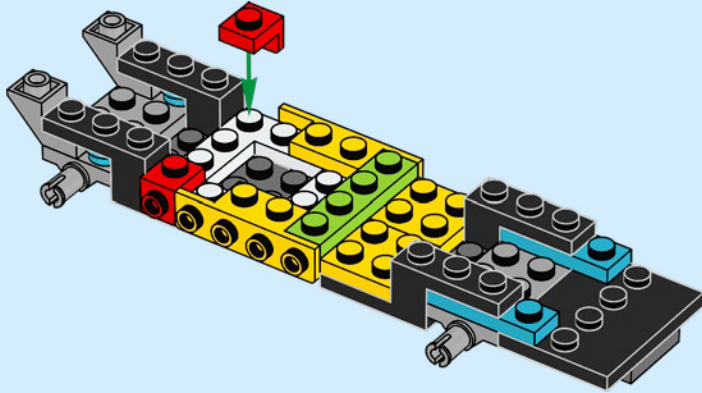

10

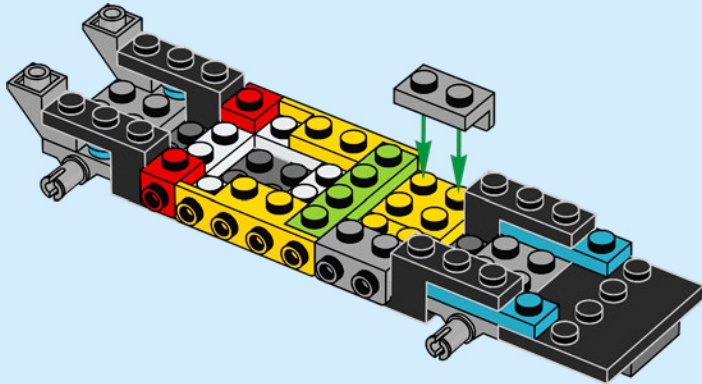

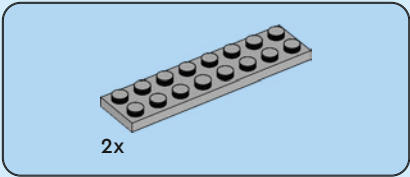

11

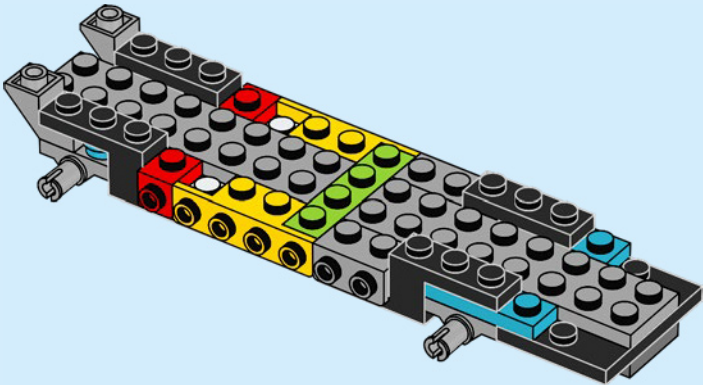

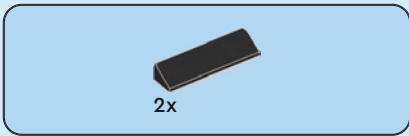

12

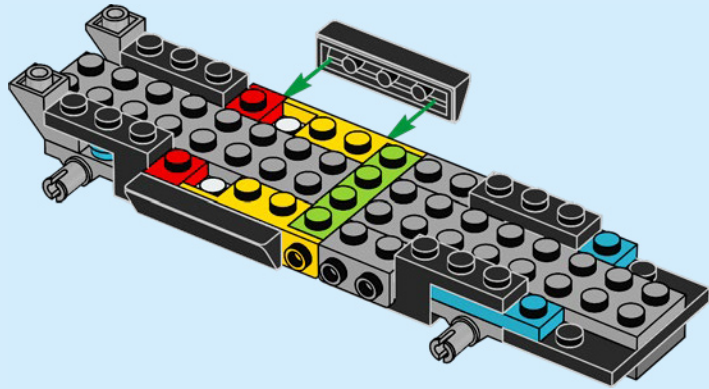

13

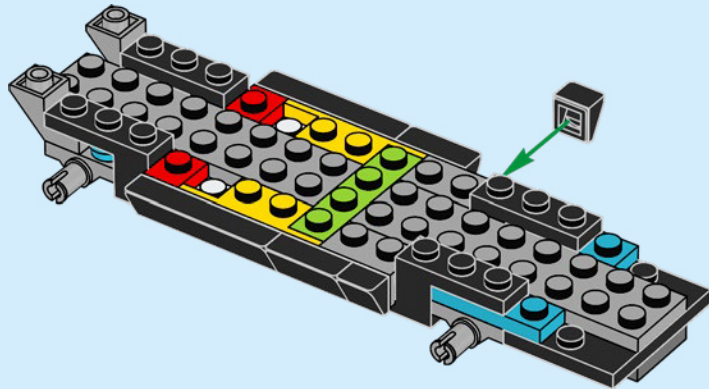

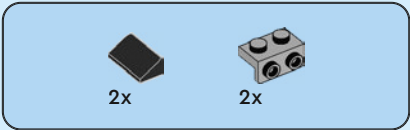

14

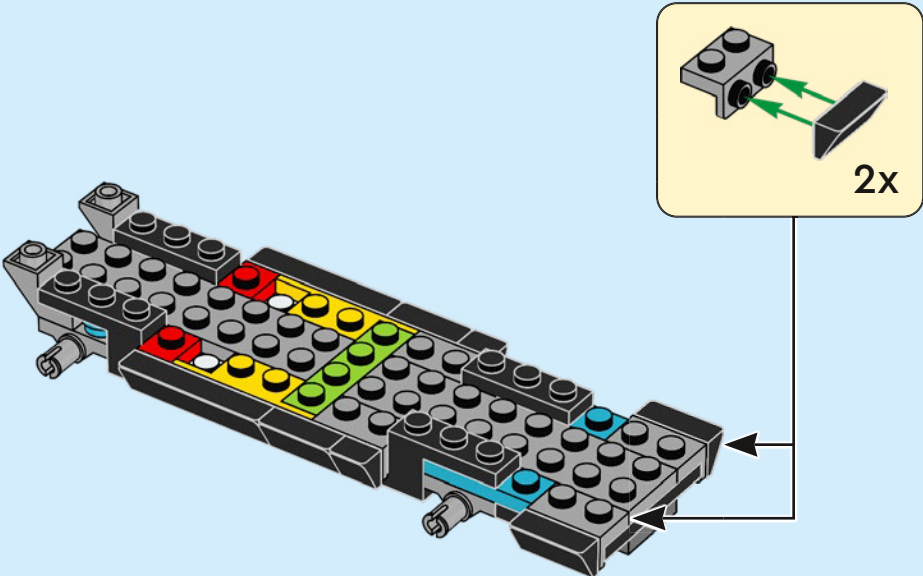



1x

15

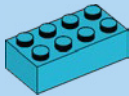
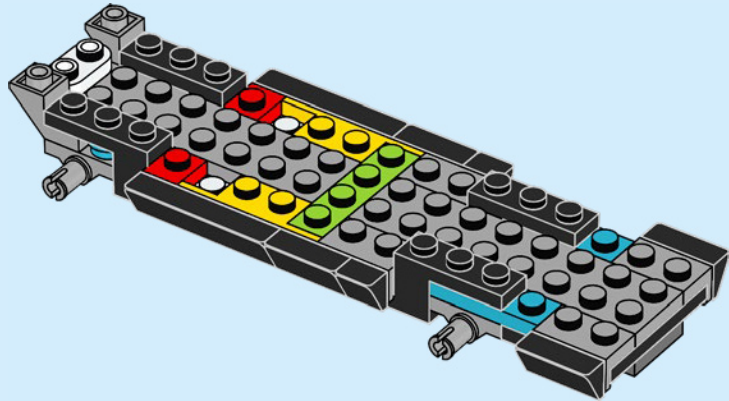

1x

16

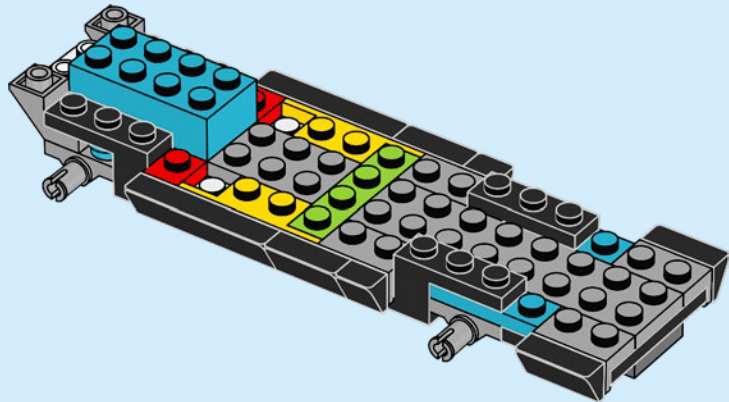



2x

17

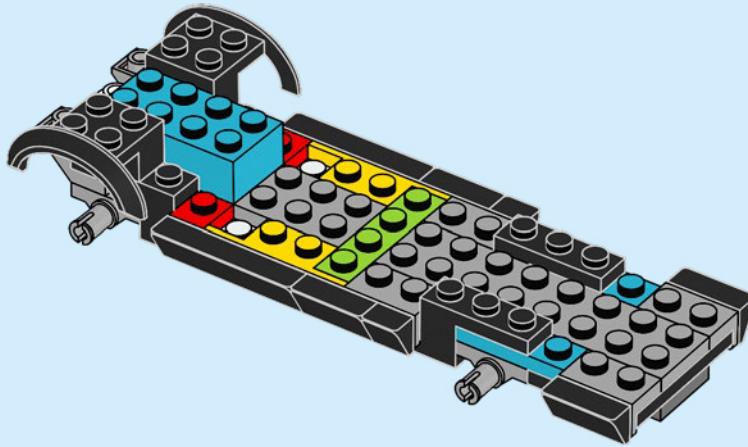



2x



2x

18

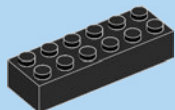
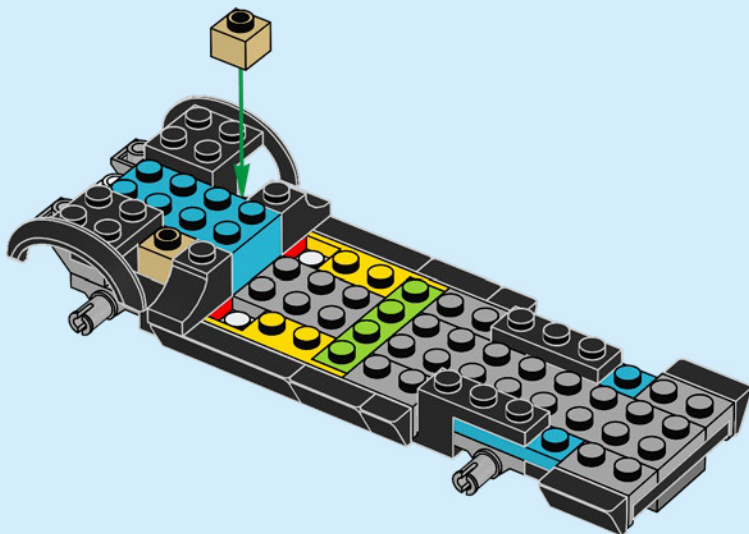

1x



2x

19

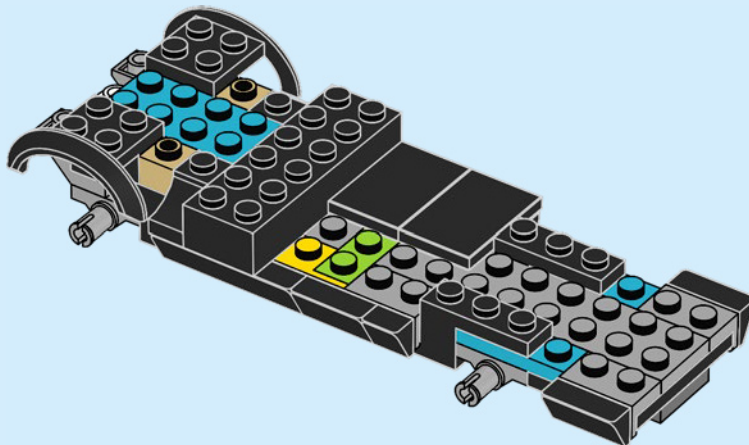



1x



1x

20

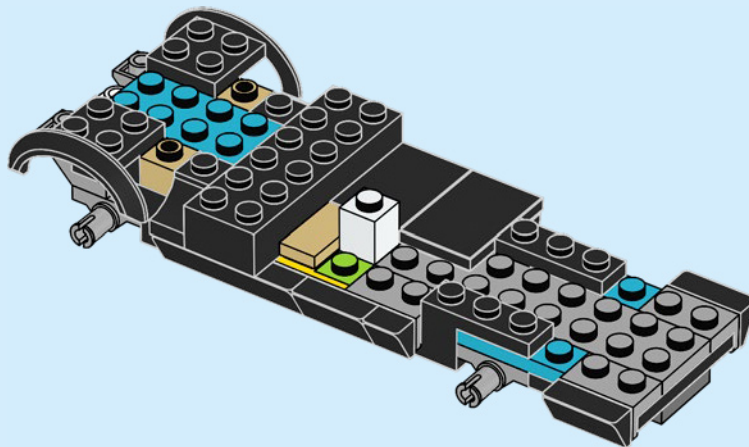

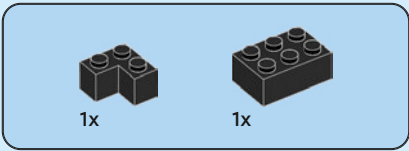

21

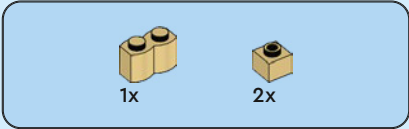
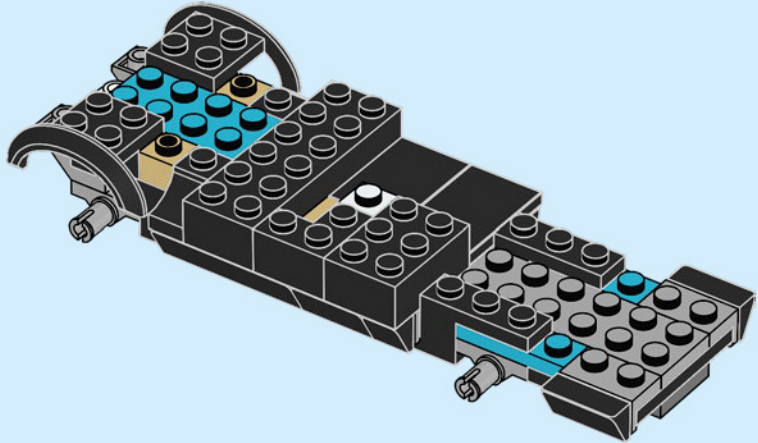

22

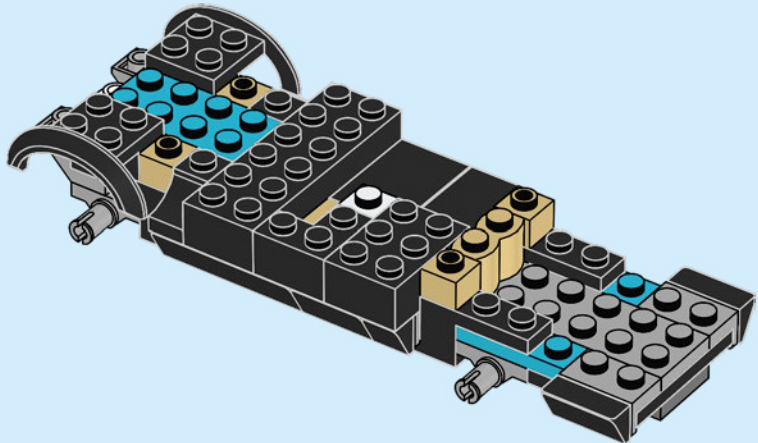



2x

23

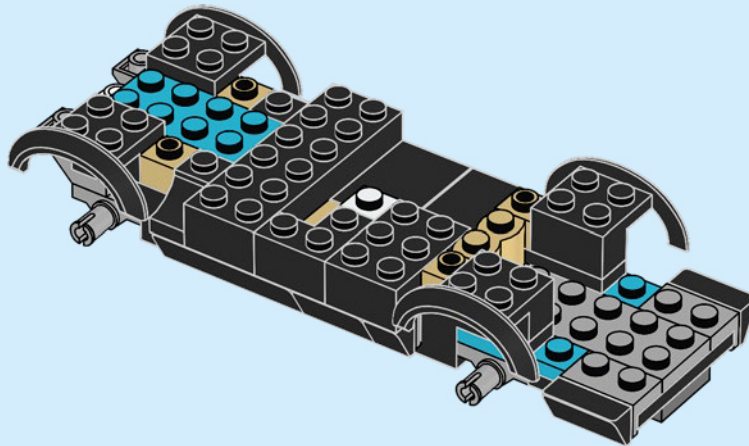



2x

24

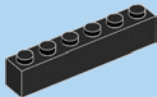
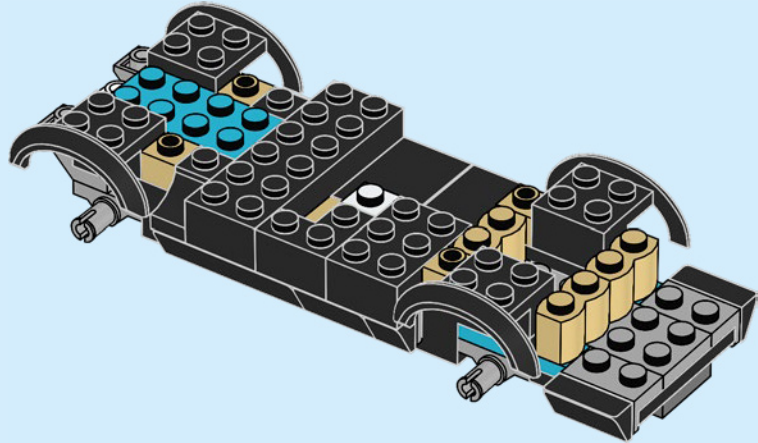

1x

25

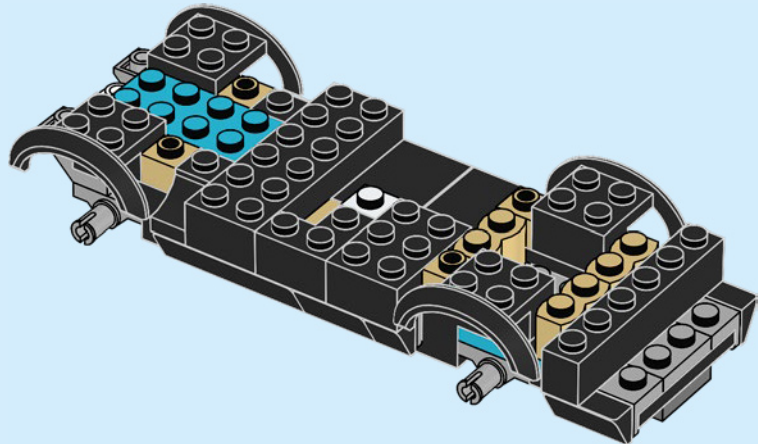



1x

26

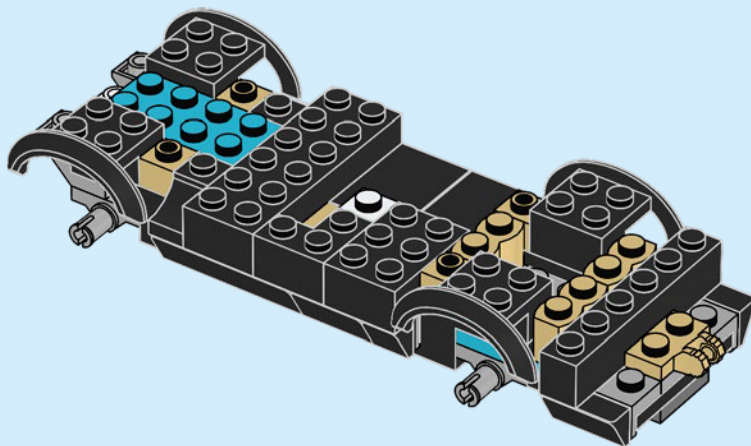



2x

27

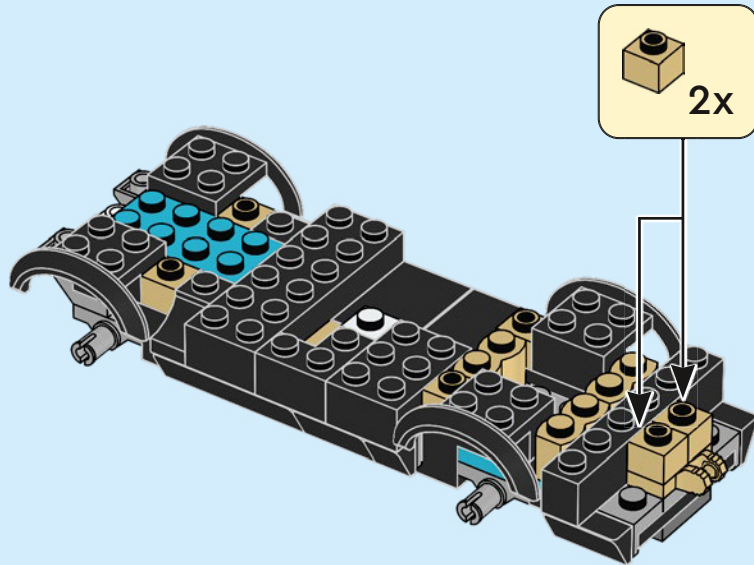



28

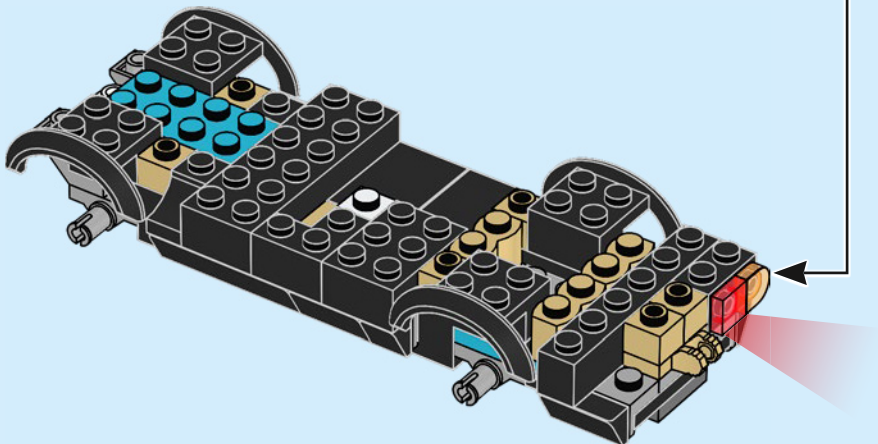
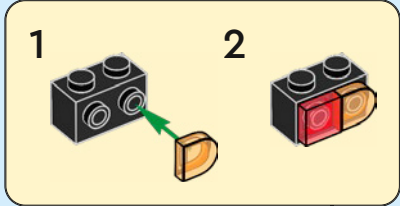



29

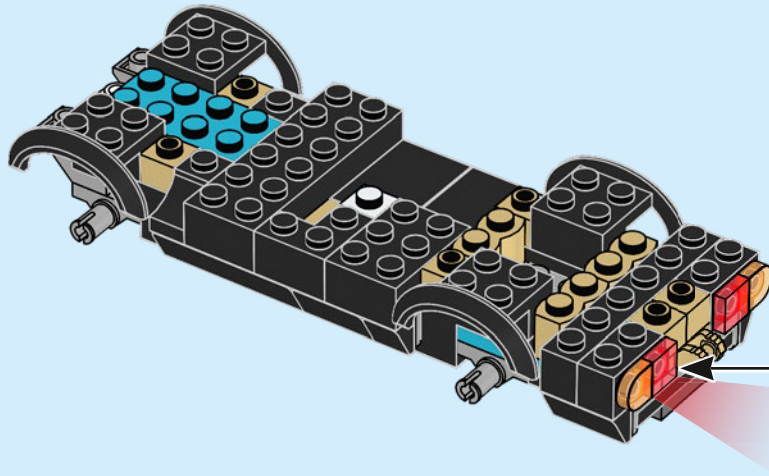
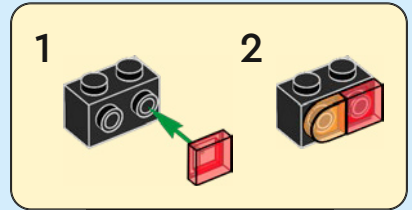



2x

30

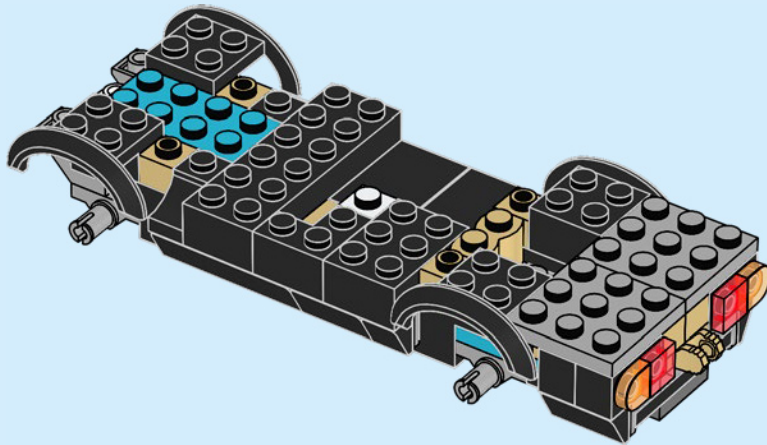

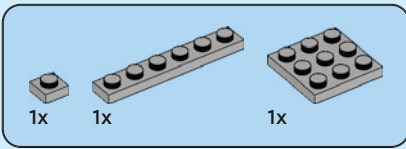

31

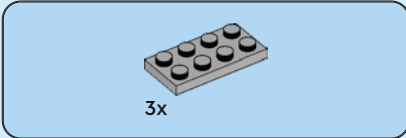
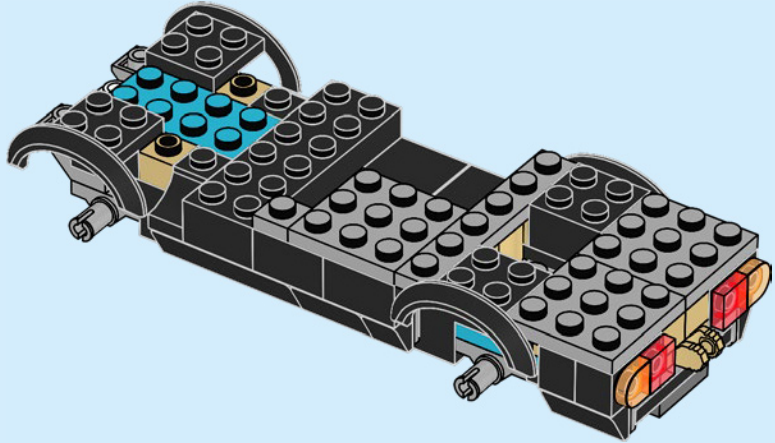

32

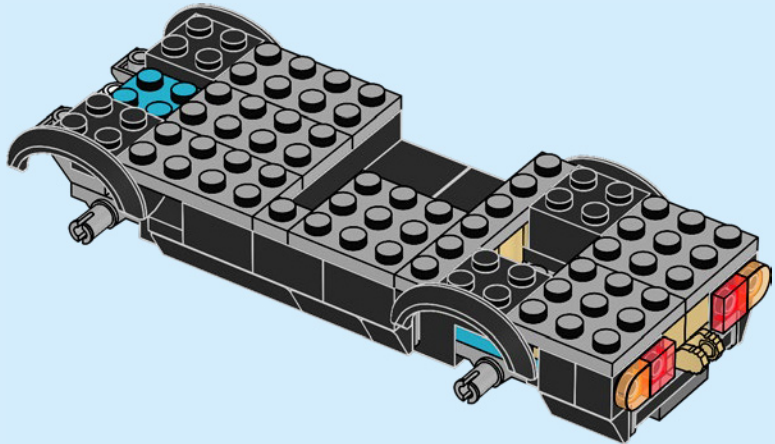

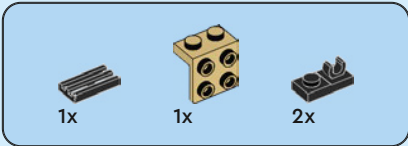

33

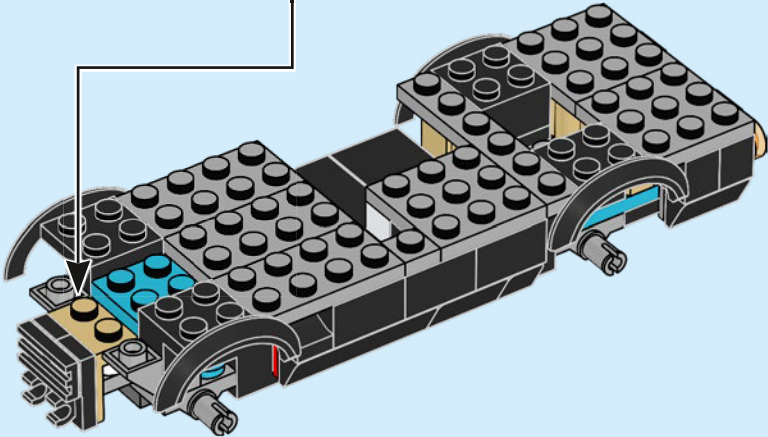
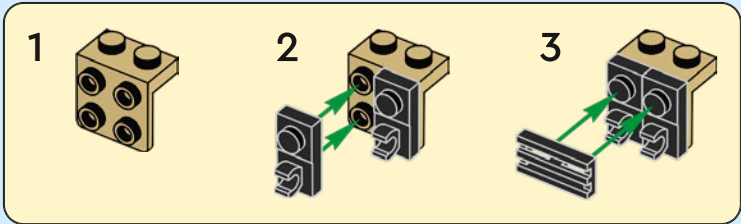



2x

34

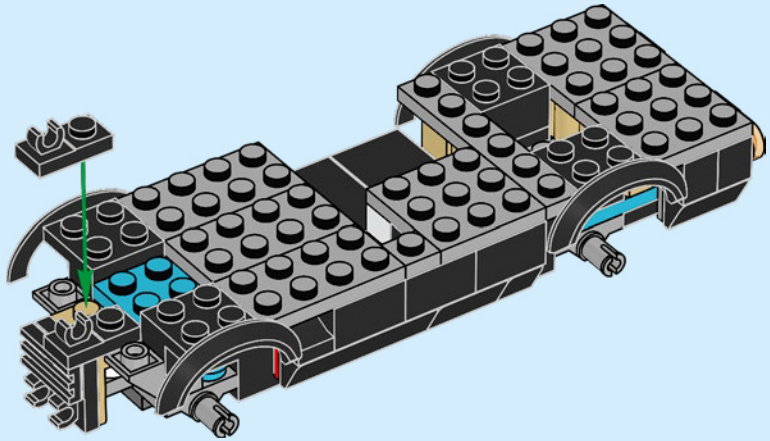

1x

35

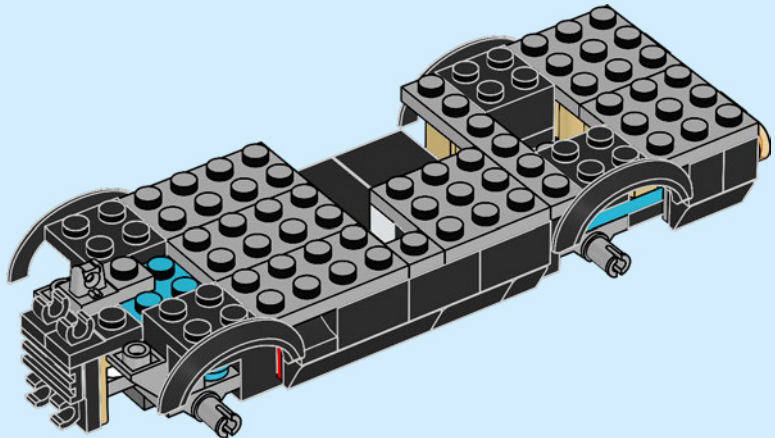



1x



1x

36

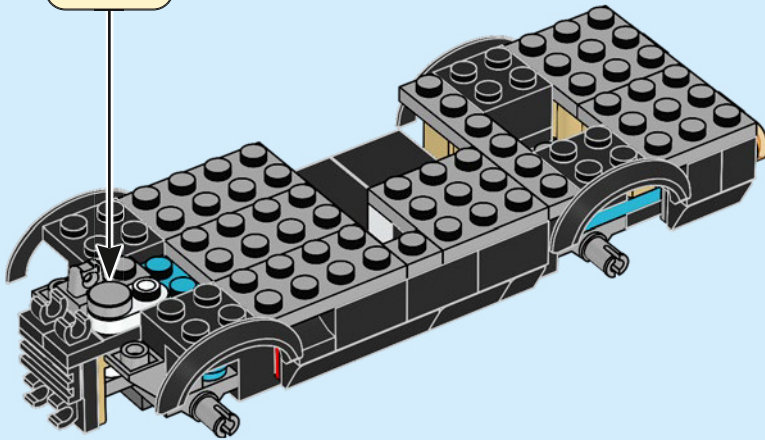
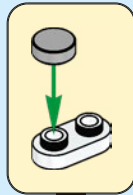



1x

37

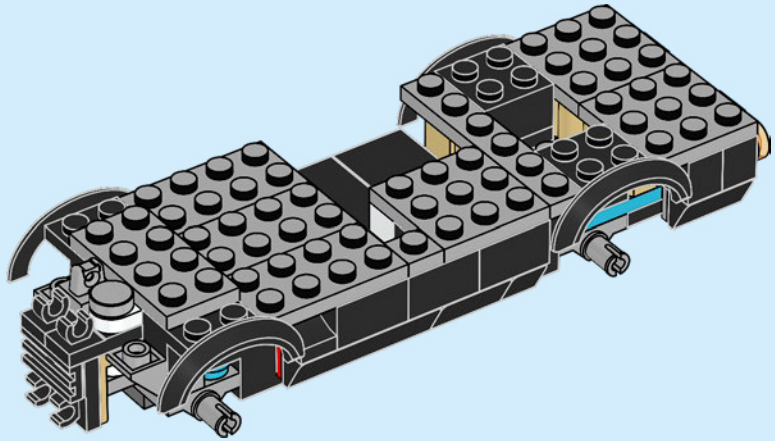

2x



2x

38

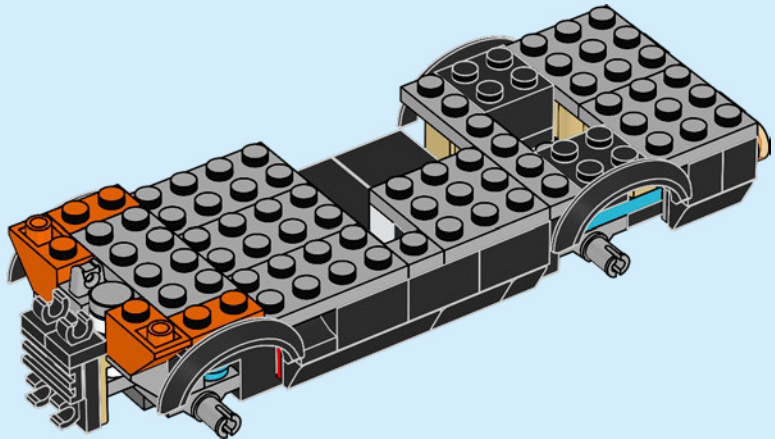

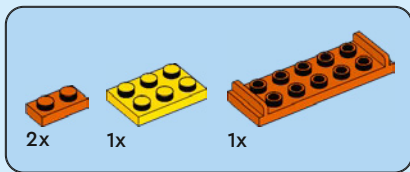

39

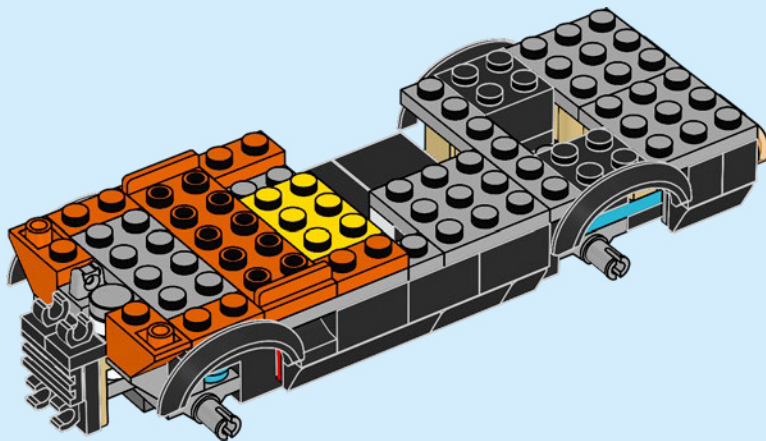

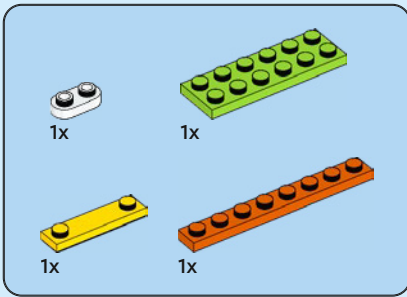

40

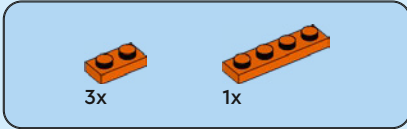
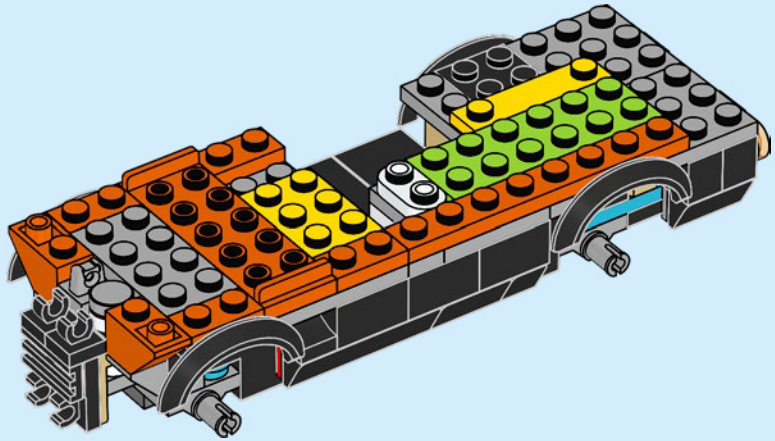

41

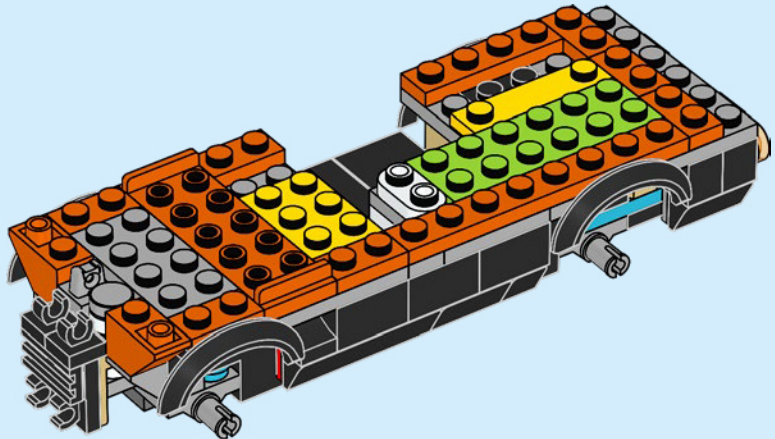

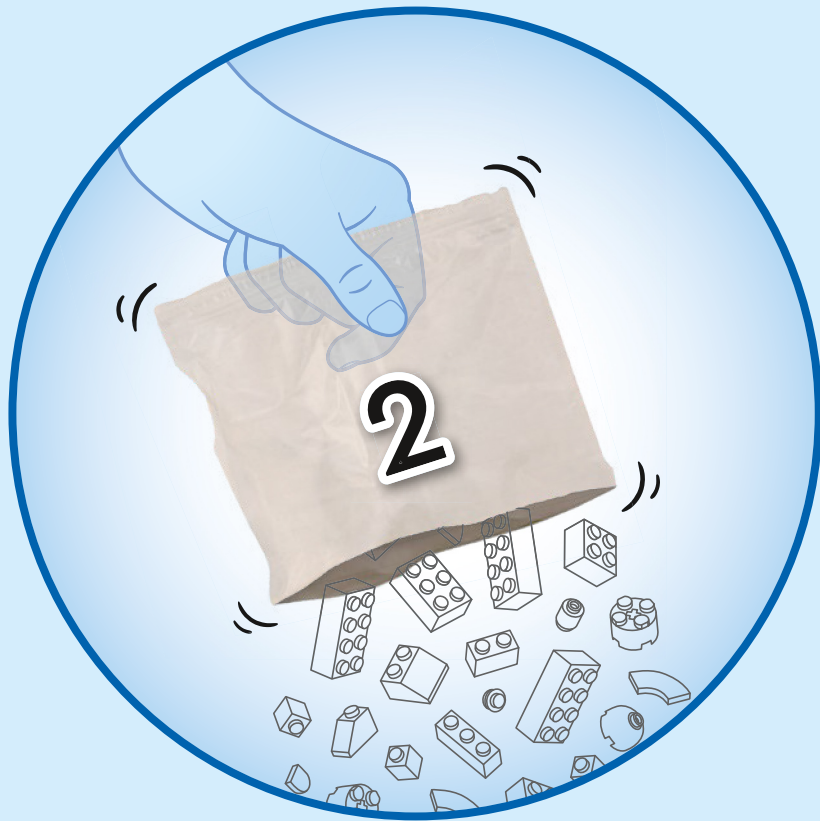

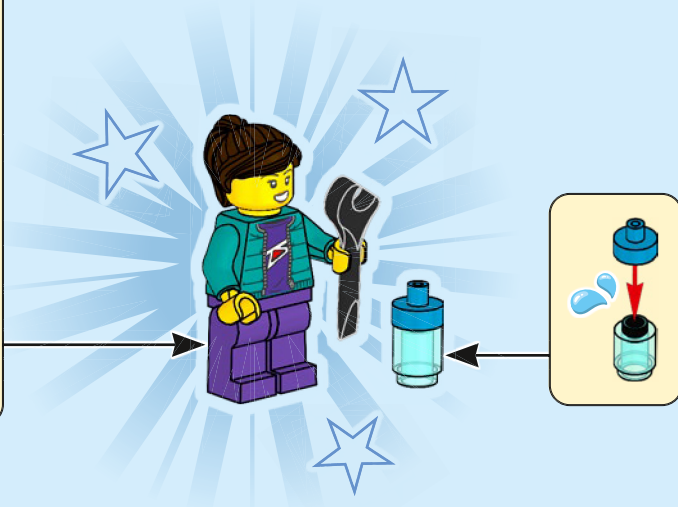
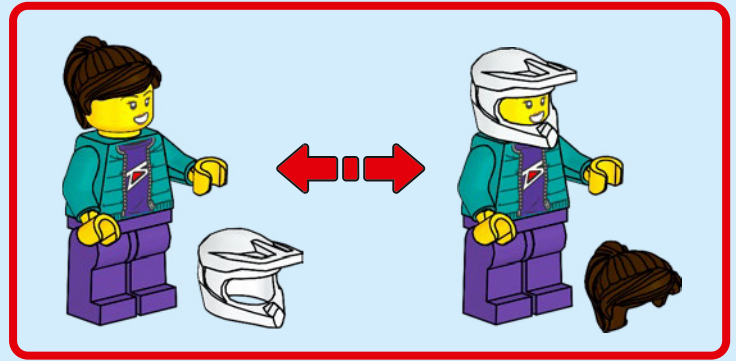
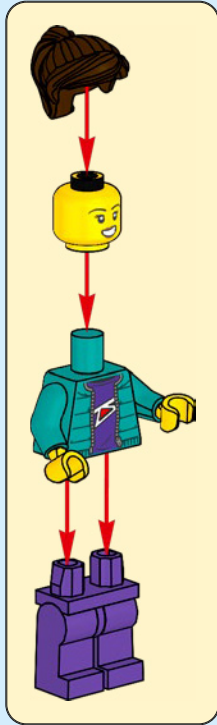

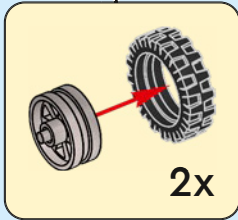
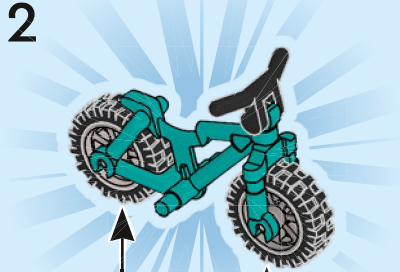
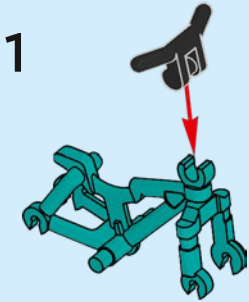
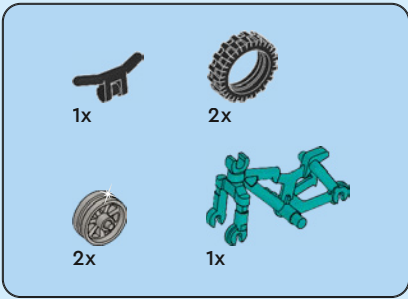

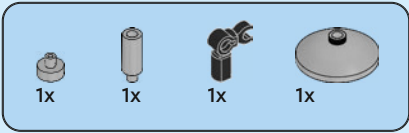

1

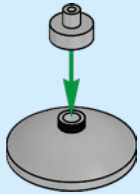

2

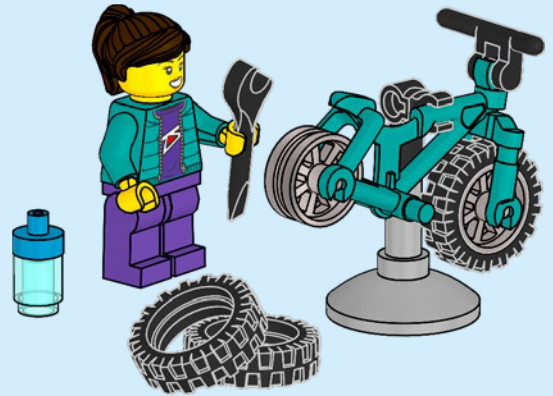
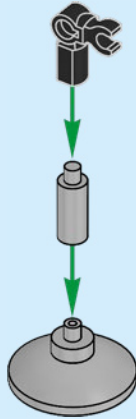

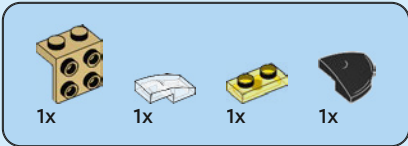

42

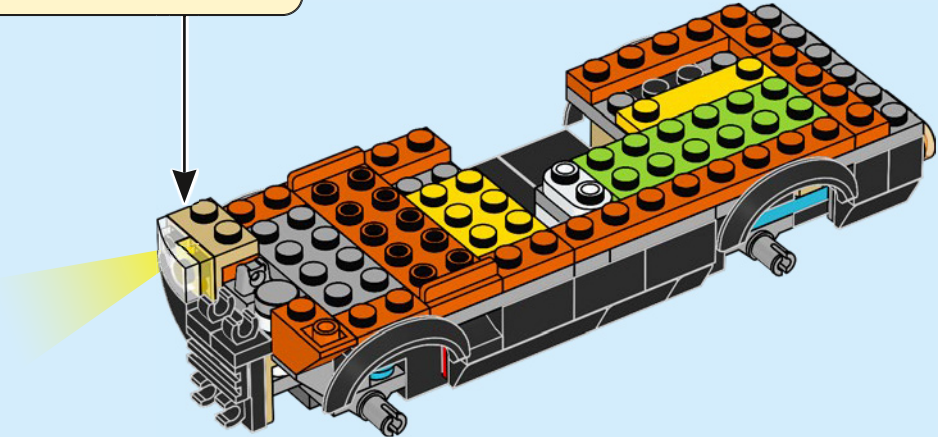
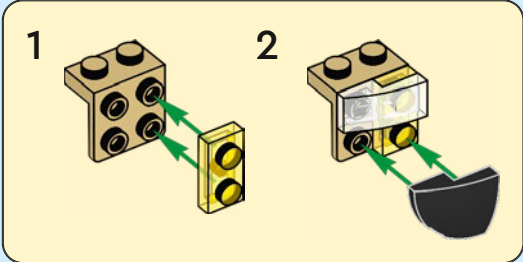

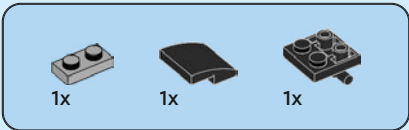

43

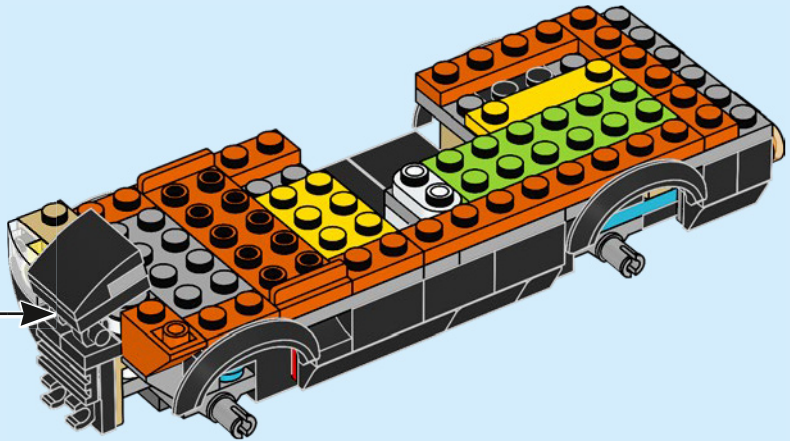
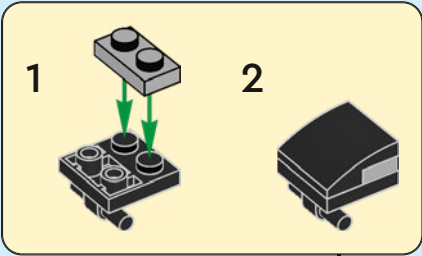

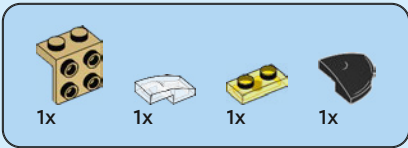

44

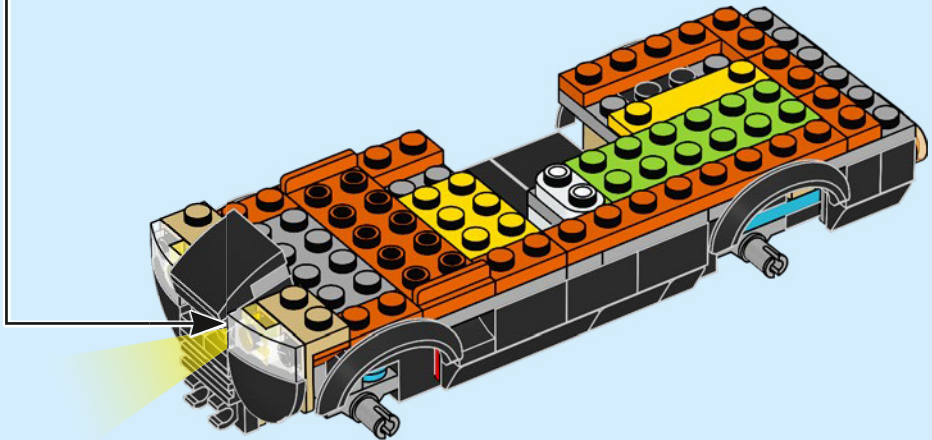
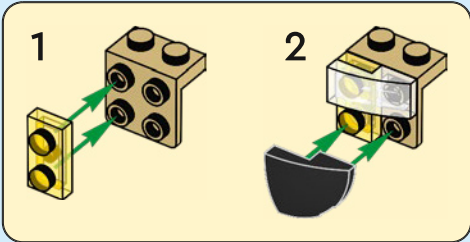

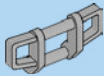

1x

45

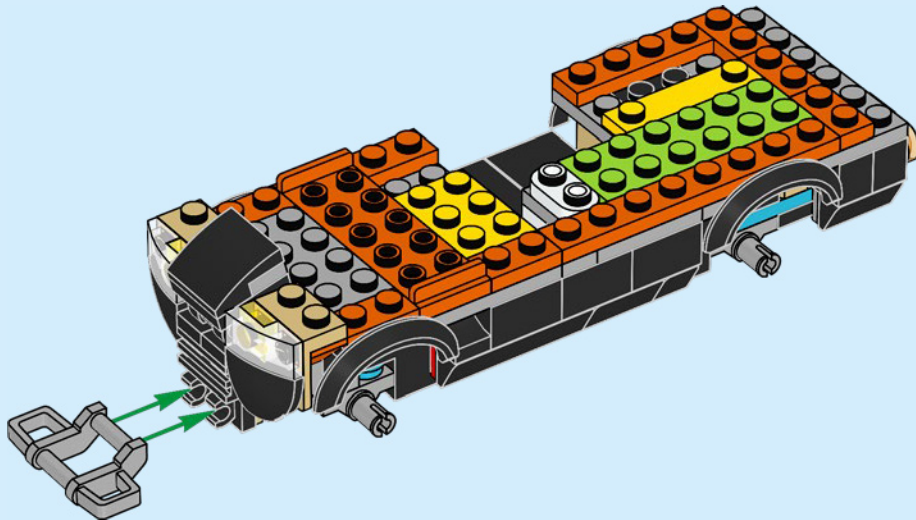

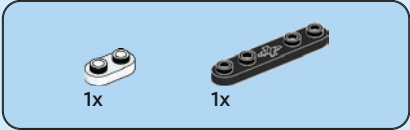
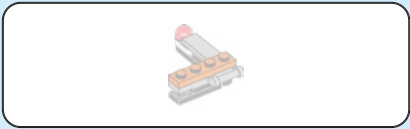

46

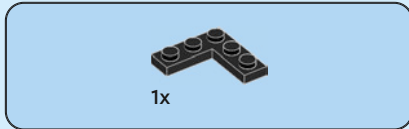
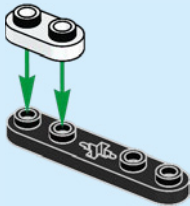

47

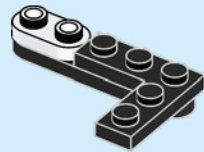



1x

48

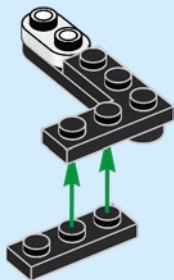

1x

49

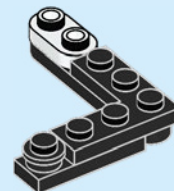

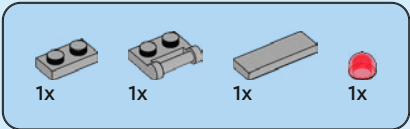

50

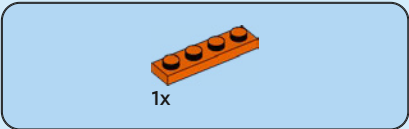
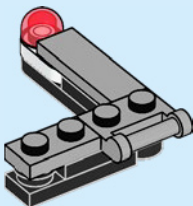

51

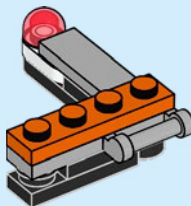

52

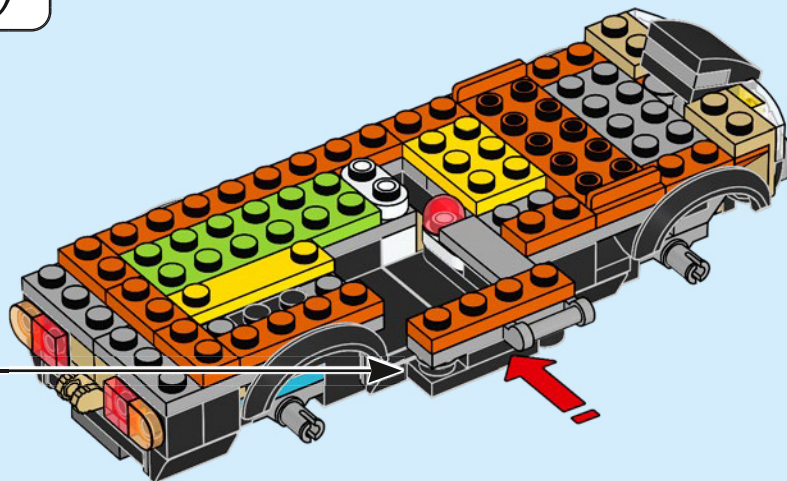

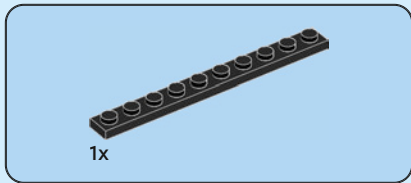

53

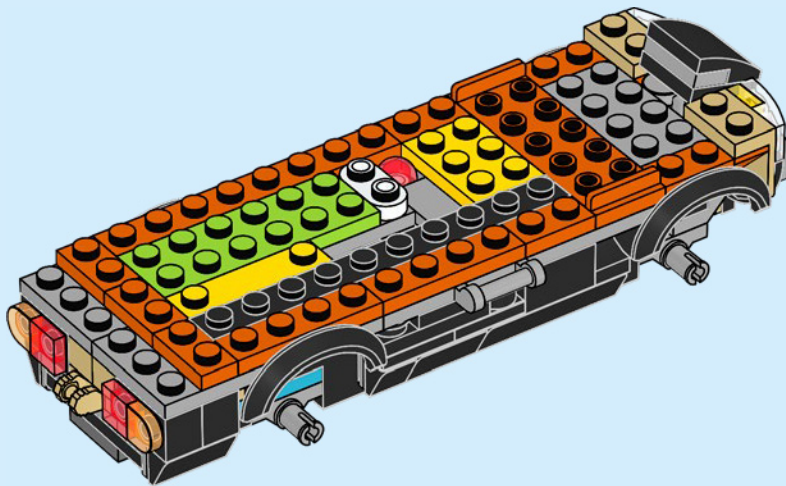

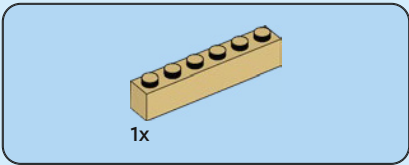

54

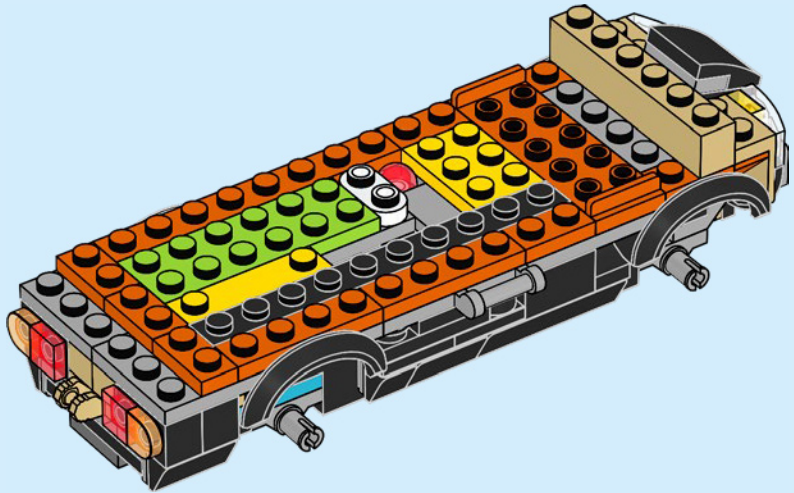

55

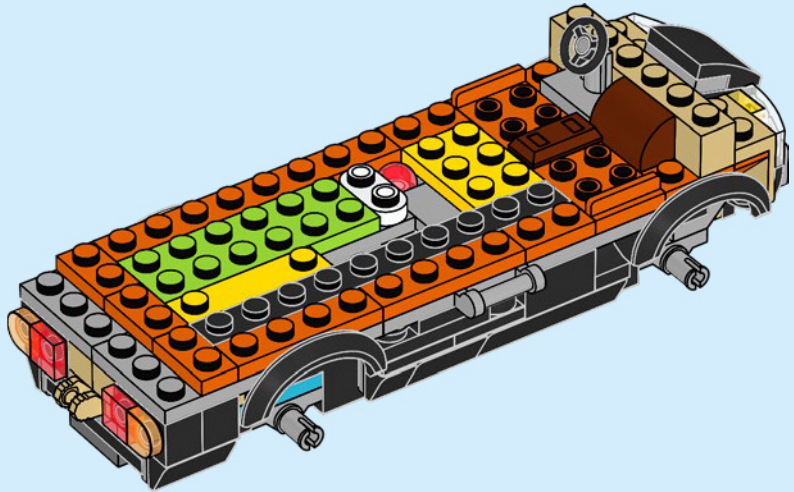

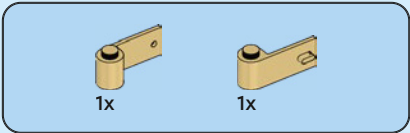

56

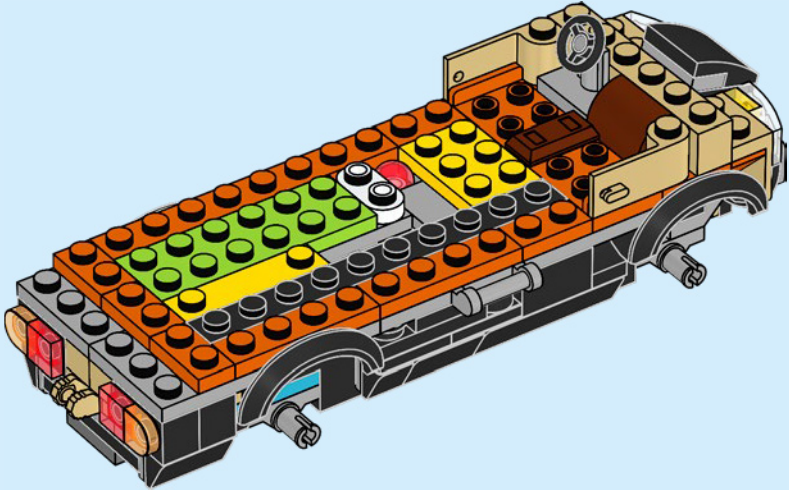



2x



2x

57

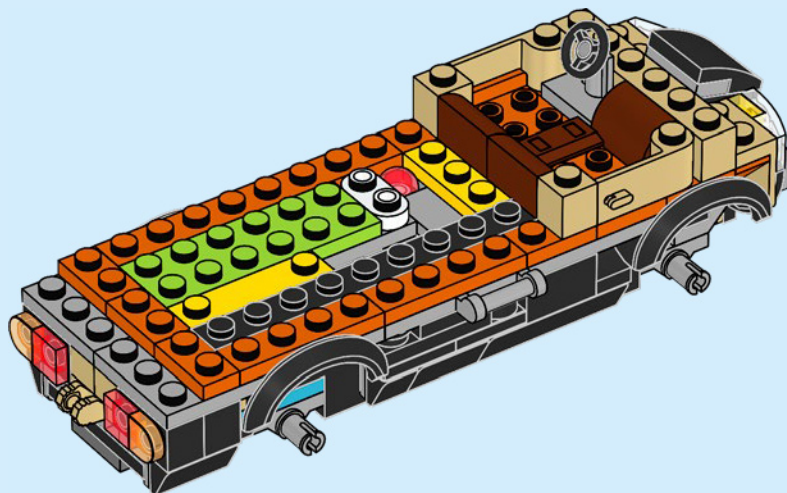

1x



1x



1x

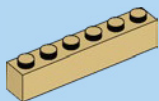

1x

58

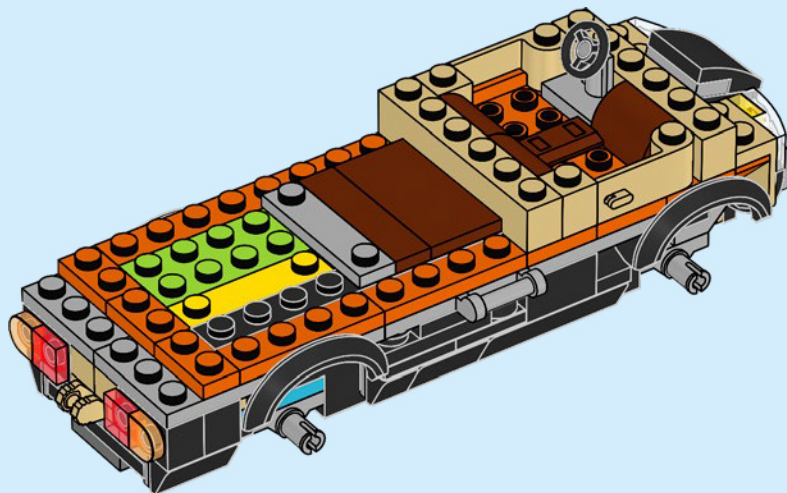

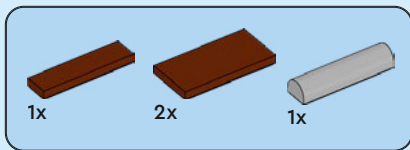

59

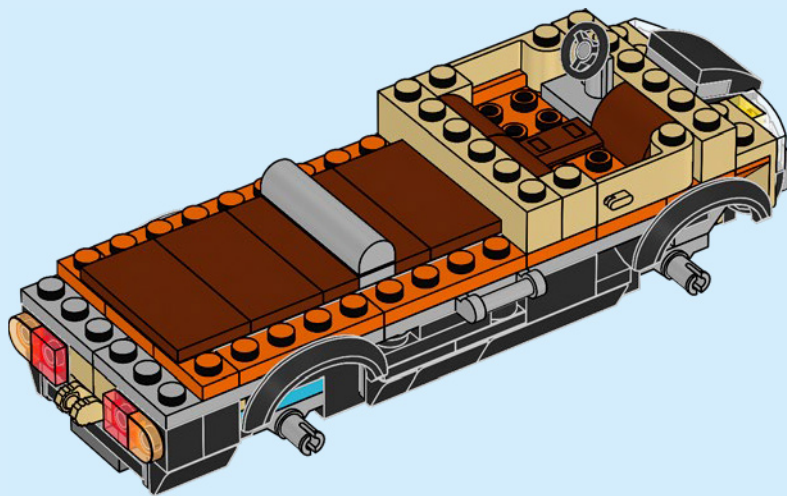

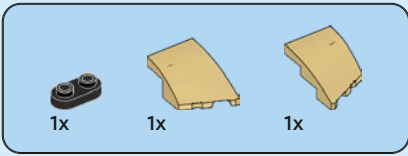

60

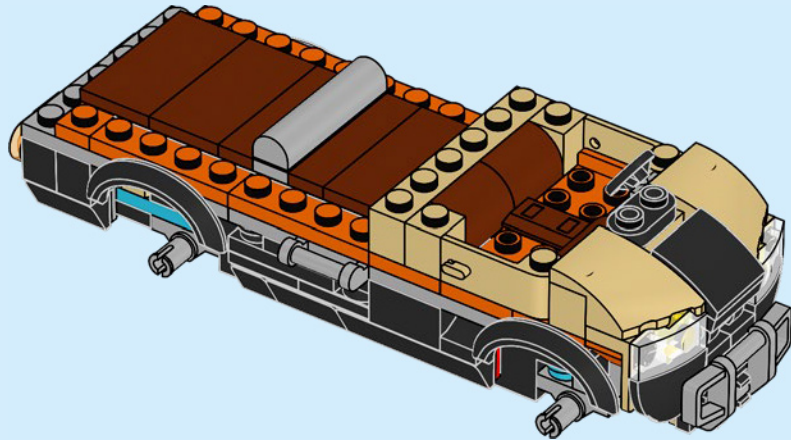



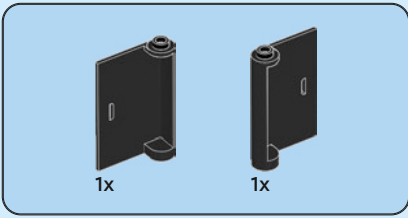

61

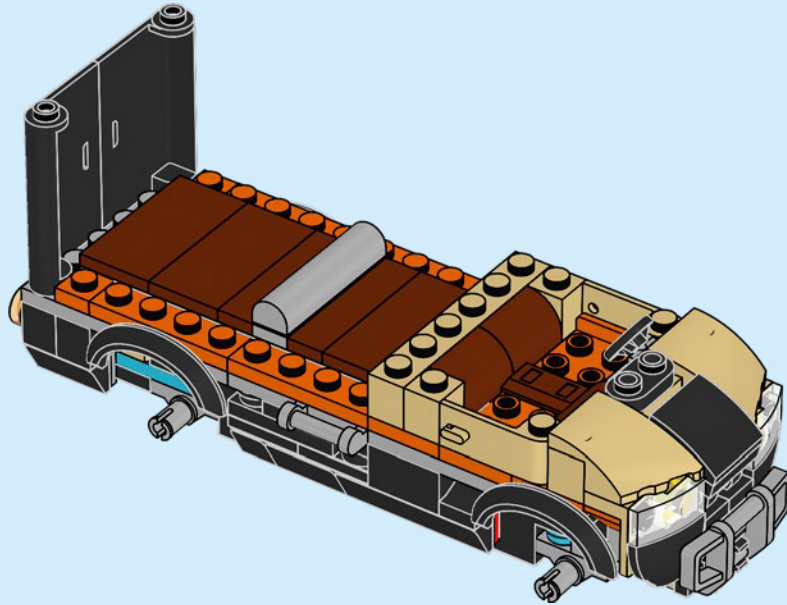

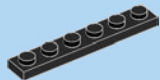

1x

62

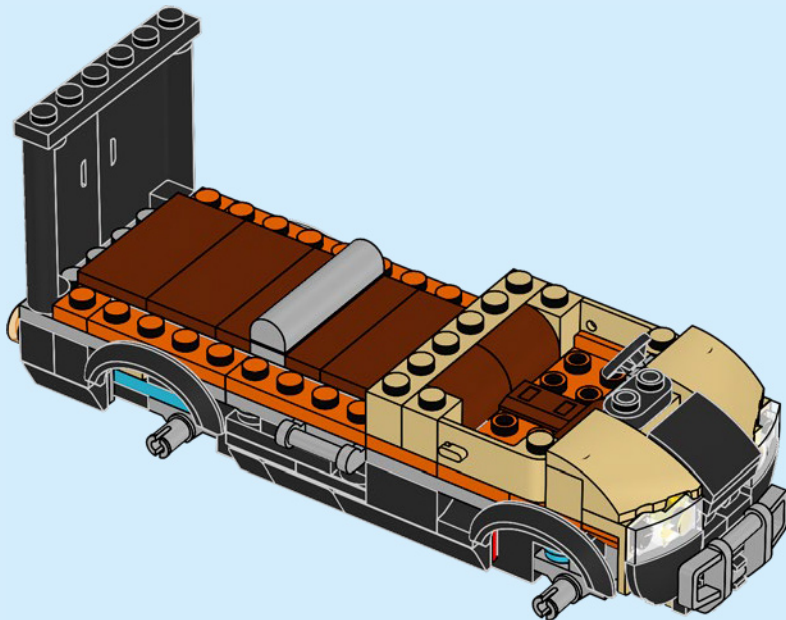



2x

63

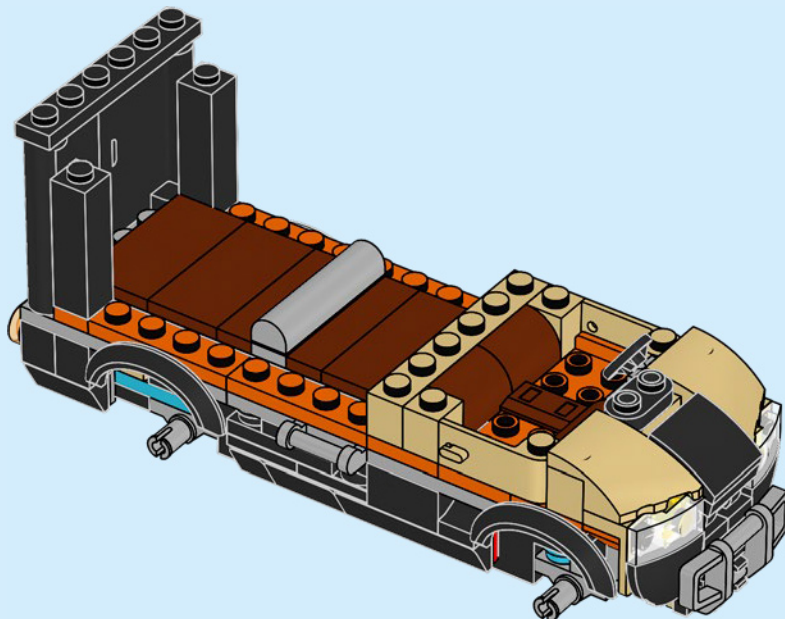

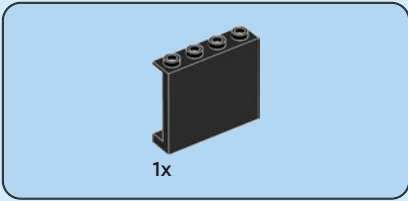

64

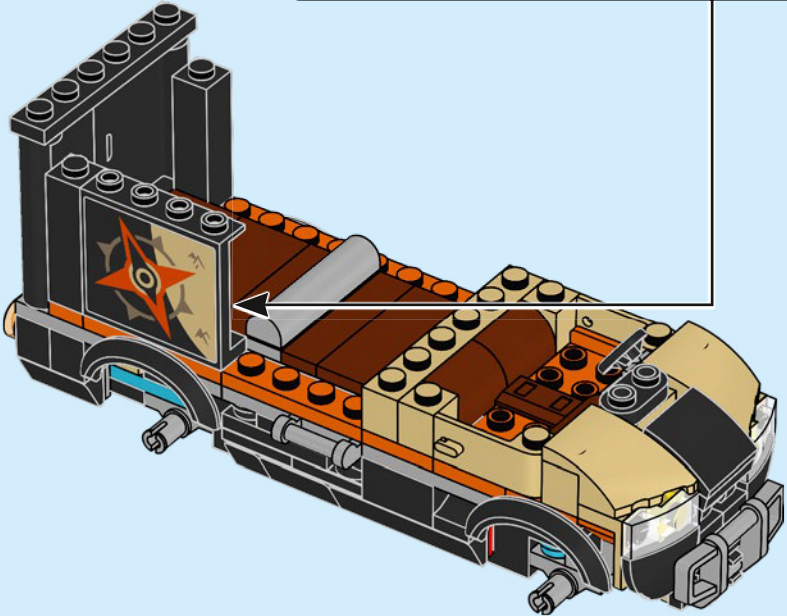
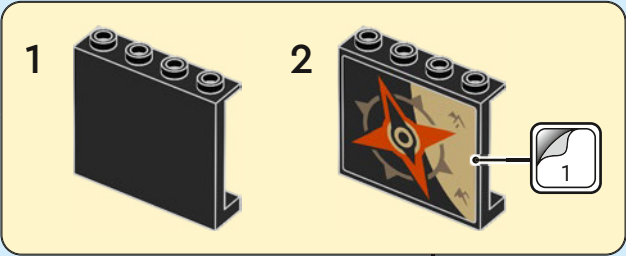



1x



1x

65

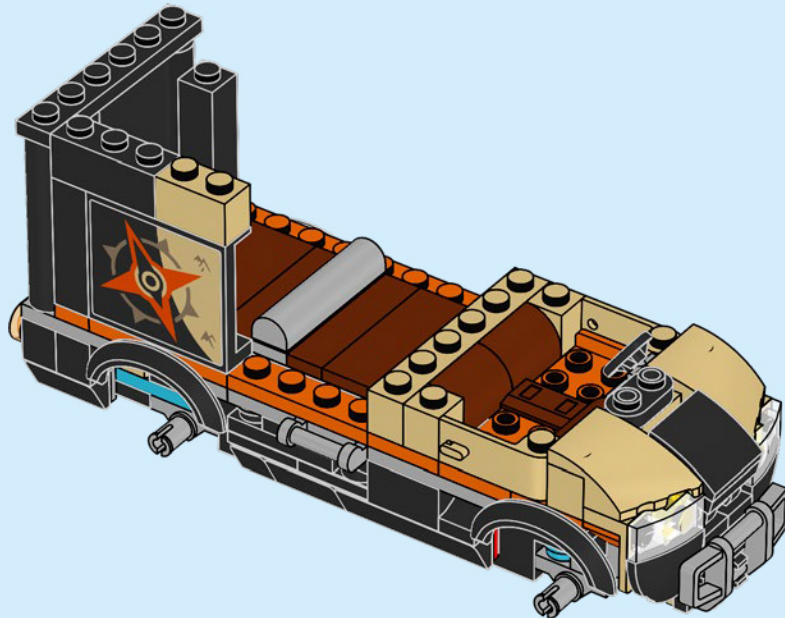

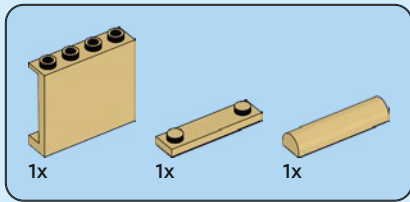

66

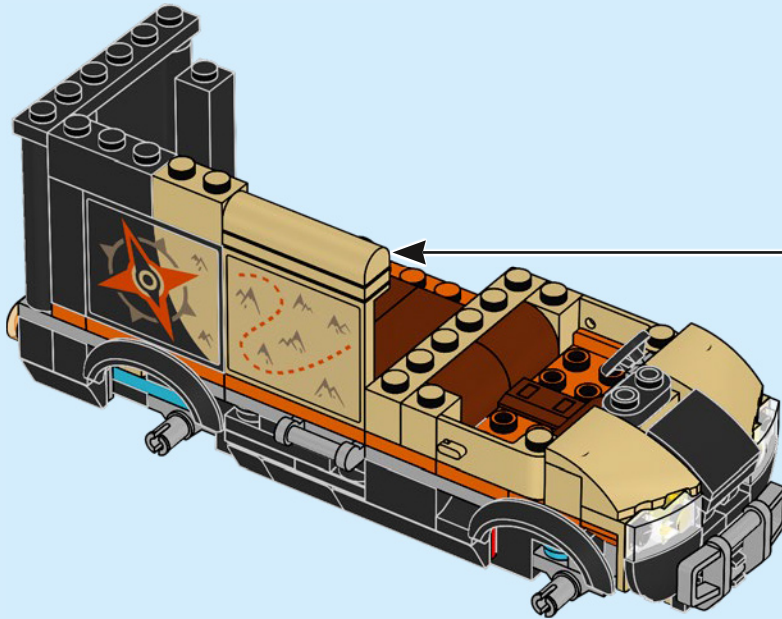
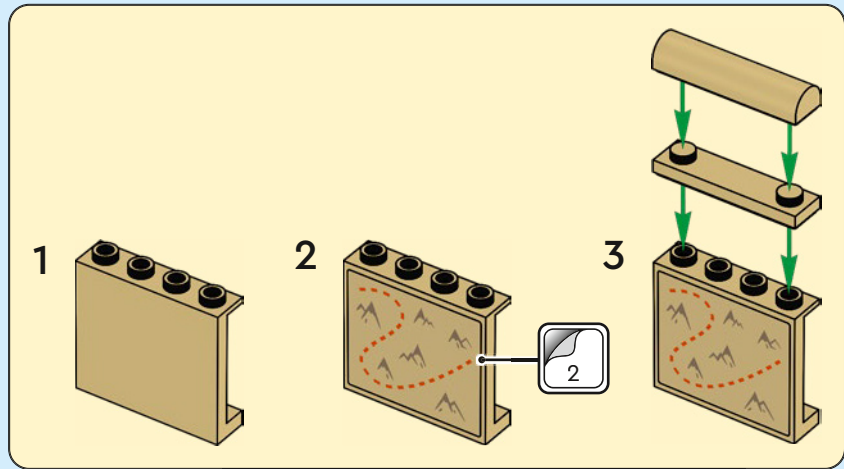



2x

67

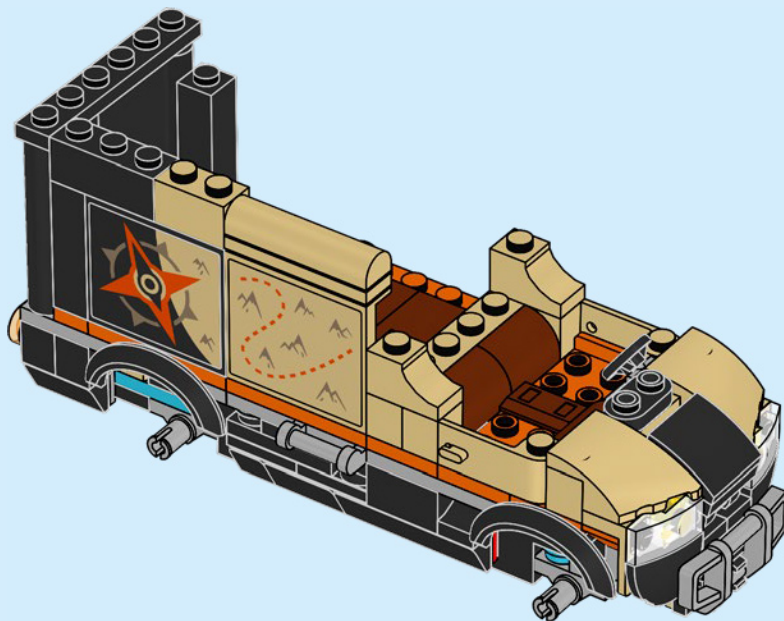

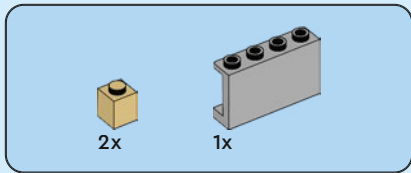

68

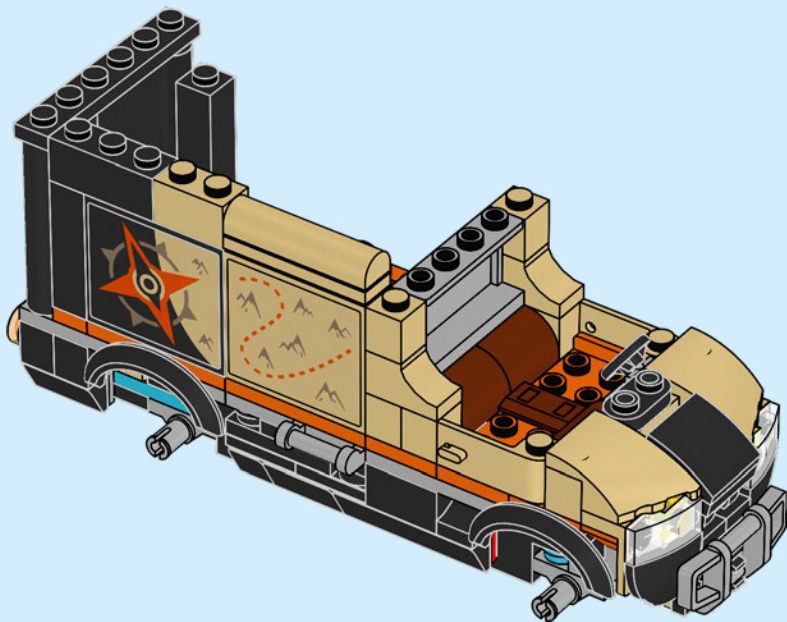



2x



1x

69

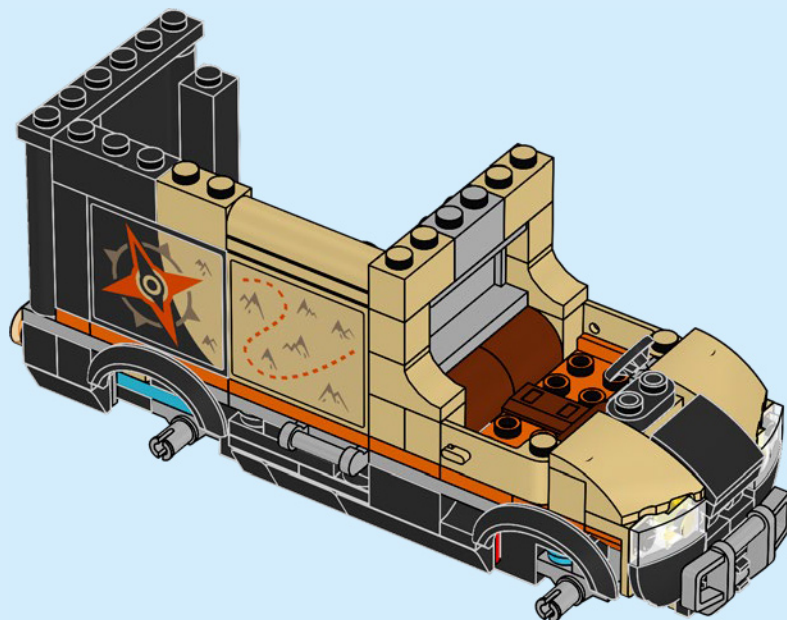

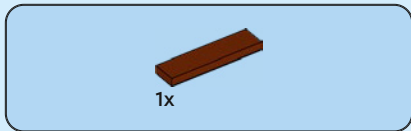

70

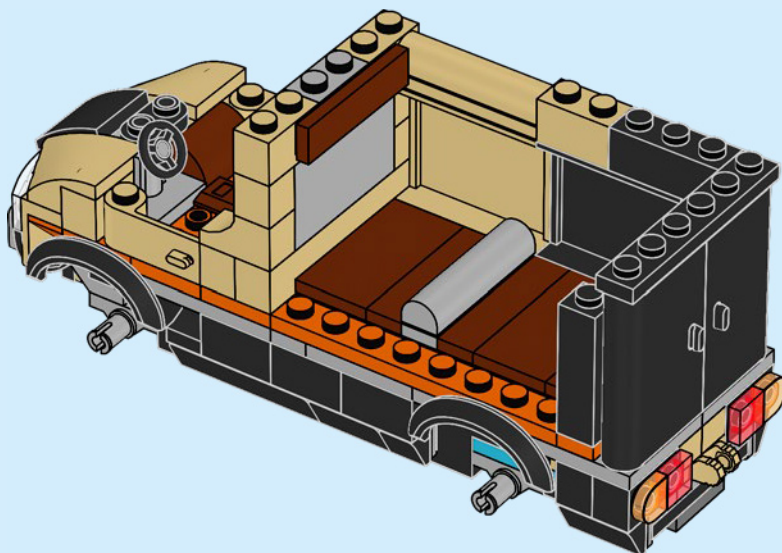

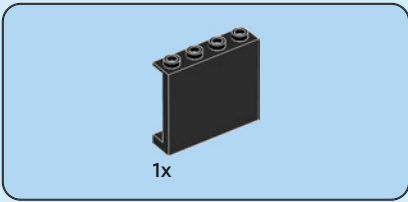

71

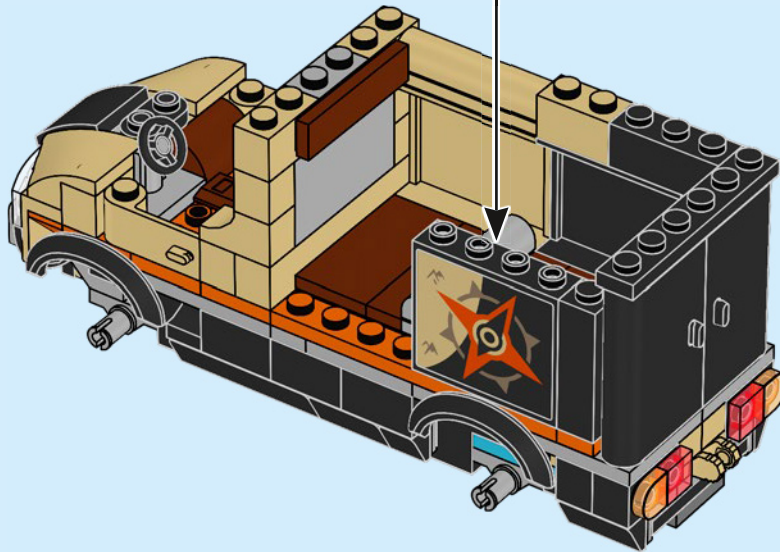
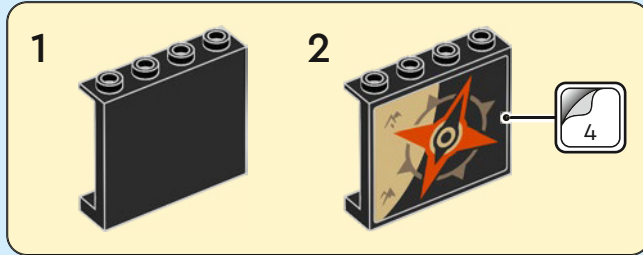

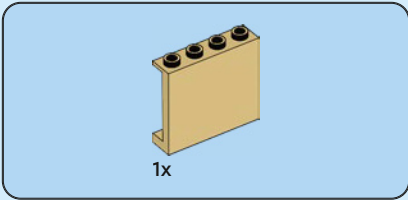

72

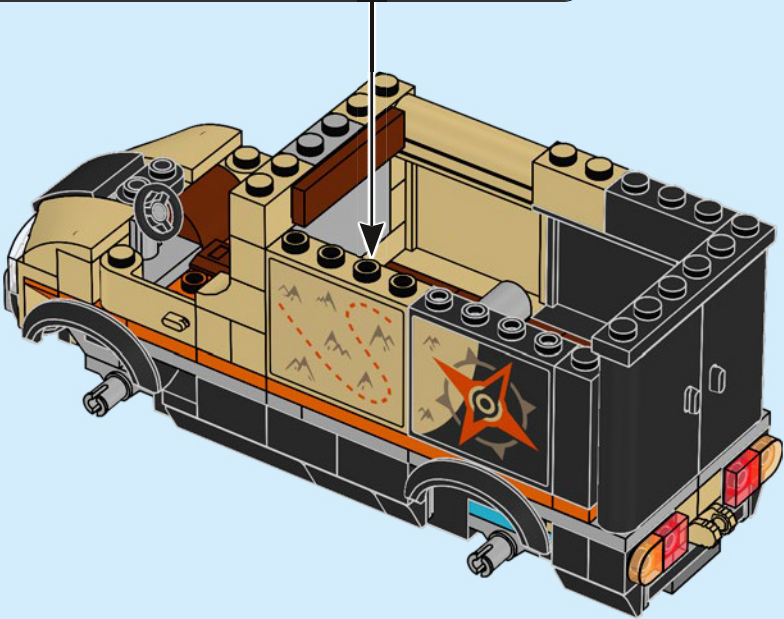
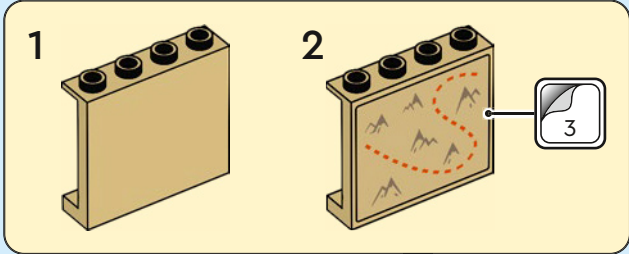

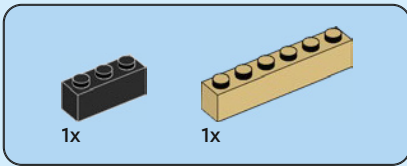

73

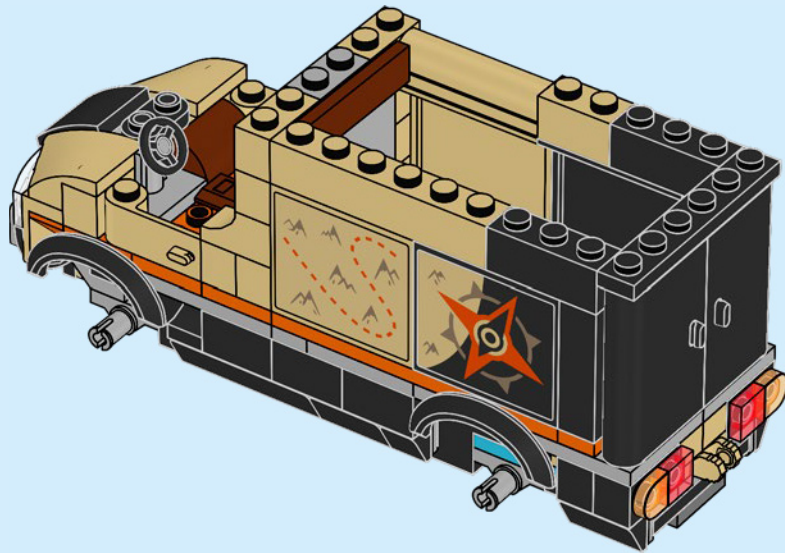

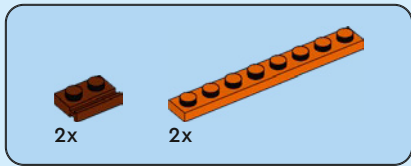

74

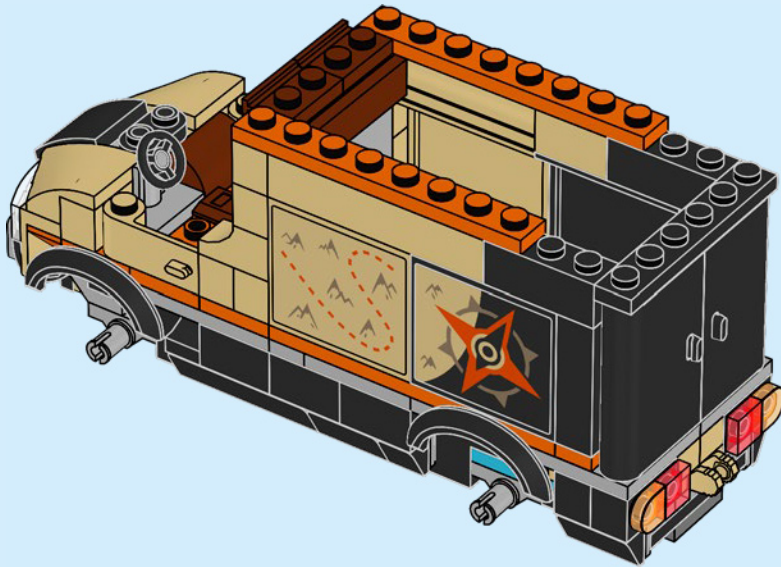



2x



2x

75

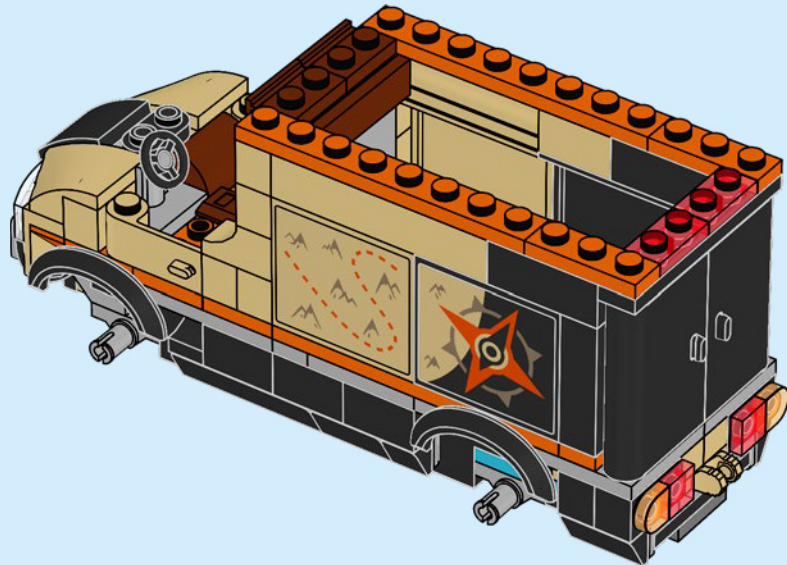

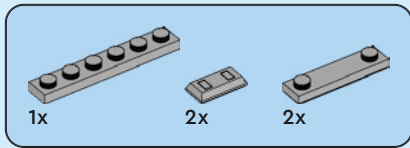

76

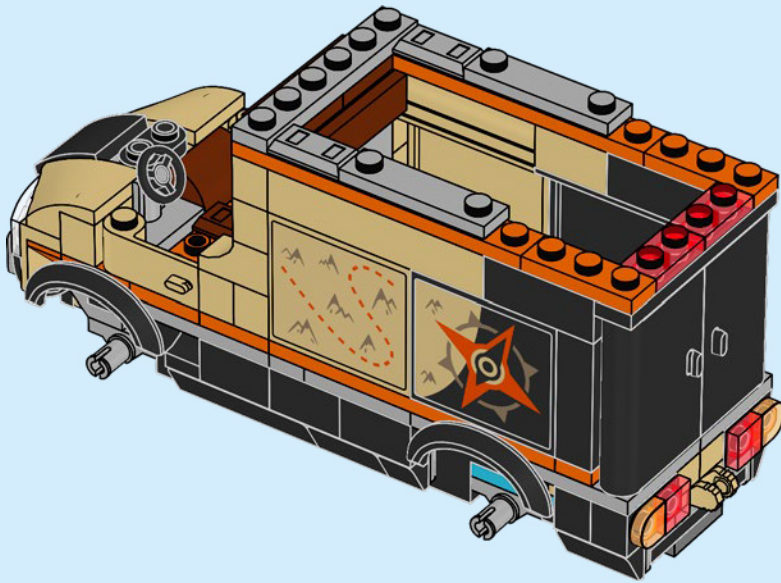



4x

77

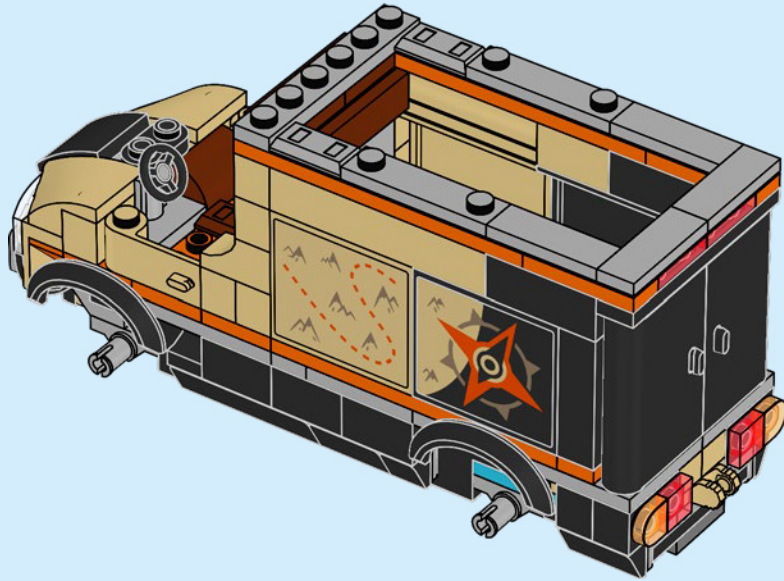

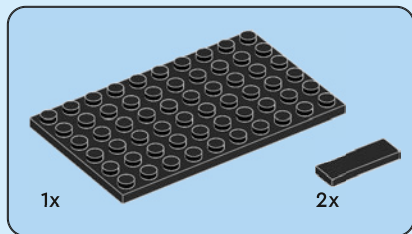

78

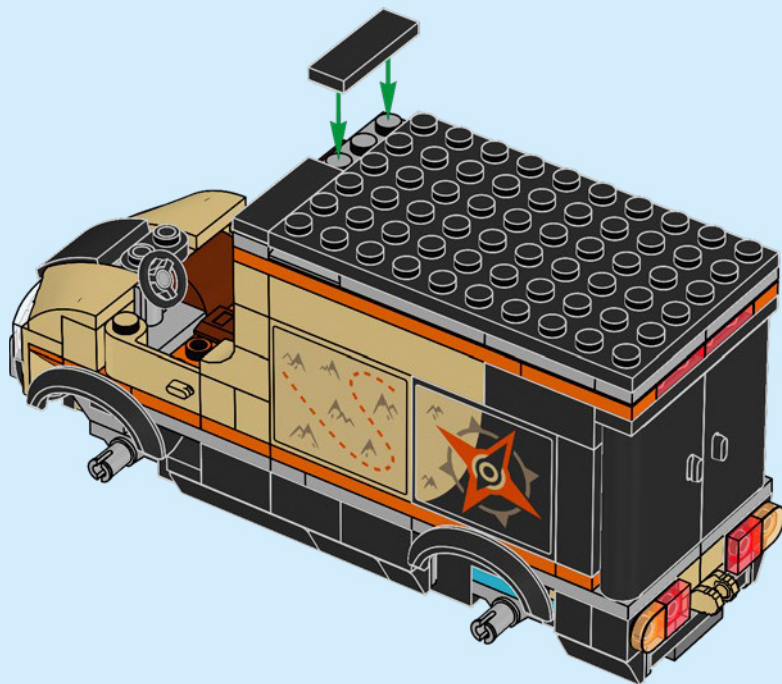



2x

79

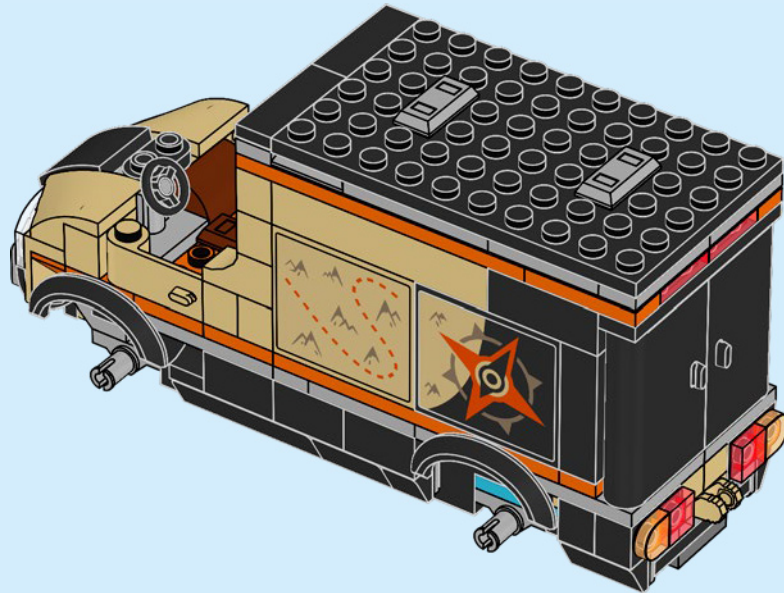



2x



2x

80

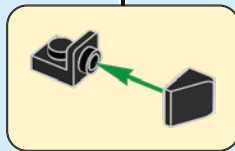
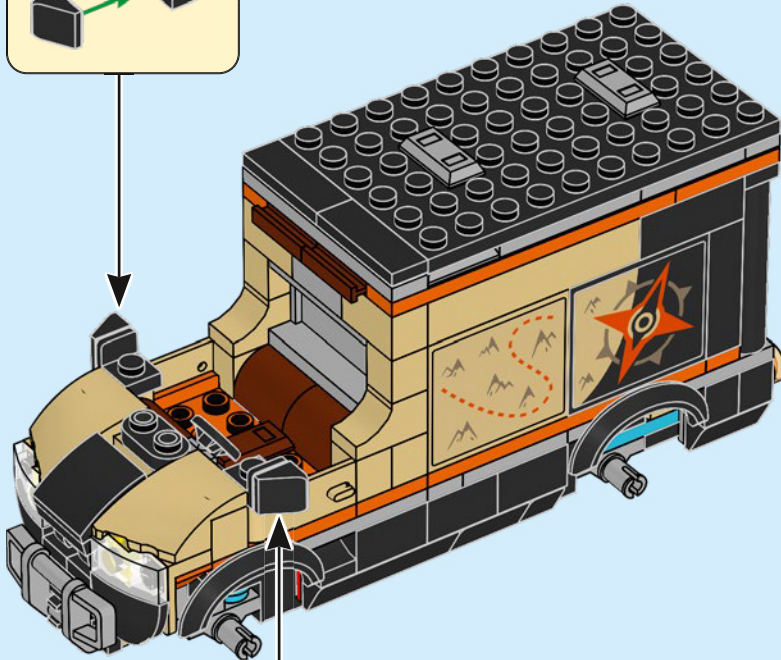
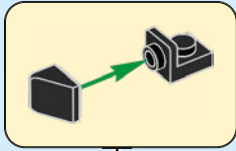

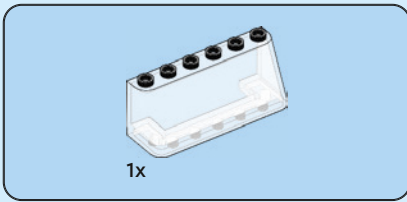

81

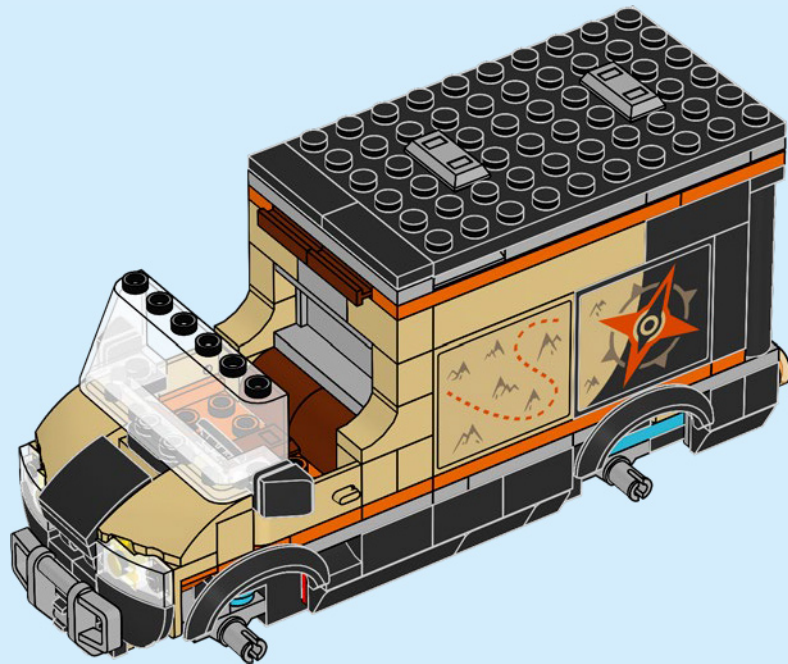

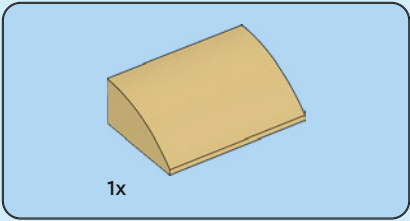

82

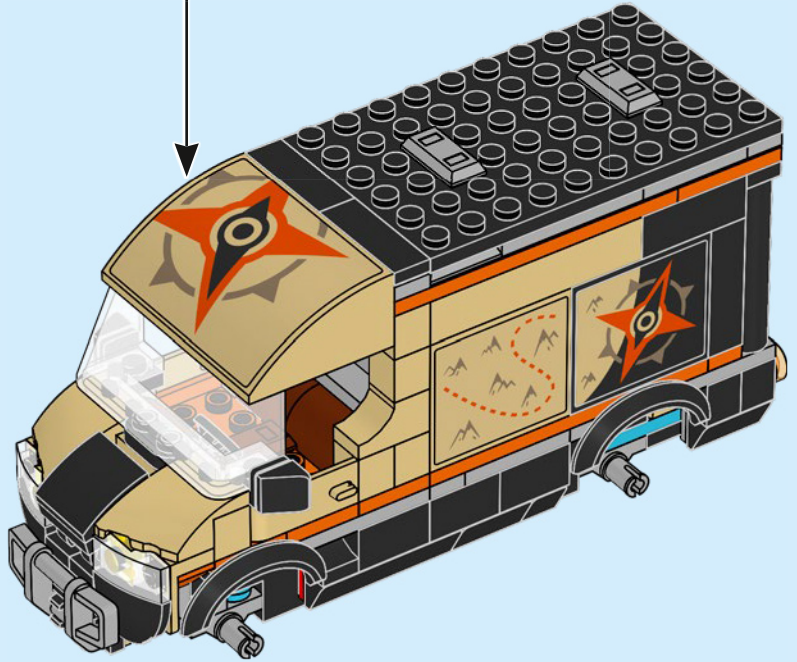
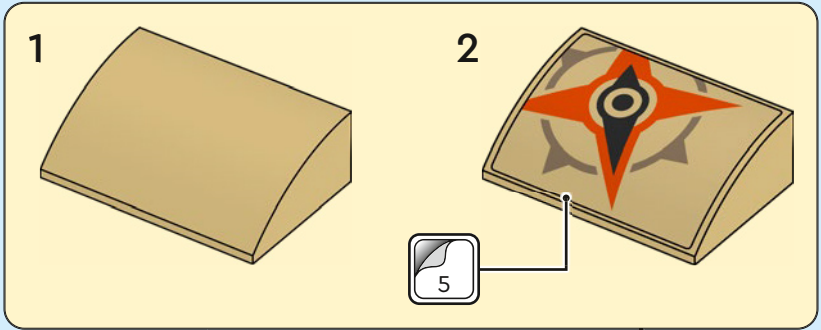



1x

83

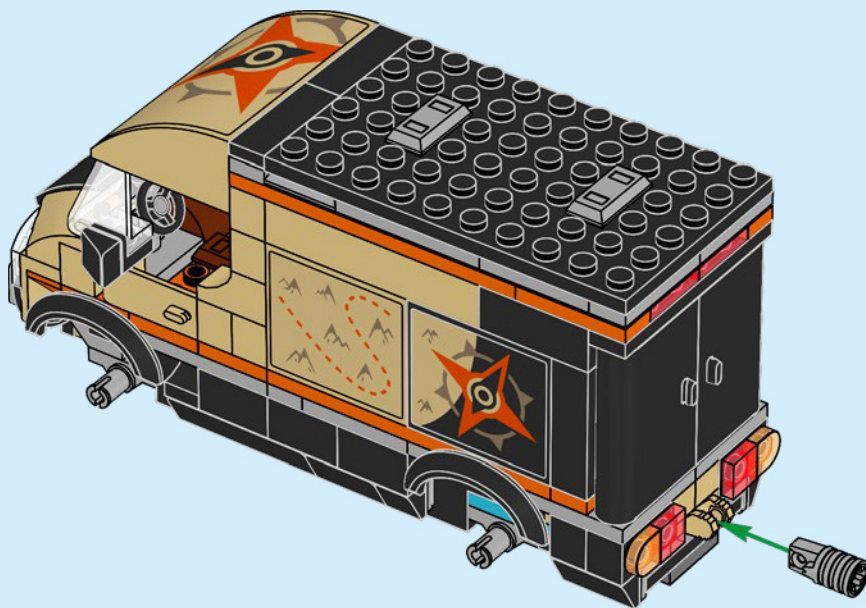

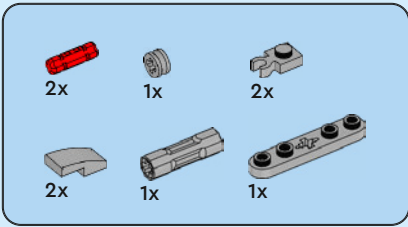

84

1

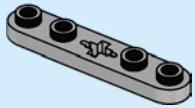

2

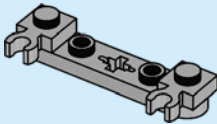

3

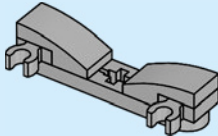

4

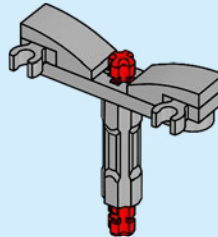

5

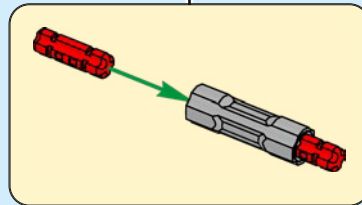
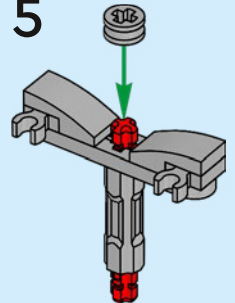

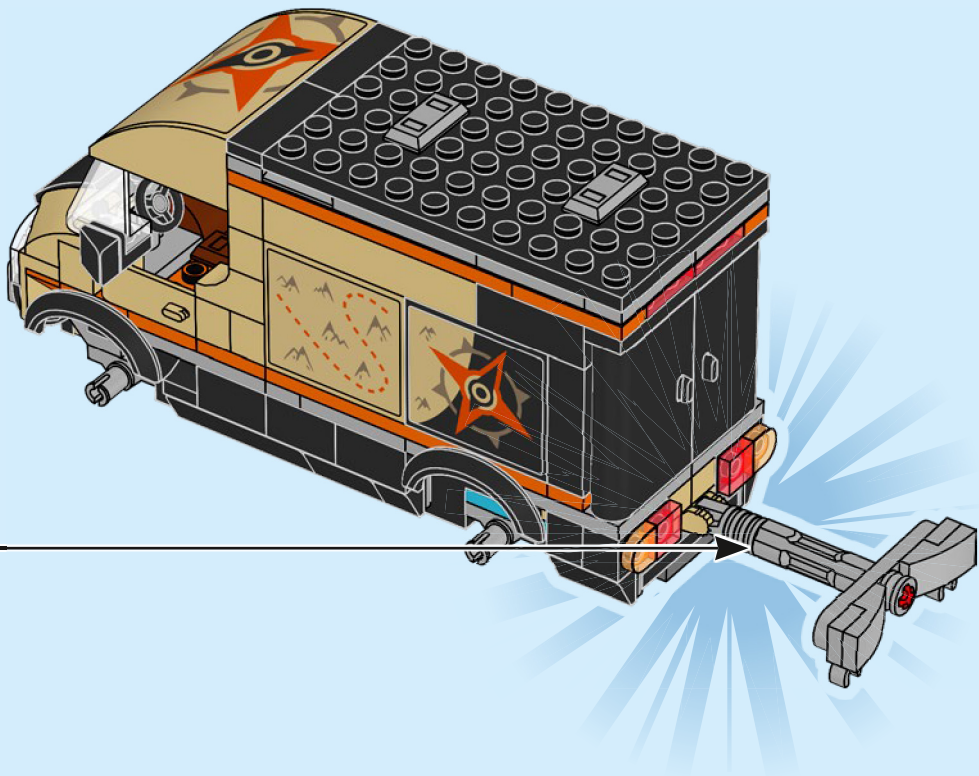

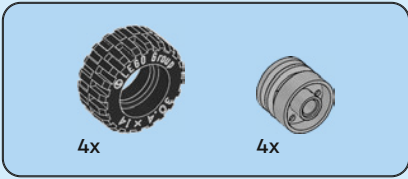

85

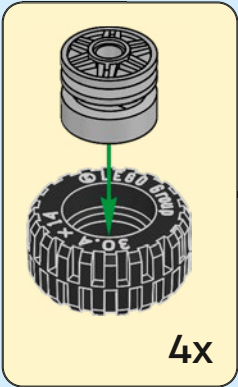
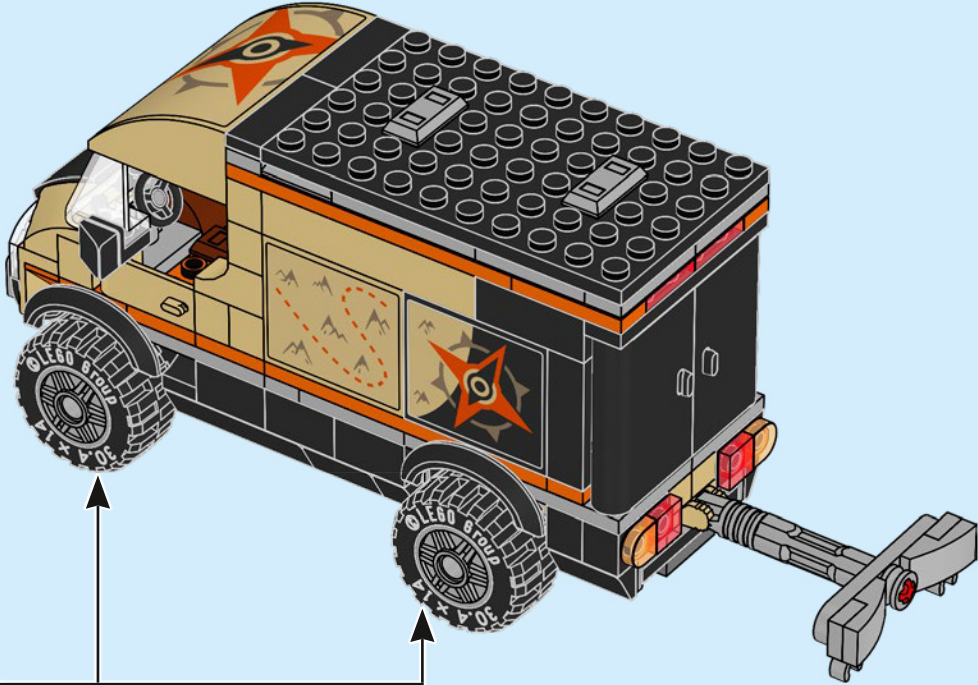

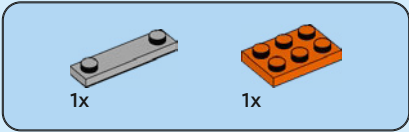
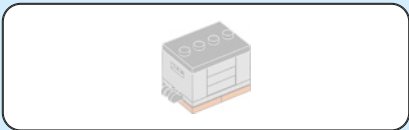

86

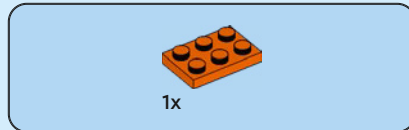
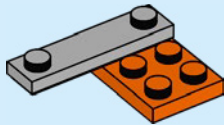

87

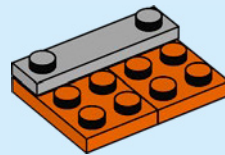

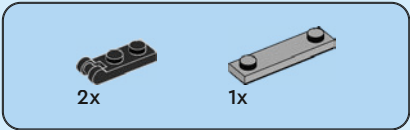

88

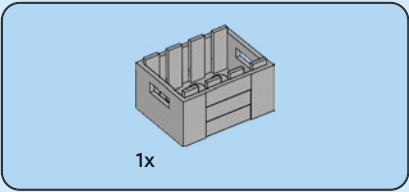
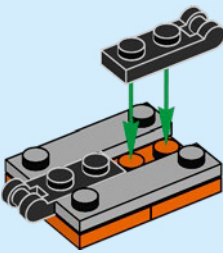

89

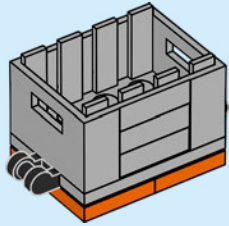

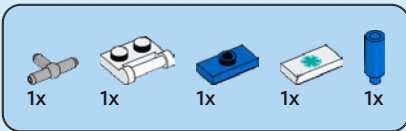

90

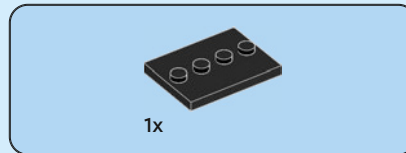
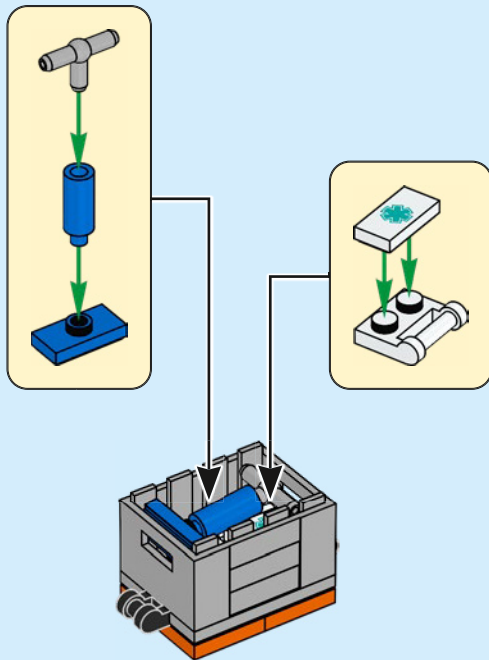

91

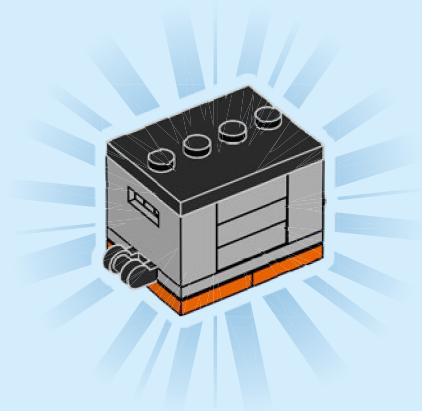

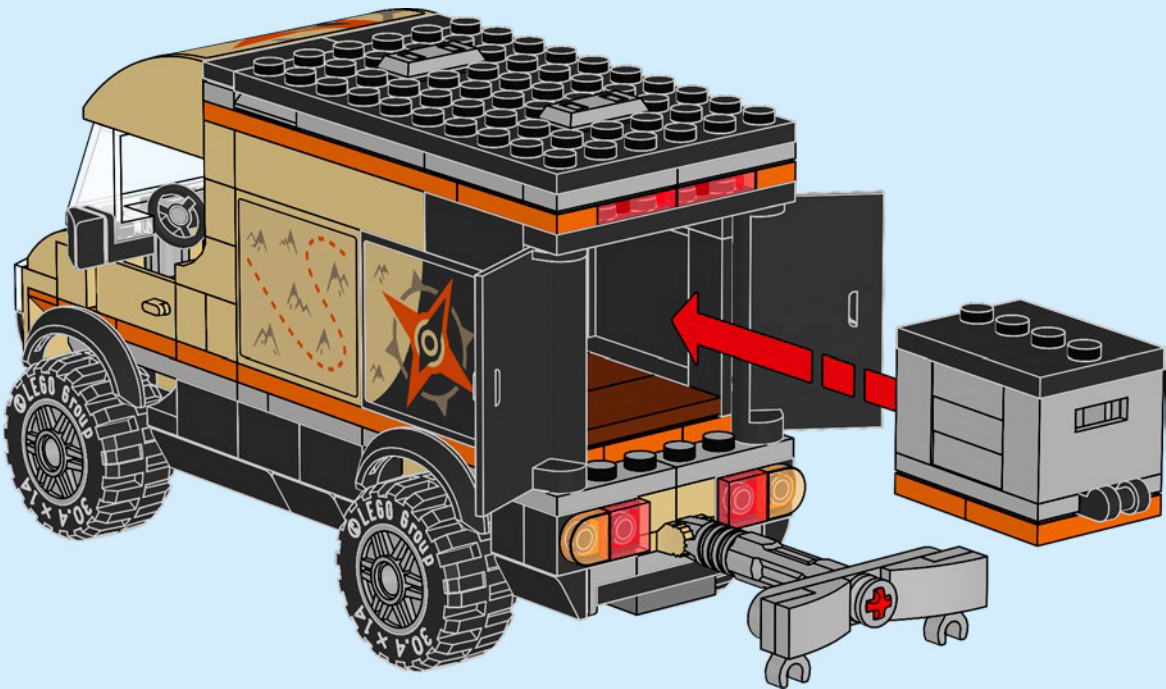

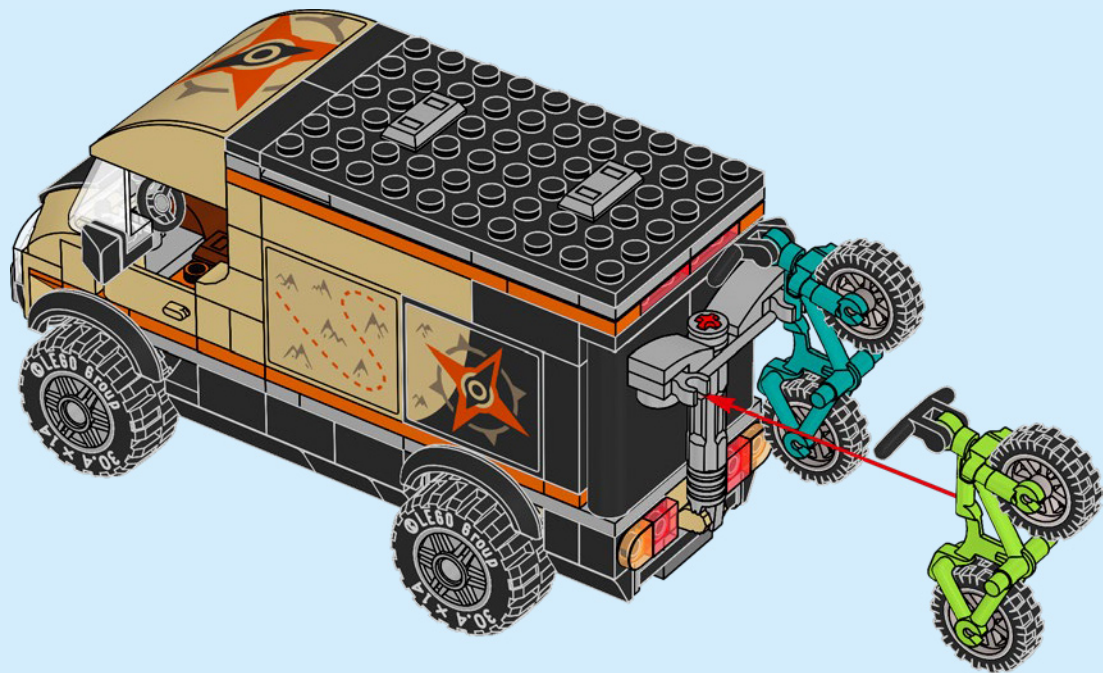

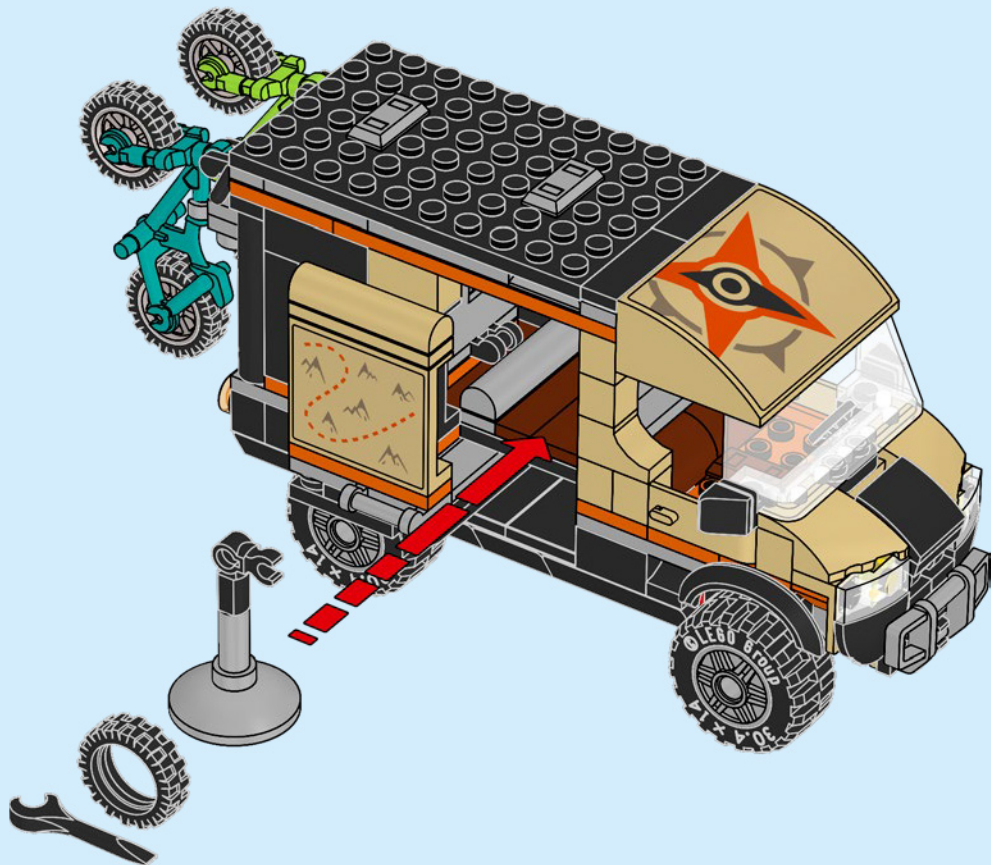

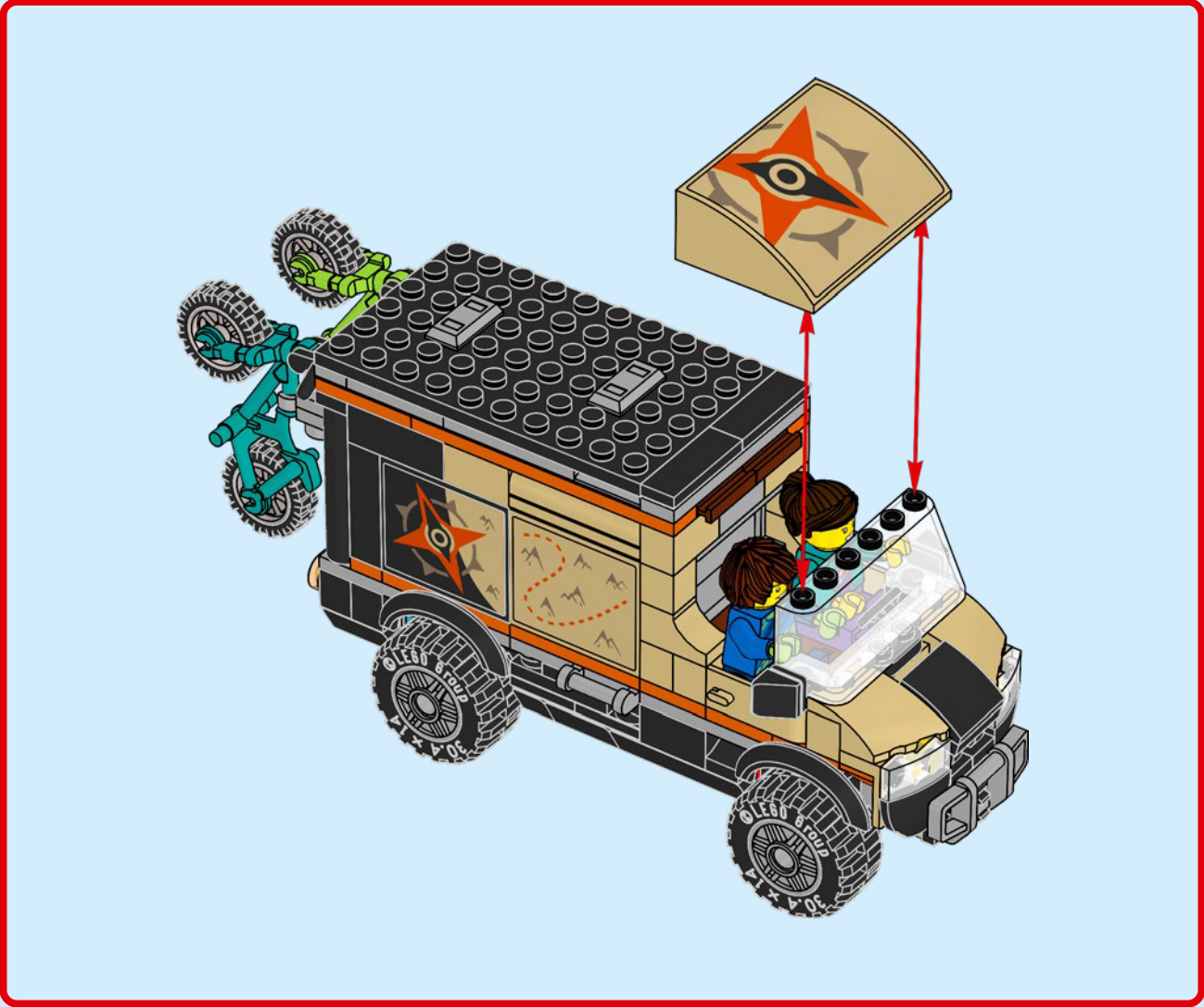





CITY

60494



60492



60497



60480



1x 300501	1x 6608949	1x 6092582	2x 6562635	1x 6468536	1x 6439175
4x 6210272	1x 6404629	1x 6610089	2x 6369578	1x 362326	1x 6280168
1x 6426712	1x 6608952	1x 6288000	2x 6138173	1x 362326	4x 6484901
1x 6434779	1x 6404628	1x 6215170	1x 4226995	2x 362226	2x 6076678
1x 4222017	2x 6146877	2x 6168616	4x 6347310	2x 4558170	2x 6076678
1x 6167450	1x 6257600	3x 302124	1x 241226	1x 400626	1x 300926
4x 4113915	1x 6375672	1x 6257598	1x 6602322	1x 300226	1x 366626
6x 6458392	3x 4218749	1x 614126	1x 6064174	2x 6162892	1x 4181144
3x 4218749	3x 4112982	4x 4504382	5x 6064174	4x 6170505	1x 4181144
3x 4109995	1x 6608950	2x 6065496	2x 3003126	2x 4558209	1x 447726
2x 6383295	2x 6372478	2x 6234695	1x 235726	2x 6601521	1x 303326
1x 6338180	2x 4142865	1x 6338384	1x 6053077	2x 6601521	4x 6508253
1x 4114026	2x 4142865	1x 6210270	1x 6488003	2x 6601521	1x 303326
3x 6117975	1x 6584956	4x 4548180	2x 4515368	4x 4619323	2x 6508253



1x
6207255



2x
6507959



1x
6491486



1x
6261744



3x
6311210



2x
4645103



3x
4211194



3x
4579690



1x
6436421



1x
6271165



1x
6284071



1x
6258831



1x
4211399



1x
6265704



1x
4211508



2x
6296894



2x
6407767



2x
4211398



1x
6015344



4x
6134378



1x
6265694



2x
6028813



4x
4654582



1x
4244627



4x
6109684



1x
6070564



4x
6273212



5x
4558169



1x
6608948



1x
6608948



1x
6608948



2x
4211406



5x
6257593



1x
6402876



1x
6061675



3x
6015347



1x
6549304



4x
4211395



1x
6108560



2x
6408542



2x
4211438



2x
4211406



1x
4210796



1x
4210796



1x
4210796



1x
6564868



2x
6581817



2x
6514003



2x
6514002



1x
6603898



1x
6310580



1x
6603898



1x
4187743



1x
6608945



1x
4621548



1x
4210796



1x
4210796



1x
4210796



1x
4210796



1x
4210796



1x
4586410



1x
4162916



1x
6093516



4x
6413492



1x
6223733



2x
6102986



2x
6119107



1x
4625629



1x
6510175



1x
6510175



1x
6608946



3x
6467485



7x
6466720



2x
6584054



2x
6567216



2x
6584052



2x
6469089



2x
6469089

[LEGO.com/service](https://www.lego.com/service)

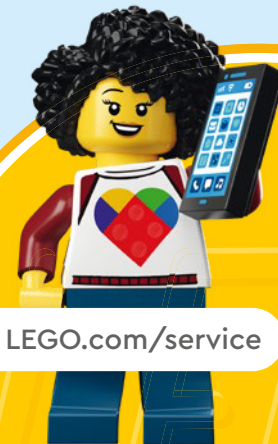

YOU COULD **WIN**



Scan this QR code or go to **LEGO.COM/PRODUCTFEEDBACK** and give us your short feedback about this LEGO® set for a chance to win a cool LEGO prize.

Terms and Conditions apply*

EN: YOU COULD WIN. Terms and Conditions apply* **DE: Du könntest GEWINNEN.** Es gelten die Teilnahmebedingungen* **FR: TU POURRAIS GAGNER.** Des conditions s'appliquent* **IT: Potresti VINCERE tu.** Termini e condizioni sono applicabili* **ES: PUEDES GANAR.** Aplican términos y condiciones* **PT: PODERÁ GANHAR.** Aplicam-se Termos e Condições* **ZH: 轻松获奖. 条款和条件适用*** **PL: Szansa na WYGRANĄ.** Obowiązuje regulamin* **CS: Máte šanci VYHRÁT.** Platí všeobecné smluvní podmínky* **SK: Máte šancu VYHRÁŤ.** Platia všeobecné zmluvné podmienky* **HU: TE IS NYERHETSZ!** Felhasználási feltételek érvényesek* **UA: ВИ МОЖЕТЕ ВИГРАТИ.** Застосовуються загальні положення та умови* **RO: Ai putea CÂȘTIGA.** Se aplică termeni și condiții* **BG: Можете да СПЕЧЕЛИТЕ.** Има определени правила и условия* **LV: Tu vari LAIMĒT.** Ir spēkā noteikumi un nosacījumi.* **ET: Sul on võimalus VÕITA.** Kehtivad tingimused* **LT: Jūs galite LAIMĖTI.** Taikomos sąlygos* **TR: KAZANABİLİRSİN.** Şartlar ve Koşullar geçerlidir*

*[LEGO.com/productfeedback-terms](https://www.lego.com/productfeedback-terms)