

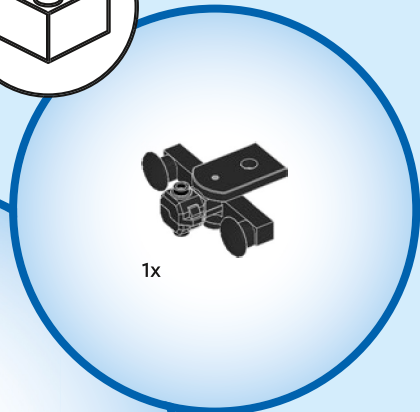

CITY

60511

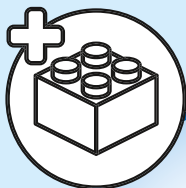



1x



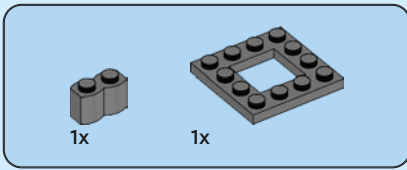

1

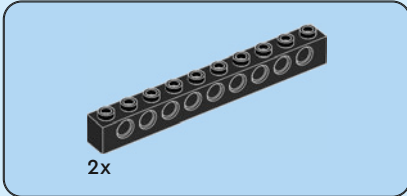
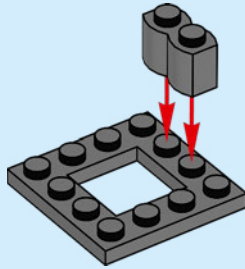

2

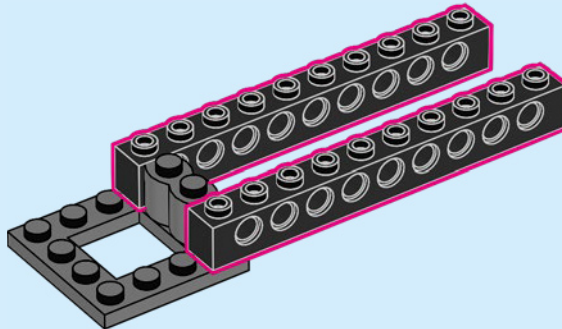

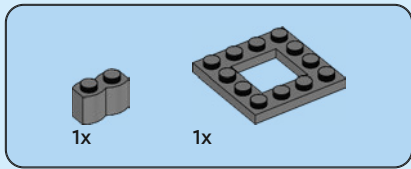

3

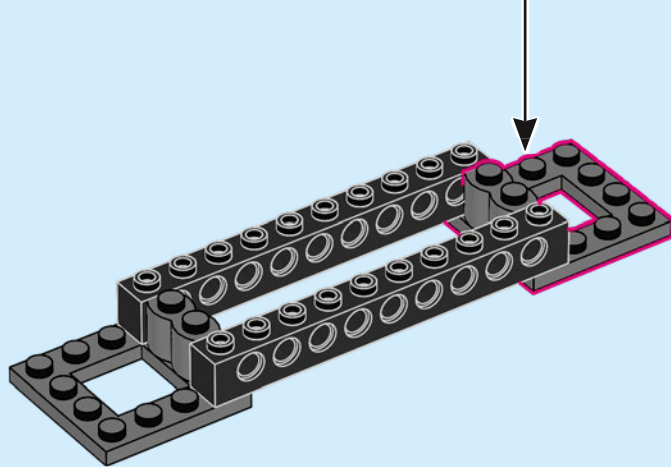
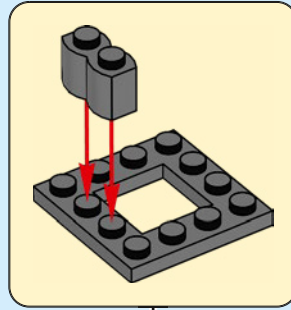

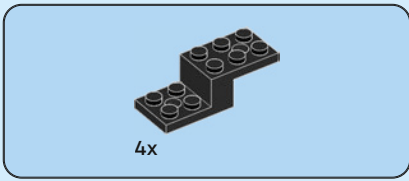

4

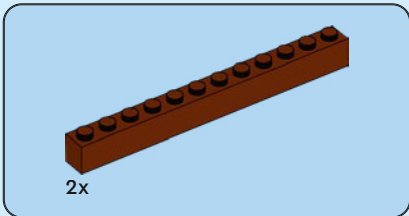
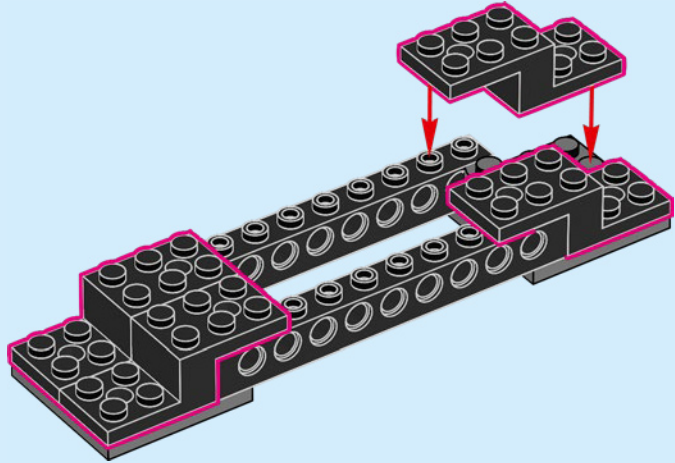

5

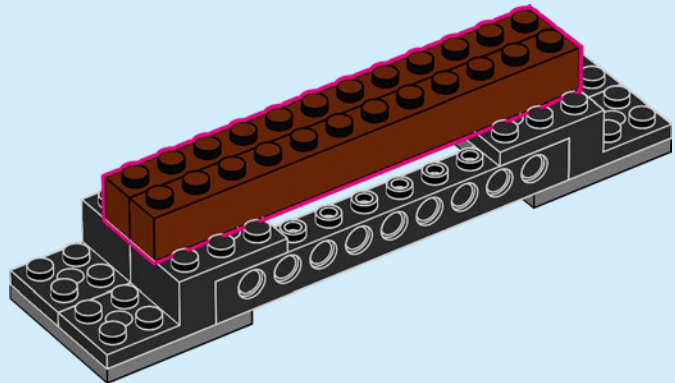

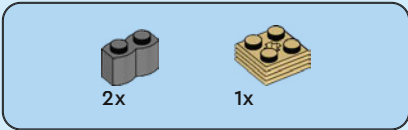

6

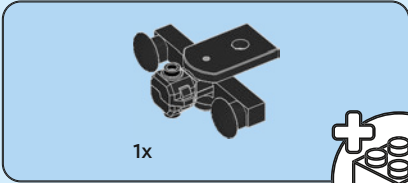
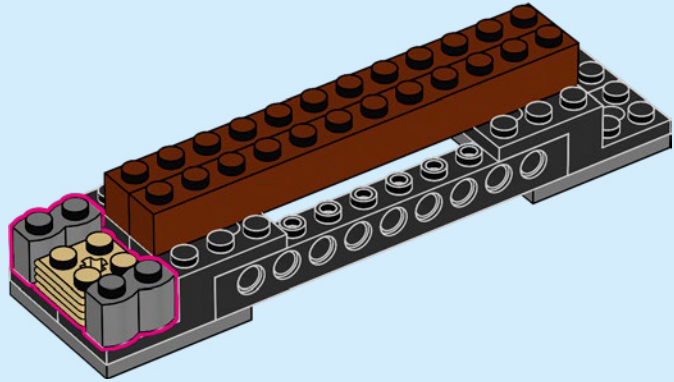

7

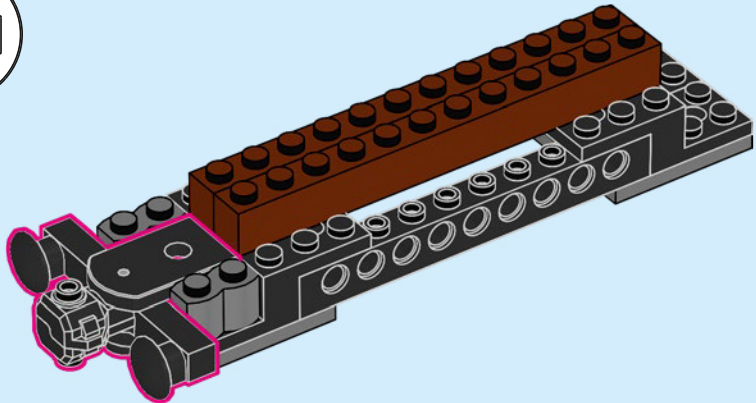
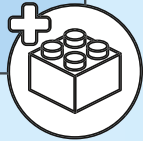



2x

8

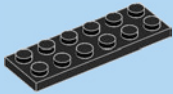
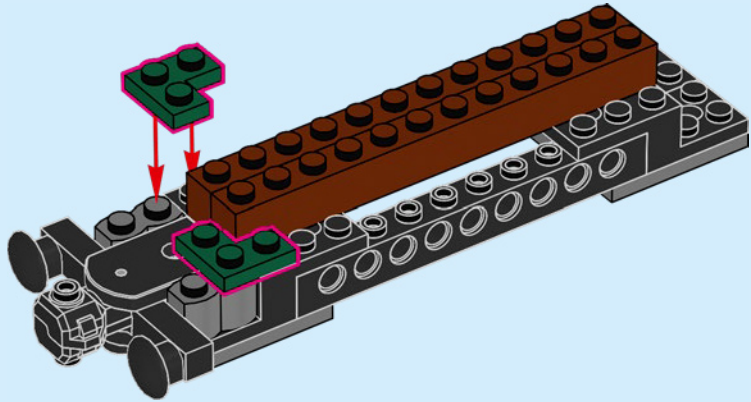

1x

9

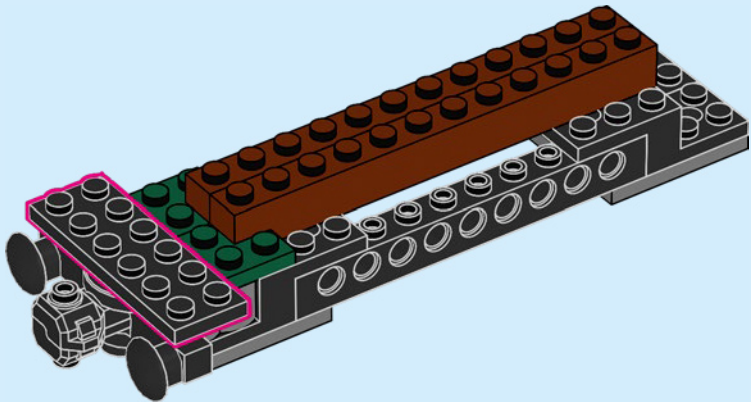

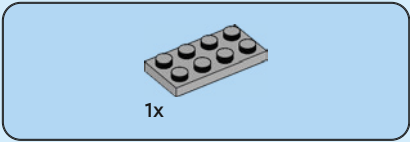

10

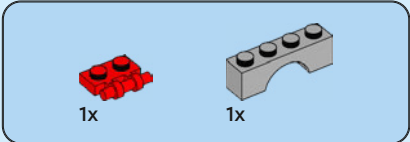
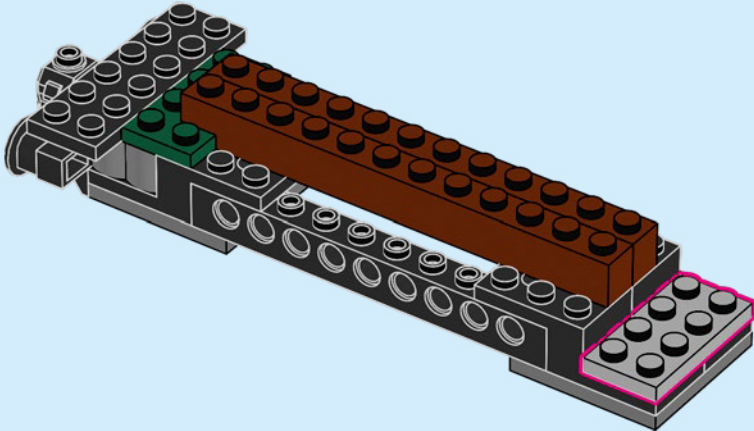

11

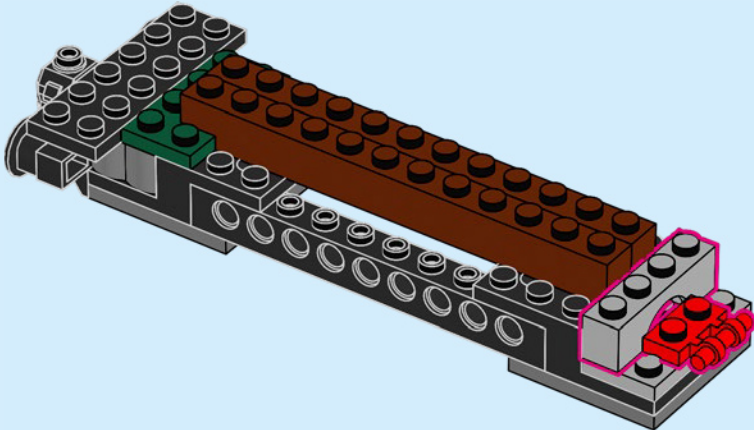



2x

12

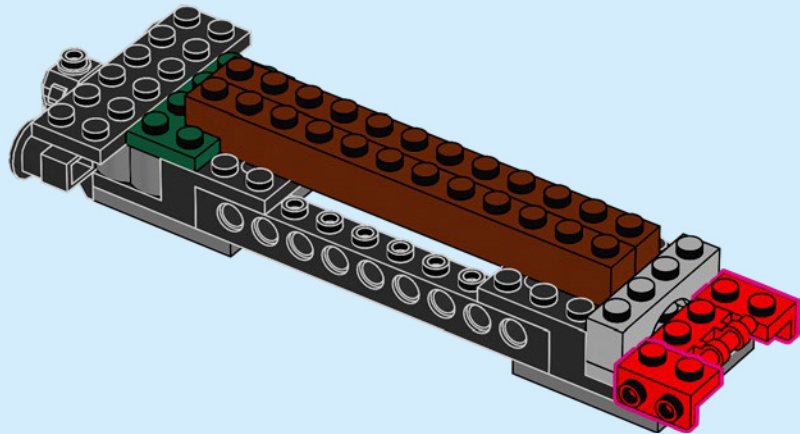

2x

13

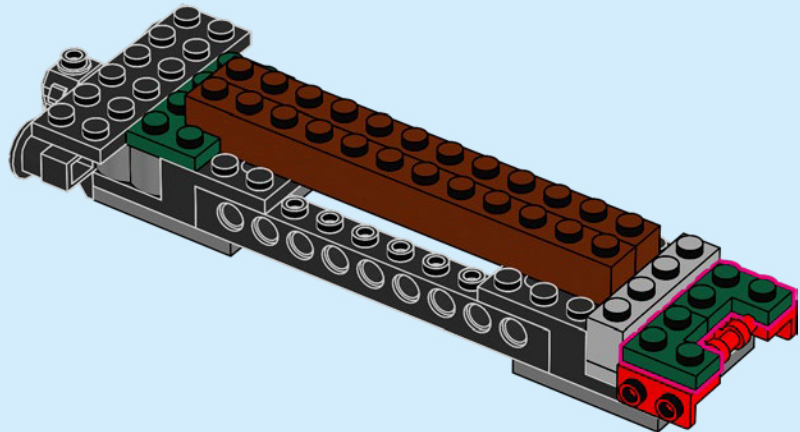

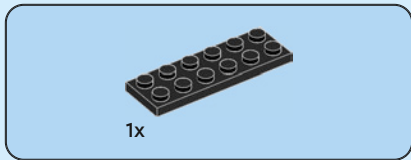

14

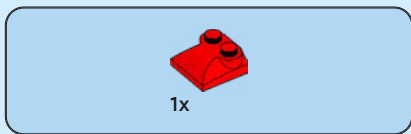
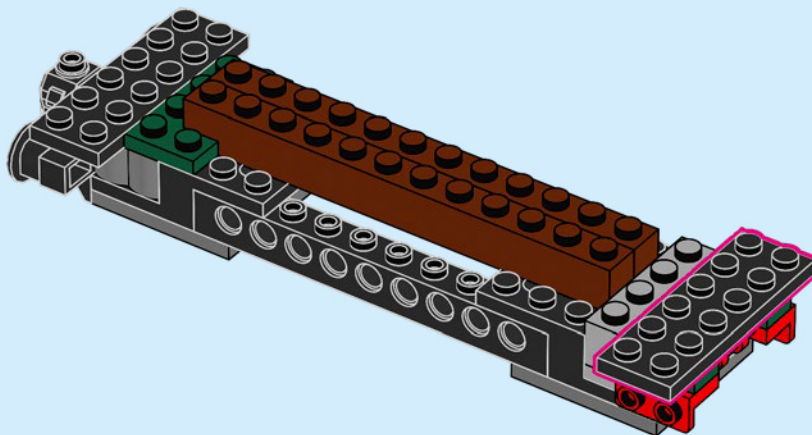

15

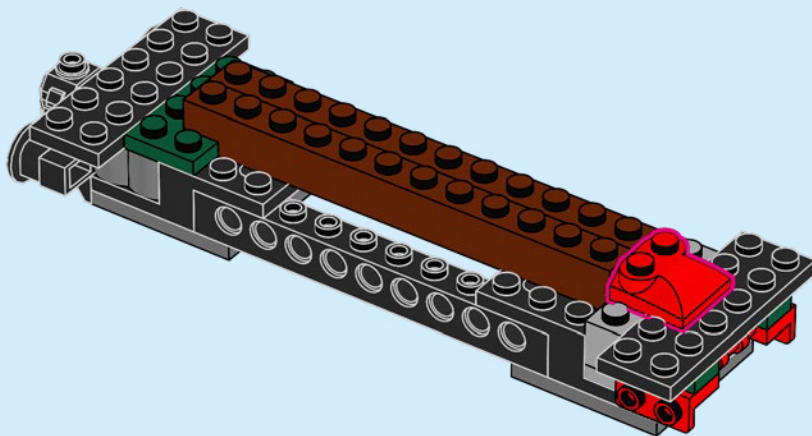



1x

16

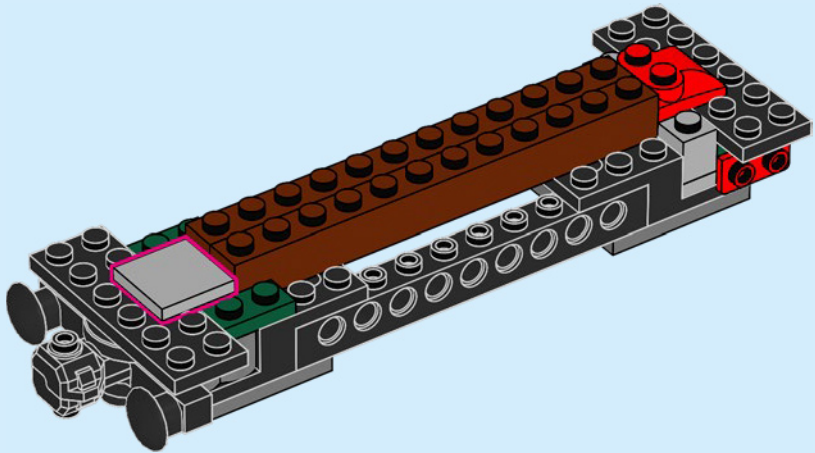

2x

17

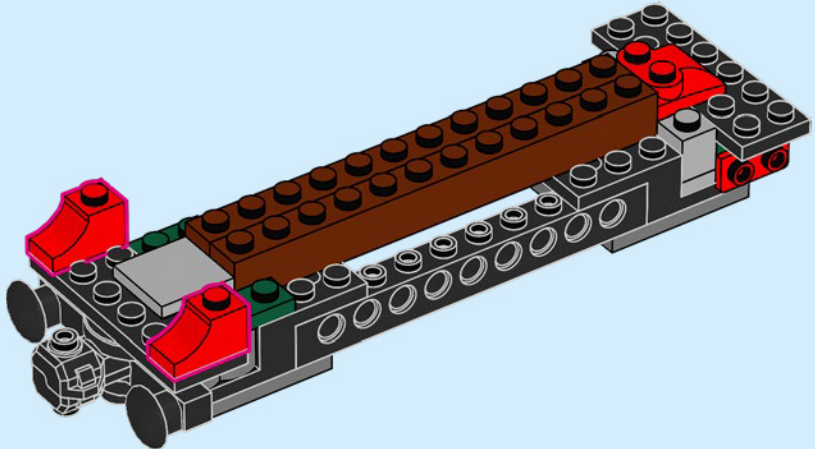

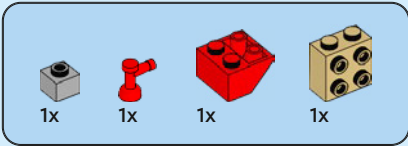

18

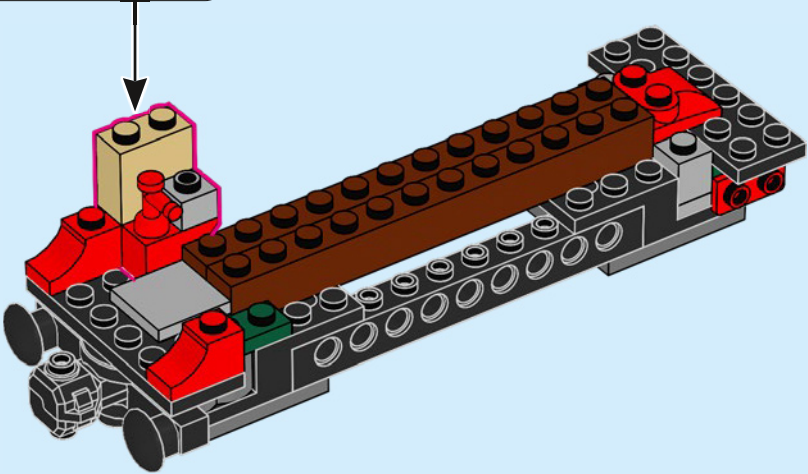
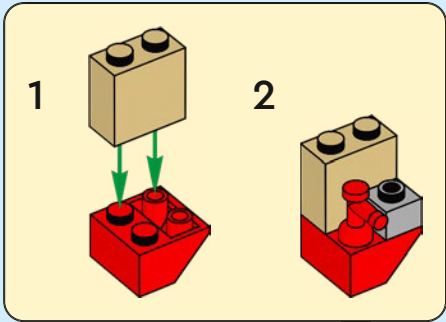



2x



2x

19

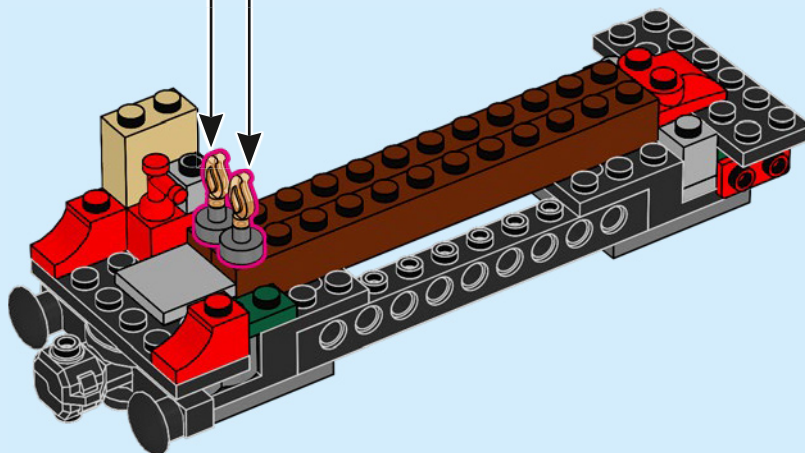
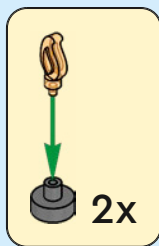

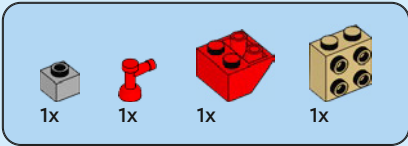

20

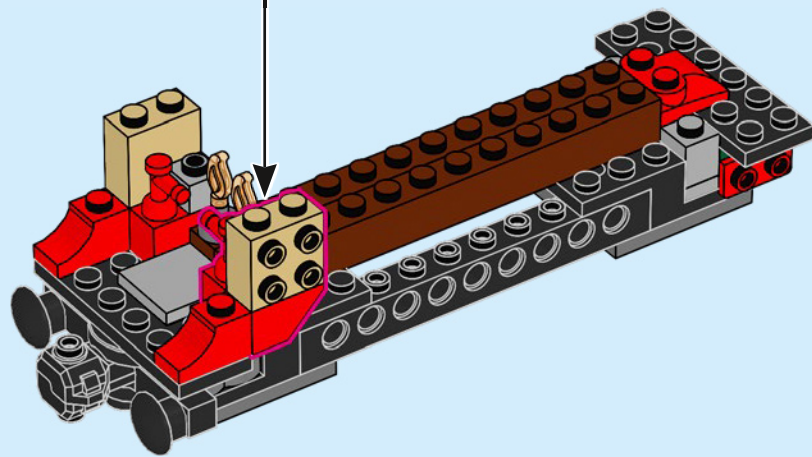
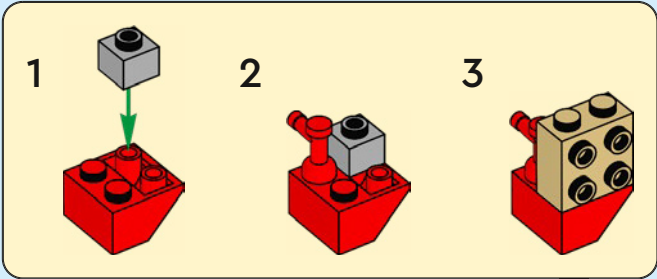

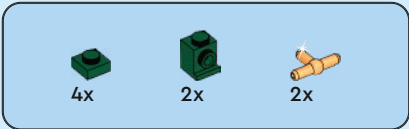

21

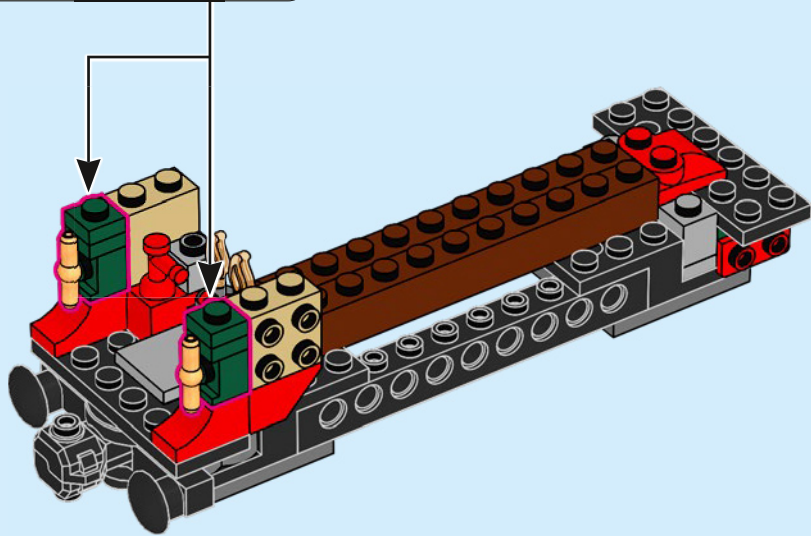
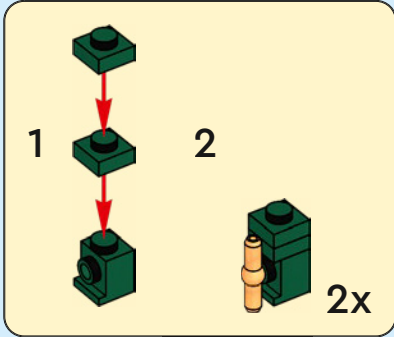

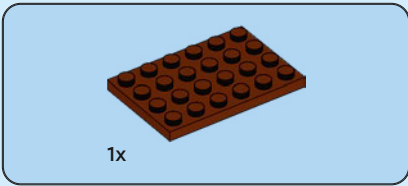

22

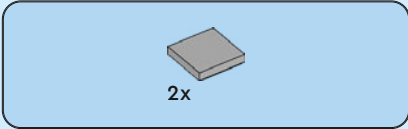
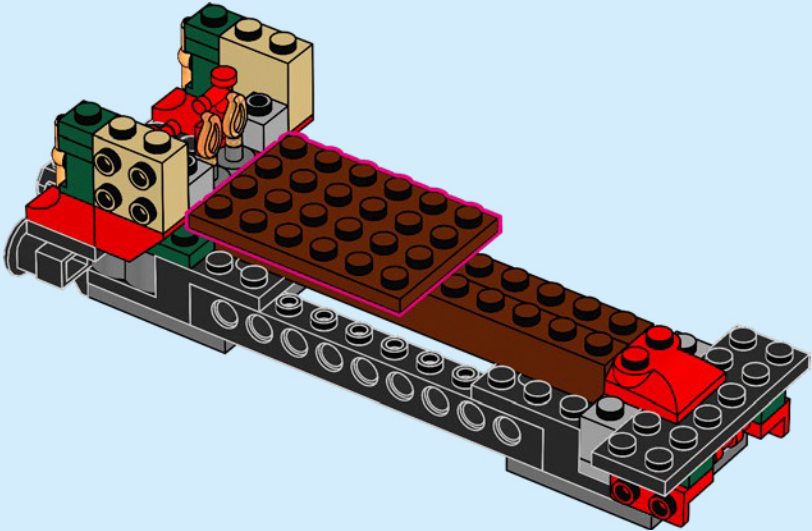

23

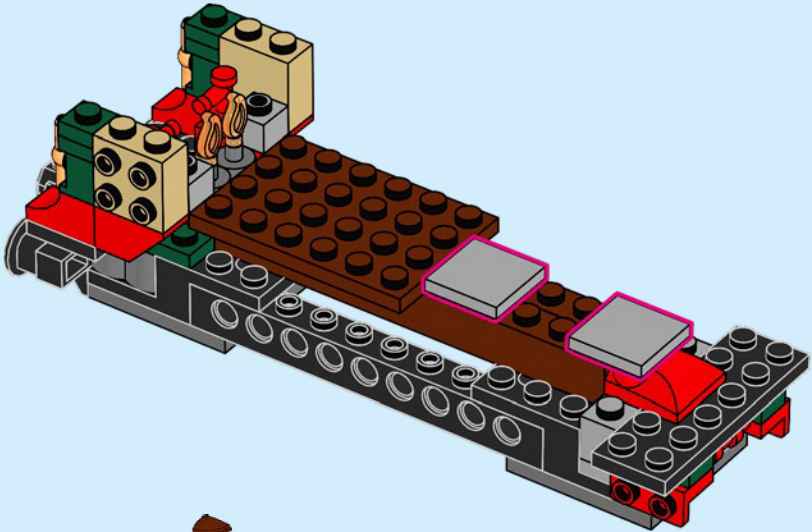

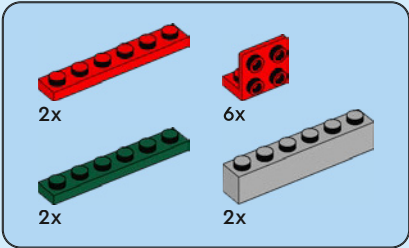
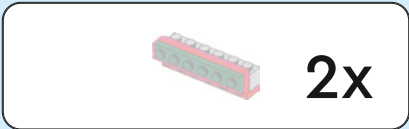

24

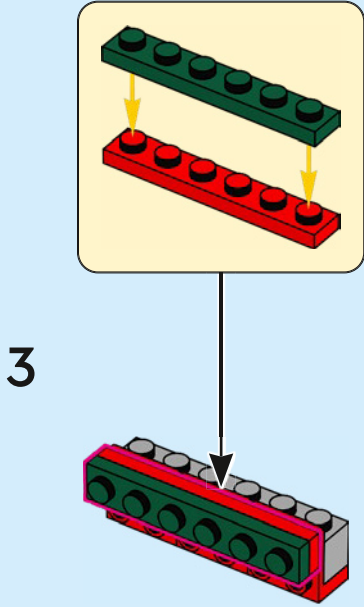
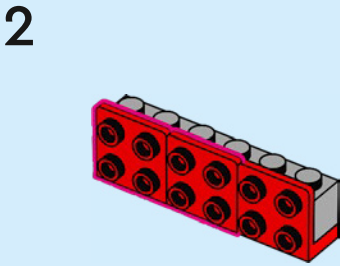
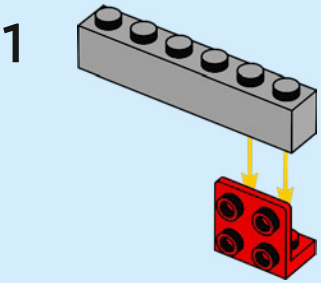

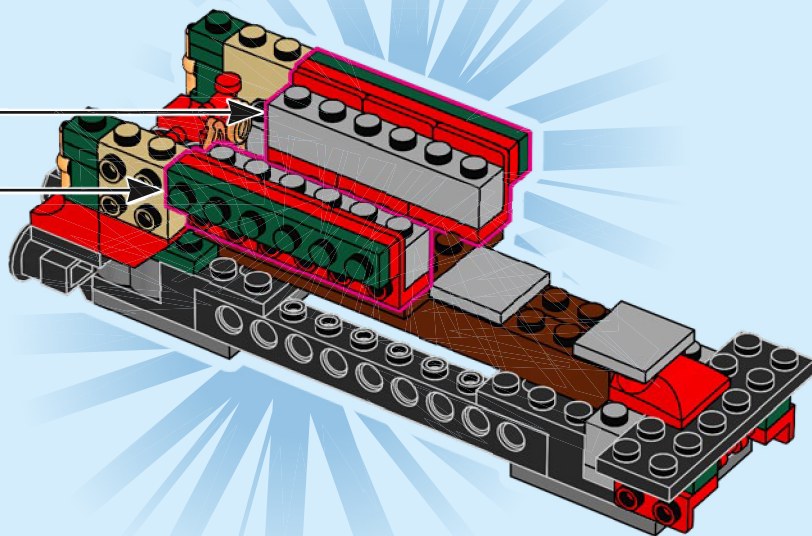

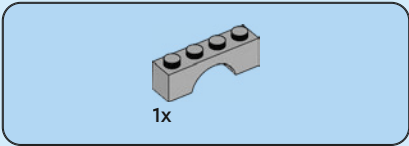

25

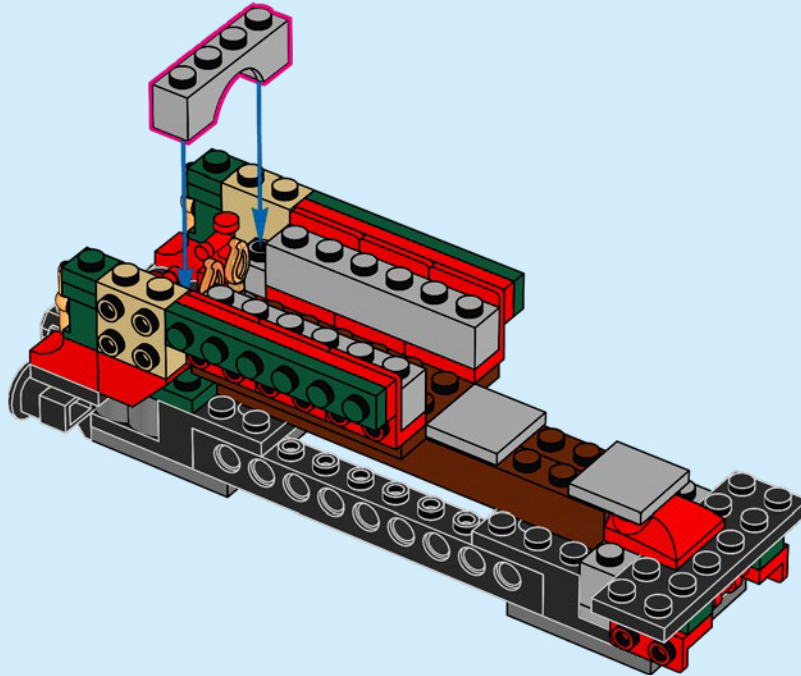



2x

26

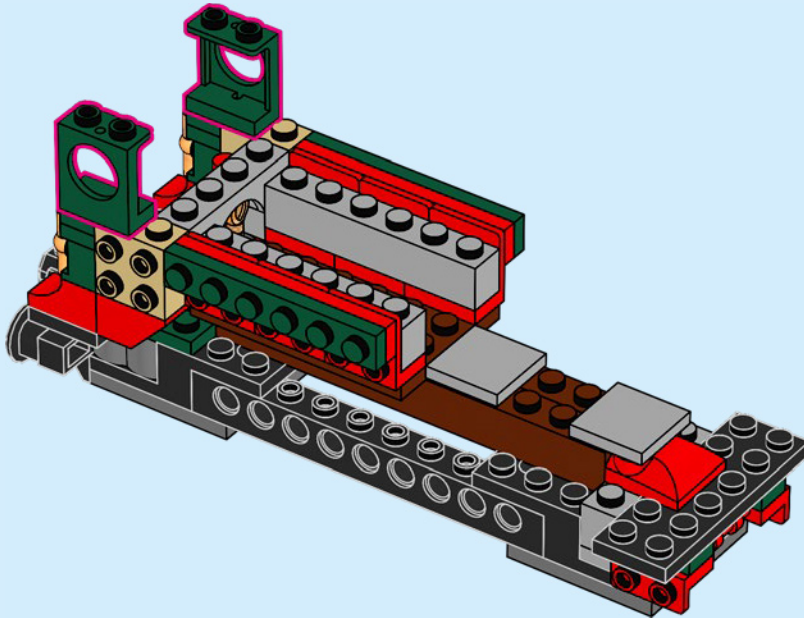

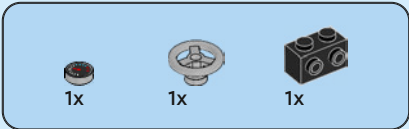

27

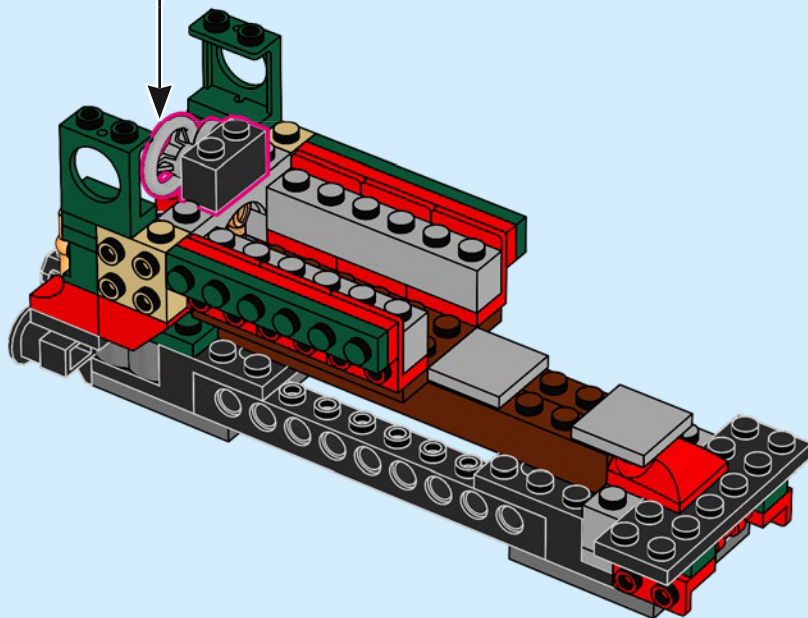
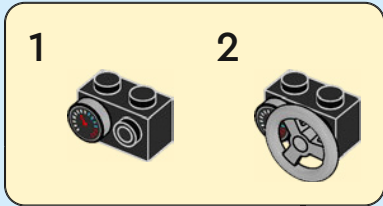

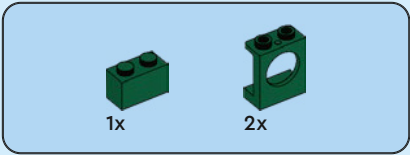

28

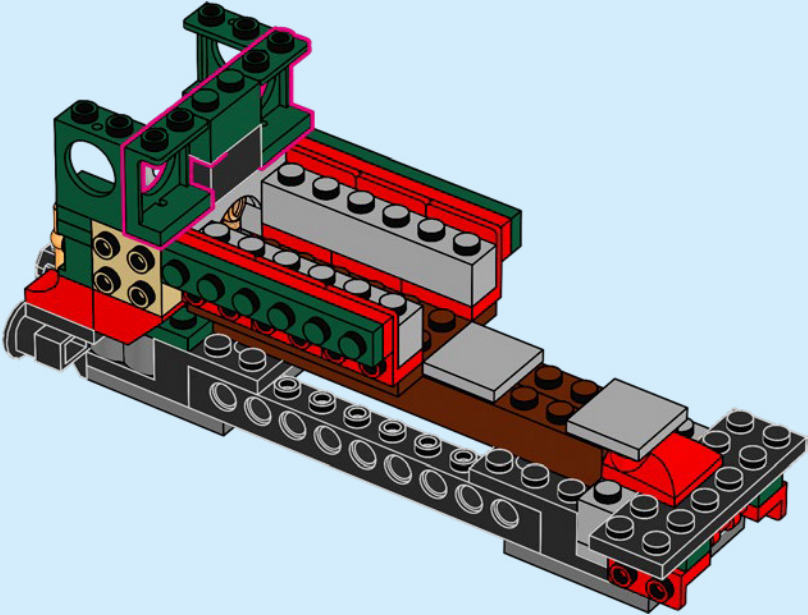

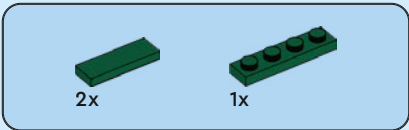

29

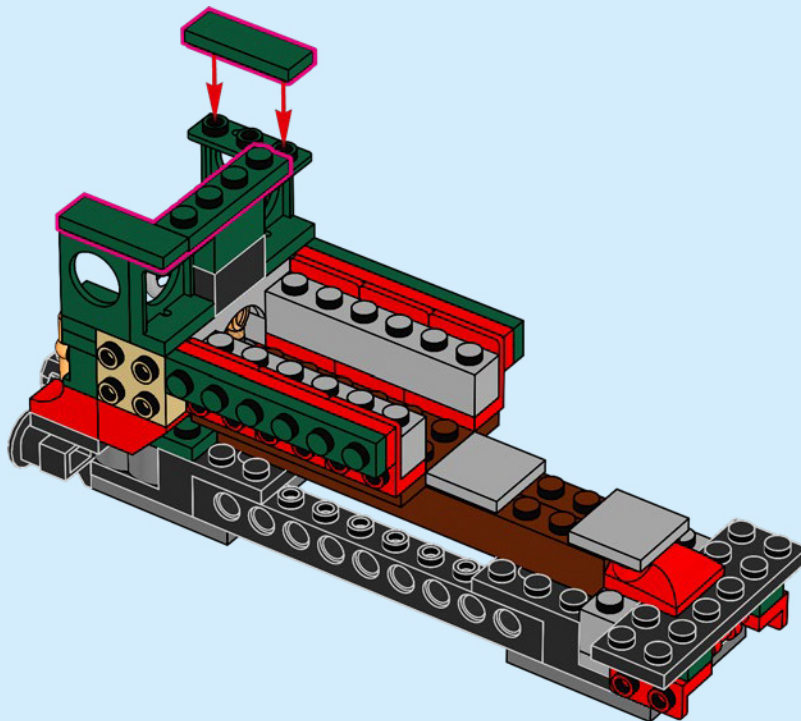

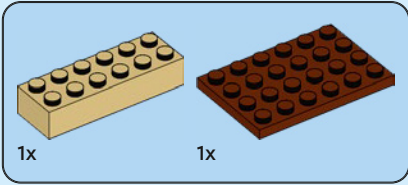

30

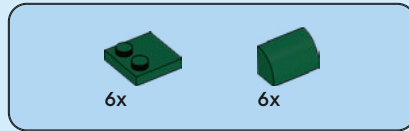
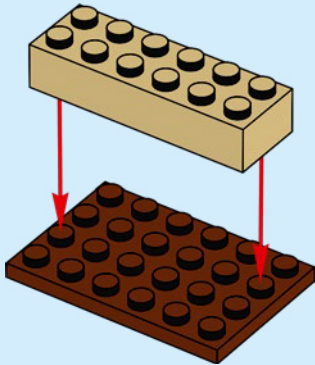

31

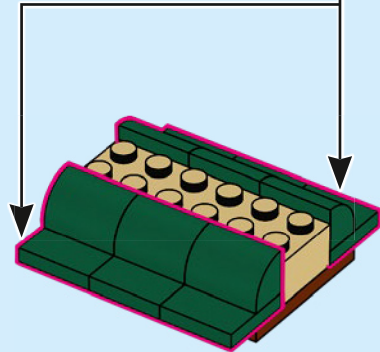
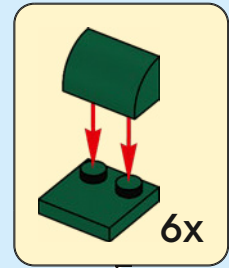



2x



1x

32

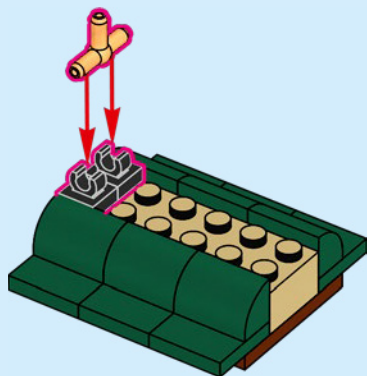

2x

33

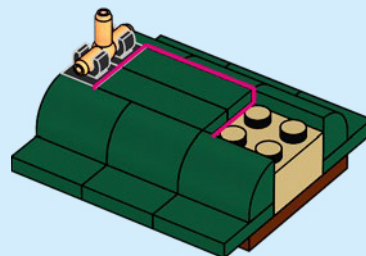

1x

34

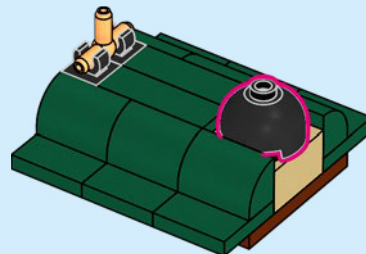

35

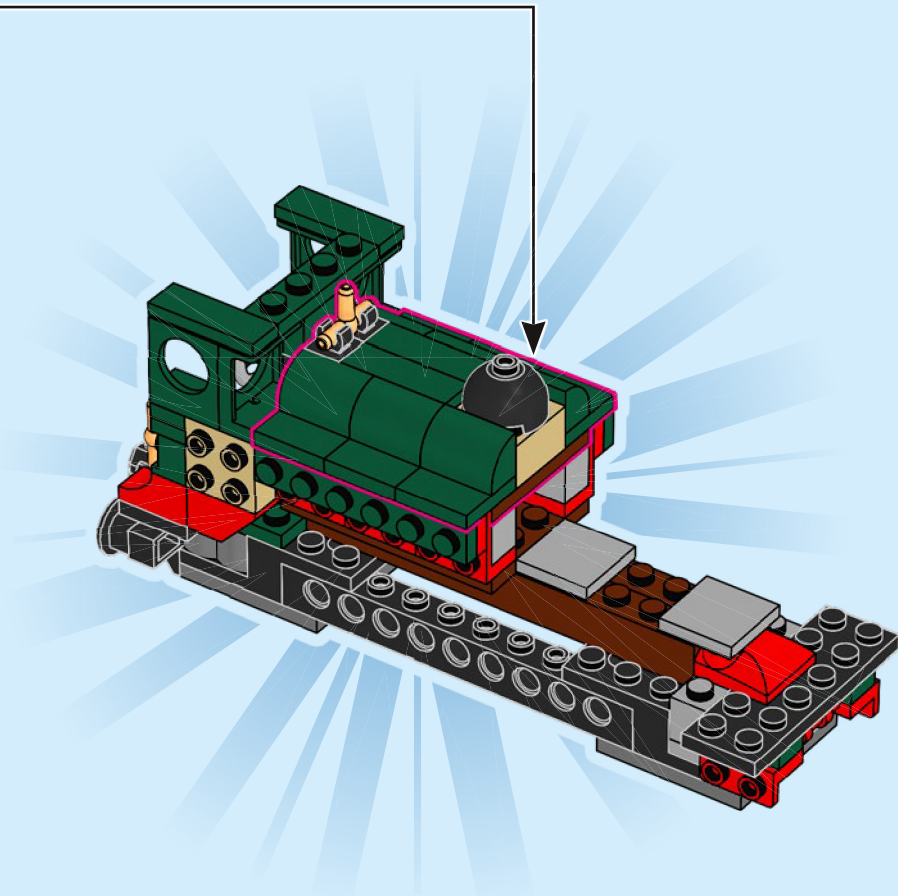

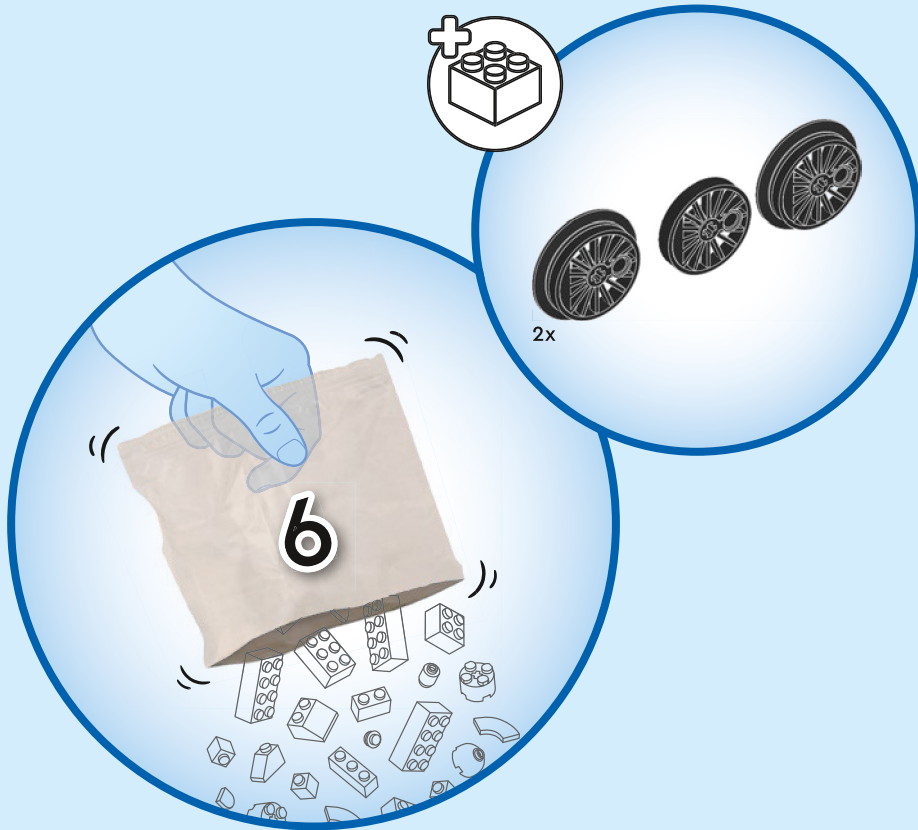



2x

36

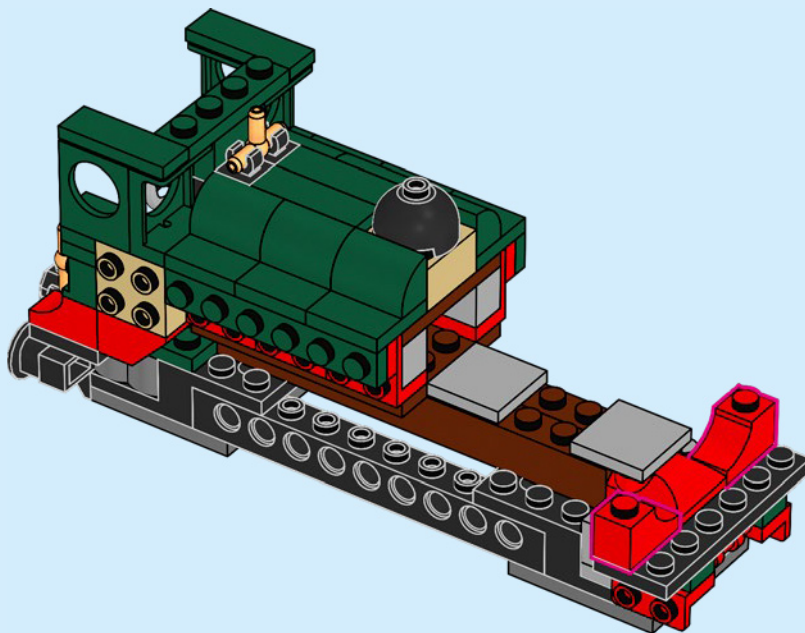

2x

37

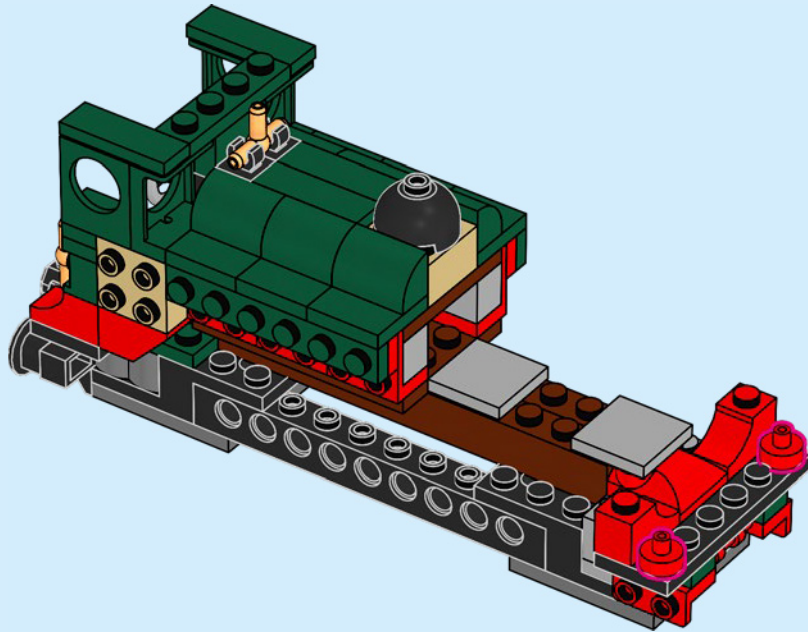

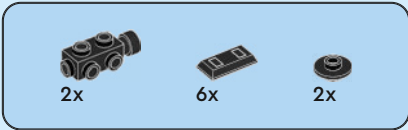

38

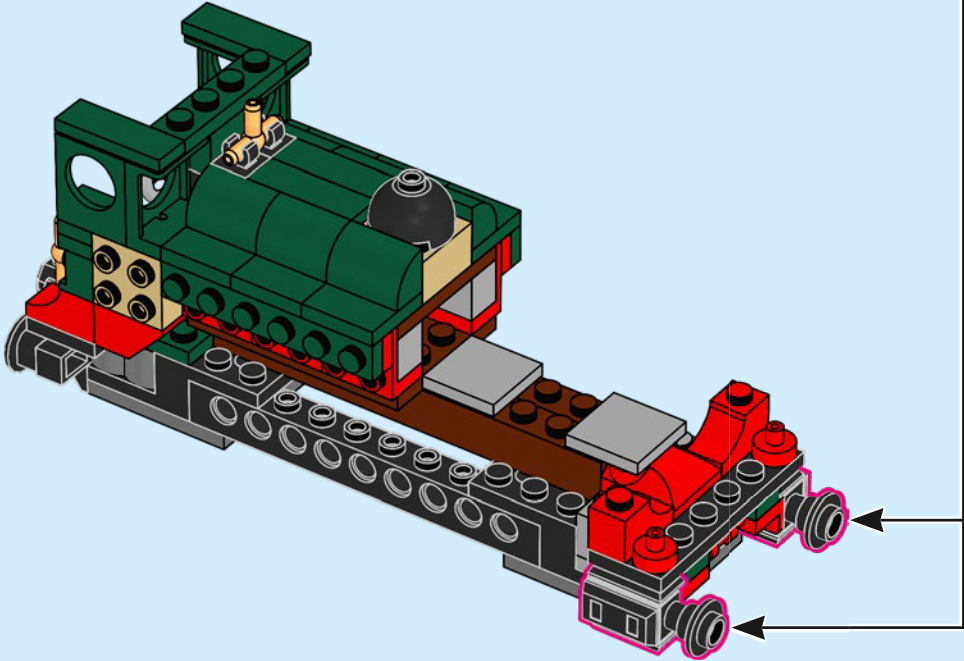
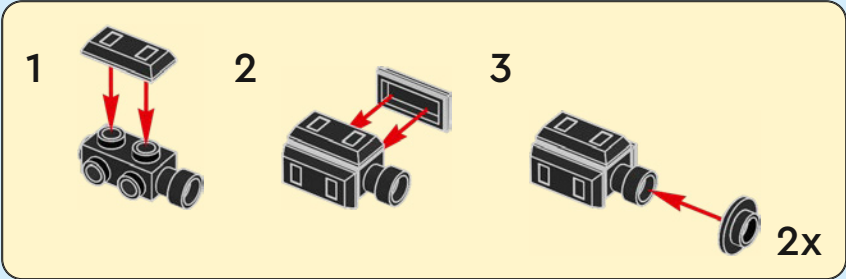



2x

39

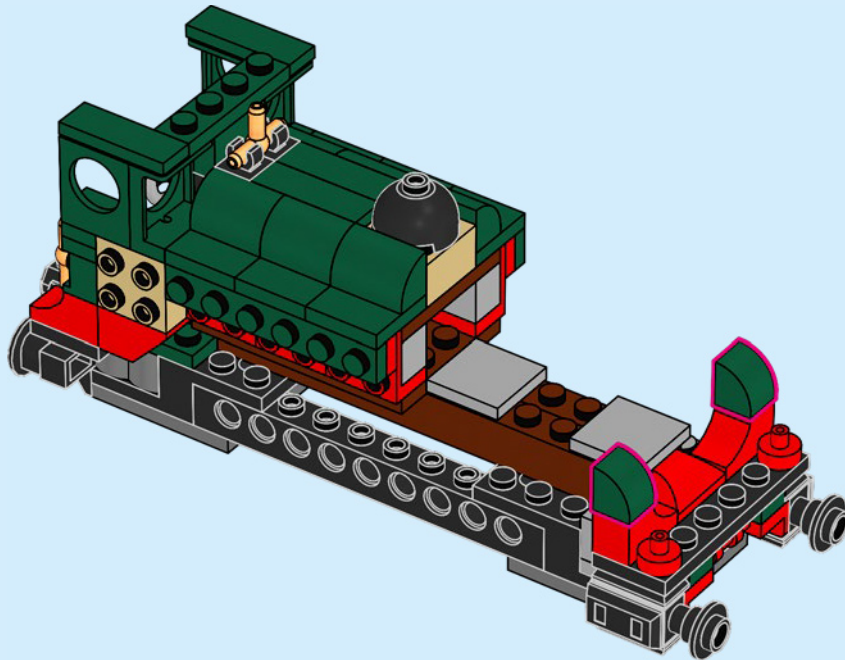



2x



2x

40

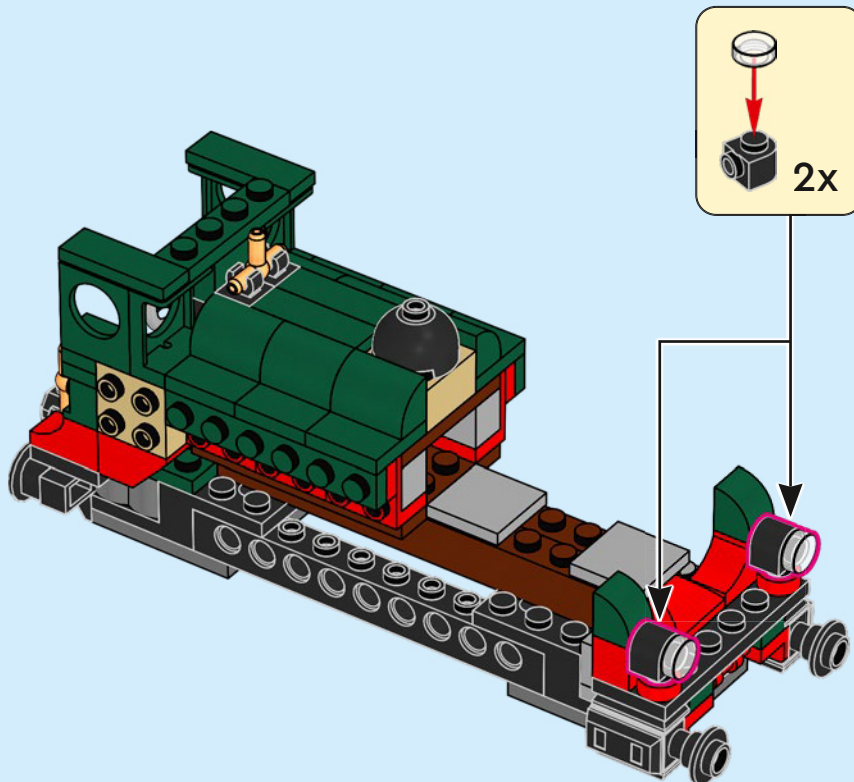

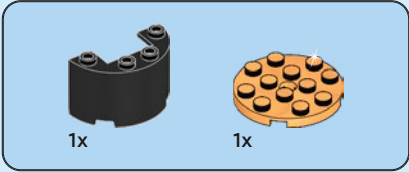
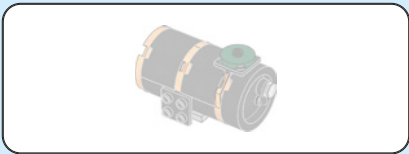

41

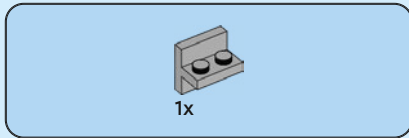
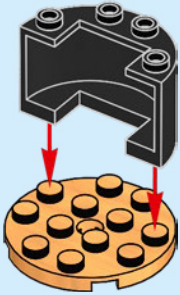

42

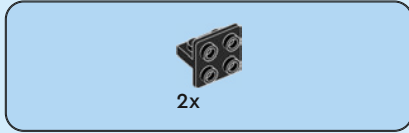
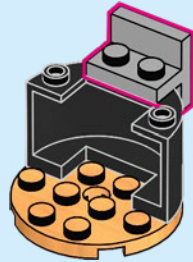

43

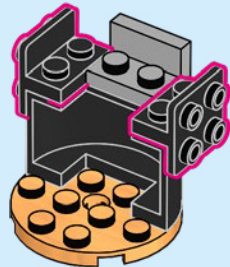

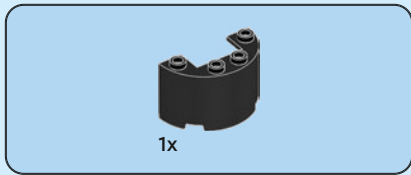

44

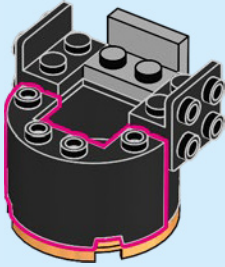

45

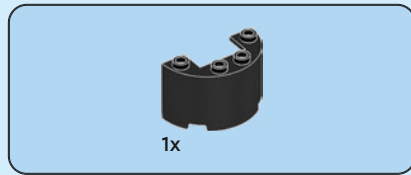
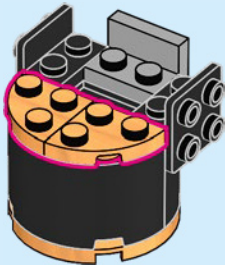

46

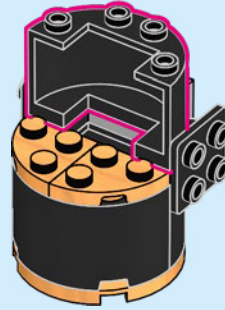

47

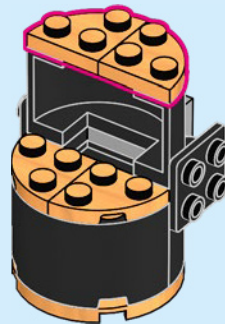

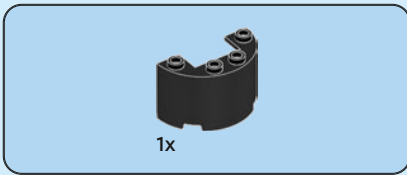

48

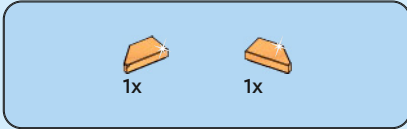
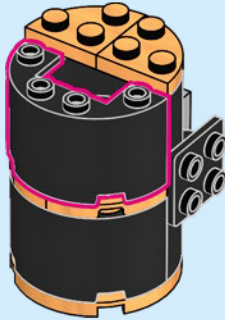

49

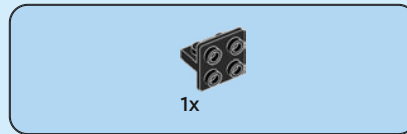
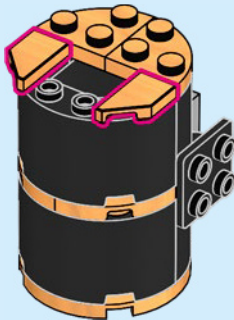

50

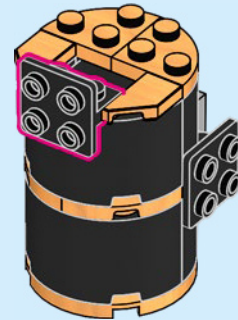



51

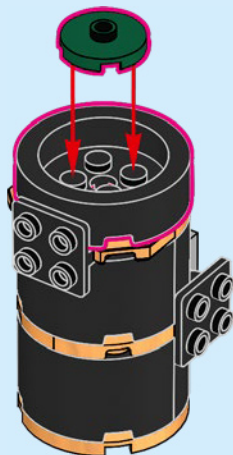

52

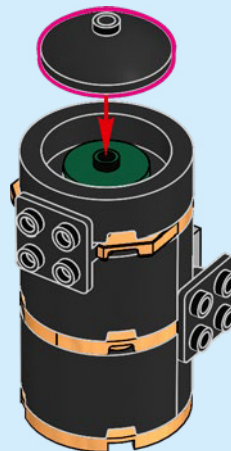



1x

53

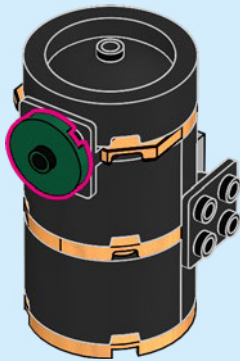

1x



1x

54

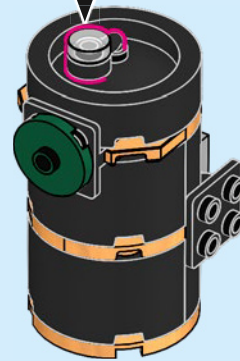
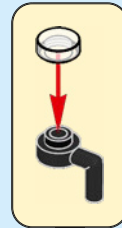

55

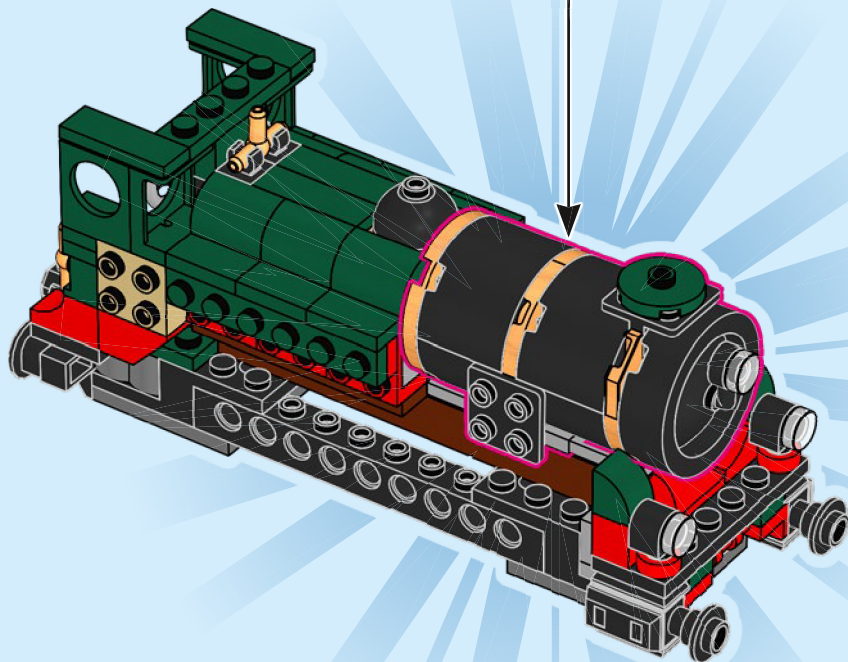

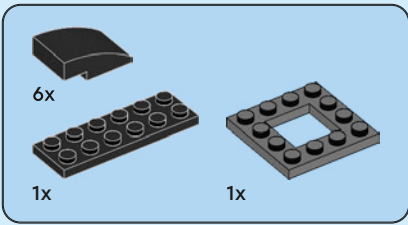

56

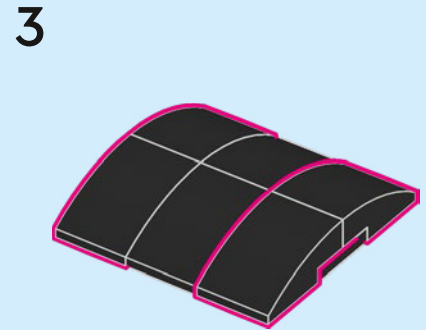
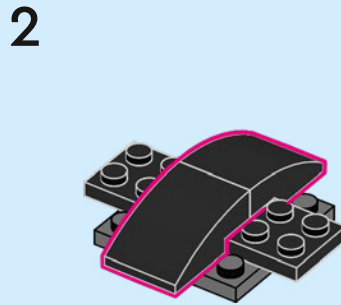
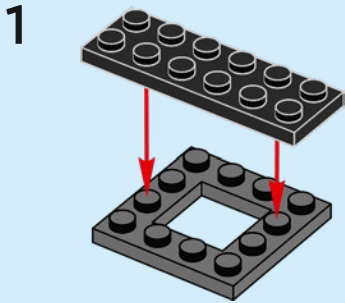

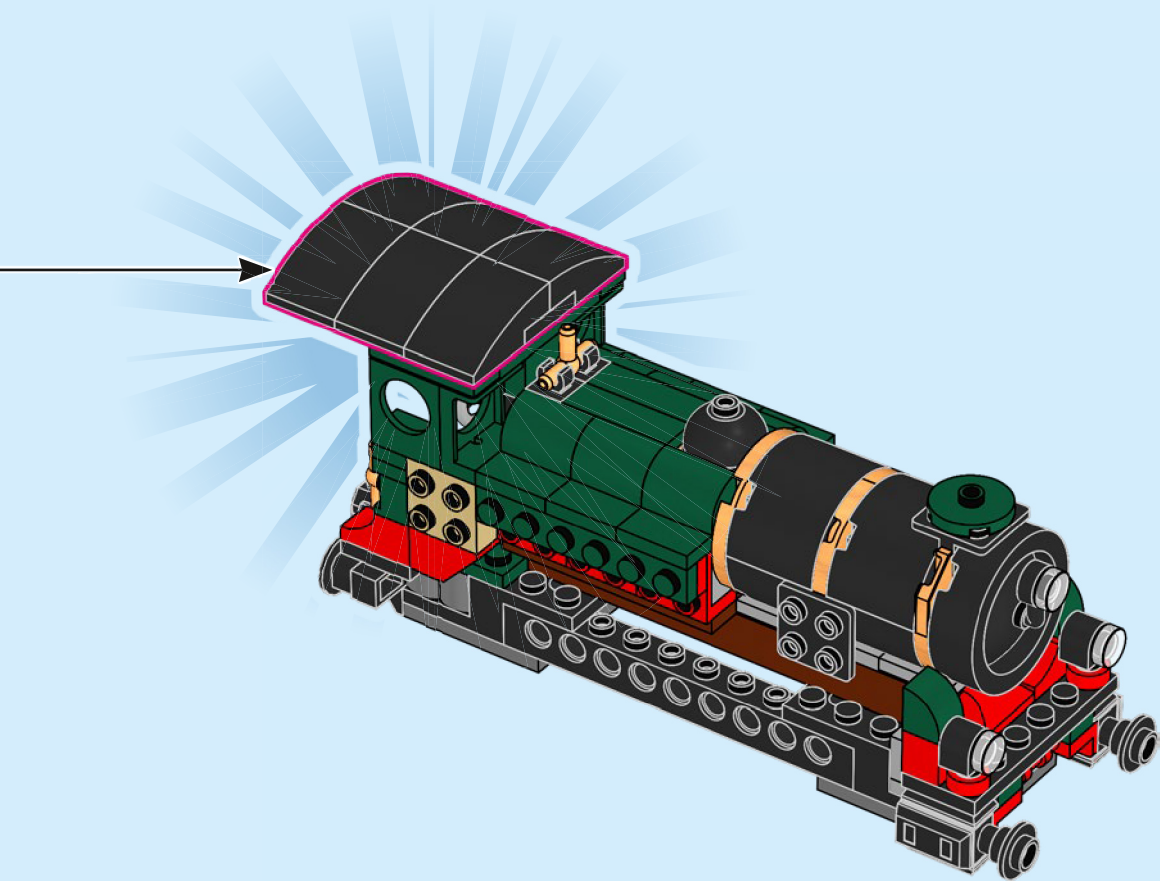

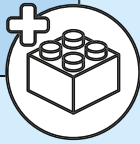
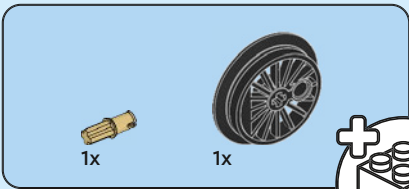

57

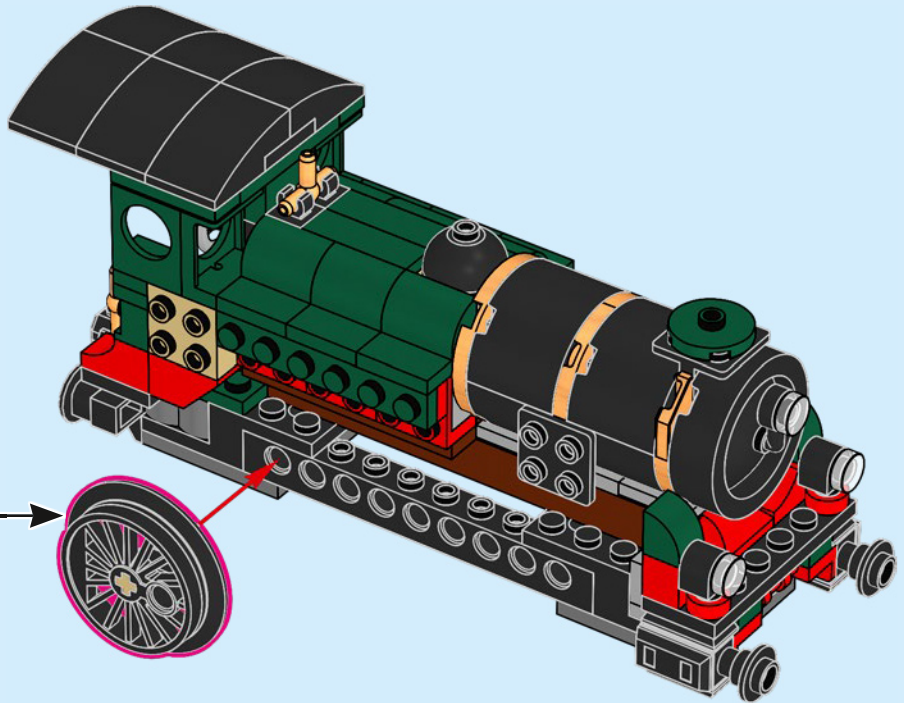
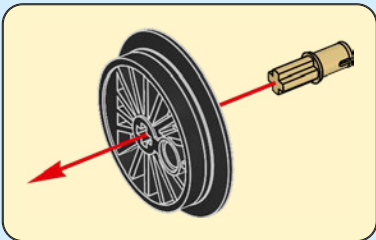

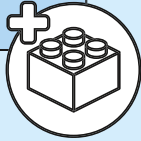
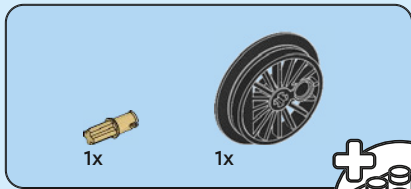

58

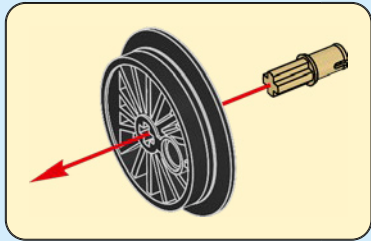
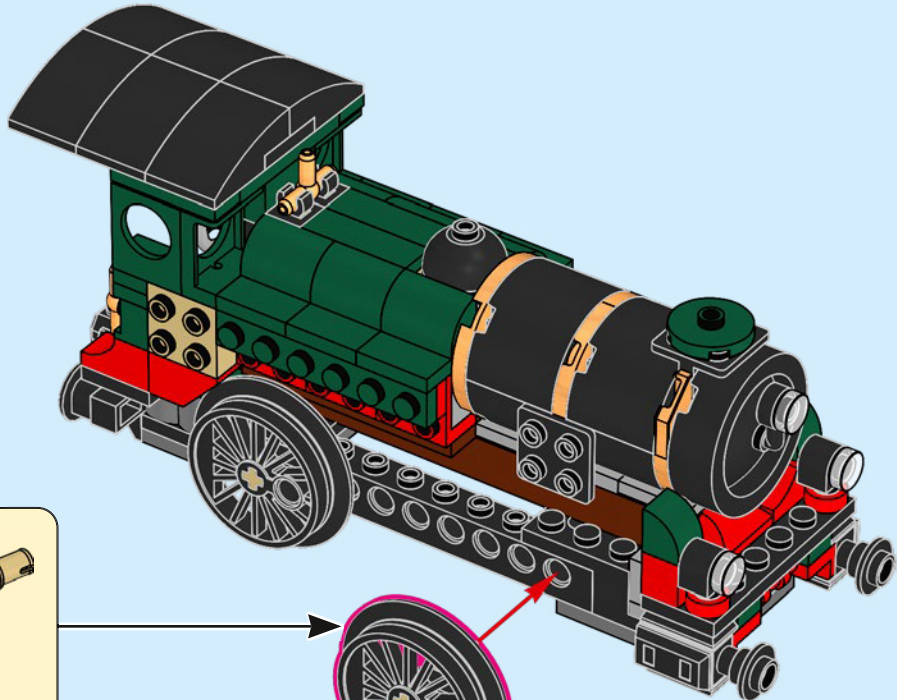

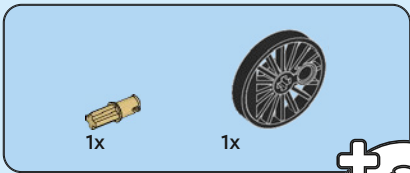

59

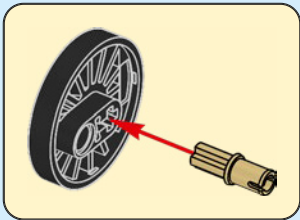
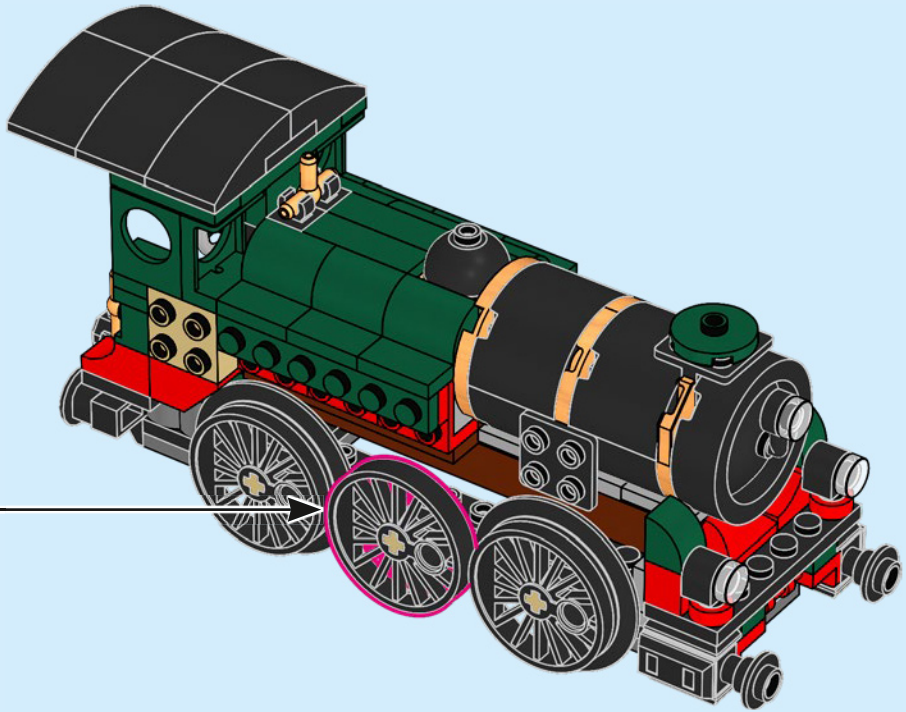
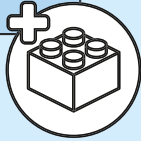

3x

60

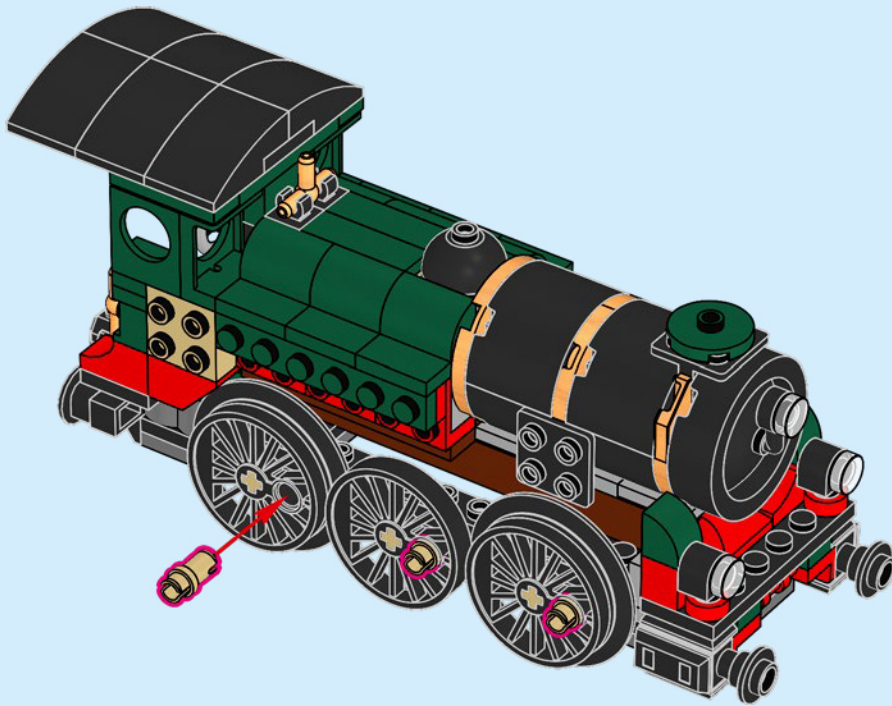

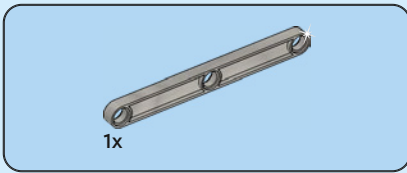

61

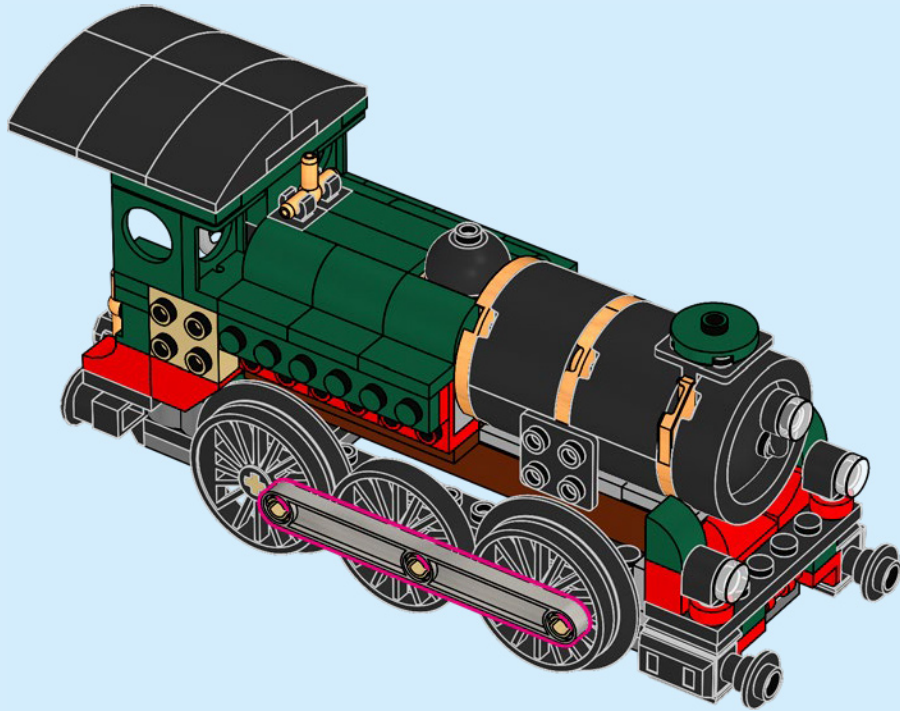

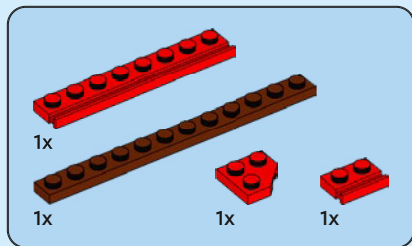

62

1

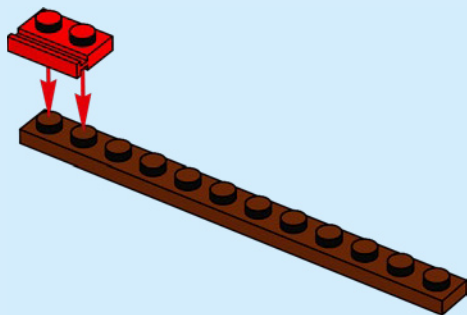

2

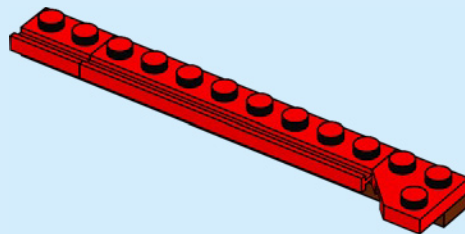

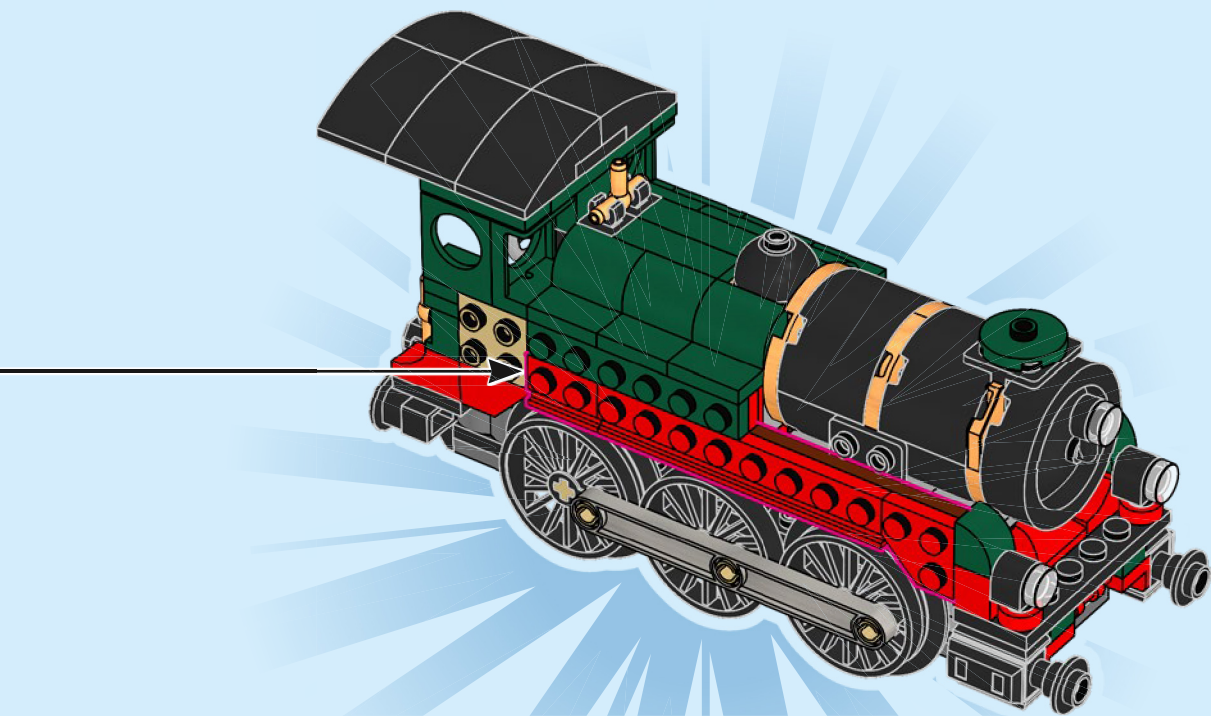

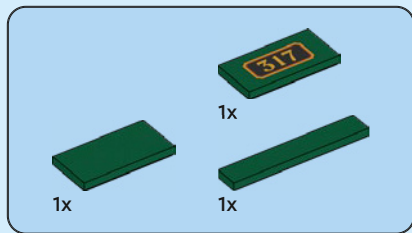

63

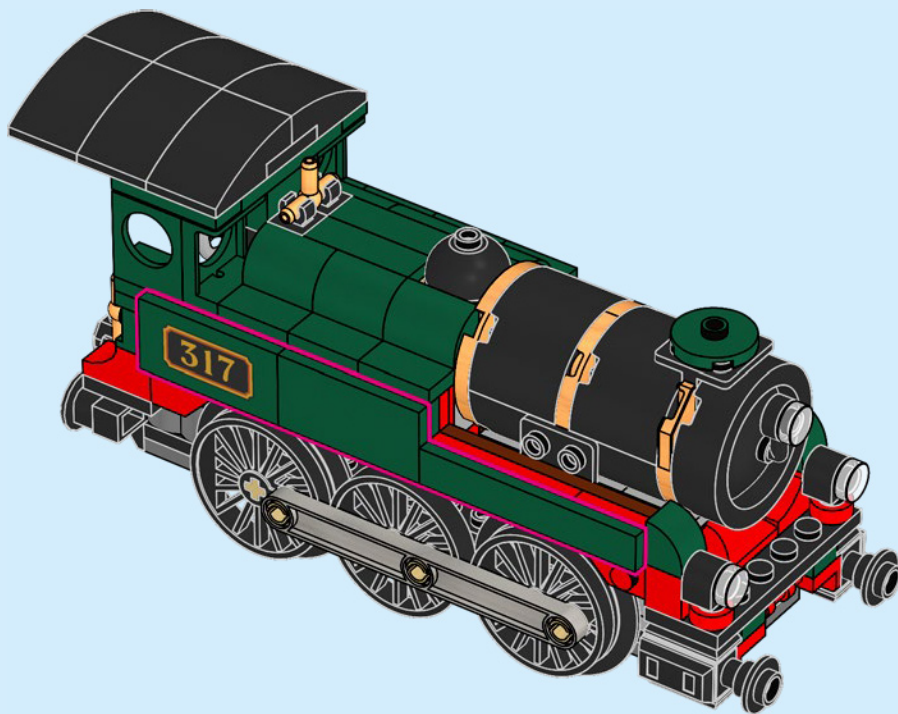



64

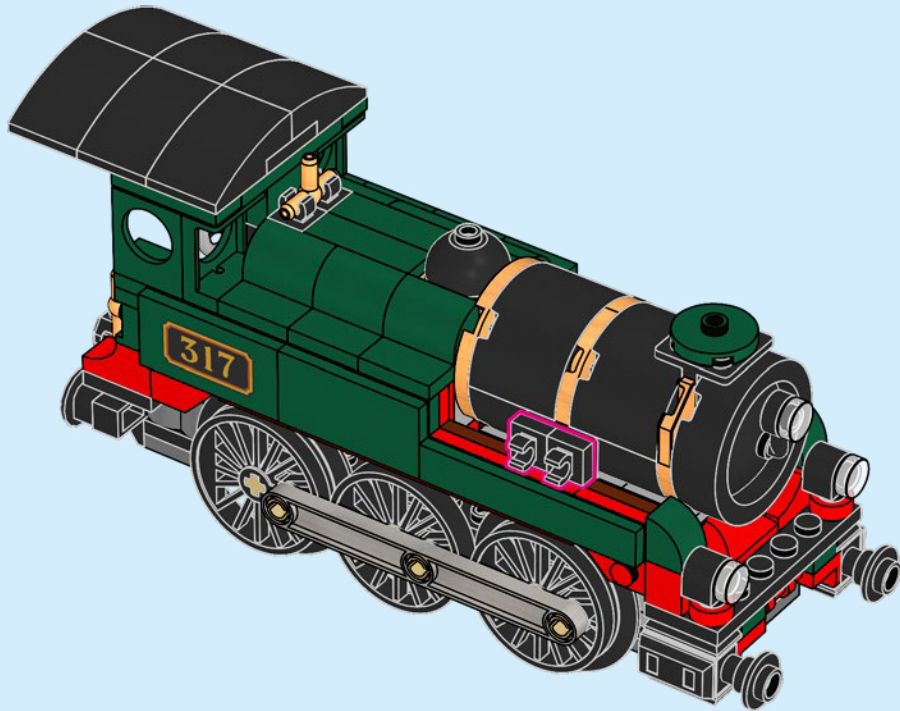

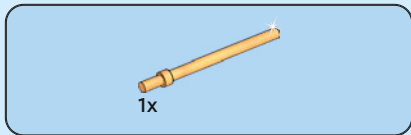

65

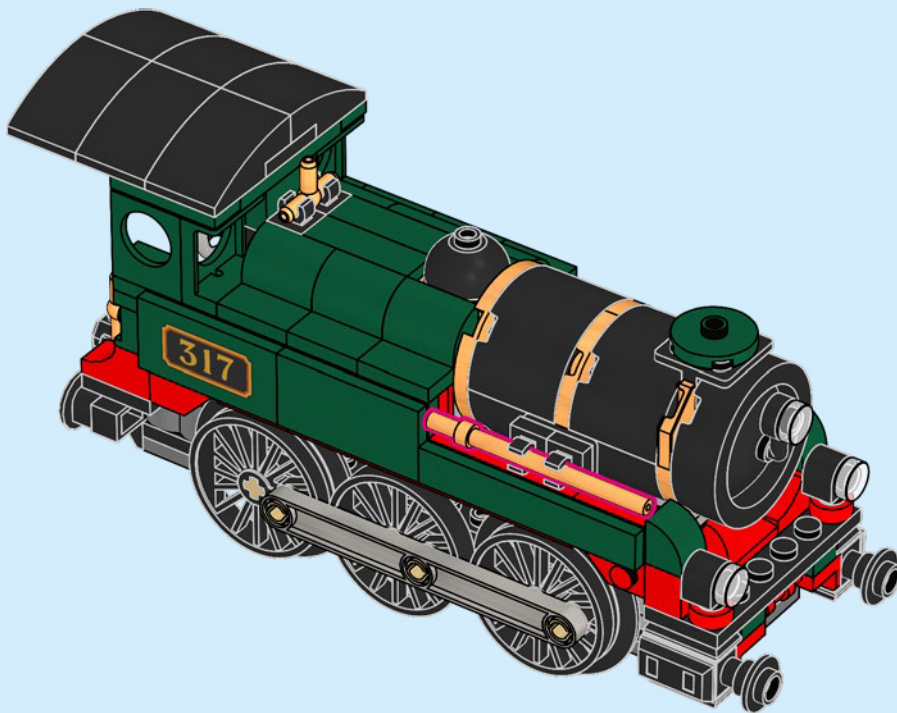

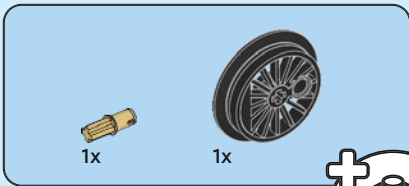

66

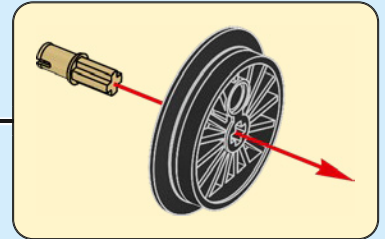
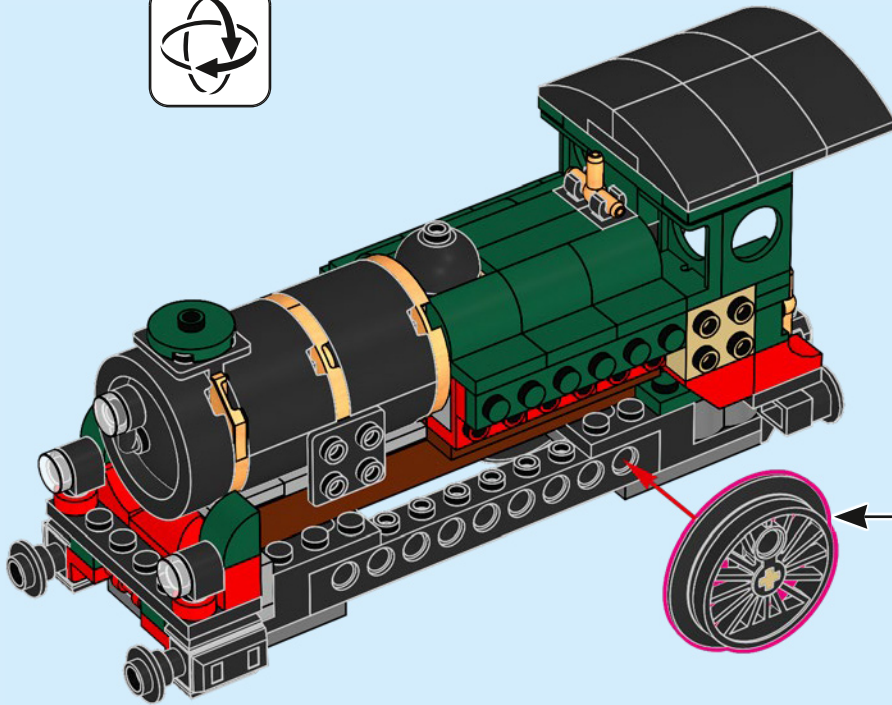
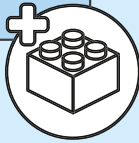

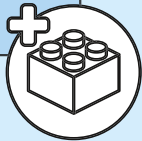
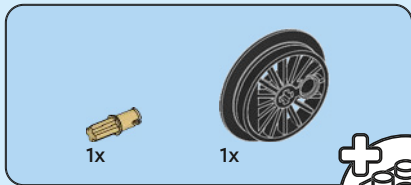

67

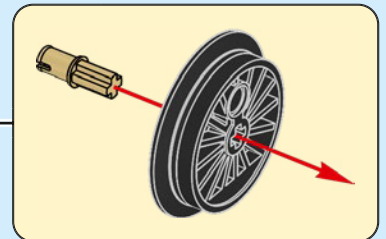
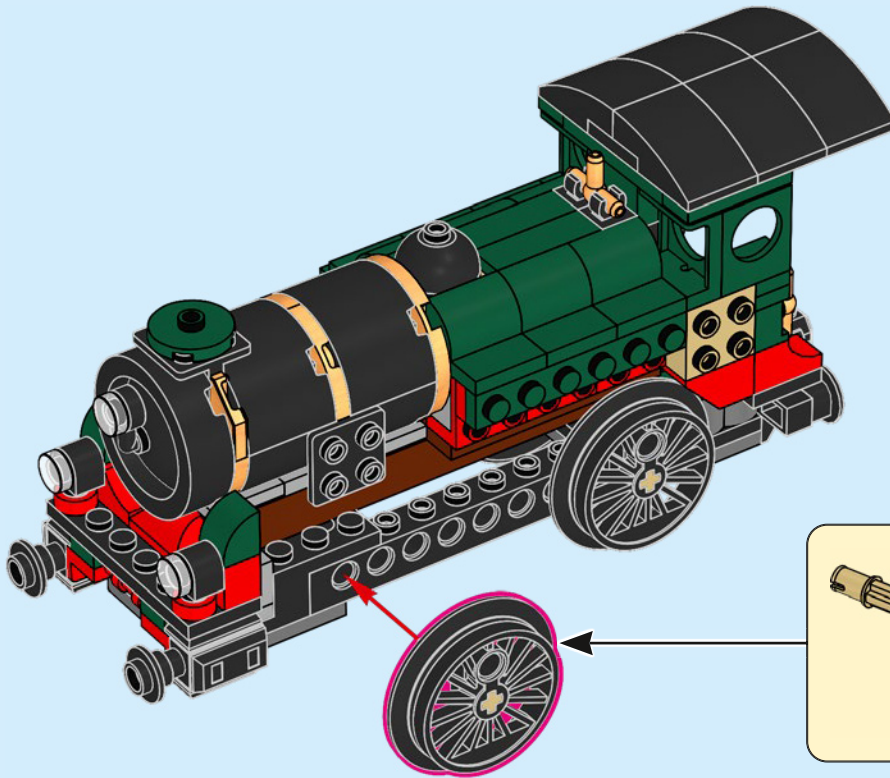

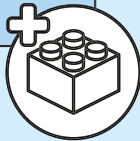
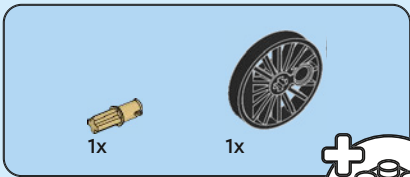

68

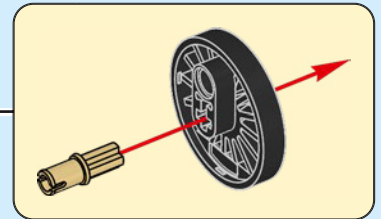
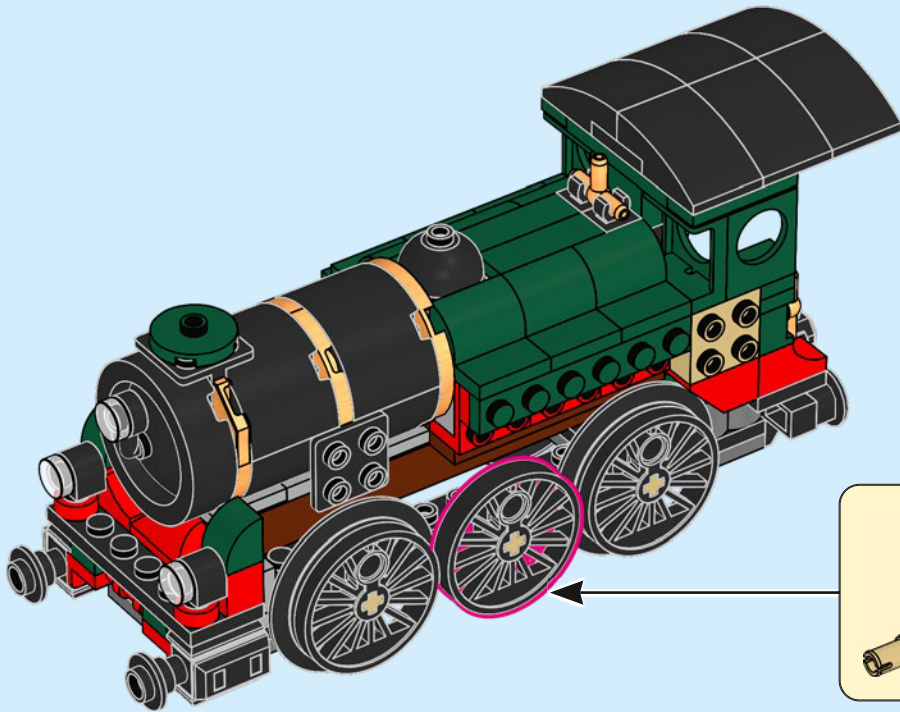



3x

69

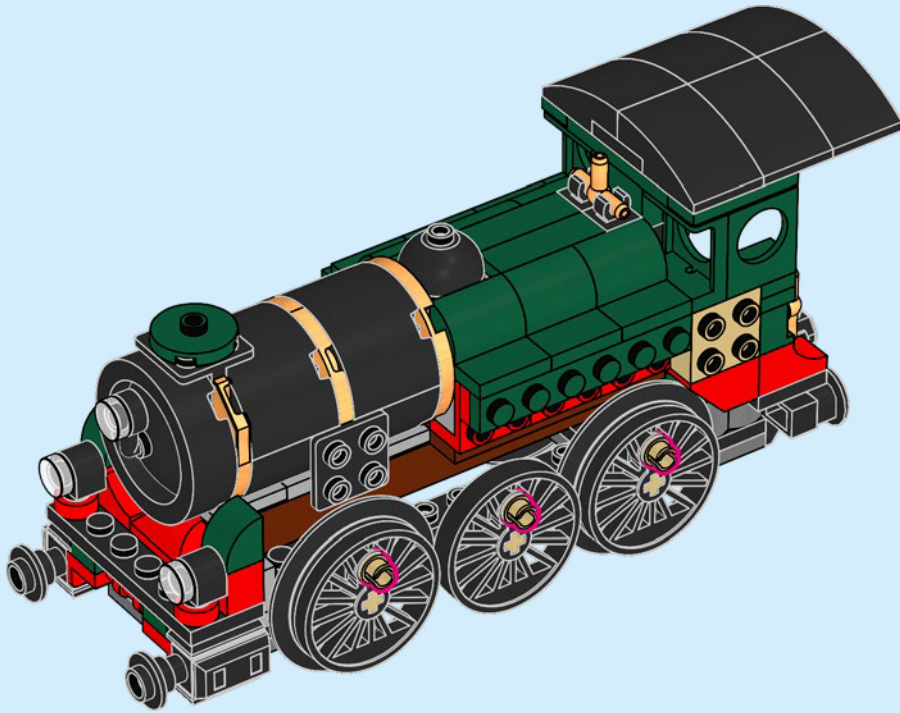

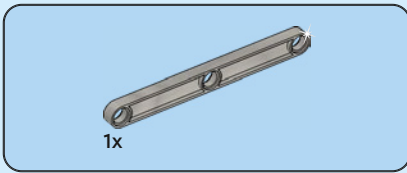

70

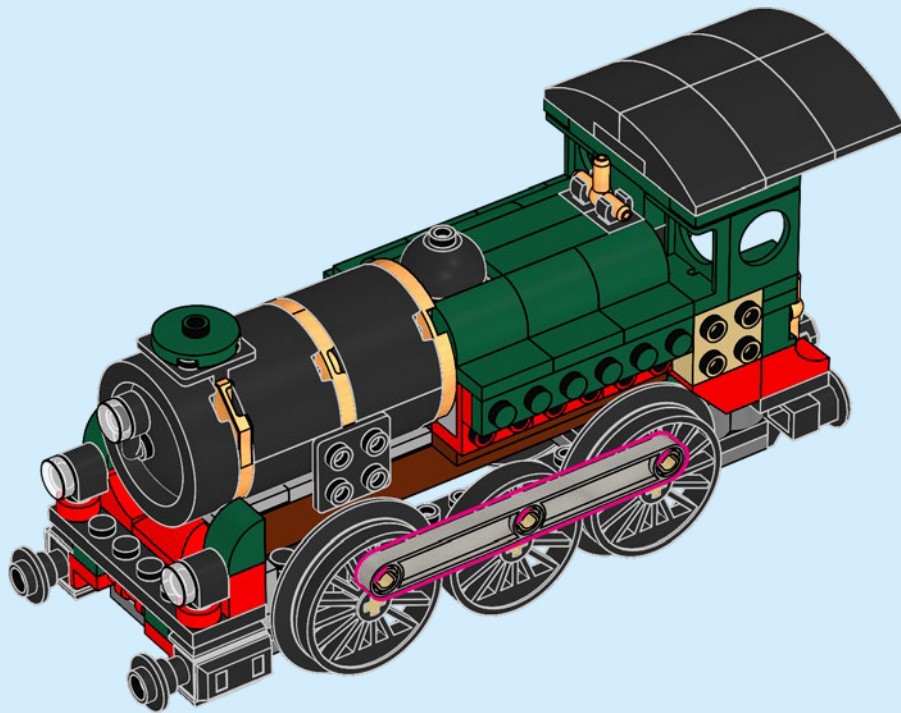

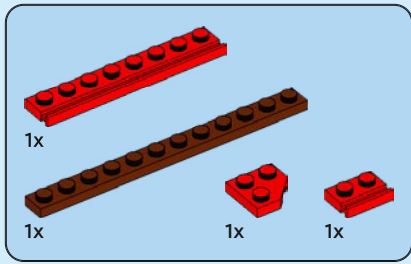

71

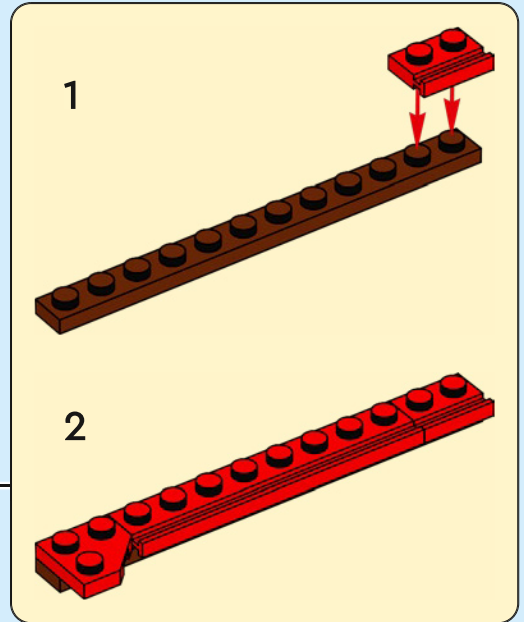
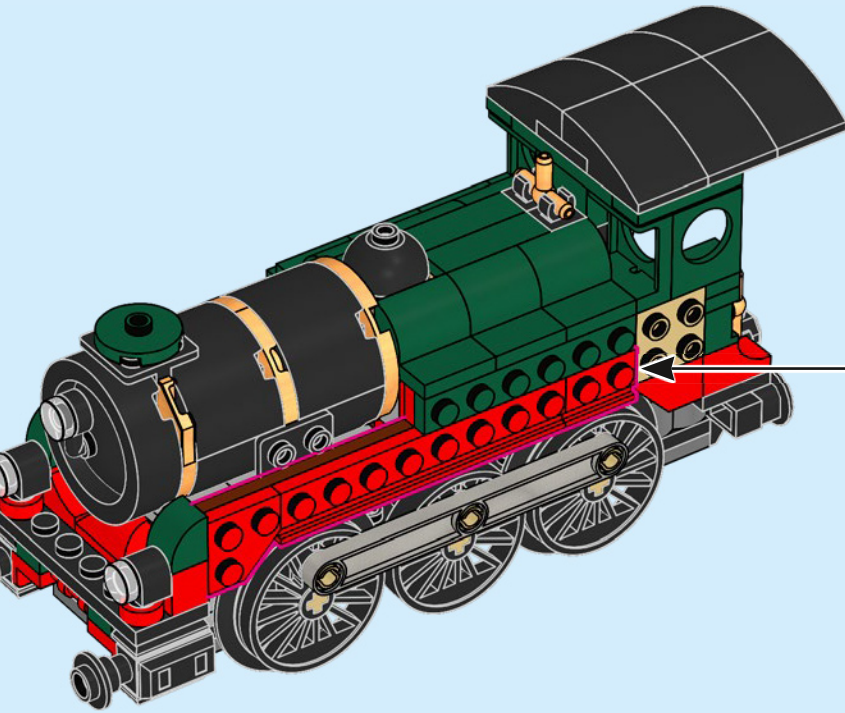

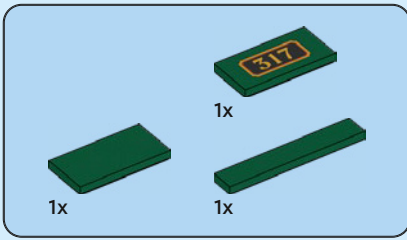

72

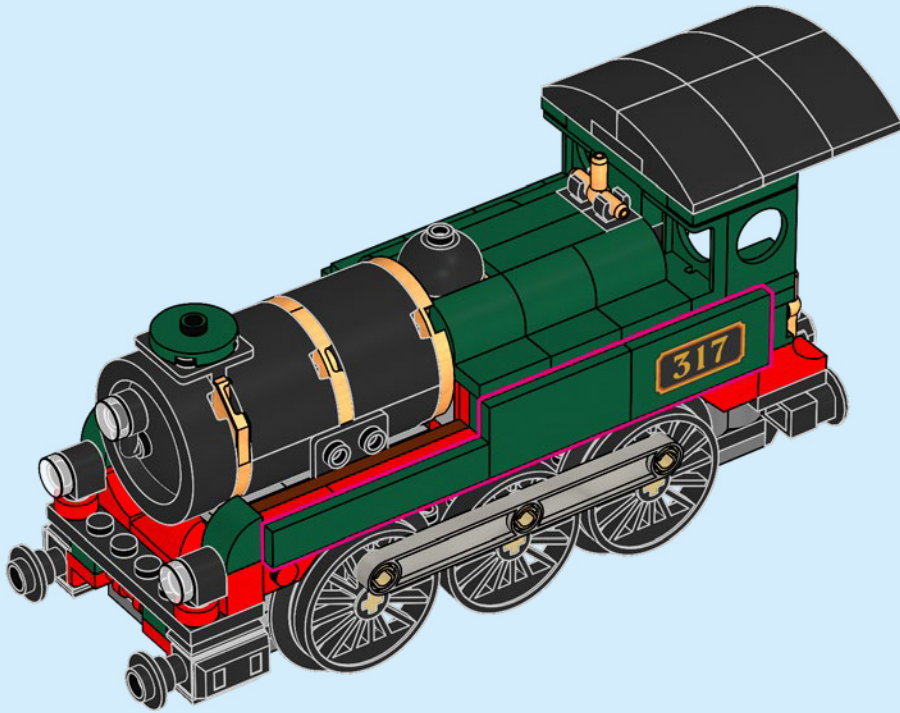



2x

73

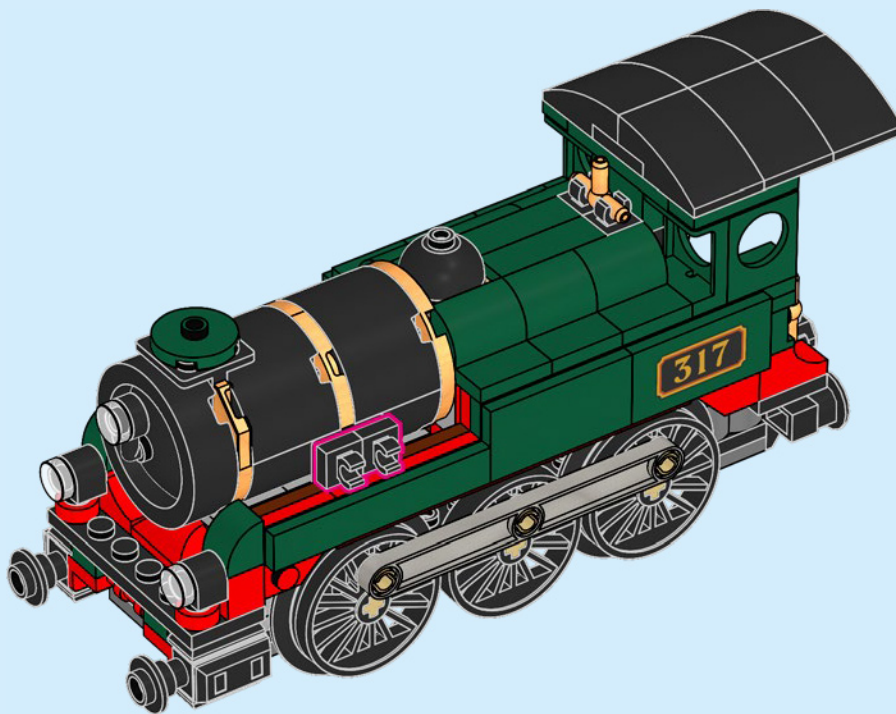



74

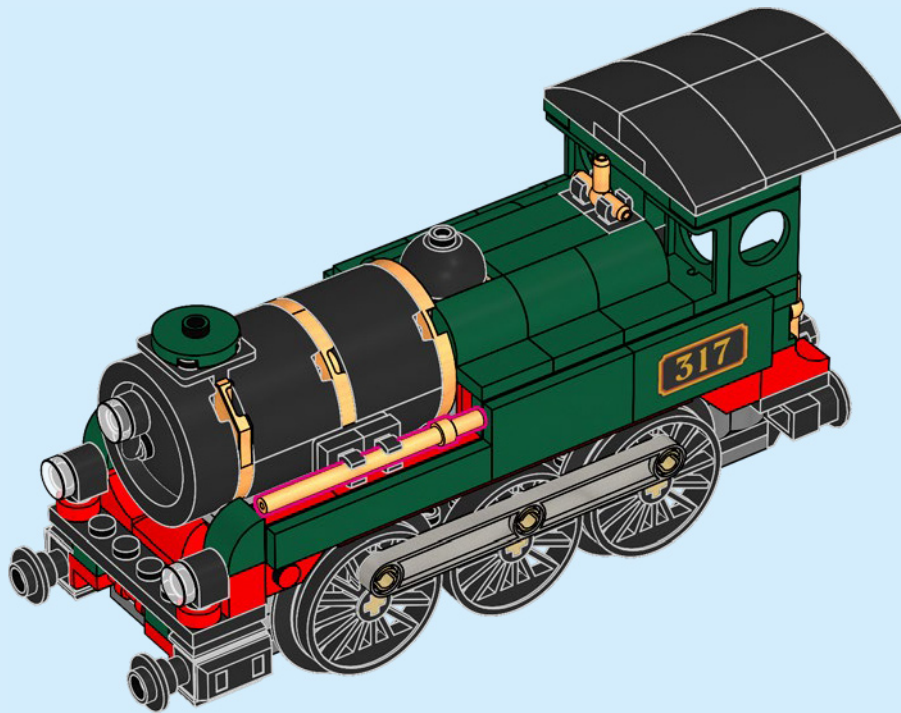



1x

75

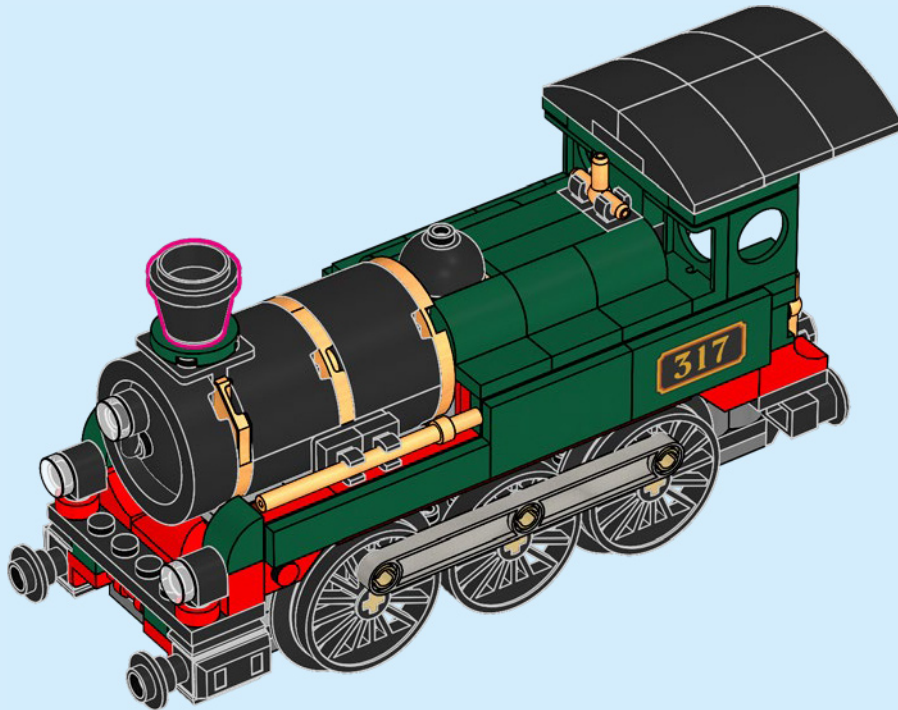



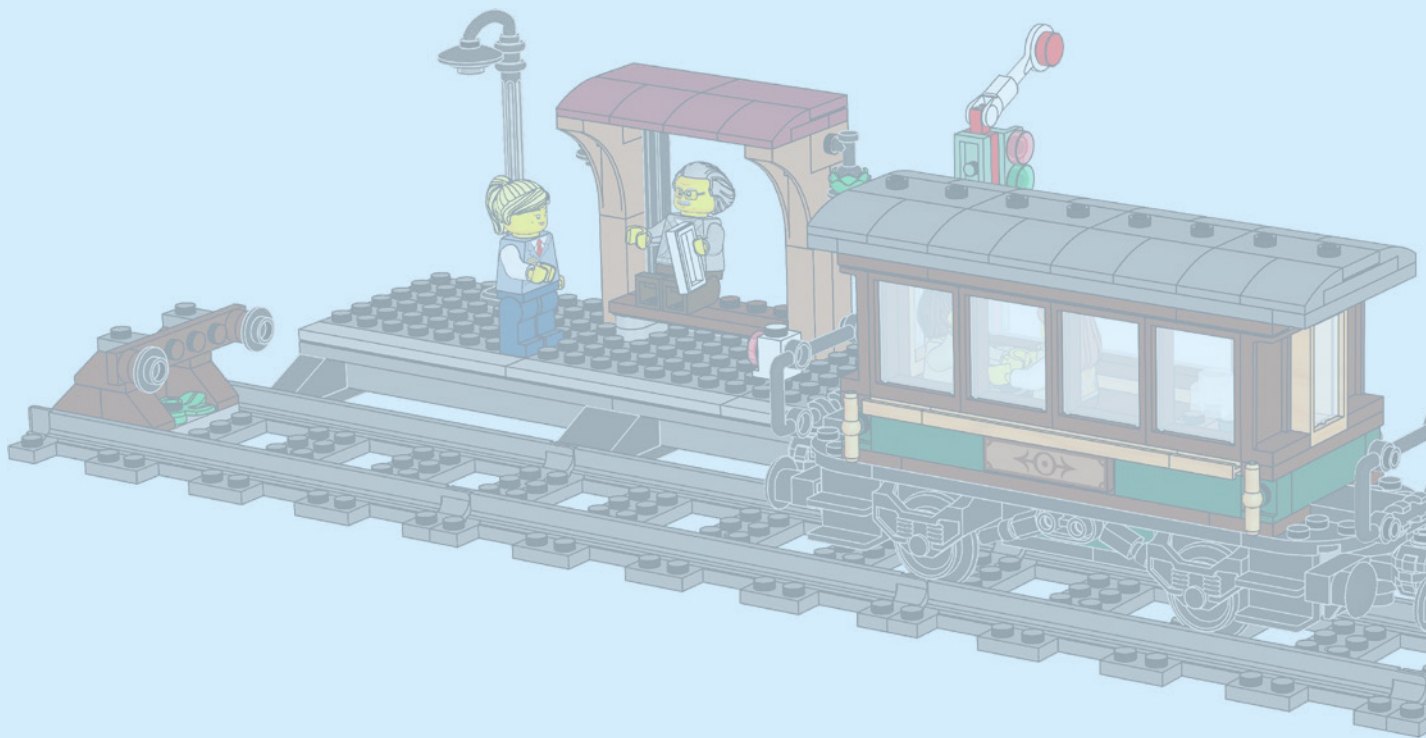

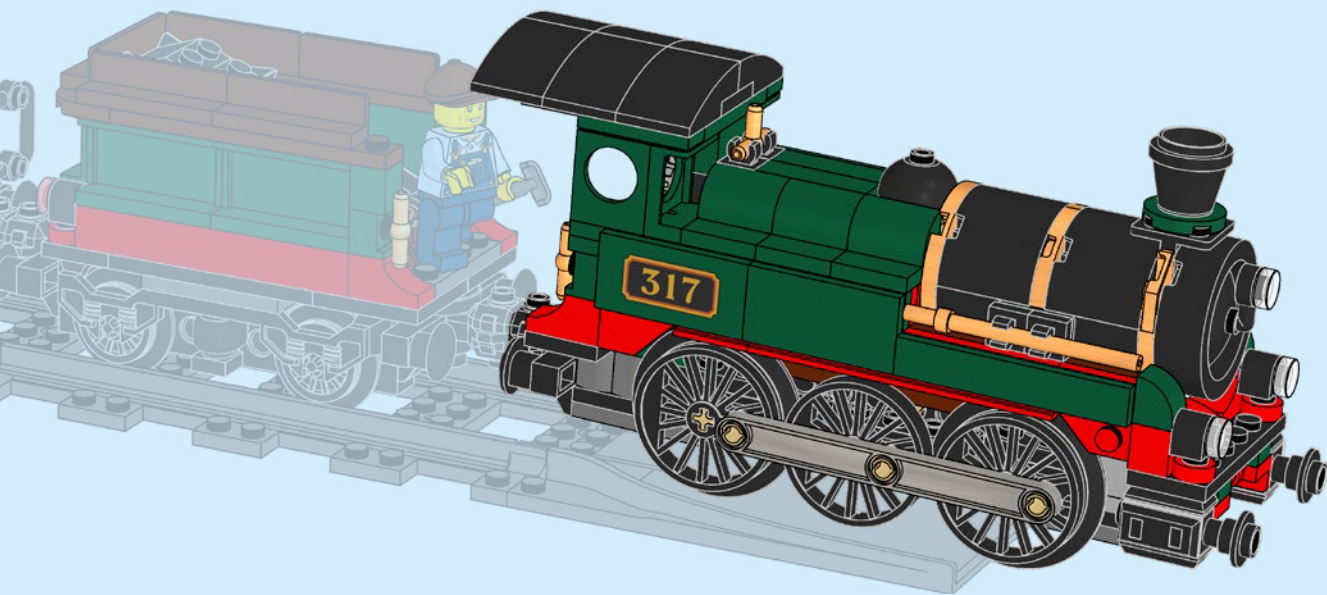



CITY

60494



60492



60497



60480



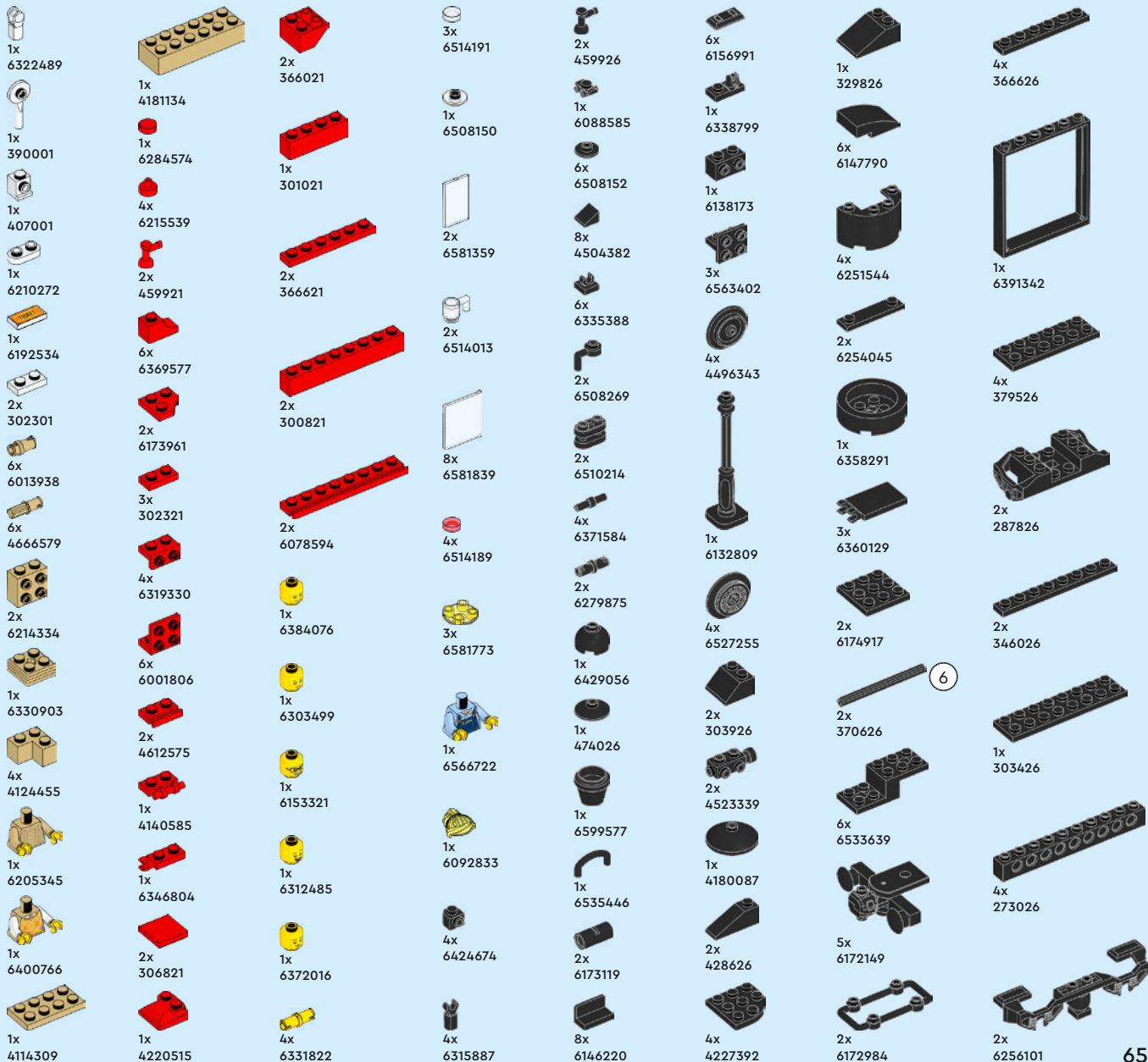



2x
6236464

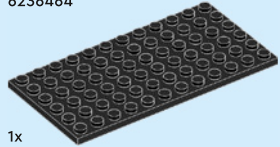

1x
302826

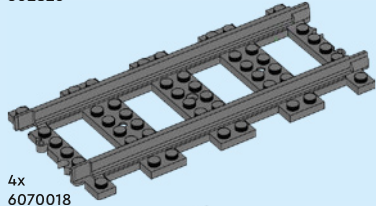

4x
6070018

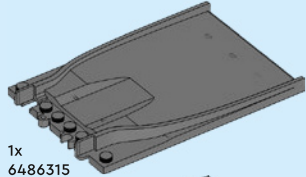

1x
6486315

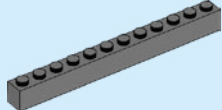

4x
4210798

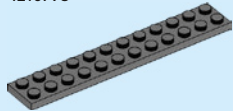

2x
4211067

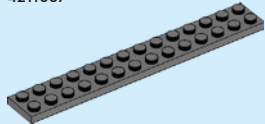

2x
6000970



1x
6514194

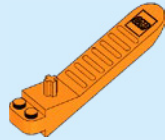

1x
6240515

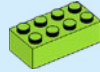

1x
4165967



1x
6494416



2x
4162916



1x
6509111



8x
6532421



4x
6055169



2x
6586936



2x
4521915



2x
6512536



4x
6534881



6x
6526022



1x
4245570



4x
6541446



6x
6484031



4x
4650622



4x
4245571



1x
6020923



5x
6486808



3x
4260493



2x
6599875



2x
6440430



2x
4245566



2x
6216880



1x
4521948



1x
6423391



2x
6192923



1x
6328184



4x
4539090



4x
6107758



2x
6264030



2x
4539061



2x
6186003



1x
6152321



2x
6514274



2x
6186673



1x
6408343



1x
6491486



1x
4221886



4x
6398342



6x
4211199



1x
4211219



1x
4645103



4x
4211257



2x
6526059



4x
6100769



8x
6502373



2x
6535594



2x
6599863



5x
6092659



2x
4211186



5x
4221590



1x
4211204



2x
4585337



2x
4216945



2x
4271874



2x
4223683



2x
4222627



2x
6055145



2x
6055145

1x
4211412

1x
6284071

1x
6329581

2x
6401023

2x
6335378

4x
6248890

1x
6234738

1x
6092956

4x
4211414

4x
6117967

1x
6258820

3x
4211413

1x
6453944

2x
6347992

2x
6171894

1x
4211396

2x
4211445

2x
4211435

4x
6257593

1x
4211395

3x
6372029

4x
4211393

1x
4612621

2x
6591166

3x
4211481

2x
6287854

2x
6378362

2x
6339311

2x
4569382

2x
6401015

2x
6488532

2x
6271752

2x
6413106

4x
4211095

16x
6071261

1x
6267047

3x
4213607

4x
4211001

1x
4211006

4x
6307616

2x
4211056

7x
6186825

1x
4595710

2x
4257526

1x
4211061

3x
4210794

1x
6508086

1x
6508101

9x
6452472

4x
6578193

2x
6547883

4x
6338242

1x
6521234

2x
6170470

2x
6417695

2x
6453350

2x
4298979

1x
4529672

2x
6550579

2x
6229130

1x
6004435

 [LEGO.com/service](https://www.LEGO.com/service)

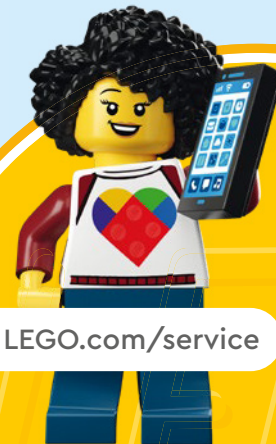

YOU COULD **WIN**



Scan this QR code or go to **LEGO.COM/PRODUCTFEEDBACK** and give us your short feedback about this LEGO® set for a chance to win a cool LEGO prize.

Terms and Conditions apply*

EN: YOU COULD WIN. Terms and Conditions apply* **DE: Du könntest GEWINNEN.** Es gelten die Teilnahmebedingungen* **FR: TU POURRAIS GAGNER.** Des conditions s'appliquent* **IT: Potresti VINCERE tu.** Termini e condizioni sono applicabili* **ES: PUEDES GANAR.** Aplican términos y condiciones* **PT: PODERÁ GANHAR.** Aplicam-se Termos e Condições* **ZH: 轻松获奖. 条款和条件适用*** **PL: Szansa na WYGRANĄ.** Obowiązuje regulamin* **CS: Máte šanci VYHRÁT.** Platí všeobecné smluvní podmínky* **SK: Máte šancu VYHRÁŤ.** Platia všeobecné zmluvné podmienky* **HU: TE IS NYERHETSZ!** Felhasználási feltételek érvényesek* **UA: ВИ МОЖЕТЕ ВИГРАТИ.** Застосовуються загальні положення та умови* **RO: Ai putea CÂȘTIGA.** Se aplică termeni și condiții* **BG: Можете да СПЕЧЕЛИТЕ.** Има определени правила и условия* **LV: Tu vari LAIMĒT.** Ir spēkā noteikumi un nosacījumi.* **ET: Sul on võimalus VÕITA.** Kehtivad tingimused* **LT: Jūs galite LAIMĖTI.** Taikomos sąlygos* **TR: KAZANABİLİRSİN.** Şartlar ve Koşullar geçerlidir*

*[LEGO.com/productfeedback-terms](https://www.lego.com/productfeedback-terms)