

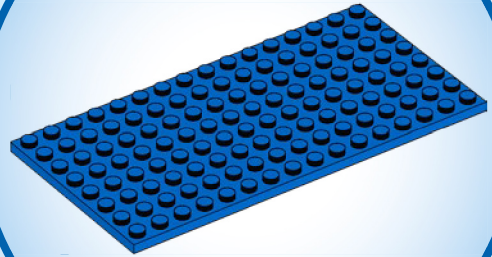

# CITY

60506

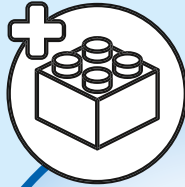



1x



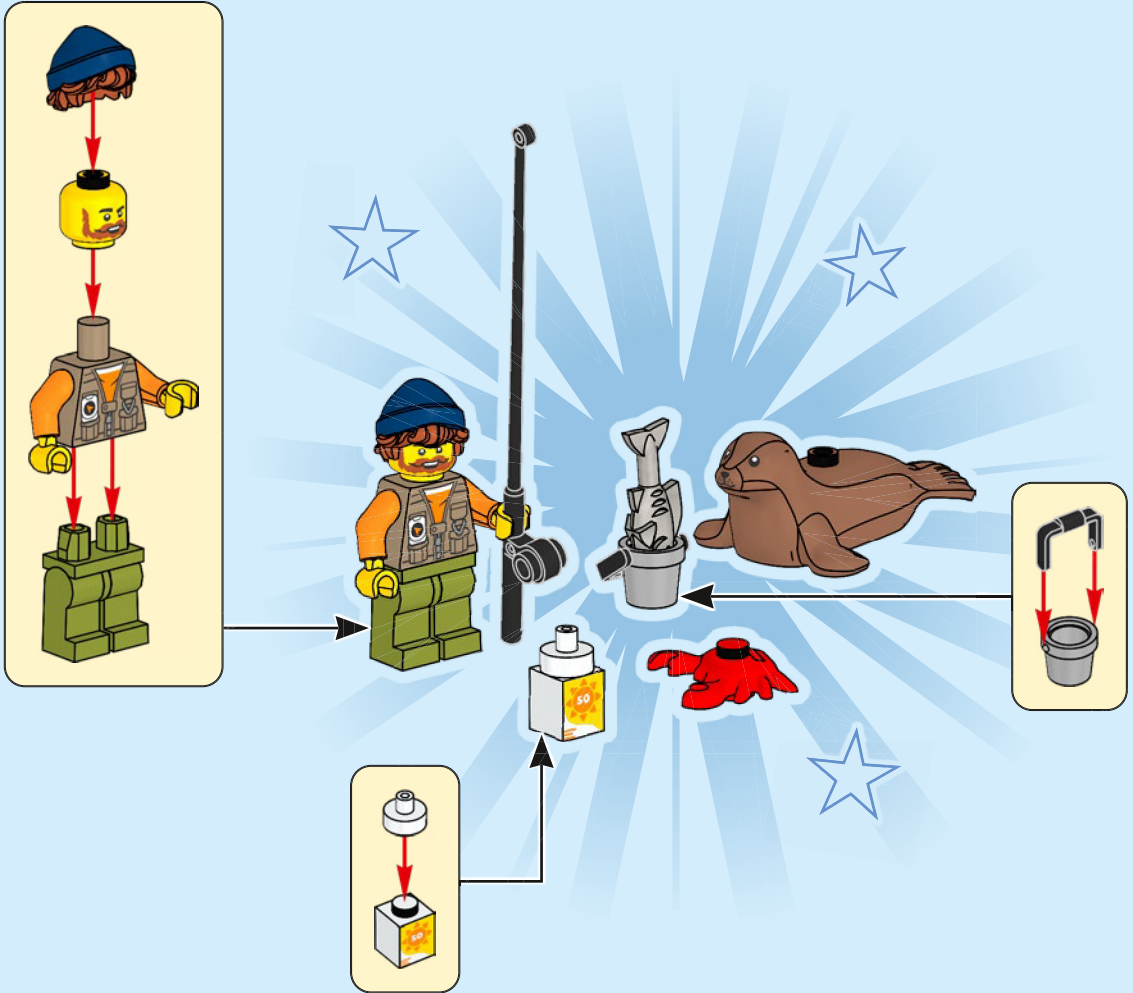

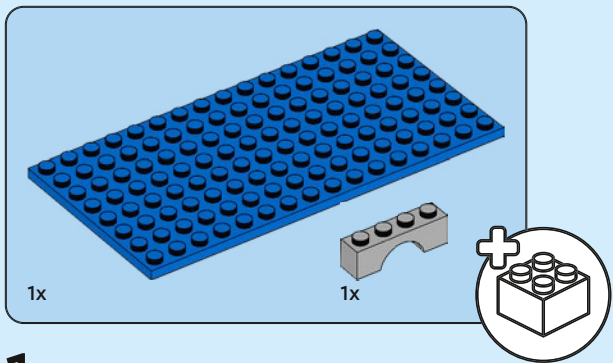

1

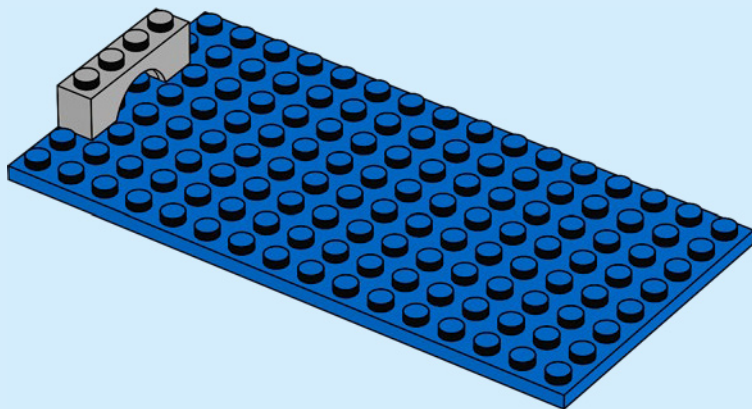



2

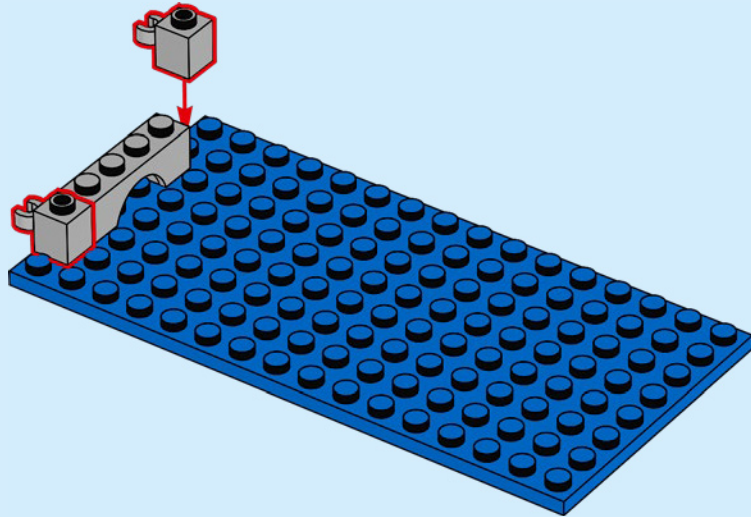

3

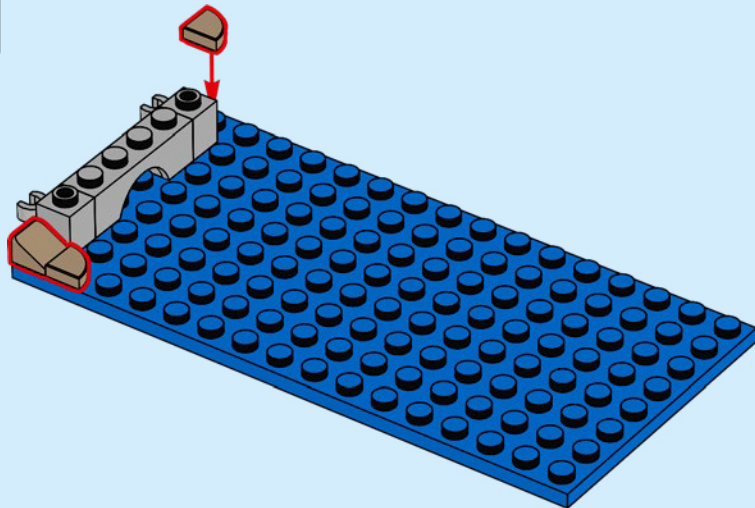



1x



1x

4

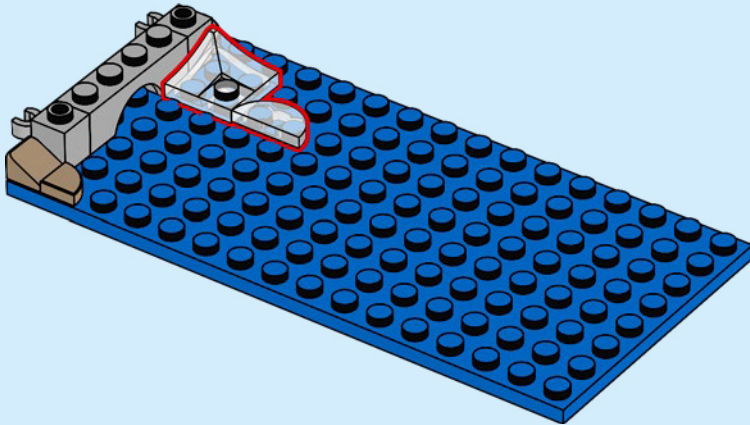

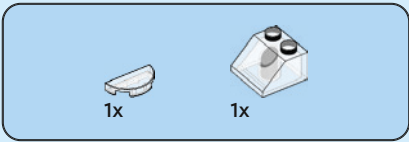

5

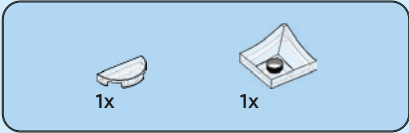
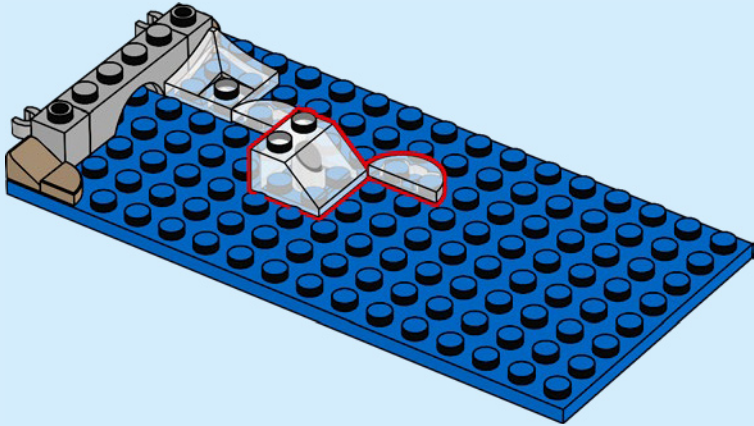

6

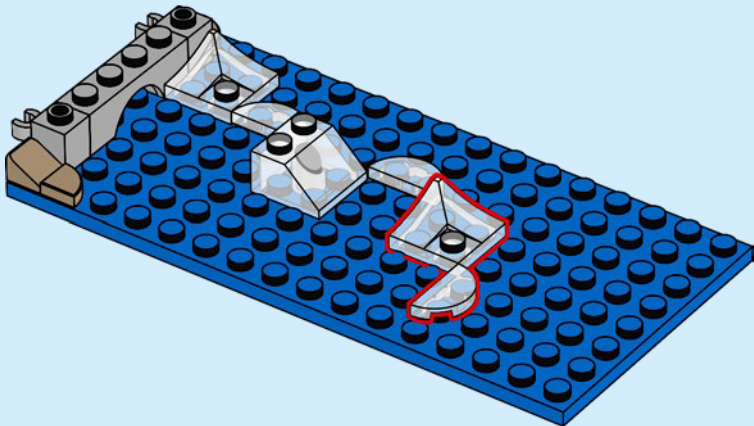



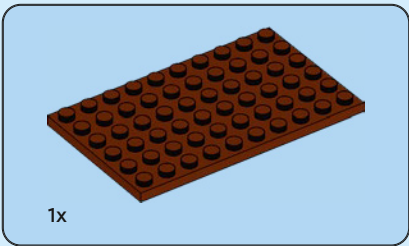

8

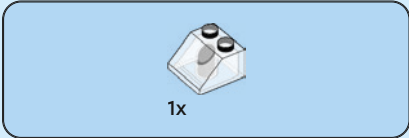
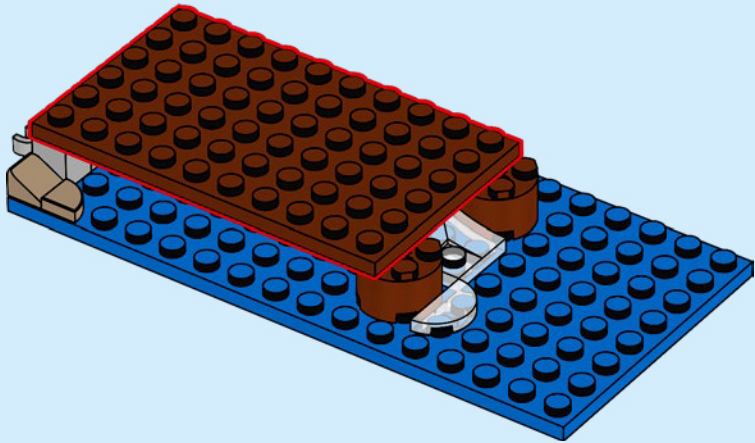

9

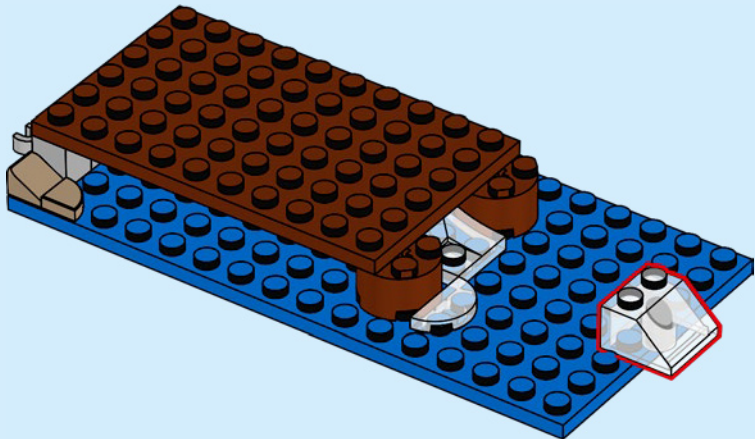

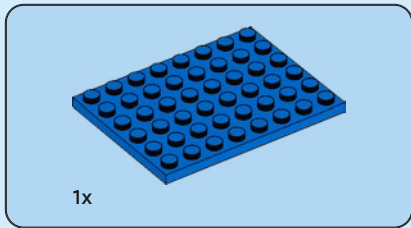

10

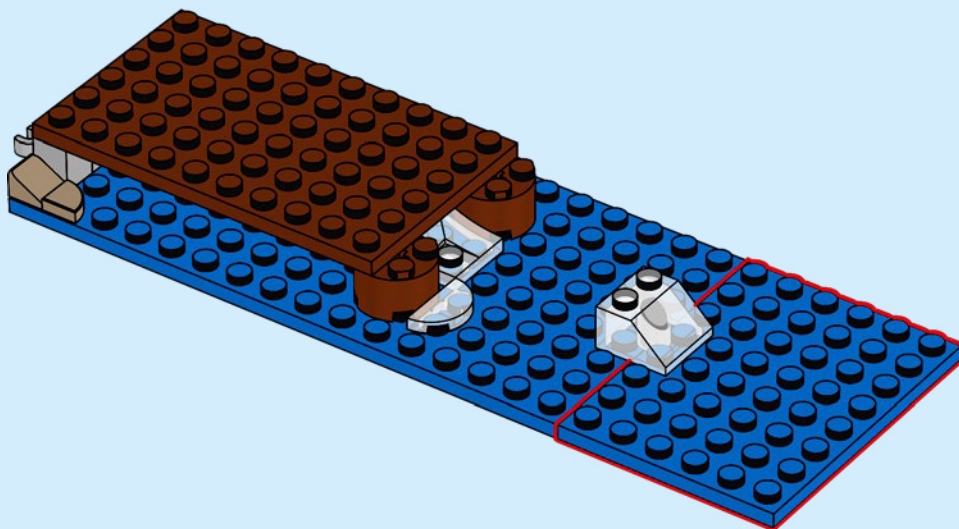



2x



1x

11

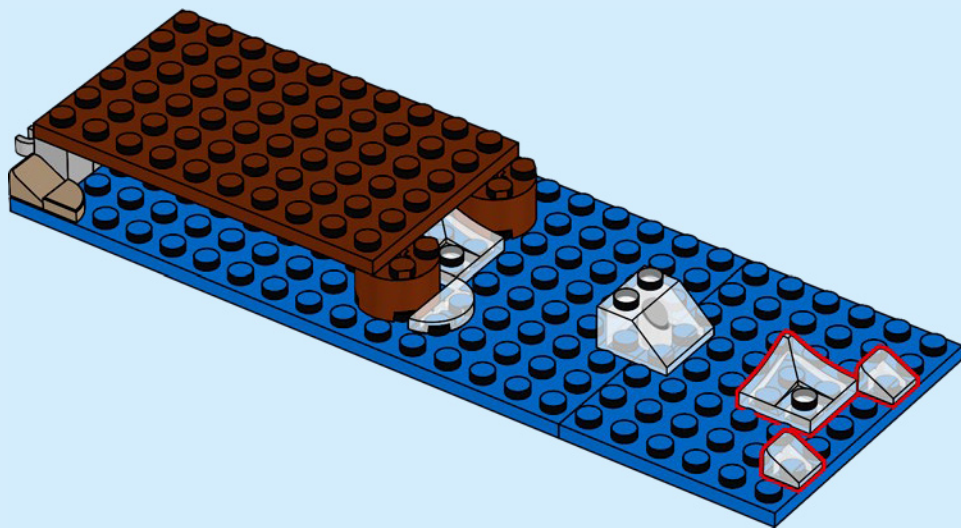



2x

12

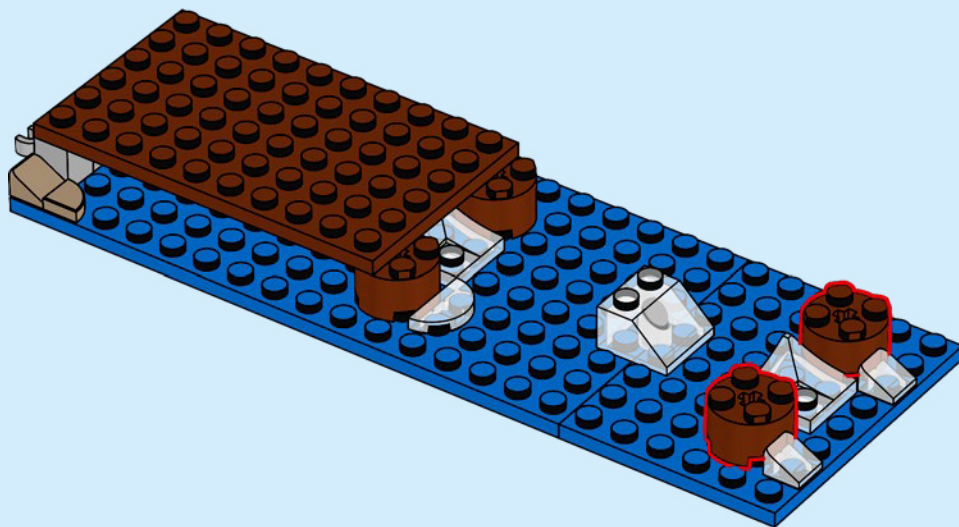

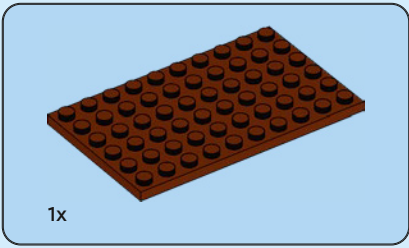

13

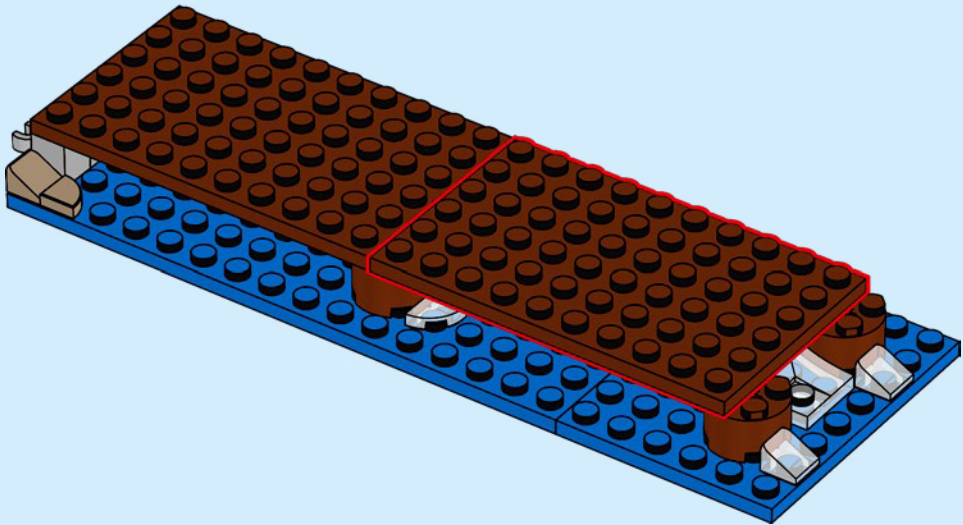



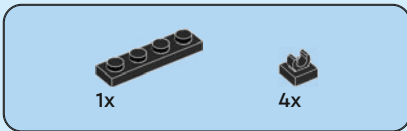

15

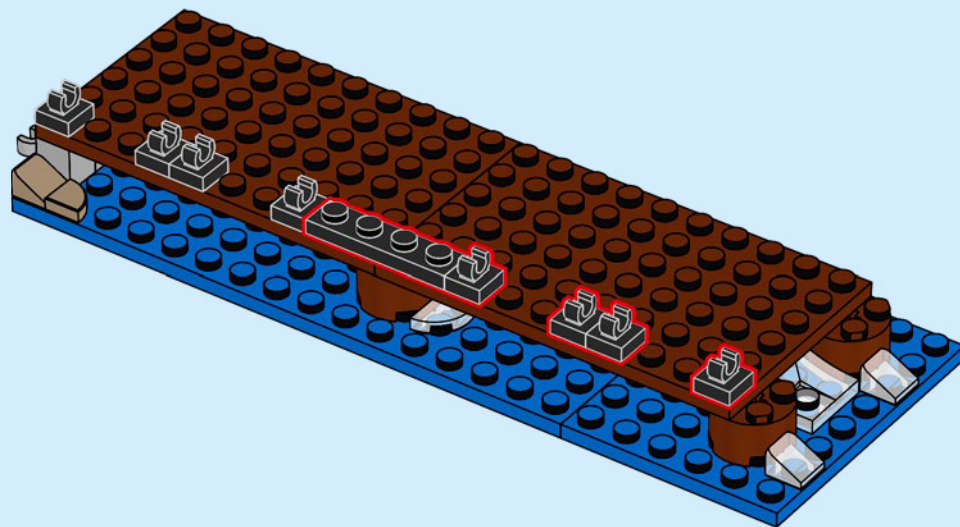

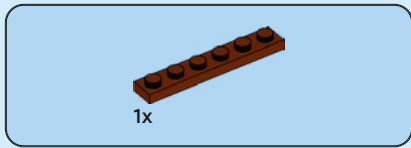

16

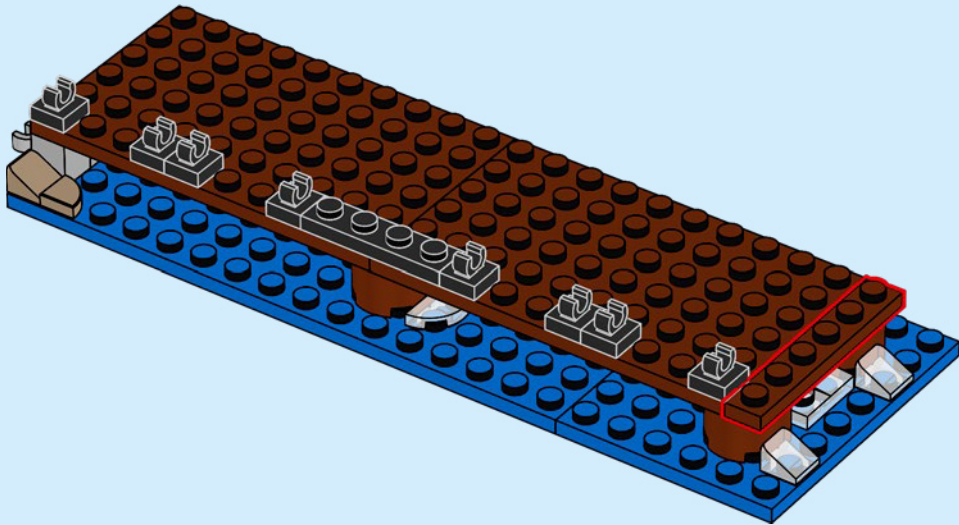



2x



2x

17

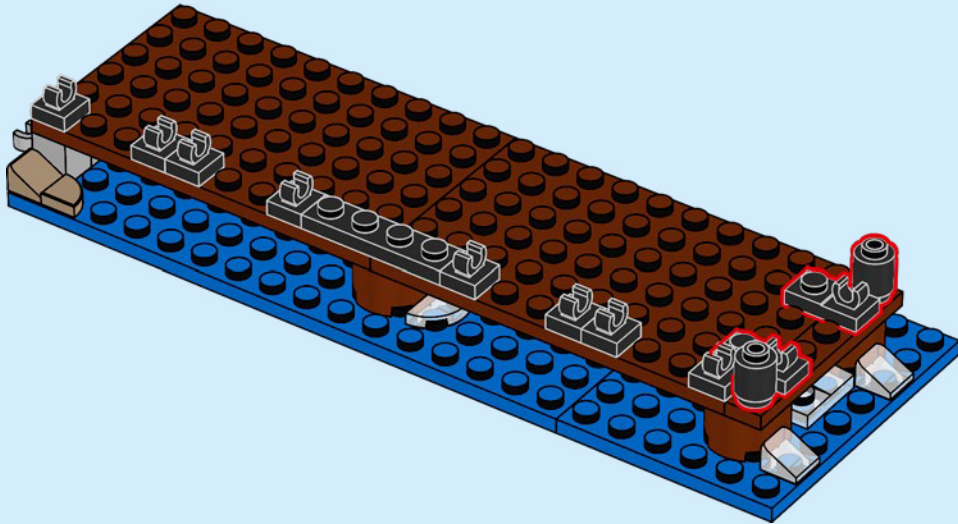



2x



1x

18

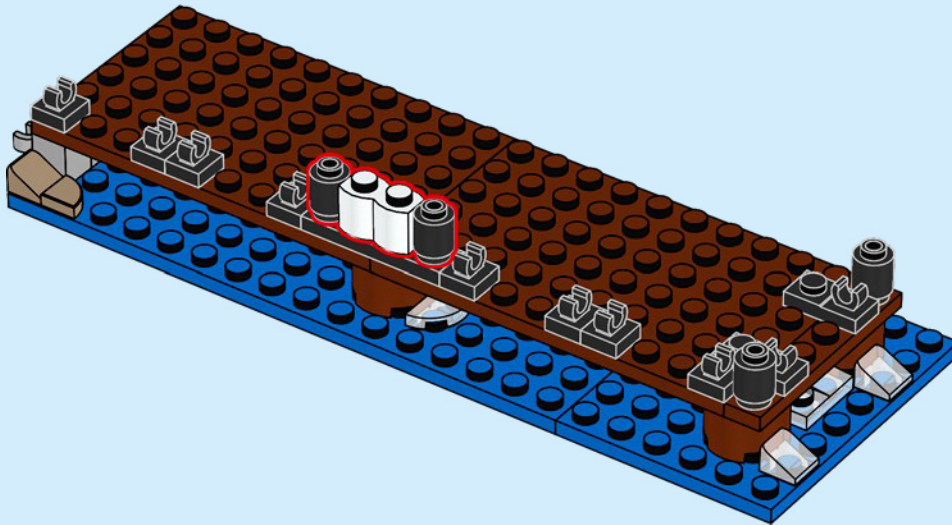



19

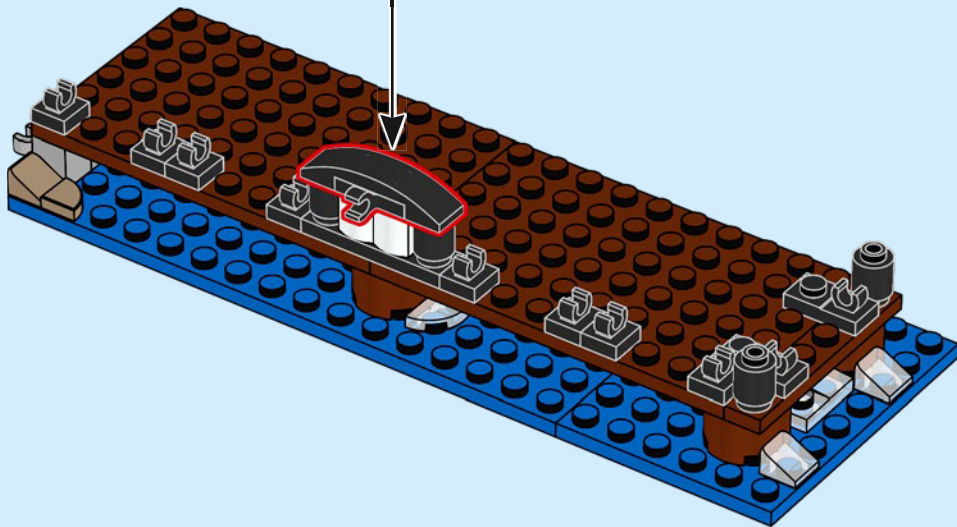
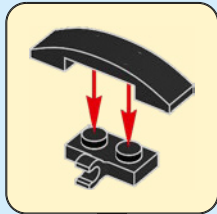



1x

20

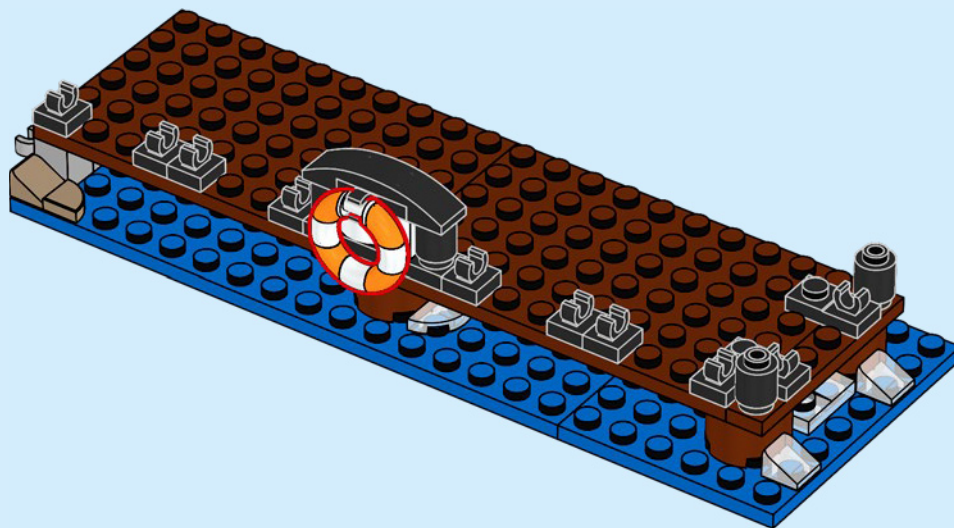

1x

1x

21

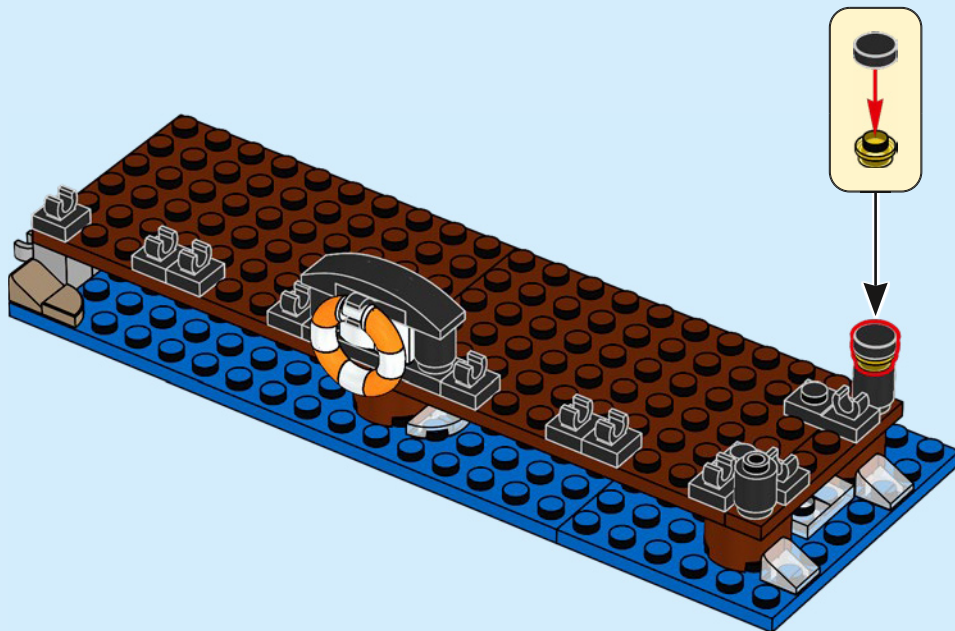



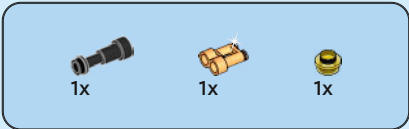

23

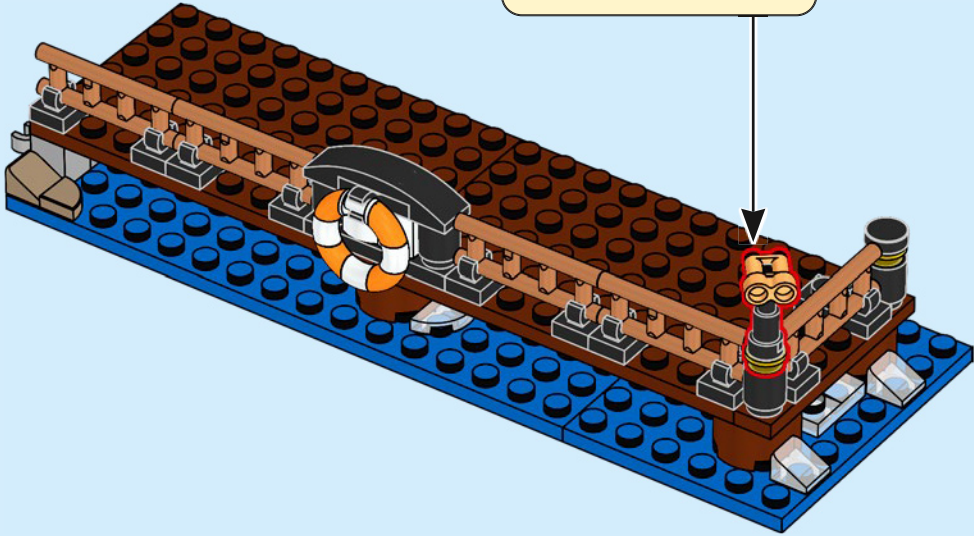
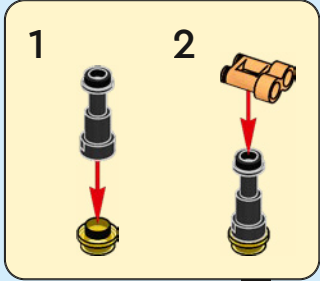

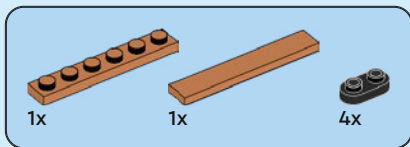

24

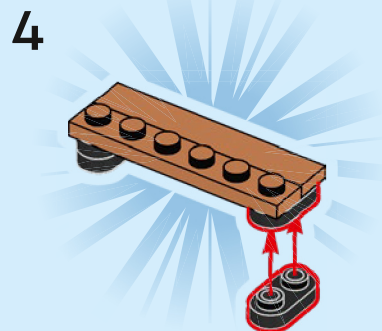
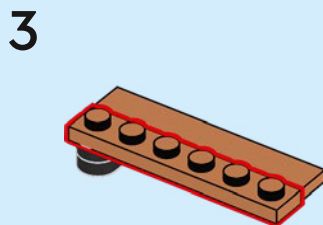
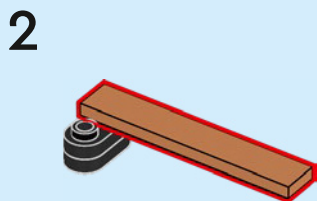
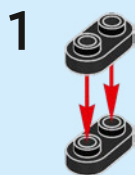

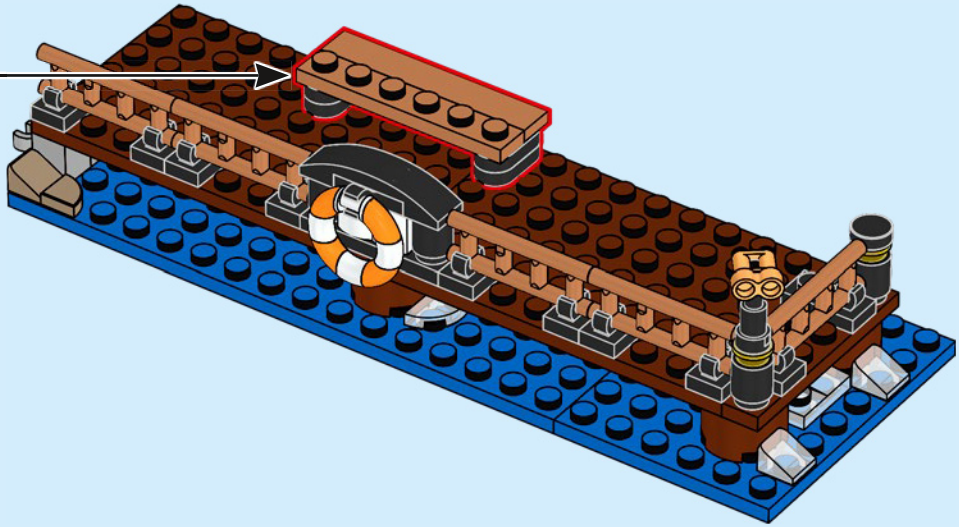

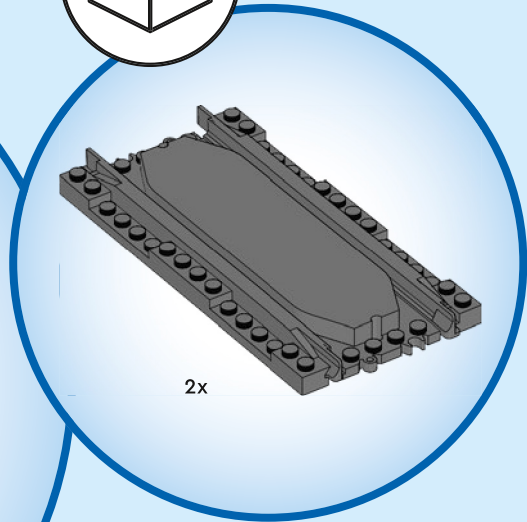
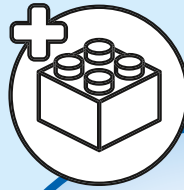

2x



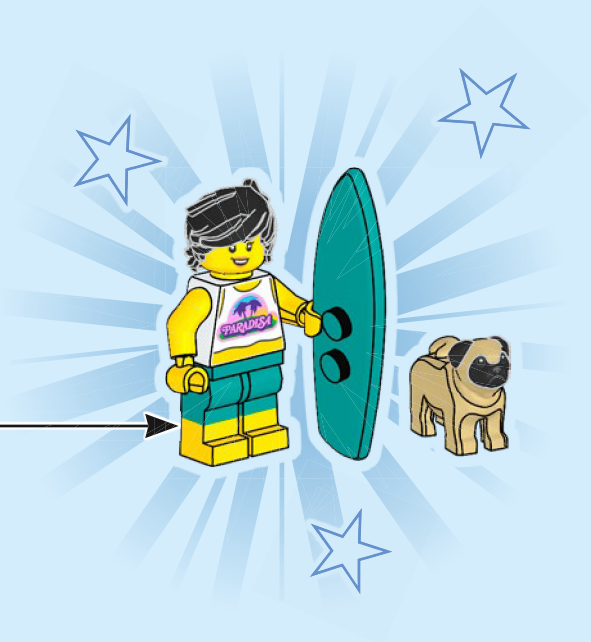
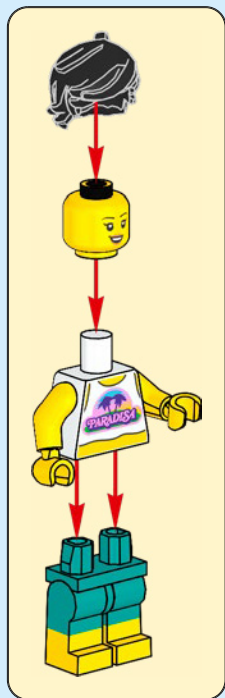

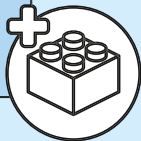
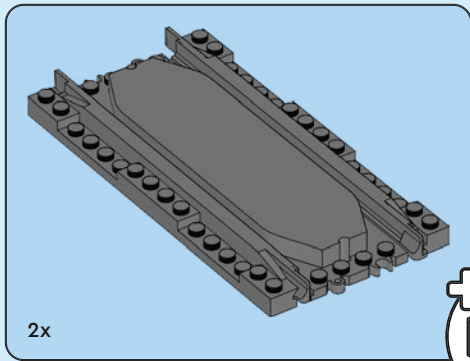

25

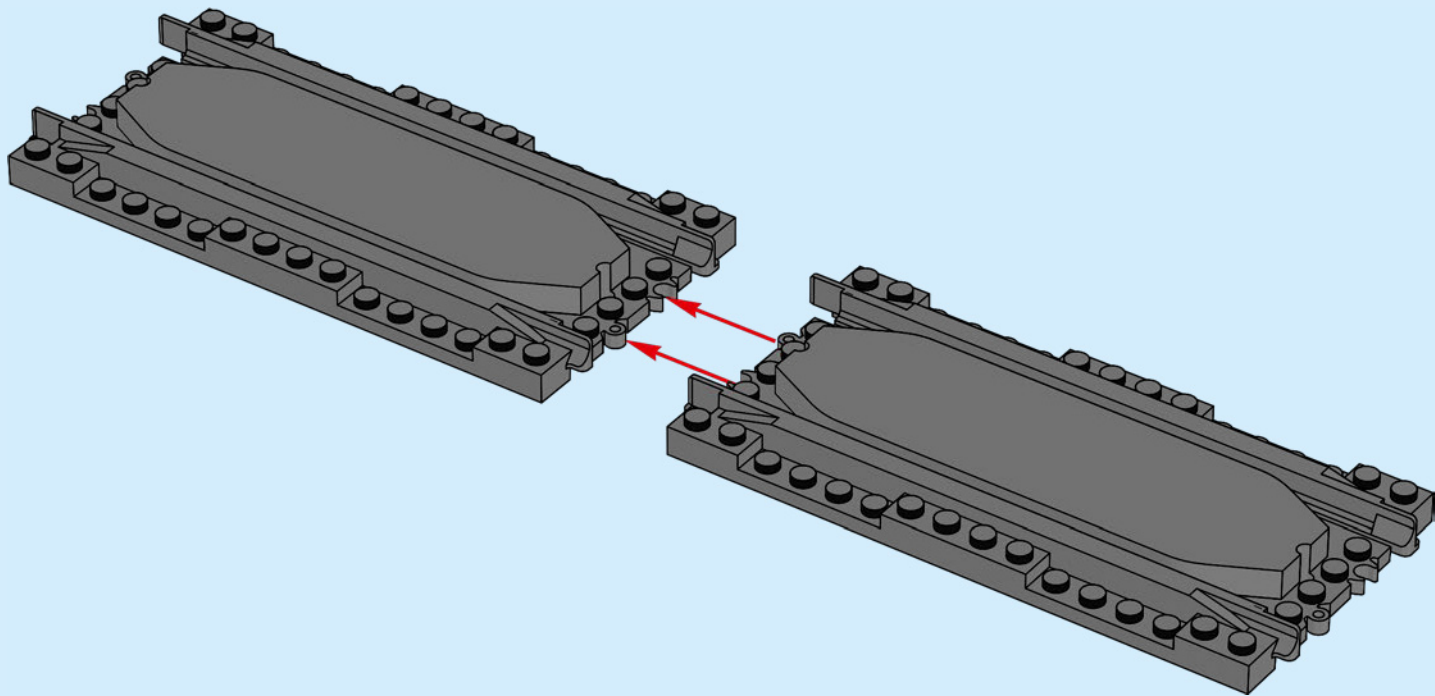

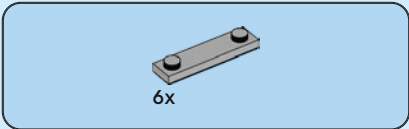

26

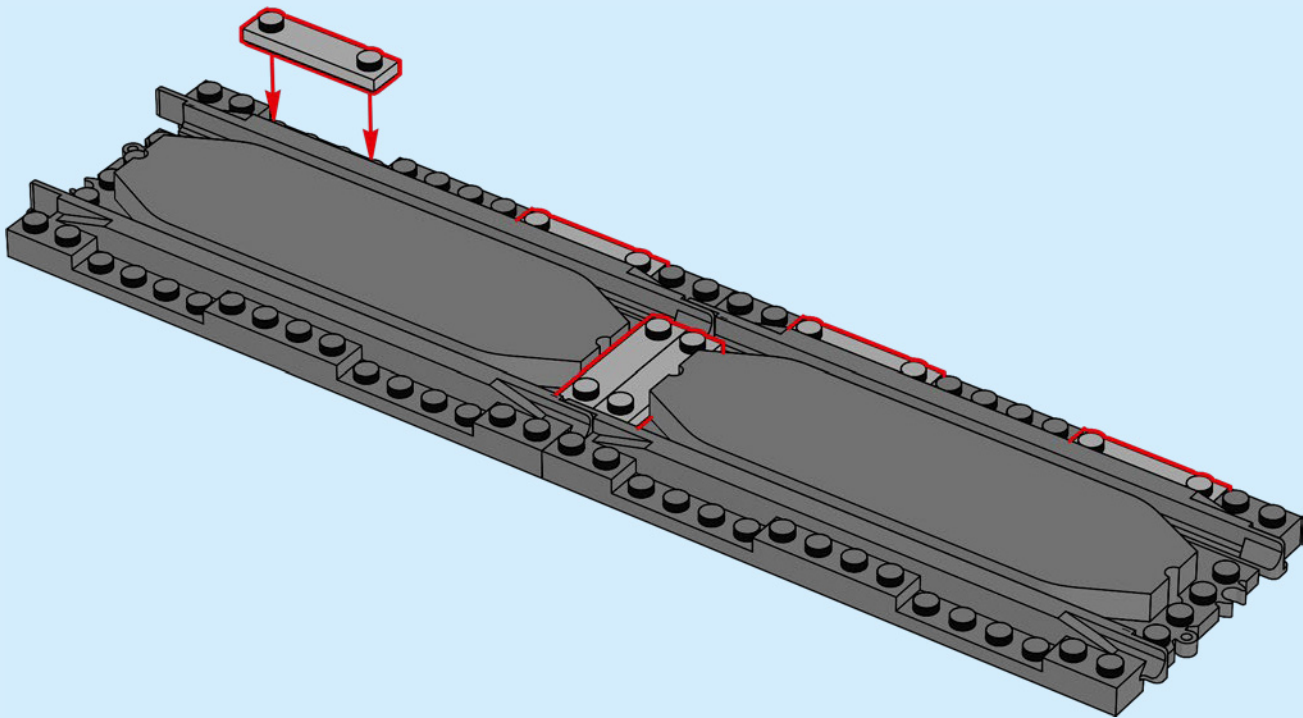



2x

27

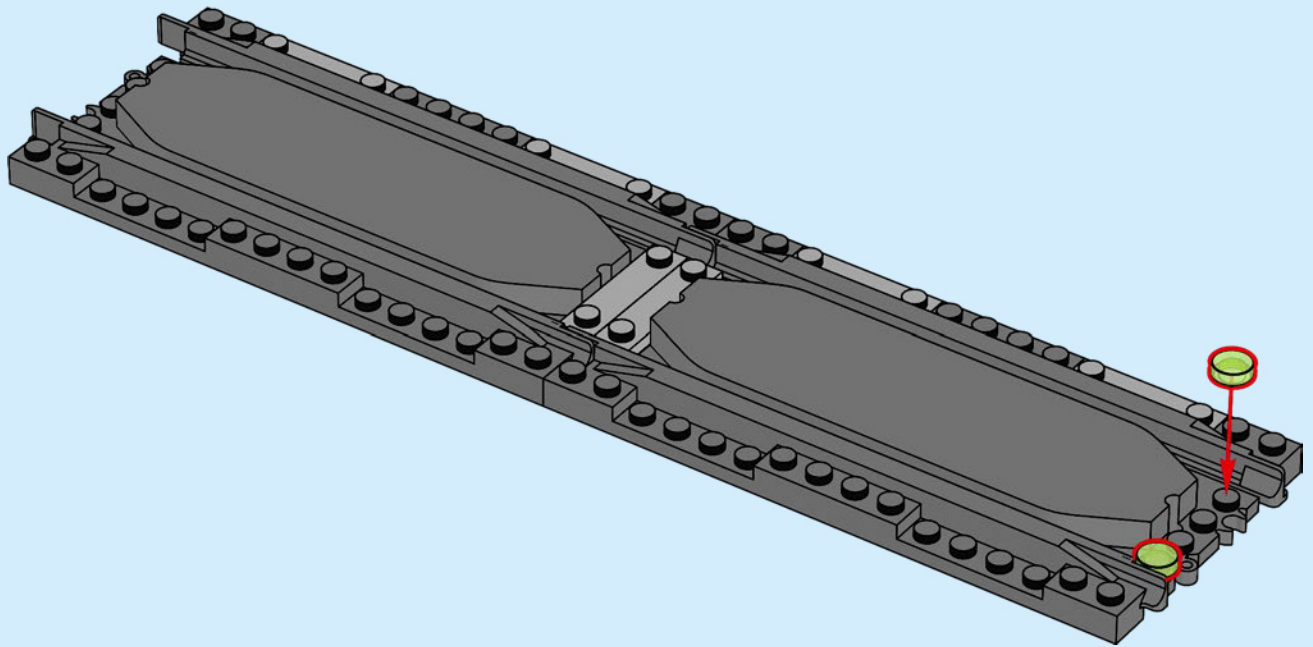

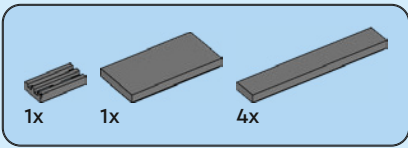

28

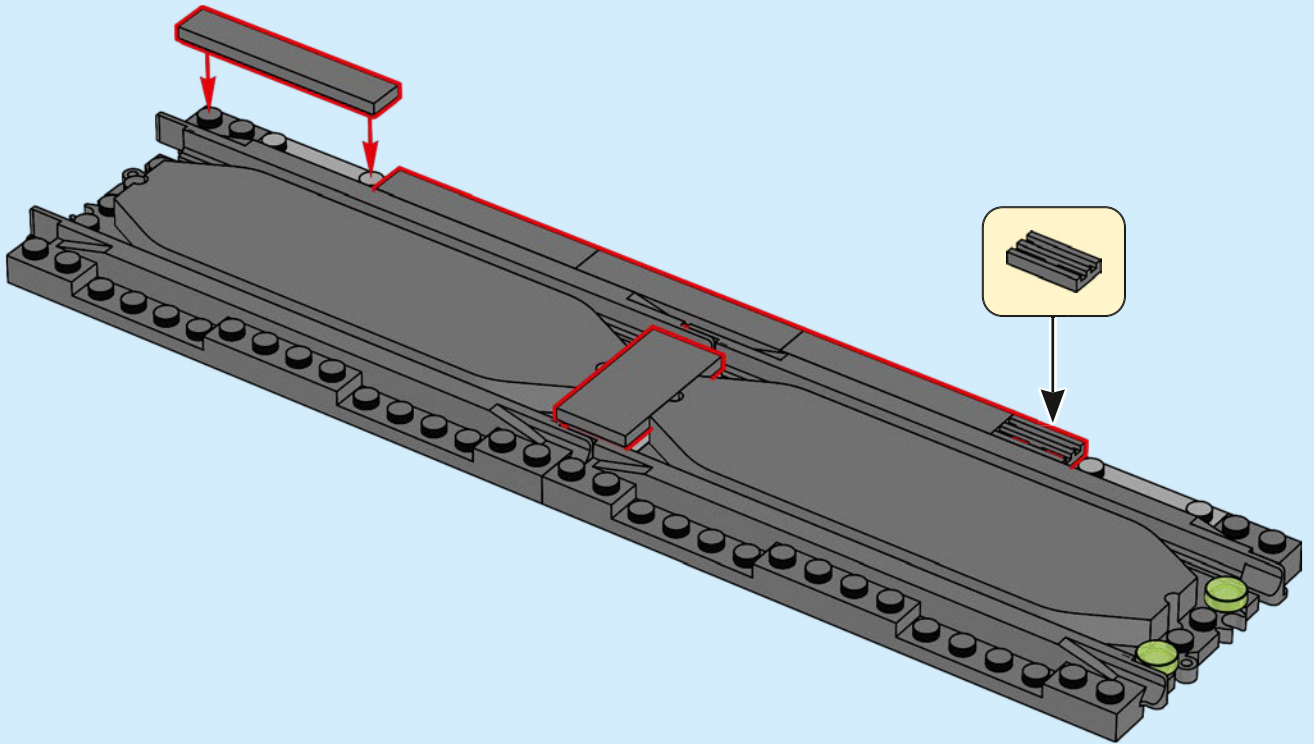

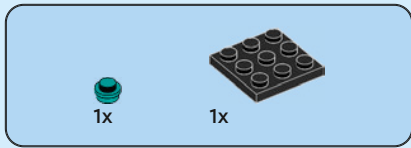

29

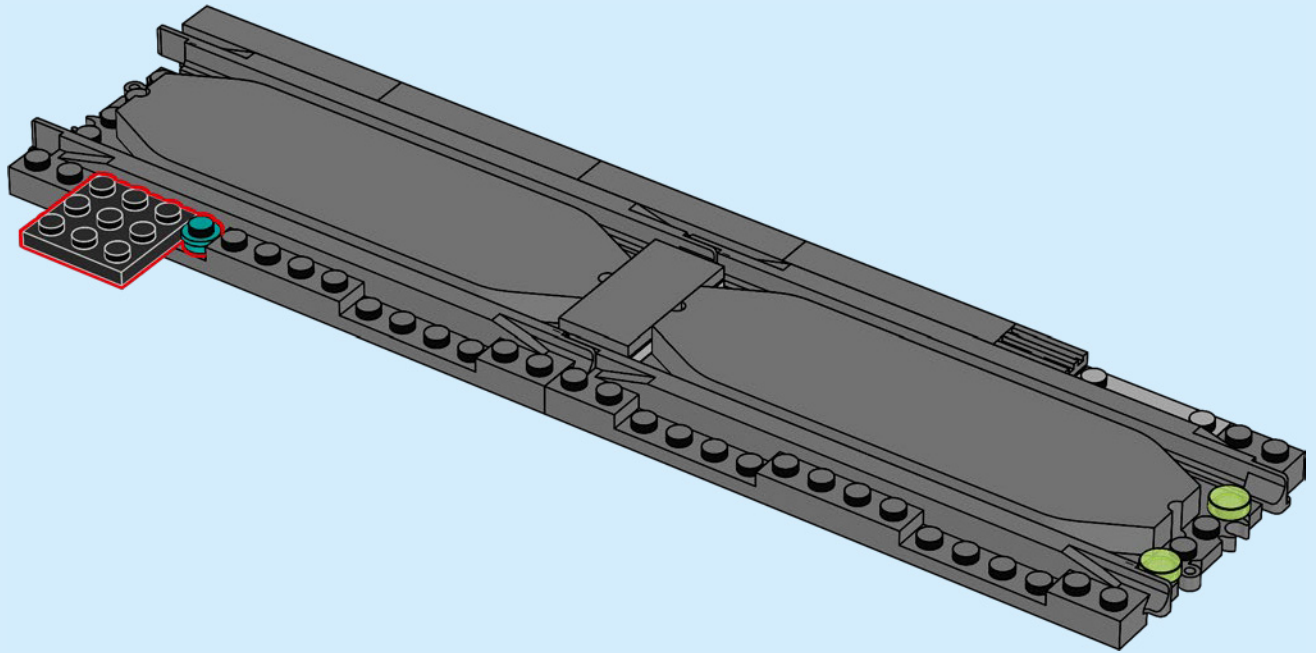

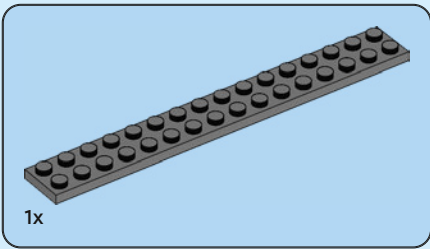

30

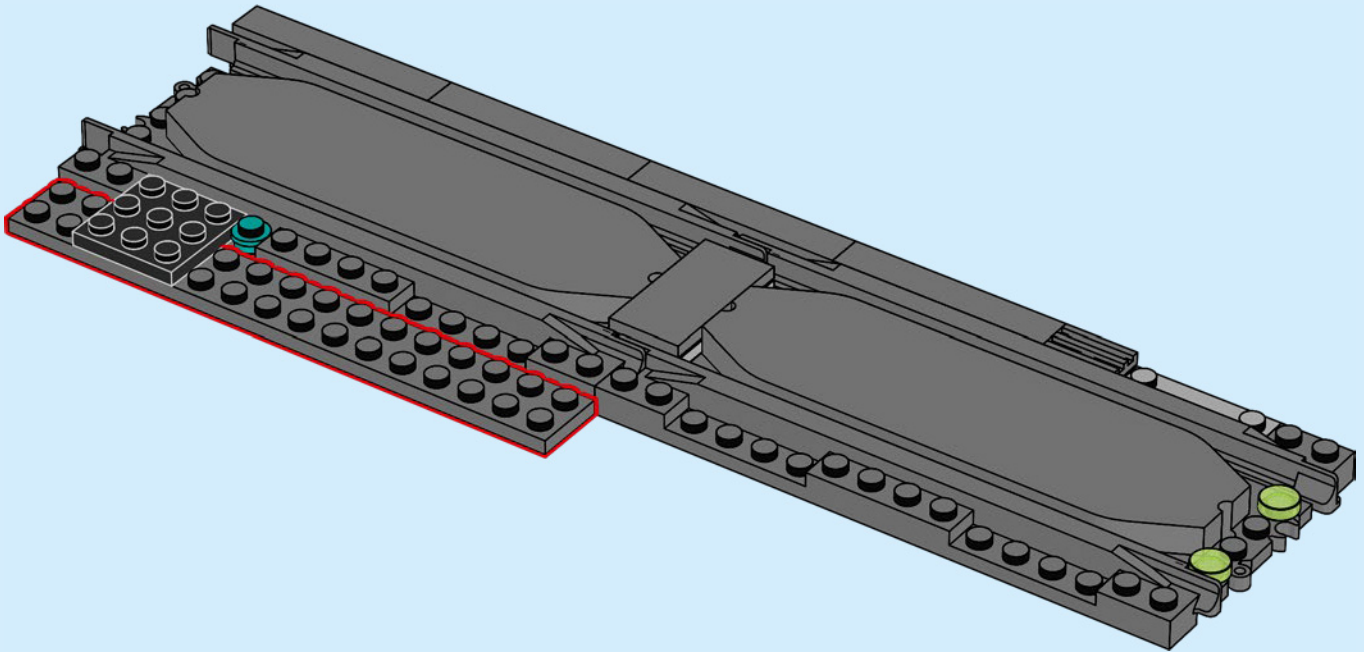

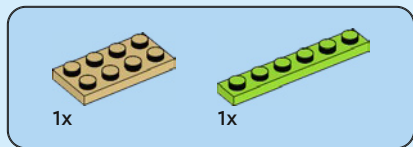

31

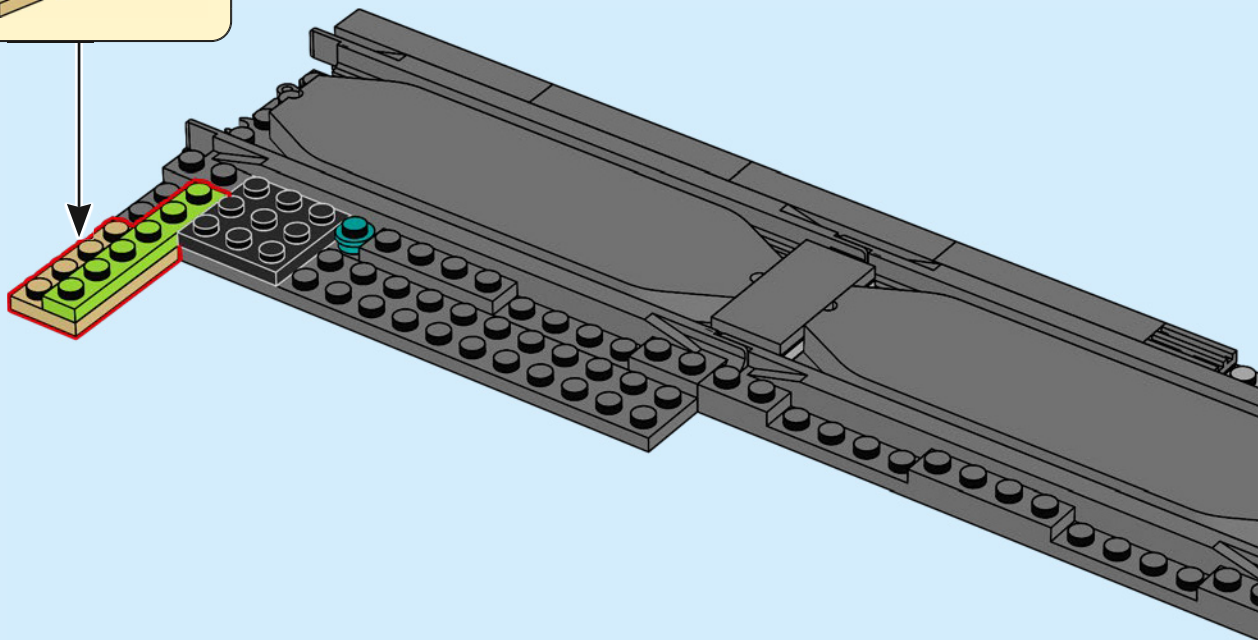
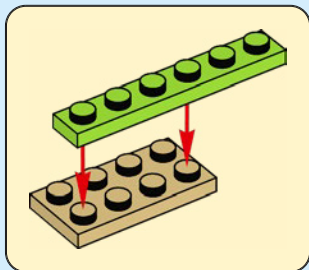

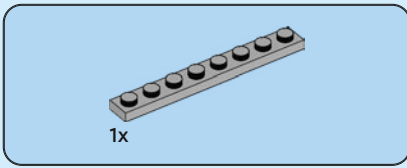

32

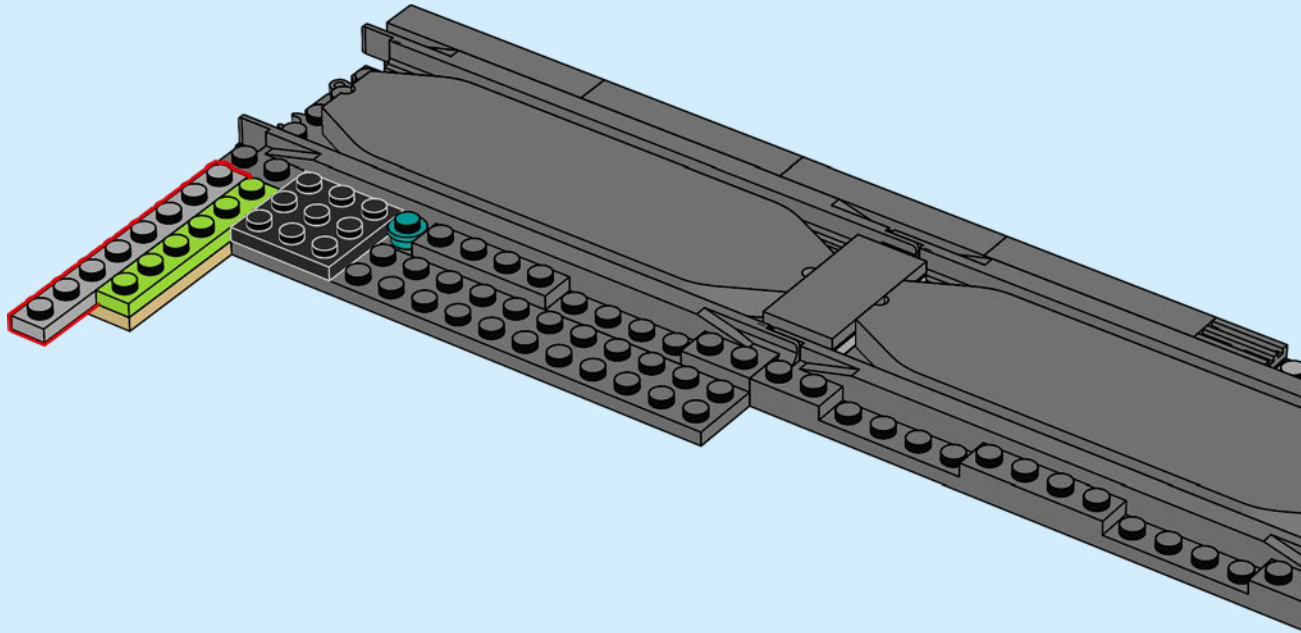

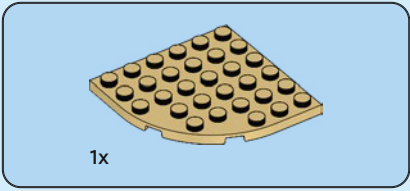

33

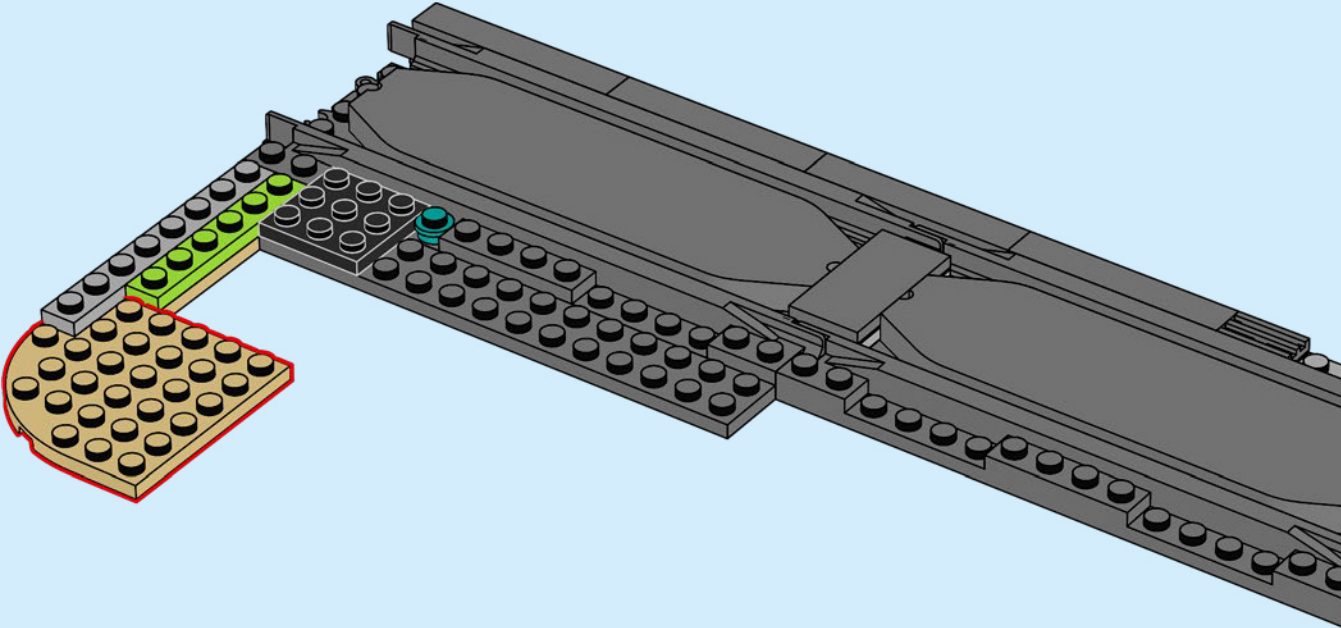

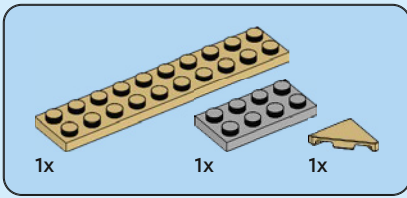

34

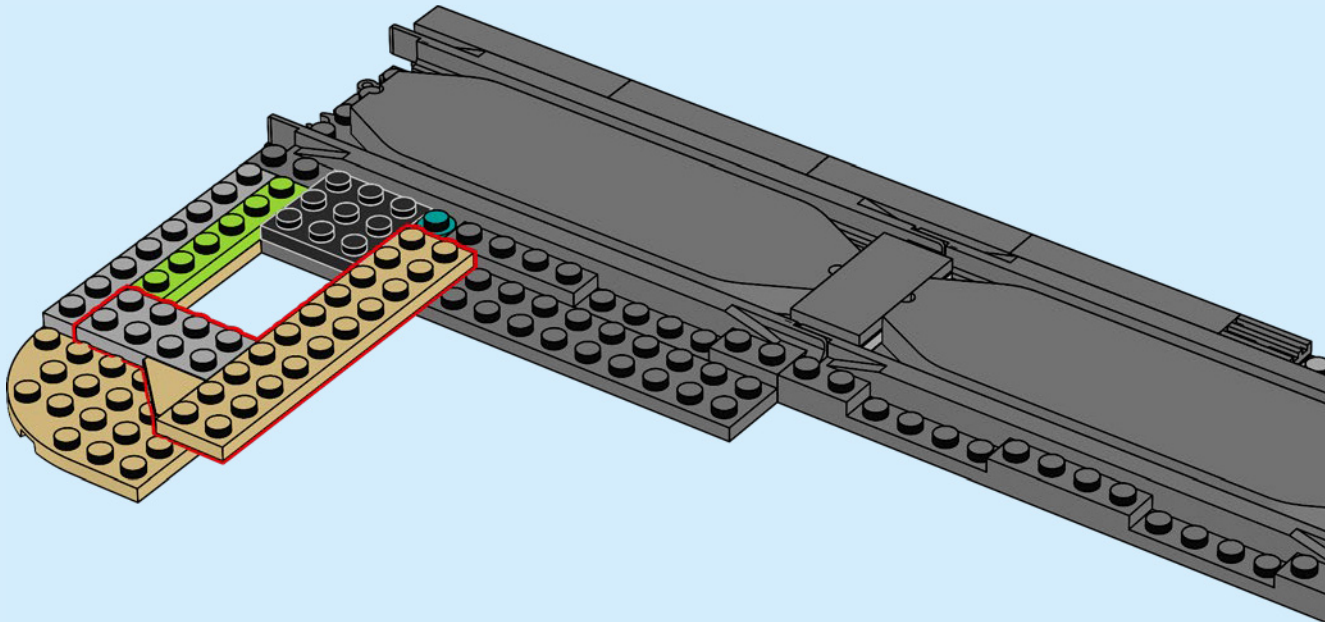

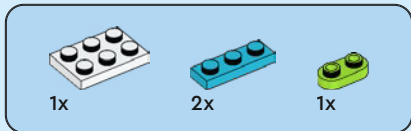

35

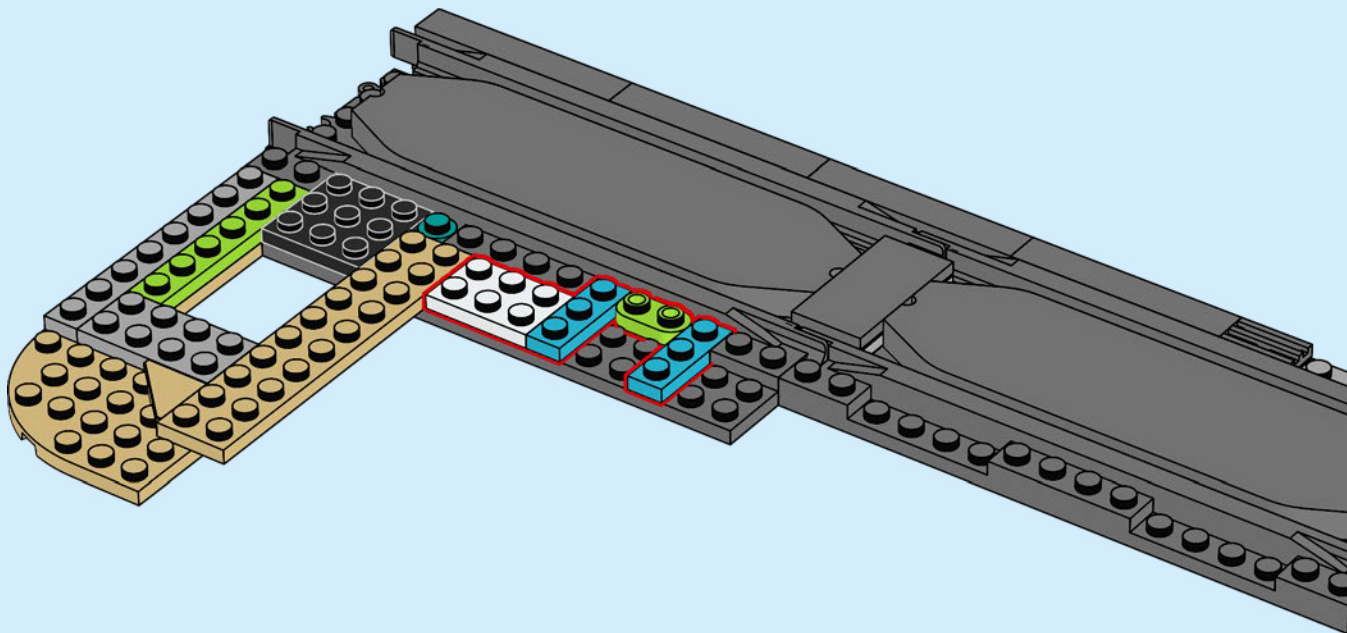

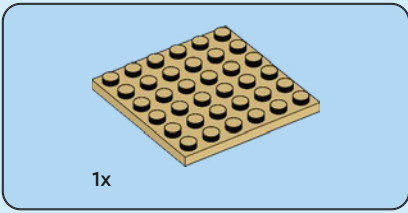

36

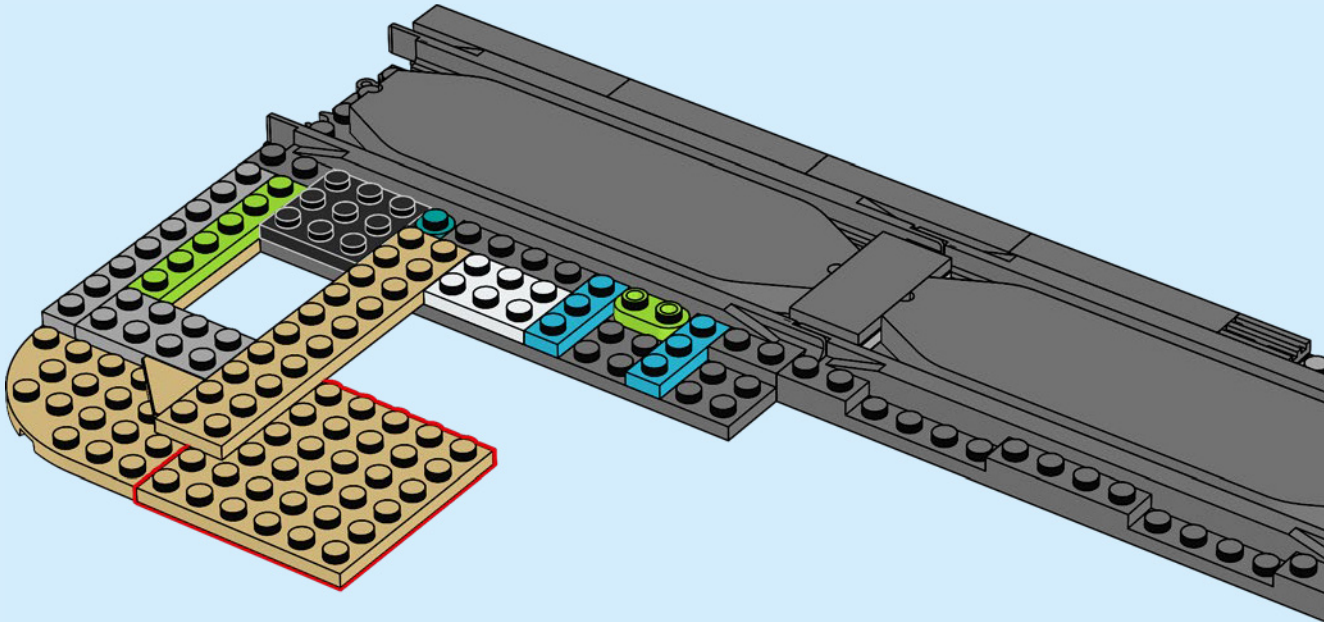

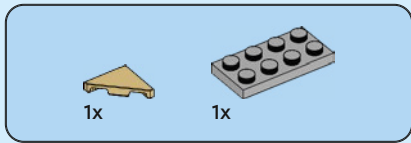

37

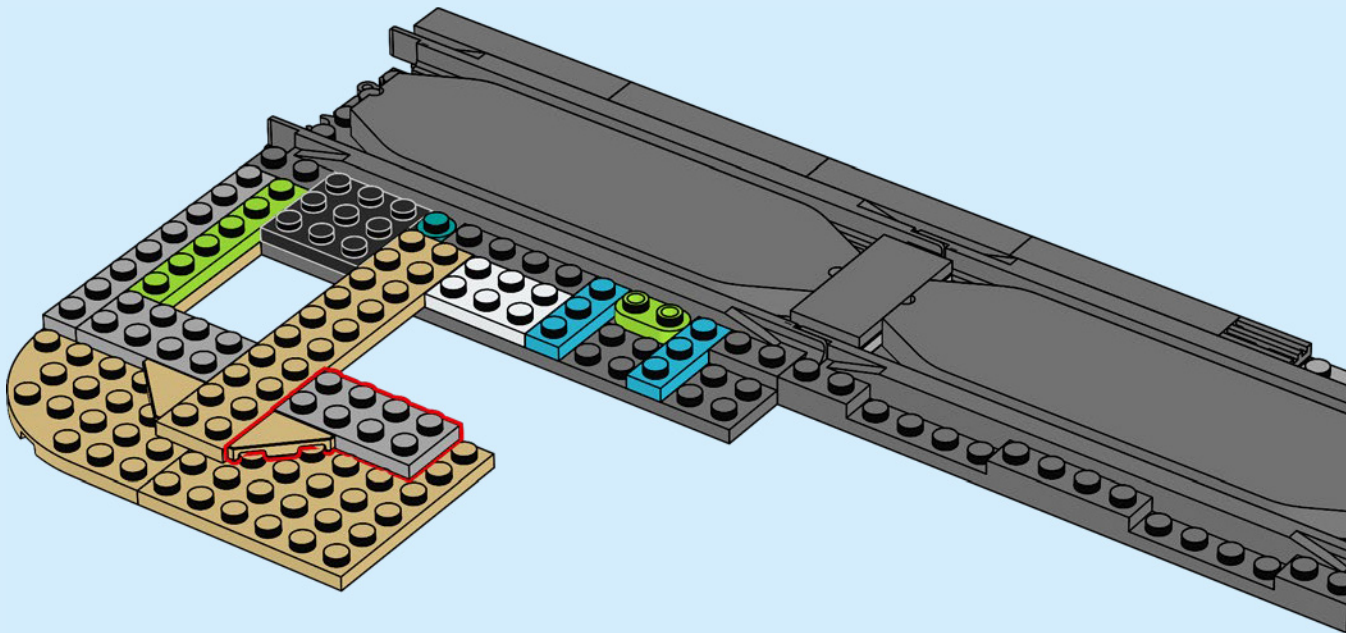

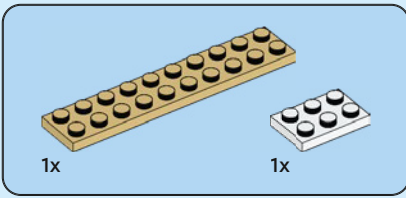

38

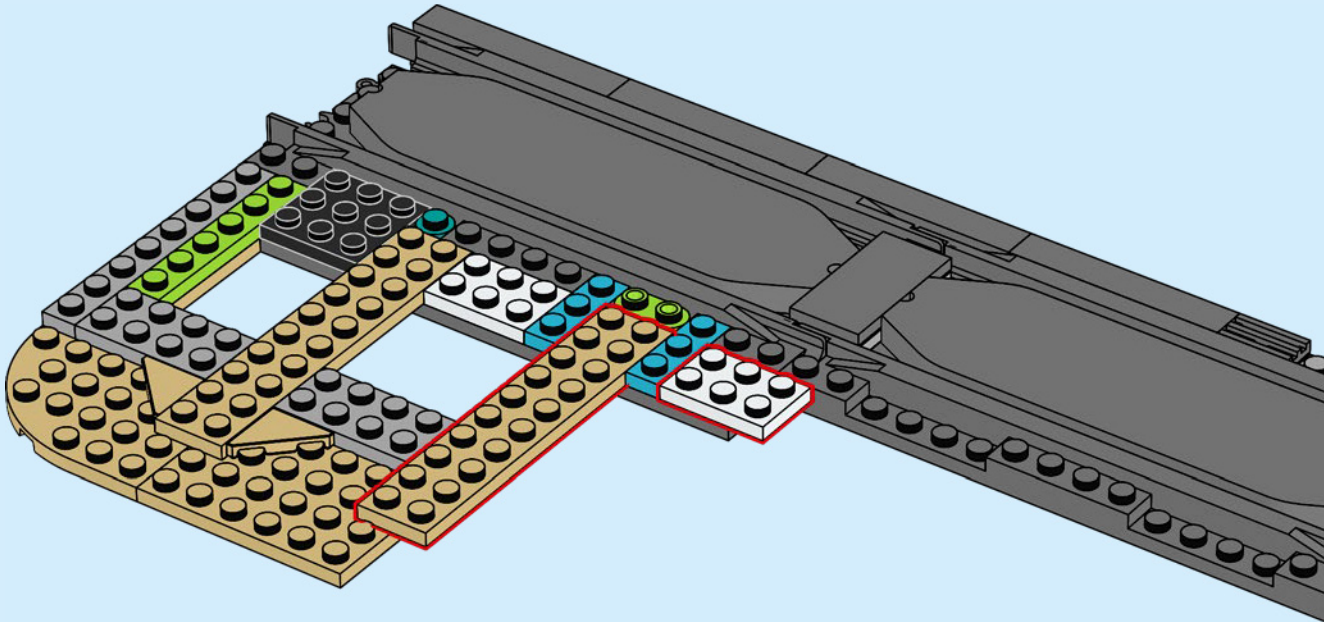

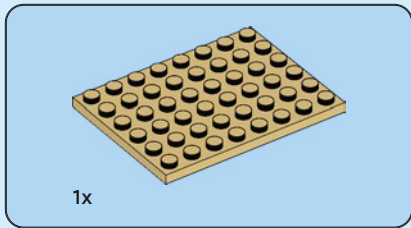

39

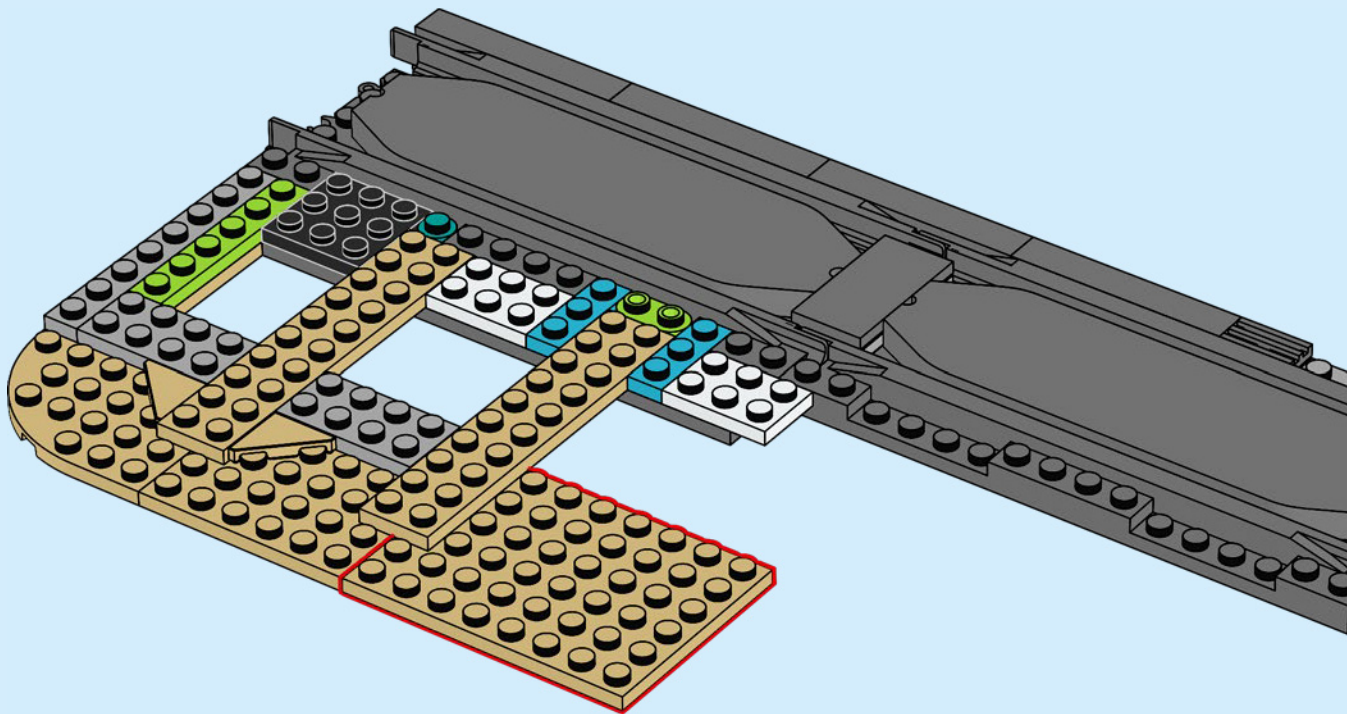

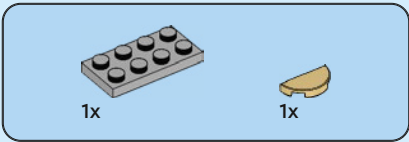

40

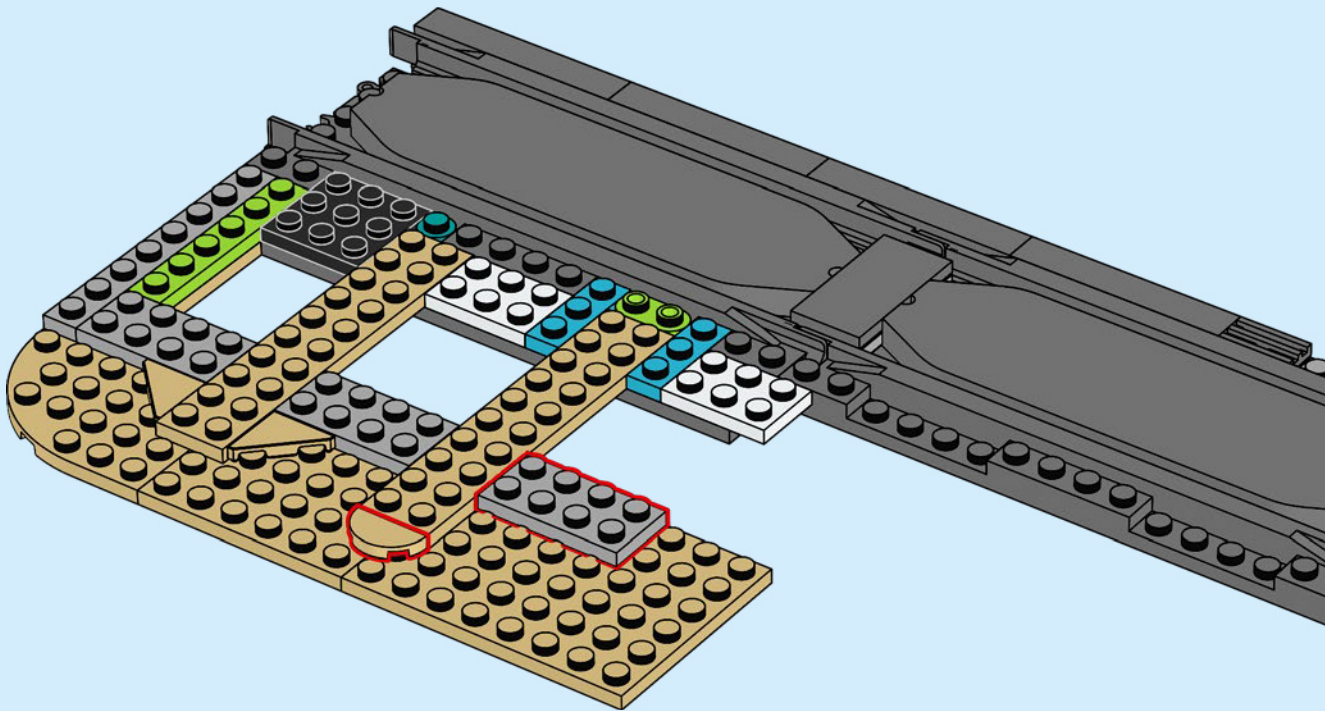

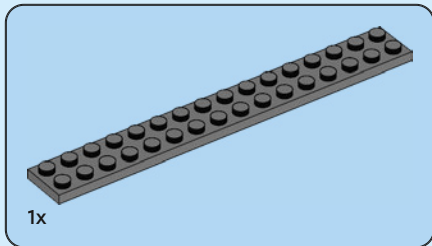

41

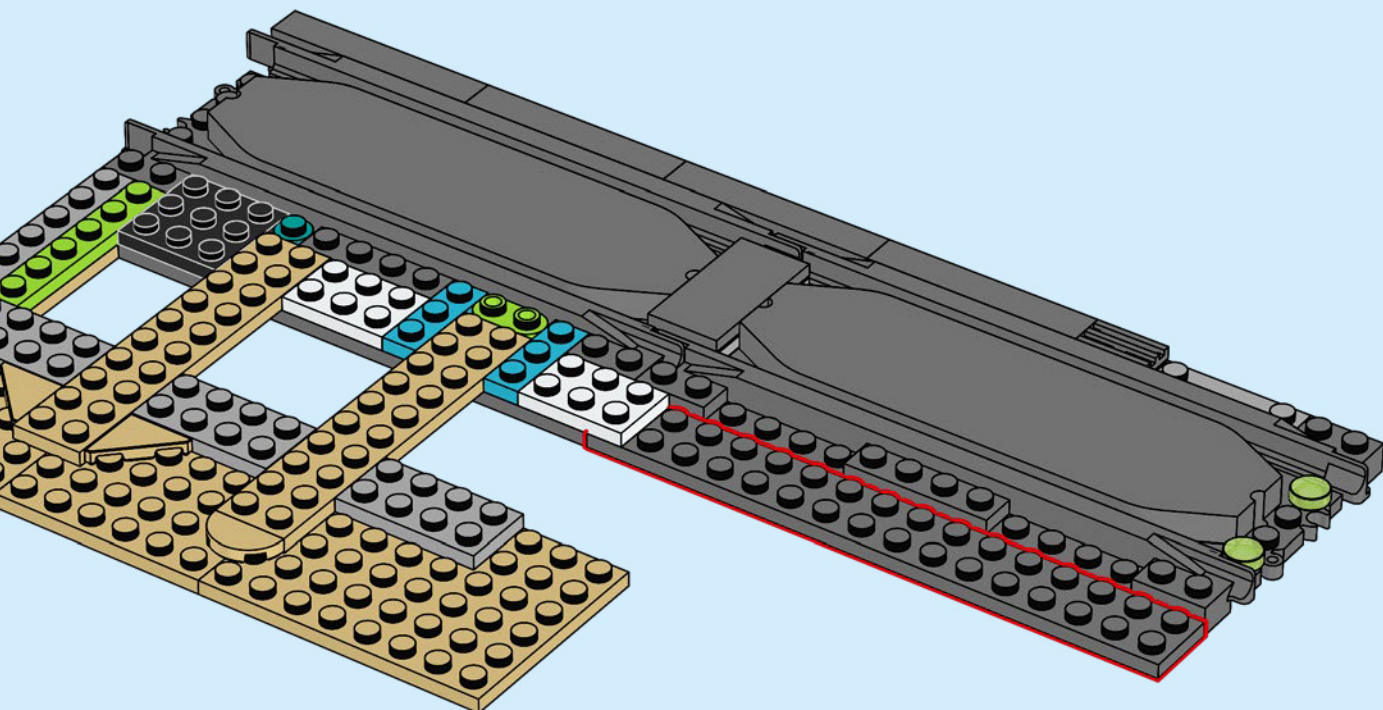

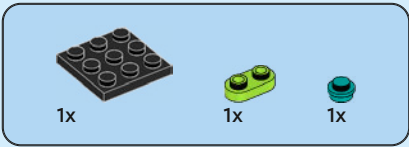

42

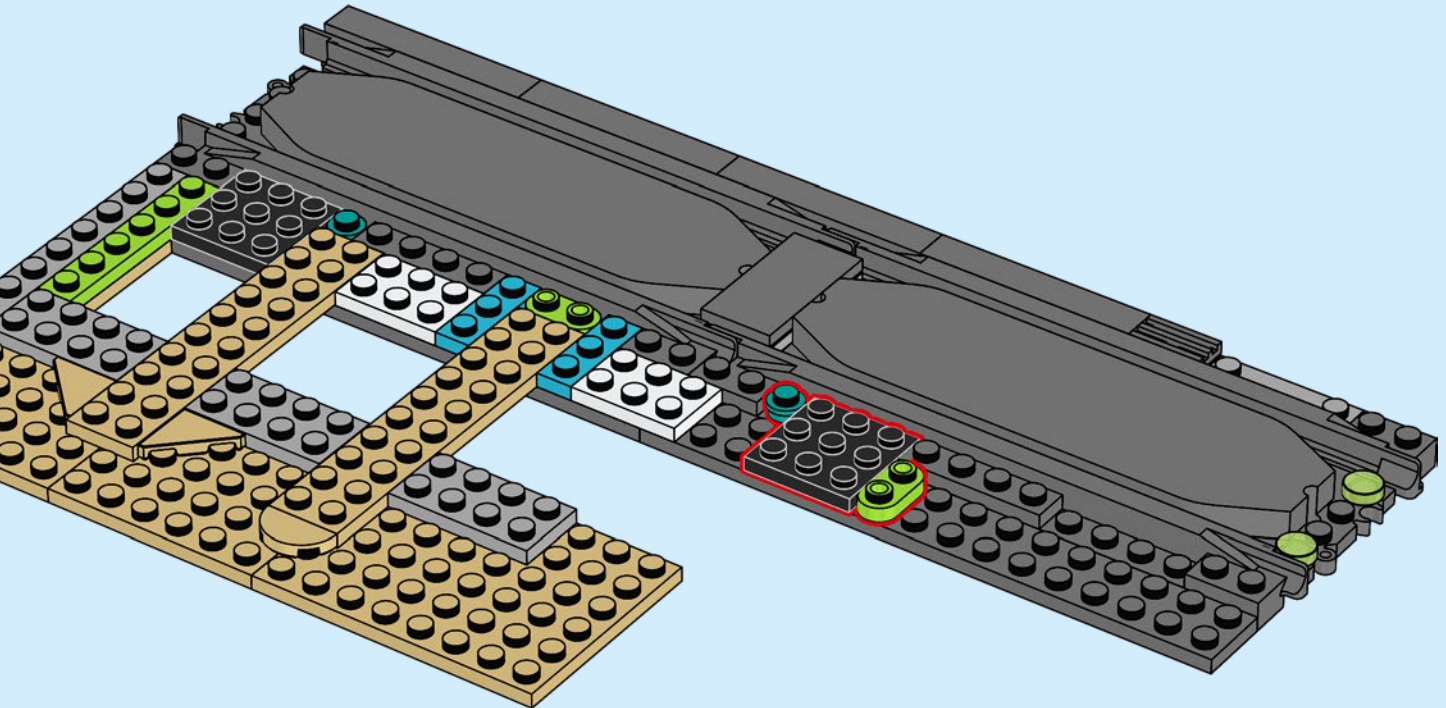

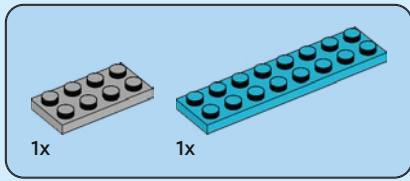

43

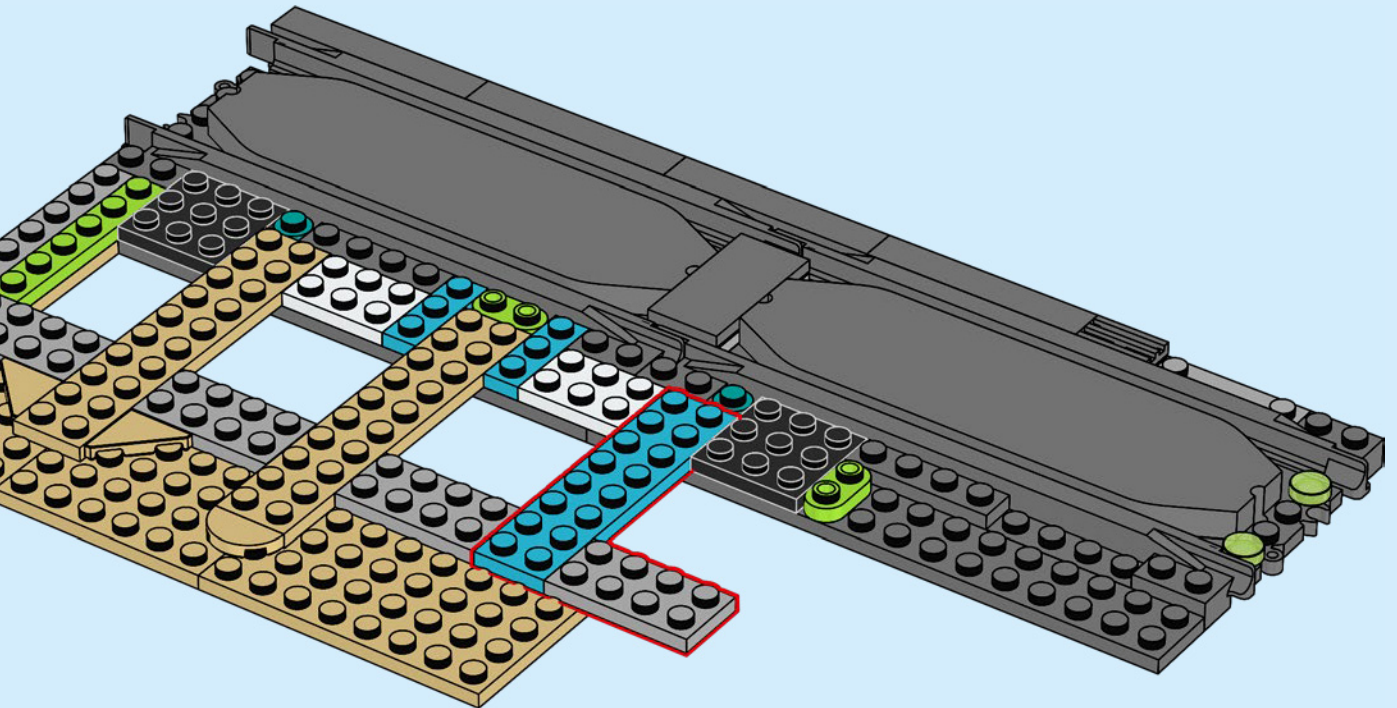

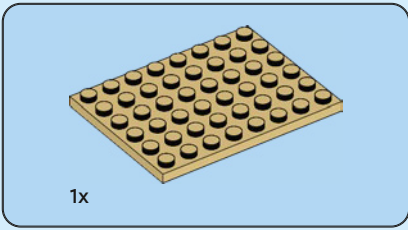

44

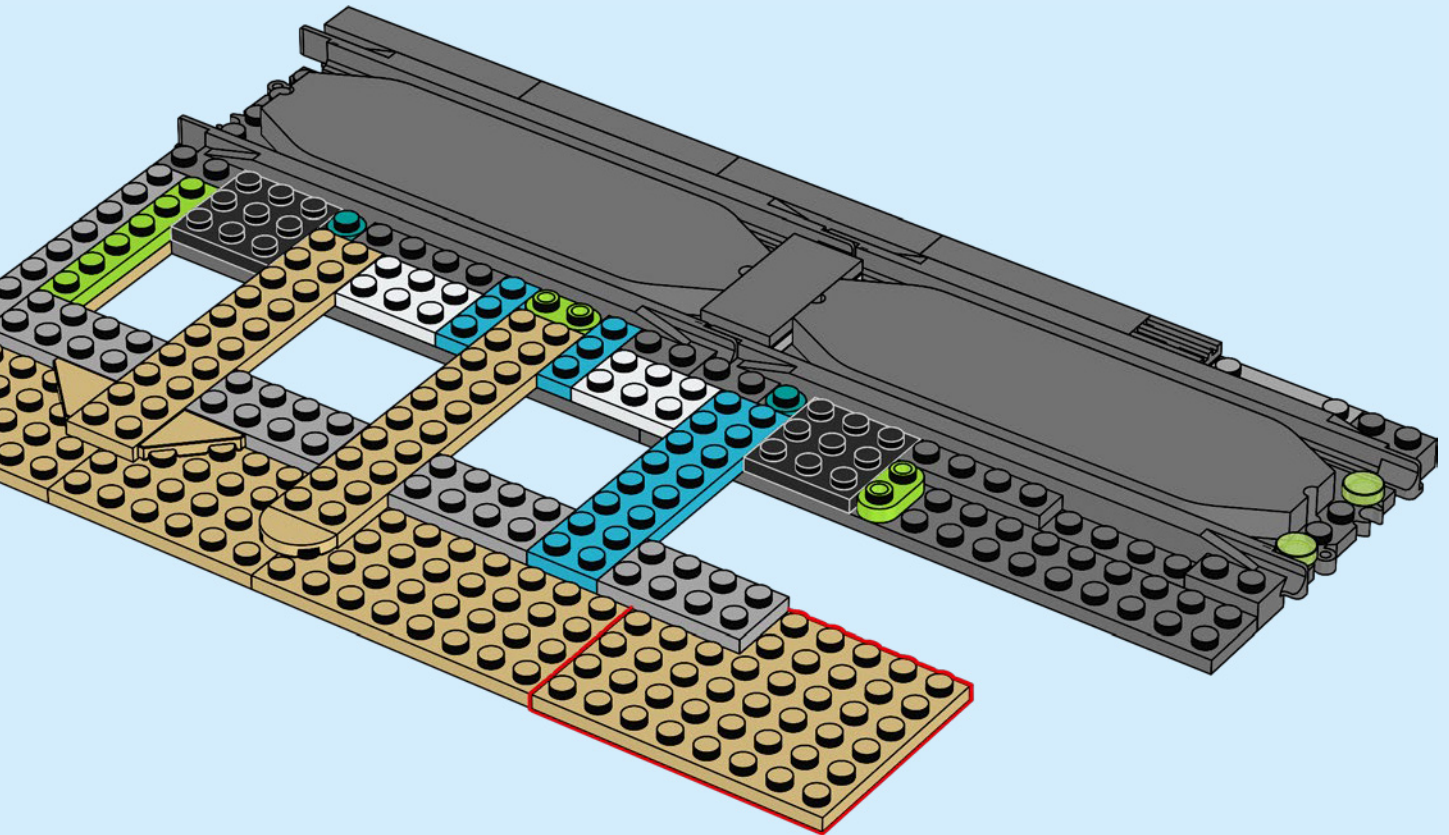

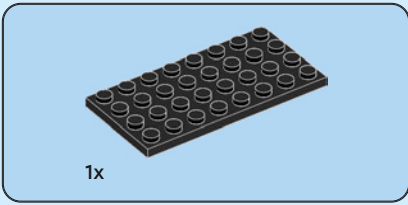

45

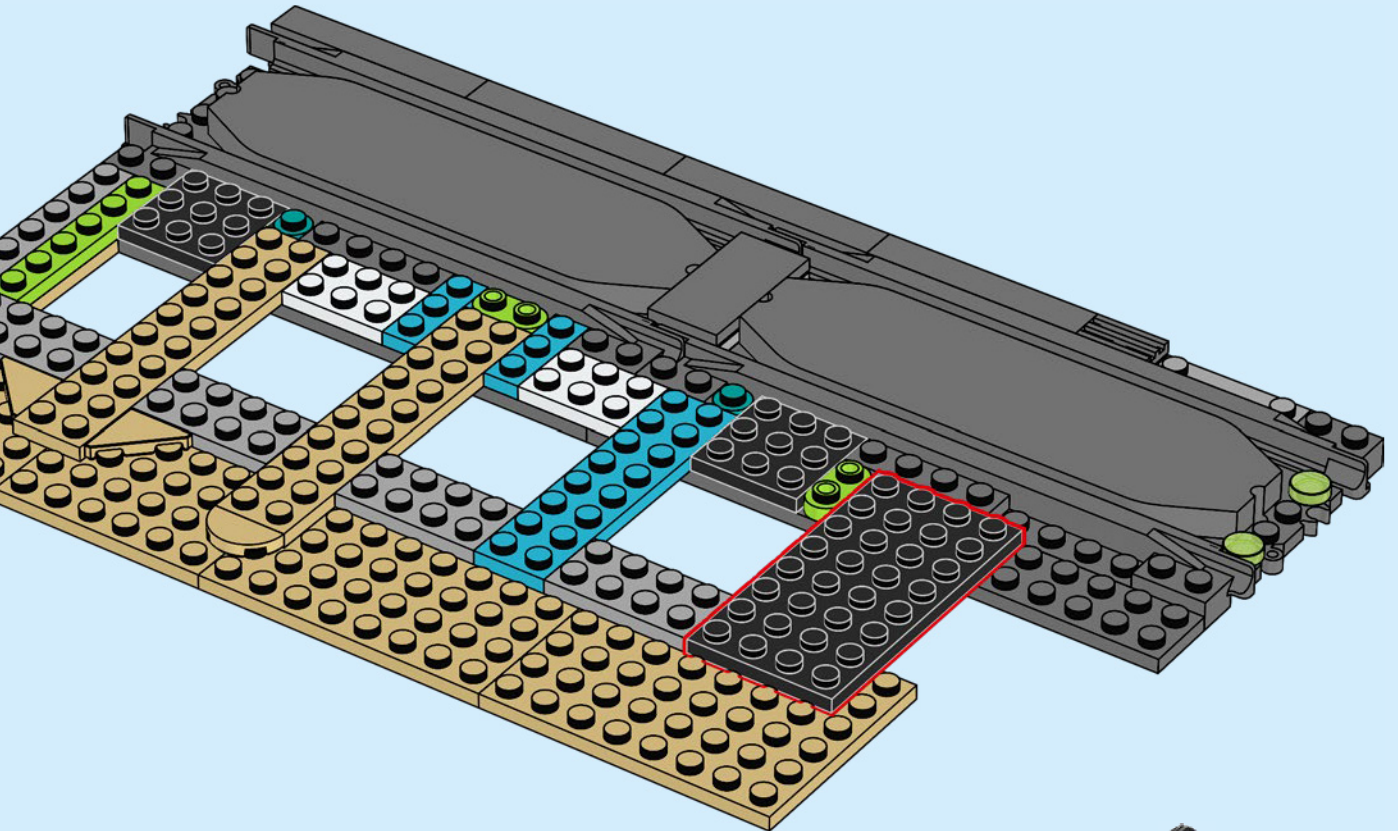

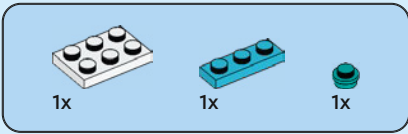

46

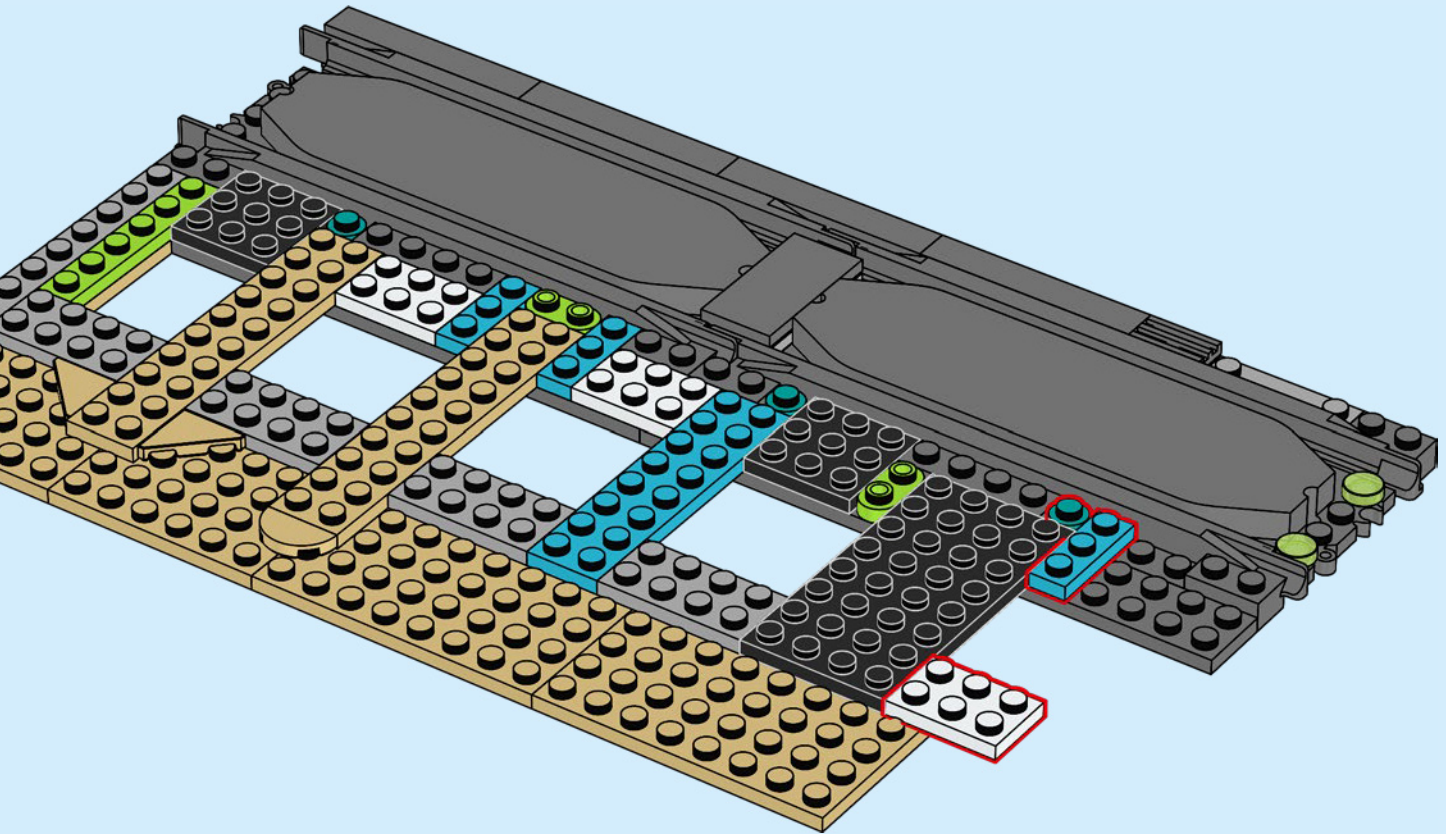

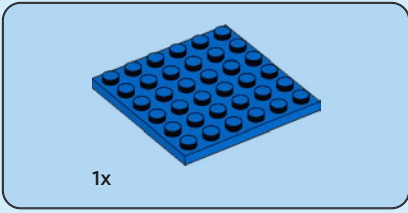

47

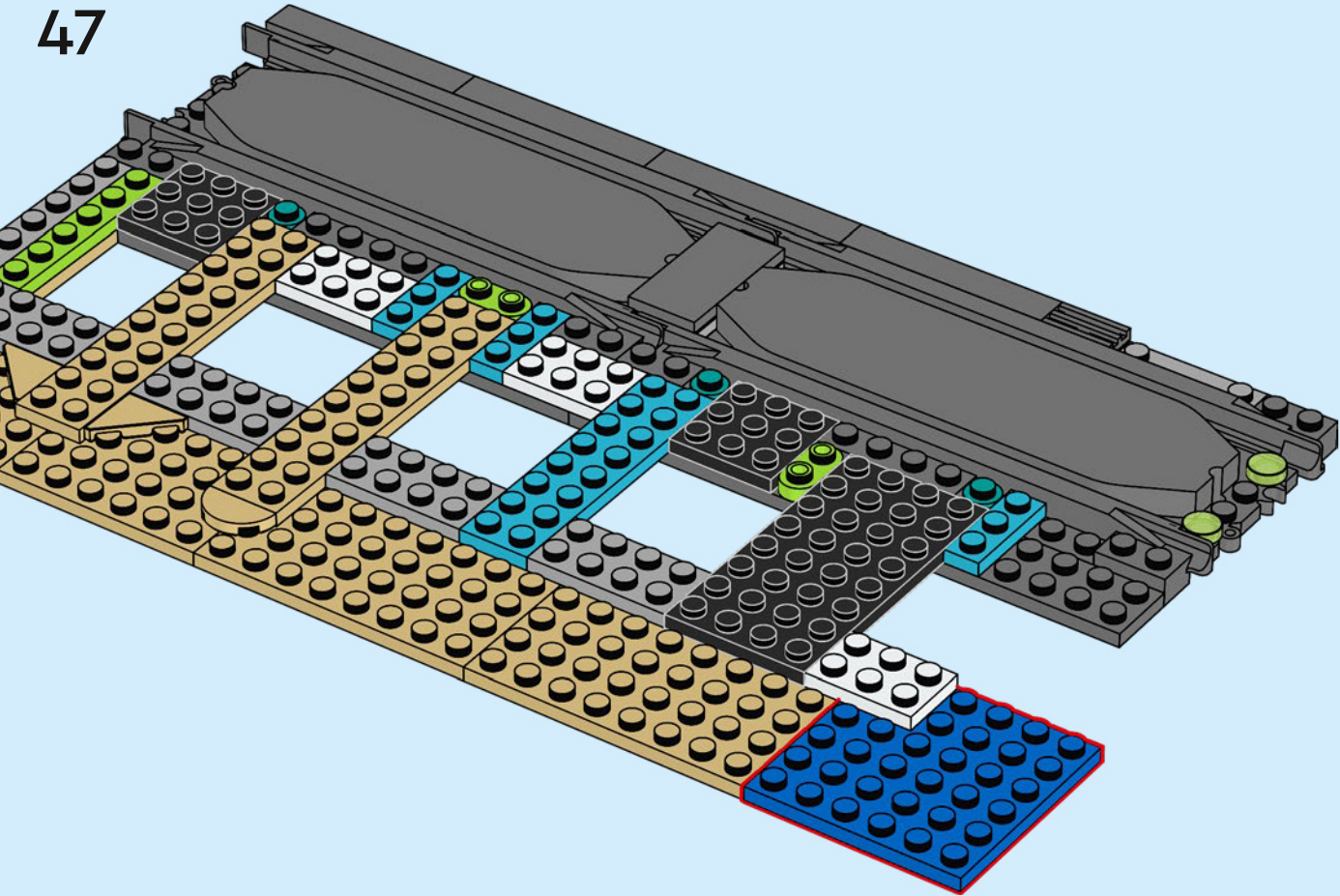

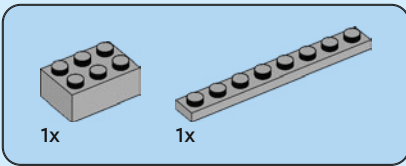

48

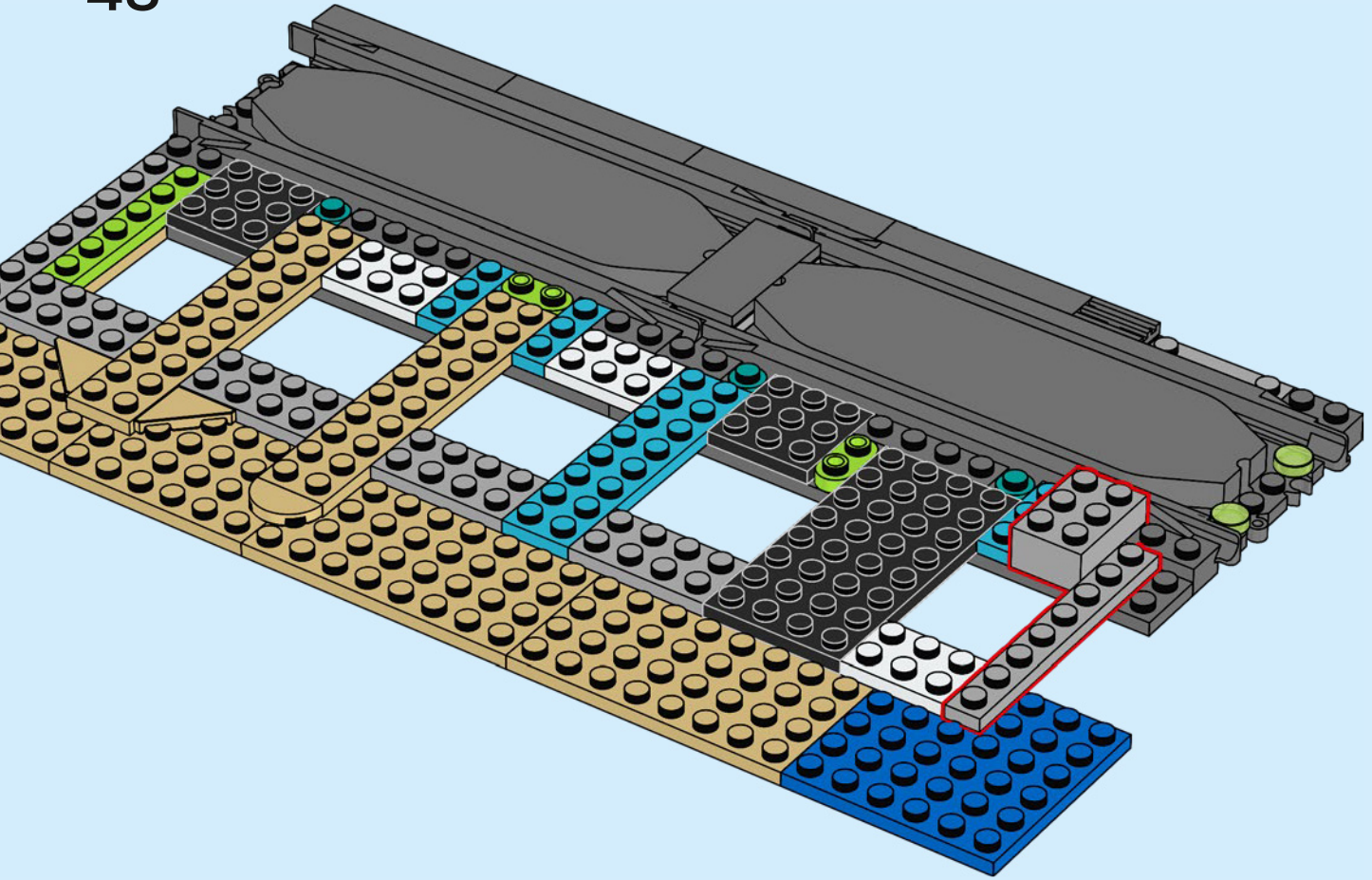



1x

49

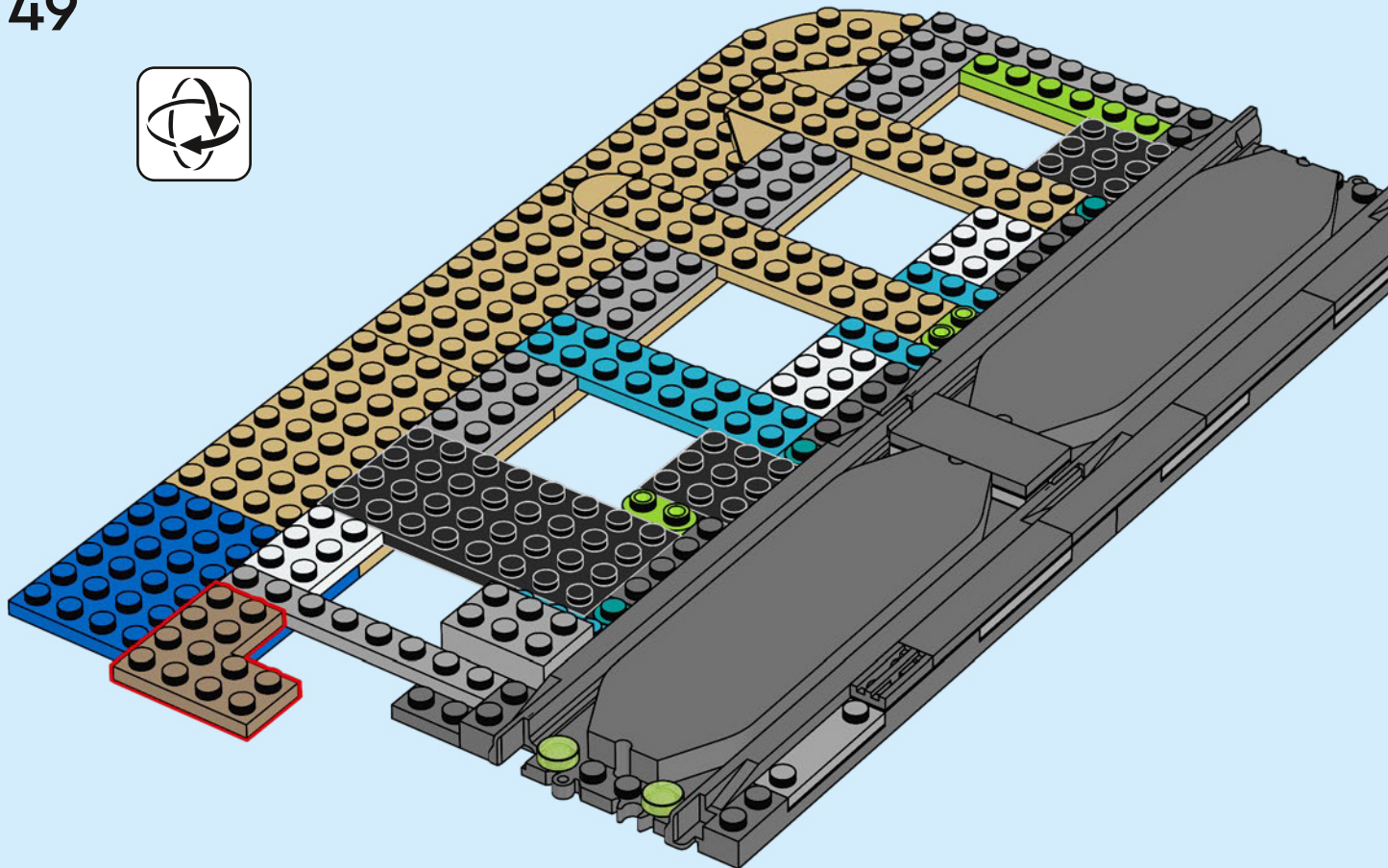

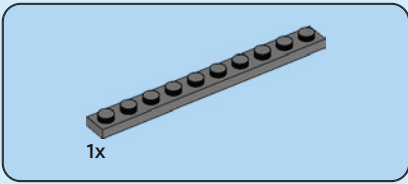

50

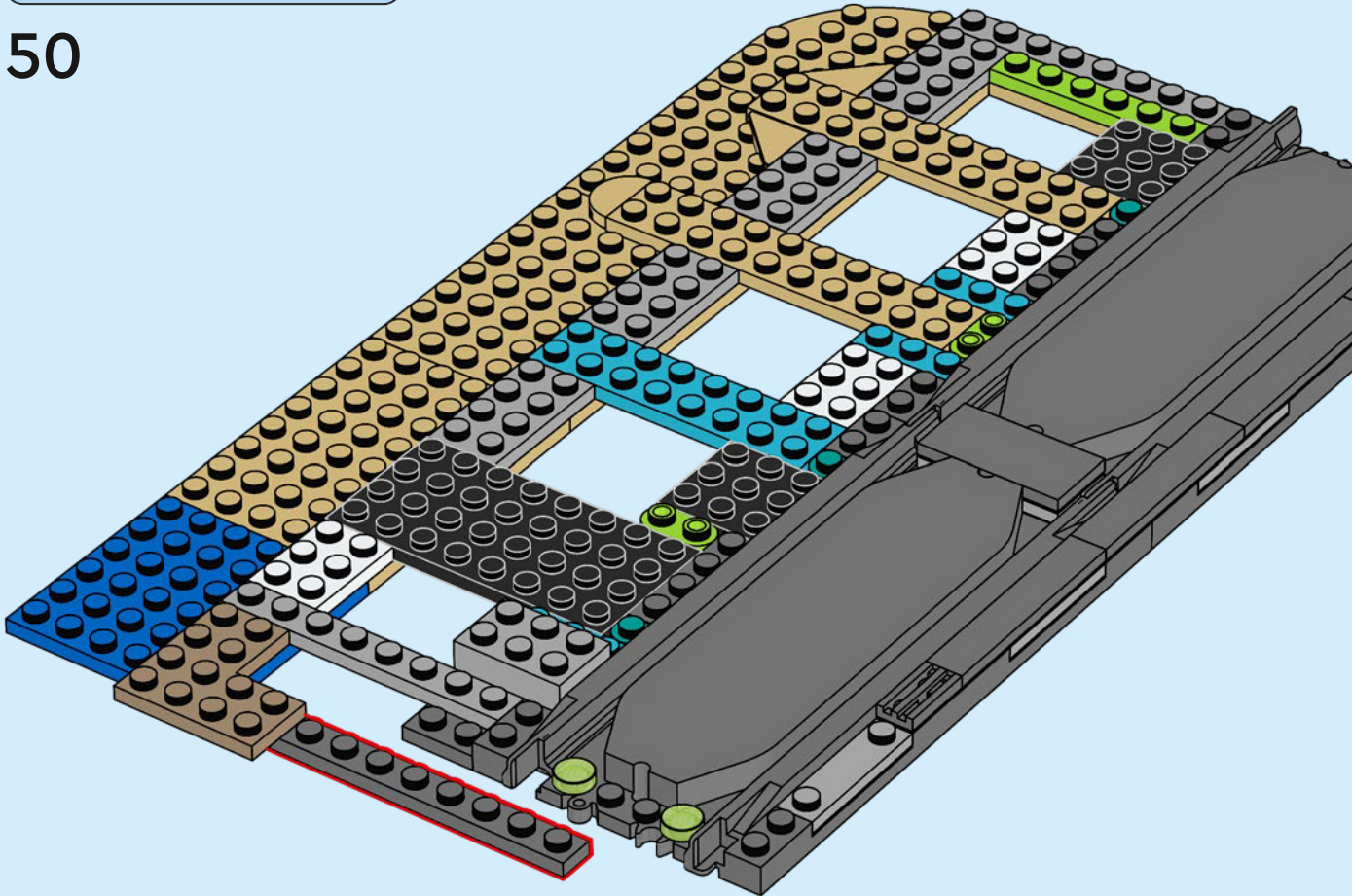



1x

51

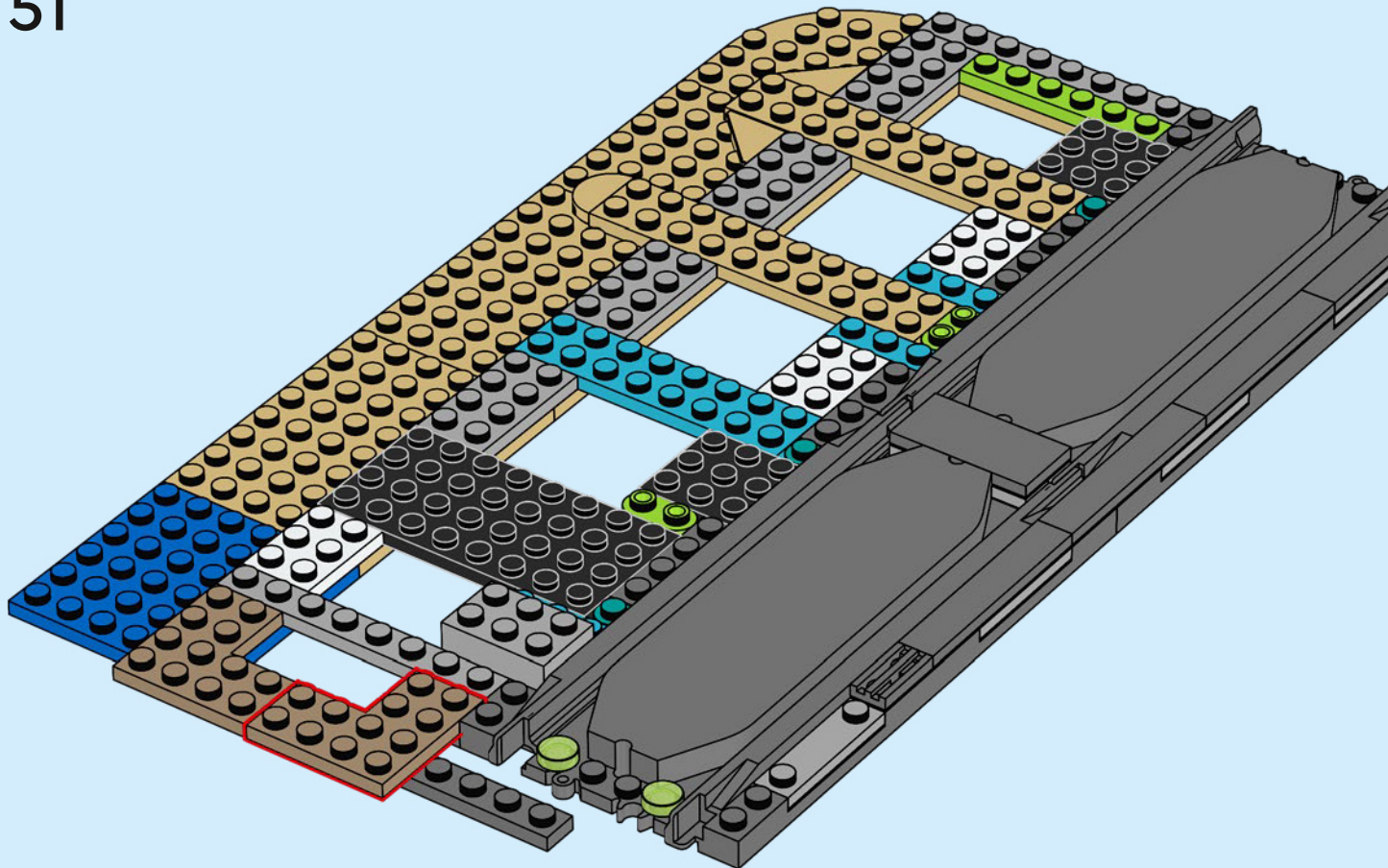

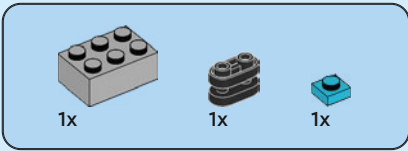

52

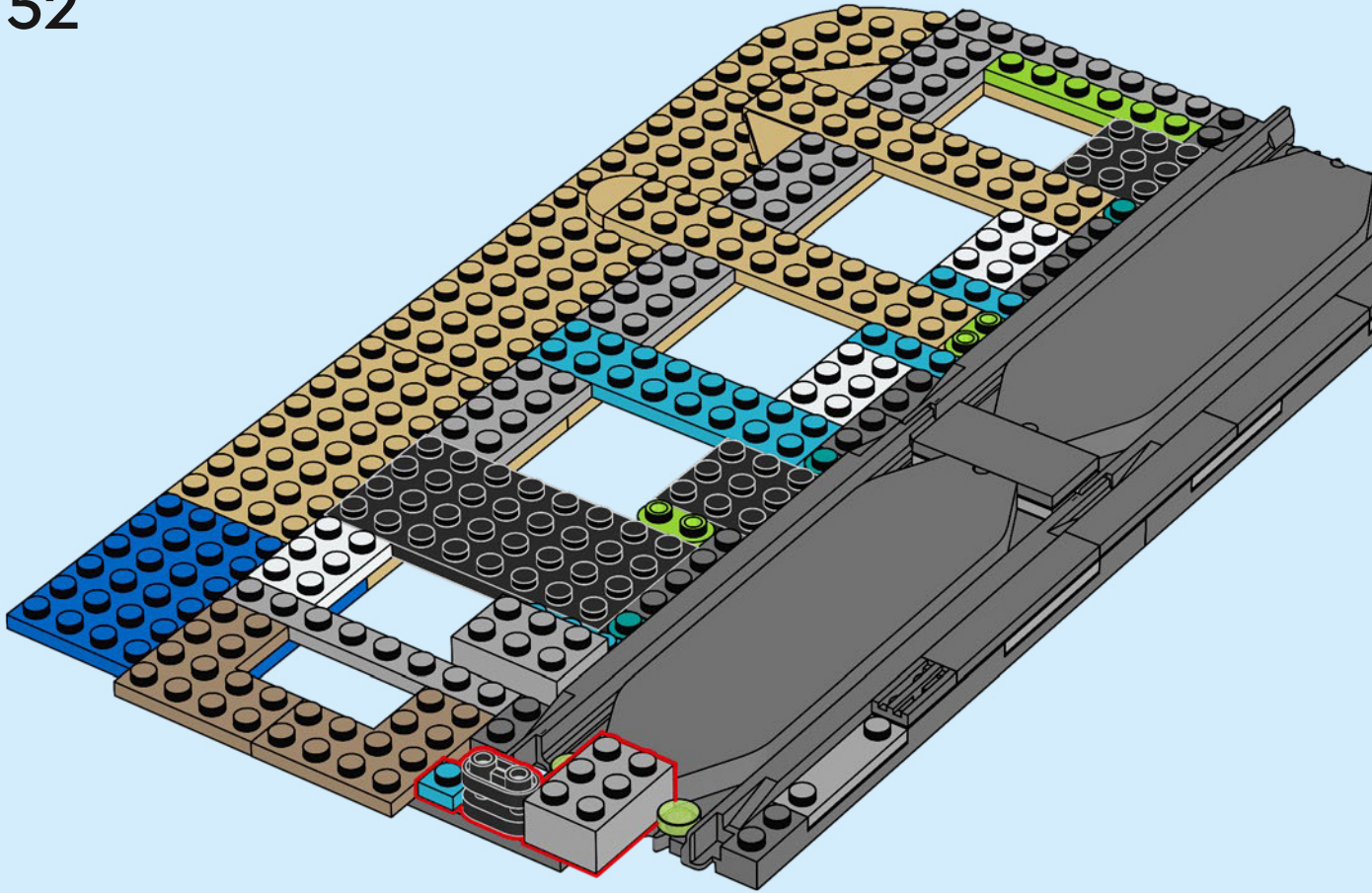

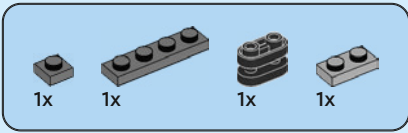

53

1

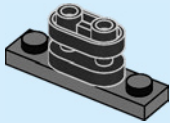

2

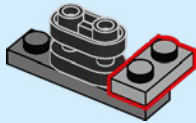

3

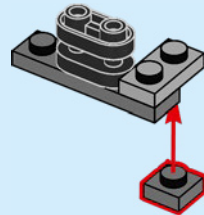

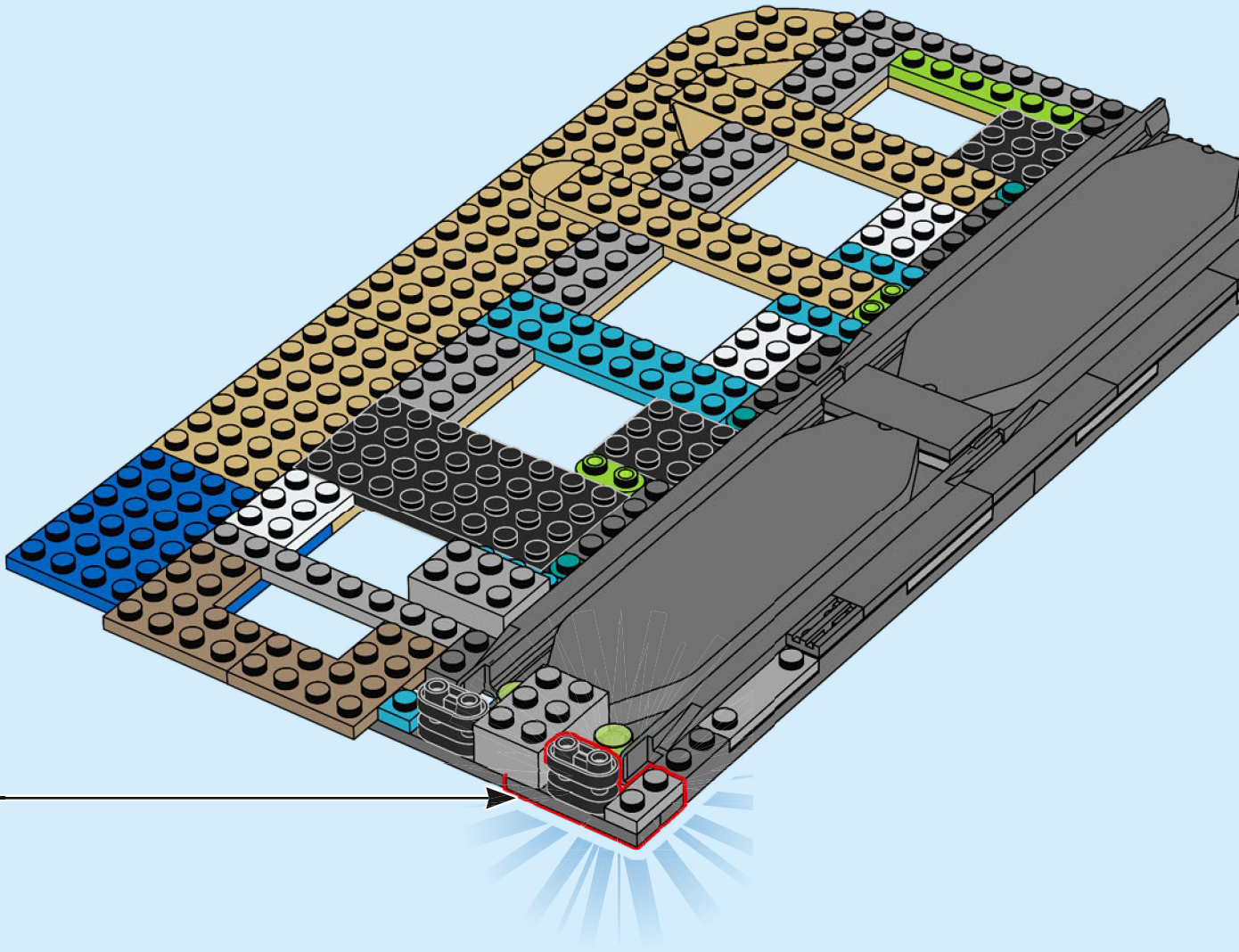

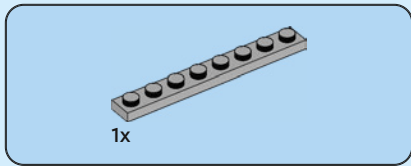

54

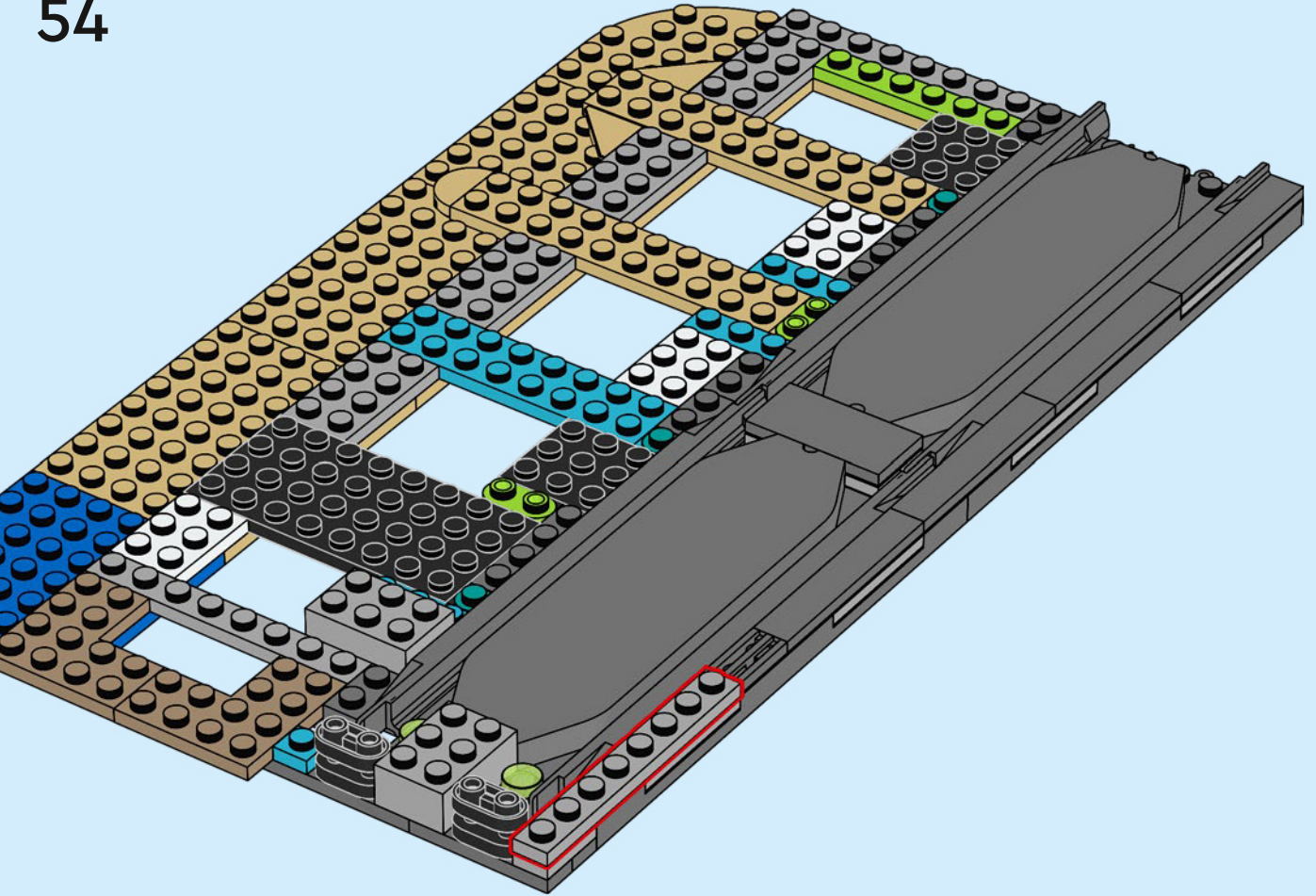

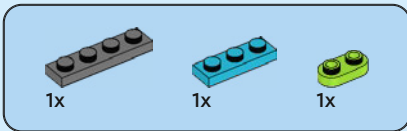

55

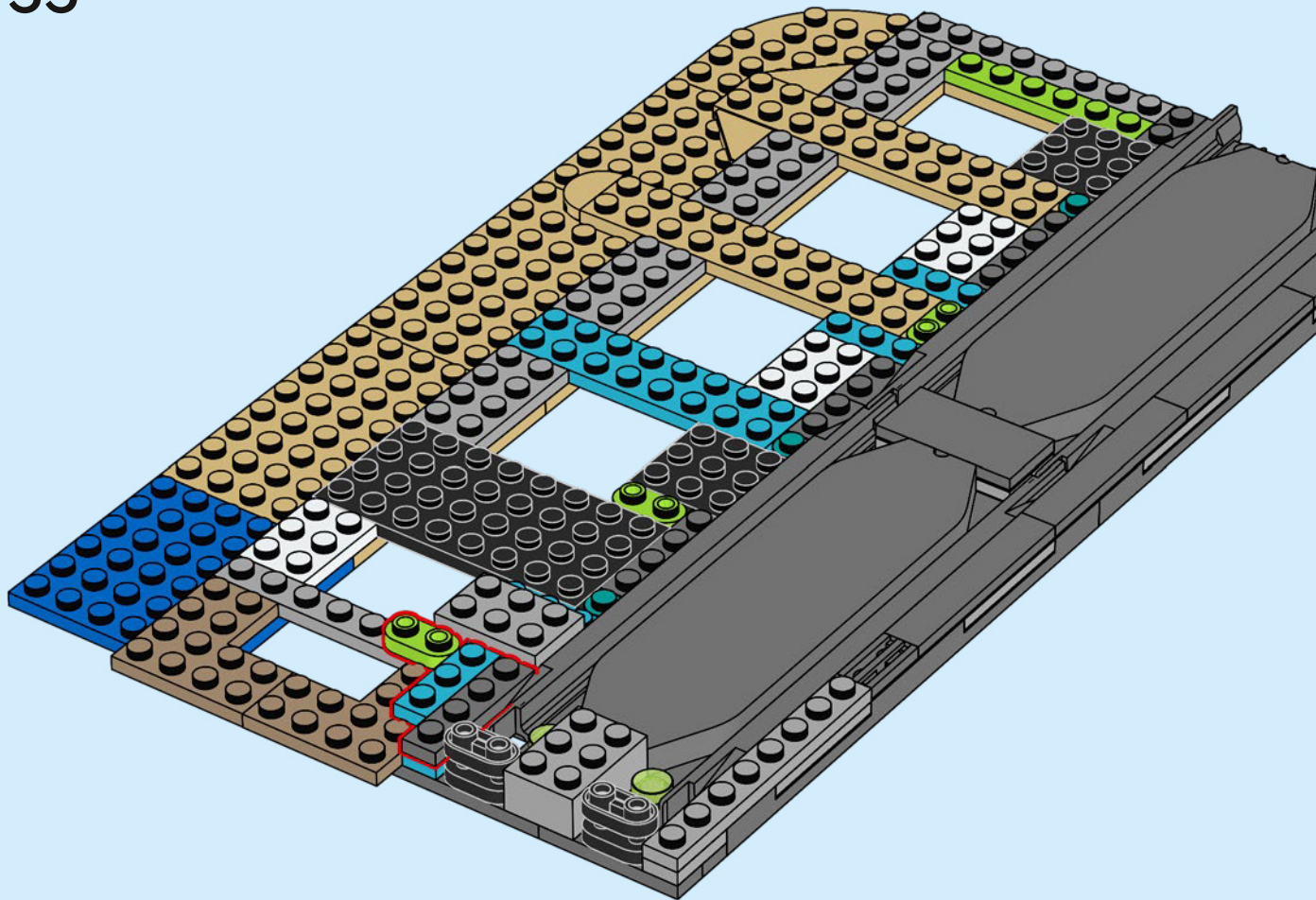

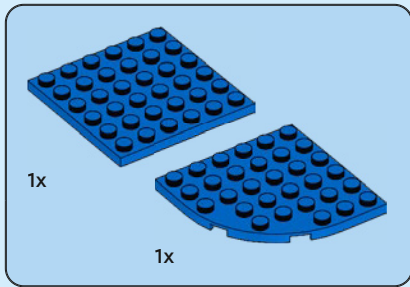

56

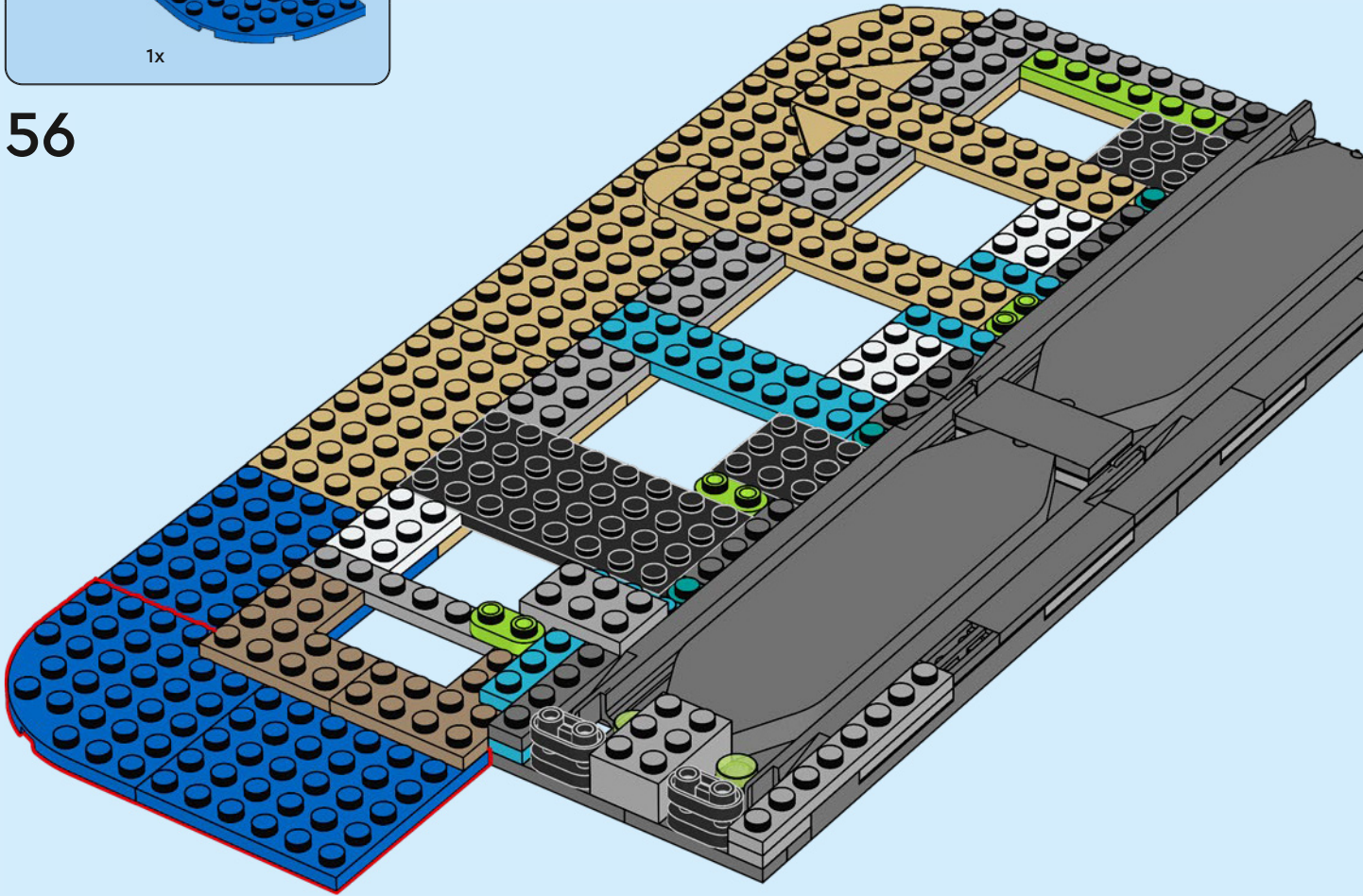

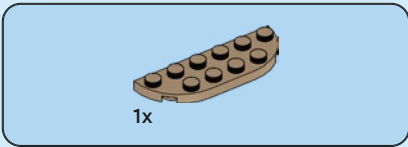

57

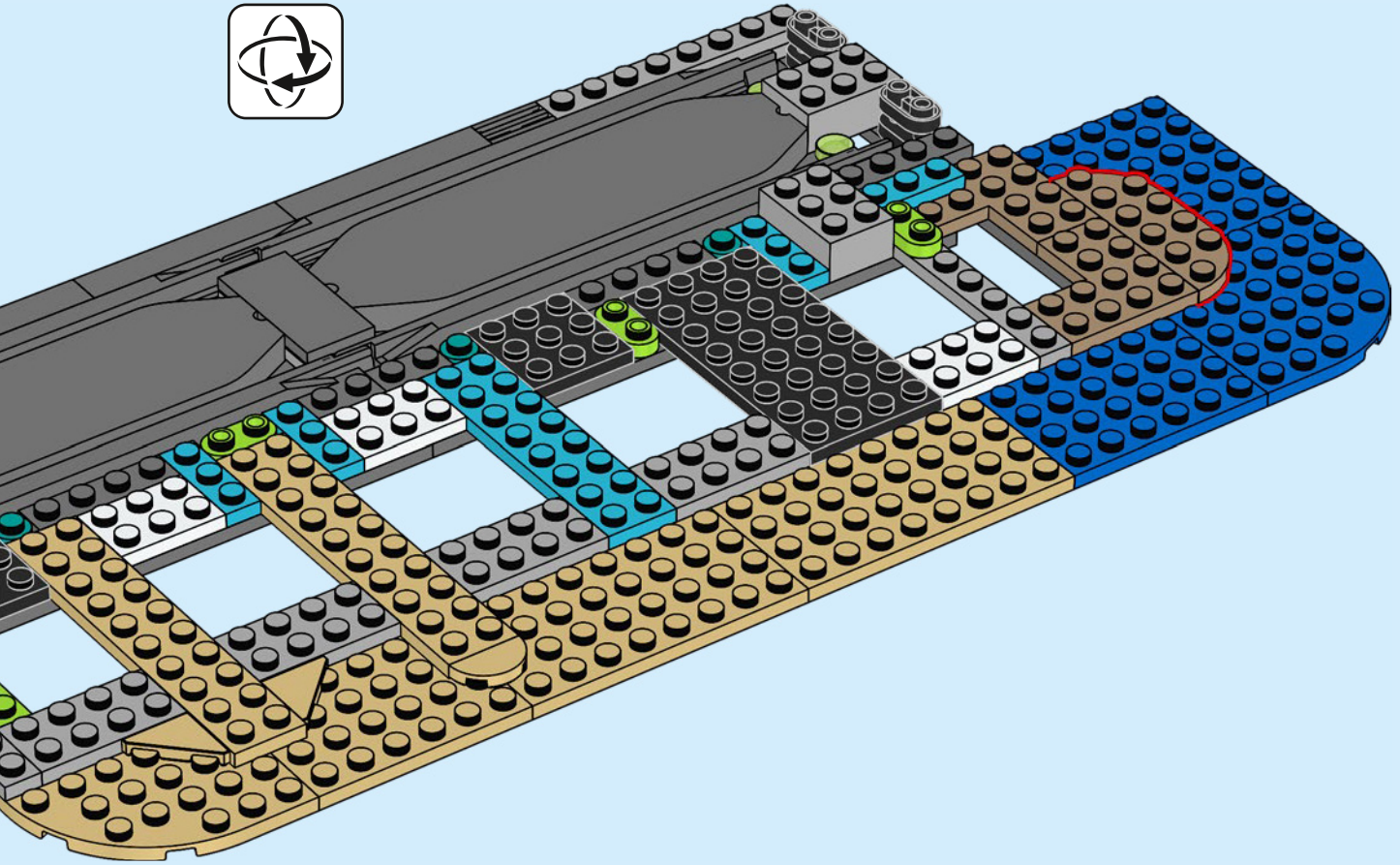

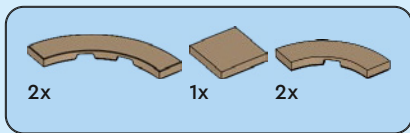

58

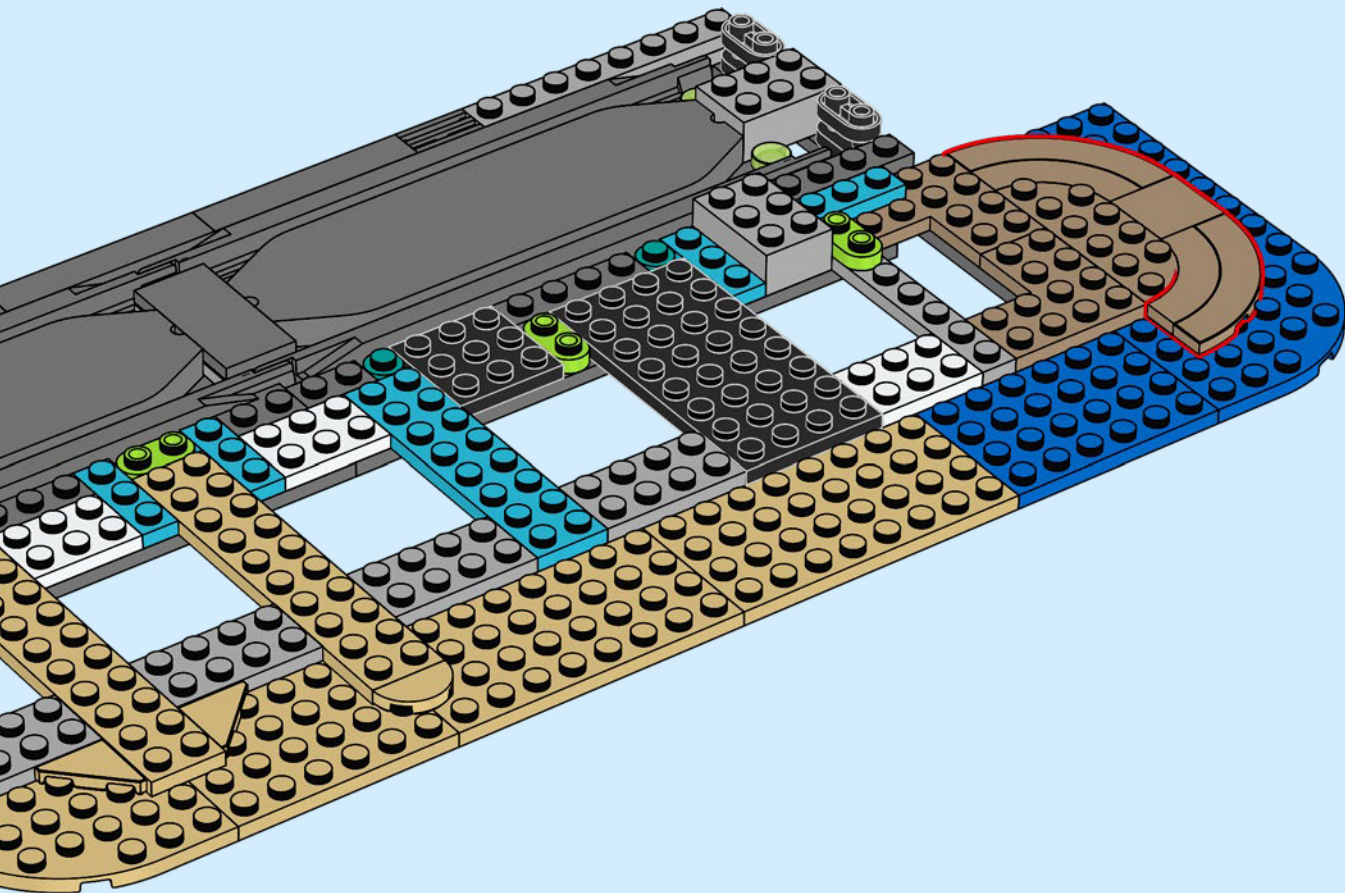

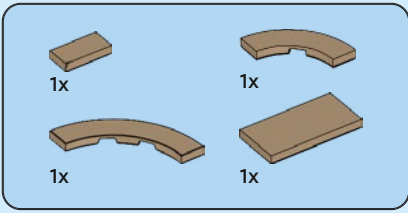

59

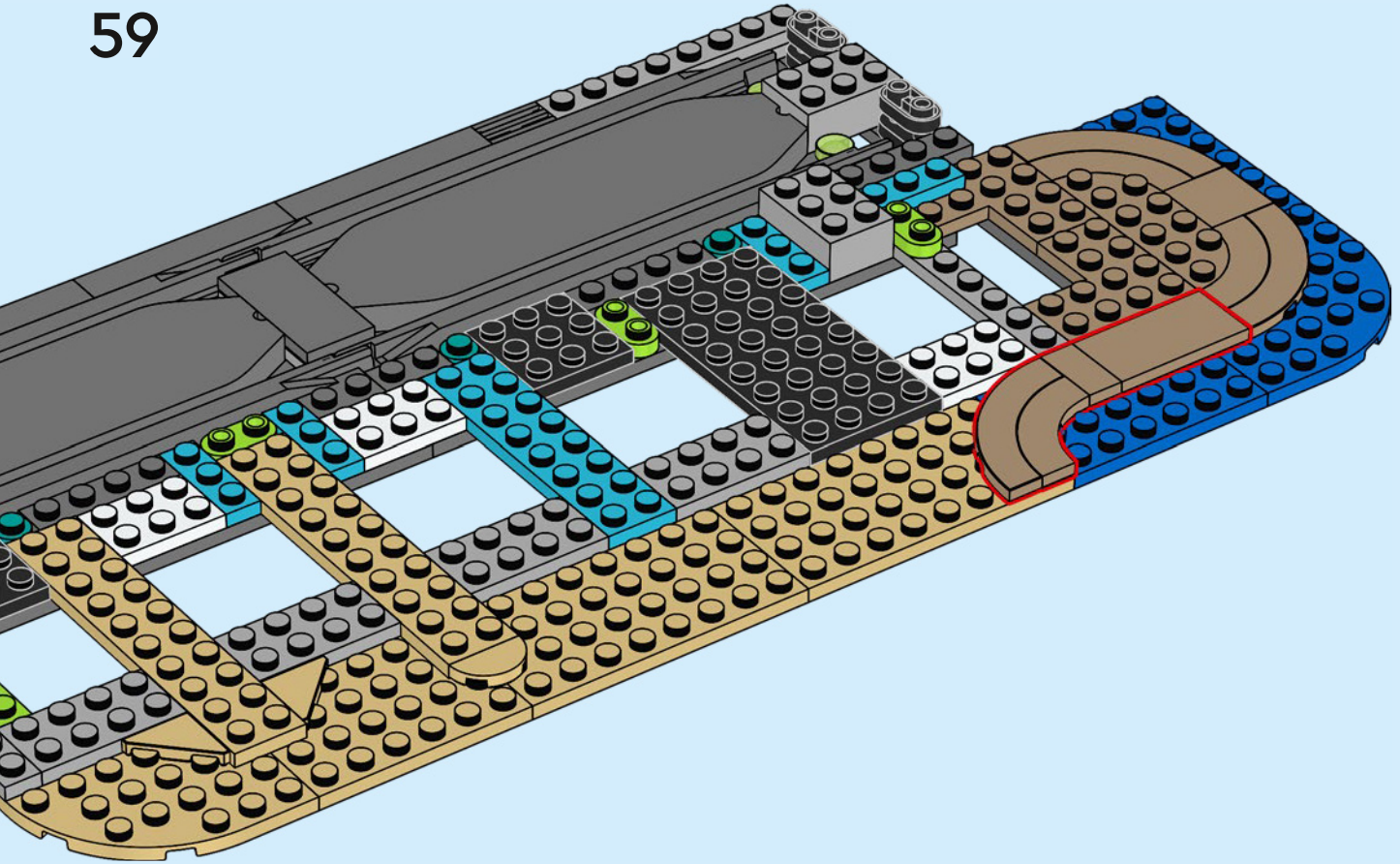

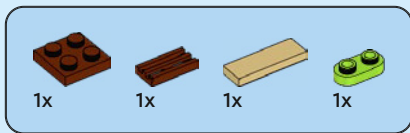

60

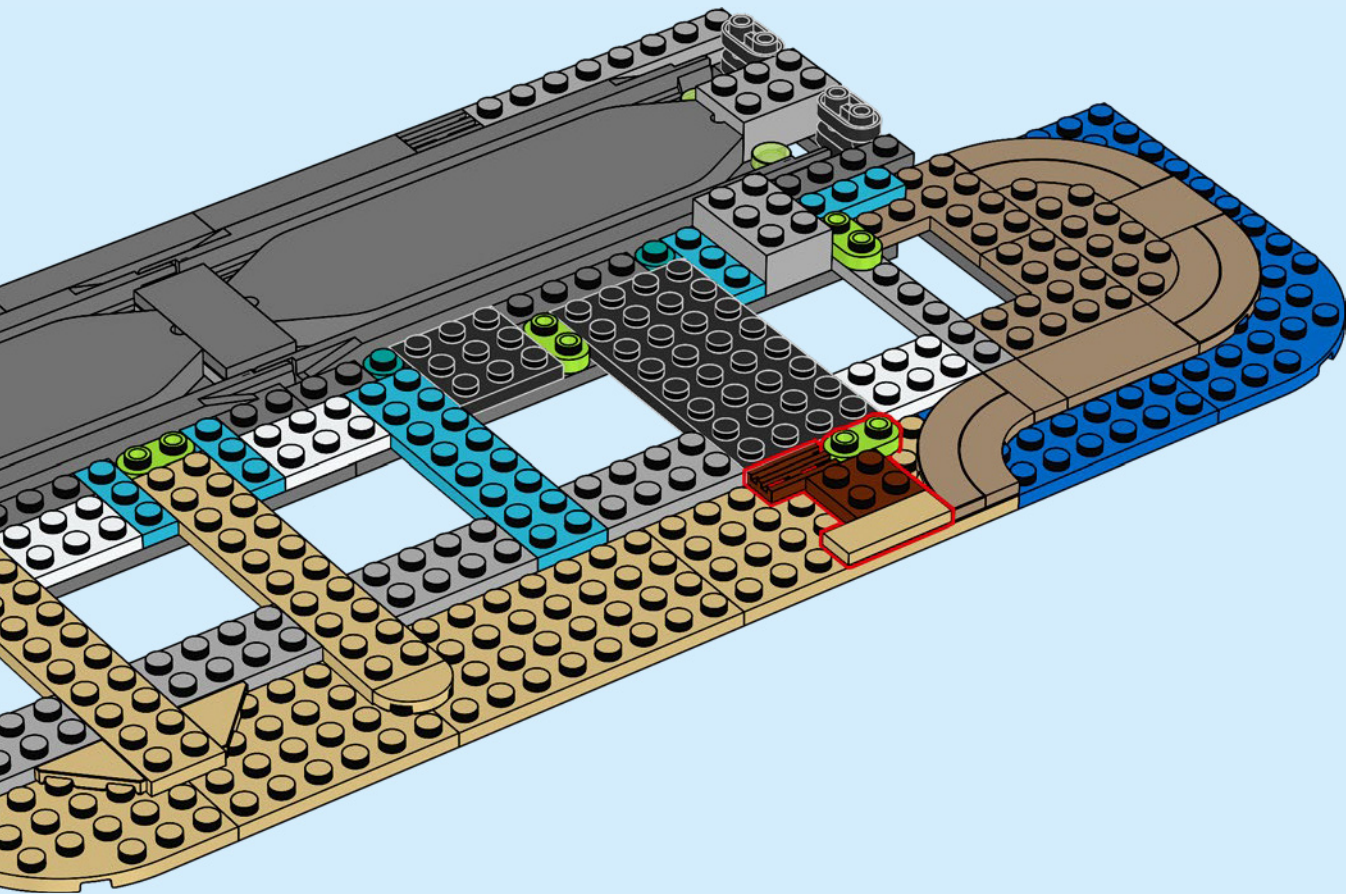



1x



2x

61

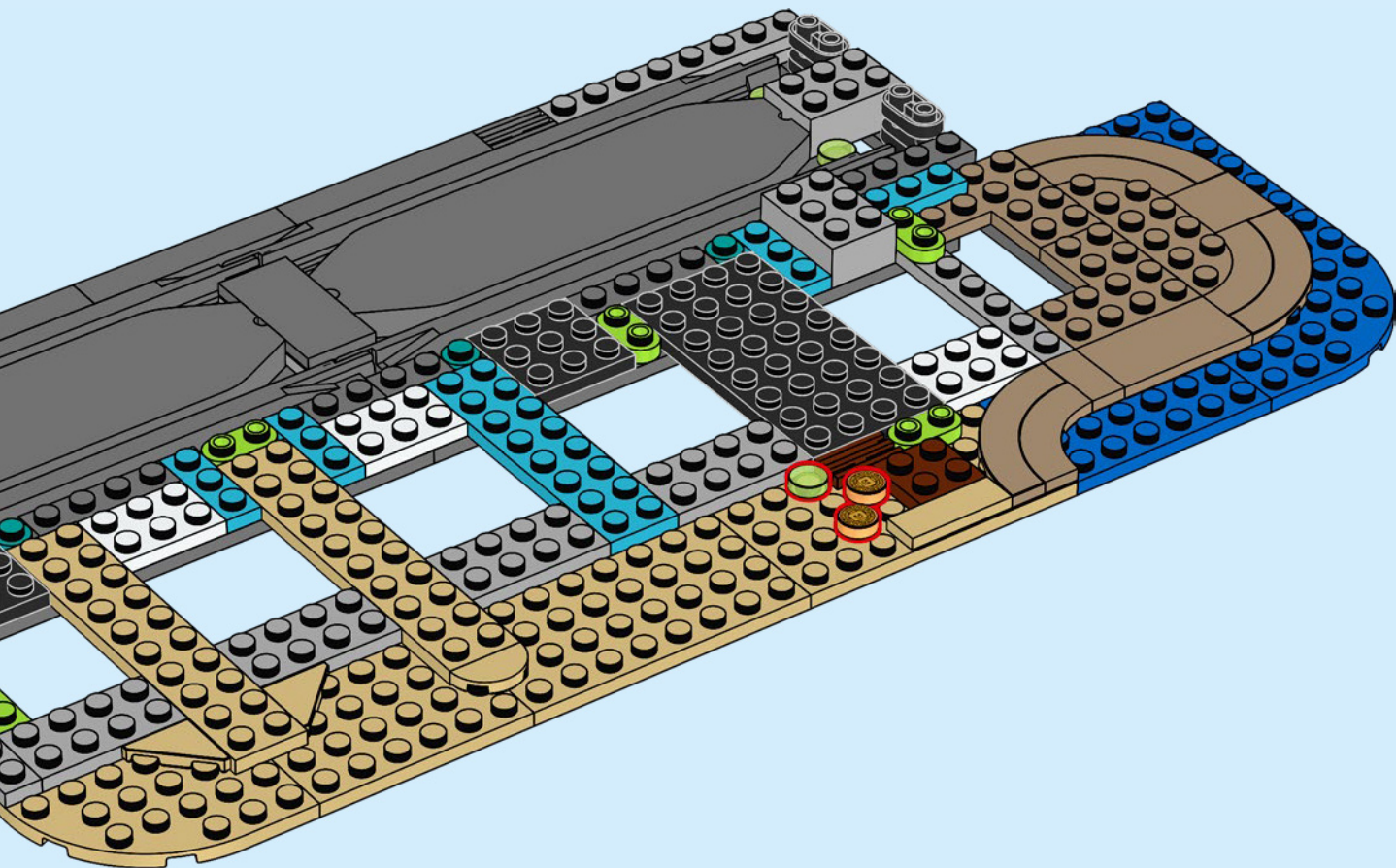

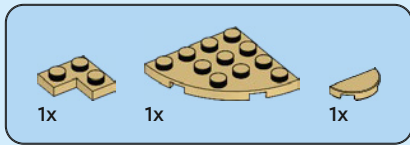

62

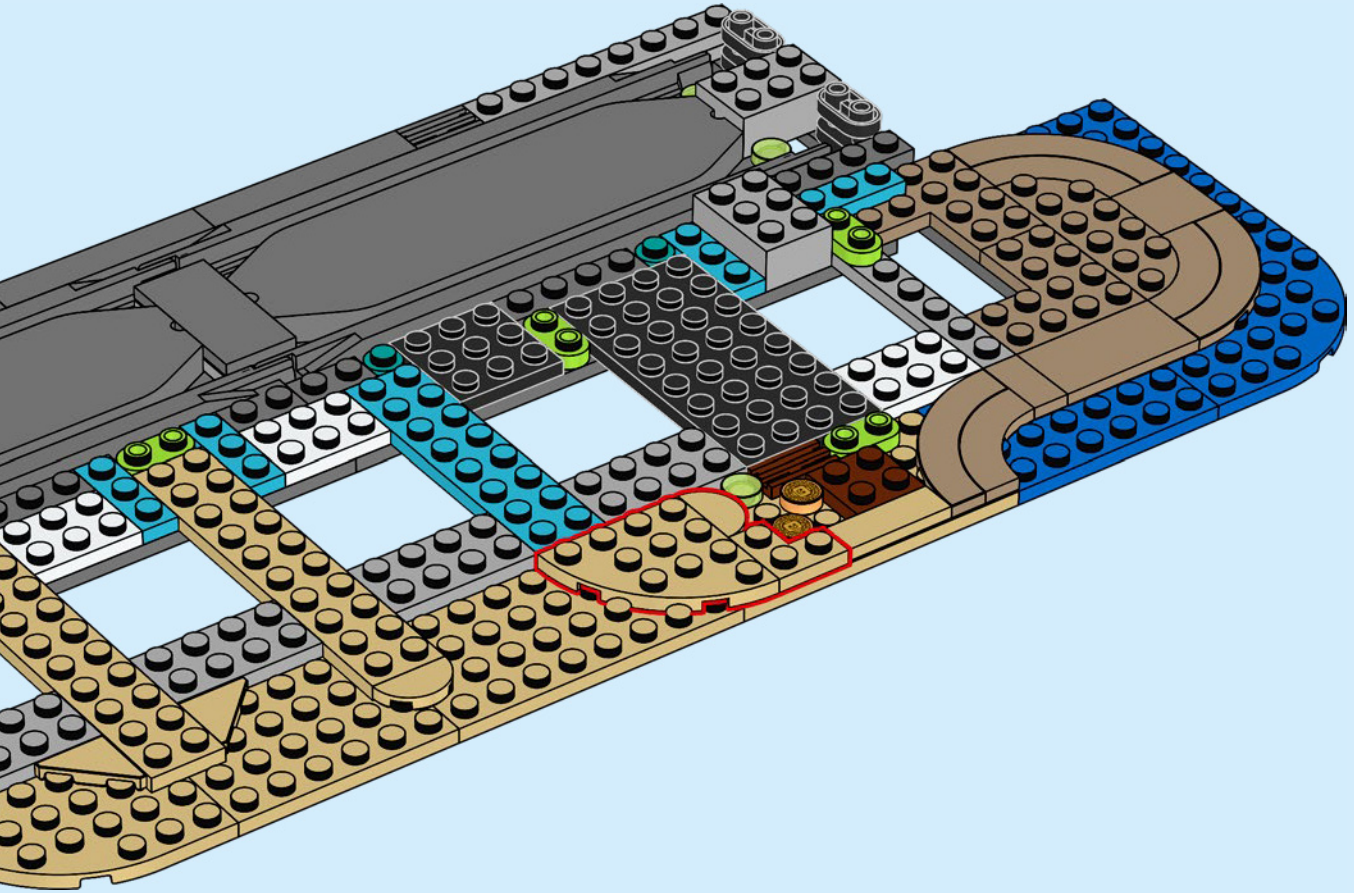

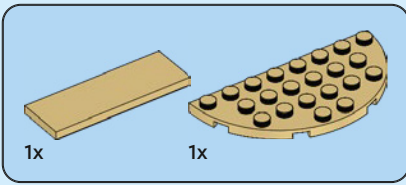

63

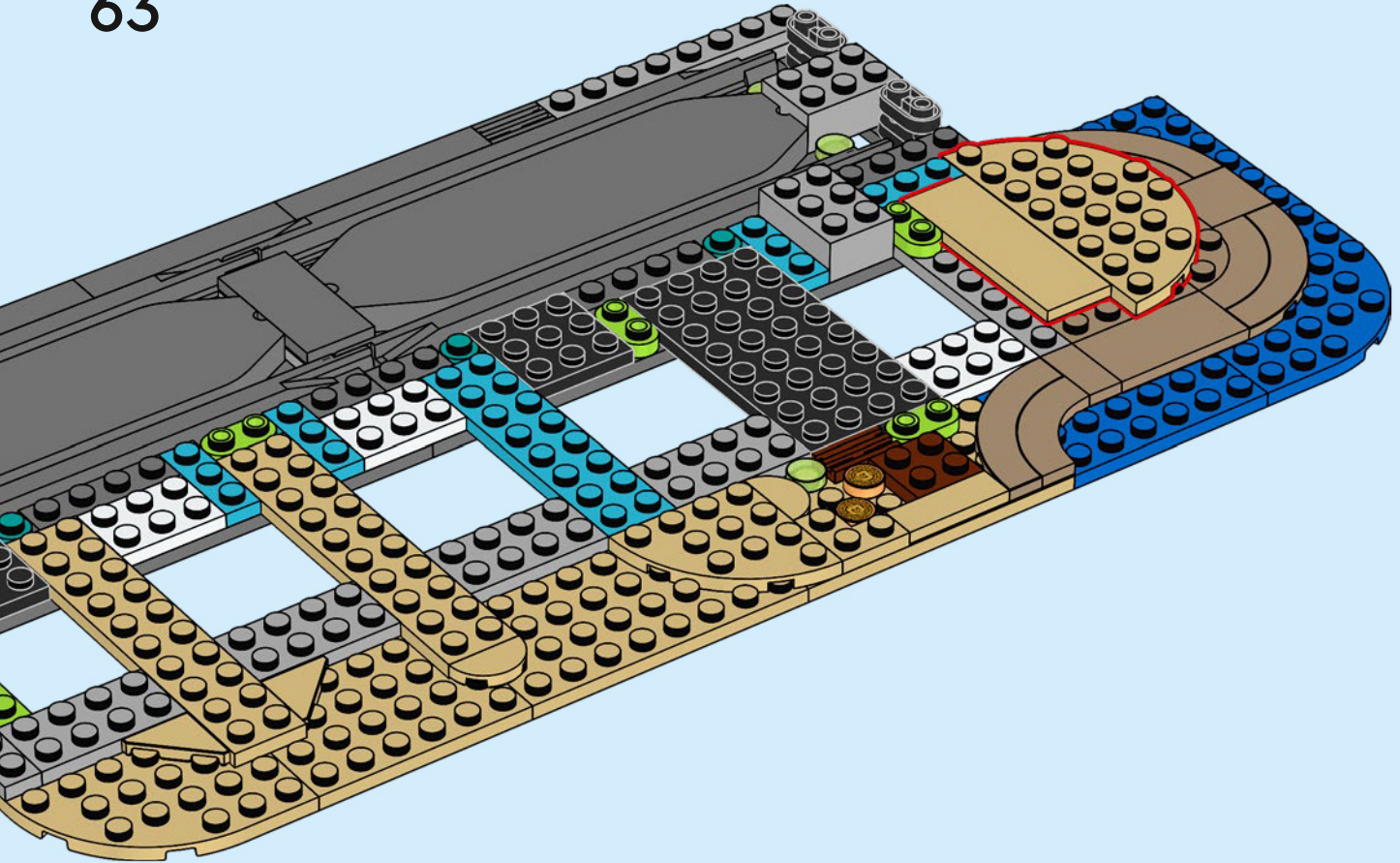

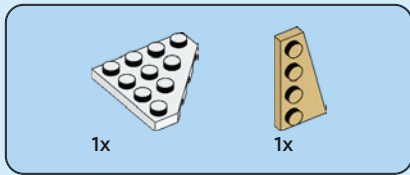

64

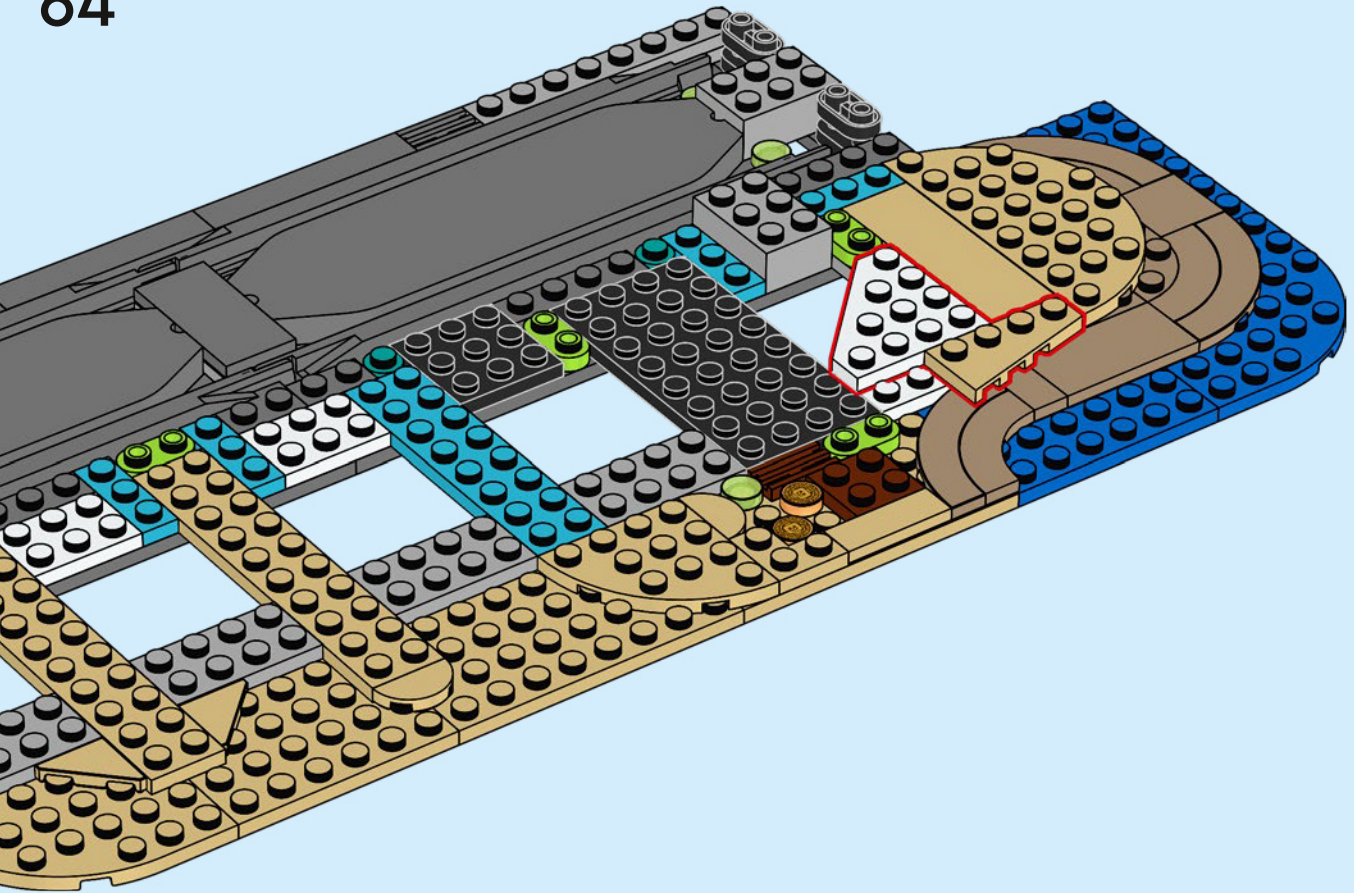

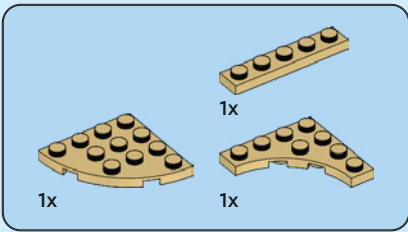

65

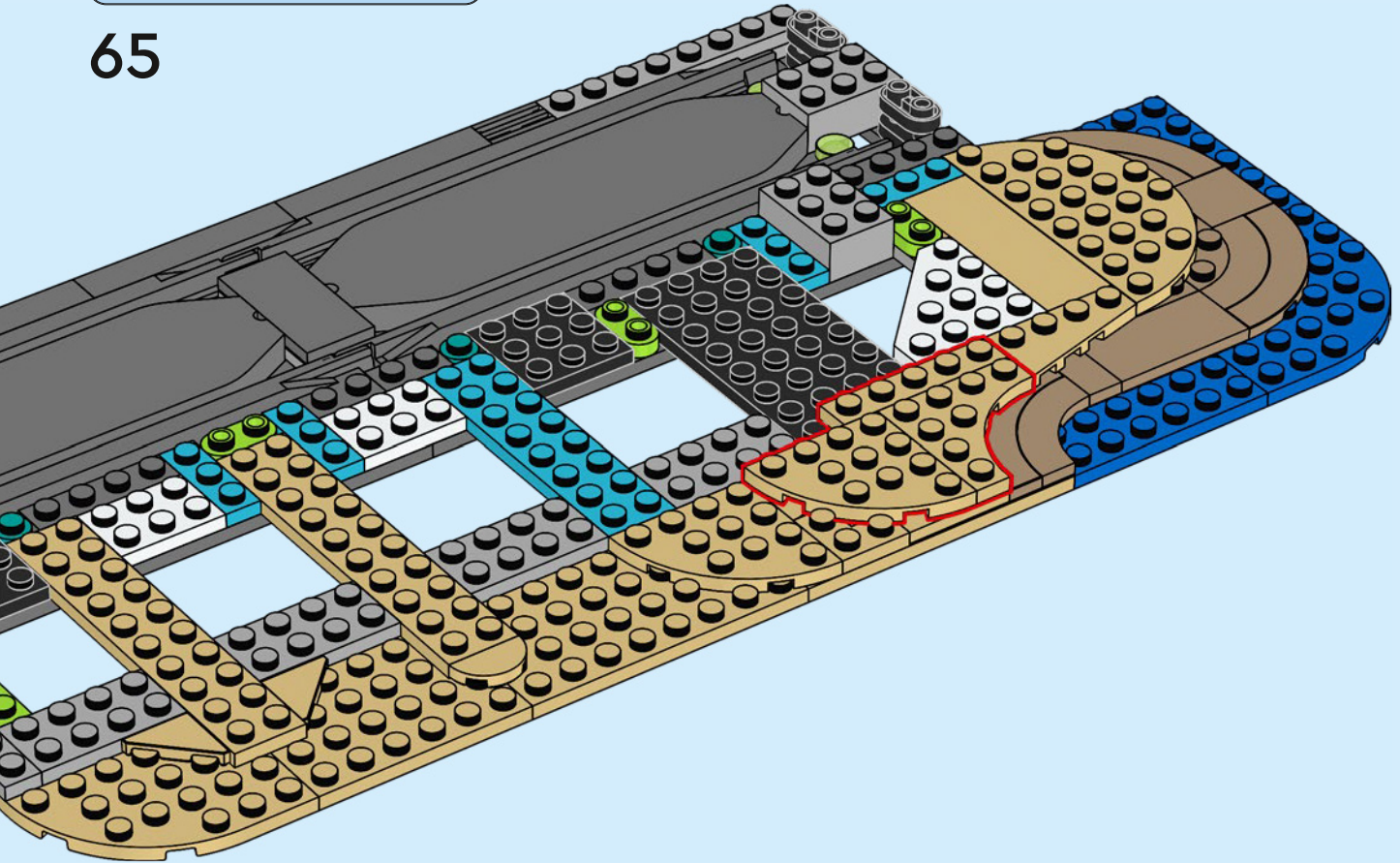

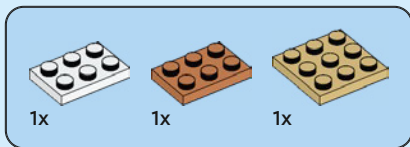

66

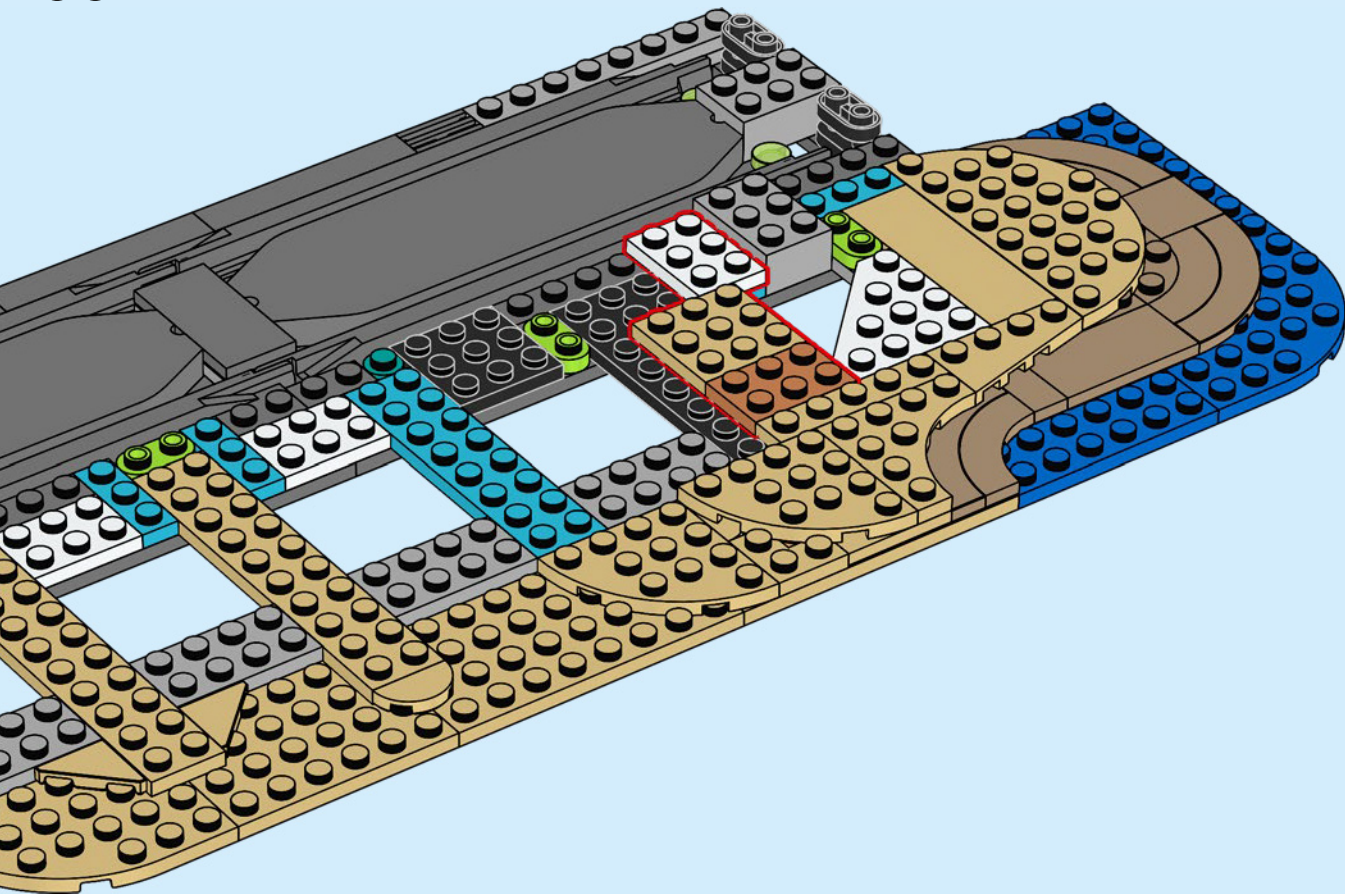

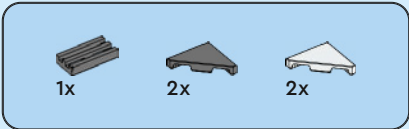

67

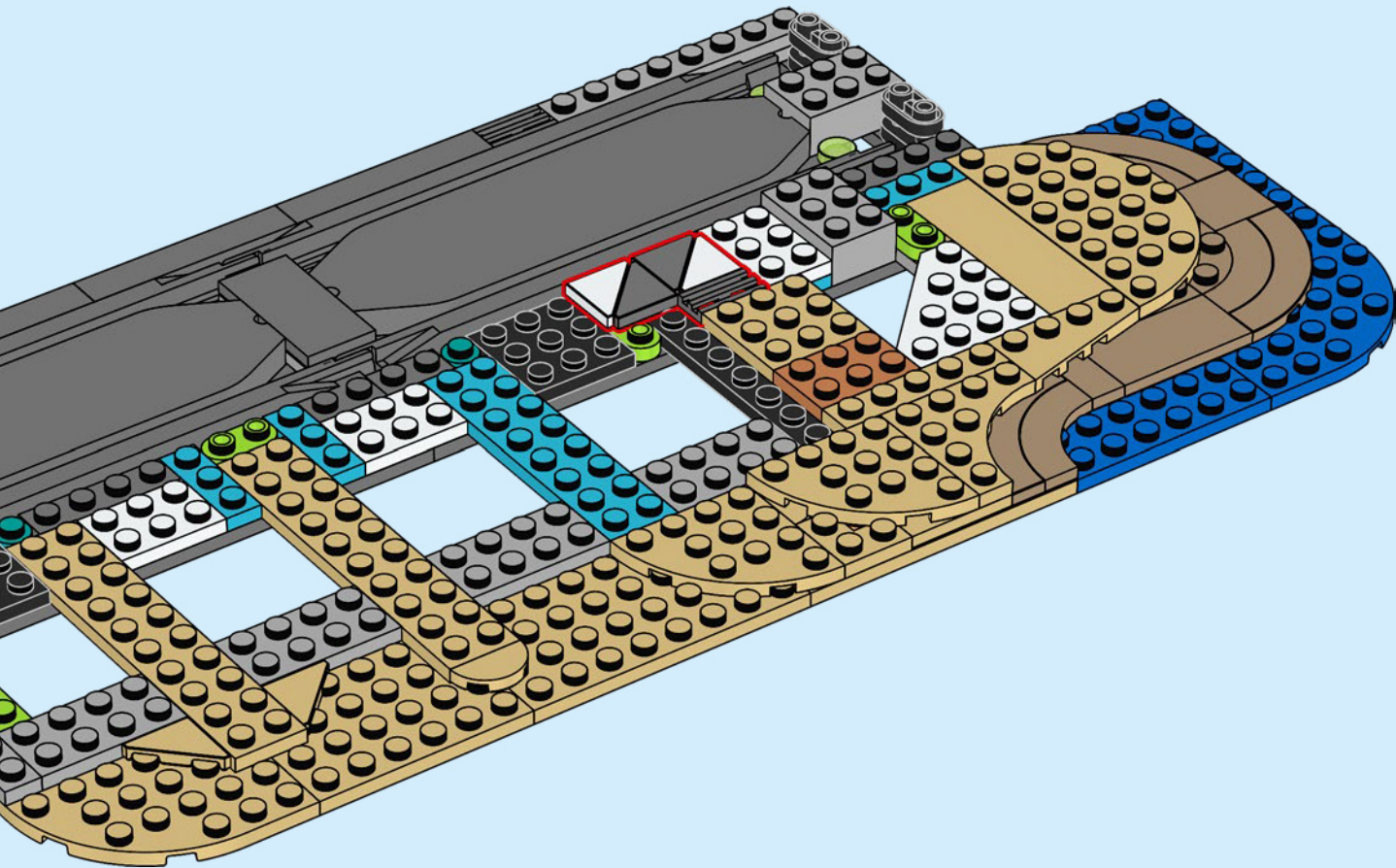



2x



2x

68

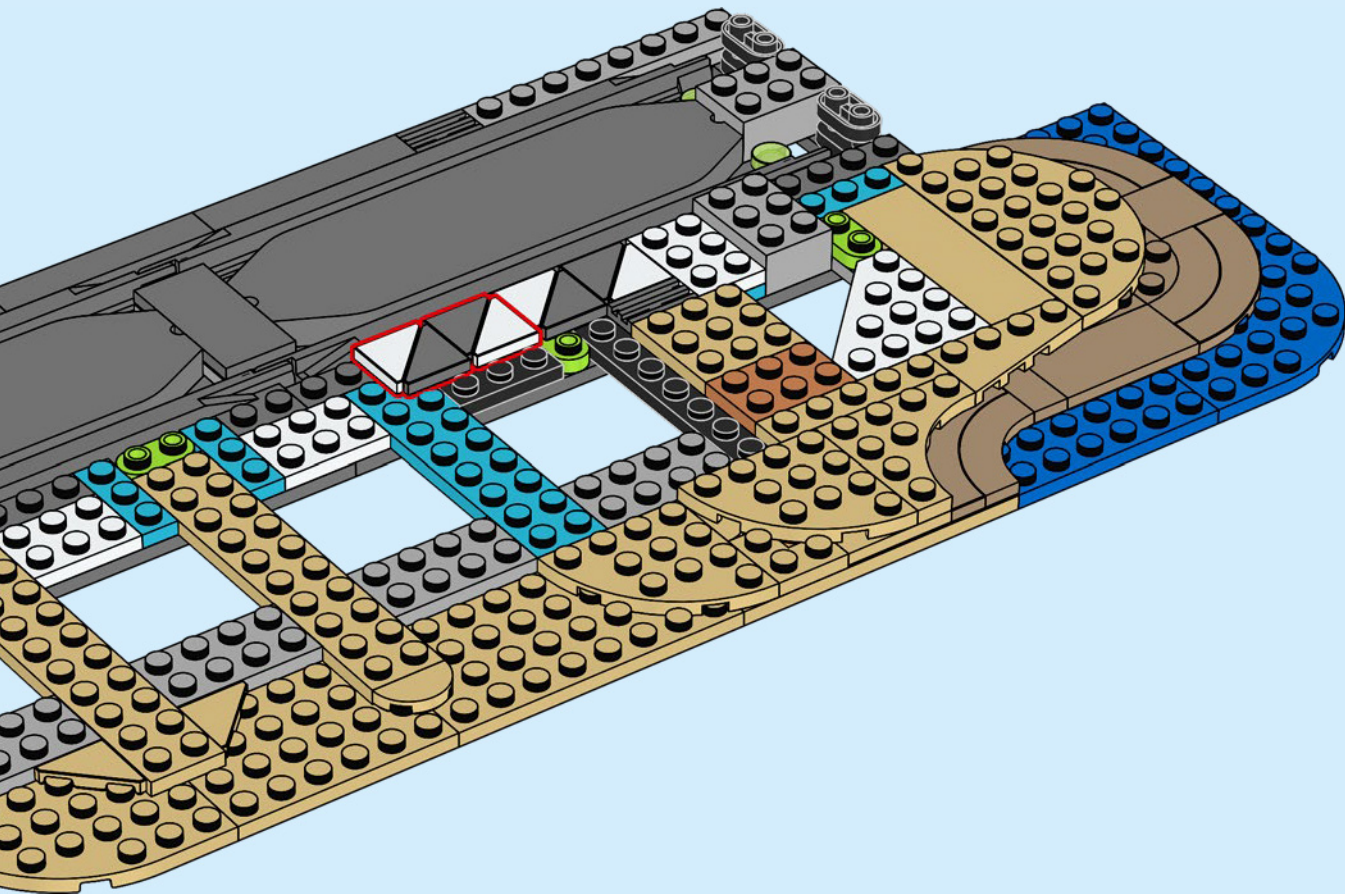



9x



9x

69

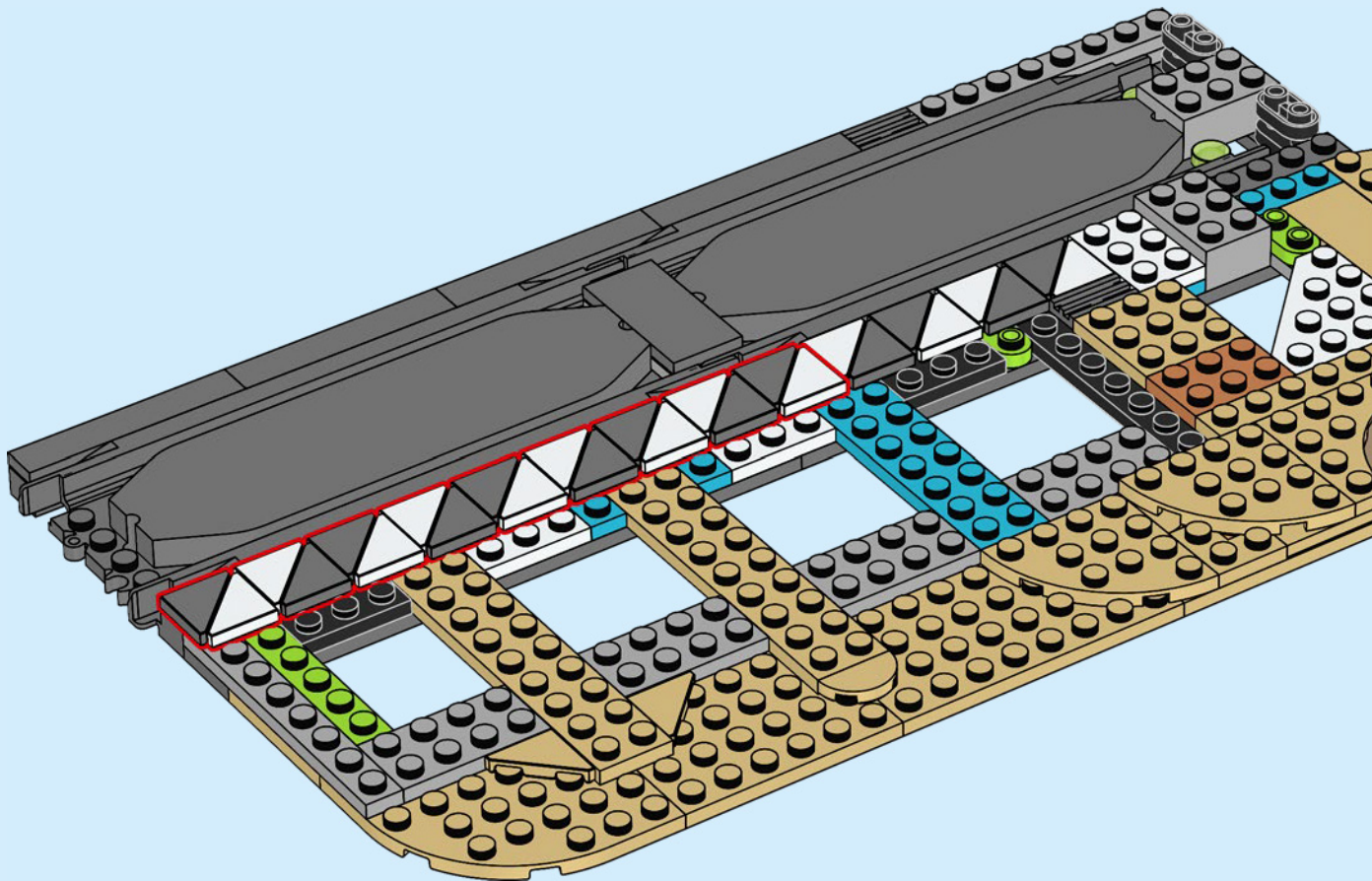

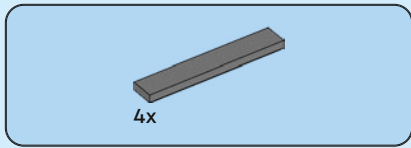

70

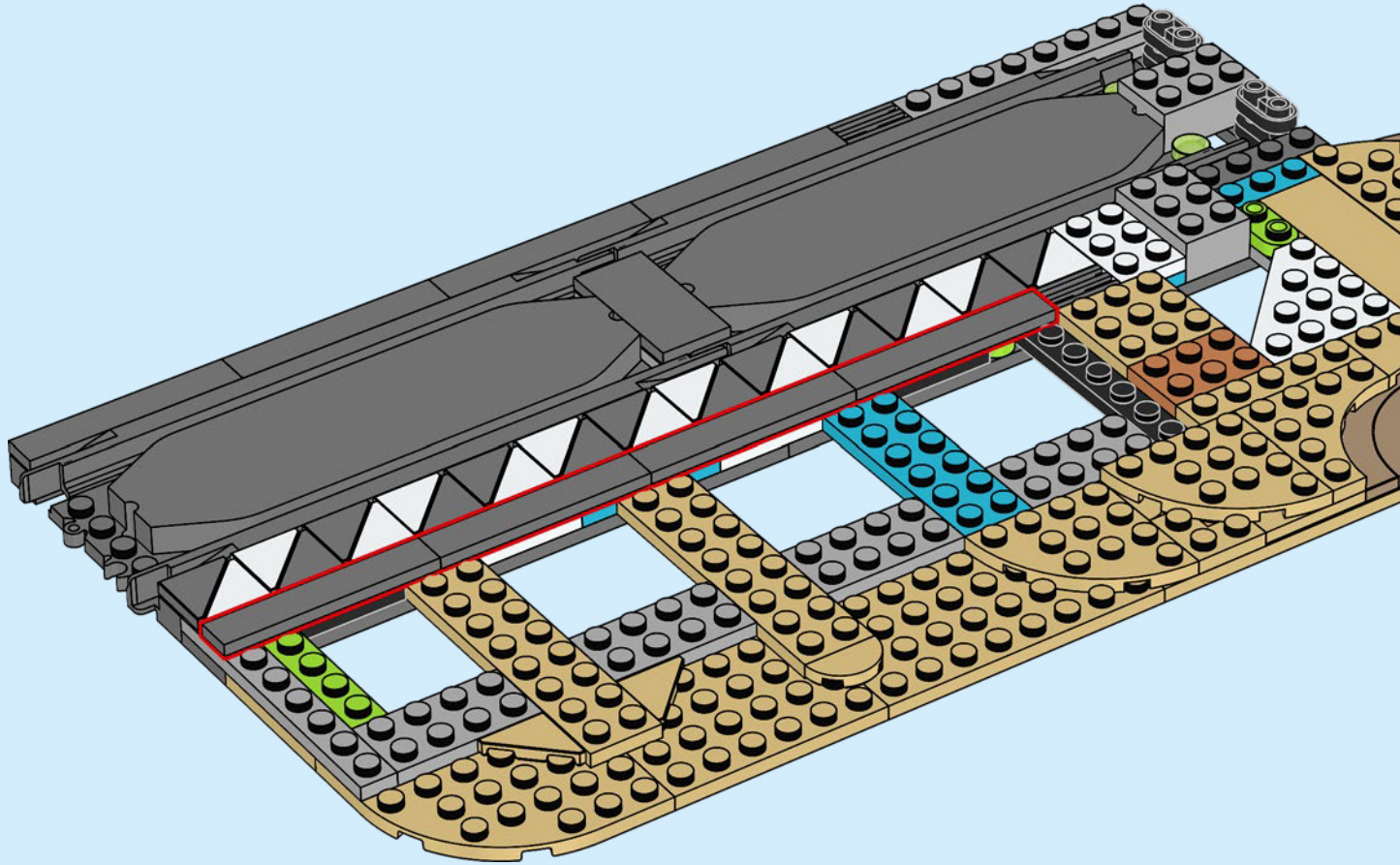

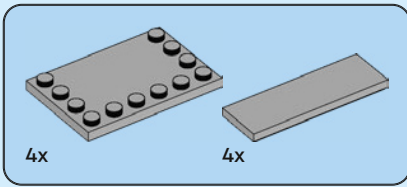

71

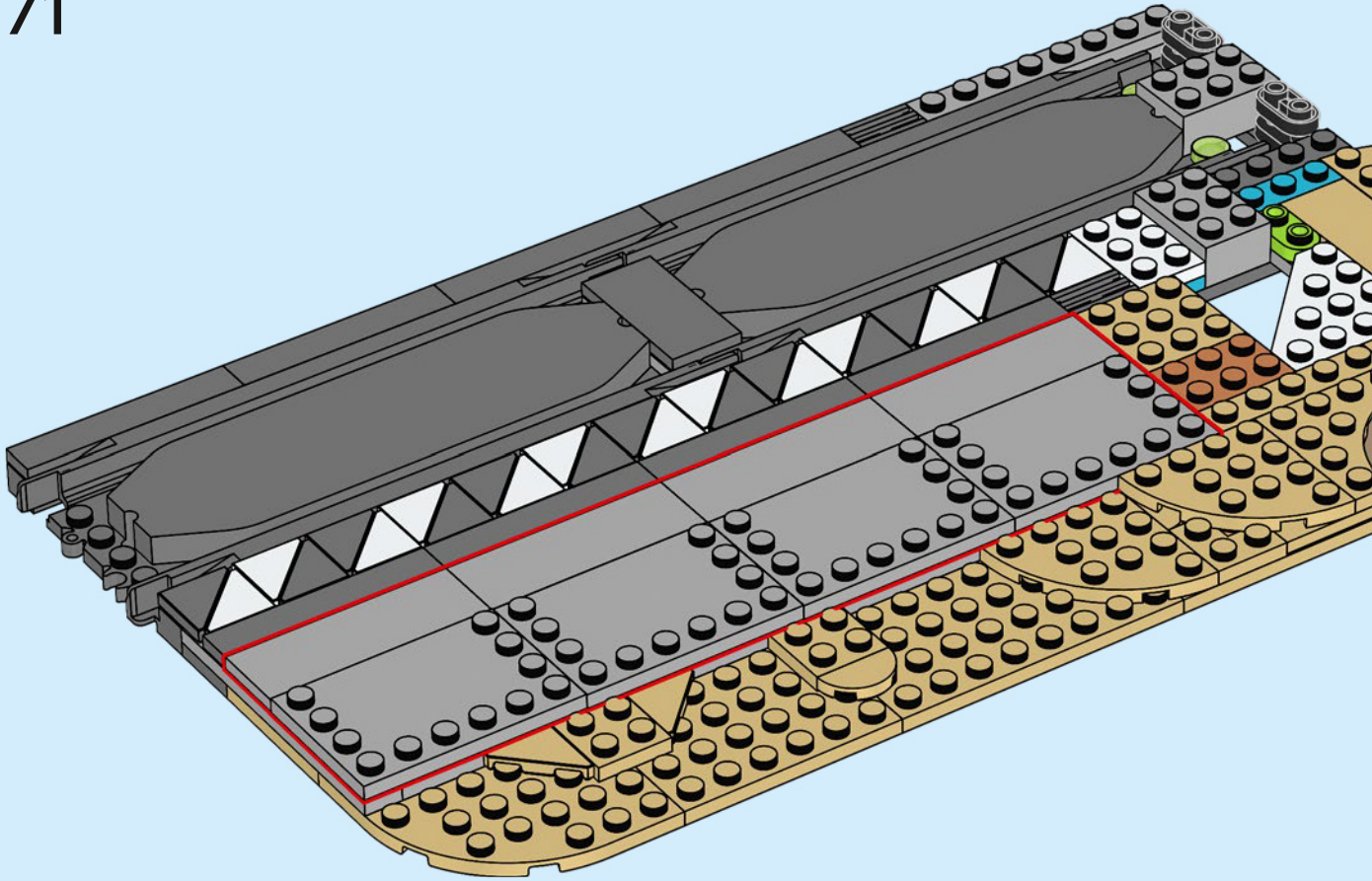

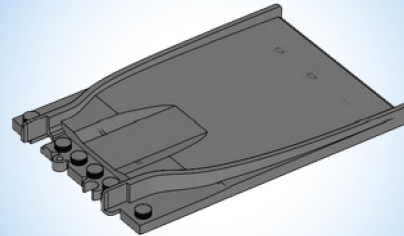
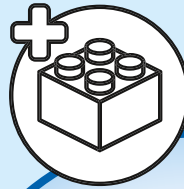
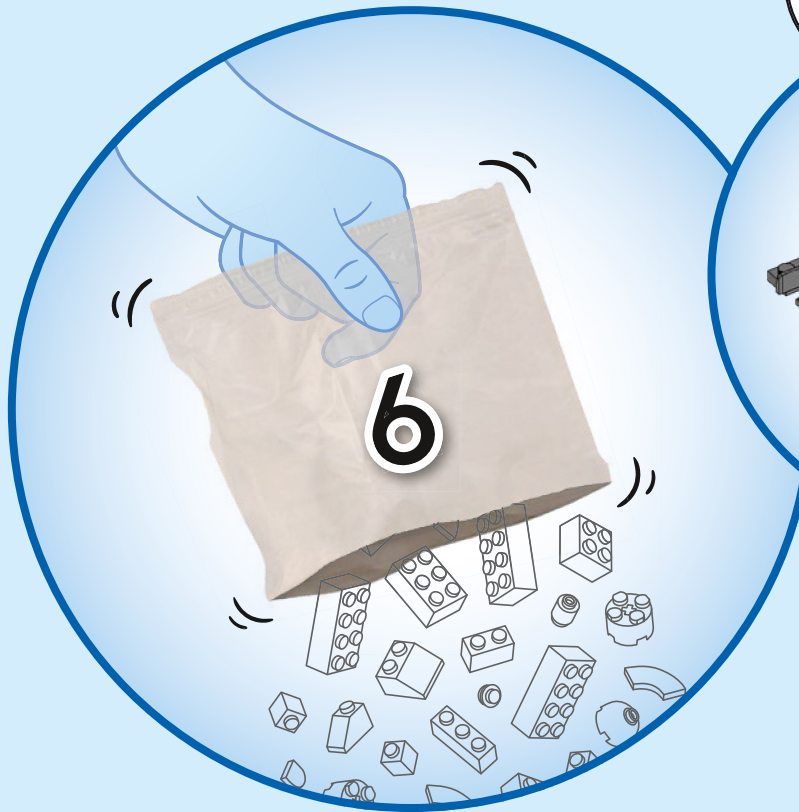

1x

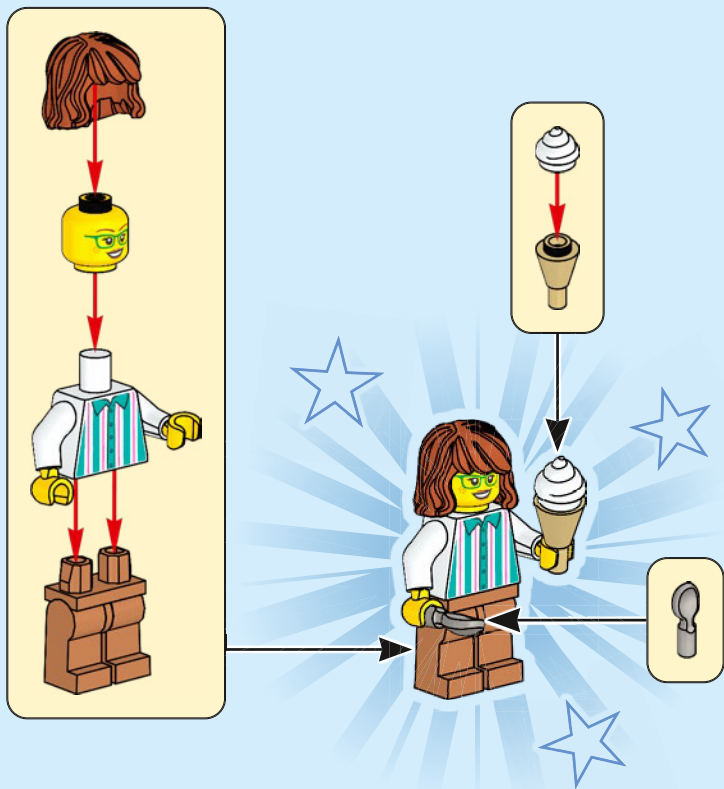

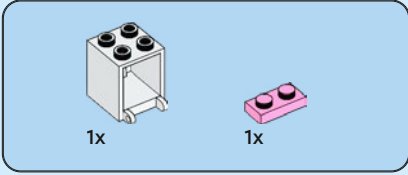
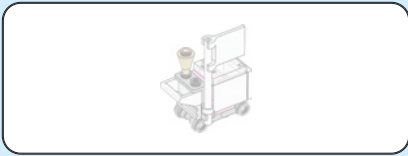

1

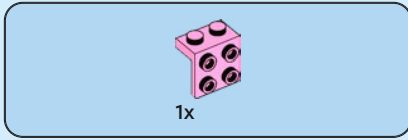
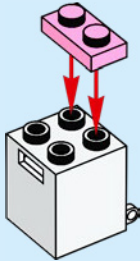

2

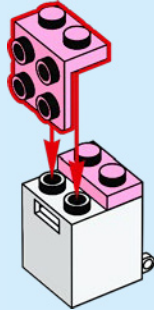



1x



1x

3

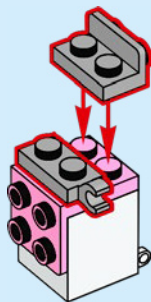

1x



1x

4

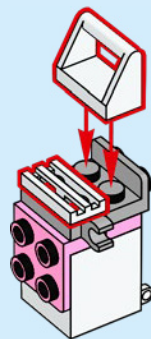

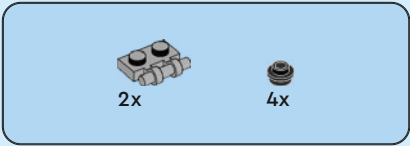

5

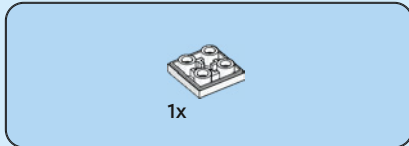
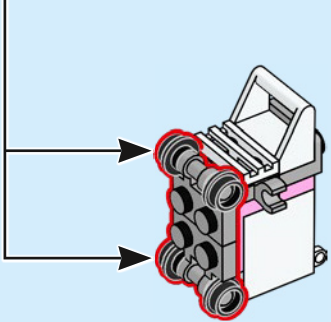
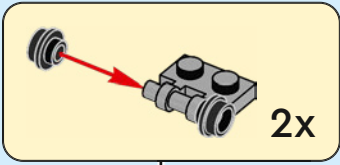

6

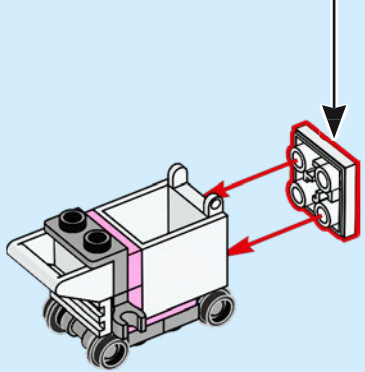
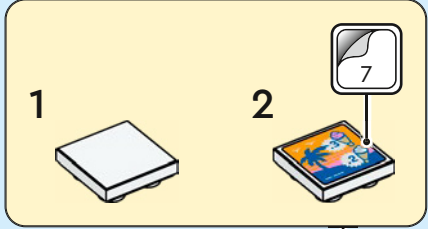



1x

7

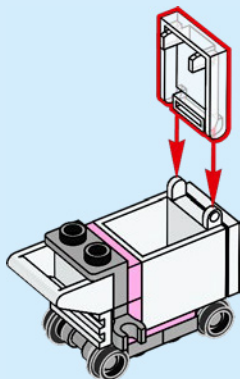

1x



1x



1x

8

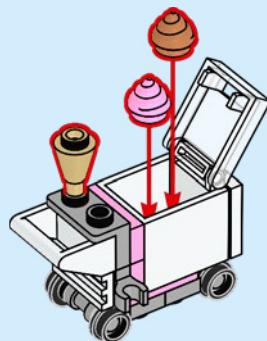

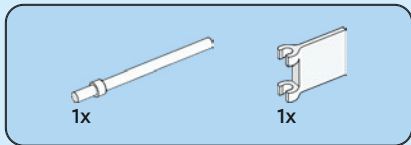

9

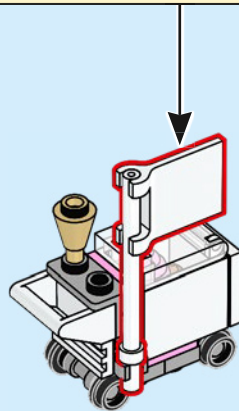
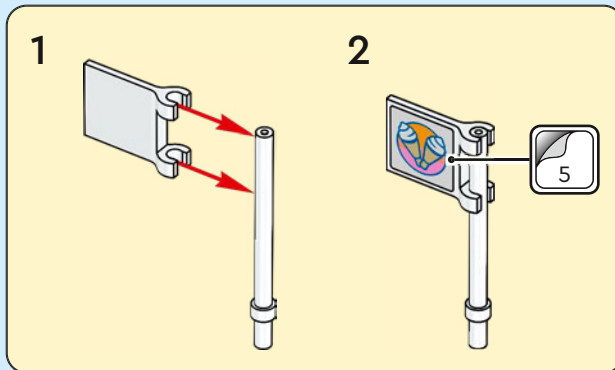

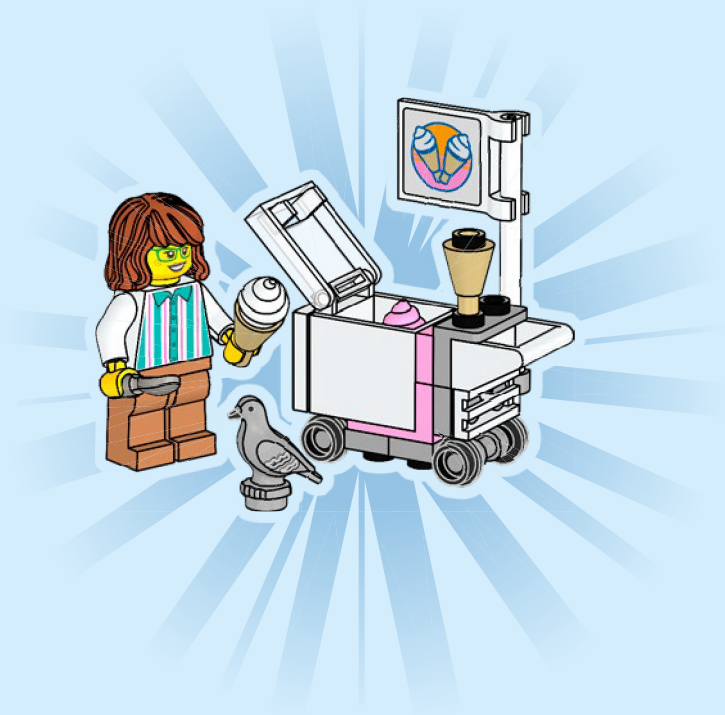

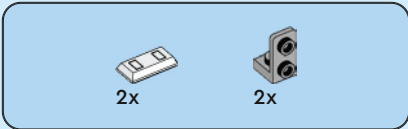

72

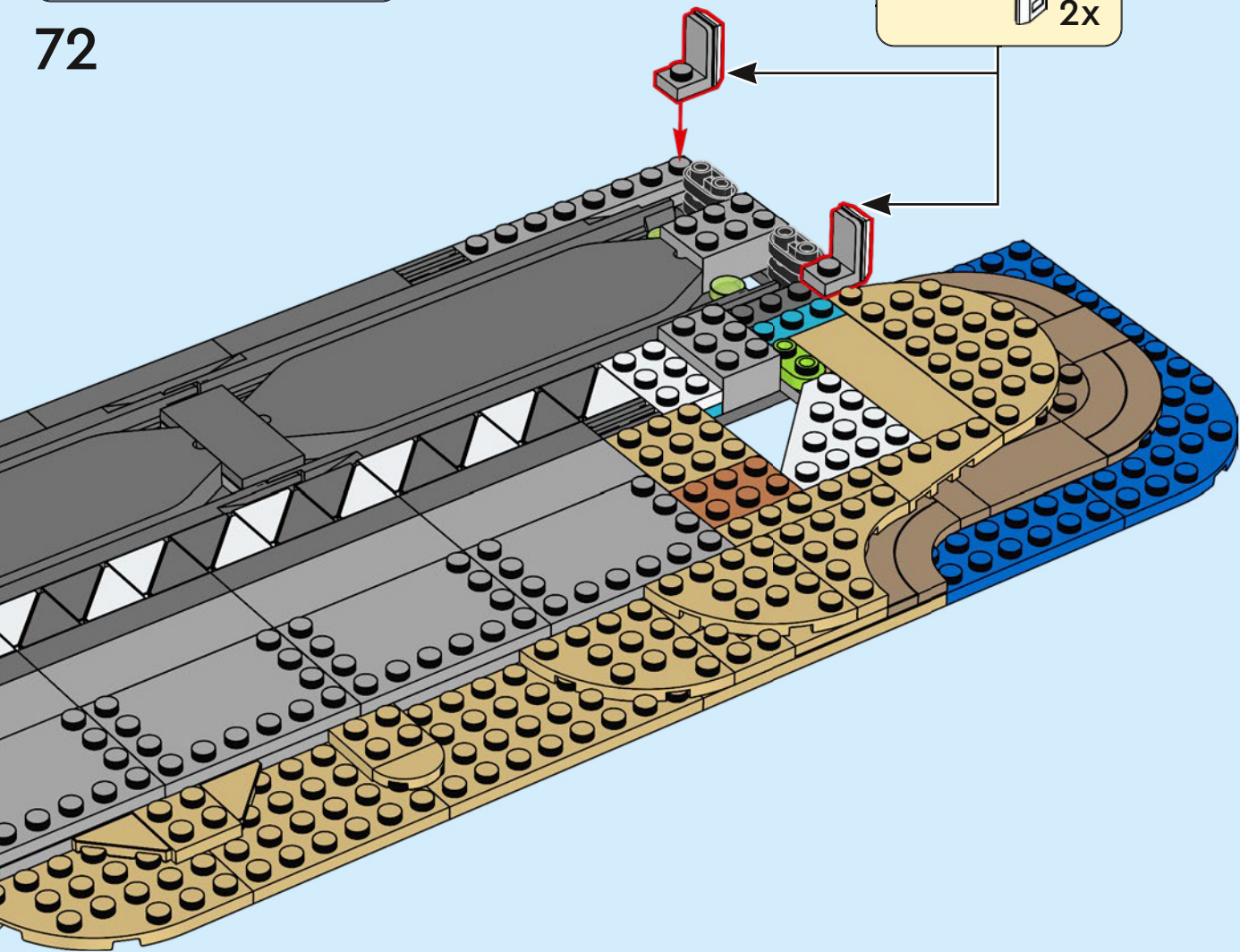
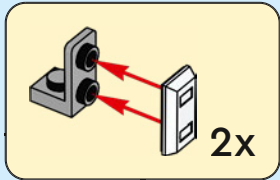

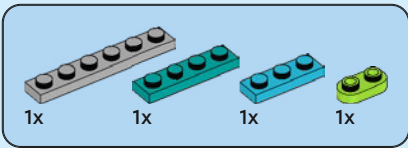

73

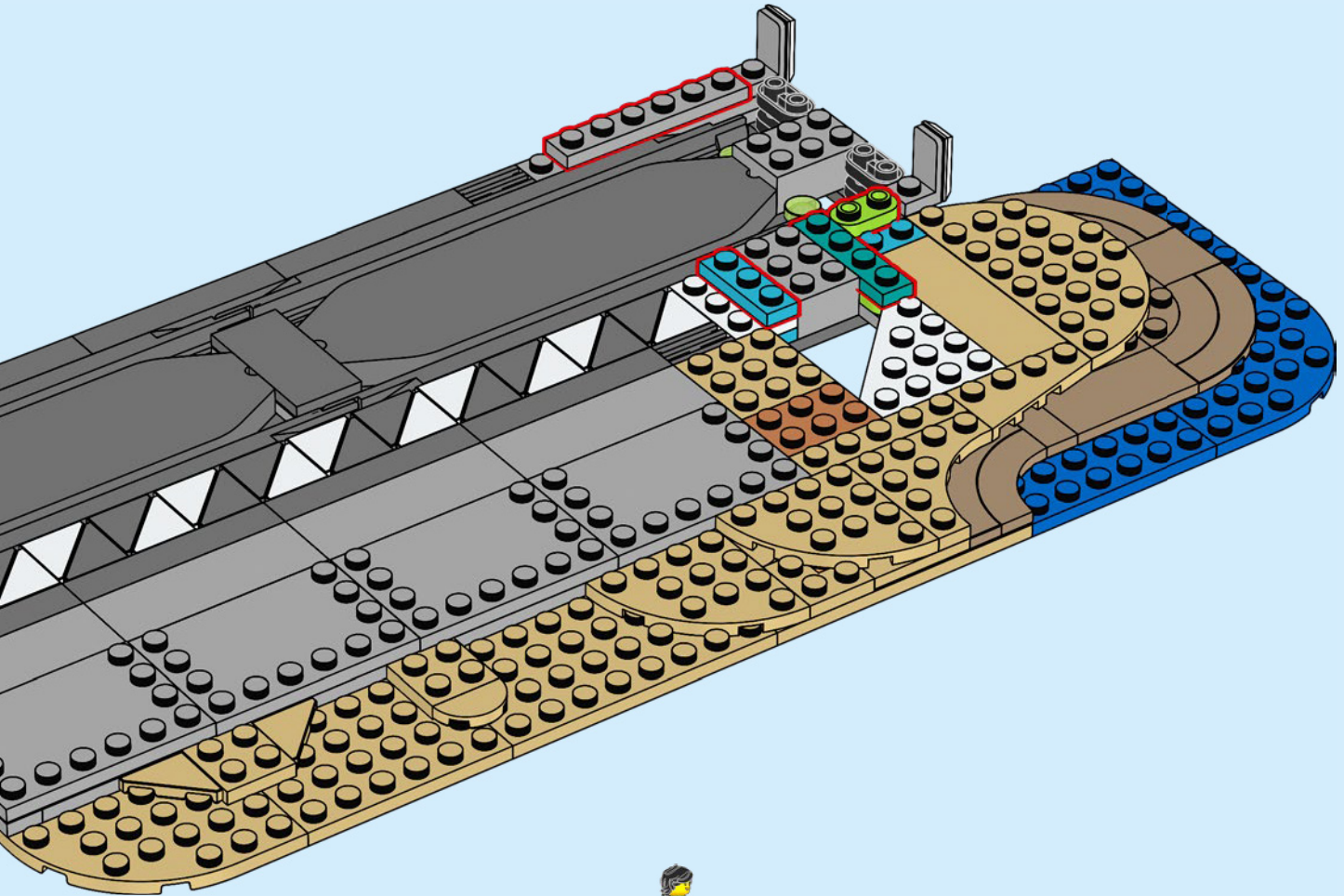

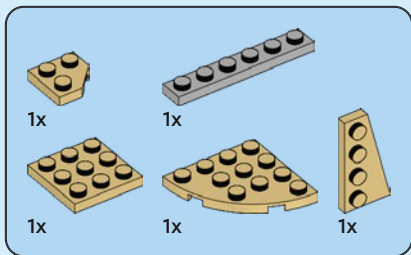

74

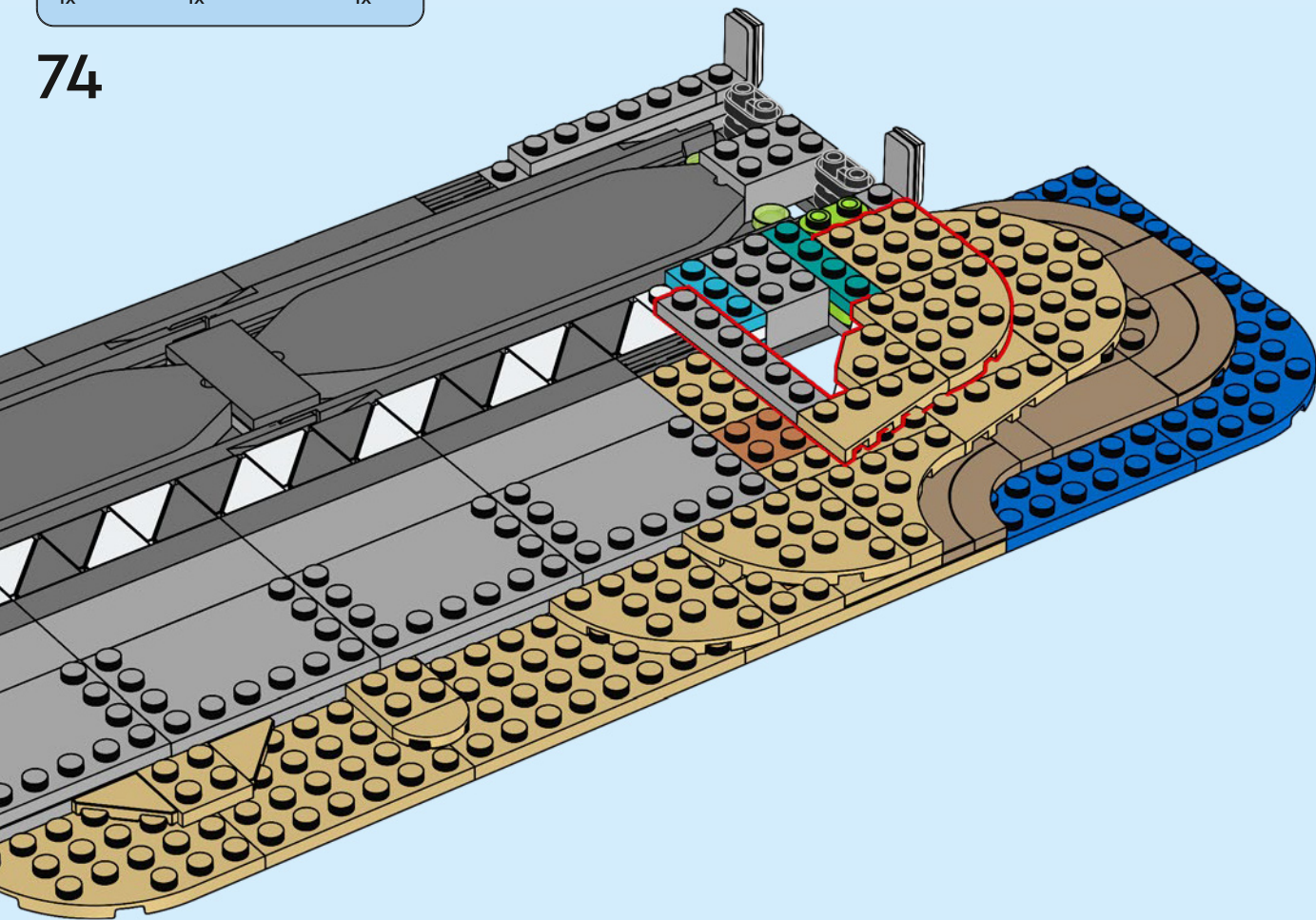

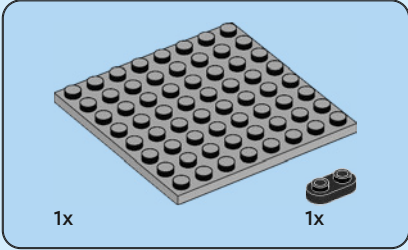
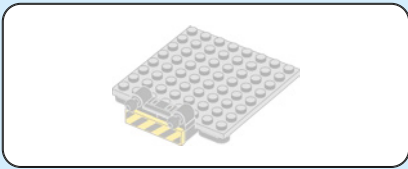

75

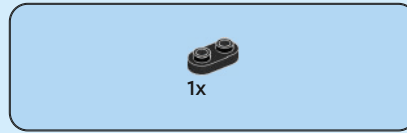
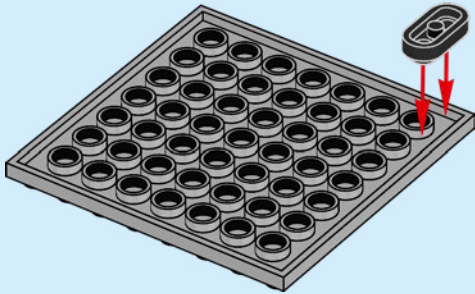

76

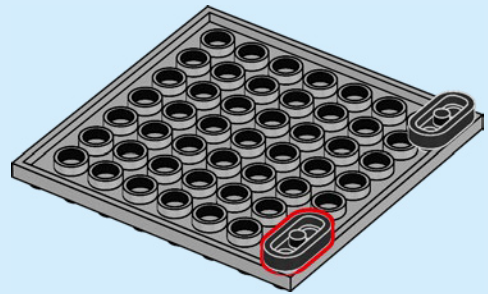



2x

77

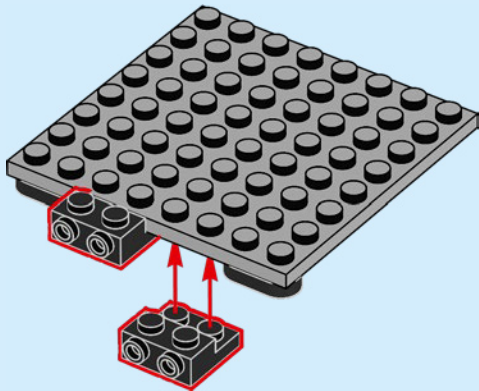

1x

78

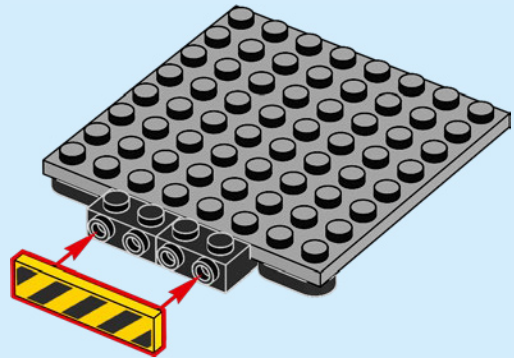



2x



2x

# 79

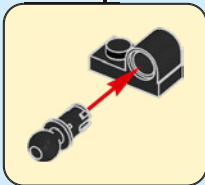
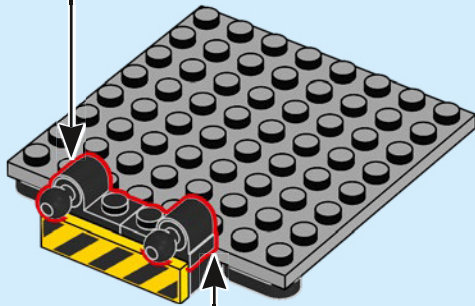
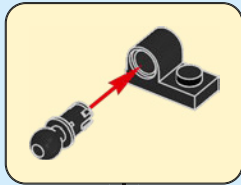

1x

# 80

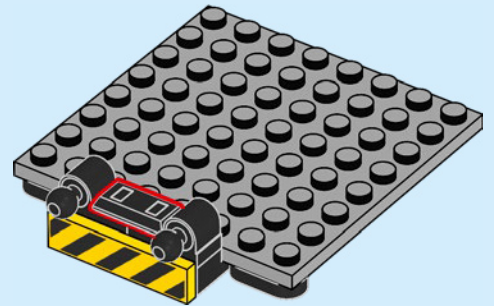

81

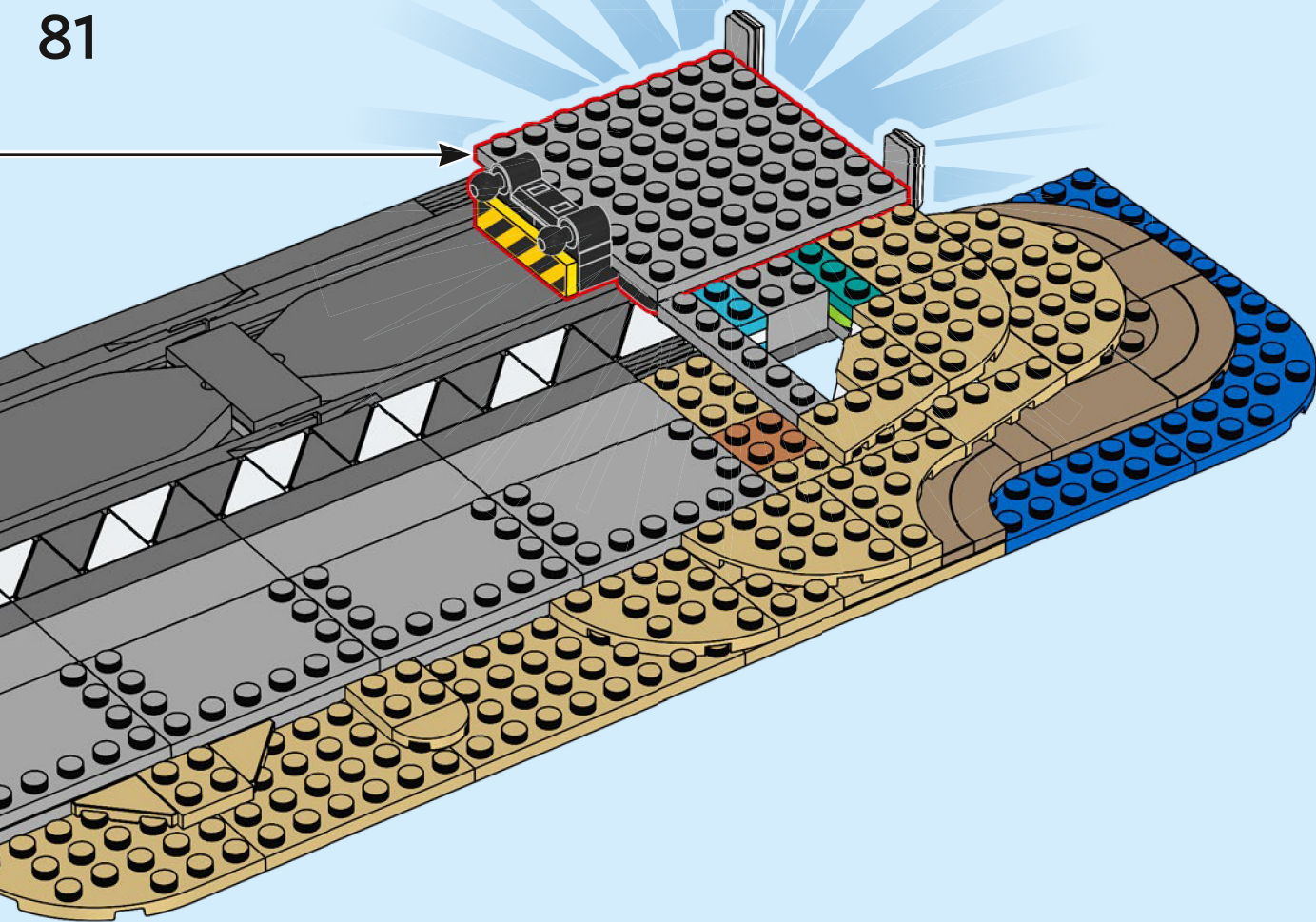

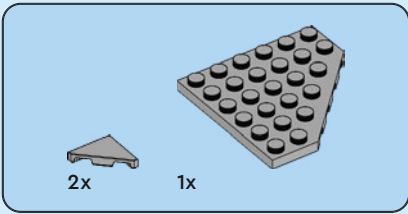

82

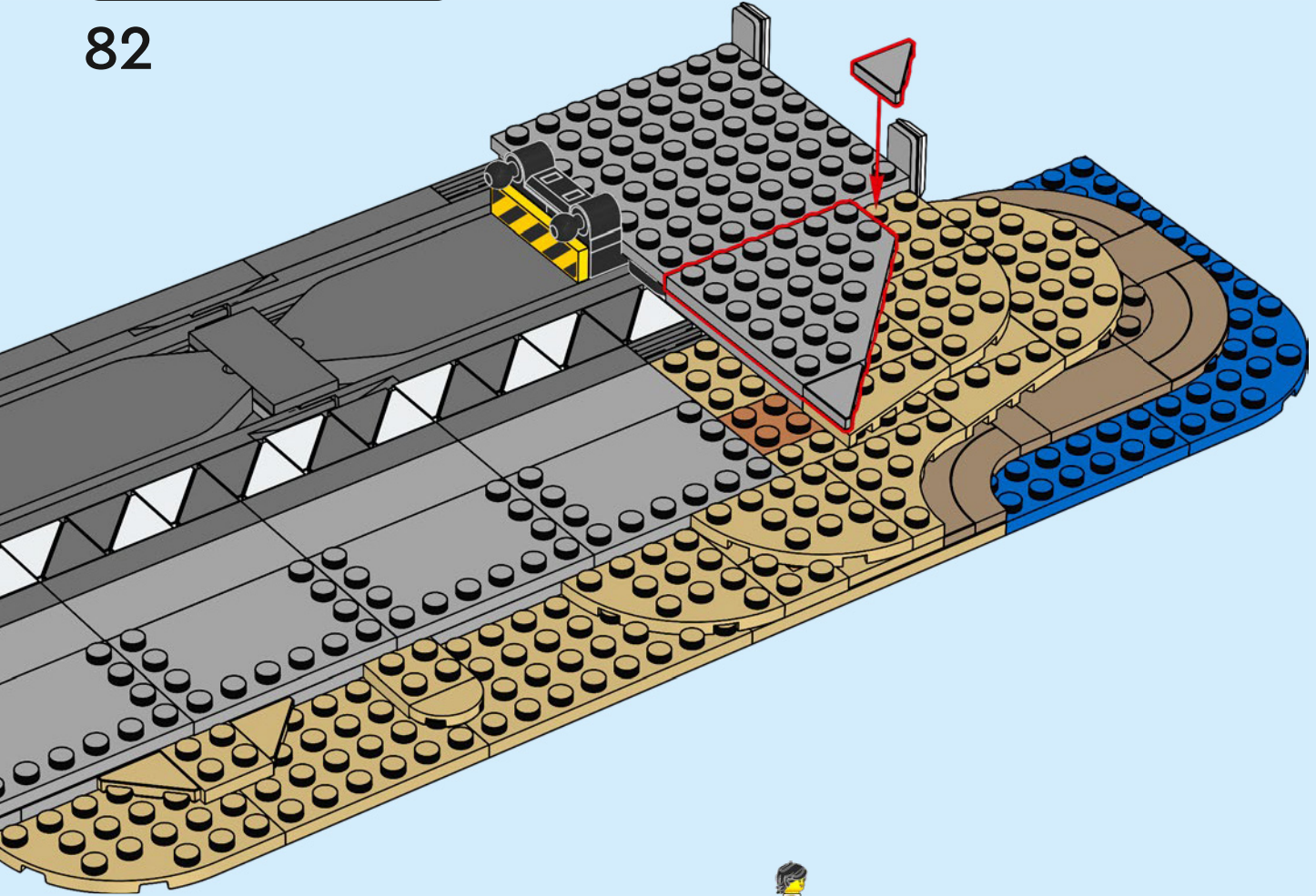



6x

83

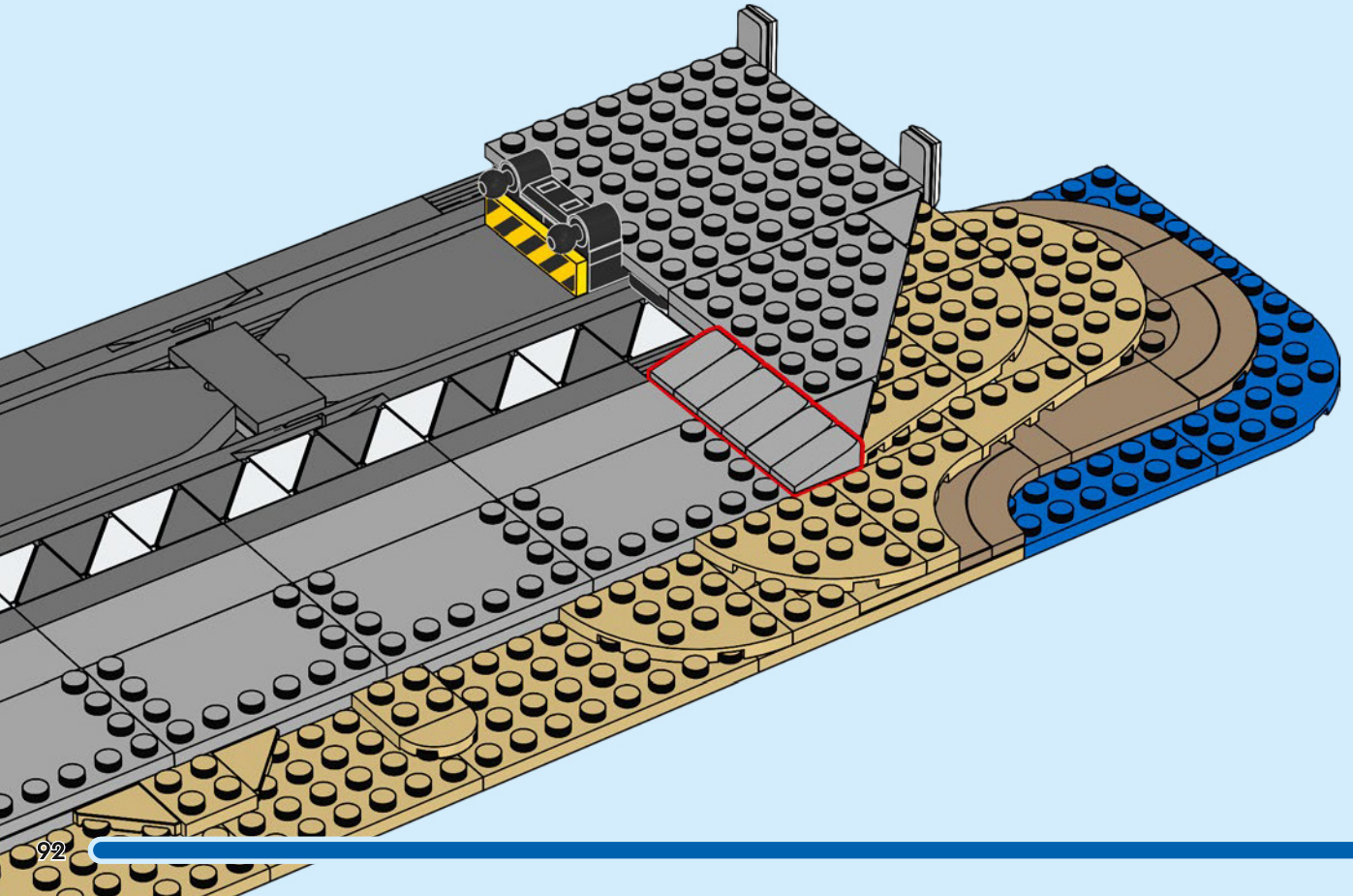

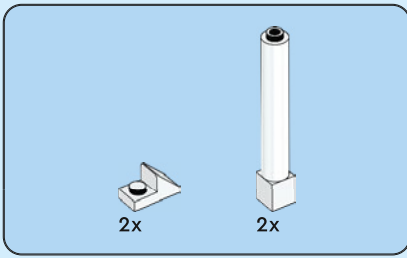

84

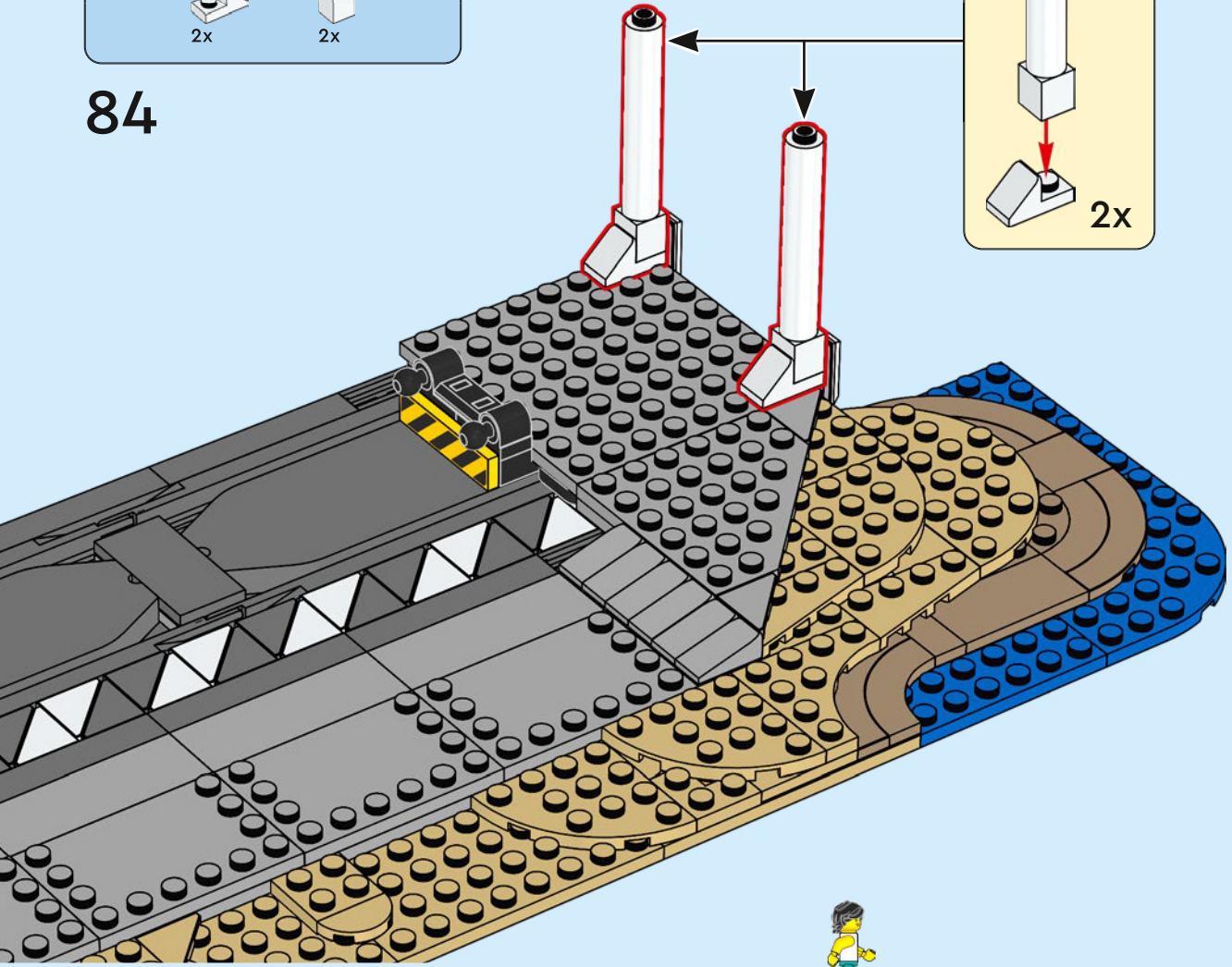
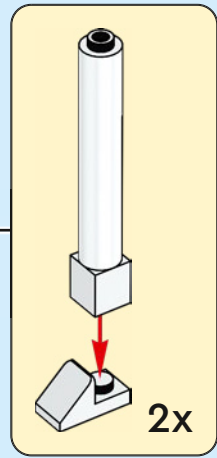

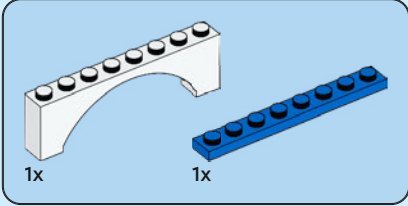
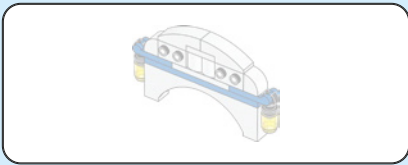

85

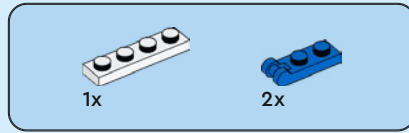
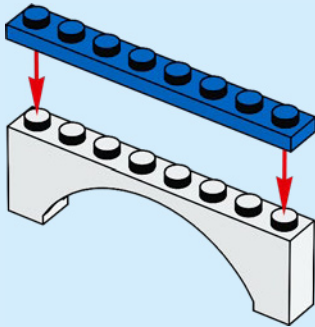

86

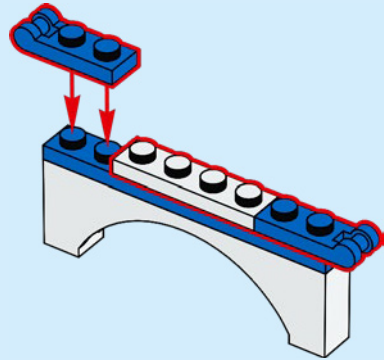



87

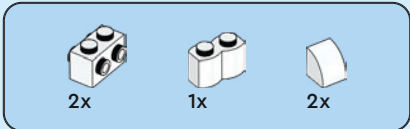
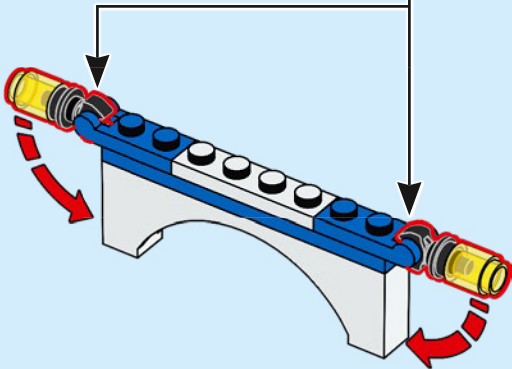
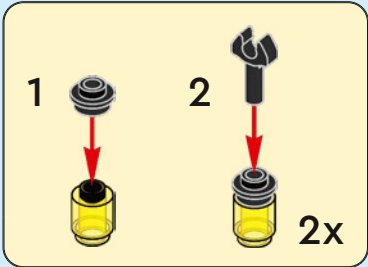

88

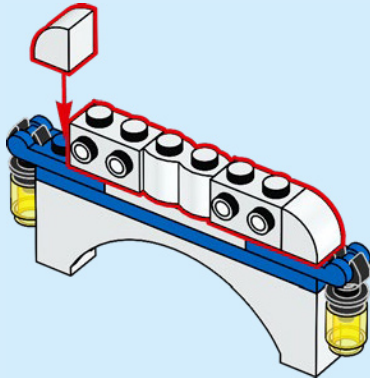



1x

89

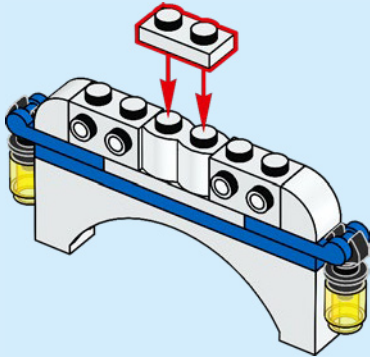

2x

90

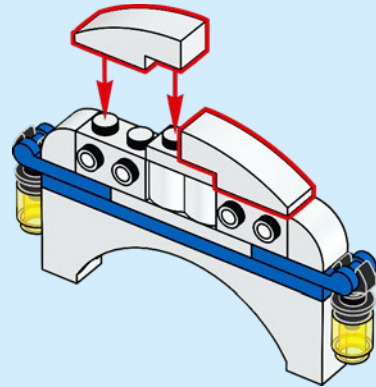

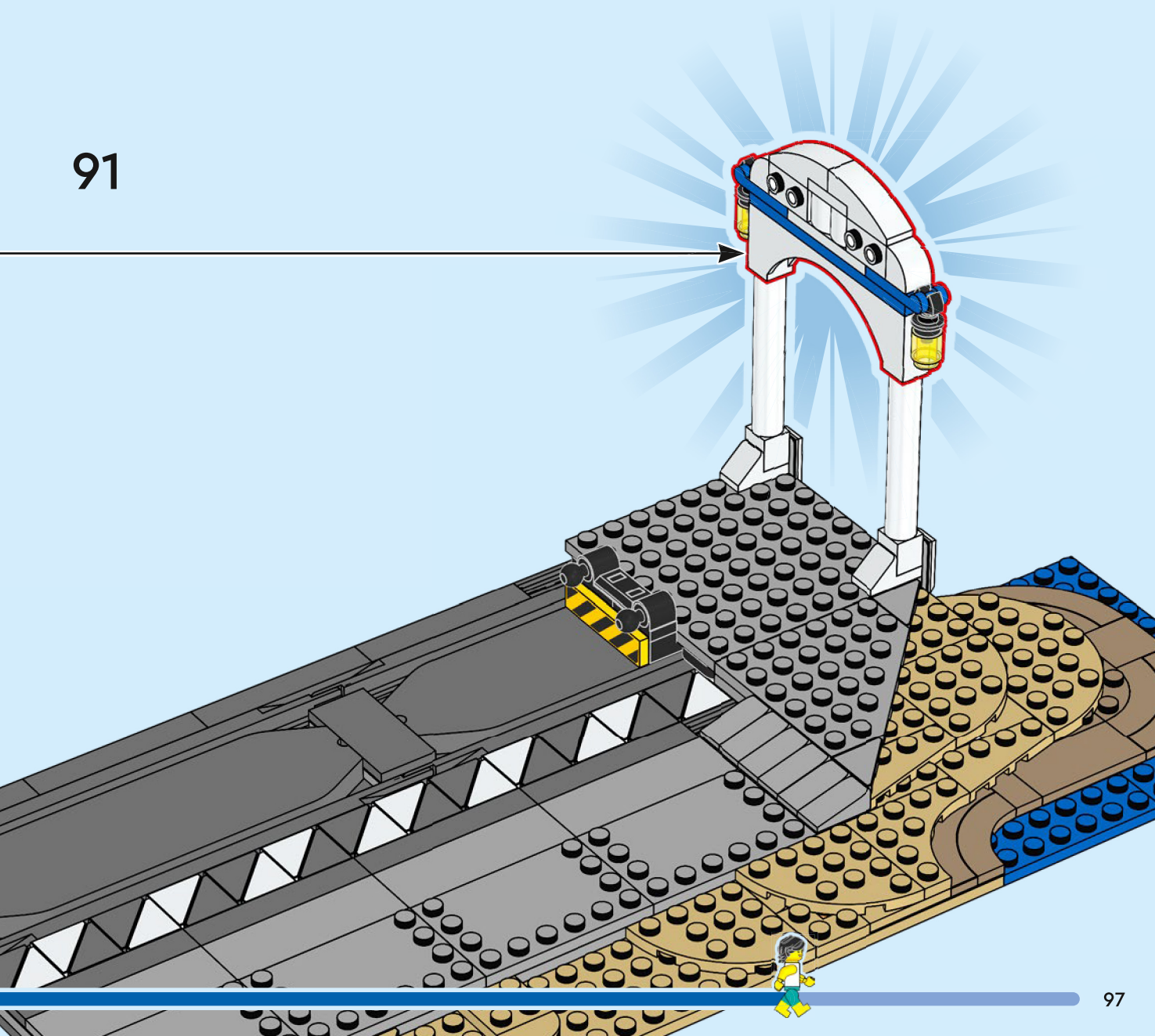

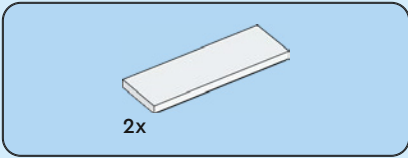

92

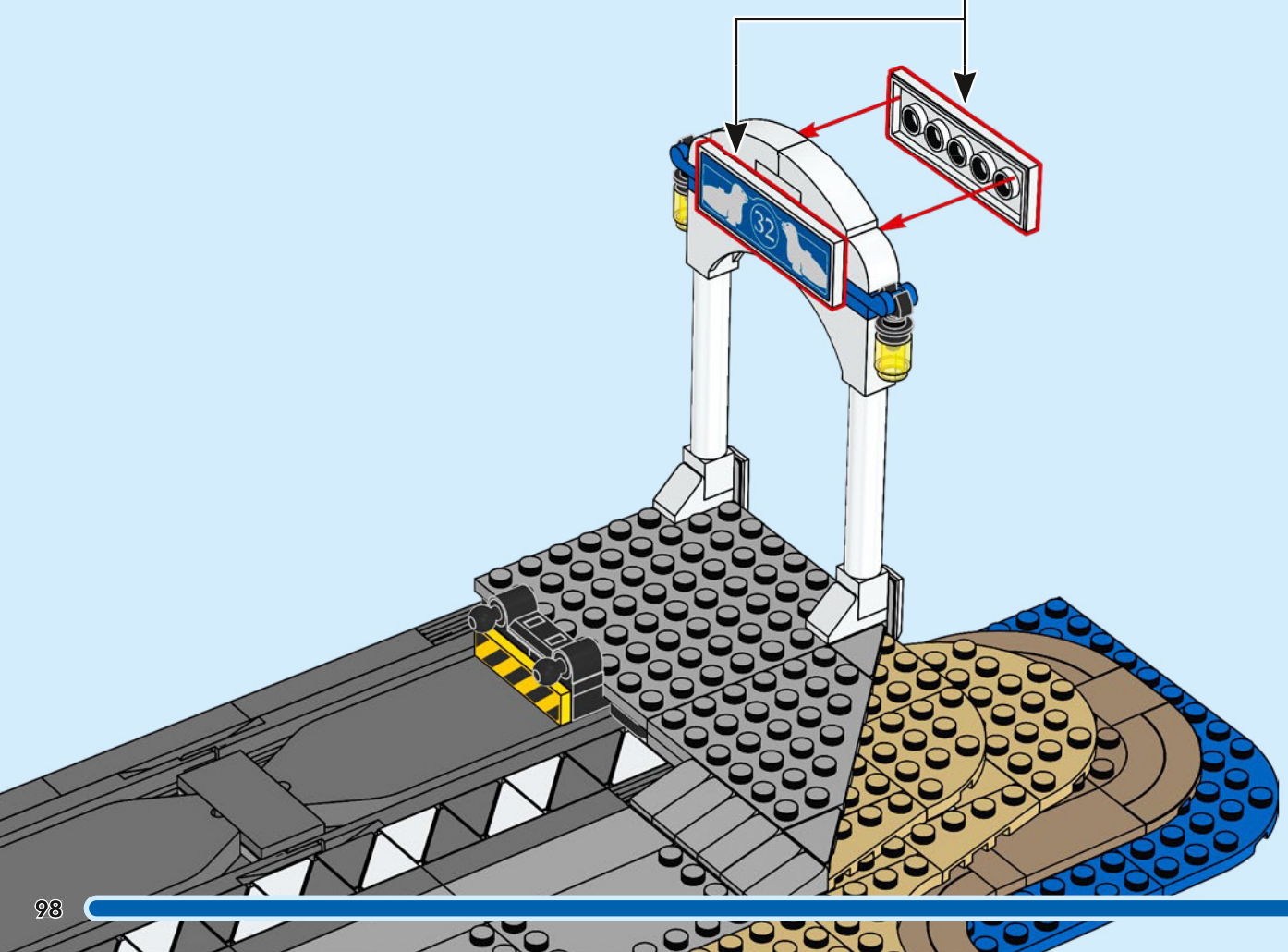
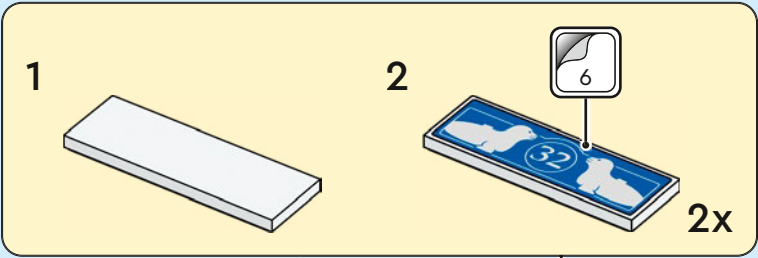

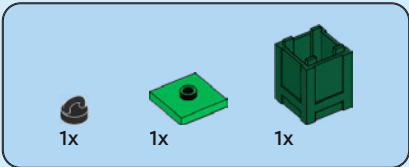

93

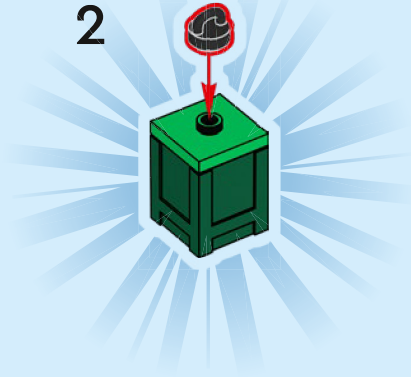
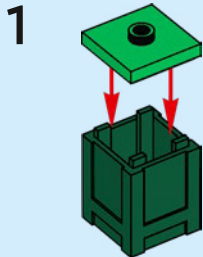

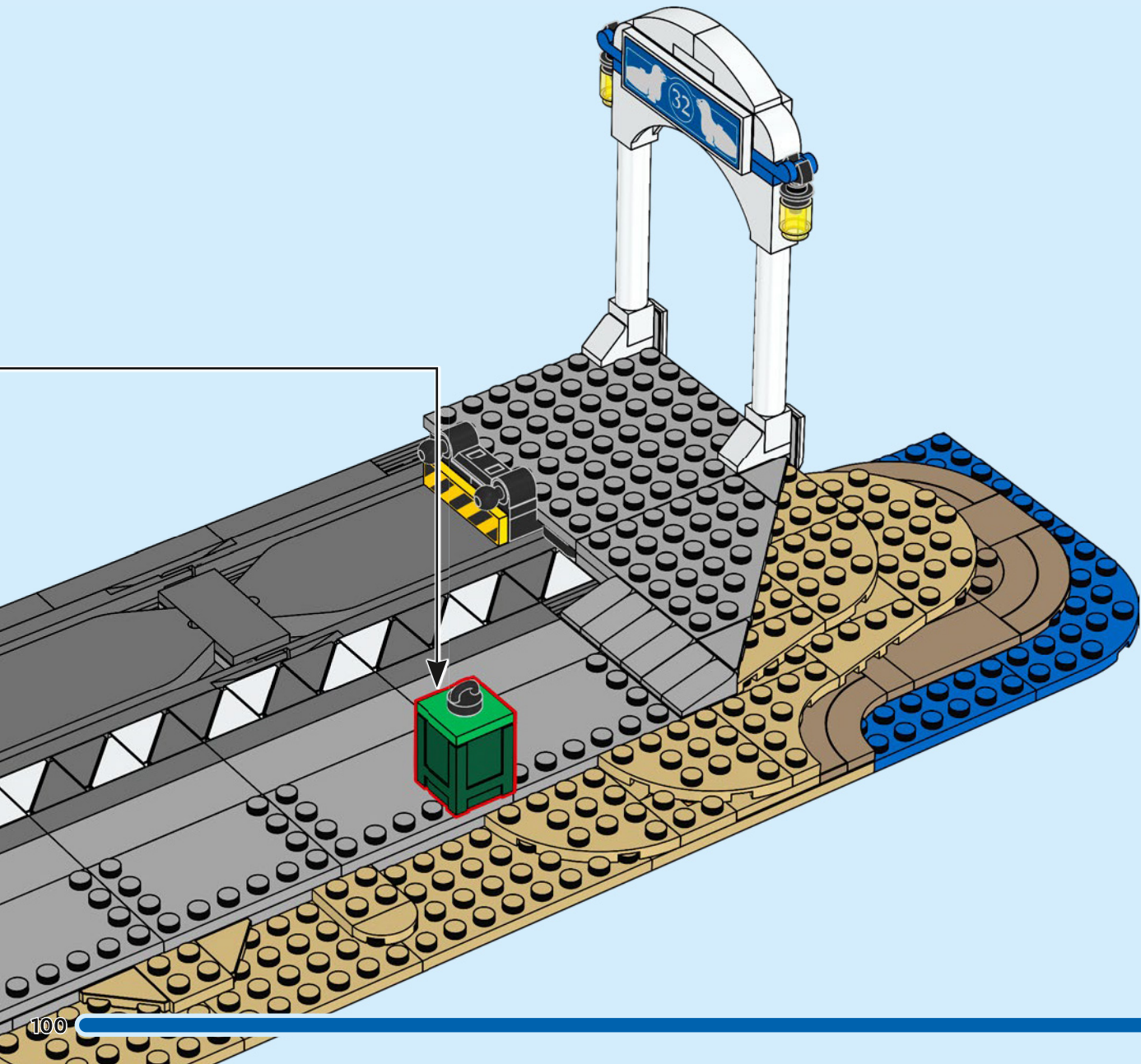

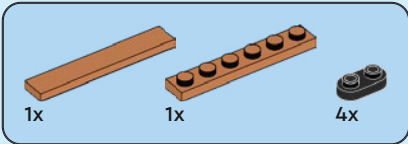
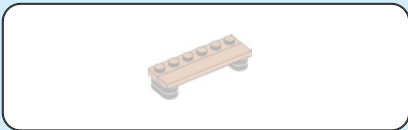

94

1

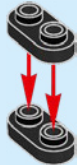

2

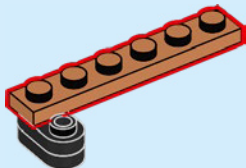

3

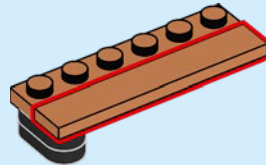

4



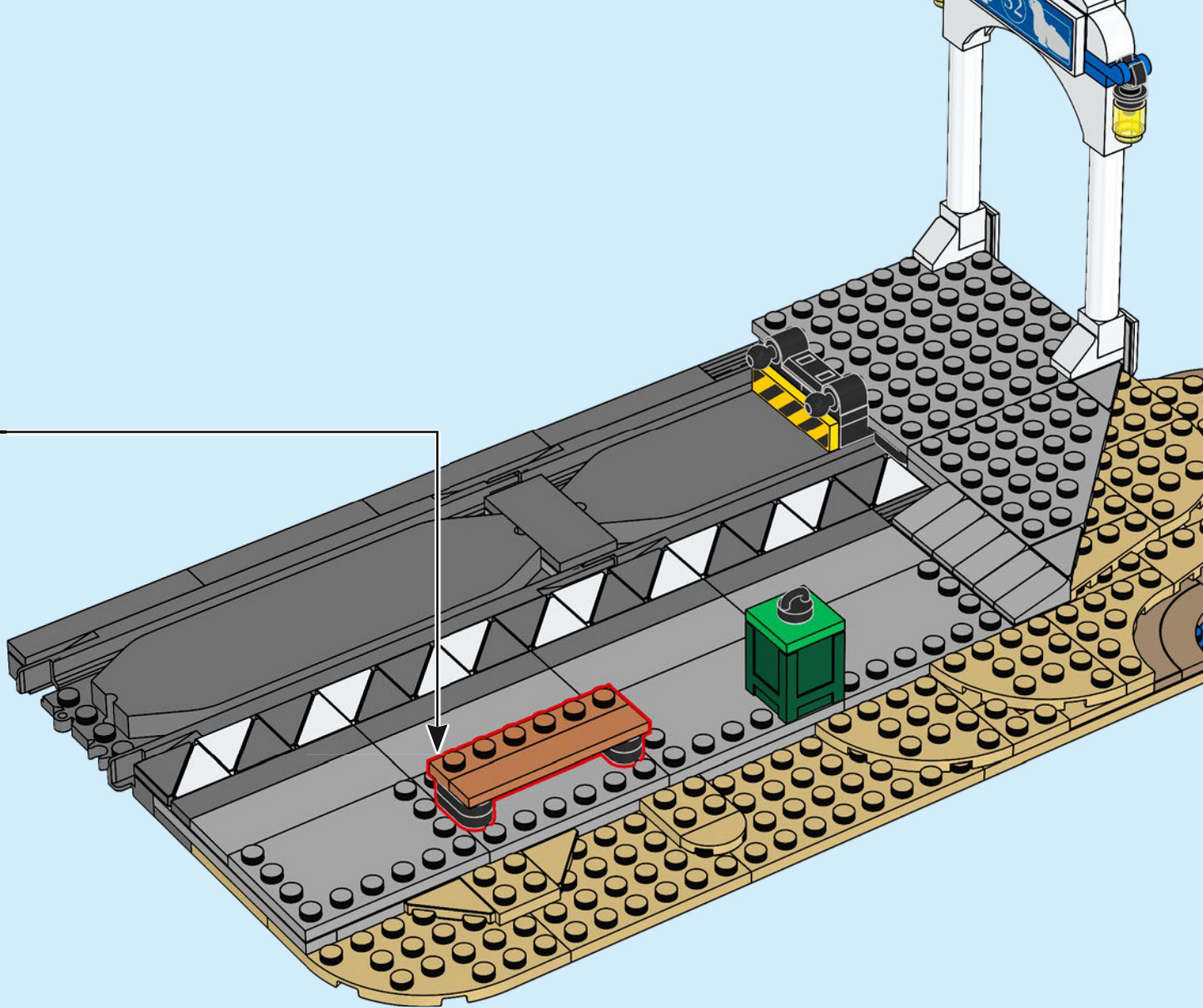



2x



2x

95

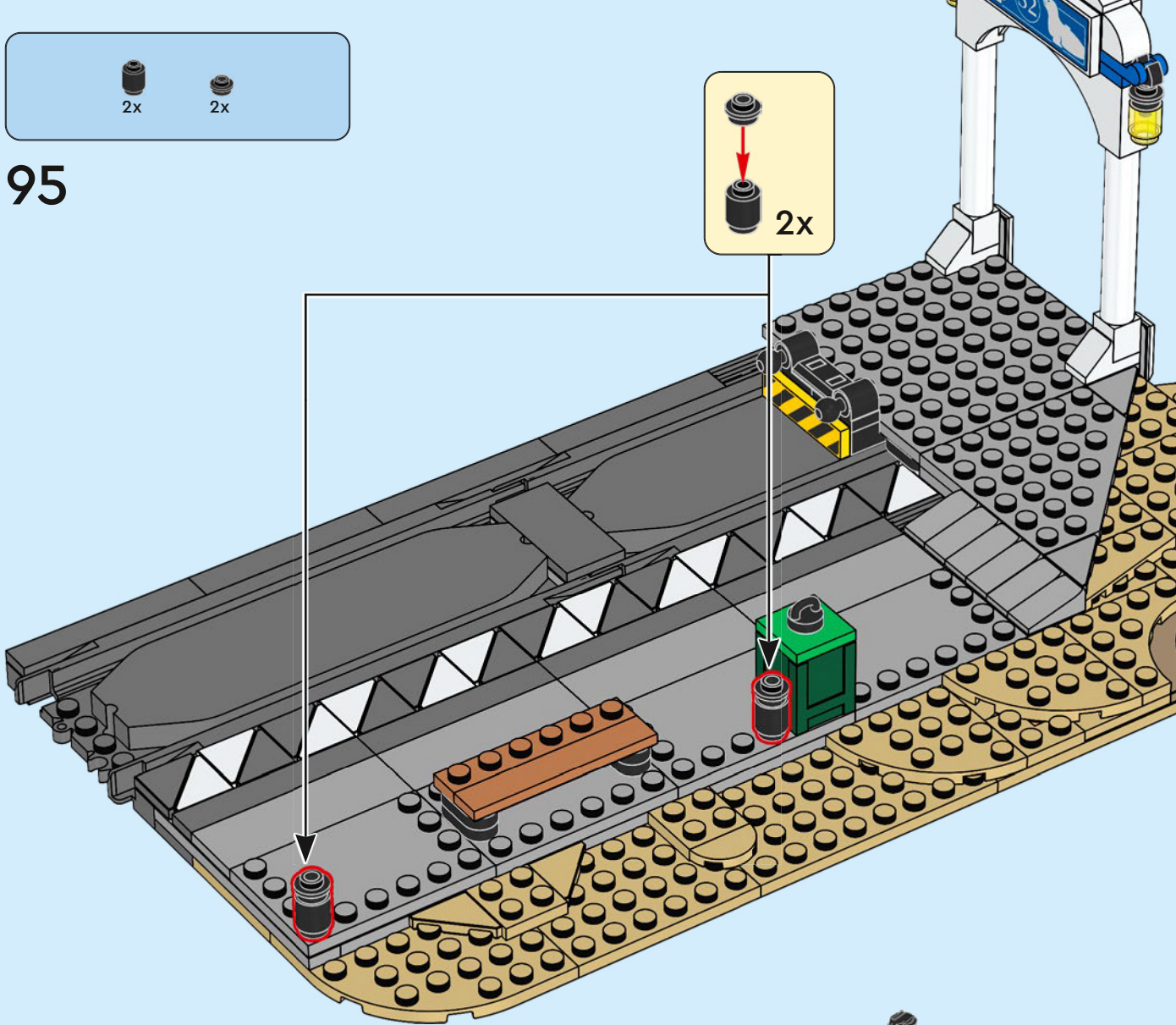
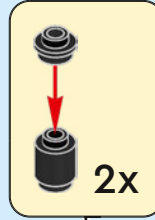



2x

96

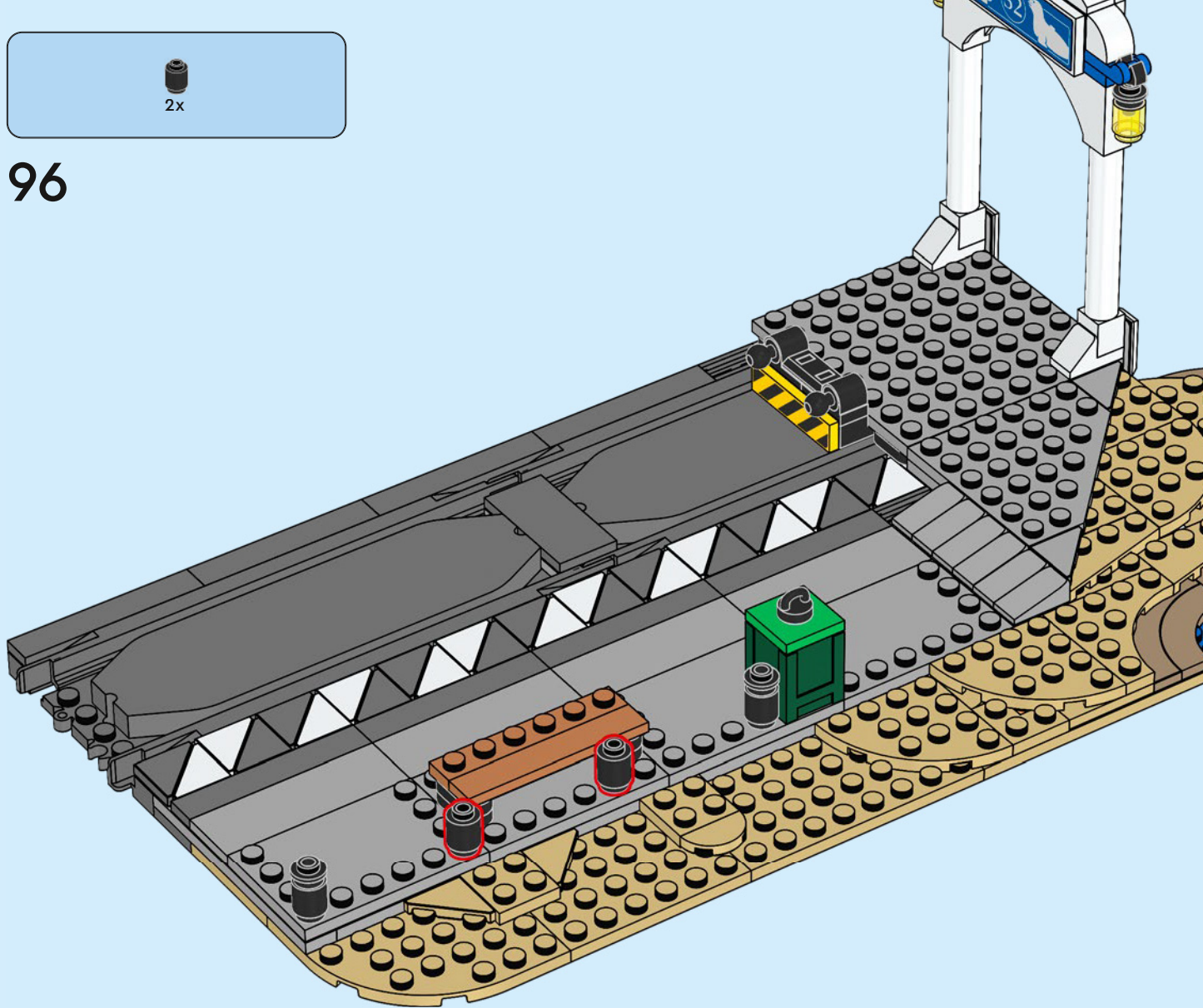

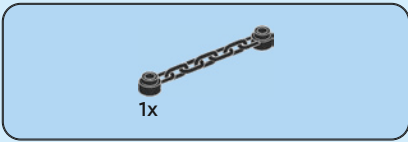

97

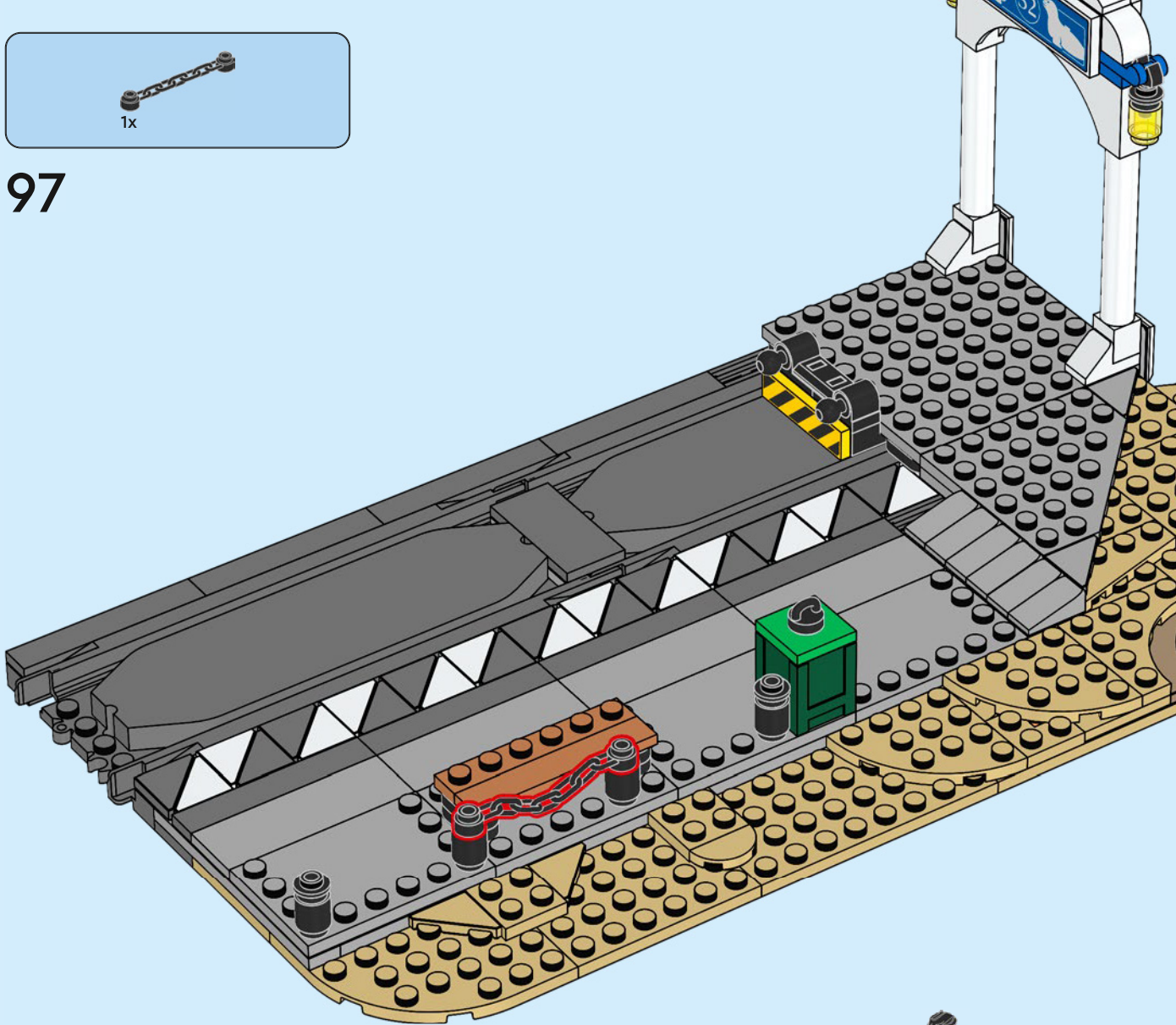

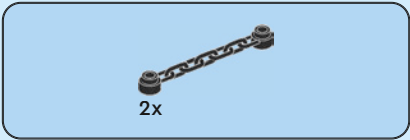

98

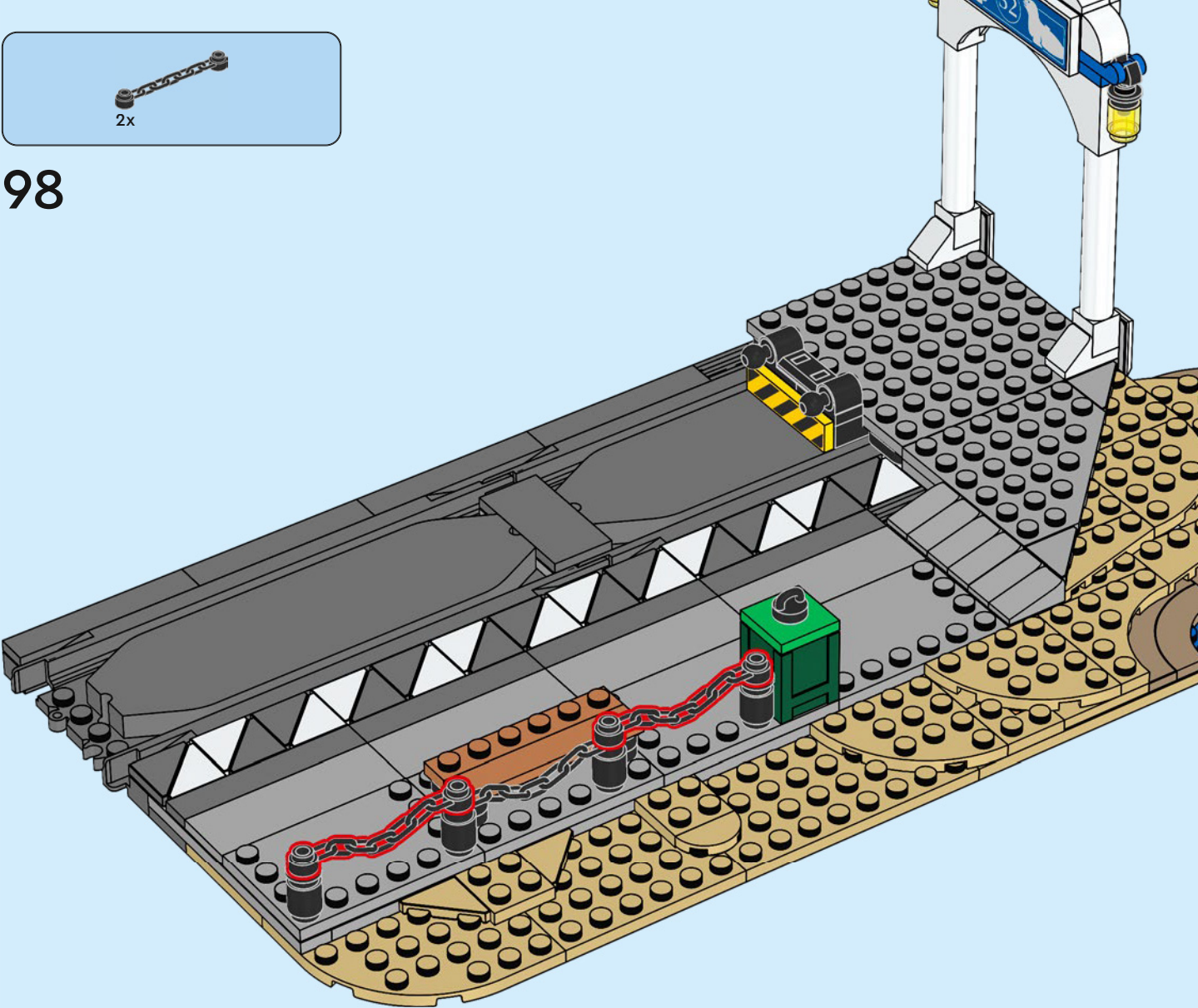



99

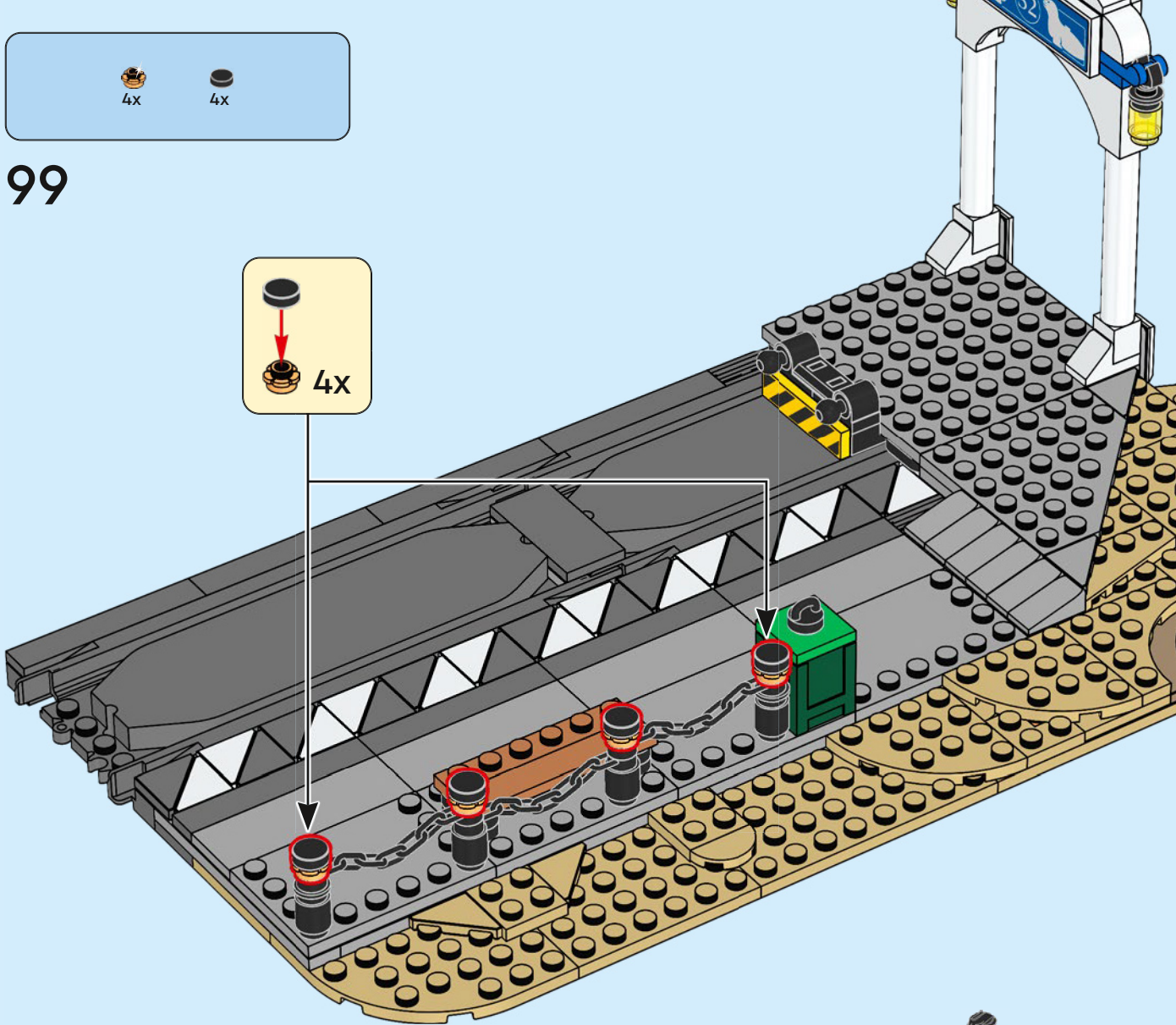
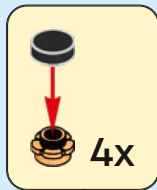

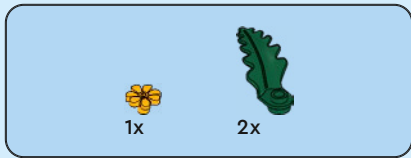

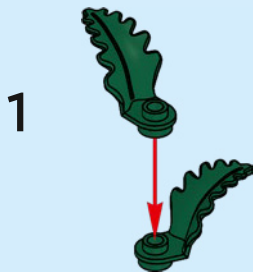

100



2





1x  1x 

101

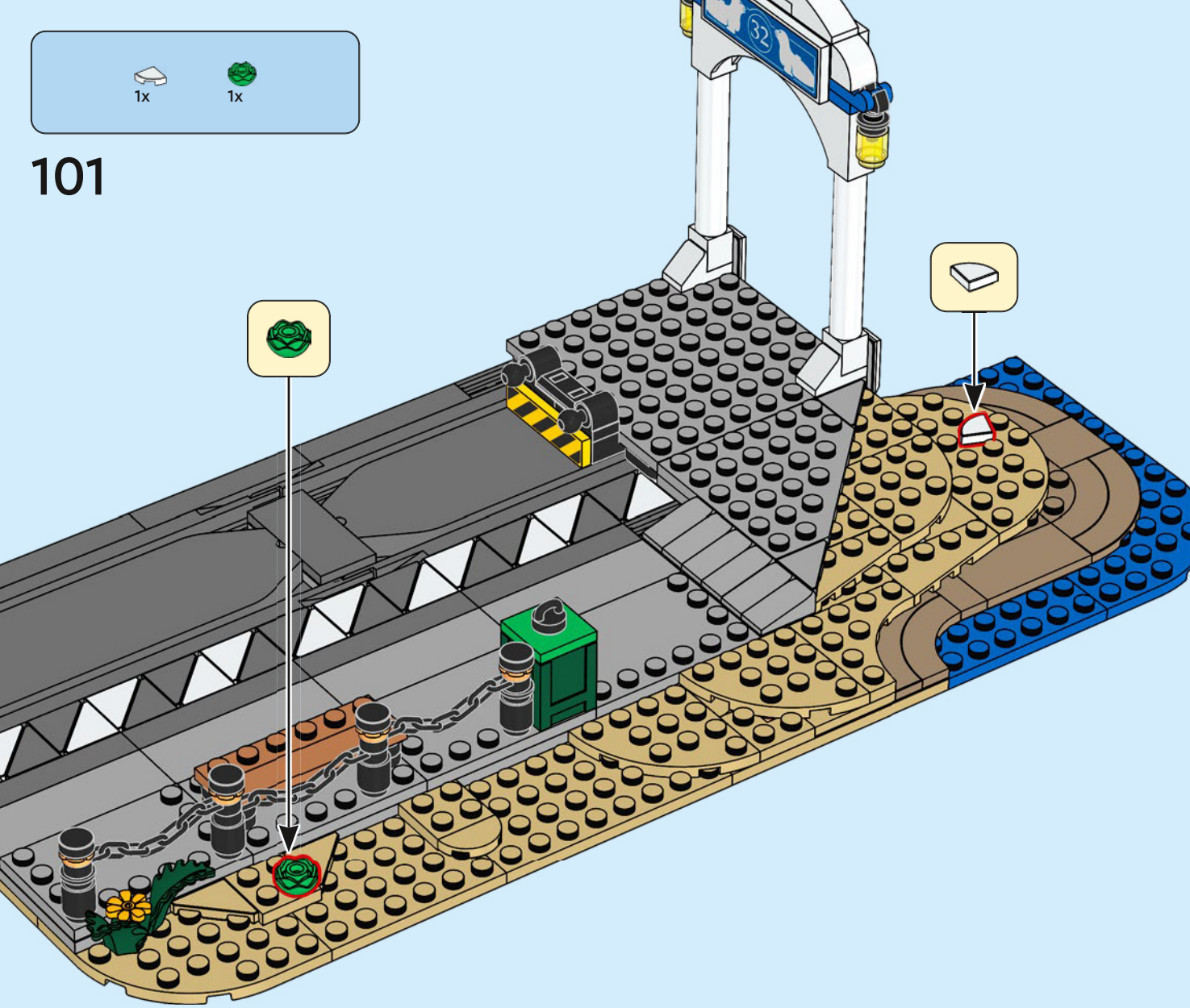

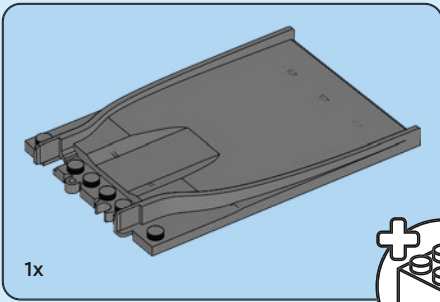

1x

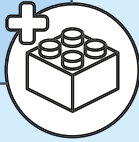

# 102

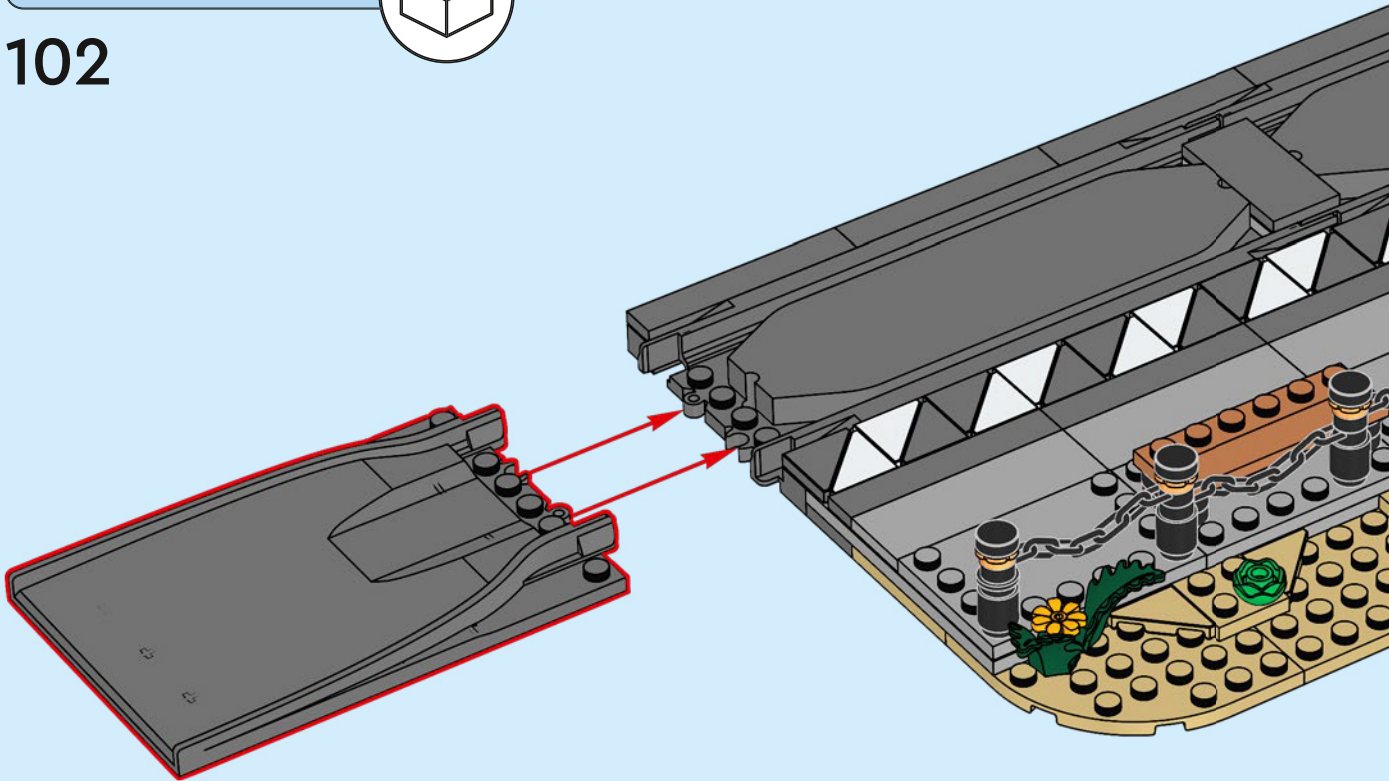

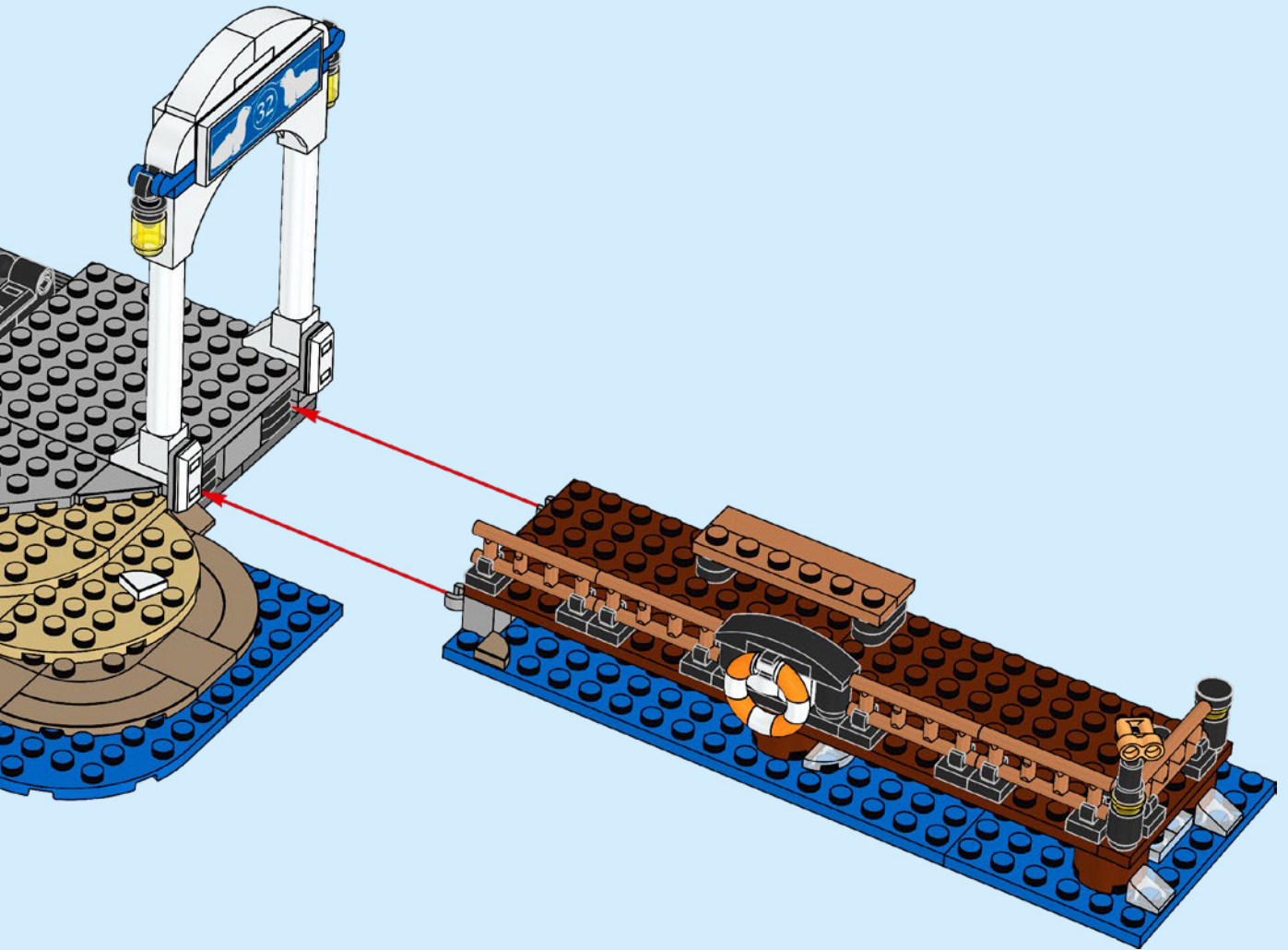





# CITY

60496



60501



60506



60511





# CITY

60494



60492



60497



60480



1x  
6438901

1x  
6186681

1x  
6172366

2x  
6073345

2x  
6536331

2x  
6059185

2x  
4667575

2x  
6210076

2x  
6069002

1x  
302301

1x  
241201

1x  
243201

1x  
6597562

1x  
6365487

13x  
6217875

1x  
6013866

1x  
434501

2x  
4249112

1x  
6553193

1x  
6270480

1x  
6632611

4x  
302101

1x  
4160215

1x  
371001

4x  
302001

4x  
4560178

1x  
6170419

2x  
6332042

1x  
6313647

1x  
303201

2x  
6538442

2x  
6510069

2x  
6177890

1x  
6236914

12x  
6468347

2x  
6314477

1x  
4114077

1x  
6131896

2x  
6287878

1x  
4113233

2x  
6115031

1x  
4114309

1x  
6294227

7x  
6351905

2x  
4243824

1x  
6371465

3x  
4570516

1x  
6331158

1x  
6123812

1x  
4125217

1x  
6056484

2x  
4509897

2x  
4249019

2x  
6070501

4x  
6117974

1x  
6253363

8x  
6315482

2x  
6073890

1x  
346023

2x  
4199519

1x  
6093691

1x  
303623

1x  
4610354

1x  
6311265

1x  
6642300

1x  
6434805

1x  
6599862

1x  
6271746



4x  
6117938



1x  
6329661



8x  
306226



8x  
6168646



5x  
6284070



1x  
6504712



2x  
6439039



1x  
6270122



1x  
6524887



2x  
6508152



8x  
6335388



1x  
6245281



2x  
6508152



1x  
6245281



2x  
6344752



2x  
6510214



1x  
6603222



10x  
6210270



20x  
6330189



11x  
4644456



2x  
6114987



4x  
6156991



1x  
6313116



2x  
6347310



3x  
241226



1x  
4538456



2x  
4107761



4x  
6527255



1x  
6599864



2x  
302226



2x  
242026



2x  
4565323



2x  
6469445



2x  
6476459



4x  
302126



1x  
371026



1x  
4613153



1x  
301026



2x  
6174917



2x  
302026



2x  
302026



2x  
4560182



3x  
6328408



2x  
370626



4x  
273026

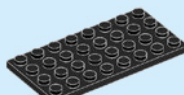

1x  
303526



1x  
6550579



1x  
6389692



1x  
6569034



1x  
6569871



1x  
6514191



2x  
6245250



12x  
6581359



3x  
6510073



1x  
6499105



2x  
6581839



3x  
6508337



2x  
6514100



2x  
6514189



2x  
6514236



2x  
6514056



1x  
6514194



3x  
6325978



1x  
6583363



2x  
6314091



1x  
6350418



1x  
6603225



1x  
6254100



6x  
4183133



5x  
6264062



3x  
6167483



1x  
4529160



1x  
6610087



1x  
6319295



1x  
6494416



3x  
6325978



1x  
6040126



2x  
6055172



1x  
4496699



1x  
4507045



1x  
6531809



2x  
6175927



3x  
6522842



1x  
6164288



1x  
6167854

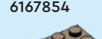

2x  
6151537

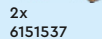

3x  
6490609

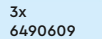

2x  
6395744



1x  
4162916



2x  
6581728

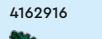

1x  
6530042



1x  
6452531



4x  
6328180

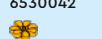

4x  
6478179



4x  
4211166

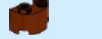

1x  
4224243



1x  
4216695



1x  
6196221



1x  
4211206



6x  
6251470



4x  
6100769



2x  
4211189



1x  
6257604



2x  
6599863



1x  
4221590



1x  
4211211



1x  
4211211



2x  
6338230



2x  
6338230

118



1x  
6057487



2x  
4211483



2x  
4211399



2x  
6345639



2x  
6345426



6x  
6493586



1x  
4211398



1x  
6004990



6x  
4211568



2x  
6217876



2x  
4211632



1x  
6319336



6x  
6469440



6x  
4211429



4x  
4645412



1x  
4221775



2x  
6118827



2x  
4211386



6x  
6257593



1x  
4211435



2x  
6015347



4x  
4211395



2x  
6132983



2x  
4211438



4x  
6318584



1x  
4211520

1x  
4211520

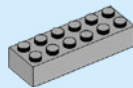

1x  
4211795



3x  
4211425



4x  
4211838

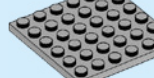

2x  
4211474

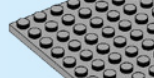

1x  
4166618



1x  
6494465

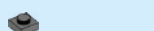

1x  
4210719

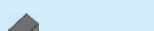

2x  
4504378

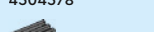

2x  
4210631



13x  
6262025

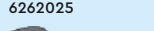

16x  
6071261

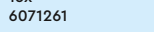

4x  
6469463

4x  
6469463



4x  
6440667



2x  
4568734



6x  
6395363



2x  
4211043



2x  
4211001



1x  
4560184



14x  
4210651



3x  
4211002



1x  
4257526



1x  
6000970



2x  
4210796

2x  
4210796

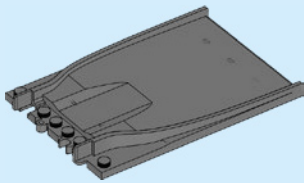

1x  
6486315

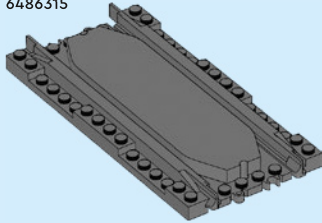

2x  
6530143



1x  
6519699



1x  
4654128



1x  
6490206



2x  
6531909



6x  
6209691



2x  
6592500



1x  
6034543



4x  
6503258



10x  
6170470



1x  
6409768



1x  
6554053



1x  
6517675



1x  
6262262



1x  
6334099



5x  
6535361



2x  
6102995



2x  
6295464



1x  
6363148



1x  
4611885



3x  
6514203



1x  
6043605



1x  
6599865



7x  
6097493



4x  
6150307



5x  
6396673



2x  
6097419



4x  
6071246



2x  
6322828



8x  
6555310



2x  
6598402



4x  
6119126



1x  
4625032



4x  
6176171



4x  
6258069



11x  
6119107

4x  
6465291



2x  
6598403



2x  
4655256



2x  
4619653



2x  
4619653



1x  
6146926



2x  
6078339



2x  
6074793



1x  
6253666



2x  
6603223



 [LEGO.com/service](https://www.LEGO.com/service)

YOU COULD

WIN

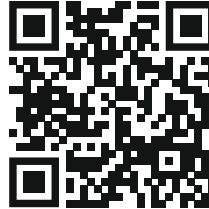

Scan this QR code or go to **LEGO.COM/PRODUCTFEEDBACK** and give us your short feedback about this LEGO® set for a chance to win a cool LEGO prize.

Terms and Conditions apply\*

**EN: YOU COULD WIN.** Terms and Conditions apply\* **DE: Du könntest GEWINNEN.** Es gelten die Teilnahmebedingungen\* **FR: TU POURRAIS GAGNER.** Des conditions s'appliquent\* **IT: Potresti VINCERE tu.** Termini e condizioni sono applicabili\* **ES: PUEDES GANAR.** Aplican términos y condiciones\* **PT: PODERÁ GANHAR.** Aplicam-se Termos e Condições\* **ZH: 轻松获奖. 条款和条件适用\*** **PL: Szansa na WYGRANĄ.** Obowiązuje regulamin\* **CS: Máte šanci VYHRÁT.** Platí všeobecné smluvní podmínky\* **SK: Máte šancu VYHRAŤ.** Platia všeobecné zmluvné podmienky\* **HU: TE IS NYERHETSZ!** Felhasználási feltételek érvényesek\* **UA: ВИ МОЖЕТЕ ВИГРАТИ.** Застосовуються загальні положення та умови\* **RO: Ai putea CÂȘTIGA.** Se aplică termeni și condiții\* **BG: Можете да СПЕЧЕЛИТЕ.** Има определени правила и условия\* **LV: Tu vari LAIMĒT.** Ir spēkā noteikumi un nosacījumi.\* **ET: Sul on võimalus VÕITA.** Kehtivad tingimused\* **LT: Jūs galite LAIMĖTI.** Taikomos sąlygos\* **TR: KAZANABİLİRSİN.** Şartlar ve Koşullar geçerlidir\*

\*[LEGO.com/productfeedback-terms](https://www.lego.com/productfeedback-terms)

LEGO and the LEGO logo are trademarks of the LEGO Group. ©2026 The LEGO Group.