



CITY

60501



LEGO® Builder



LEGO.com/sustainable-packaging



FR
DONNEZ
OU
RECYCLEZ



OU



OU



ASSOCIATION

MAGASIN

DÉCHÈTERIE

Adresses sur quefairedemesdechets.fr

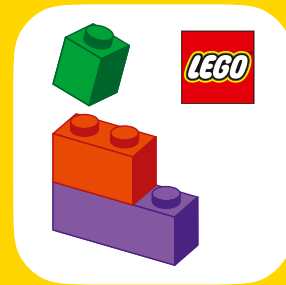

LEGO® Builder



BUILDER



Apple and the Apple logo are trademarks of Apple Inc., registered in the U.S. and other countries and regions. App Store is a service mark of Apple Inc. Google Play and the Google Play logo are trademarks of Google LLC. Tencent and the Tencent logo are trademarks of Tencent Inc.

LEGO.com/devicecheck

EN Ask parents' permission before going online | **DE** Eltern um Erlaubnis bitten, bevor du online gehst | **FR** Demande l'autorisation d'un parent avant d'aller en ligne | **IT** Chiedi il permesso ai tuoi genitori prima di andare online | **ES** Pídeles permiso a tus papás antes de conectarte a Internet | **PT** Pede autorização aos teus pais antes de ficares online | **ZH** 上网前应先征得父母的同意 | **PL** Poproś rodziców o zgodę, zanim wejdiesz do Internetu | **CS** Než půjdeš na internet, požádej rodiče o svolení | **SK** Skôr než pôjdeš na internet, vypýtaj si povolenie od rodičov | **HU** Kérj szülői engedélyt, mielőtt online csatlakoznál! | **UA** Запитуйте дозволу батьків, перш ніж користуватися інтернетом | **RO** Cere permisiunea părinților înainte de a te conecta online | **BG** Поискайте разрешение от родител, преди да влезете онлайн | **LV** Pirms došanās tiešsaistē palūdz atļauju vecākiem | **ET** Enne Interneti kasutamist küsi vanematelt luba | **LT** Prieš prisijungdami prie interneto, atsiklauskite tėvų | **TR** İnternete girmeden önce anne babandan izin iste

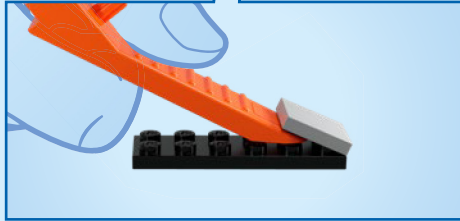
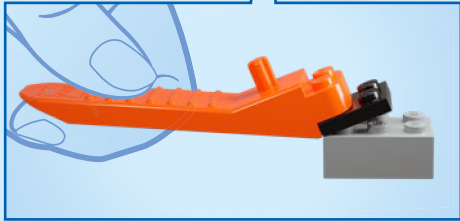
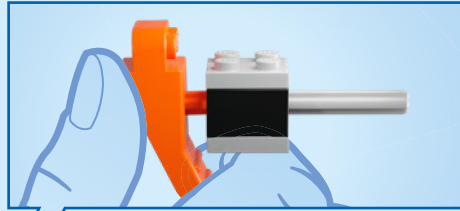
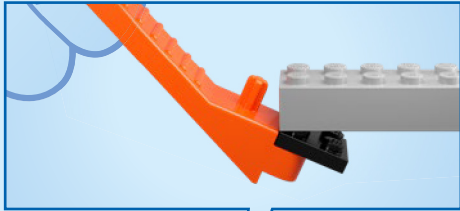

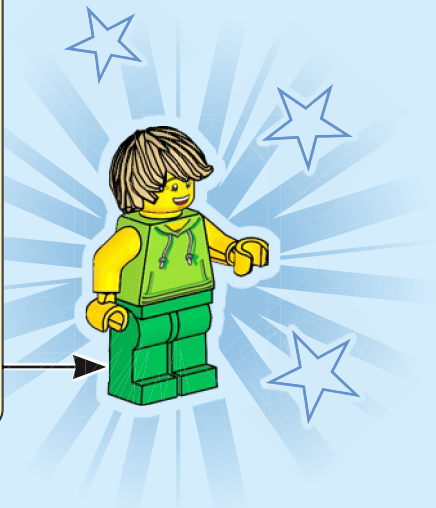
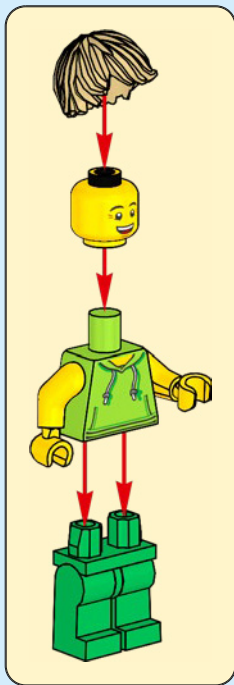

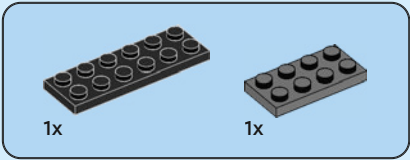

1

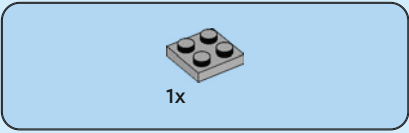
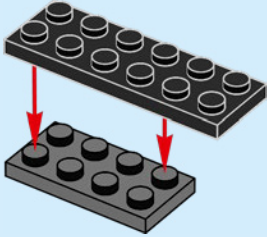

2

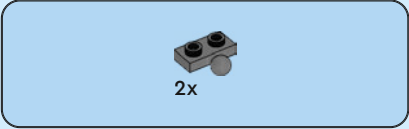
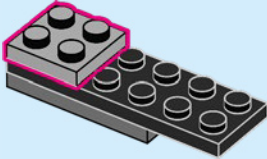

3

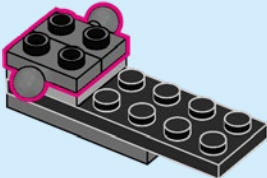



2x

4

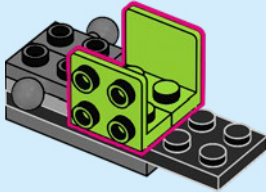

1x

5

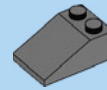
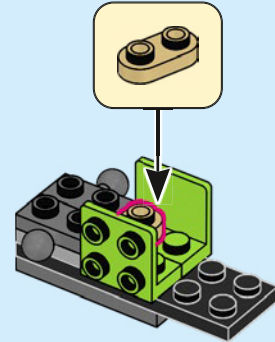

1x

6

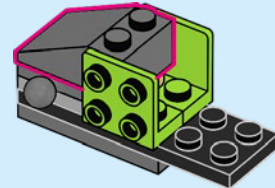



1x



1x

7

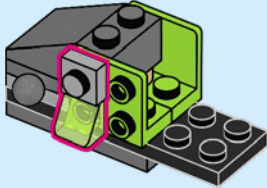

1x



1x

8

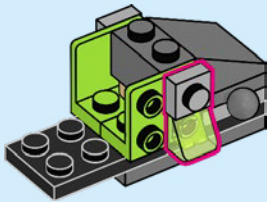
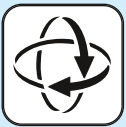

2x

9

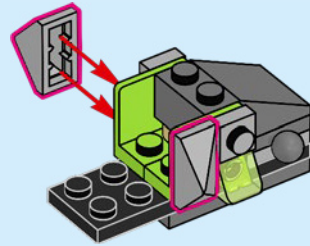

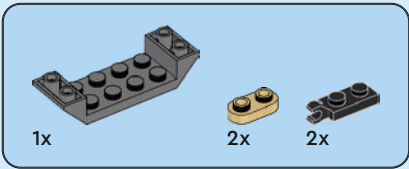

10

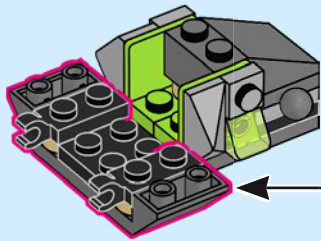
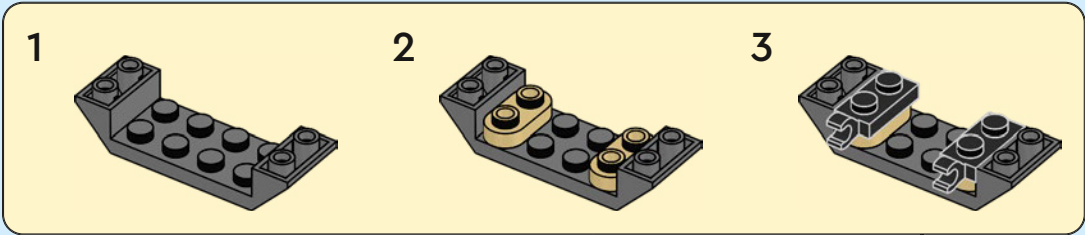

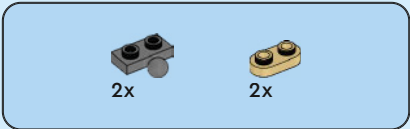

11

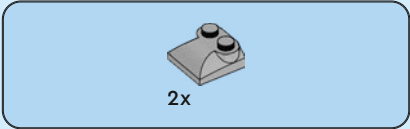
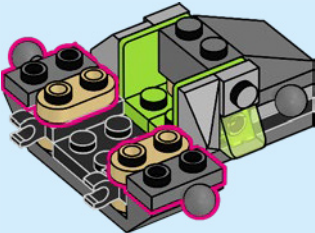

12

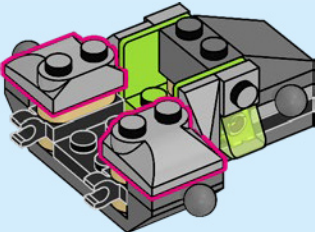

13

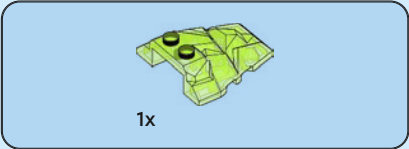
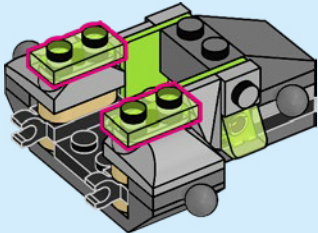

14

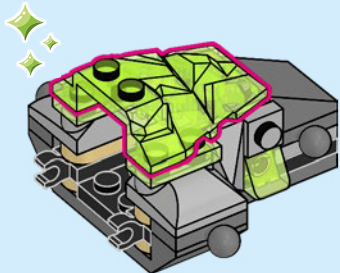

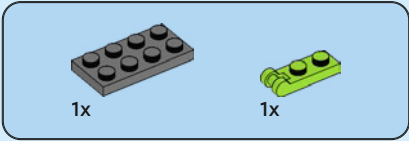

15

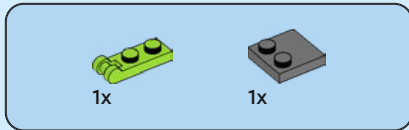
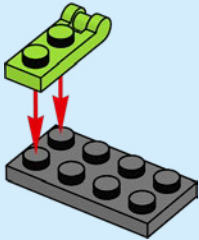

16

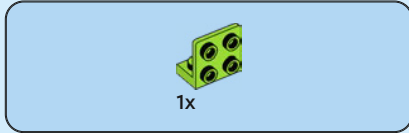
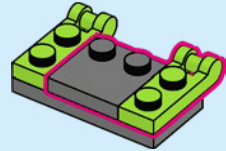

17

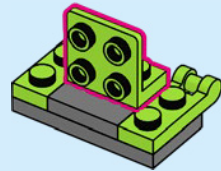



2x

18

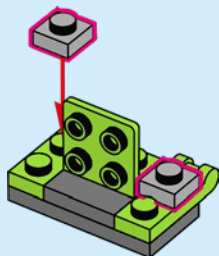

1x

19

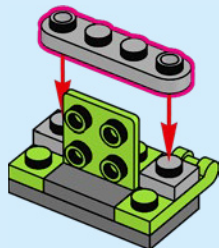

1x

20

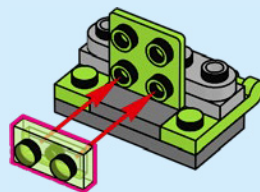



2x

21

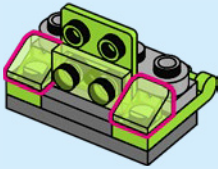

1x



1x

22

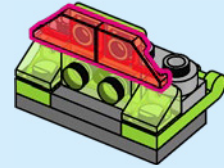

1x

23

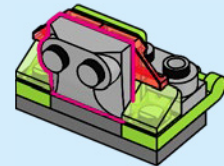

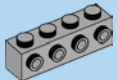

1x

24

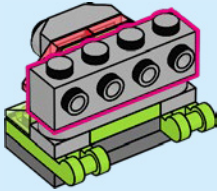

2x

25

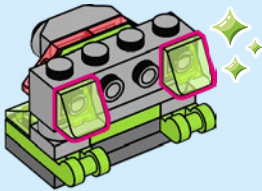

1x

26

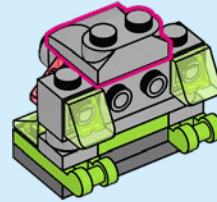

2x

27

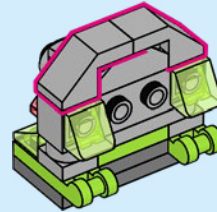

28

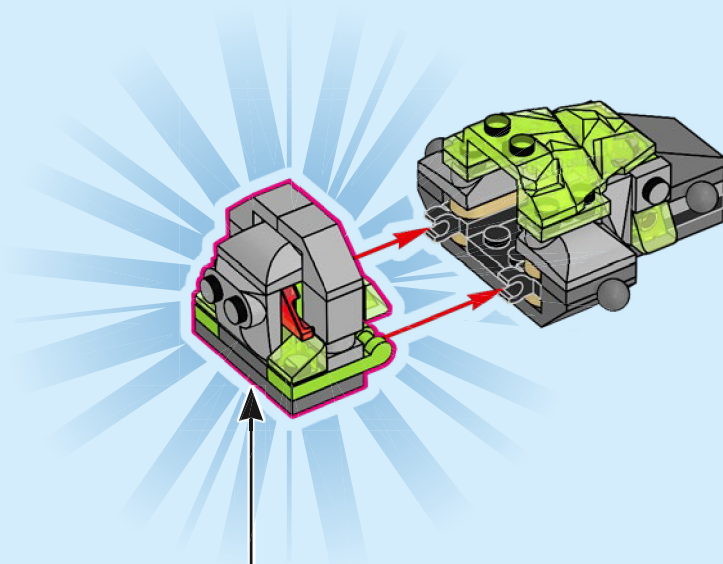

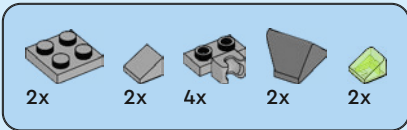

29

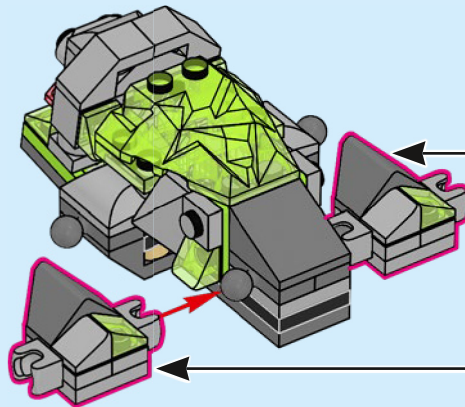
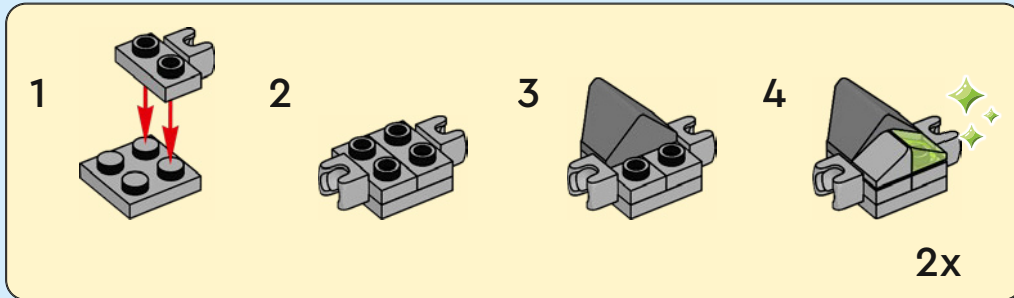



2x

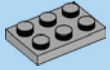

1x

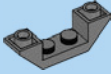

1x

30

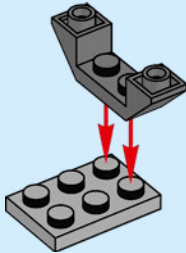

1x



1x

31

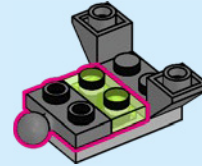

1x



1x

32

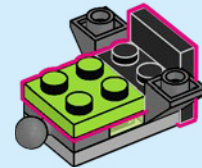

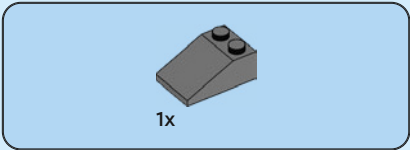

33

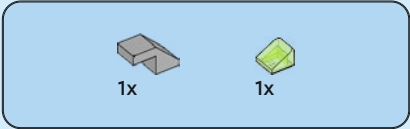
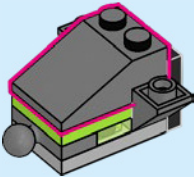

34

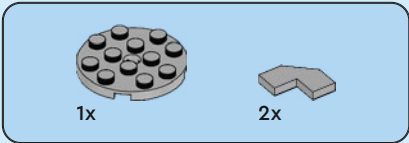
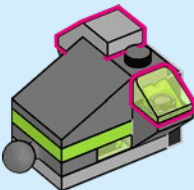

35

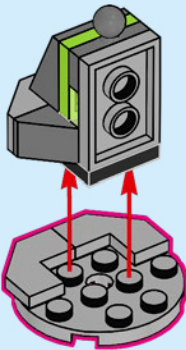
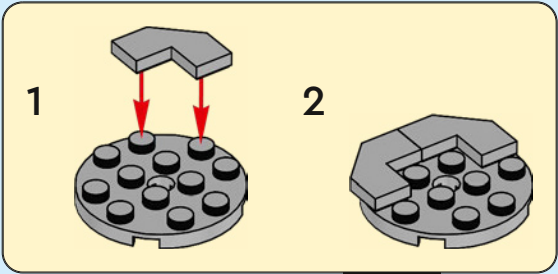



1x

36

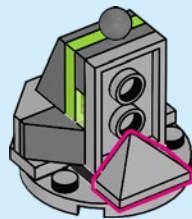

2x

37

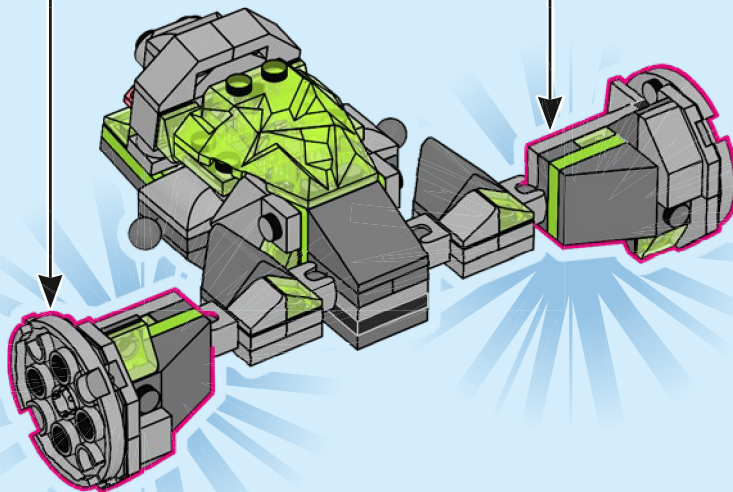

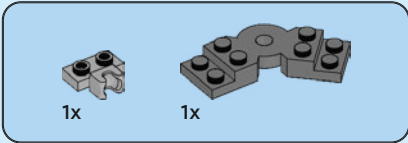

38

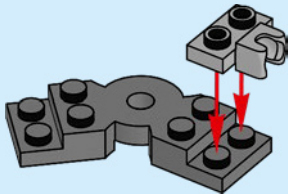

39

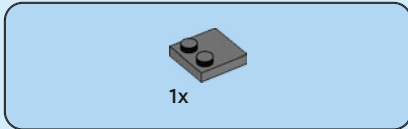
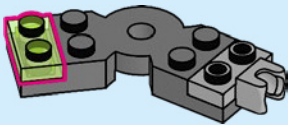

40

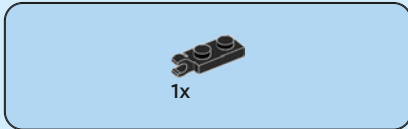
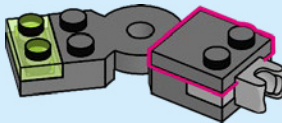

41

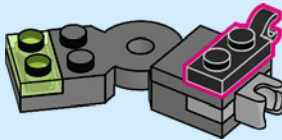

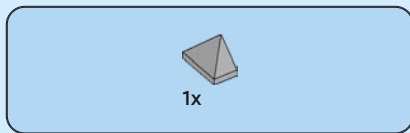

42

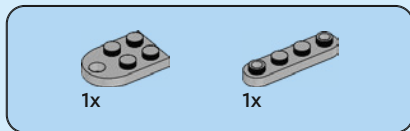
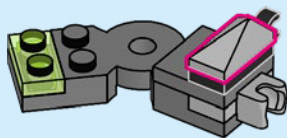

43

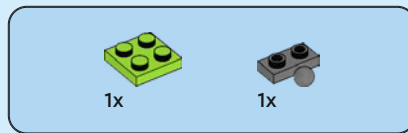
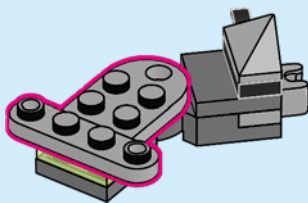

44

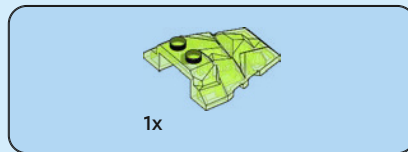
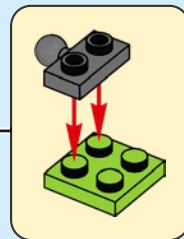
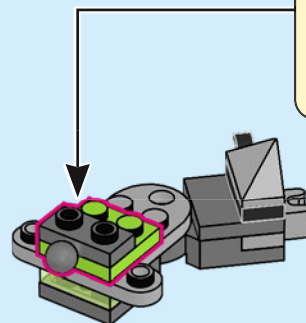

45

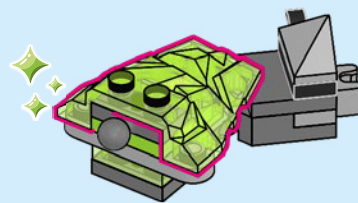

46

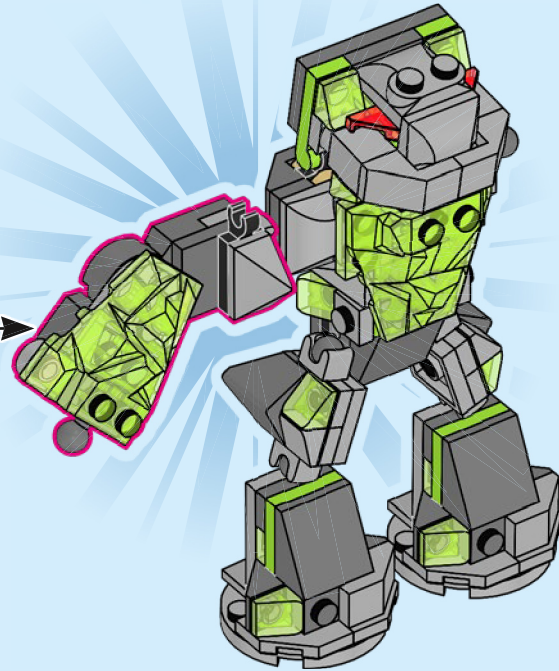

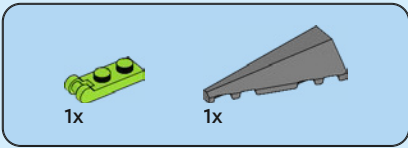

47

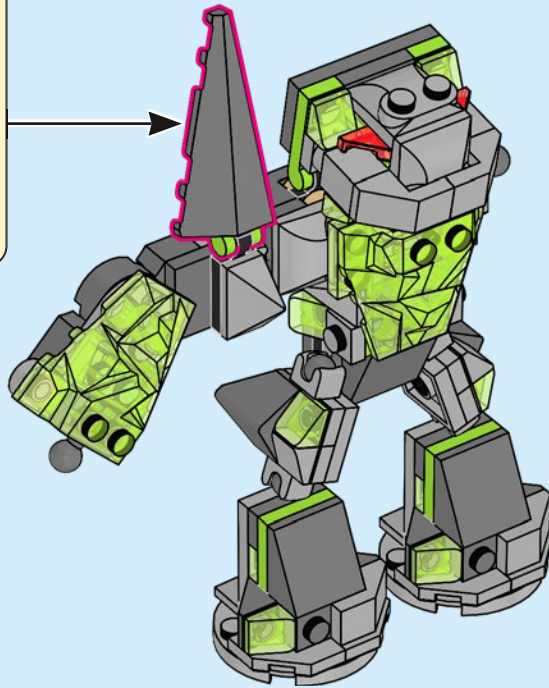
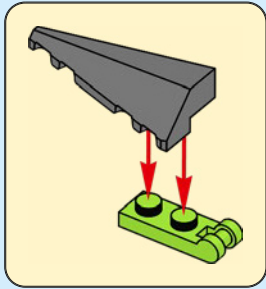

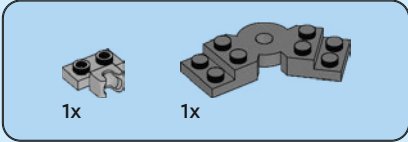

48

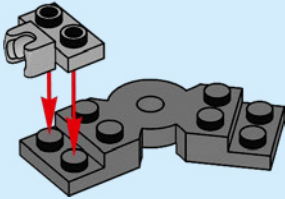

49

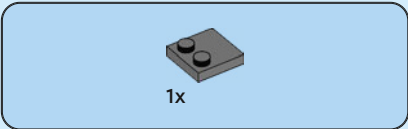
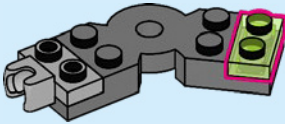

50

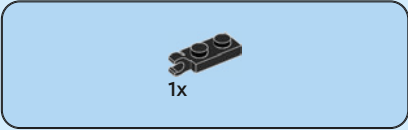
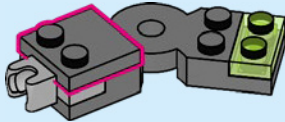

51

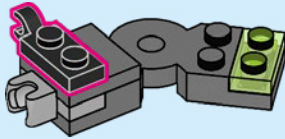



1x

52

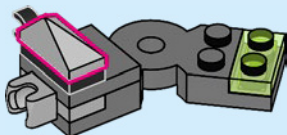

1x



1x

53

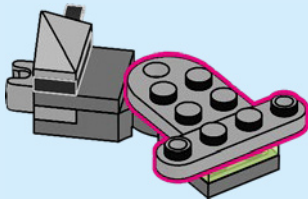

1x



1x

54

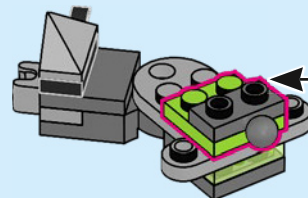
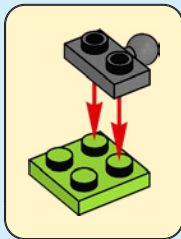

1x

55

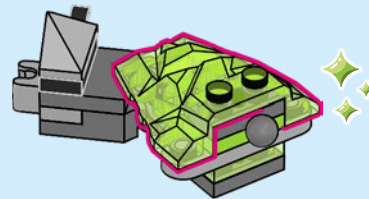

56

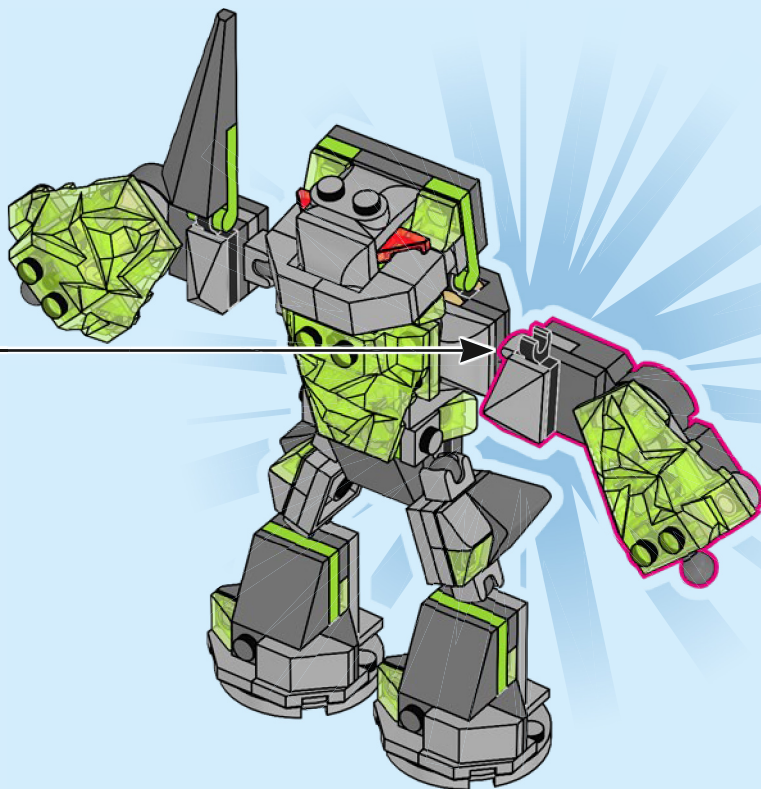

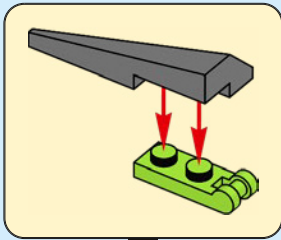
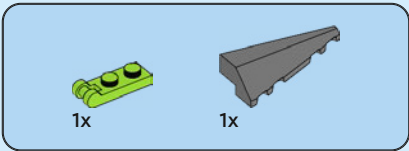

57

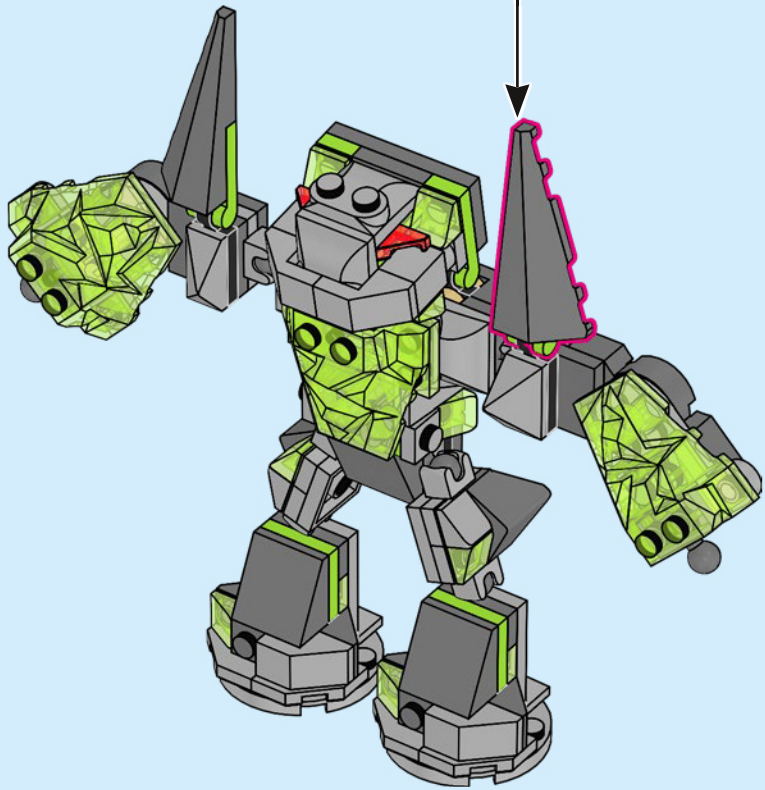



2x



1x



1x

58

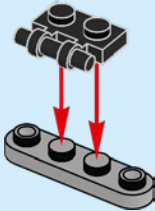

2x

59

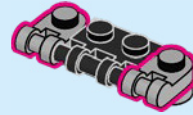

1x

60

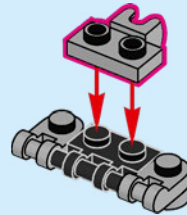

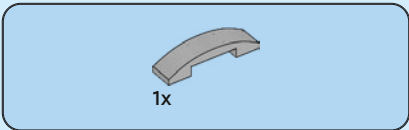

61

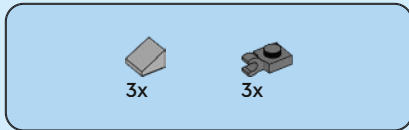
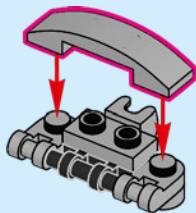

62

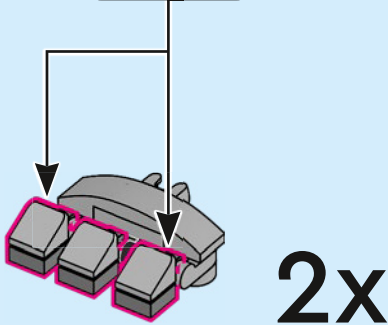
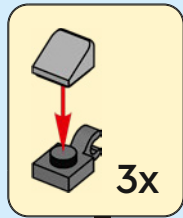

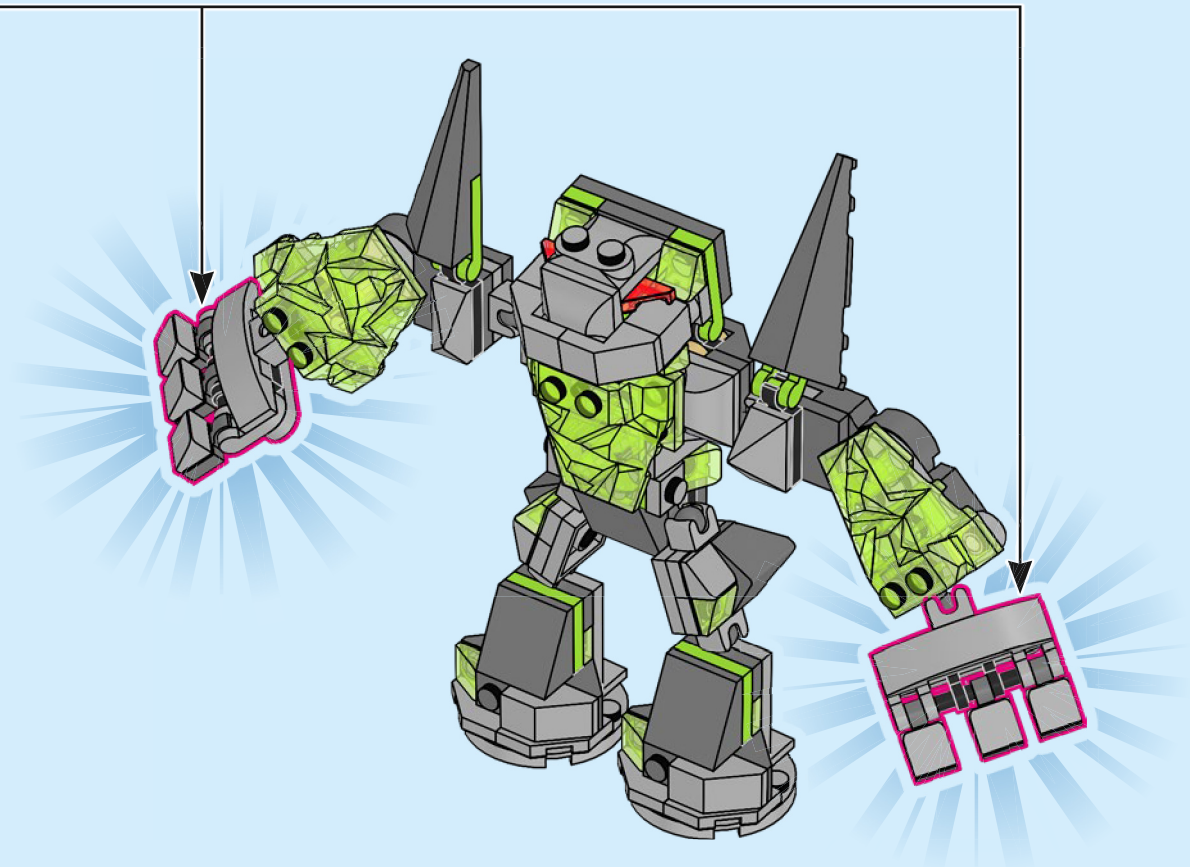

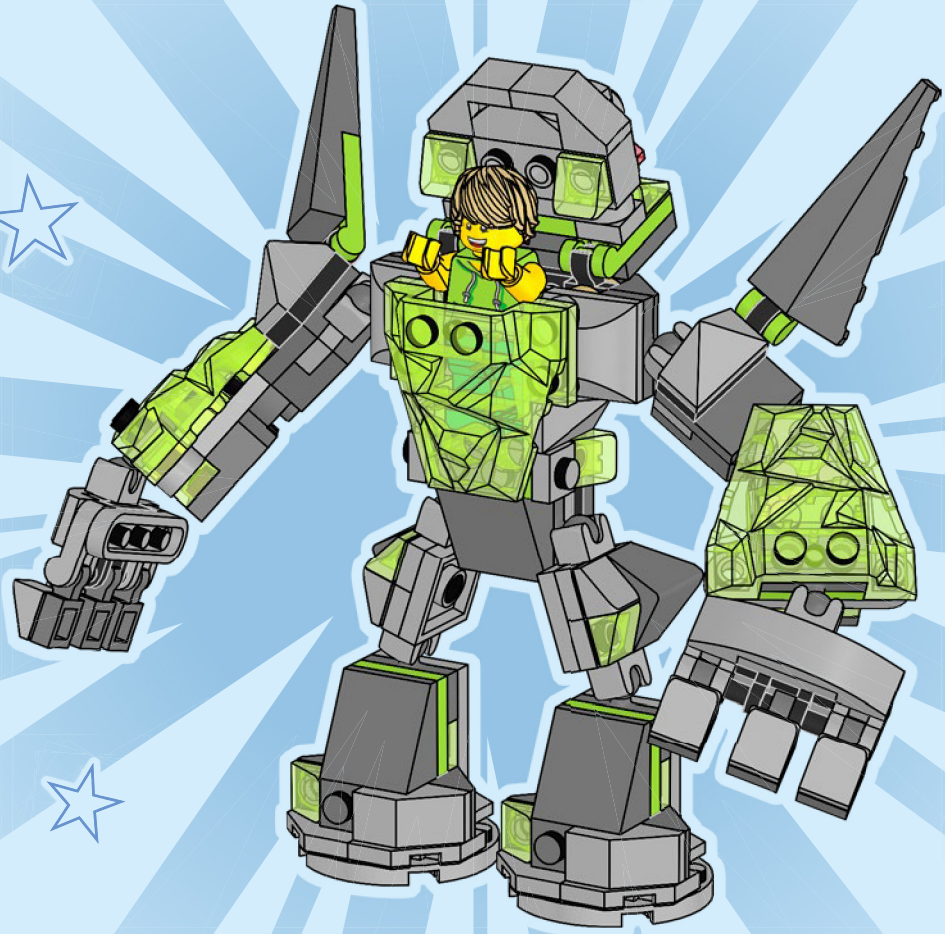



**Rebuild
the
World™**



LEGO and the LEGO logo are trademarks of the LEGO Group.
©2026 The LEGO Group.

 6650694