



CITY

60496



2

3

4

5

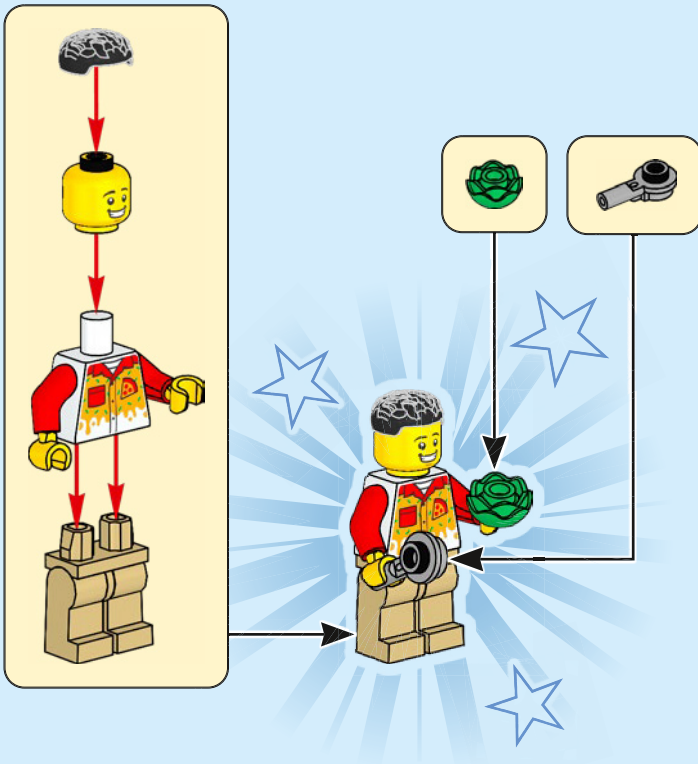

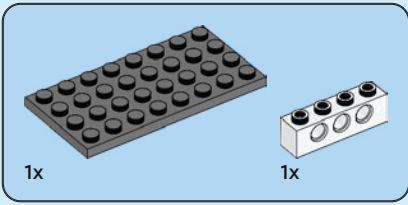

1

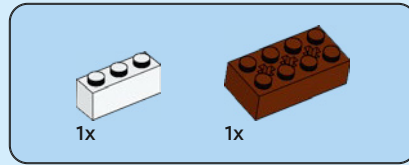
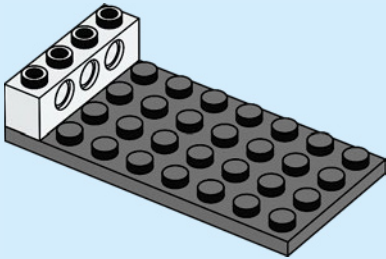

2

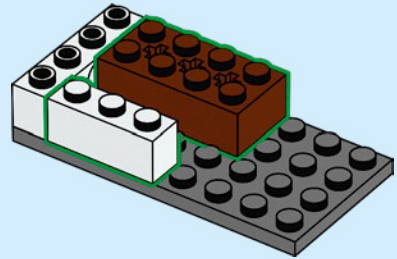

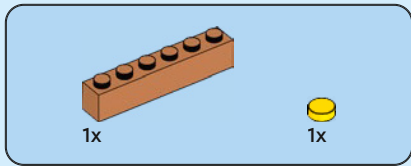

3

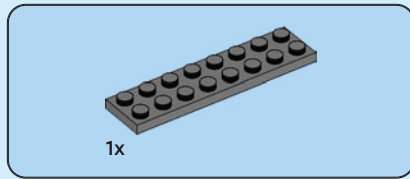
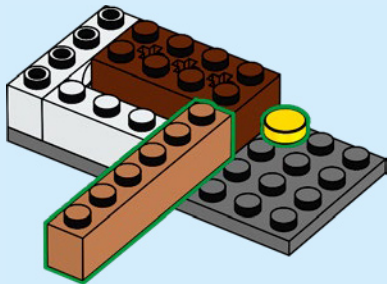

4

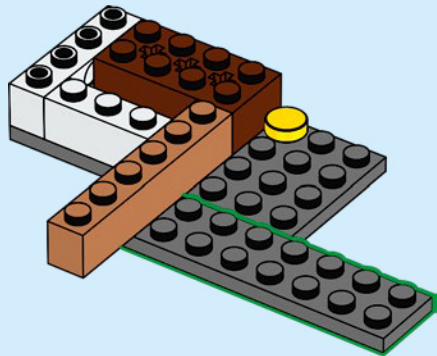

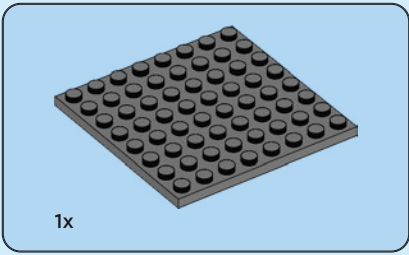

5

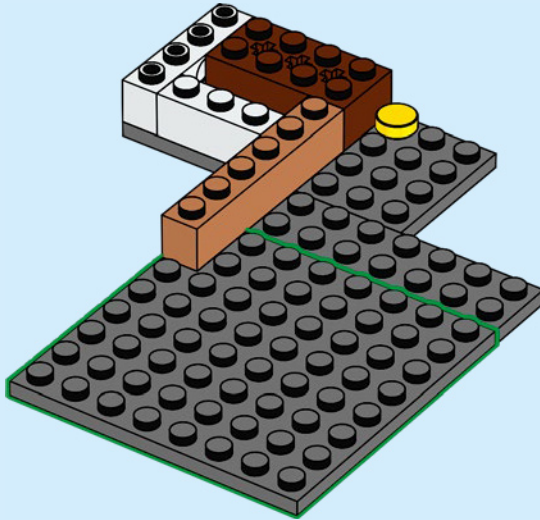

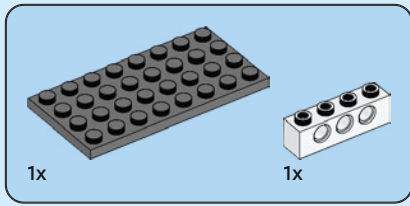

6

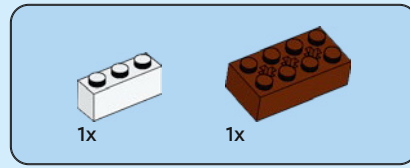
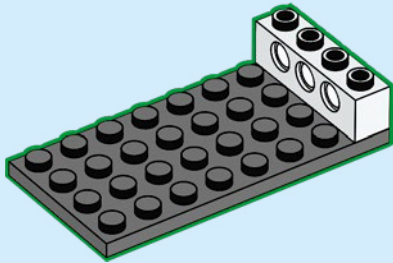

7

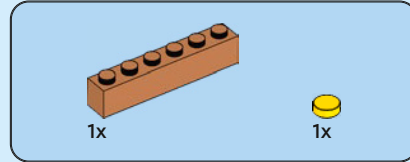
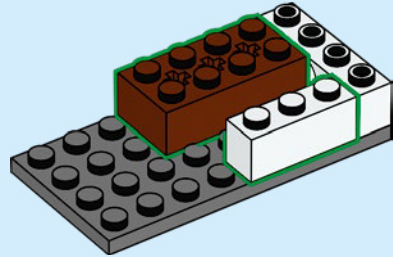

8

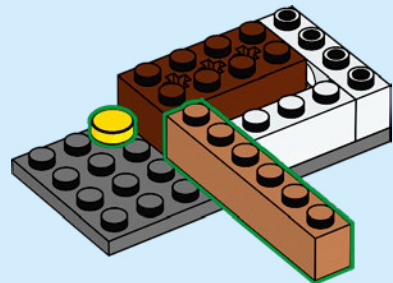

9



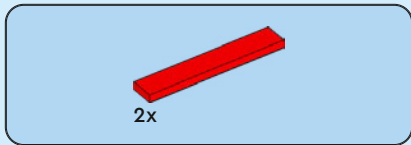

10

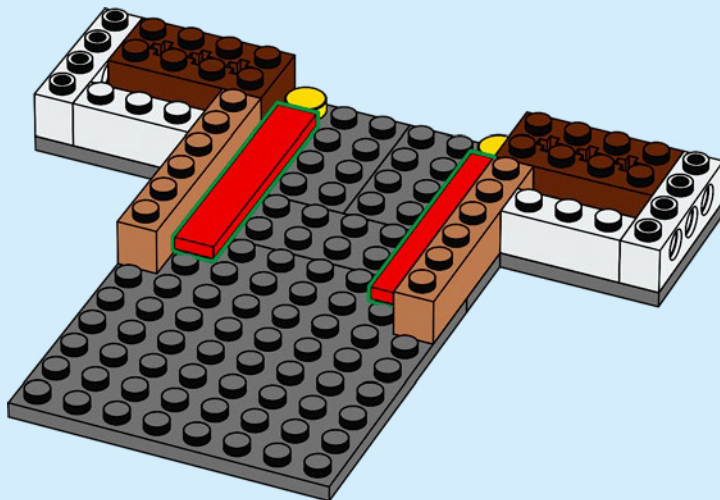

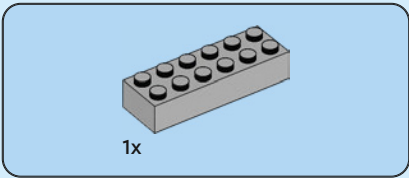

11

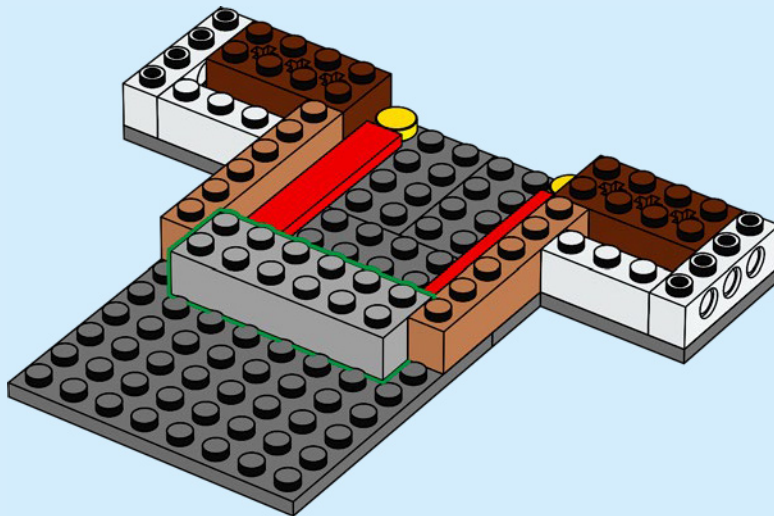



1x

12

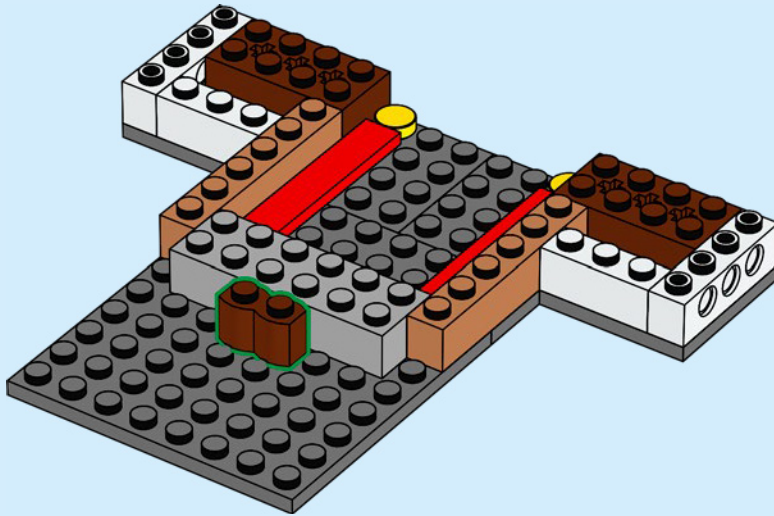

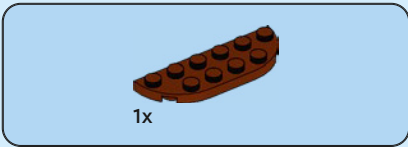

13

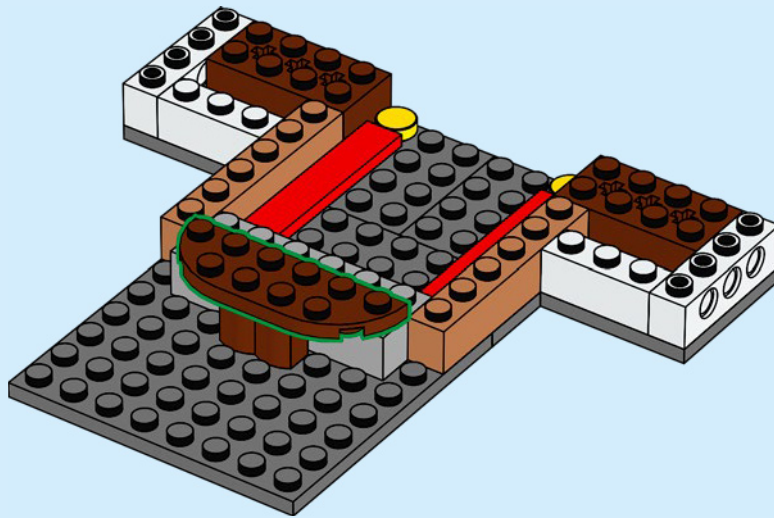

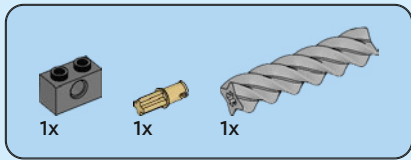

14

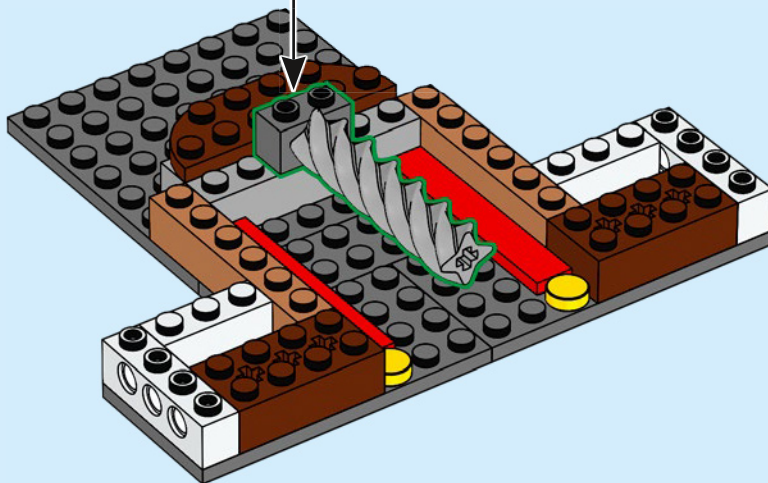
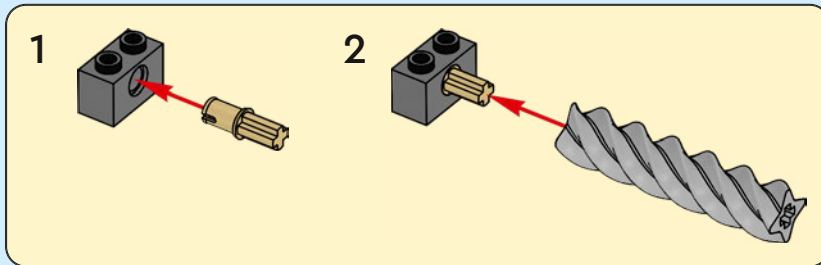

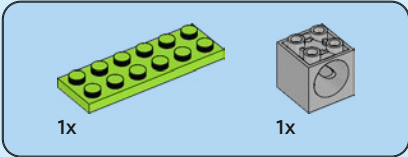
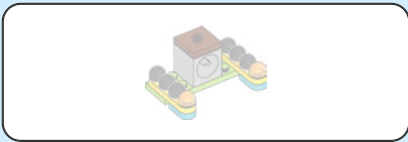

15

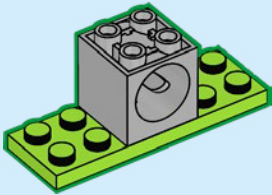

16

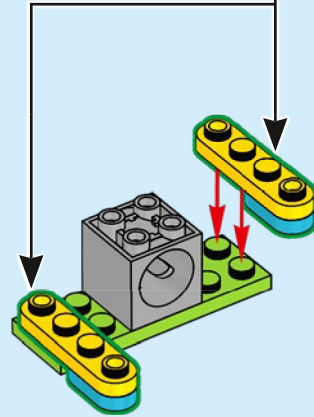
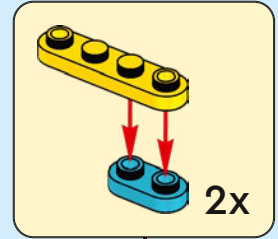



2x

17

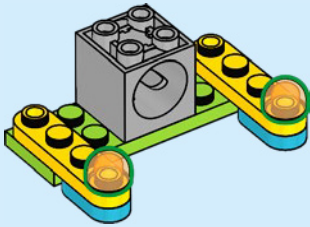

6x

18

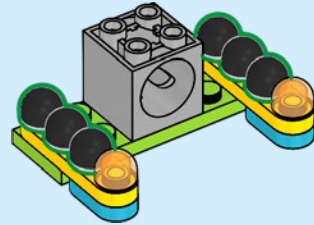

1x

19

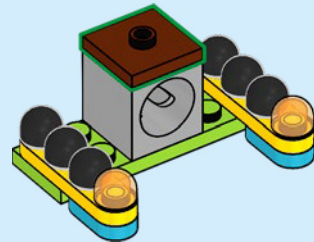

20

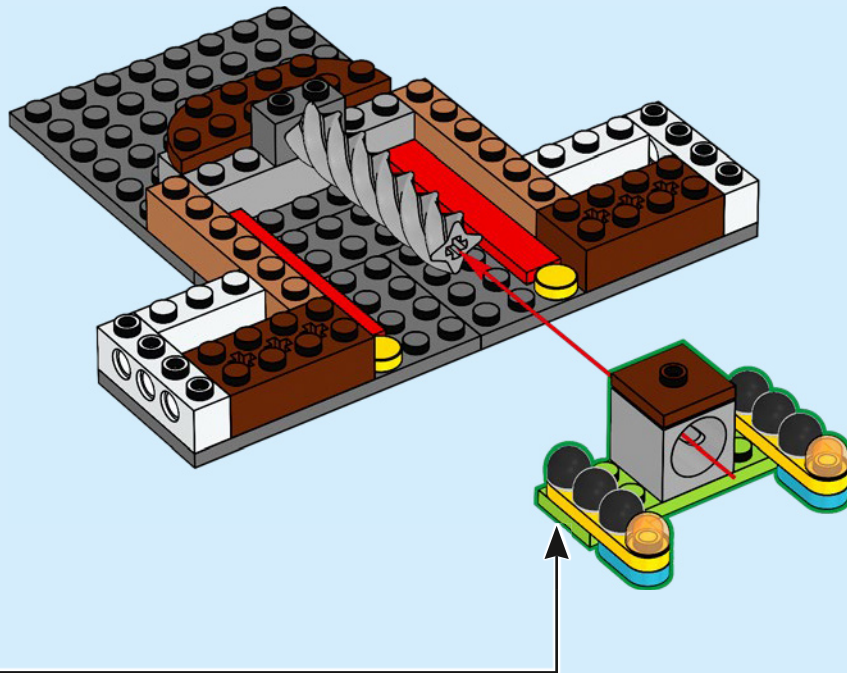



2x

21

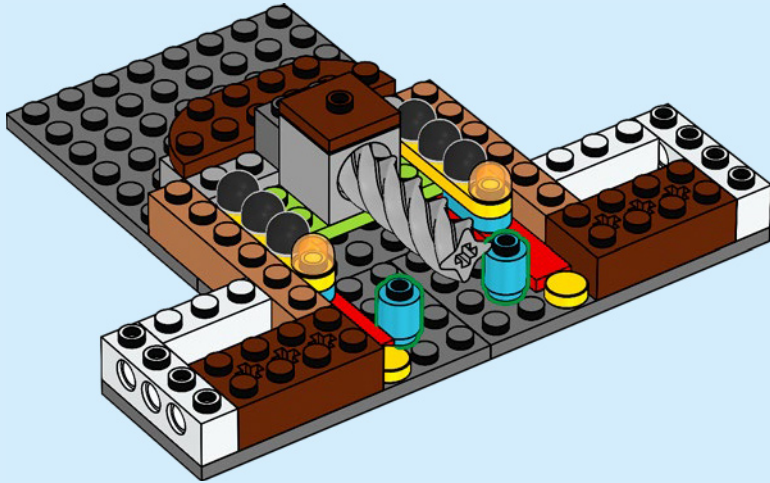

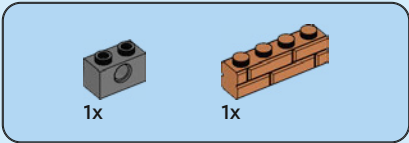

22

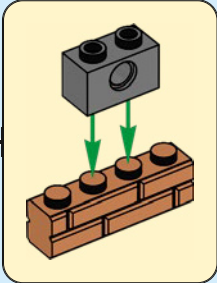
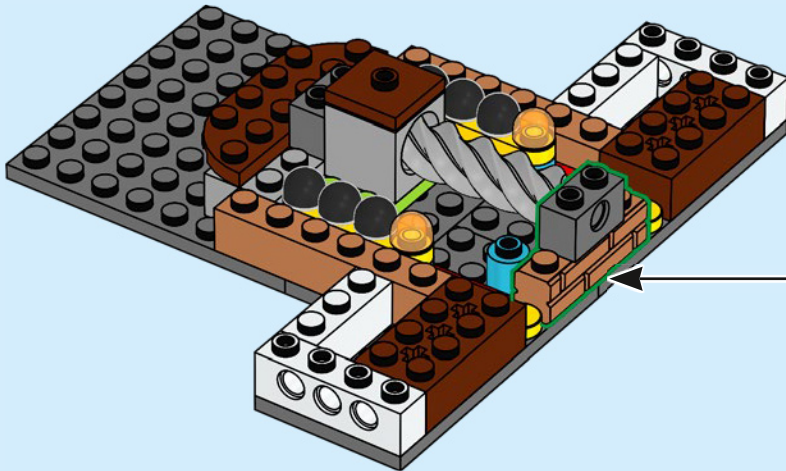

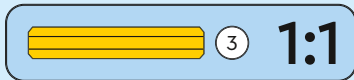
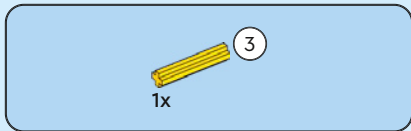

23

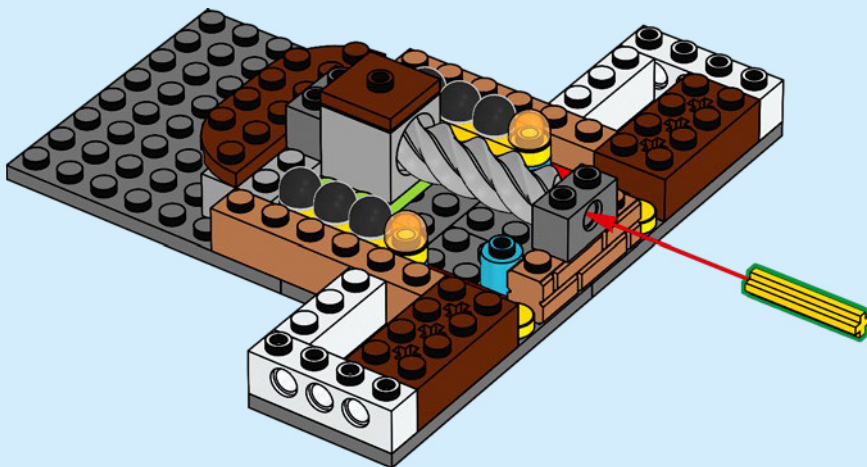



1x

24

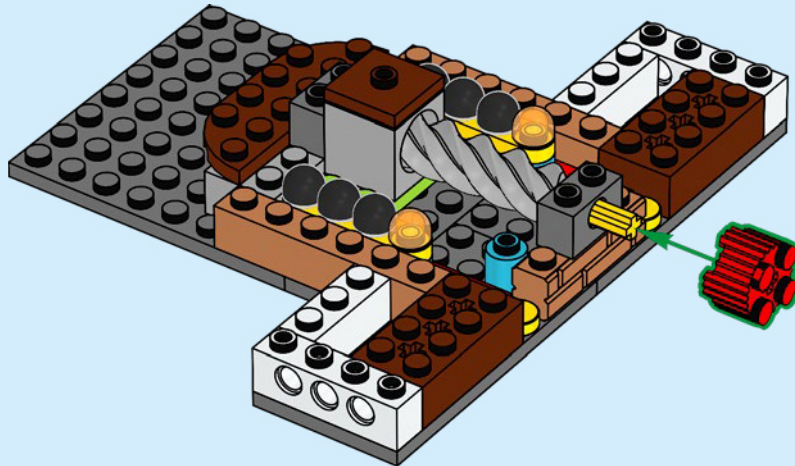

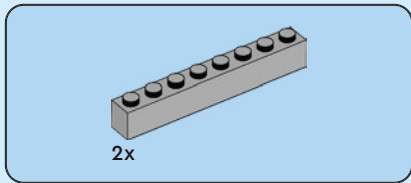

25

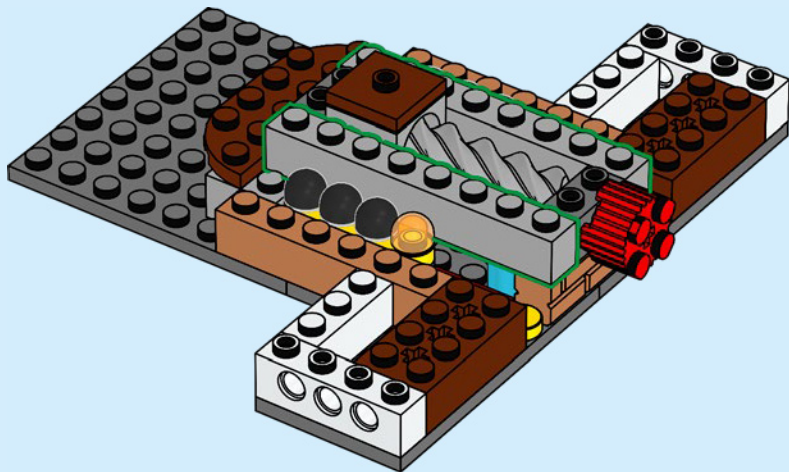



1x

26

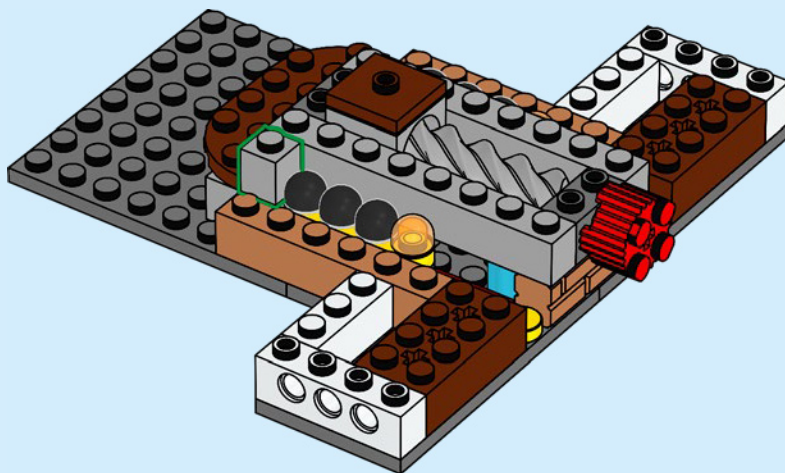

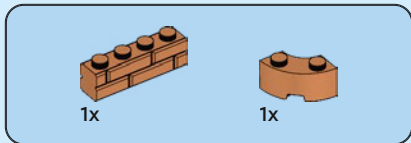

27

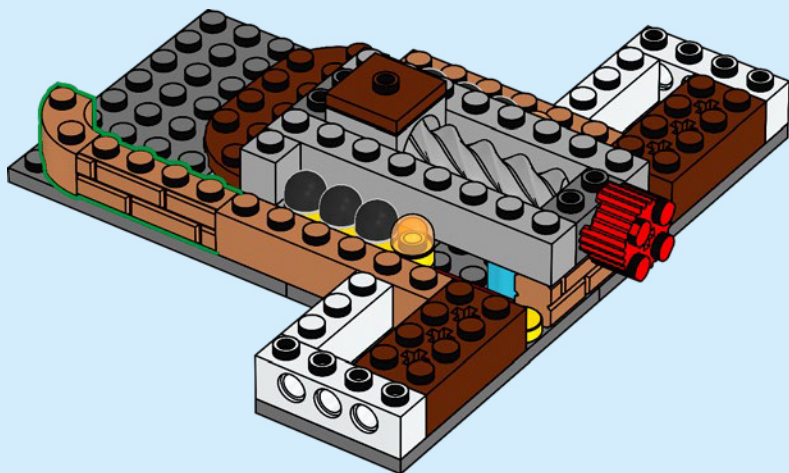



2x

28

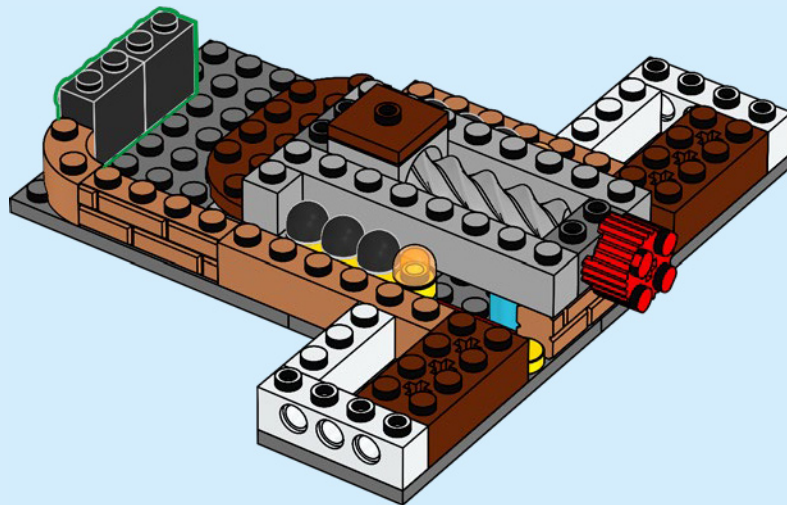

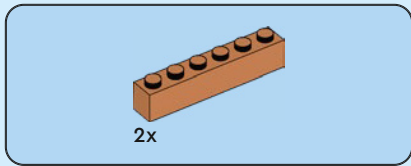

29

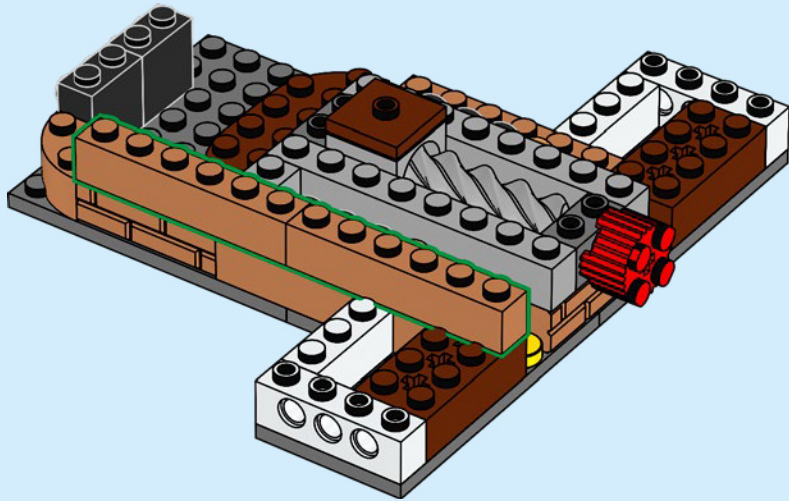

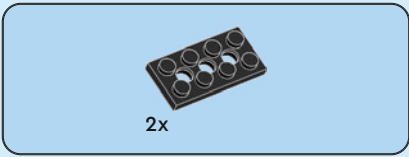

30

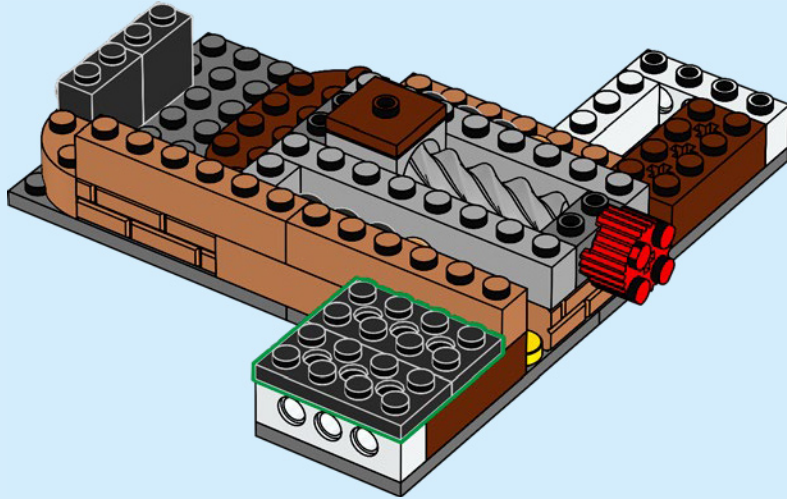

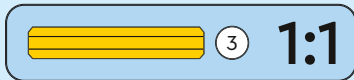
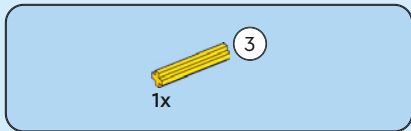

31

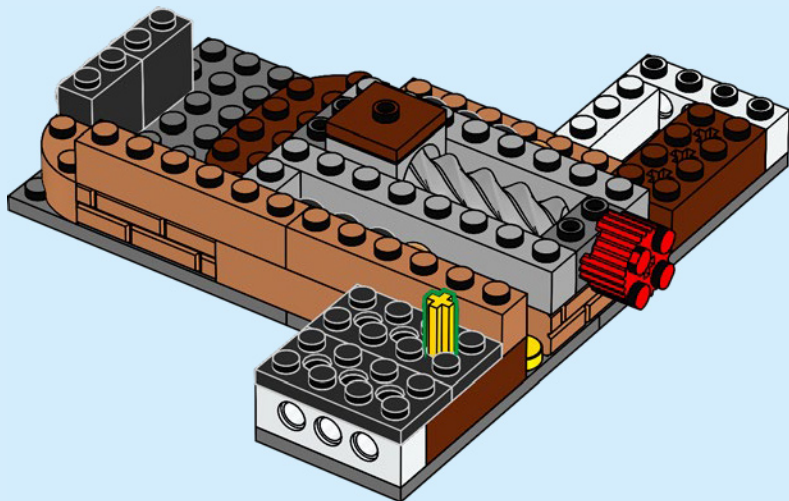



1x

32

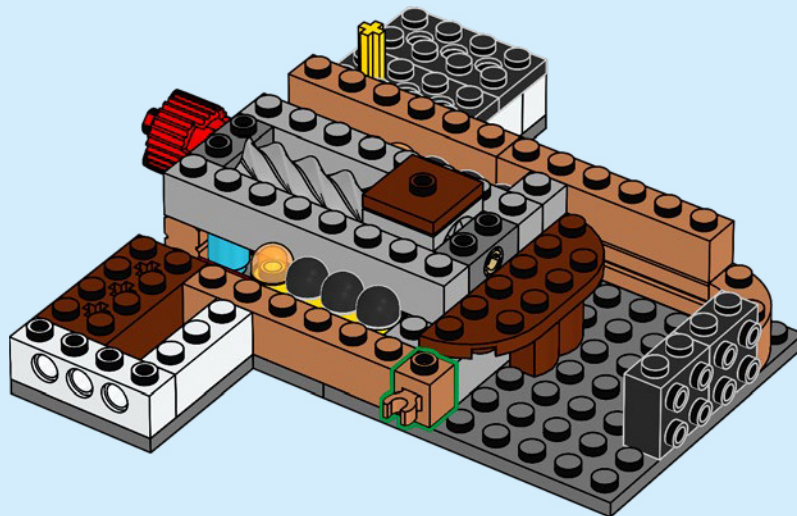



1x

33

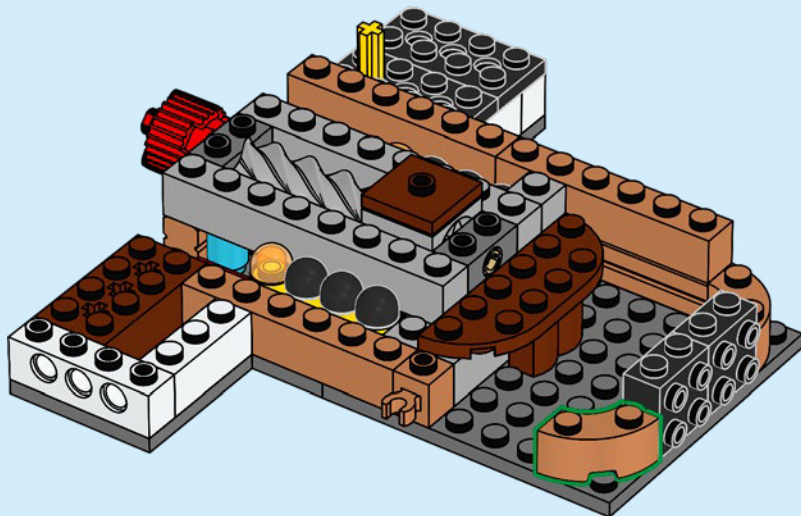



1x

34

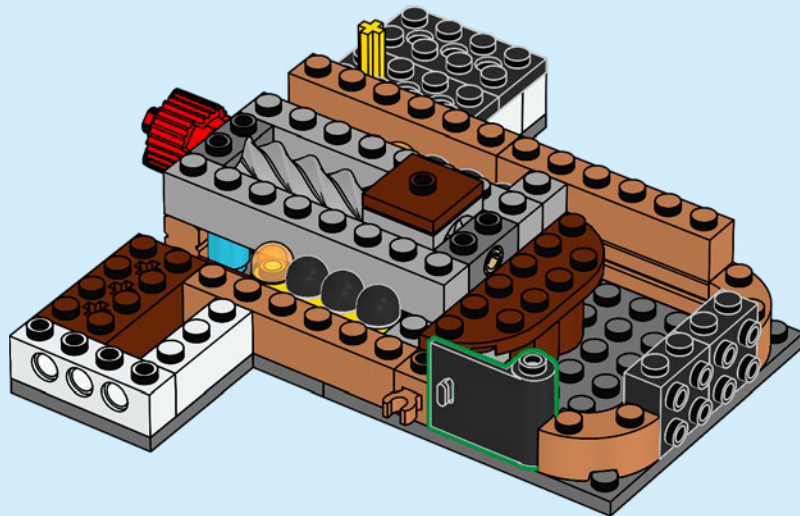



1x

35

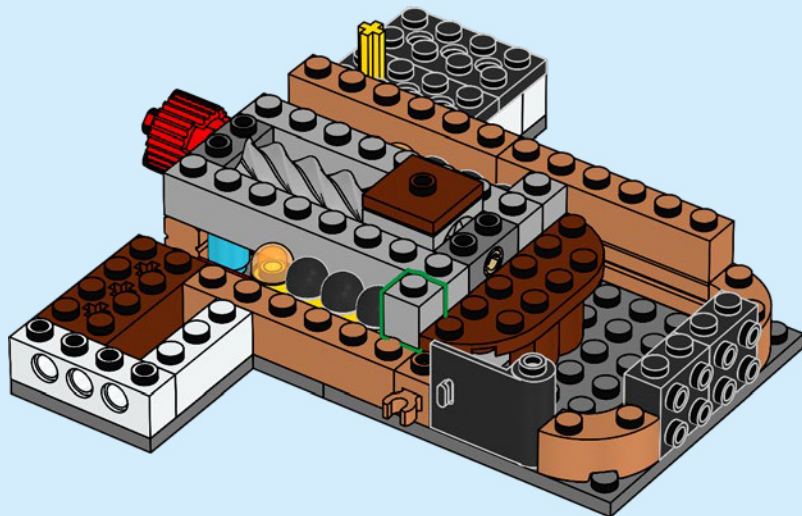

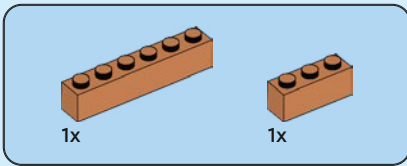

36

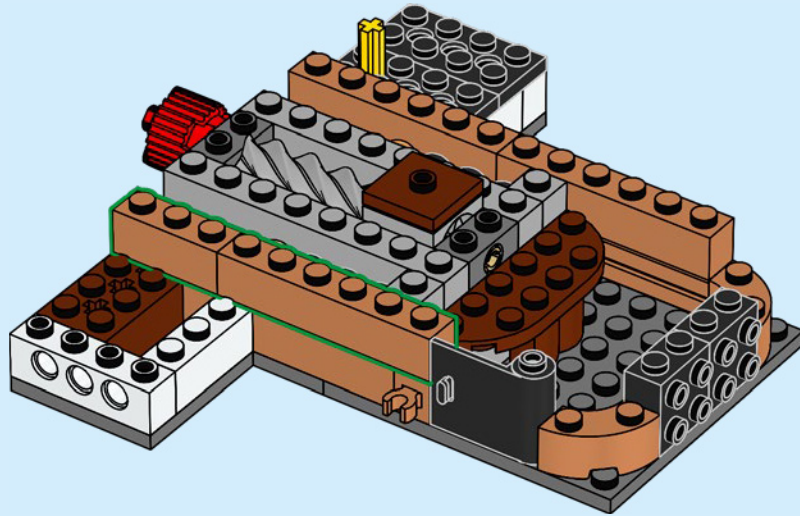



2x

37

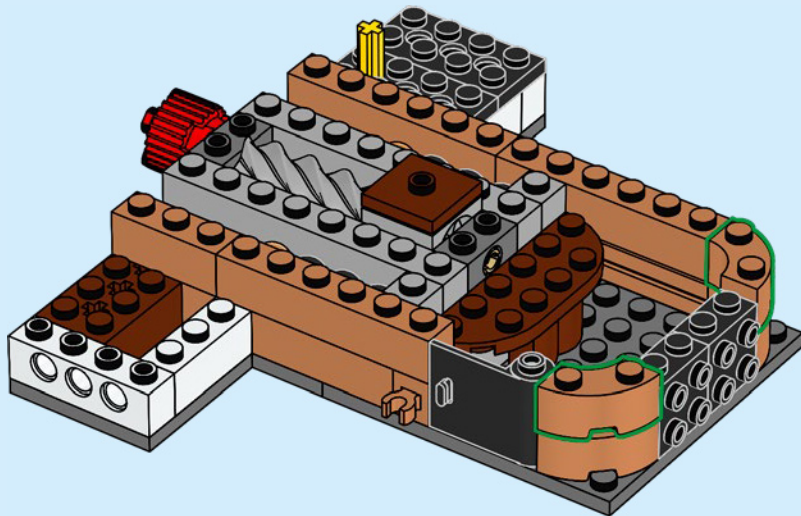

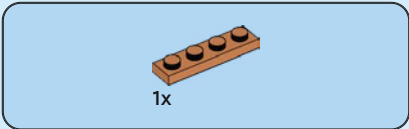

38

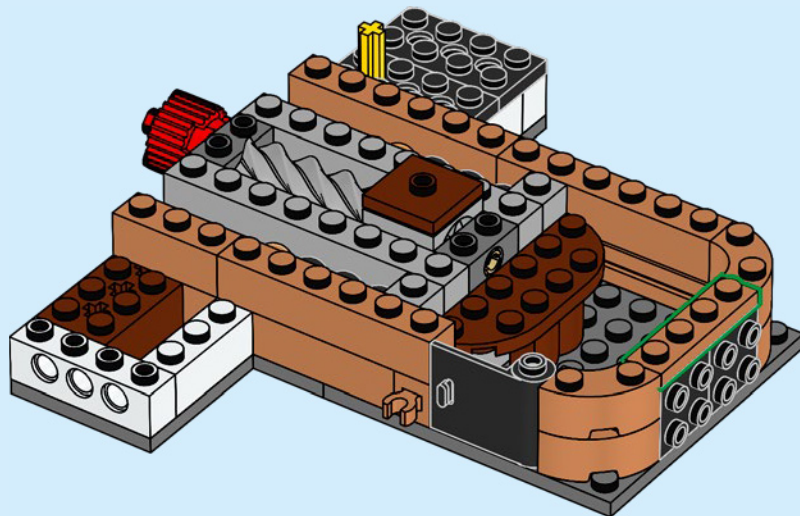

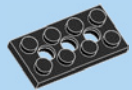

2x

39

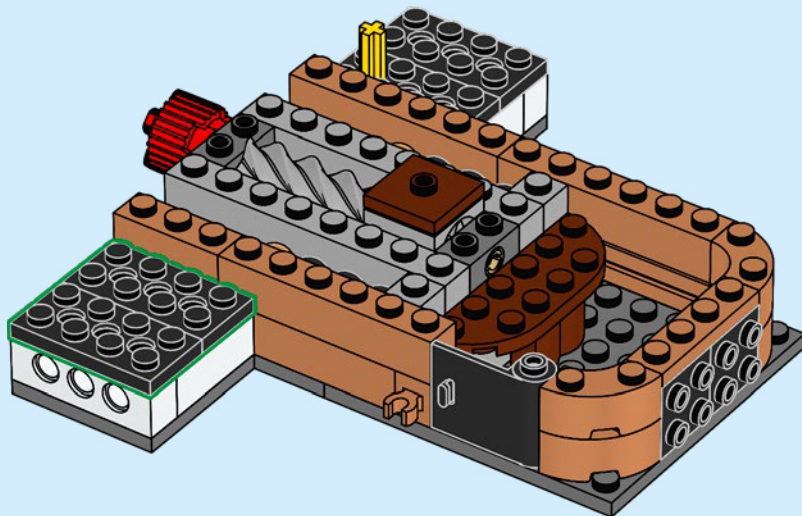

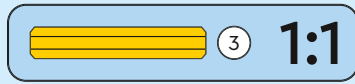
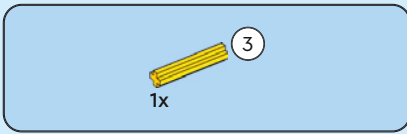

40

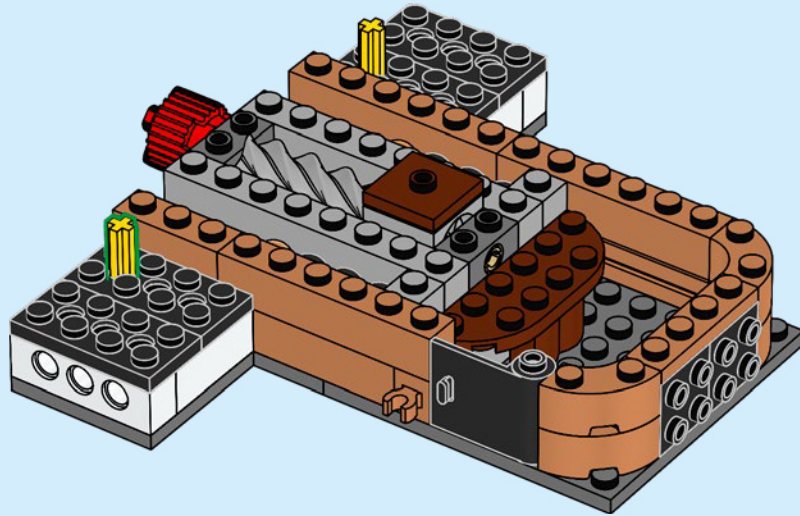

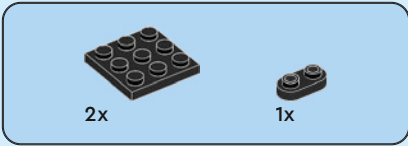

41

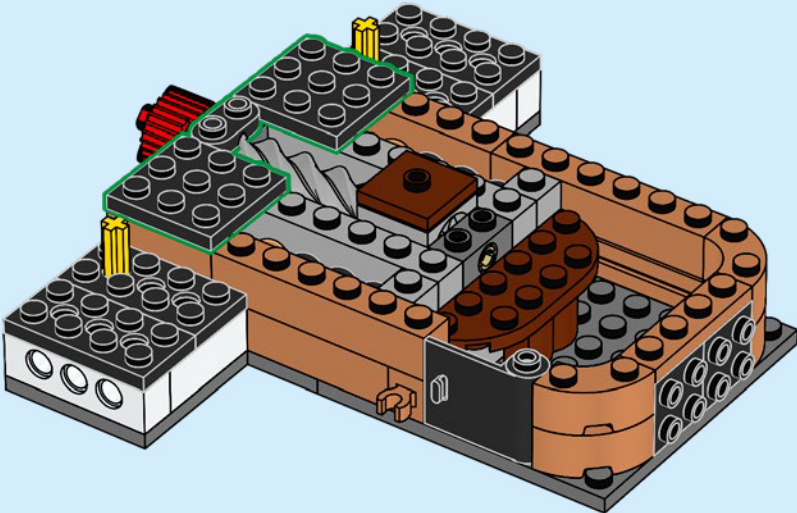



2x

42

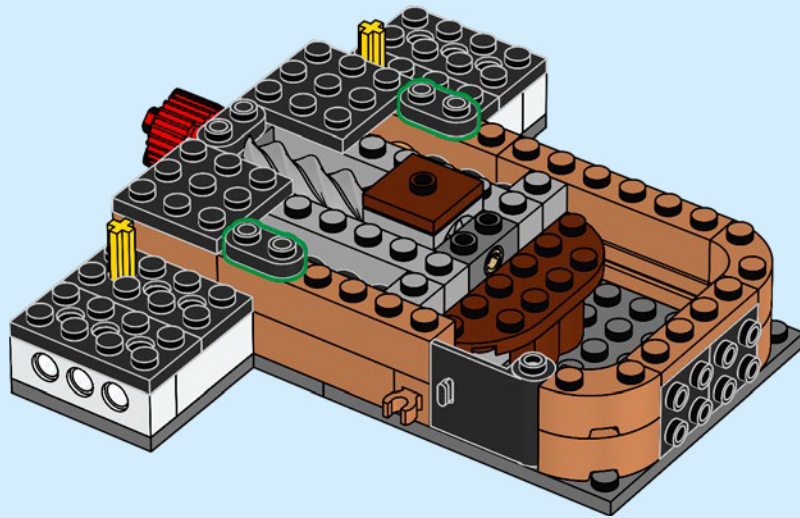



2x

43

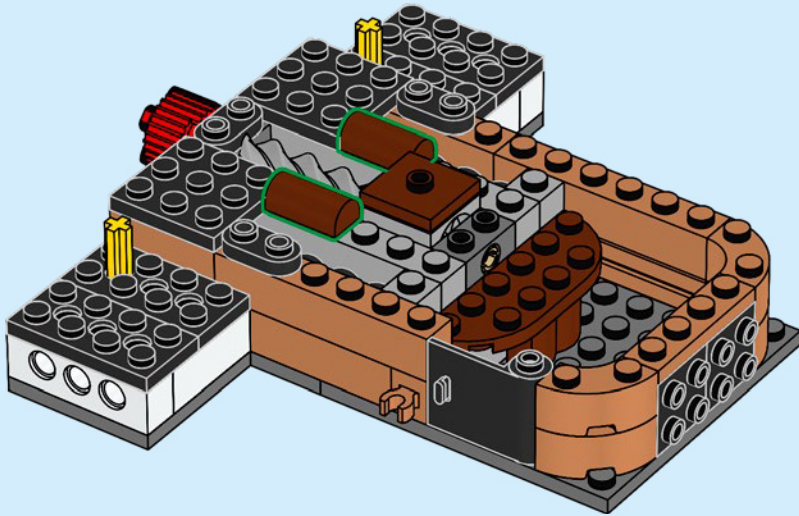

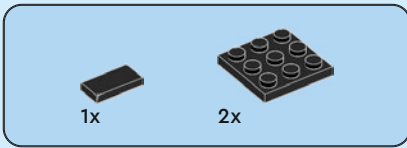

44

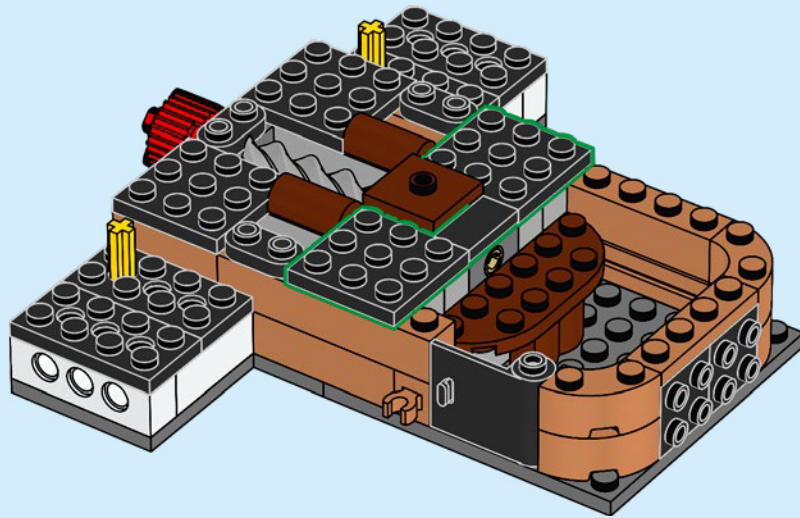

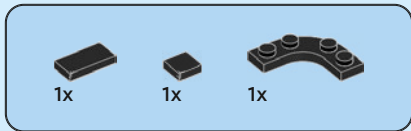

45

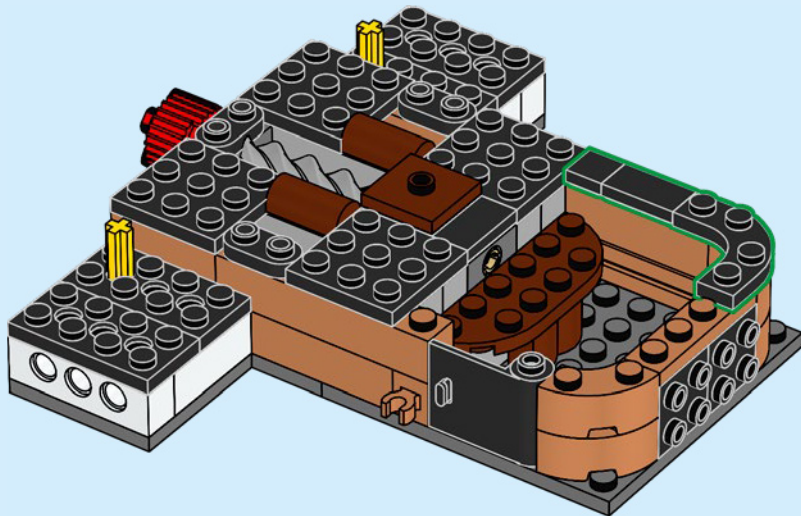

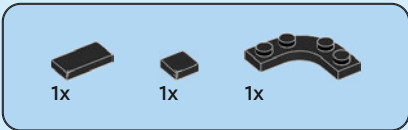

46

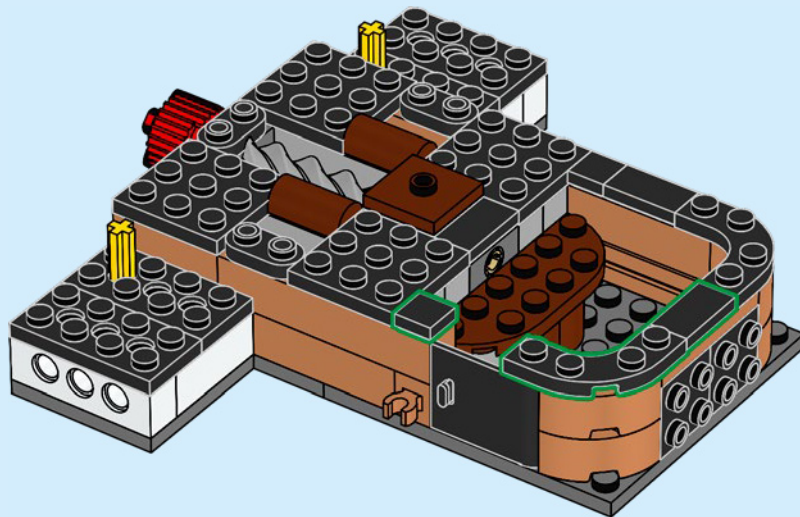



1x

47

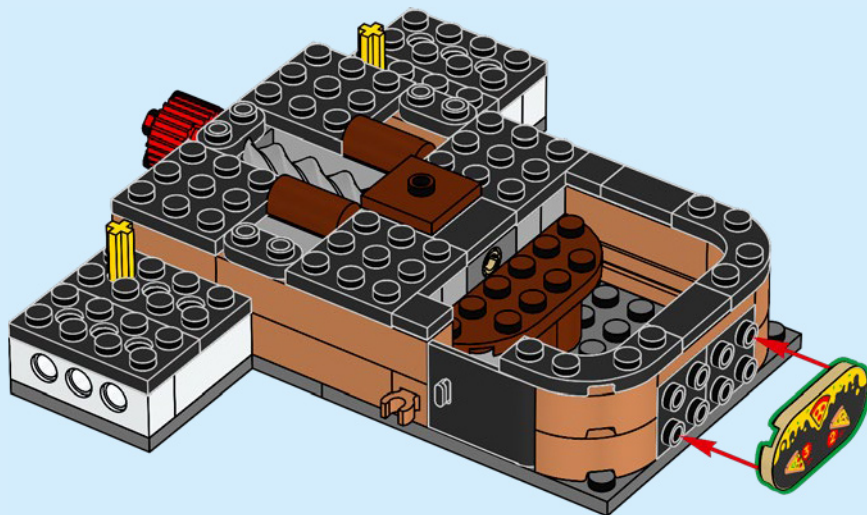



1x

48

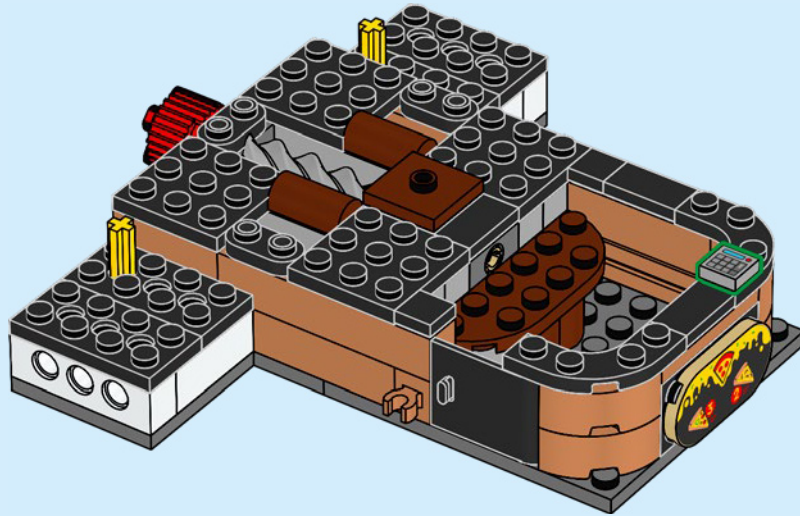



1x



2x

49

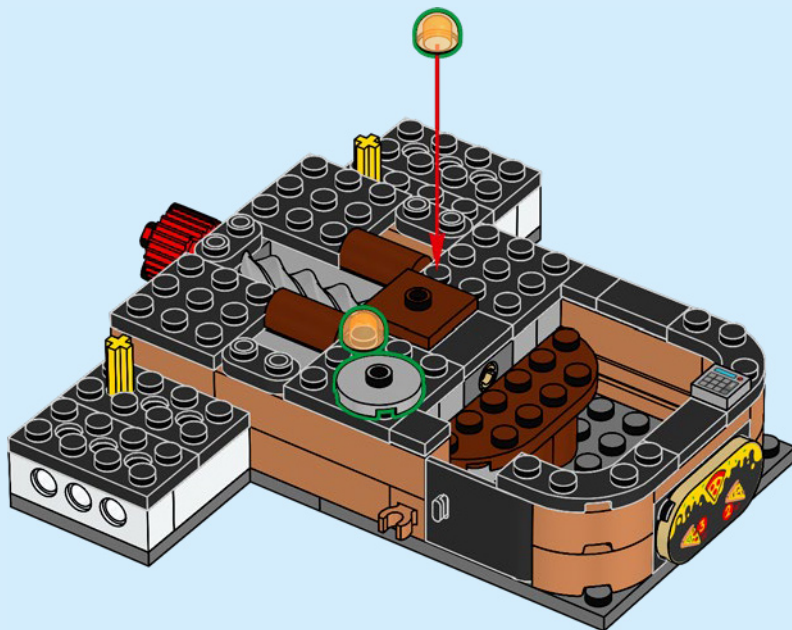



1x

50

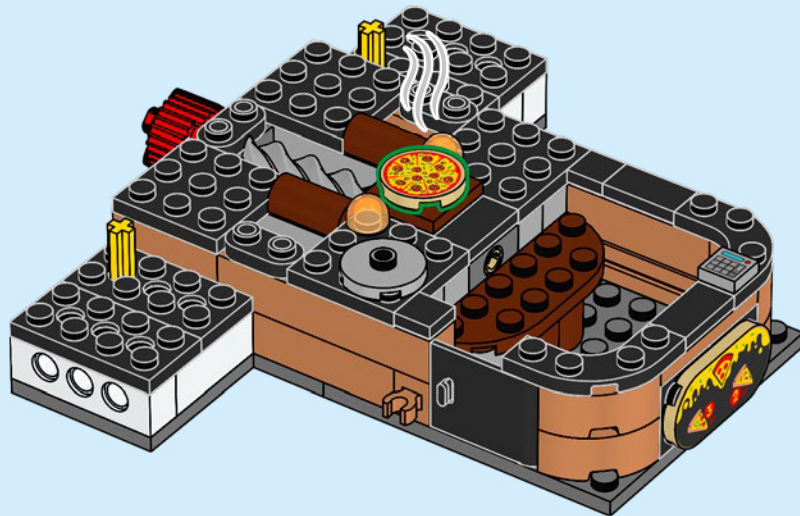



1x



1x



1x



1x

51

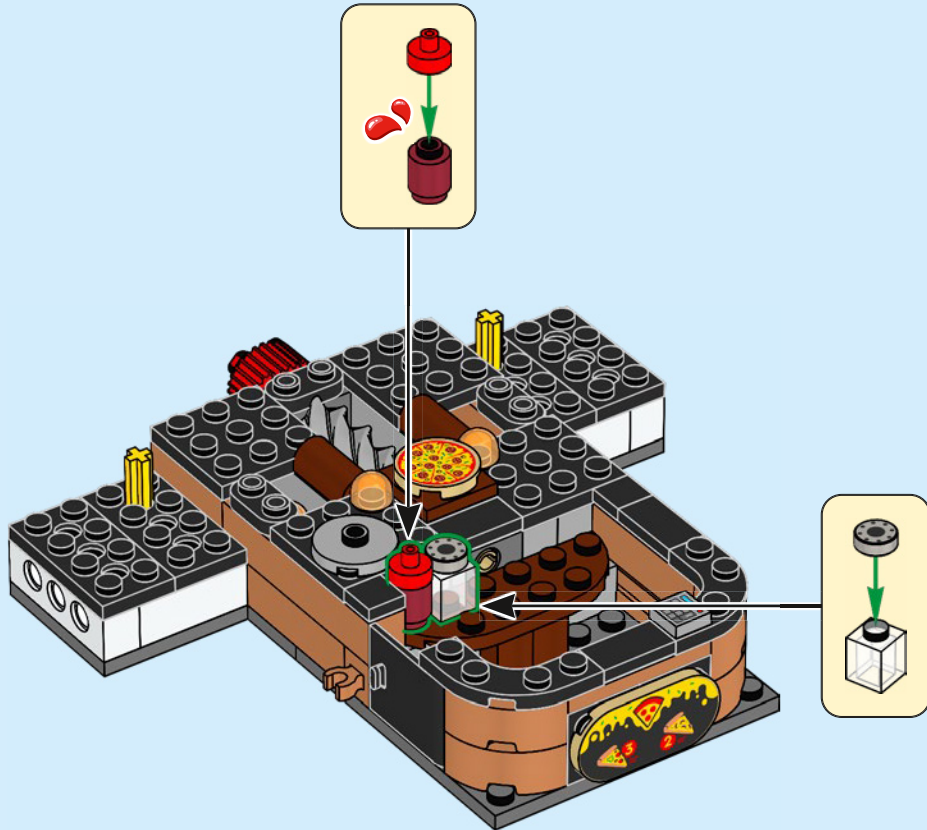

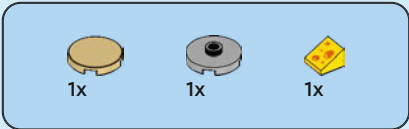

52

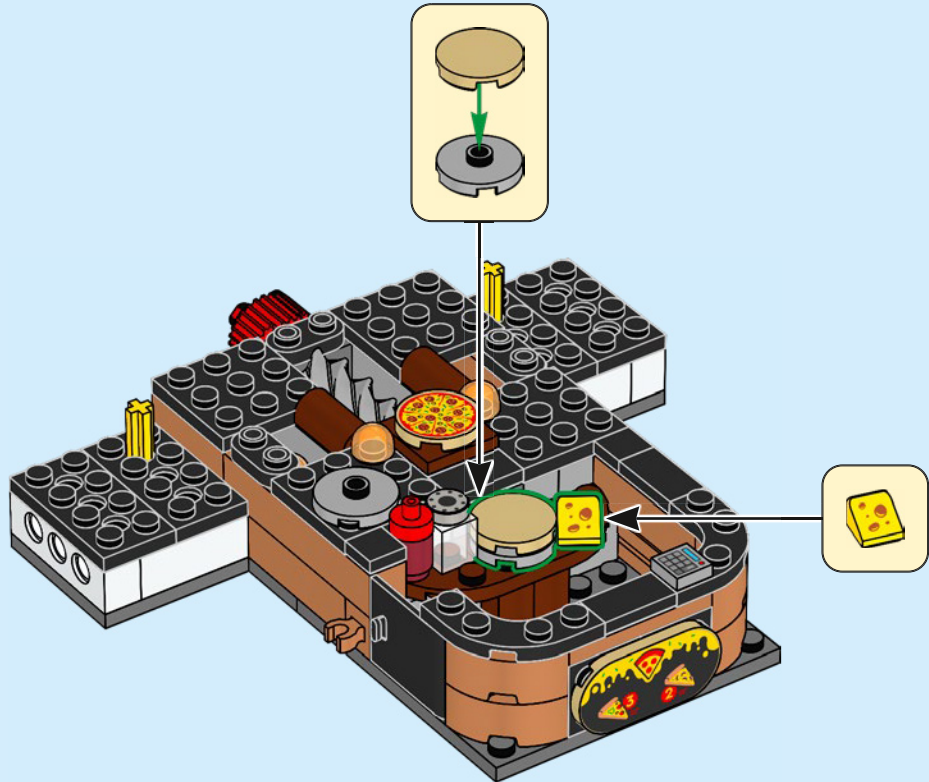



2x



1x

53

1

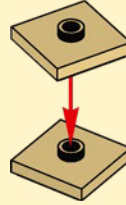

2

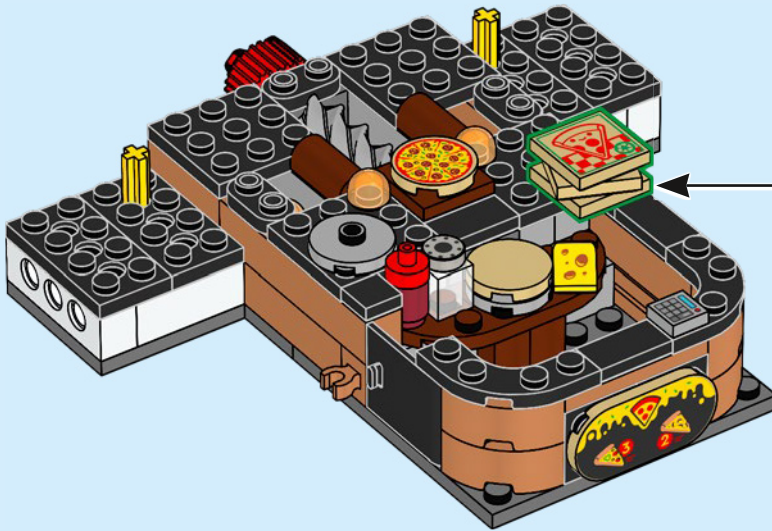



54







1x

56





2x

57



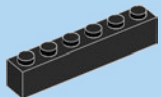

1x

58

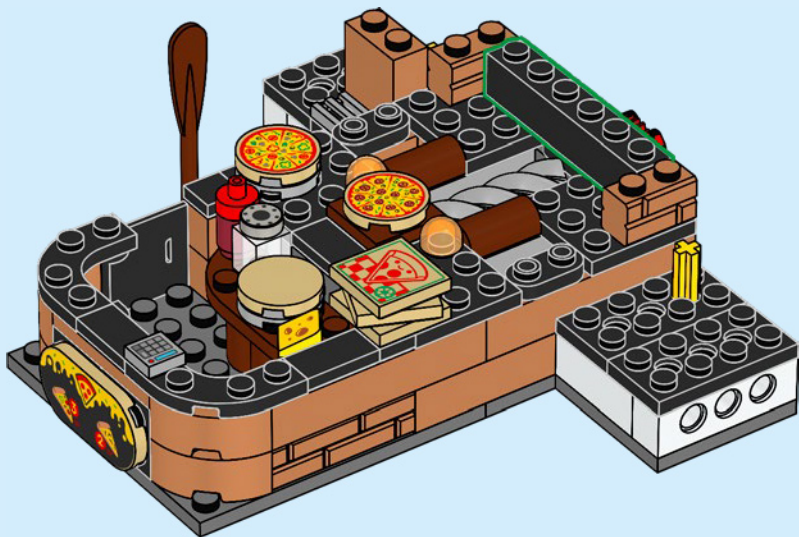



4x

59

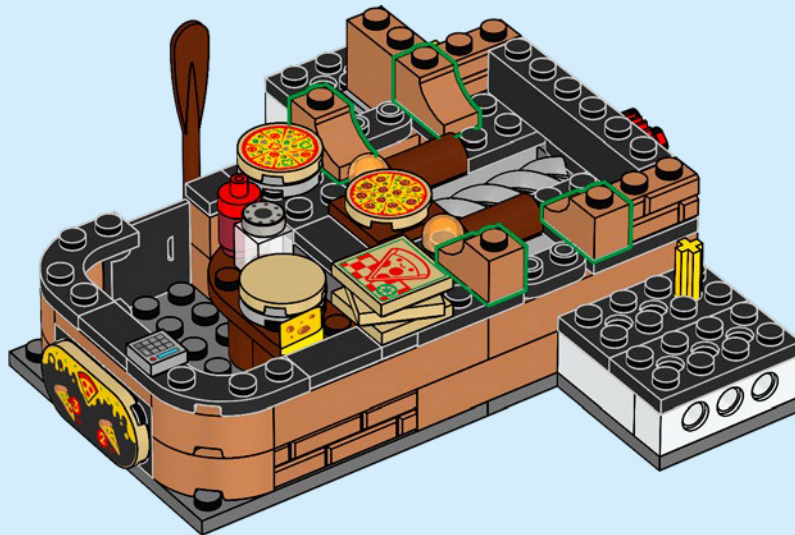

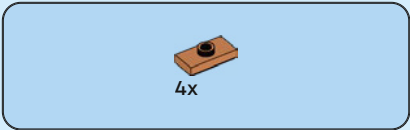

60

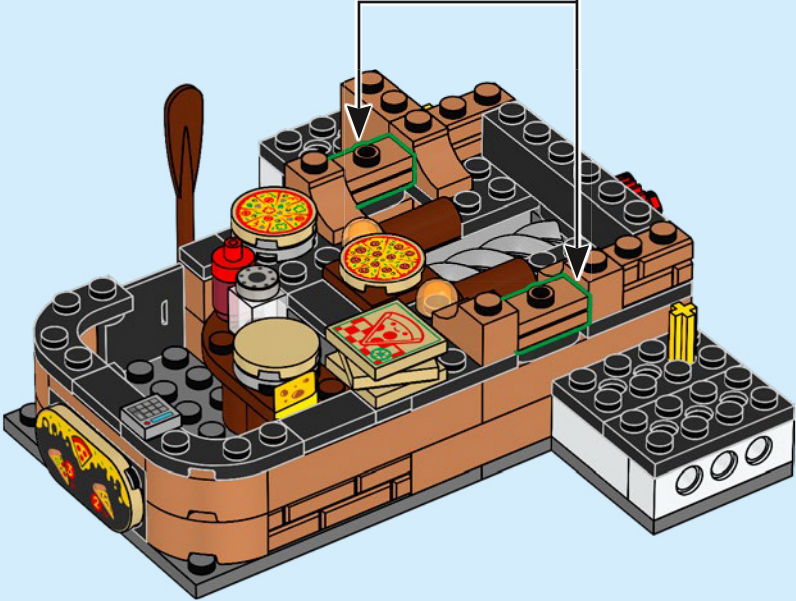
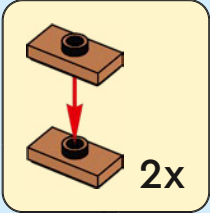



2x

62



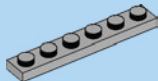

2x

63

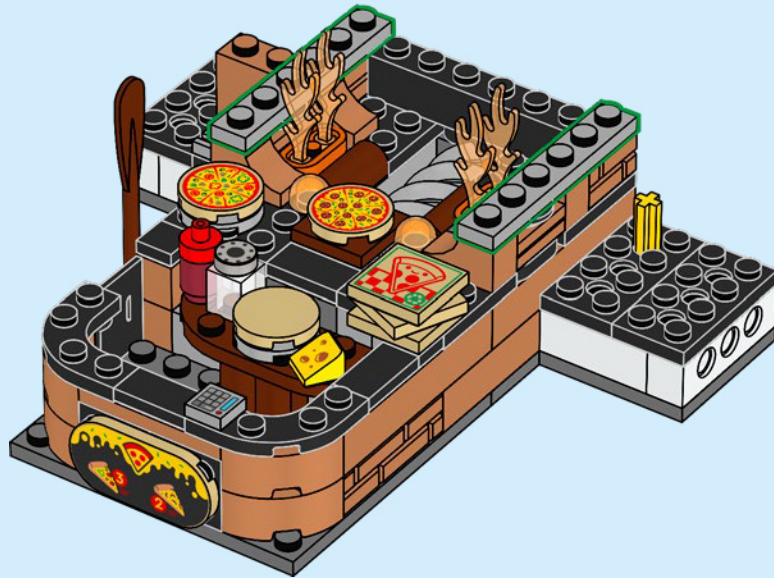

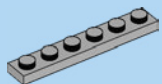

1x

64

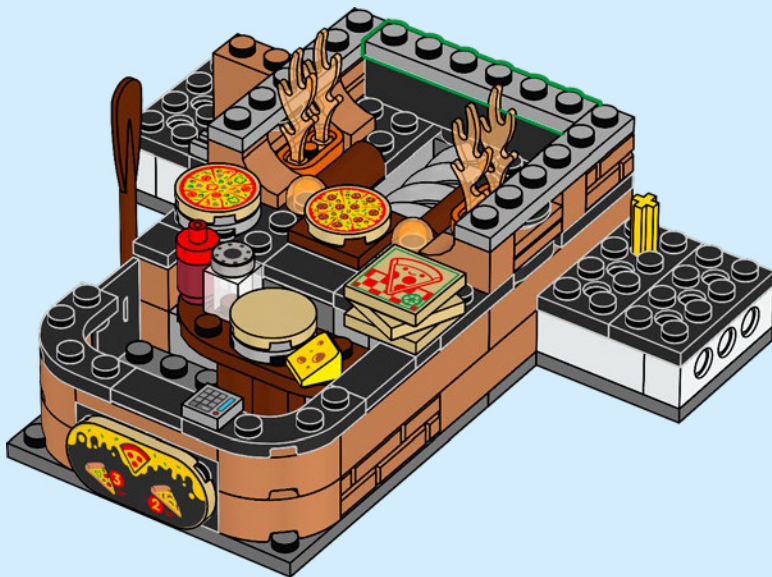

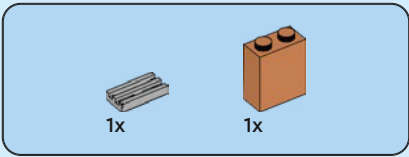

65

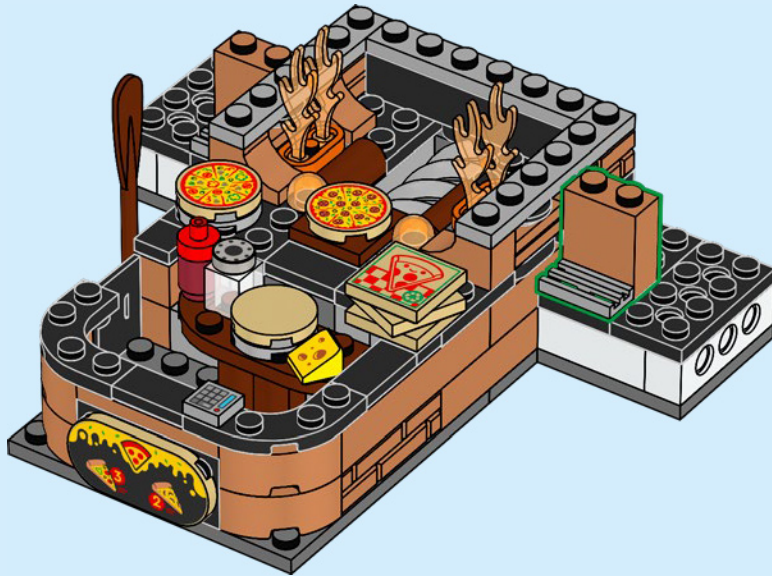



2x

66

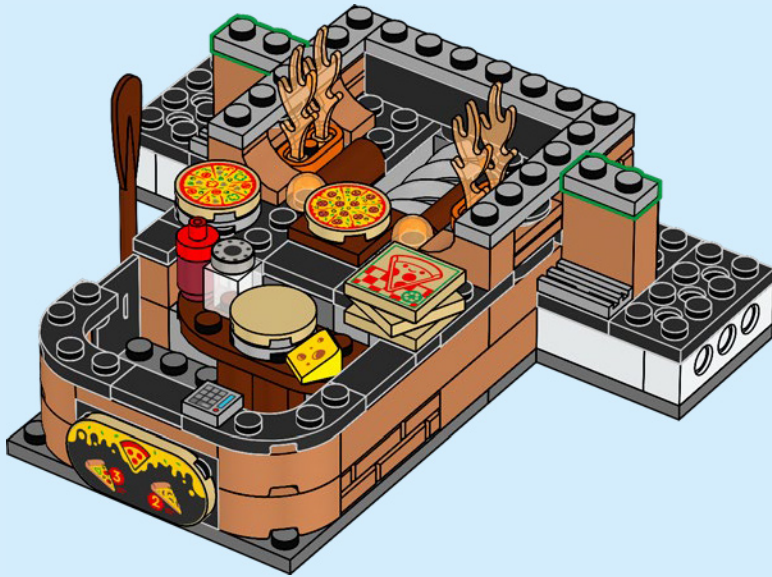



2x



2x

67

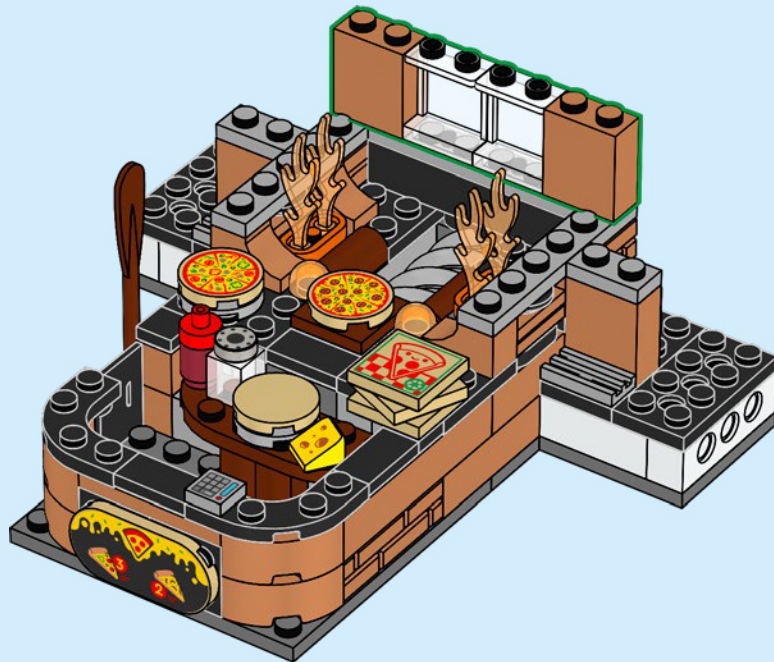



4x

68



2x

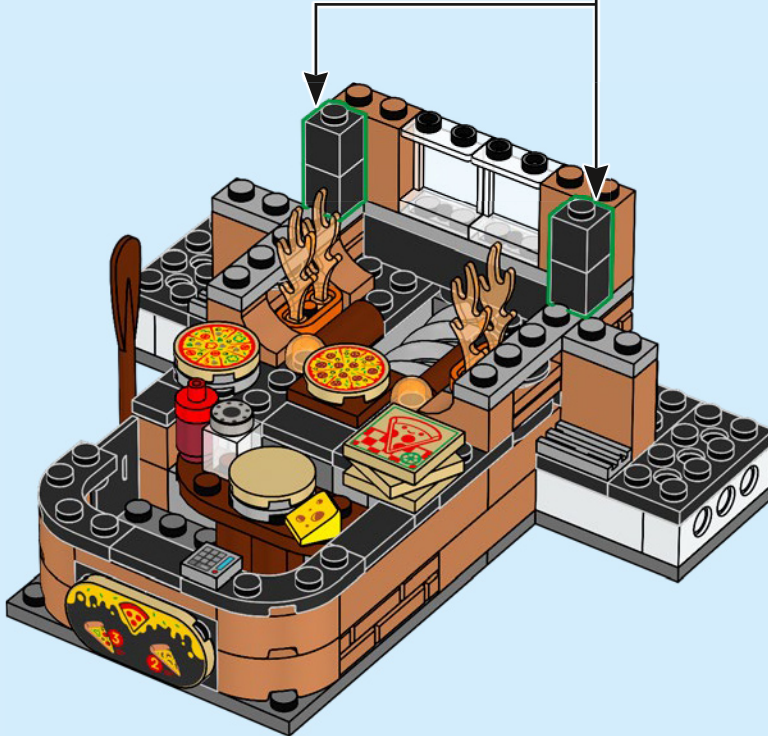



2x

69

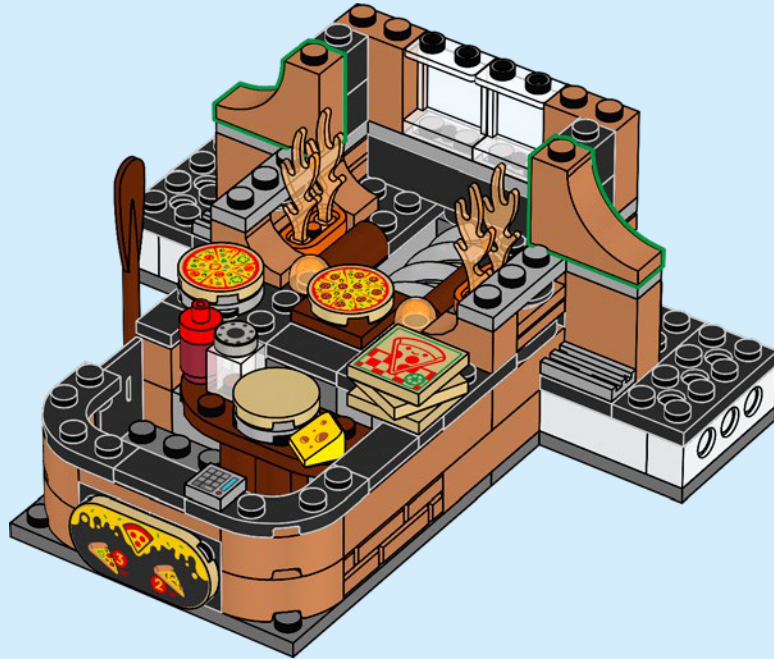



2x

70



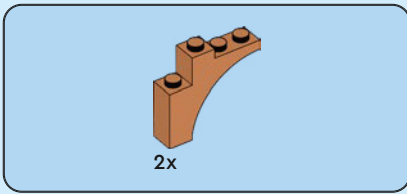

71

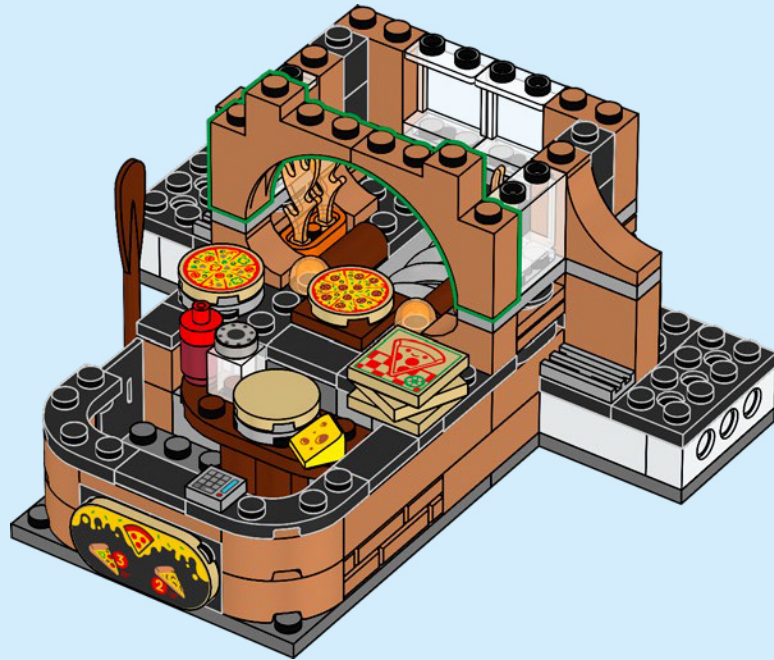

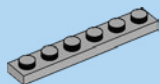

2x

72

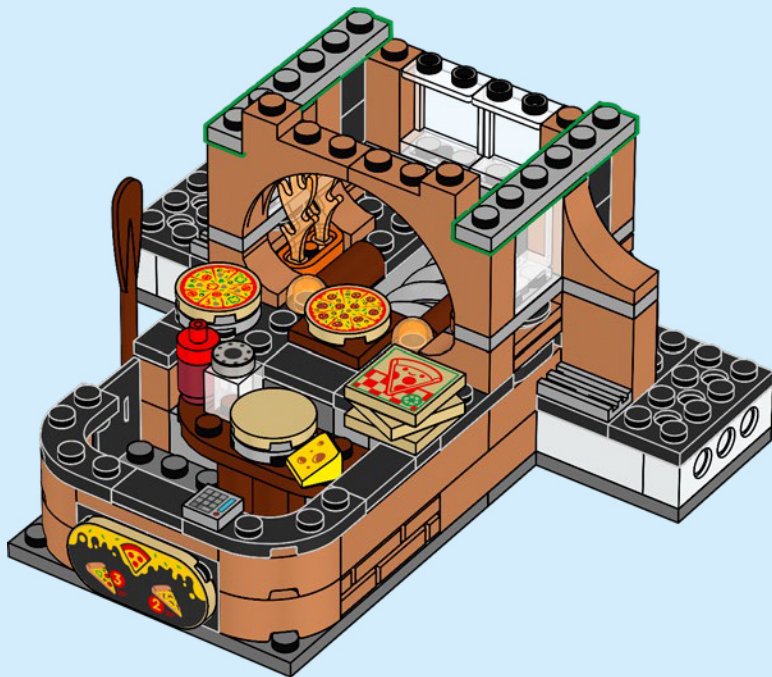

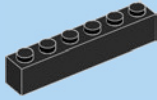

1x

73

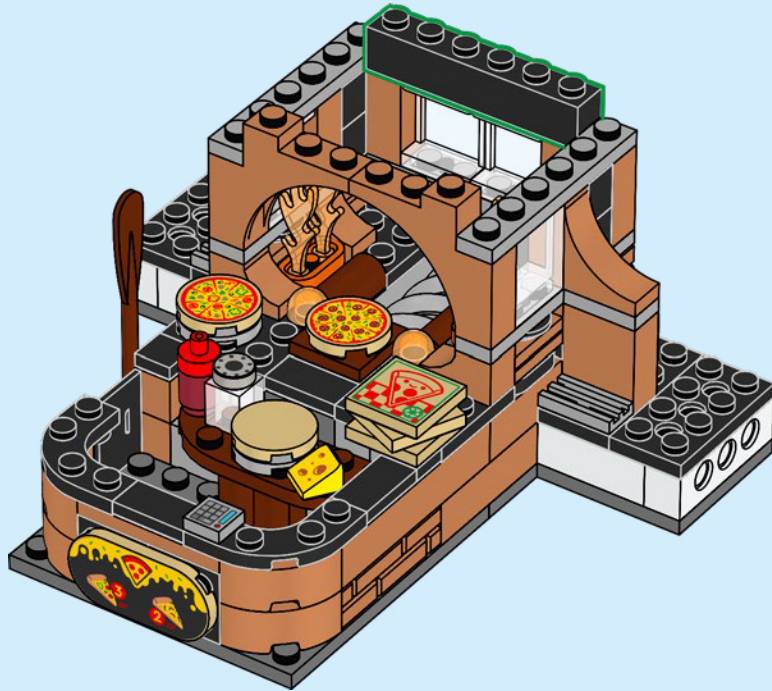

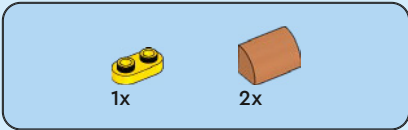

74





1x

75





3x

76

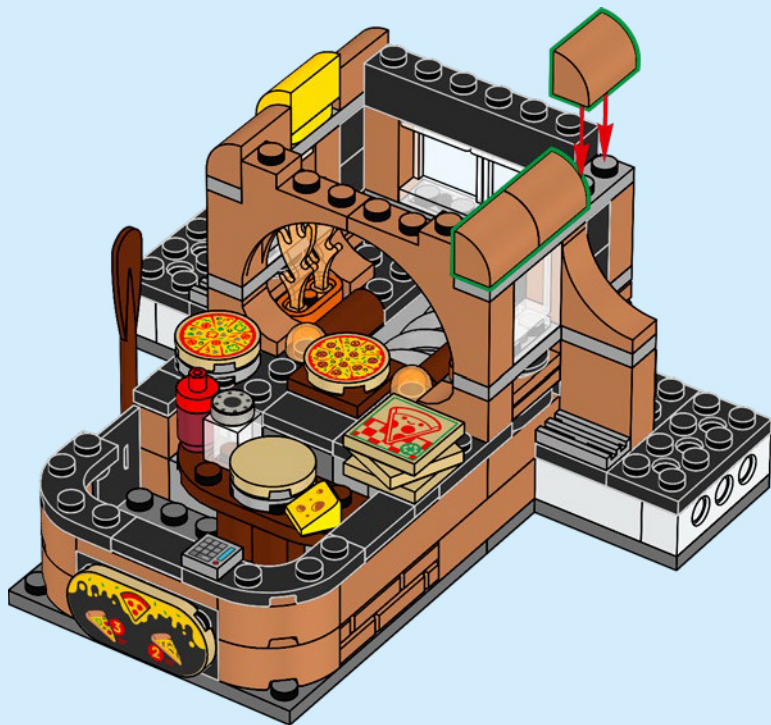

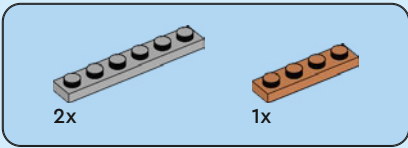

77

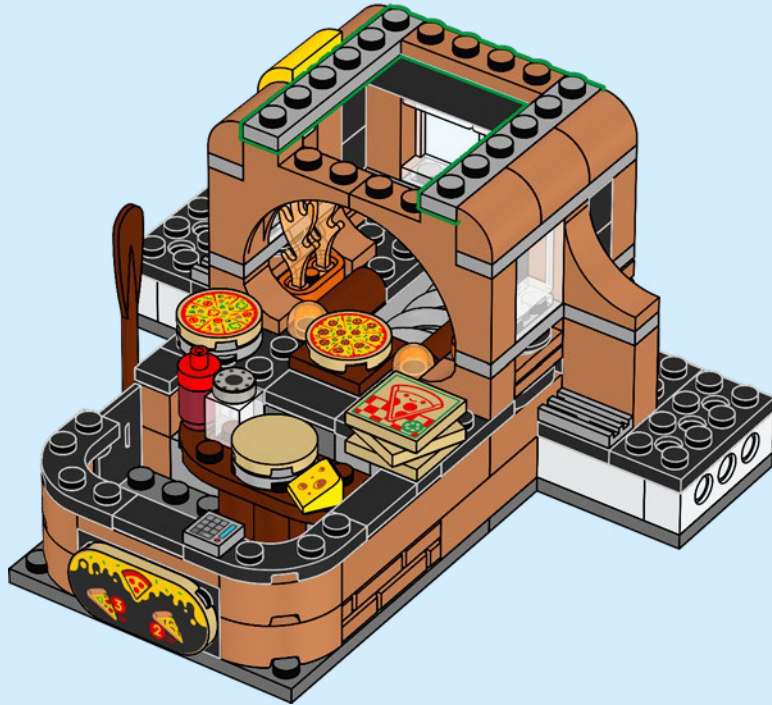

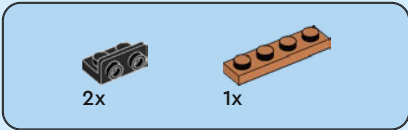

78

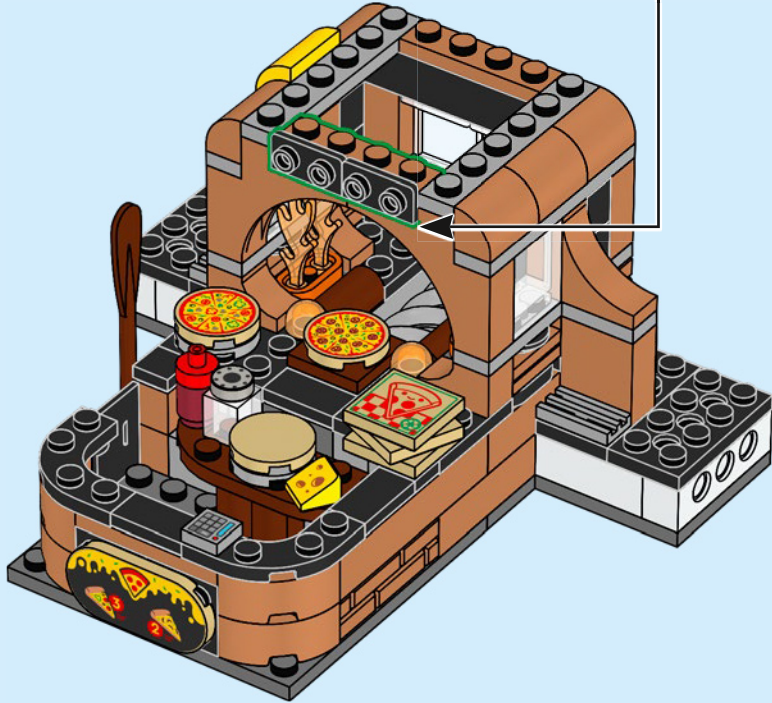
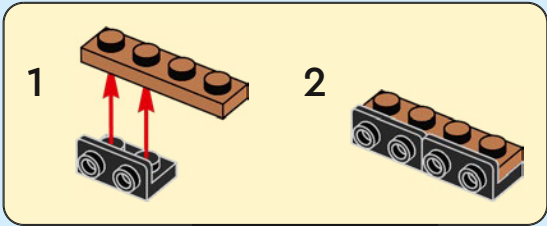

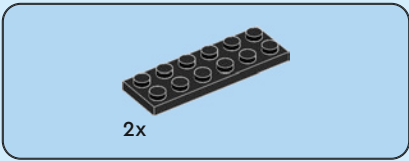

79

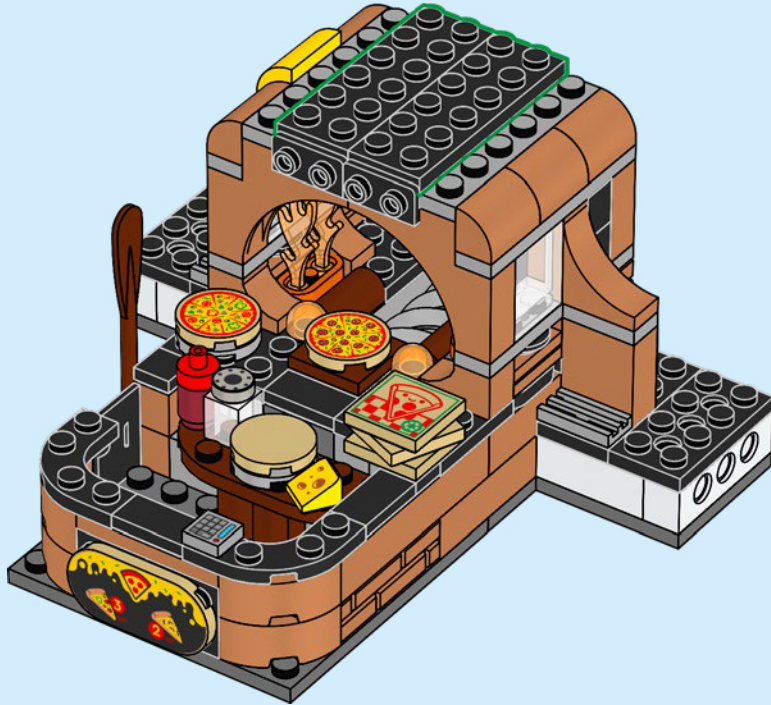

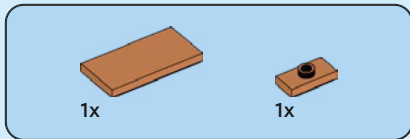

82

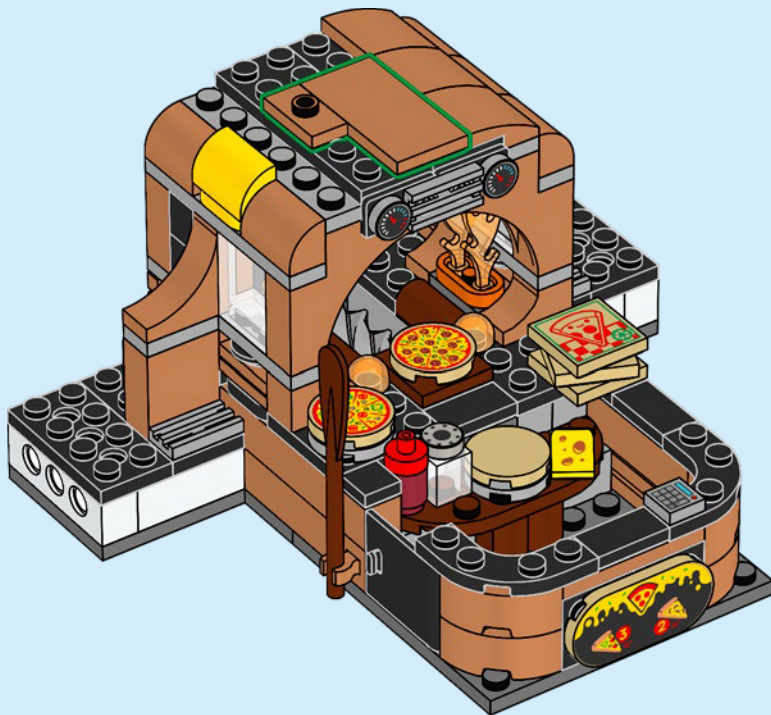



1x



2x

83

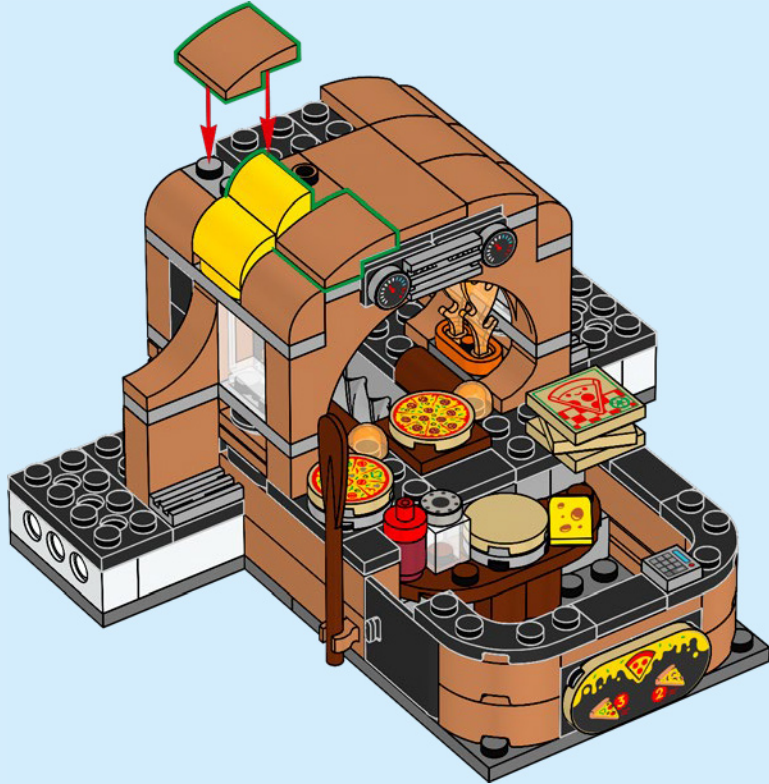



3x

84

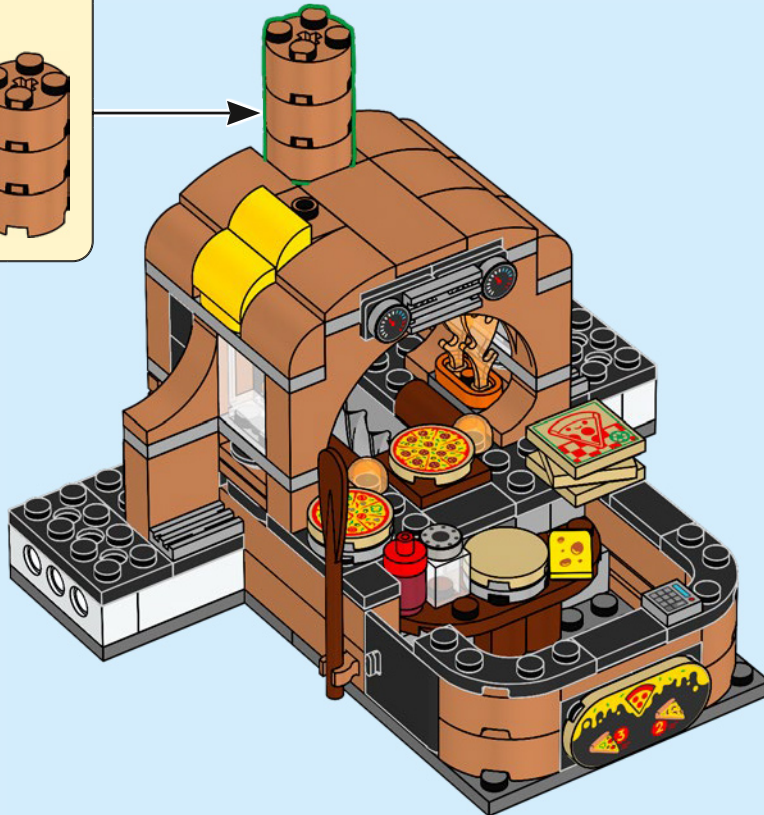
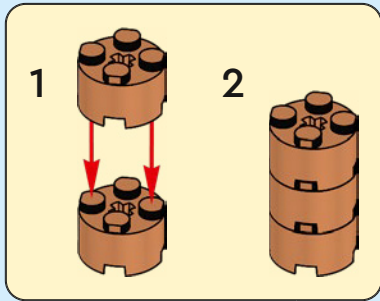



1x

85

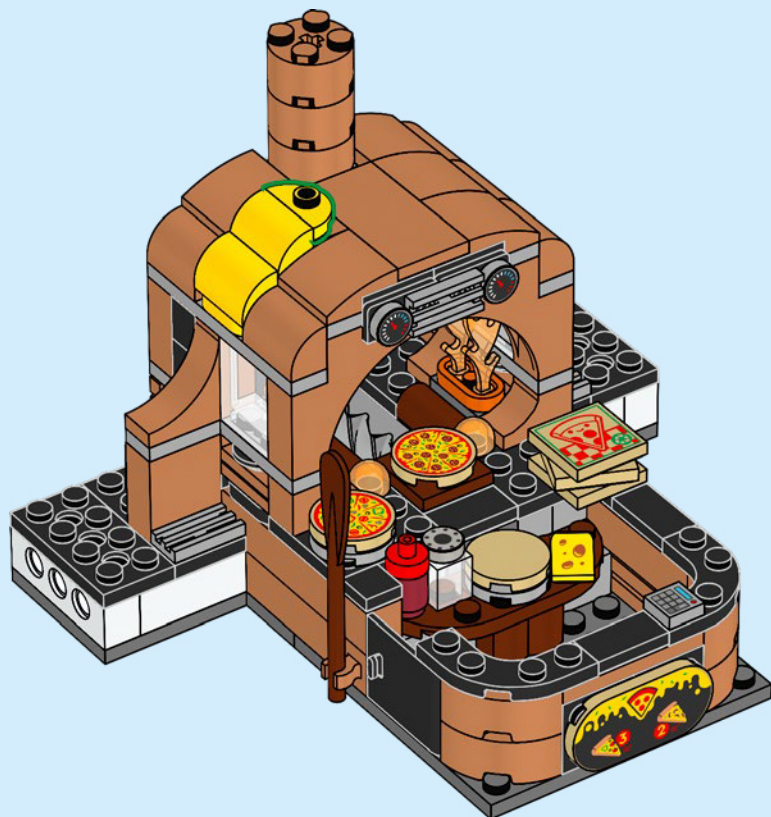

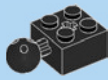

1x

87

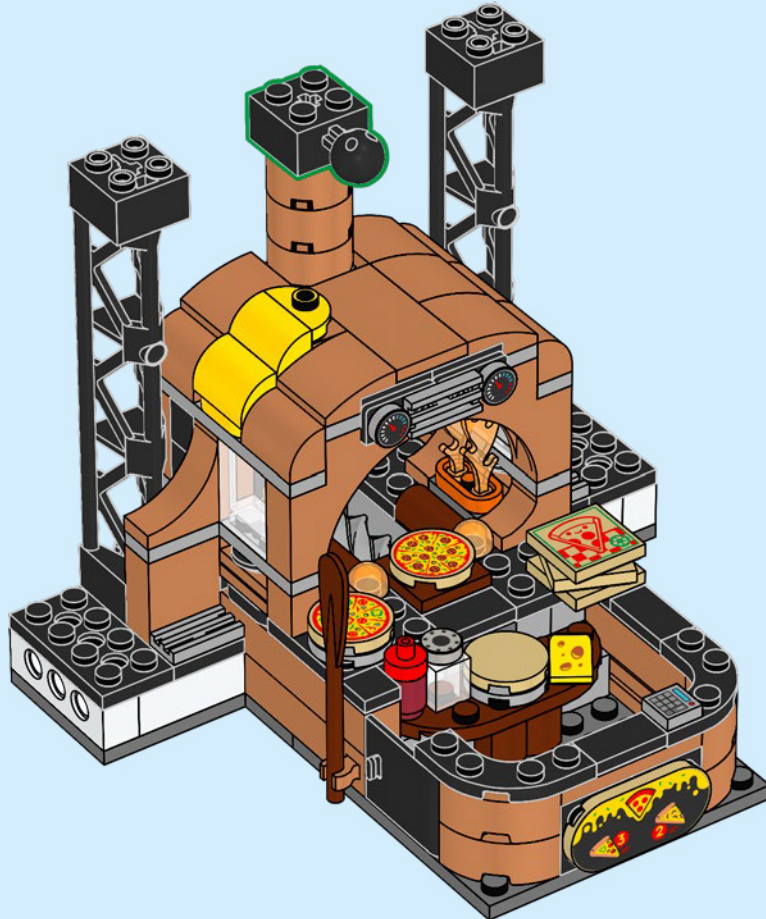

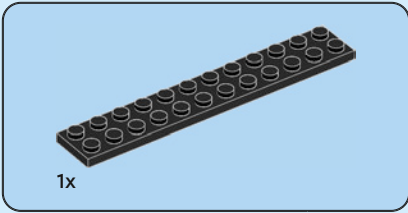

88

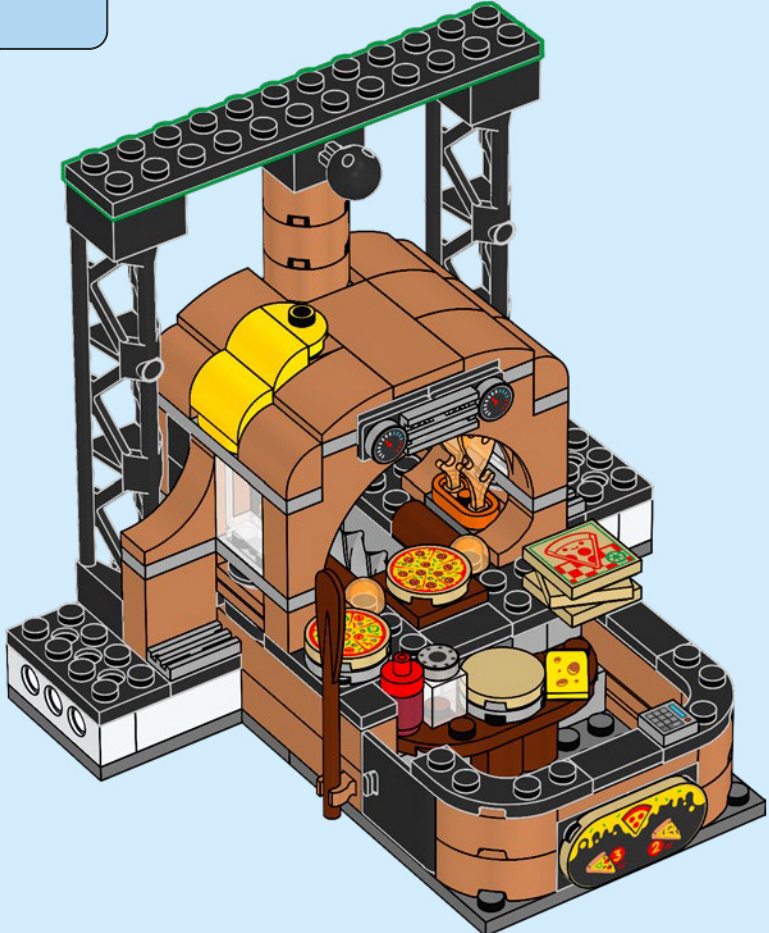



1x

89

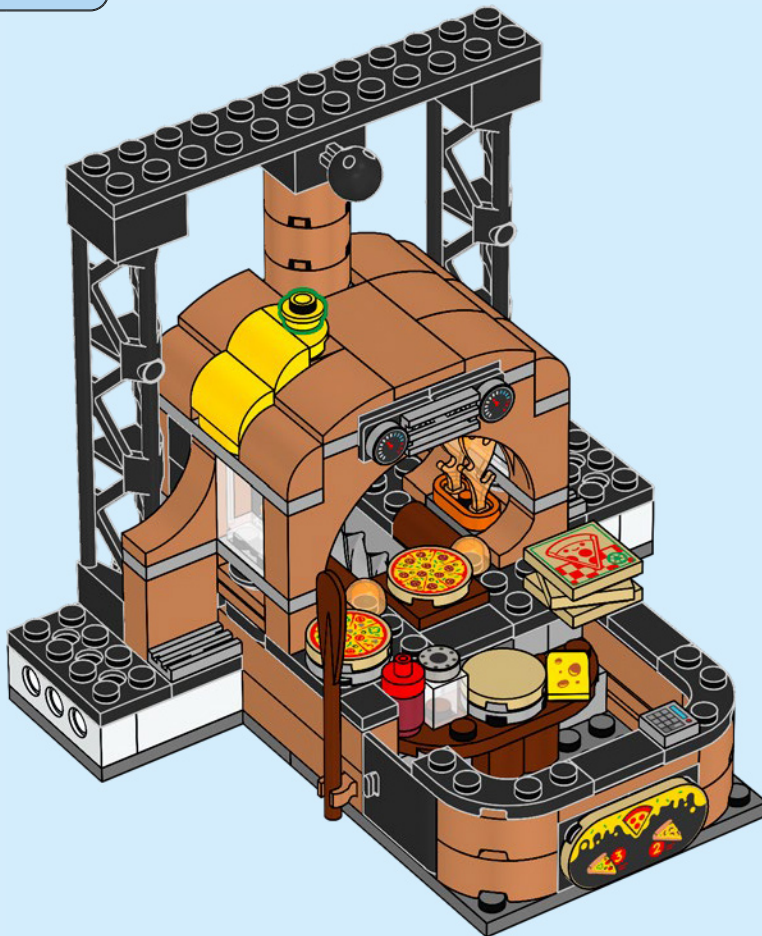



1x

90

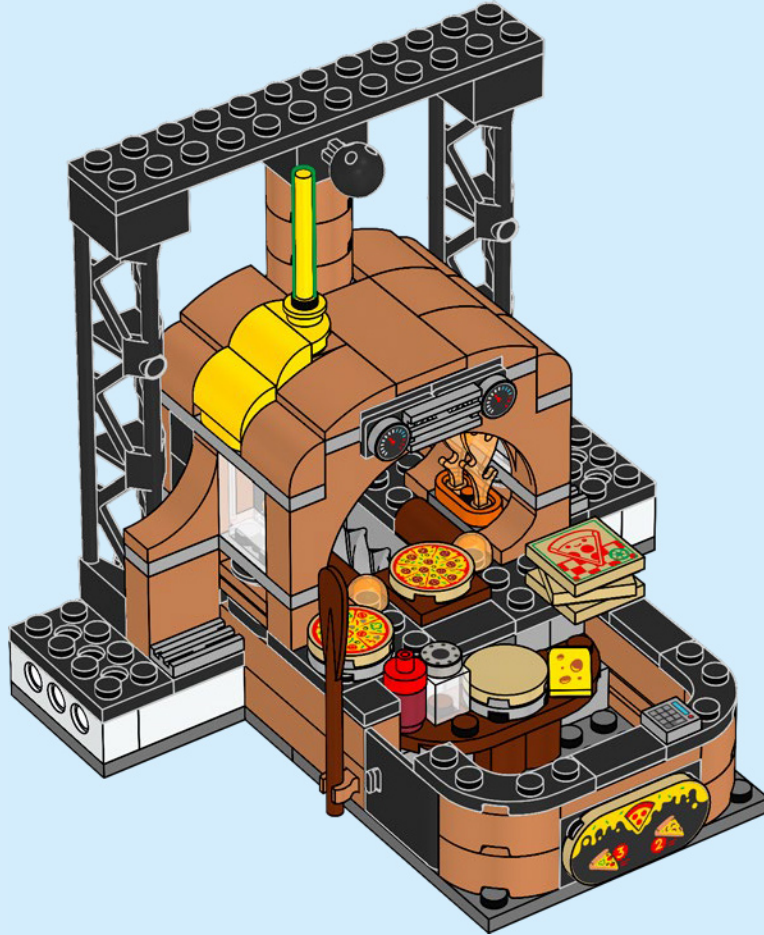



1x

91

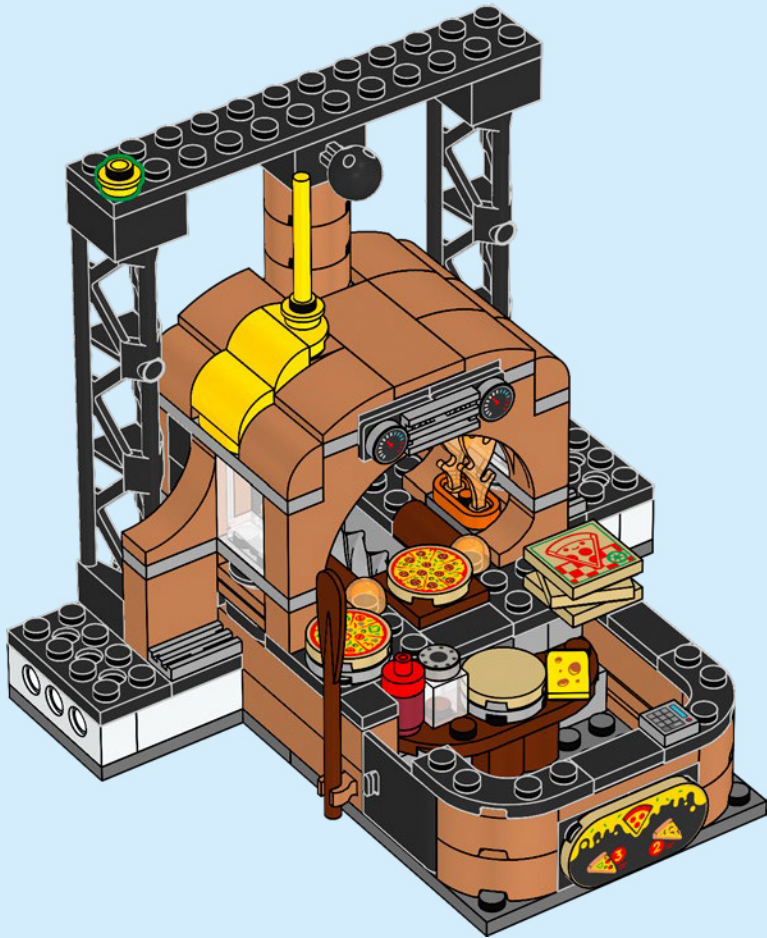

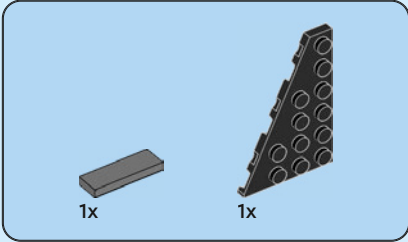
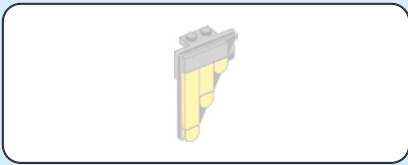

92

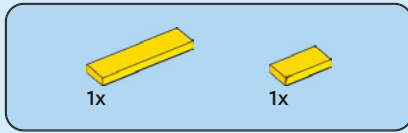
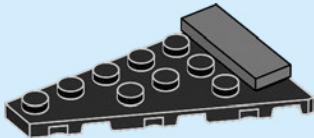

93

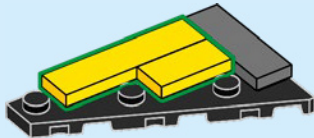

3x

94

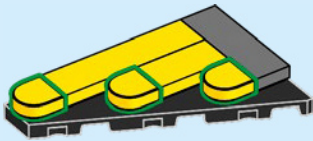

1x

95

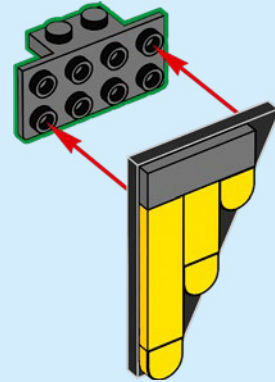

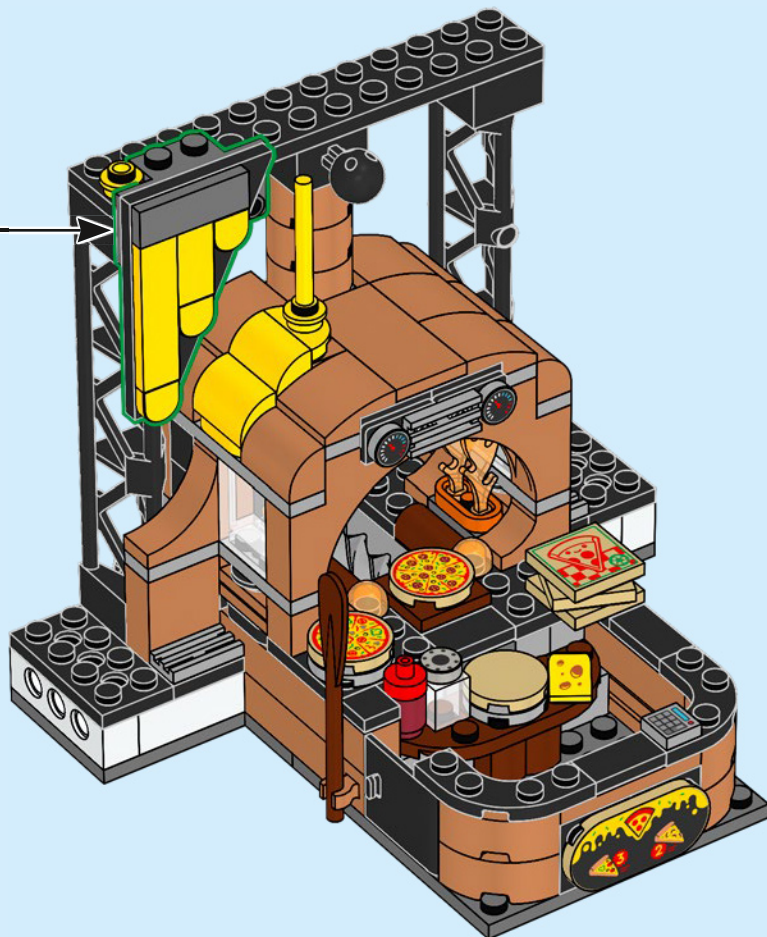



1x

97

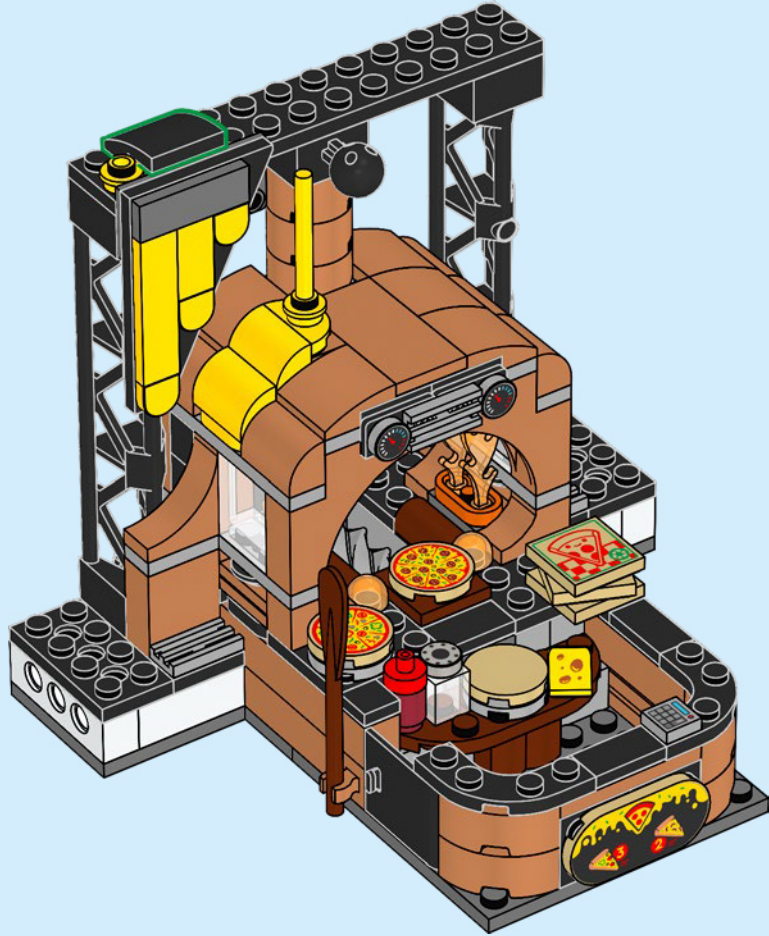

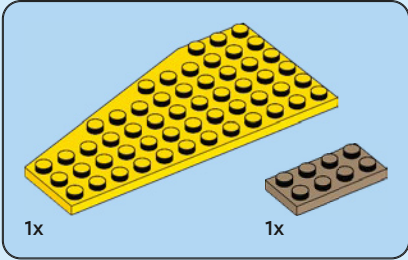
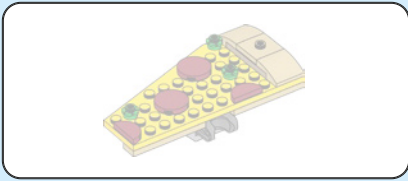

98

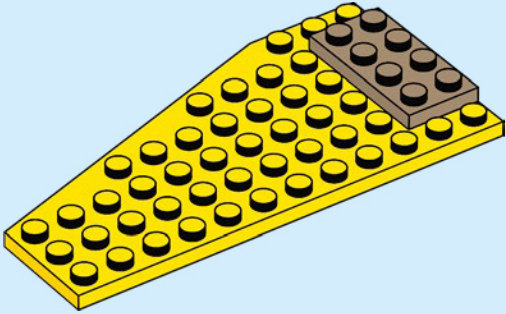

99

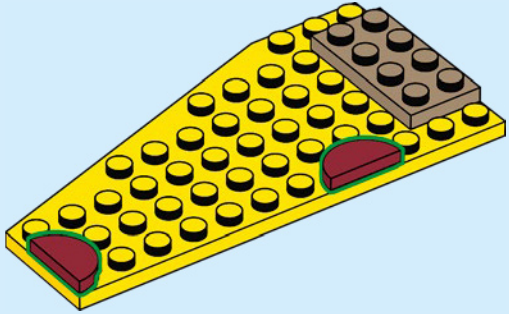



3x

100

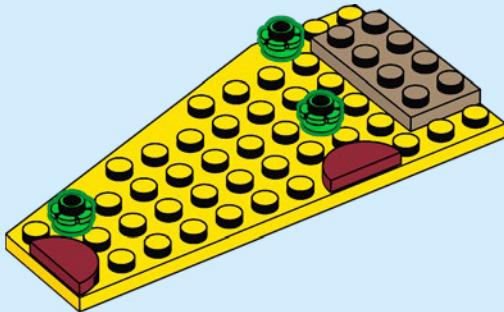

2x

101

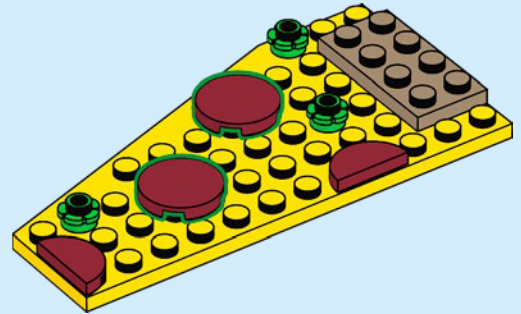

2x

102

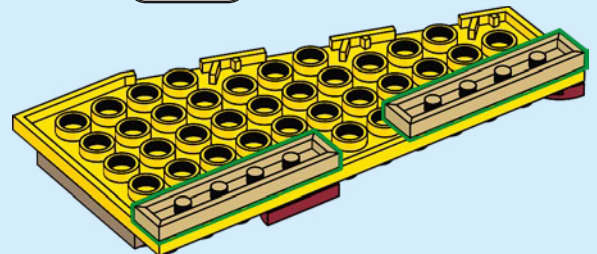

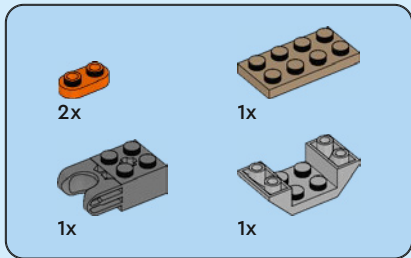

103

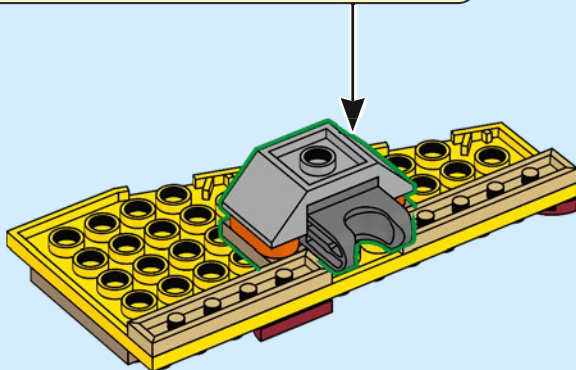
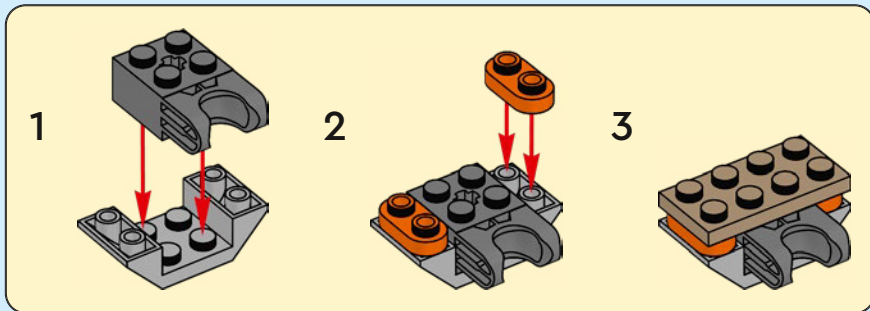

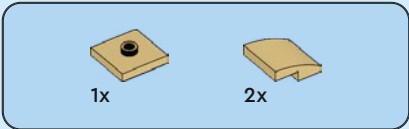

104

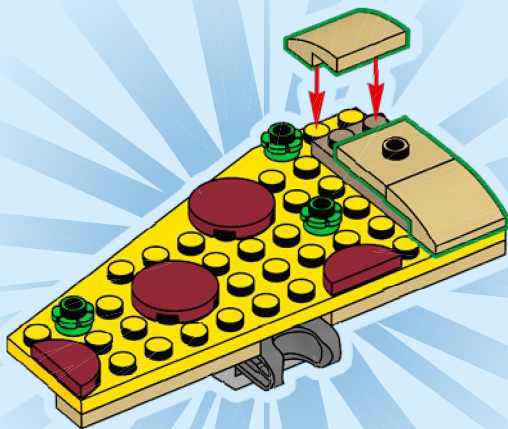

105

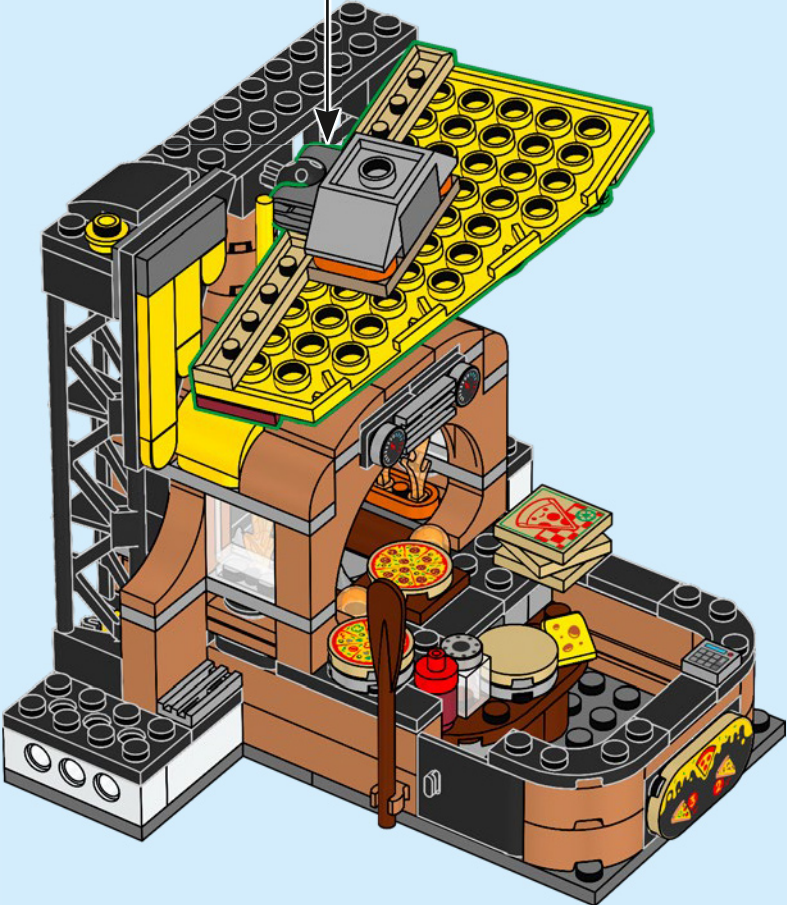



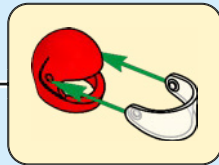
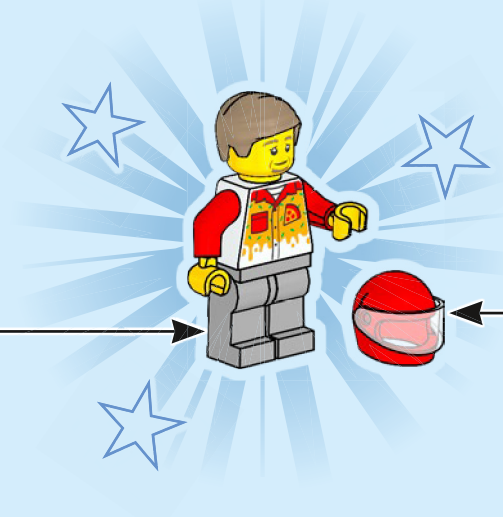
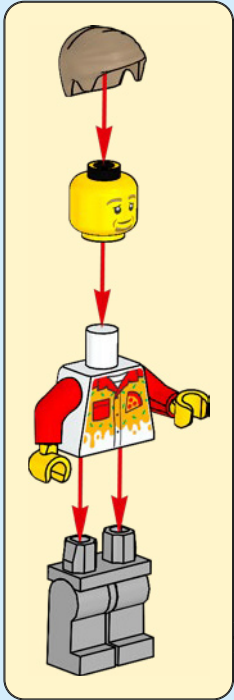
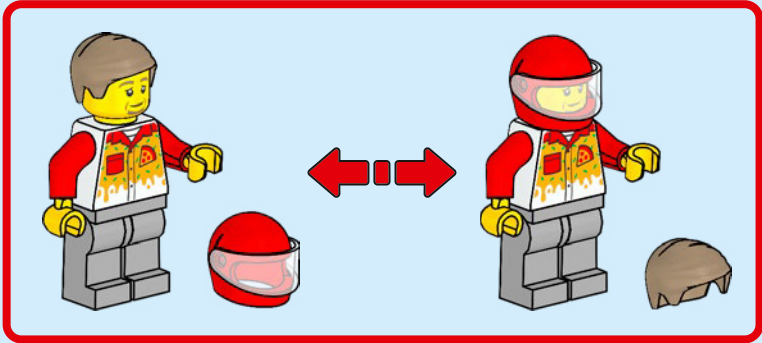

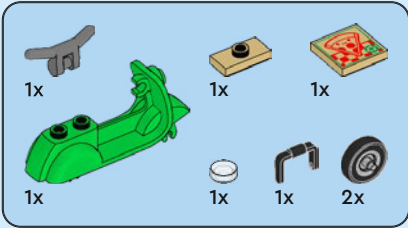

106

1

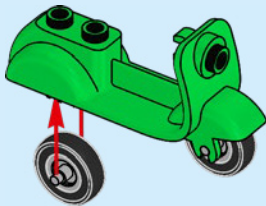

2

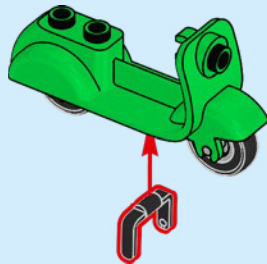

3

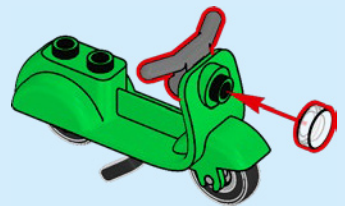

4

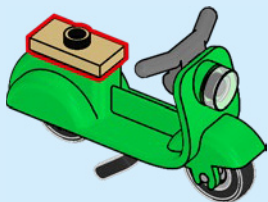

5

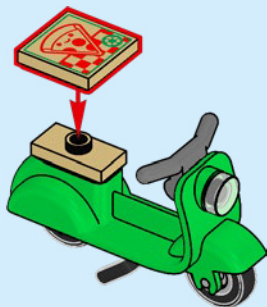



2x

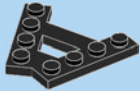

1x

107

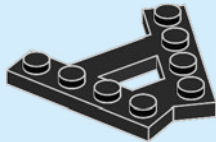

2x

108

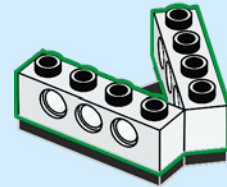

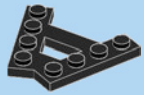

1x

109

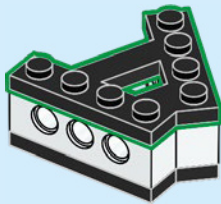

4x

110

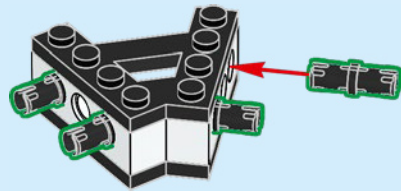

2x

111

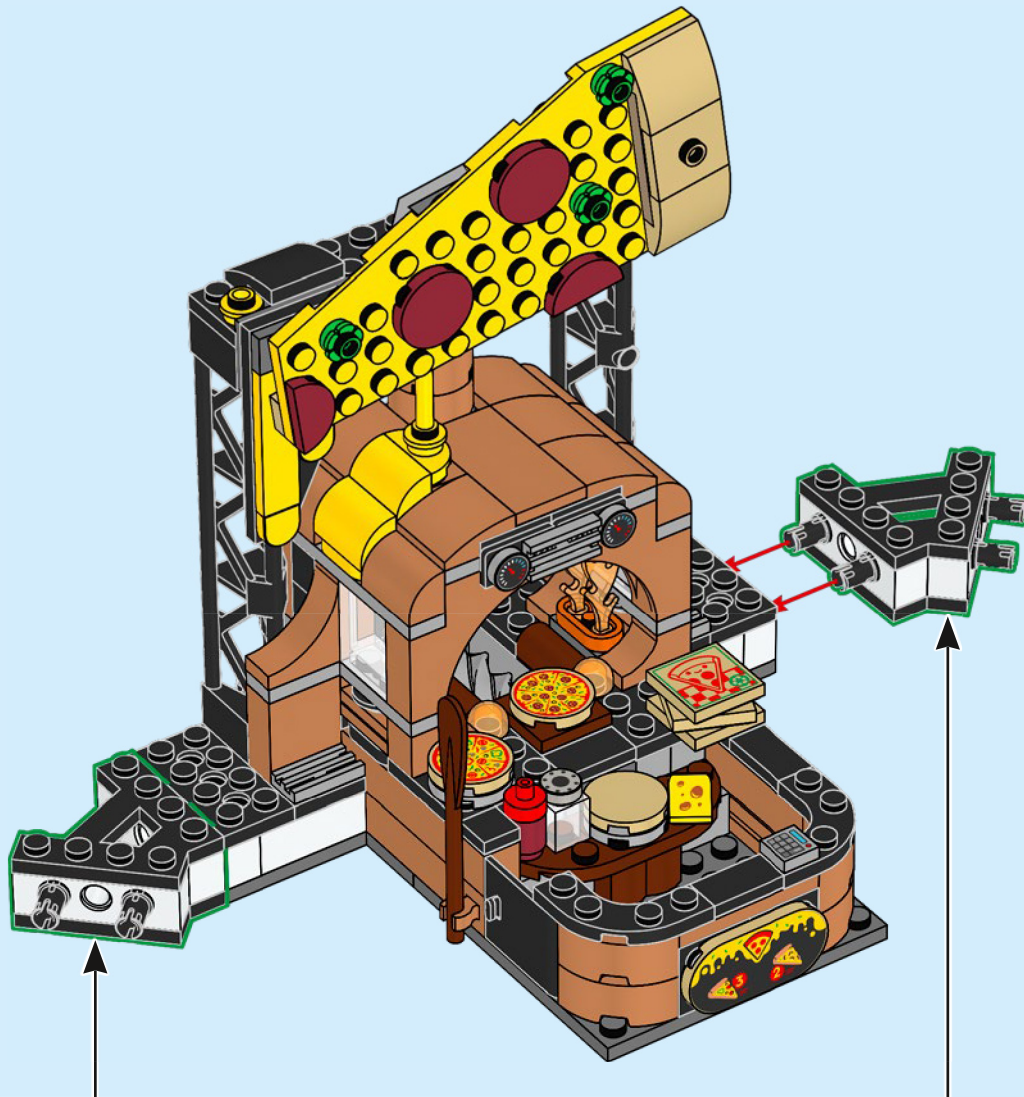

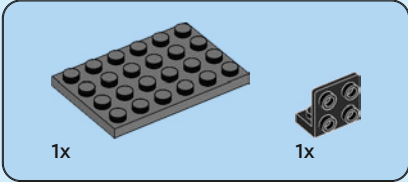
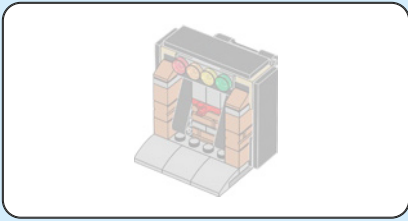

112

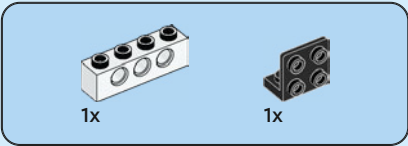
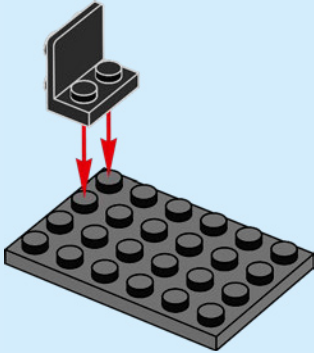

113

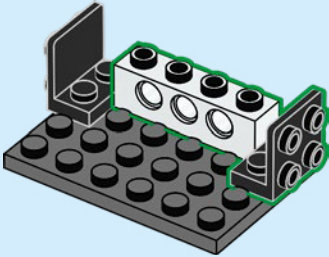



1x

114

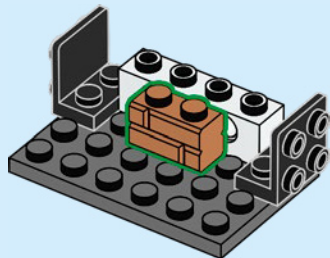

1x

115

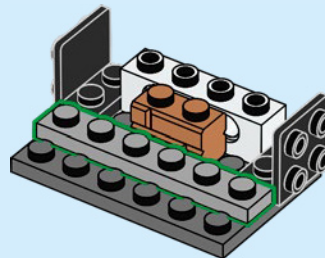



3x

116

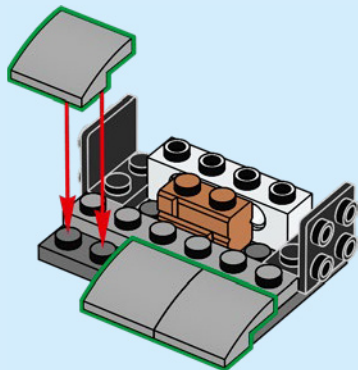

2x

117

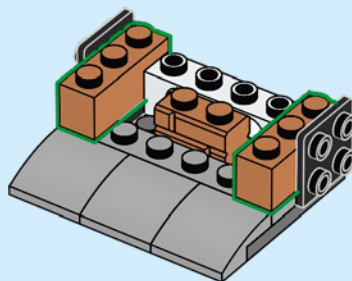



2x

118

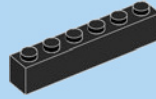
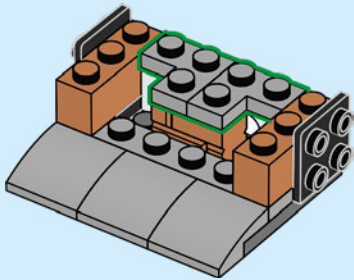

1x

119

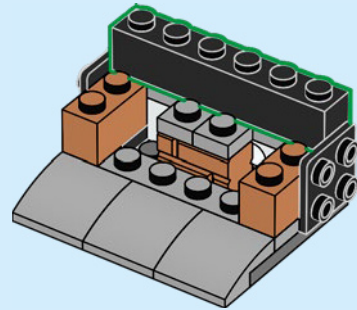



2x

120

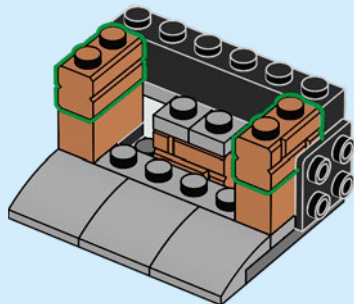

1x

121

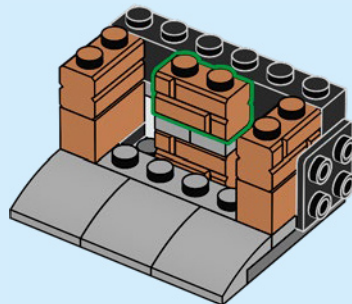



1x



1x

122

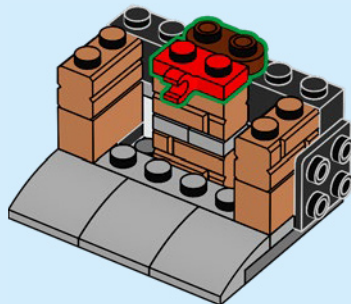

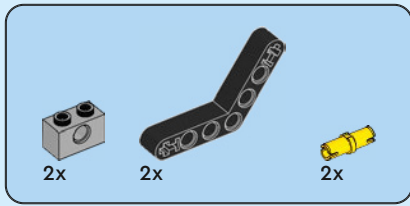

123

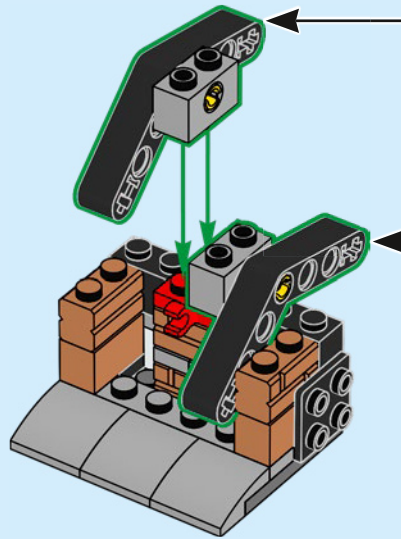
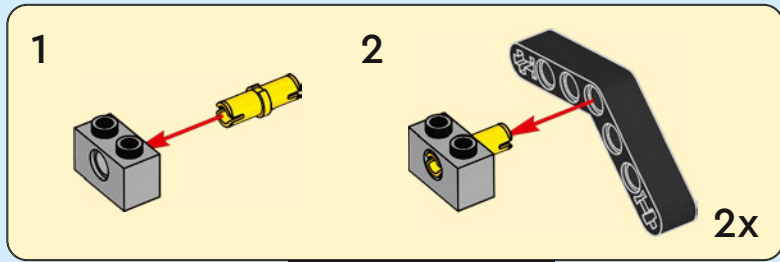



2x

124

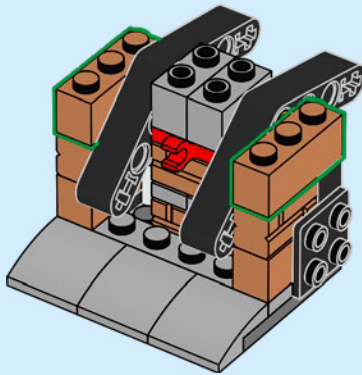

2x

125

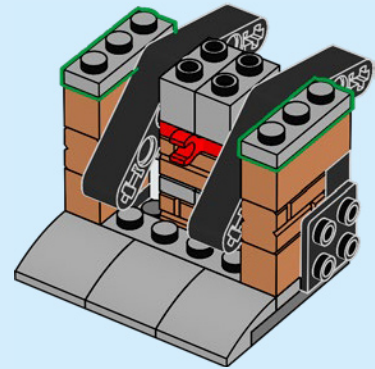

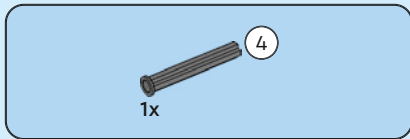

126

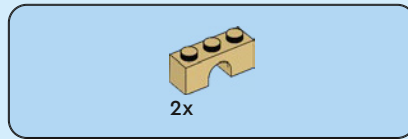
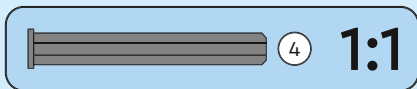
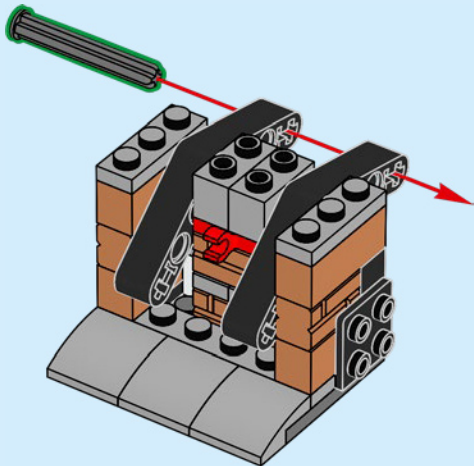

127

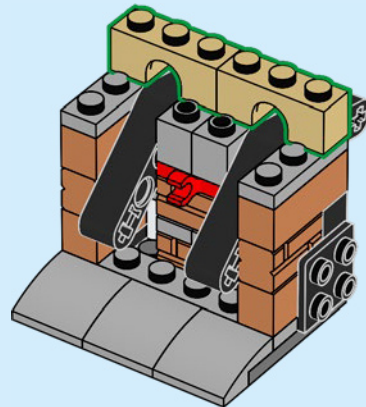

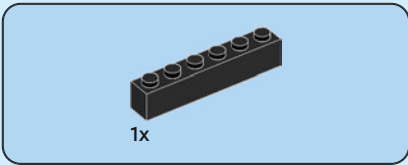

128

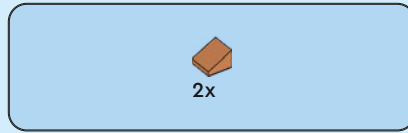
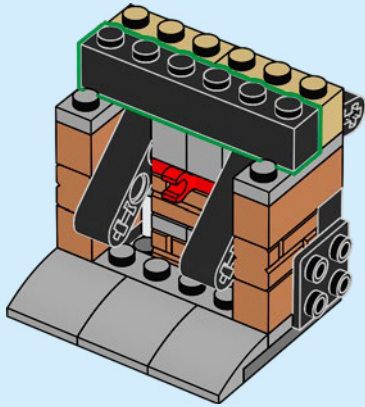

129

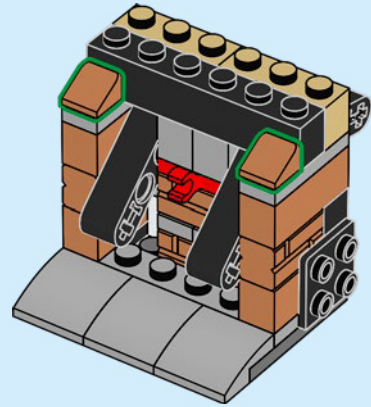



2x

130

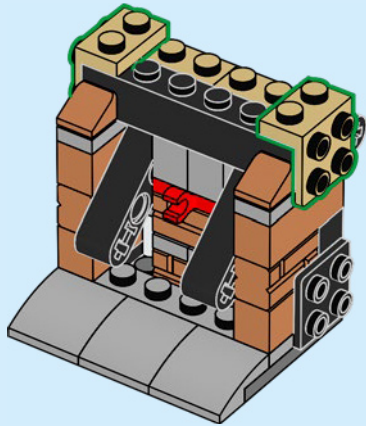

1x

131

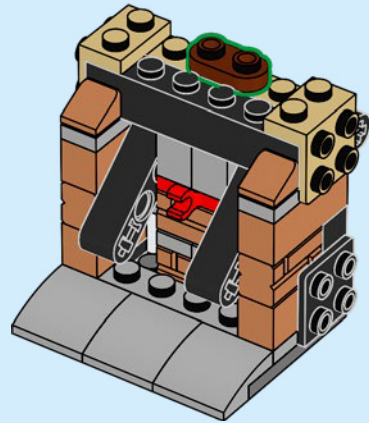



132

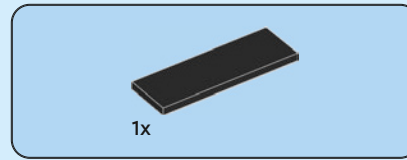
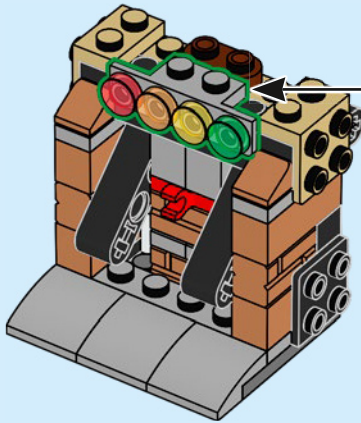
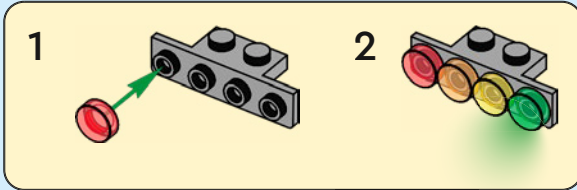

133

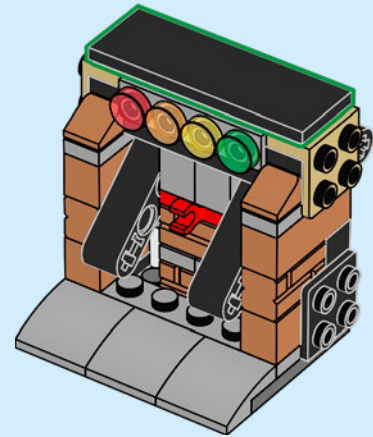

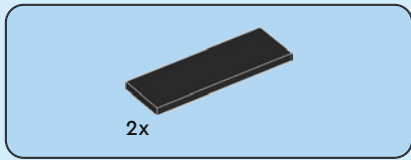

134

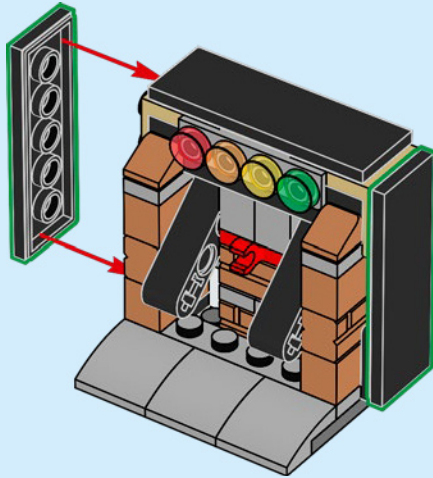

135

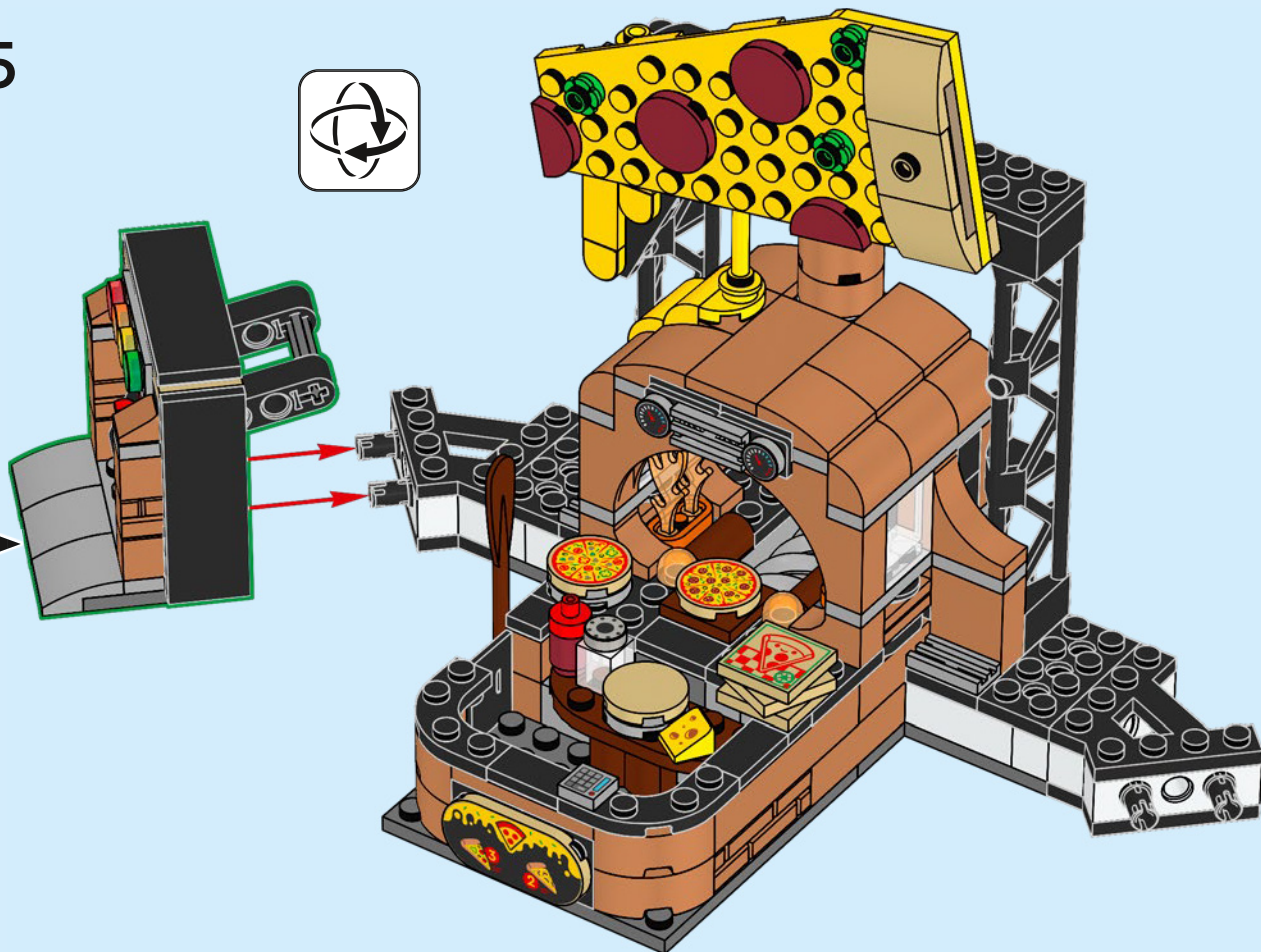



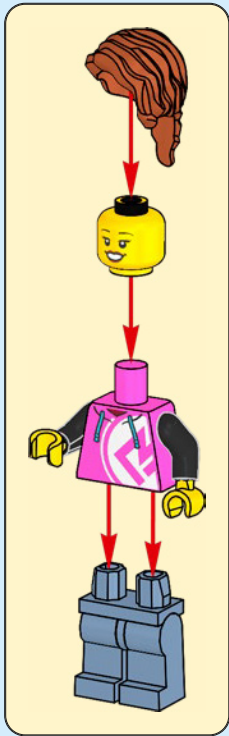

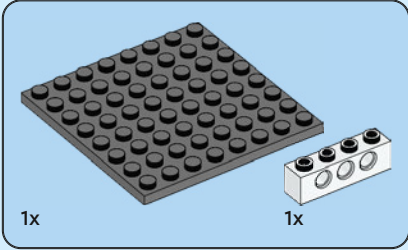
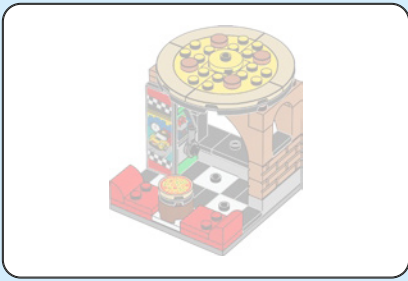

136

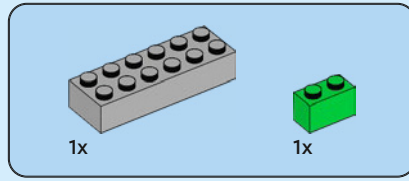
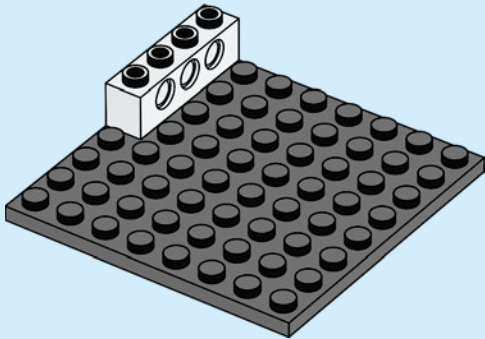

137

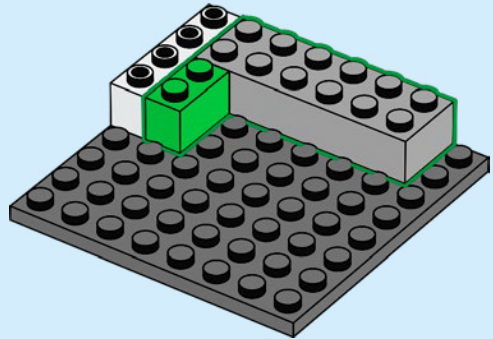

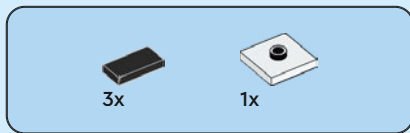

138

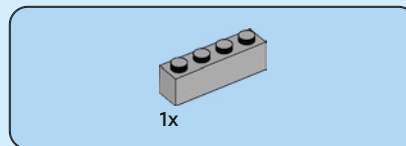
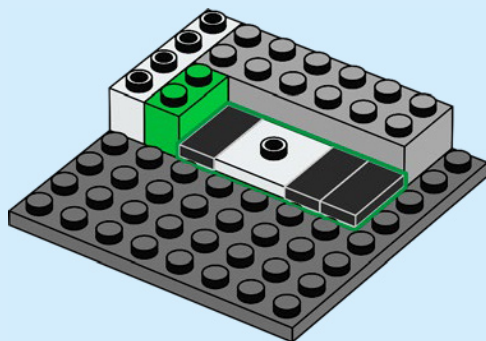

139

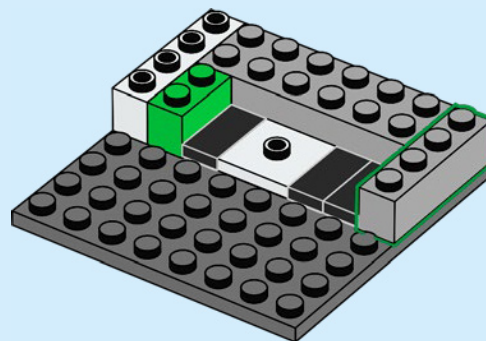

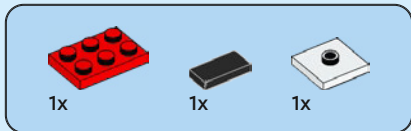

140

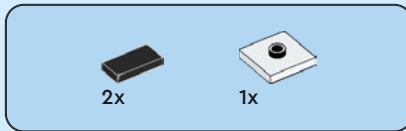
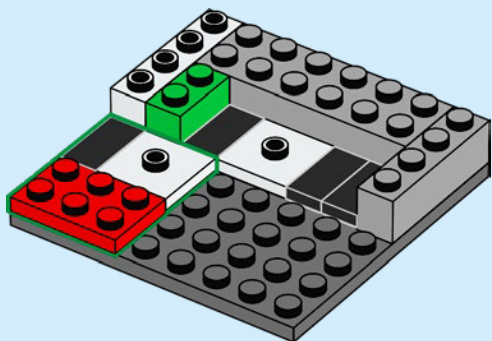

141

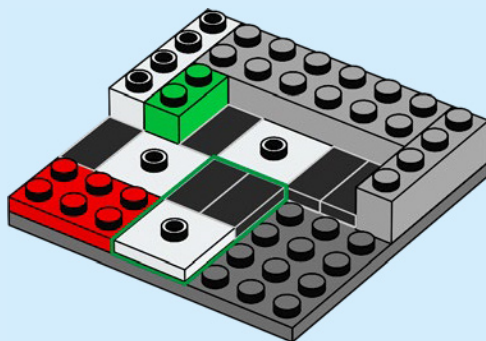

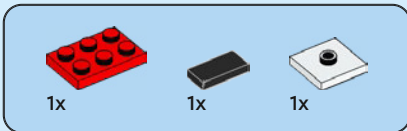

142

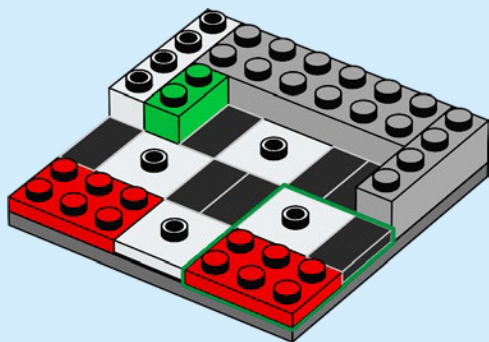

143

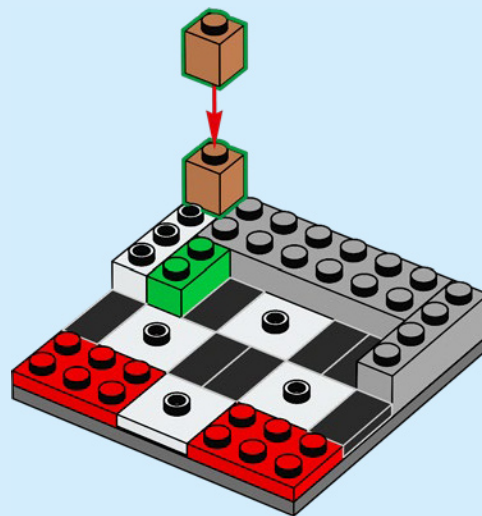

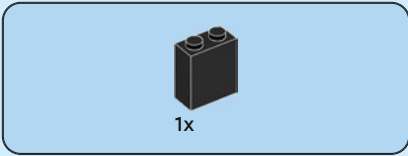

144

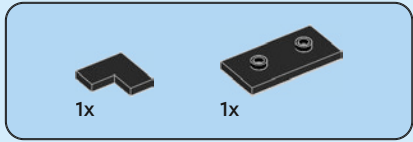
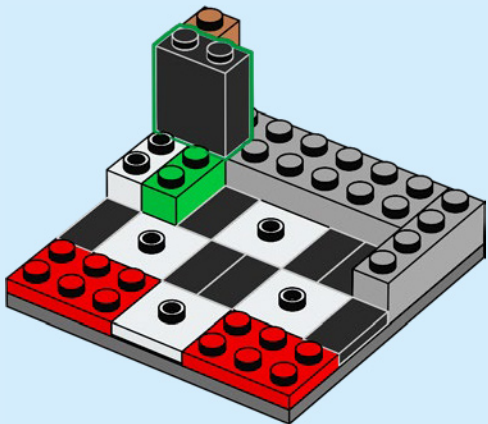

145

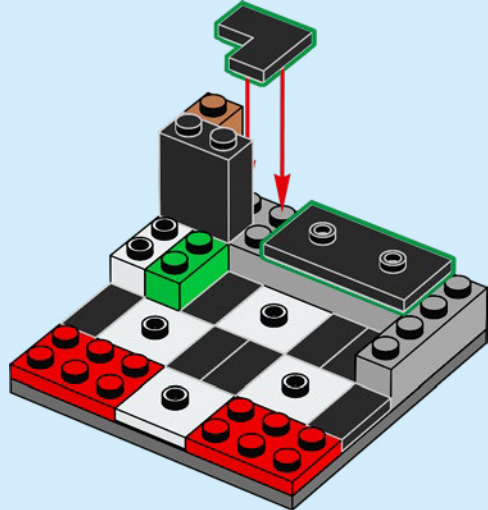

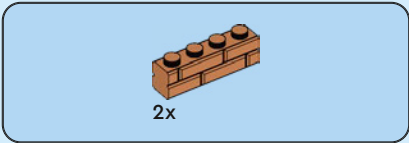

146

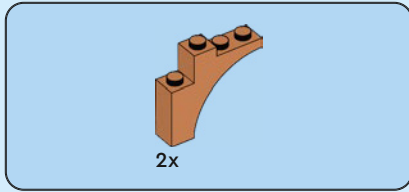
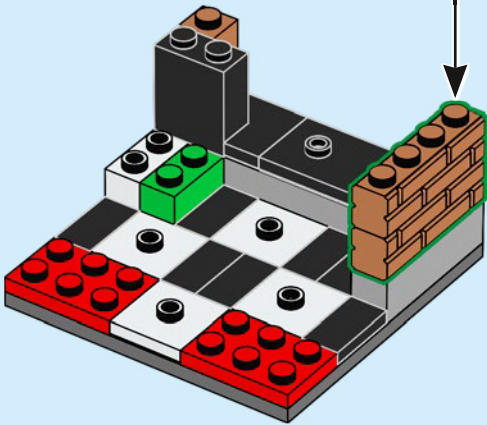
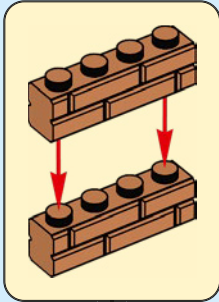

147

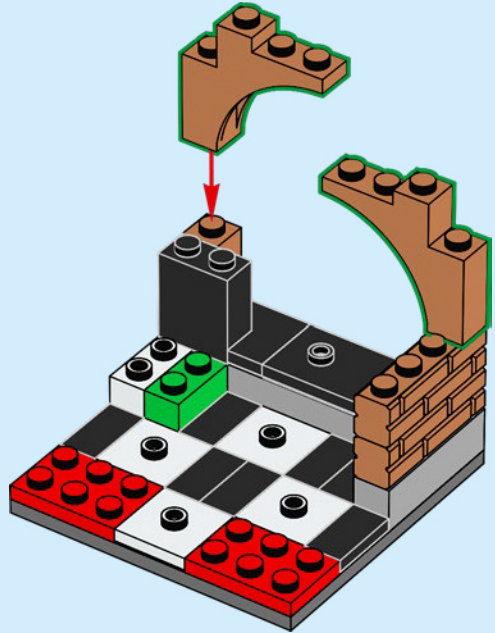



1x

148

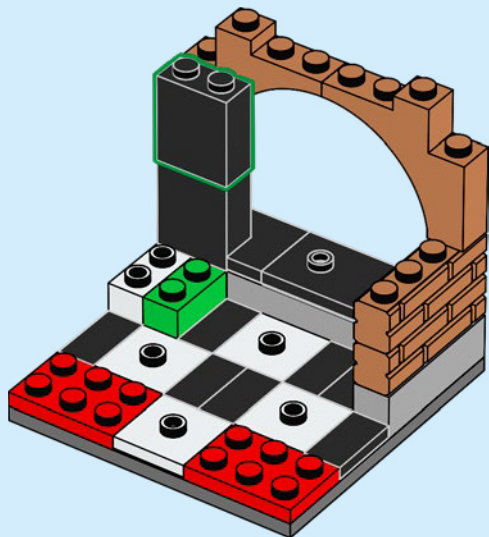

1x

149

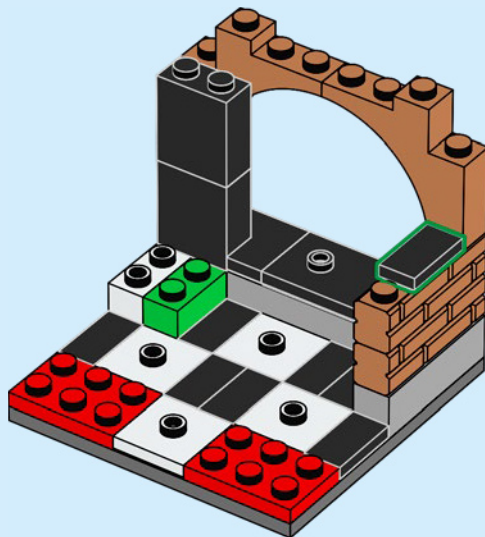



1x

150

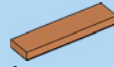
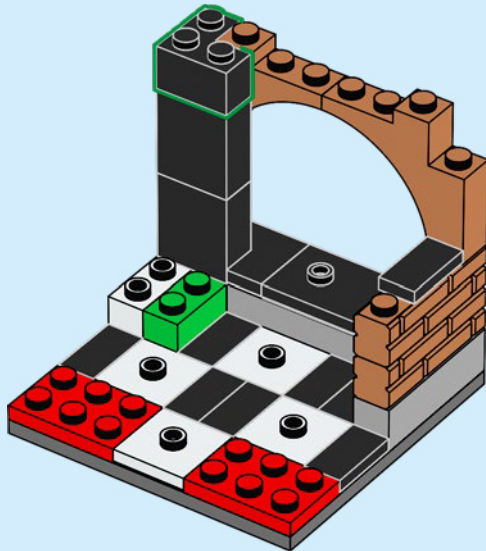

1x

151

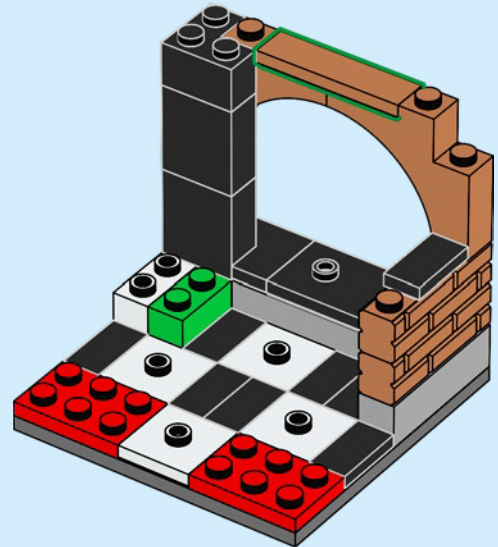



1x



1x

152

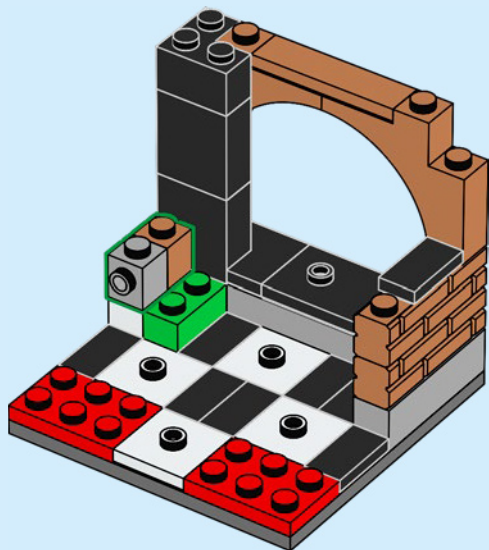

1x



1x

153

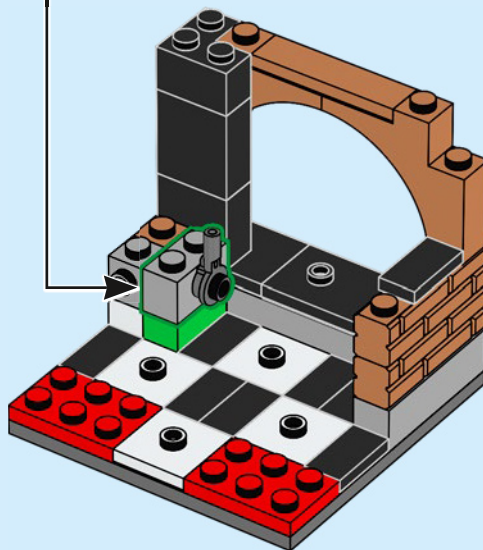
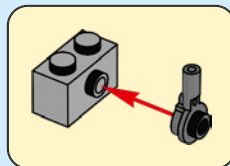

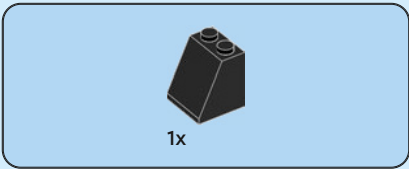

154

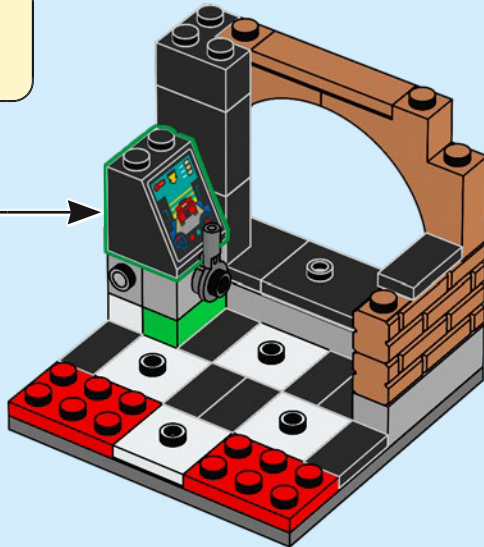
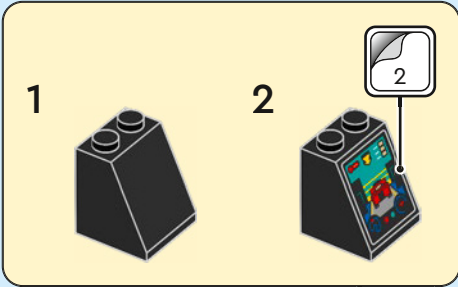

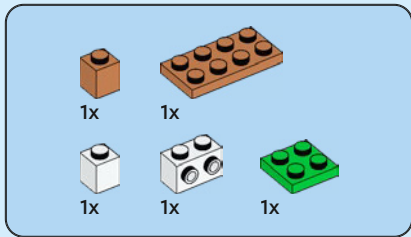

155

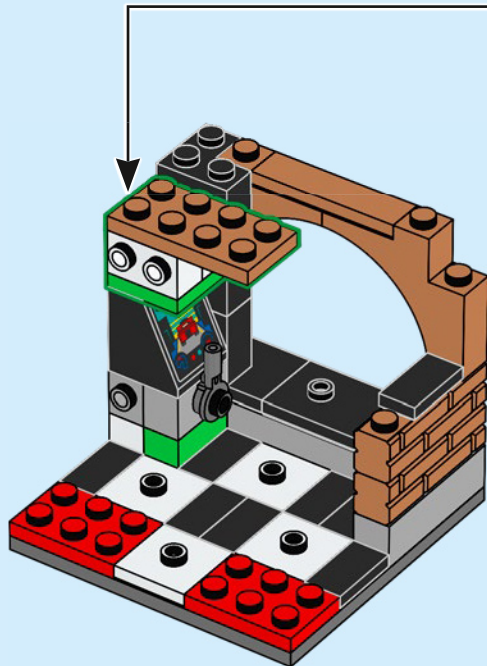
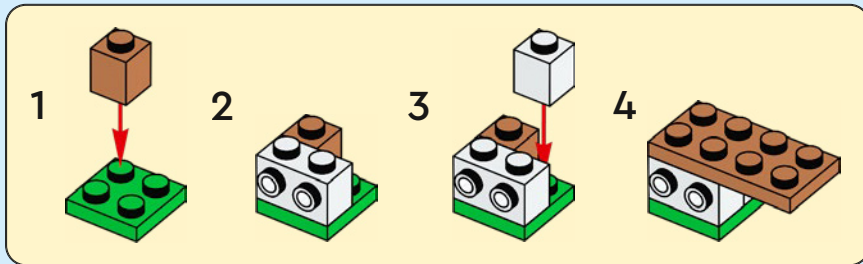

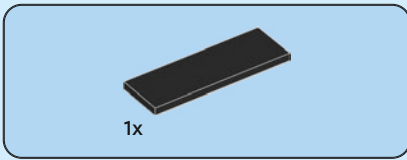

156

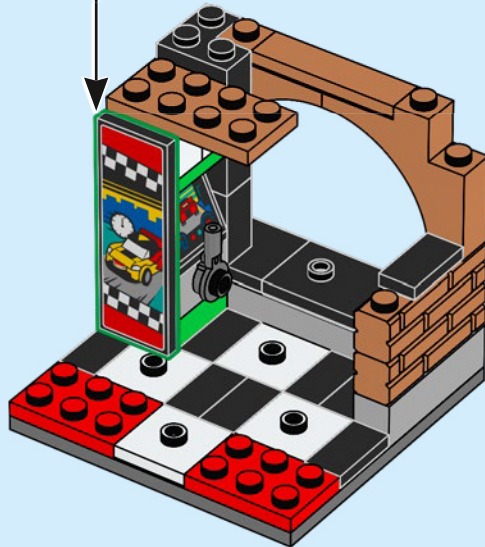
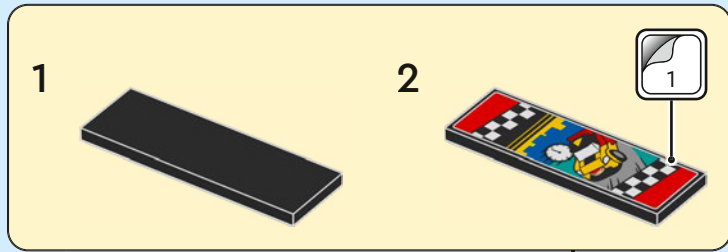

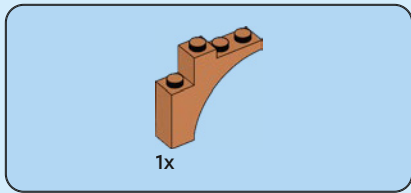

157

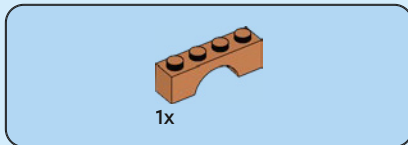
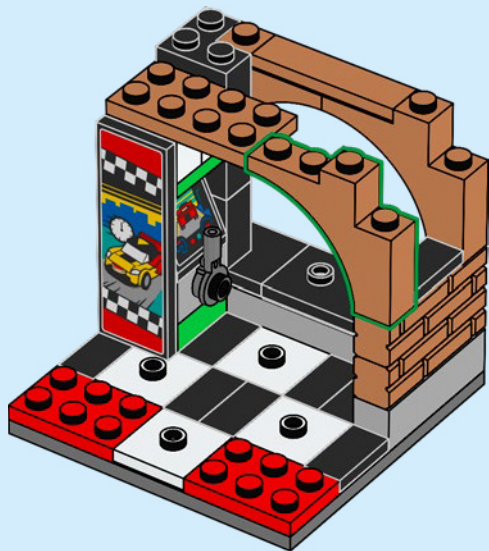

158

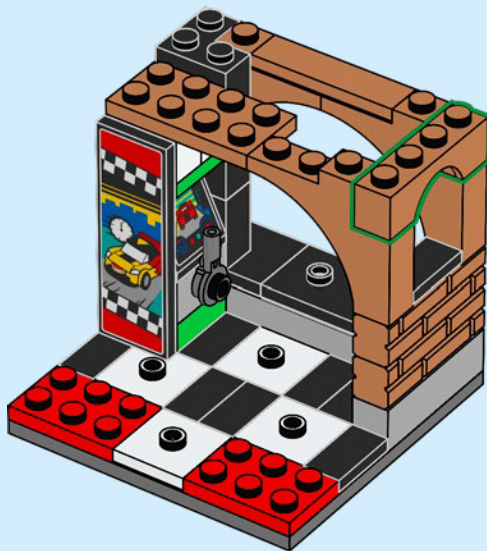

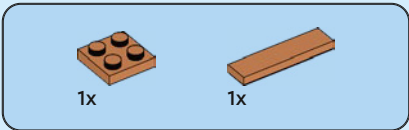

159

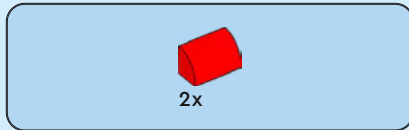
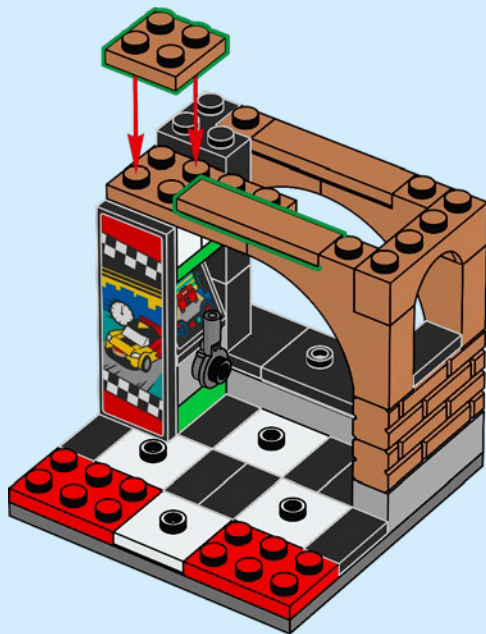

160

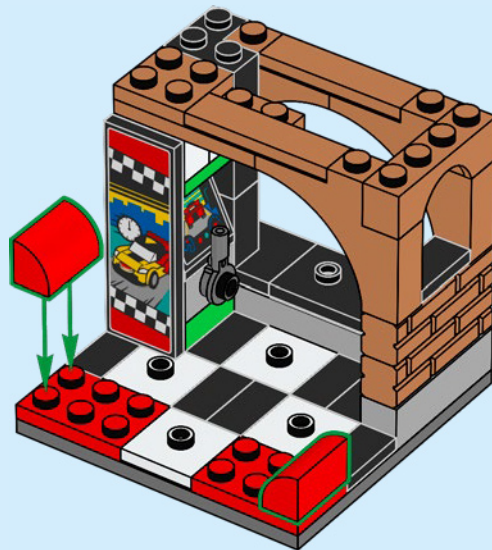



2x

161

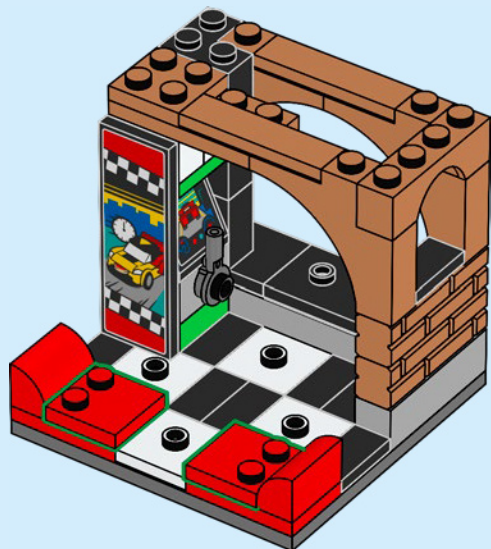

1x



1x



1x

162

1



2

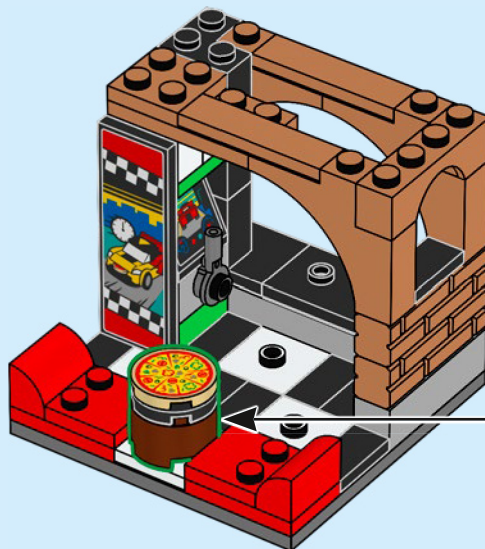

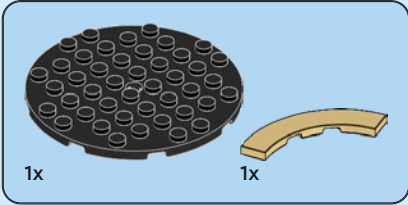
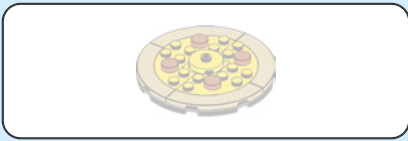

163

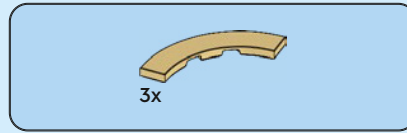
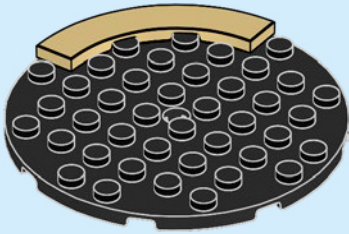

164

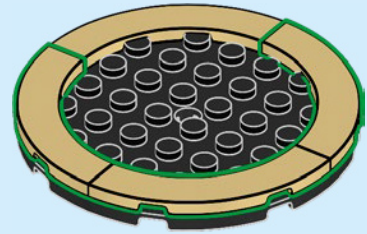

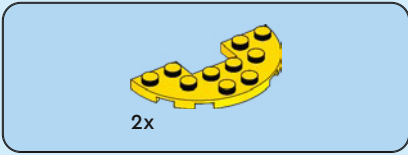

165

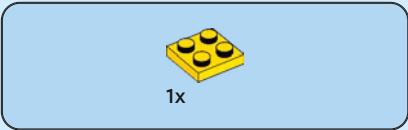
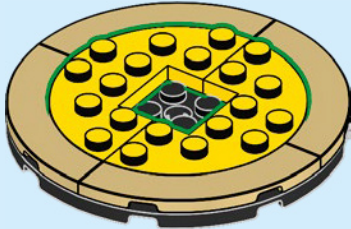

166

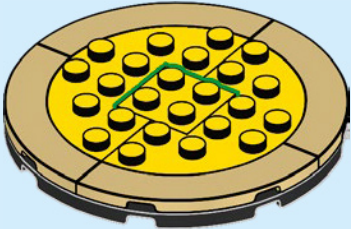



167

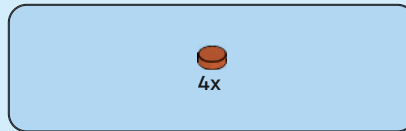
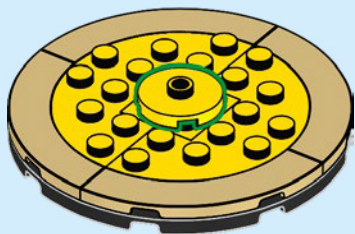

168

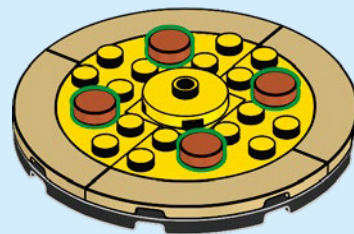

169



170

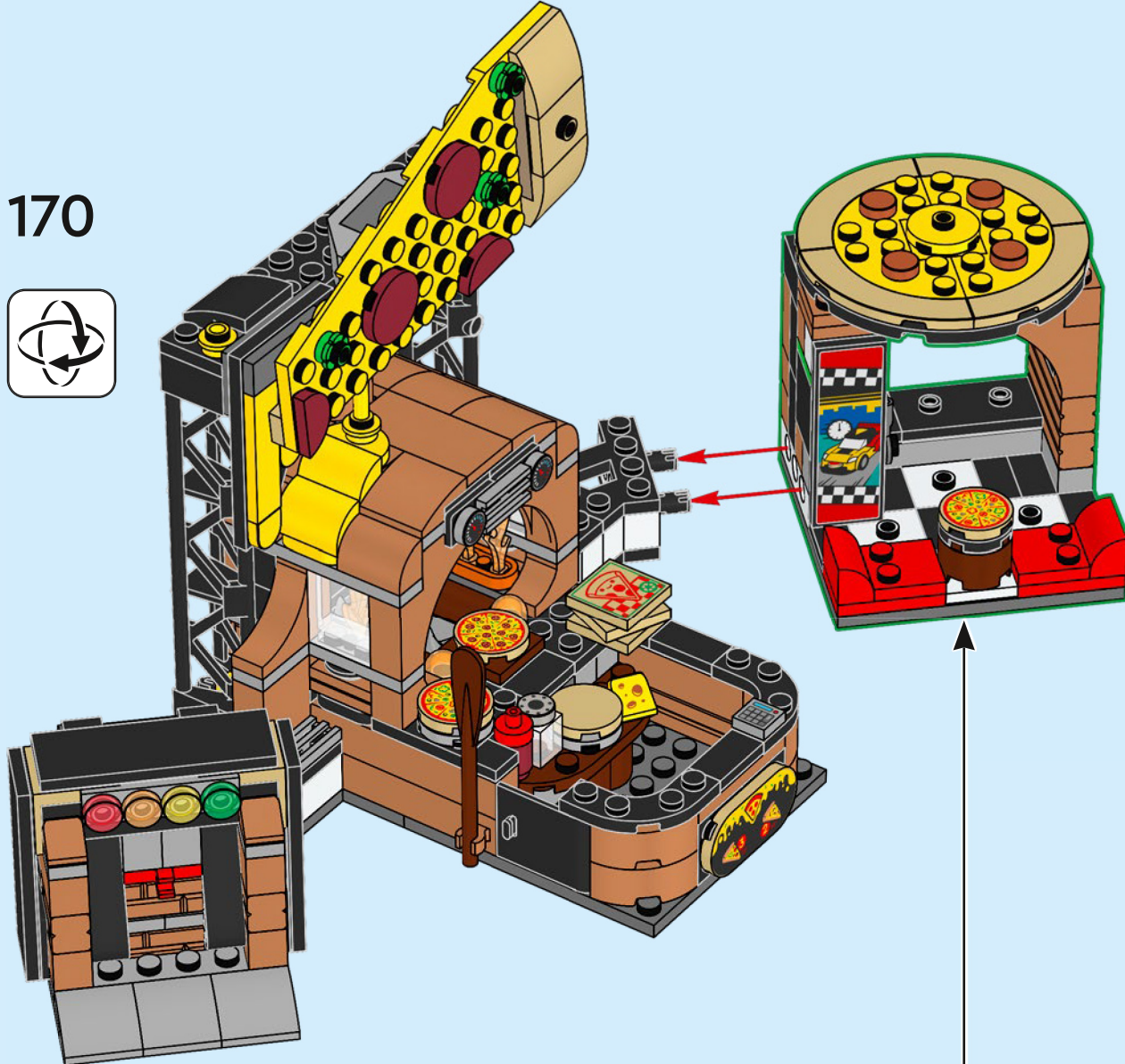

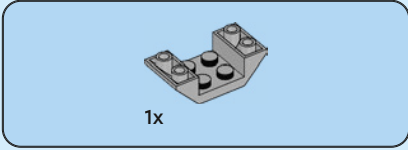
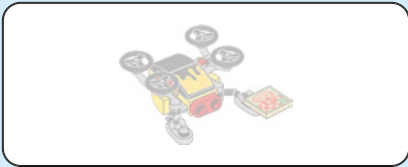

171

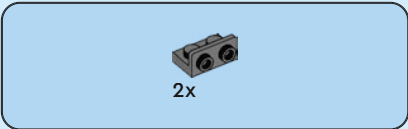
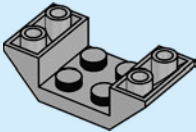

172

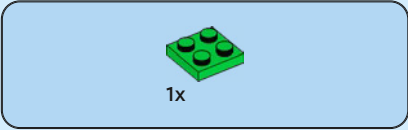
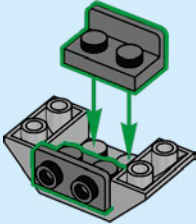

173

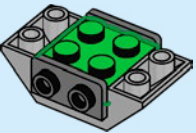



1x

174

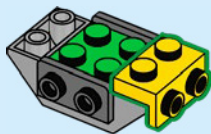

2x

175

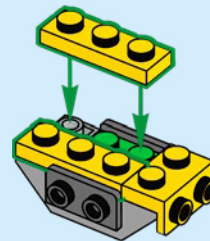

2x

176

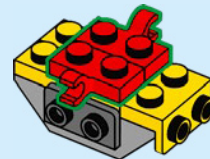



1x

177

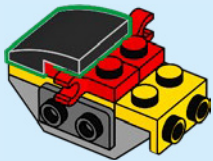

1x

178

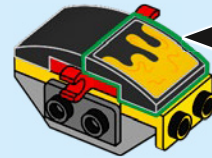
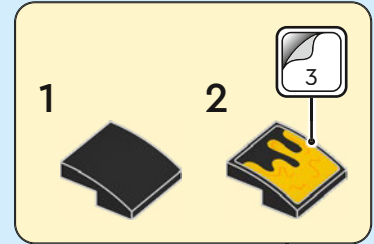

1x

179

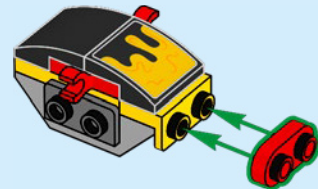



2x

180

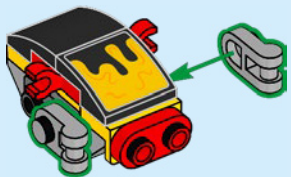

2x

181

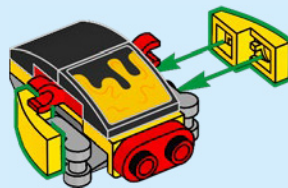

2x

182

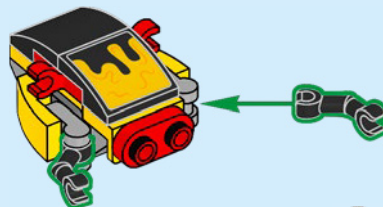



2x

183

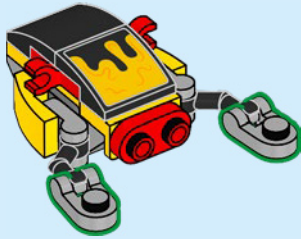

1x

184

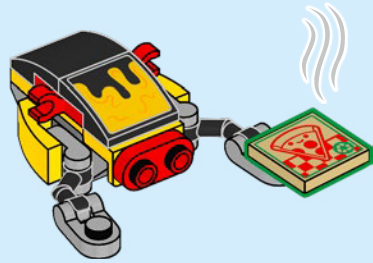

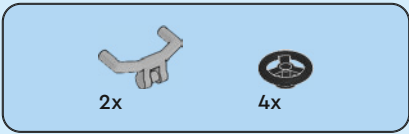

185

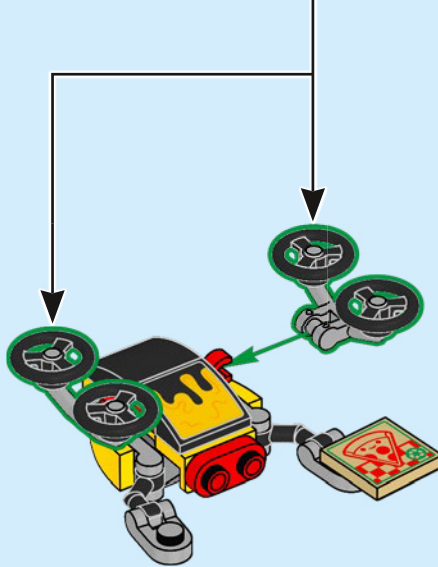
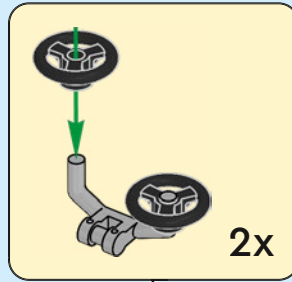

186

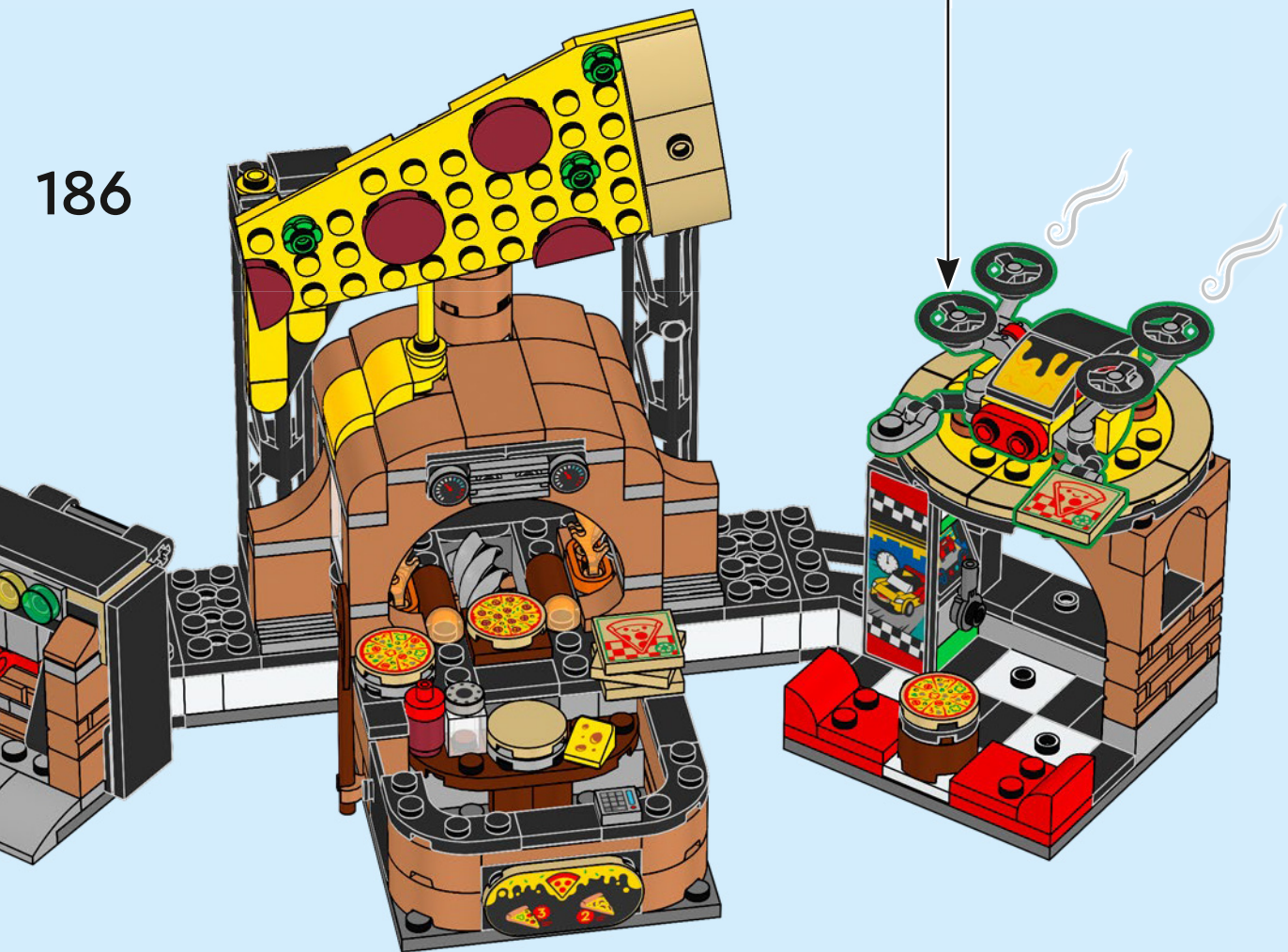



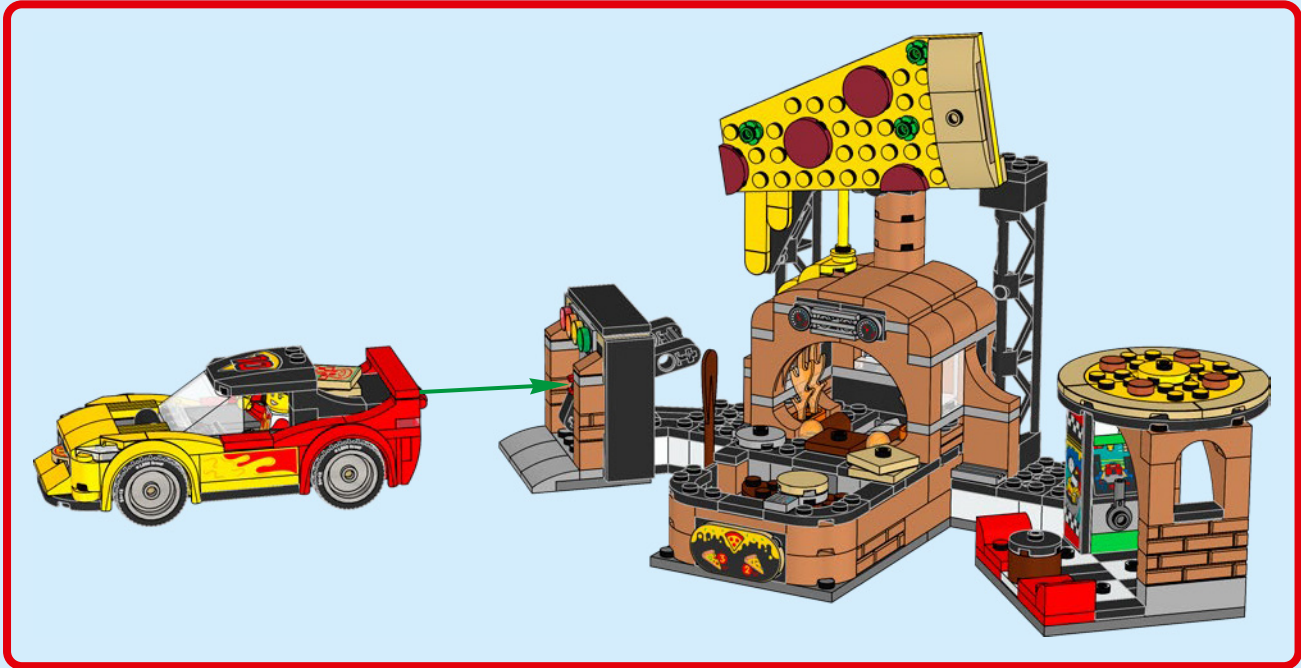

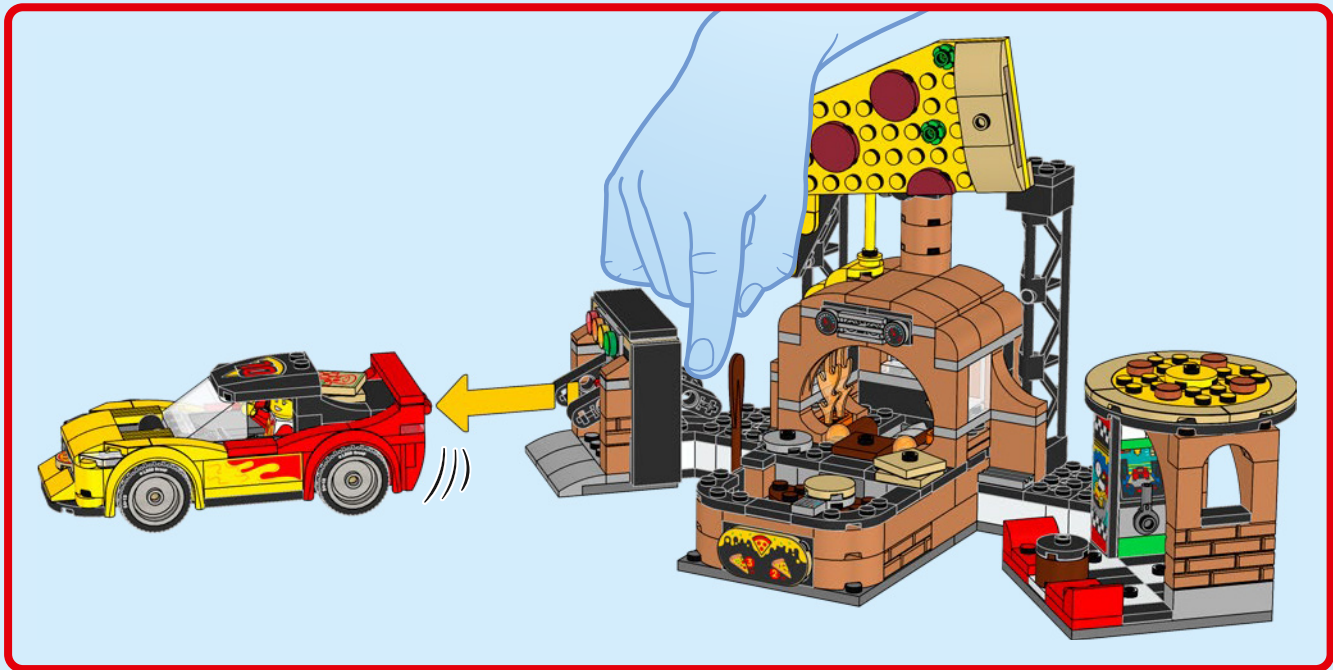



CITY

60496



60501



60506



60511





CITY

60494



60492



60497



60480





CITY

60500



60485

60479



60488



60486



1x
300501

1x
6058177

4x
6126046

2x
362201

3x
6614865

8x
370101

1x
4560178

2x
4187743

1x
4621548

1x
6215539

2x
302421

1x
4298617

1x
6210269

1x
4650646

2x
6252037

3x
6313120

2x
306921

1x
4140585

2x
6219819

2x
6105976

2x
6586666

2x
6365716

4x
302121

2x
6441691

1x
6608284

3x
4113858

5x
4666579

2x
6614159

1x
6066344

2x
6174830

1x
4507055

1x
4107623

1x
6092587

2x
6117975

4x
4565387

2x
6046924

4x
6581644

2x
4618651

1x
6614158

2x
6351905

4x
6458175

2x
4620909

2x
6396673

1x
6439273

4x
6322840

1x
6409765

1x
6536259

2x
6284577

2x
6168644

3x
6300104

1x
6649379

1x
6642356

1x
6642354

1x
6384570

1x
6521192

1x
6338182

2x
6596025

1x
6510151

1x
6510138

1x
6547142

5x
6248971

2x
6331822

2x
4550348

1x
6299764

1x
306924

2x
6297284

2x
241224

2x
6029947

1x
6185994

1x
302224

2x
6079007

3x
6130007

2x
6586861

2x
362324

2x
6506036

1x
6116606

1x
243124

1x
6599854

1x
6599855

3x
302024

2x
6488000

2x
6257060

1x
6614070

2x
6329581

2x
4211389

1x
6329583

1x
4558953

2x
6401023

2x
6285598

1x
6227897

4x
6225246

1x
6329152

2x
6183782

1x
4550325

1x
4227657

2x
4211398

3x
4211350

2x
6066097

1x
6383177

2x
4211440

2x
4211353

3x
6102357

1x
6551141

2x
4644102

2x
4211429

1x
6168615

1x
4211394

2x
4211517

8x
4211438

1x
6417811

2x
4211795

6x
6560654

2x
6508152

2x
307026

6x
300526

1x
6356860

1x
6245281

3x
6210270

2x
6302313

4x
6057397

8x
6279875

1x
6195325

2x
6275806

11x
306926

1x
6162275

2x
4267874

2x
4211392

2x
4618852

1x
4226995

1x
6472004

2x
6020193

2x
6000650

1x
6588938

4x
6053077

1x
4273703

1x
6133722

1x
325726

2x
6470981

2x
6328095

4x
6102596

1x
6258214

2x
6428167

1x
6521191

1x
6356162

4x
6174917

2x
6325190

4x
370926

1x
6438520

1x
4560182

1x
6575837

4x
6054852

1x
6614157

2x
6278125

4x
300926

2x
379526

4x
6318582

1x
6393938

1x
244526

1x
6575801

1x 6550579
 2x 6210271
 3x 6206150
 1x 4647553
 2x 6357612
 1x 6392114
 1x 6452140
 1x 6388118
 2x 4226221
 2x 4211111
 2x 6000606
 1x 4261908
 1x 6126083
 1x 4568734

1x 4225733
 1x 6118832
 1x 6083620
 2x 6092649
 1x 6338291
 1x 6186825
 1x 4211115
 1x 4210997
 2x 4211061
 2x 4210802

4

1x 6442990
 1x 6420630
 1x 6517634
 4x 6527033
 4x 6057986
 2x 6167690
 1x 6360035
 3x 6454167
 4x 6401021
 5x 6292154
 4x 6499713
 6x 4656783
 5x 6334102
 5x 6312473

1x 6056383
 4x 6346464
 5x 6192922
 2x 6189103
 3x 6167700
 5x 6652466
 4x 6055309
 1x 6467273
 2x 6102998
 1x 6218359
 1x 6093494
 5x 6099341

1x 6514191
 1x 6514207
 1x 6515311
 1x 6515310
 1x 6244787
 4x 6514185
 1x 6507933
 1x 6514189
 2x 6514003
 1x 6514193
 1x 6514194
 1x 6514197
 4x 6509776
 4x 6167741

2x 6248944
 1x 4211166
 1x 4211180
 2x 6433392
 1x 4565394
 2x 6365882
 1x 6357946
 1x 4609635

1x 6361354
 1x 6551965
 4x 6442368
 1x 4539099
 2x 6532669
 2x 6264149
 1x 4541496
 1x 4267425



[LEGO.com/service](https://www.LEGO.com/service)

YOU COULD **WIN**



Scan this QR code or go to **LEGO.COM/PRODUCTFEEDBACK** and give us your short feedback about this LEGO® set for a chance to win a cool LEGO prize.

Terms and Conditions apply*

EN: YOU COULD WIN. Terms and Conditions apply* **DE: Du könntest GEWINNEN.** Es gelten die Teilnahmebedingungen* **FR: TU POURRAIS GAGNER.** Des conditions s'appliquent* **IT: Potresti VINCERE tu.** Termini e condizioni sono applicabili* **ES: PUEDES GANAR.** Aplican términos y condiciones* **PT: PODERÁ GANHAR.** Aplicam-se Termos e Condições* **ZH: 轻松获奖. 条款和条件适用*** **PL: Szansa na WYGRANĄ.** Obowiązuje regulamin* **CS: Máte šanci VYHRÁT.** Platí všeobecné smluvní podmínky* **SK: Máte šancu VYHRAŤ.** Platia všeobecné zmluvné podmienky* **HU: TE IS NYERHETSZ!** Felhasználási feltételek érvényesek* **UA: ВИ МОЖЕТЕ ВИГРАТИ.** Застосовуються загальні положення та умови* **RO: Ai putea CÂȘTIGA.** Se aplică termeni și condiții* **BG: Можете да СПЕЧЕЛИТЕ.** Има определени правила и условия* **LV: Tu vari LAIMĒT.** Ir spēkā noteikumi un nosacījumi.* **ET: Sul on võimalus VÕITA.** Kehtivad tingimused* **LT: Jūs galite LAIMĖTI.** Taikomos sąlygos* **TR: KAZANABİLİRSİN.** Şartlar ve Koşullar geçerlidir*

*[LEGO.com/productfeedback-terms](https://www.lego.com/productfeedback-terms)