



BRICK HEADZ

40924





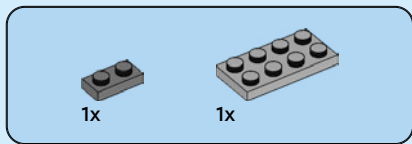

1

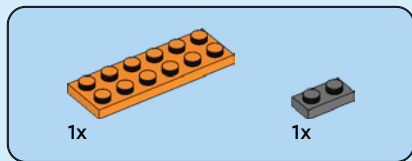
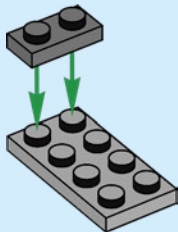

2

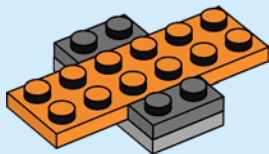



4x

3

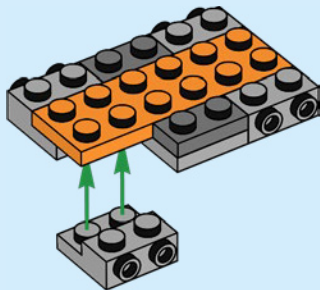

4



1x

4

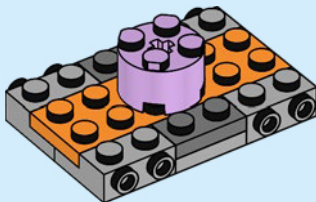

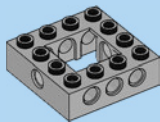

1x

5

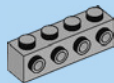
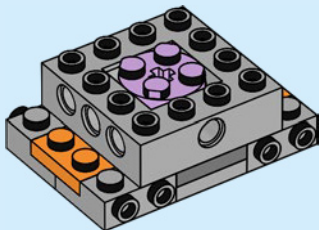

2x

6

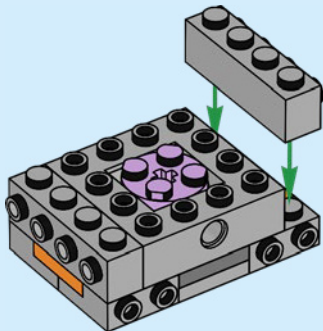



4x



1x



2x

7

1

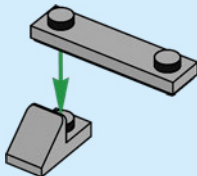

2

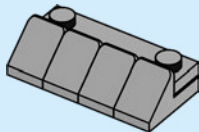

3

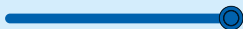
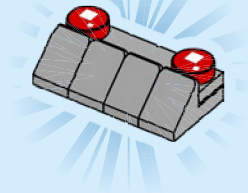

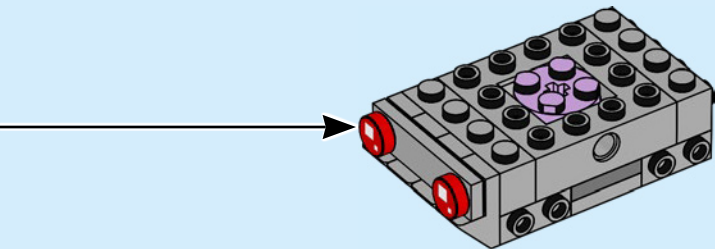



2x

8

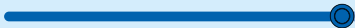
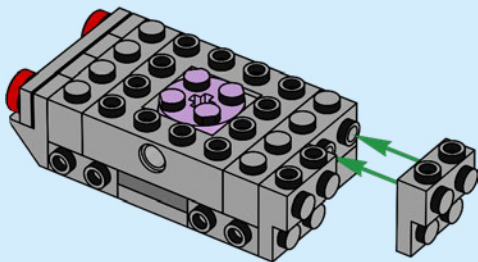



2x



1x

9

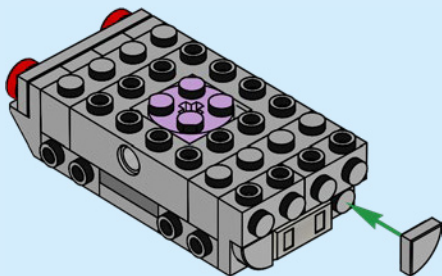



4x



8x



8x



4x

10

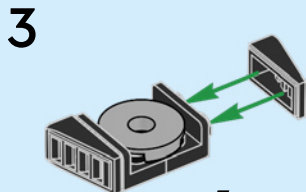
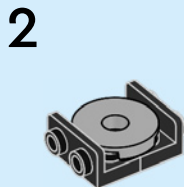
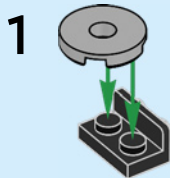

4x

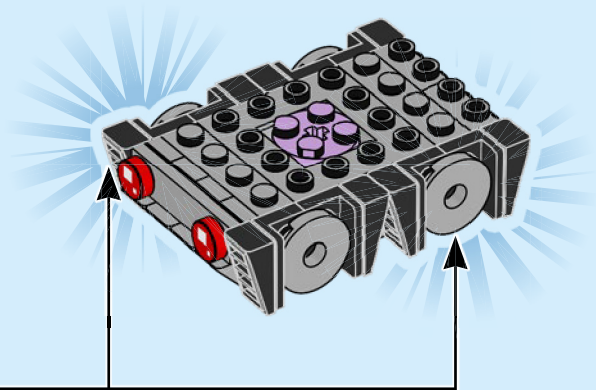



2x



2x



4x

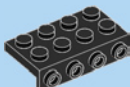

2x

11

1

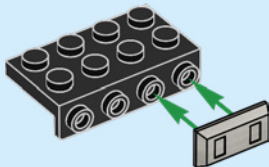

2

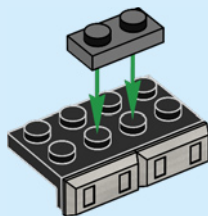

2x

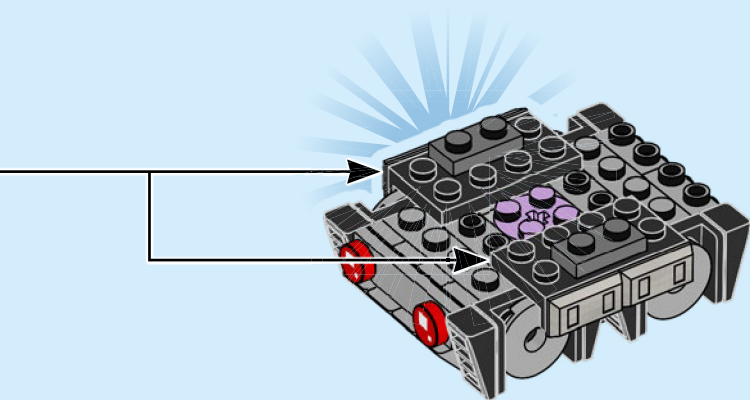





12

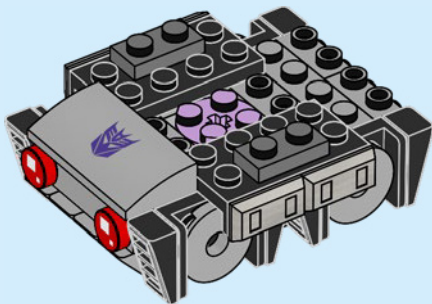



2x



2x

13

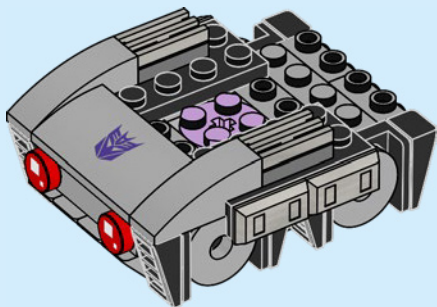

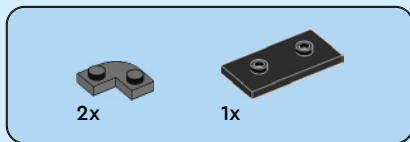

14

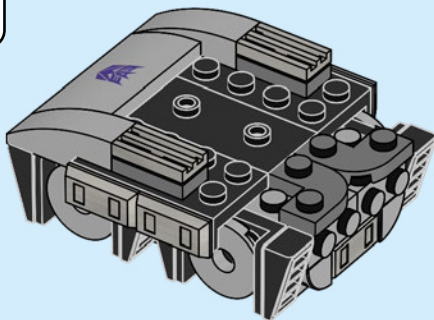
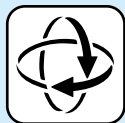

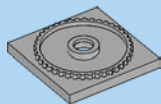

1x

15

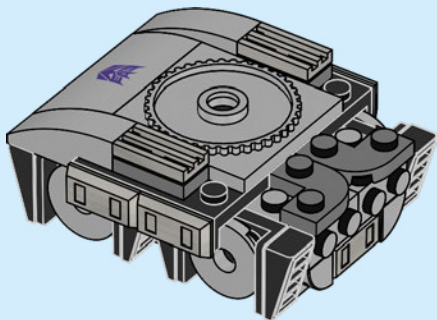



1x



2x

16

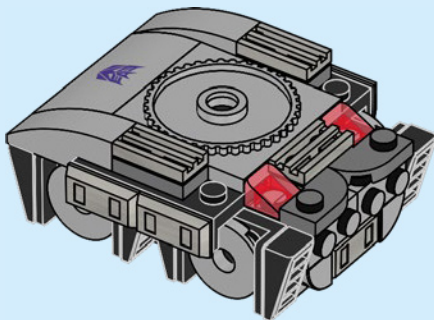



2x

17

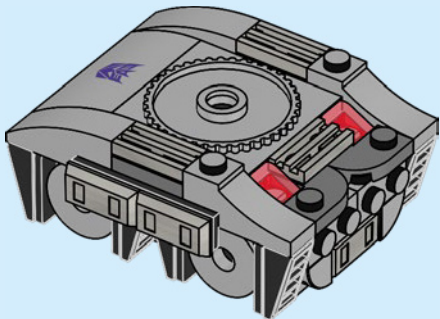



4x

18

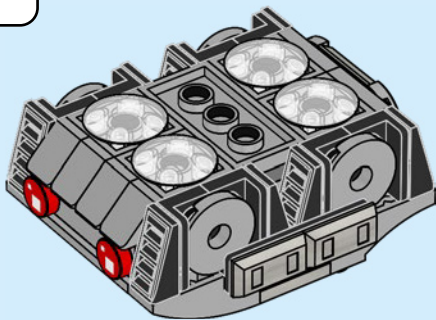
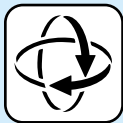

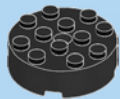

1x



1x

19

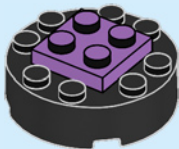



4x

20

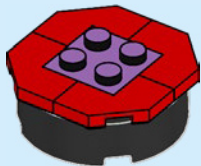

1x



2x

21

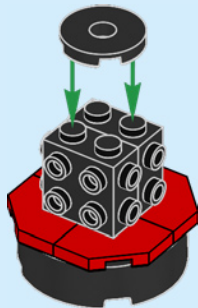



1x



1x

22

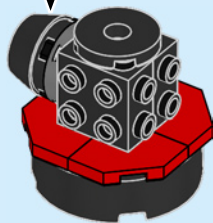
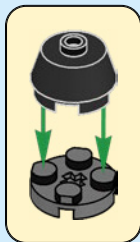

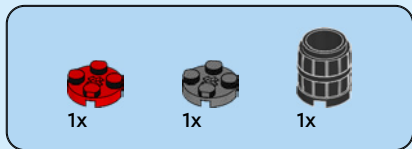

23

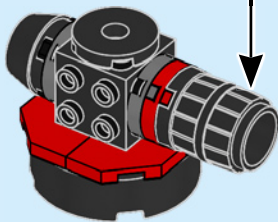
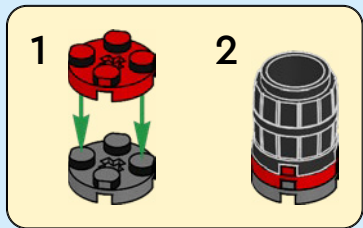

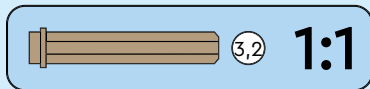
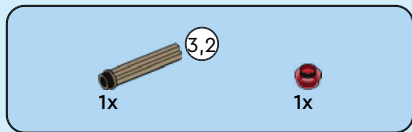

24

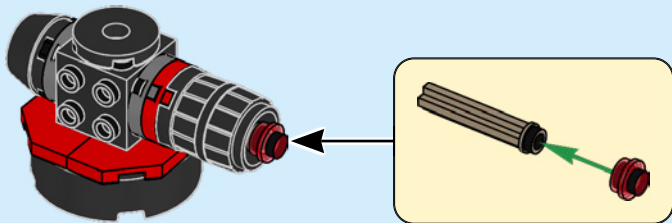



1x



1x

25

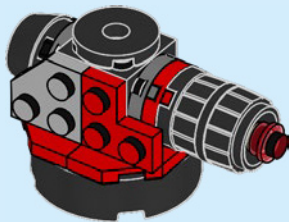

1x



1x

26

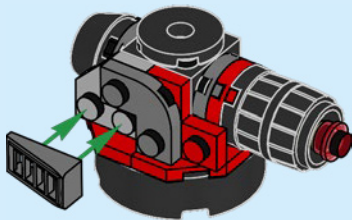



1x



1x

27

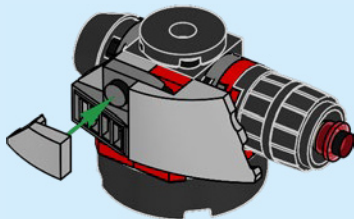



1x



1x

28

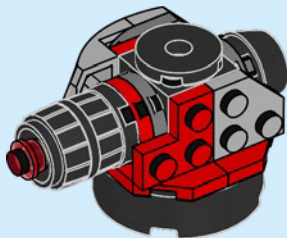

1x



1x

29

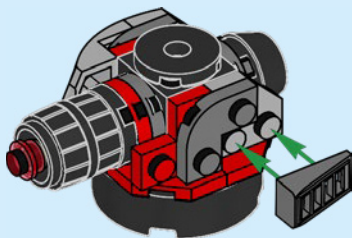



1x



1x

30

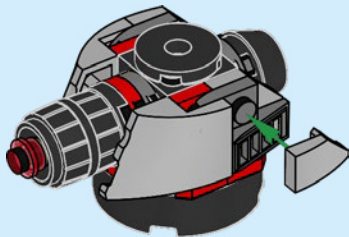

31

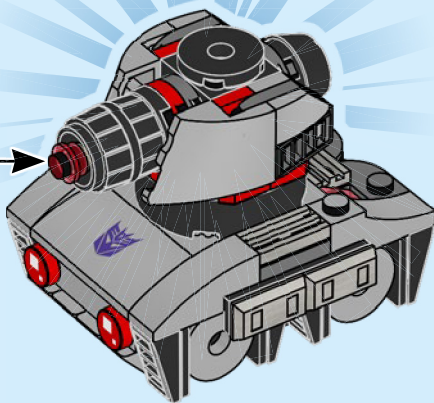

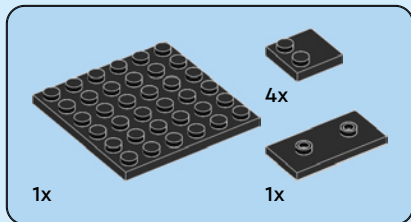

32

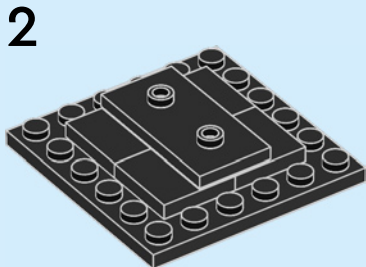
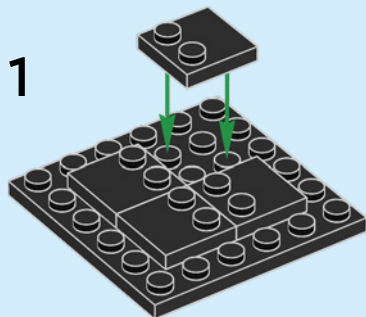

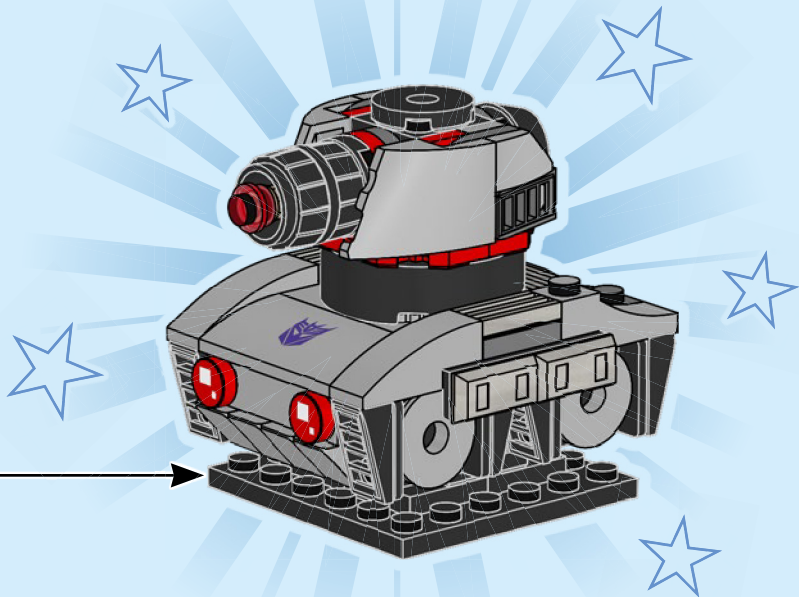

2x
6588365

4x
6618179

2x
6210269

4x
403221

2x
6135130

4x
6217194

2x
242021

2x
6118830

1x
6624698

1x
6344819

1x
6510139

1x
6510125

1x
4512363

1x
6300358

1x
4653822

1x
6195325

1x
6143850

8x
4541191

4x
302326

2x
6313116

8x
6020193

2x
6308883

4x
6192346

1x
6254045

3x
243126

1x
4558957

2x
6438520

1x
302026

1x
4560182

2x
6491823

2x
395826

2x
6031821

2x
300328

4x
6581772

1x
6514051

2x
6245252

1x
4121741

1x
6490767

3x
4619636

5x
6208446

2x
4211042

4x
4540386

4x
4211063

6x
6411395

4x
4211001

1x
4243831

2x
6176433

2x
4211399

1x
6225142

1x
6225139

1x
6558799

1x
6558800

2x
4568637

4x
6179186

2x
6186657

8x
6093859

12x
6123809

6x
4211398

4x
6493586

1x
6375808

1x
6102357

4x
4211353

12x
6469440

1x
6245254

2x
4251163

14x
6329117

1x
6375815

2x
4211636

2x
6257593

5x
4211356

10x
4211395

1x
6617575

1x
6617576

2x
4597901

1x
6045718

1x
4211640

1x
6485862

2x
6223600



 [LEGO.com/service](https://www.LEGO.com/service)

YOU COULD **WIN**



Scan this QR code or go to **LEGO.COM/PRODUCTFEEDBACK** and give us your short feedback about this LEGO® set for a chance to win a cool LEGO prize.

Terms and Conditions apply*

EN: YOU COULD WIN. Terms and Conditions apply* **DE: Du könntest GEWINNEN.** Es gelten die Teilnahmebedingungen* **FR: TU POURRAIS GAGNER.** Des conditions s'appliquent* **IT: Potresti VINCERE tu.** Termini e condizioni sono applicabili* **ES: PUEDES GANAR.** Aplican términos y condiciones* **PT: PODERÁ GANHAR.** Aplicam-se Termos e Condições* **ZH: 轻松获奖.** 条款和条件适用* **PL: Szansa na WYGRANA.** Obowiązuje regulamin* **CS: Máte šanci VYHRÁT.** Platí všeobecné smluvní podmínky* **SK: Máte šancu VYHRÁŤ.** Platia všeobecné zmluvné podmienky* **HU: TE IS NYERHETSZ!** Felhasználási feltételek érvényesek* **UA: ВИ МОЖЕТЕ ВИГРАТИ.** Застосовуються загальні положення та умови* **RO: Ai putea CÂȘTIGA.** Se aplică termenii și condiții* **BG: Можете да СПЕЧЕЛИТЕ.** Има определени правила и условия* **LV: Tu vari LAIMĒT.** Ir spēkā noteikumi un nosacījumi.* **ET: Sul on võimalus VÕITA.** Kehtivad tingimused* **LT: Jūs galite LAIMĖTI.** Taikomos sąlygos* **TR: KAZANABİLİRSİN.** Şartlar ve Koşullar geçerlidir*

*[LEGO.com/productfeedback-terms](https://www.lego.com/productfeedback-terms)

LEGO and the LEGO logo are trademarks of the LEGO Group. ©2026 The LEGO Group.

TRANSFORMERS and HASBRO and all related trademarks and logos are trademarks of Hasbro, Inc. ©2026 Hasbro.
In Japan only: © T O M Y



6650679