



BRICK HEADZ

40924



LEGO® Builder





Get excited about our new packaging!

We're switching from plastic to paper-based packaging. That's why you might find a mix of paper and plastic in our boxes!

Nos nouveaux emballages vous emballeront !

Nous passons des emballages en plastique aux emballages à base de papier. C'est pourquoi vous pourriez trouver un mélange de papier et de plastique dans nos boîtes !

¡Te presentamos nuestros nuevos empaques!

Estamos sustituyendo las bolsas de plástico por bolsas con base de papel. ¡Por eso, puedes encontrar una mezcla de papel y de plástico en nuestras cajas!

[LEGO.com/sustainable-packaging](https://www.lego.com/sustainable-packaging)



LEGO® Builder

BUILDER



Apple and the Apple logo are trademarks of Apple Inc., registered in the U.S. and other countries and regions. App Store is a service mark of Apple Inc. Google Play and the Google Play logo are trademarks of Google LLC. Tencent and the Tencent logo are trademarks of Tencent Inc.

[LEGO.com/devicecheck](https://www.lego.com/devicecheck)

EN Ask parents' permission before going online | **DE** Eltern um Erlaubnis bitten, bevor du online gehst | **FR** Demande l'autorisation d'un parent avant d'aller en ligne | **IT** Chiedi il permesso ai tuoi genitori prima di andare online | **ES** Pídeles permiso a tus papás antes de conectarte a Internet | **PT** Pede autorização aos teus pais antes de ficares online | **ZH** 上网前应先征得父母的同意 | **PL** Poproś rodziców o zgodę, zanim wejdiesz do Internetu | **CS** Než půjdeš na internet, požádej rodiče o svolení | **SK** Skôr než pôjdeš na internet, vypýtaj si povolenie od rodičov | **HU** Kérj szülői engedélyt, mielőtt online csatlakoznál! | **UA** Запитуйте дозволу батьків, перш ніж користуватися інтернетом | **RO** Cere permisiunea părinților înainte de a te conecta online | **BG** Поискайте разрешение от родител, преди да влезете онлайн | **LV** Pirms došanās tiešsaistē palūdz atļauju vecākiem | **ET** Enne Interneti kasutamist küsi vanematelt luba | **LT** Prieš prisijungdami prie interneto, atsilaukite tėvų | **TR** İnternete girmeden önce anne babandan izin iste

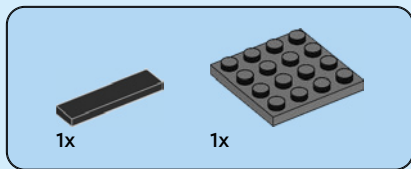

1

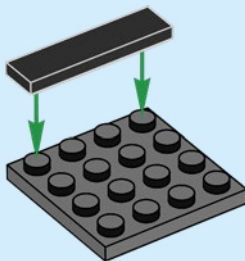

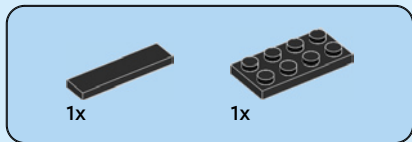

2

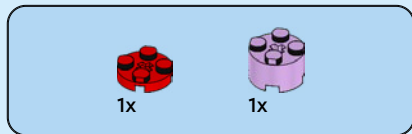
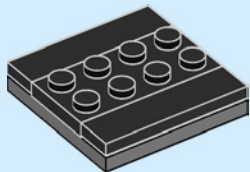

3

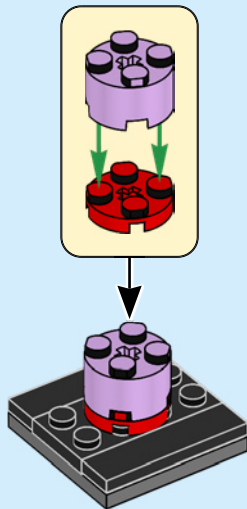



2x

4

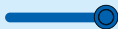
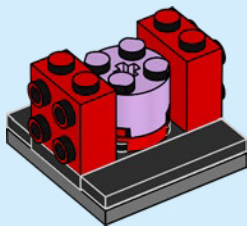

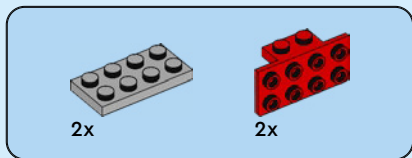

5

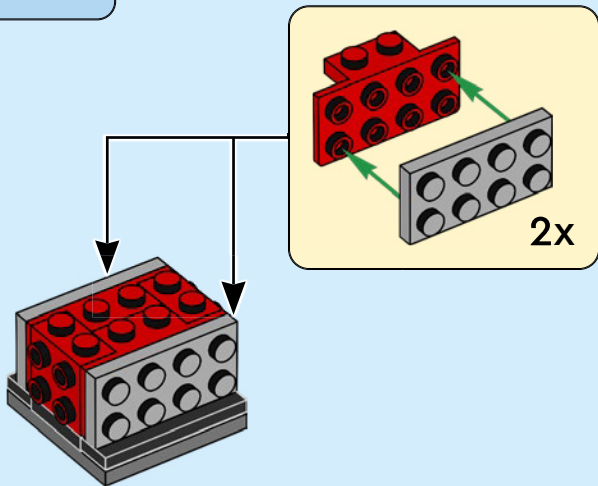



1x

6

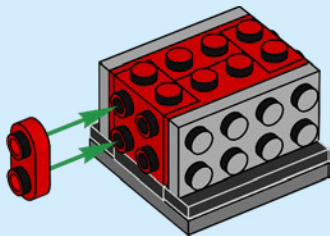

1x

7

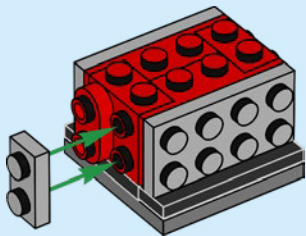



1x

8

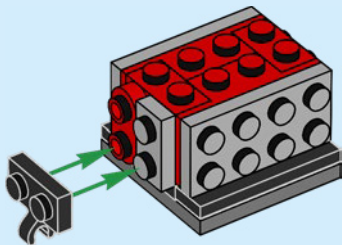

1x

9

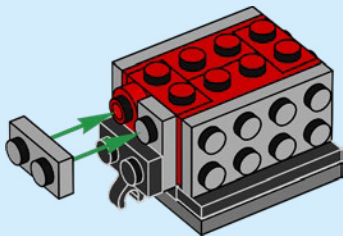



2x

10

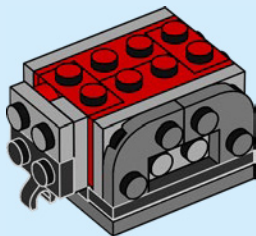

10



1x

11

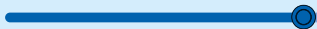
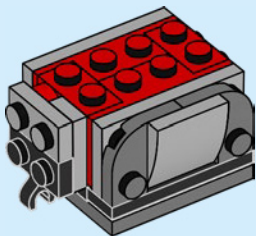



1x

12

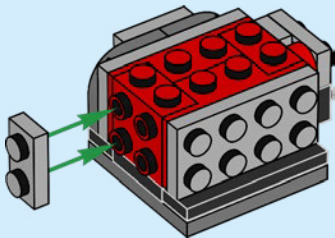

1x

13

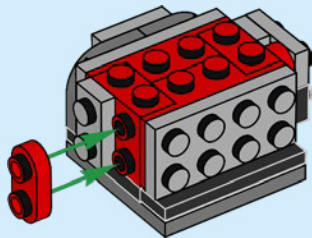



1x

14

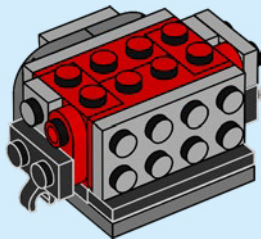

1x

15

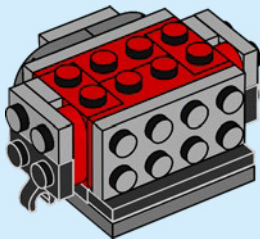



1x

16

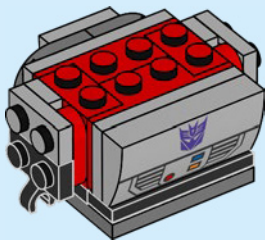

2x

17

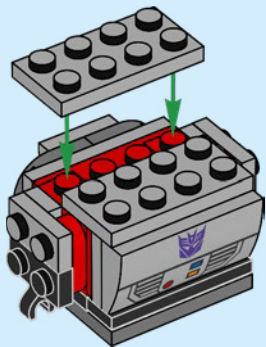



1x



1x

18

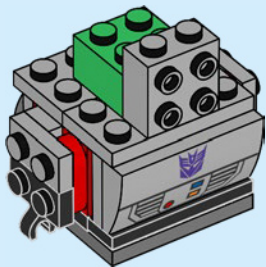

5x

19

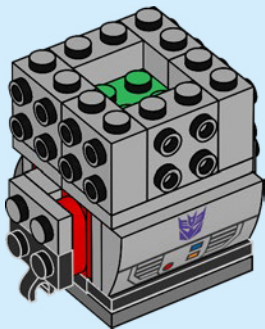



1x



1x



1x

20

1

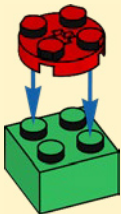

2

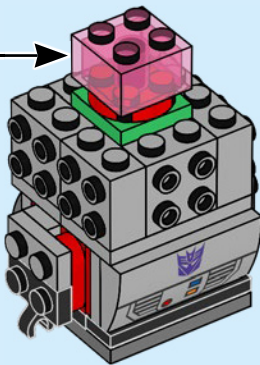



6x

21

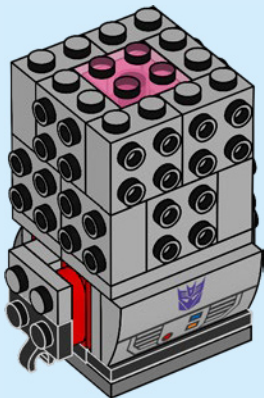



2x

22

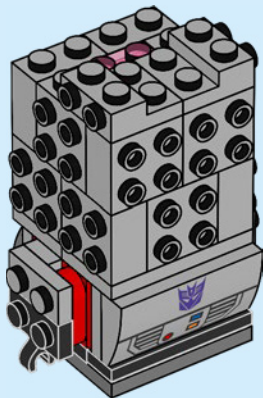

1x

23

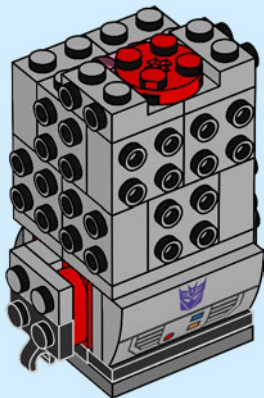

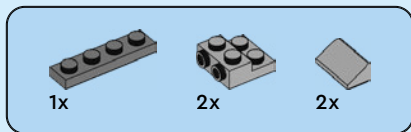

24

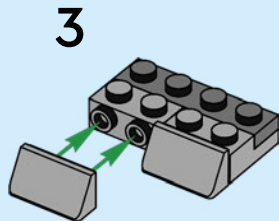
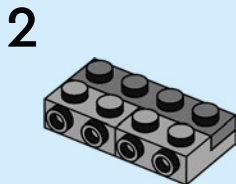
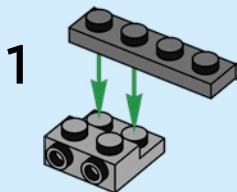

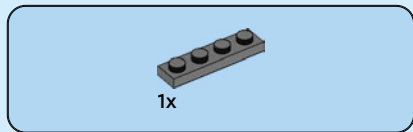
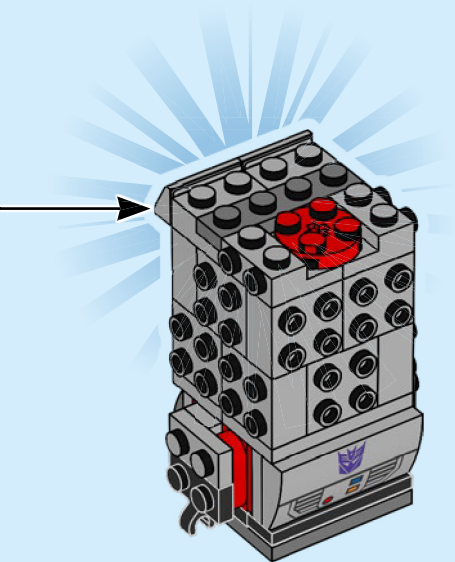

25

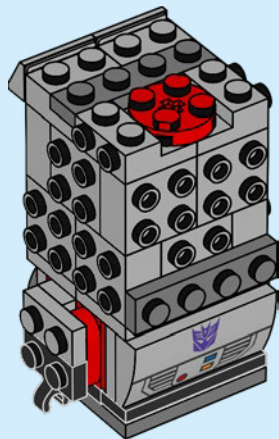

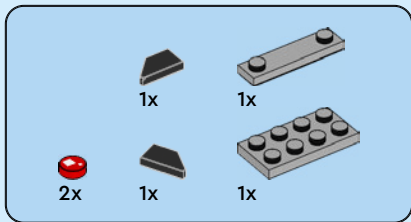

26

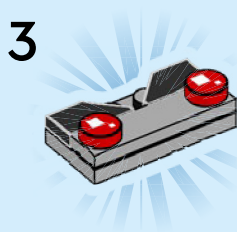
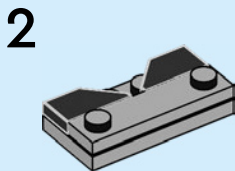
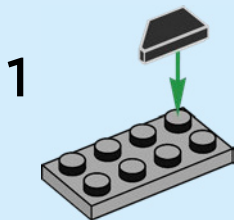

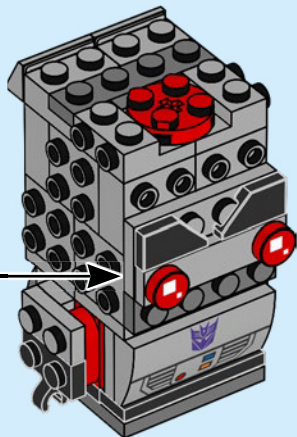



2x

27

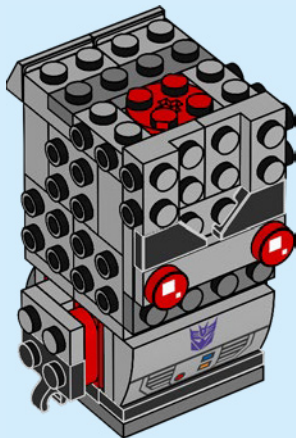

1x

28

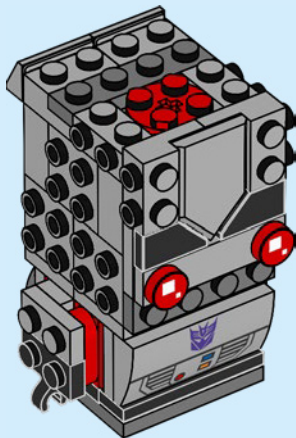

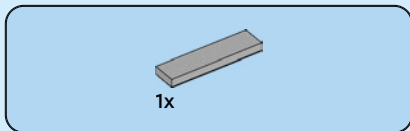

29

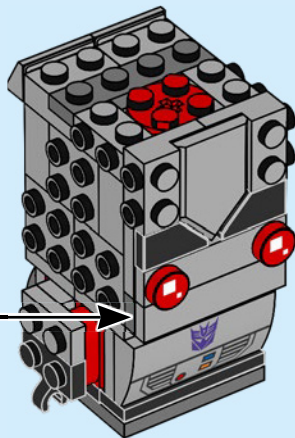
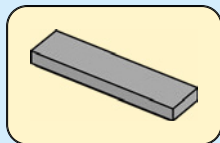

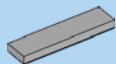

2x



2x

30

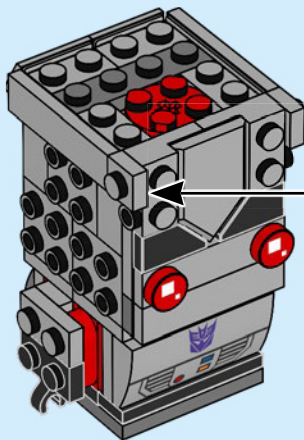

2x



1x



1x

31

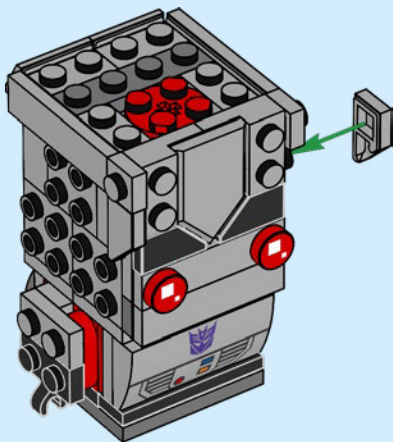

4x

32

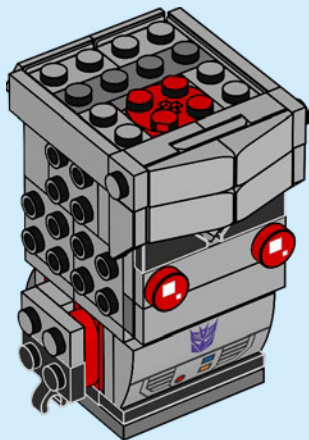



2x



4x



4x



8x



2x



2x

33

1

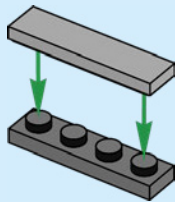

2

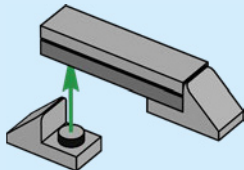

3

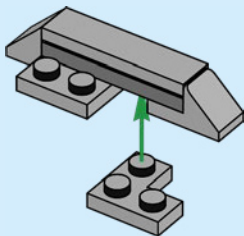

4

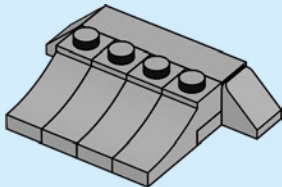

2x

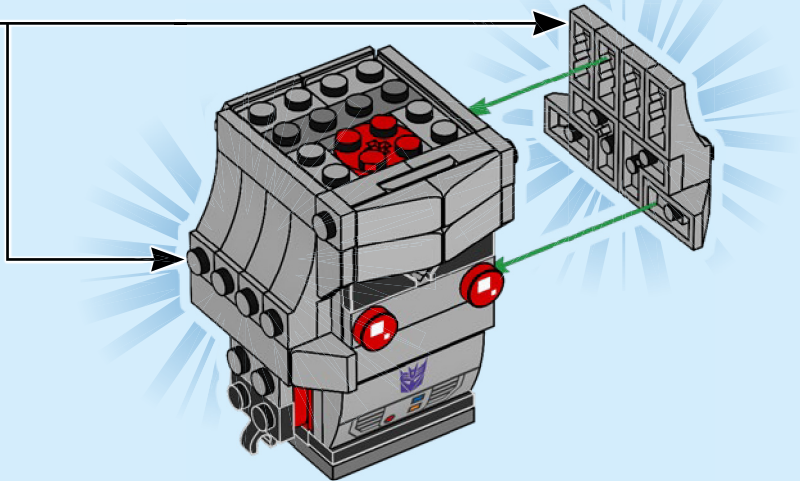



2x



3x



4x

34

1

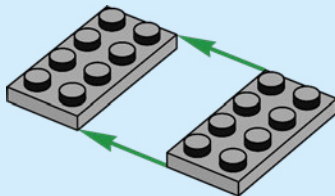

2

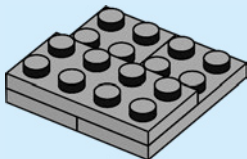

3

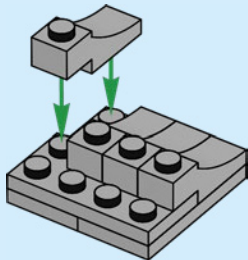

4

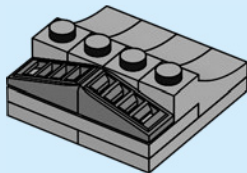

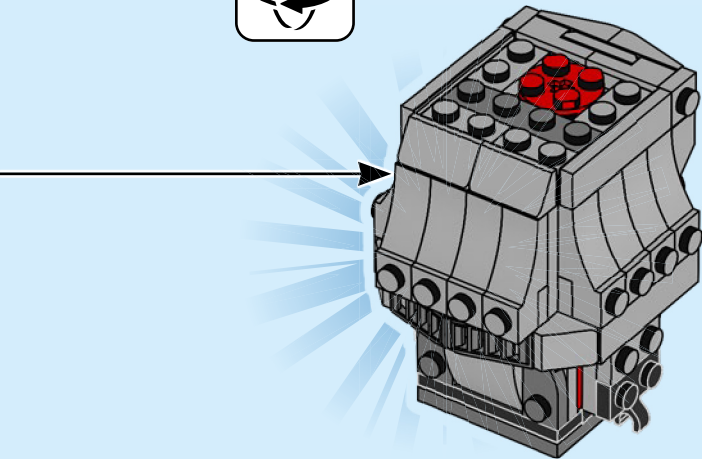



1x

35

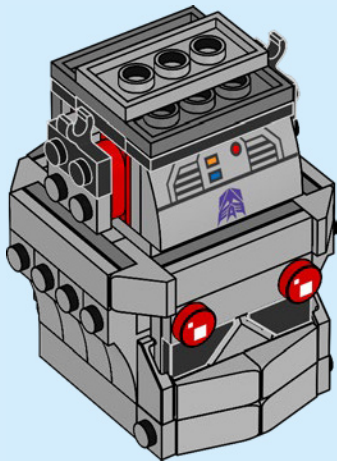



4x



2x

36

1

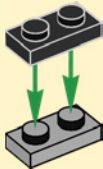

2

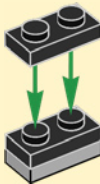

2x

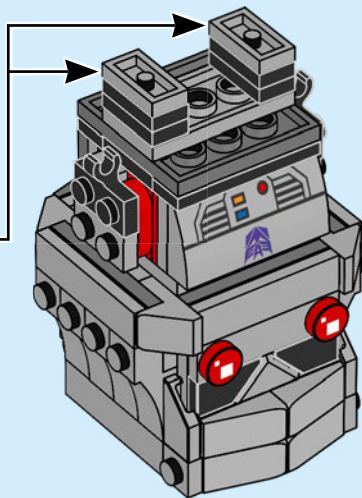

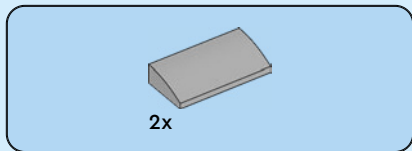

37

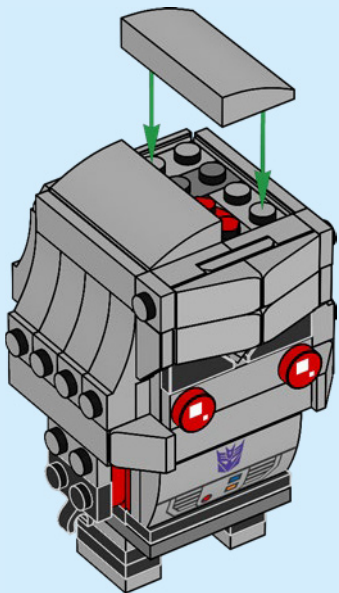



1x

38

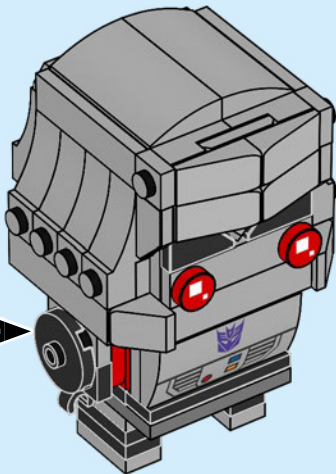

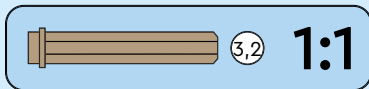
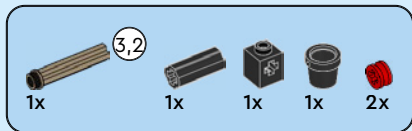

39

1

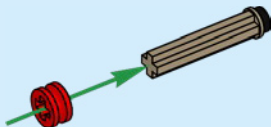

2

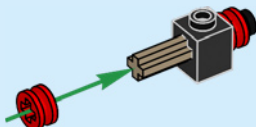

3

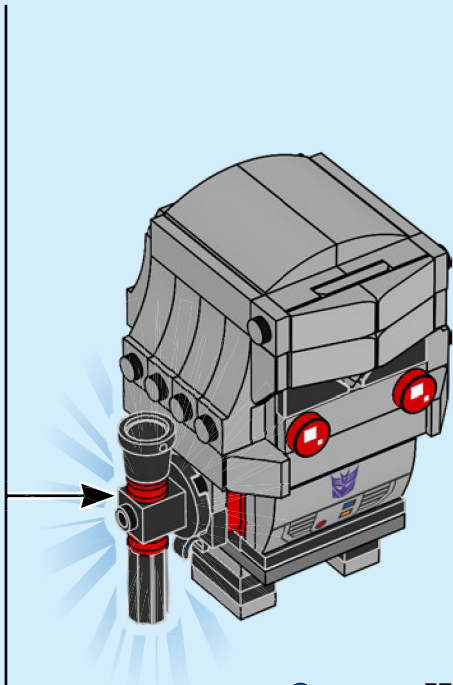
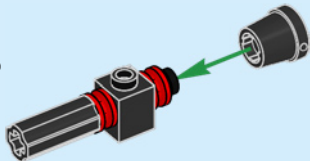

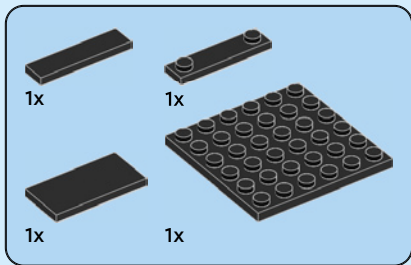

40

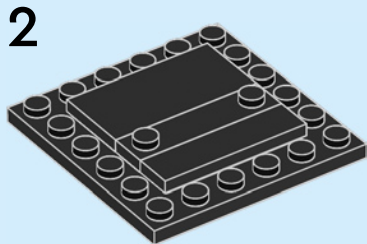
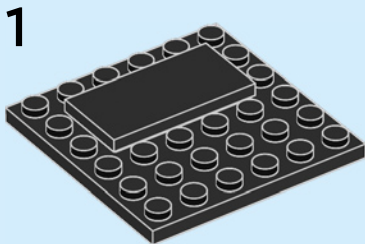

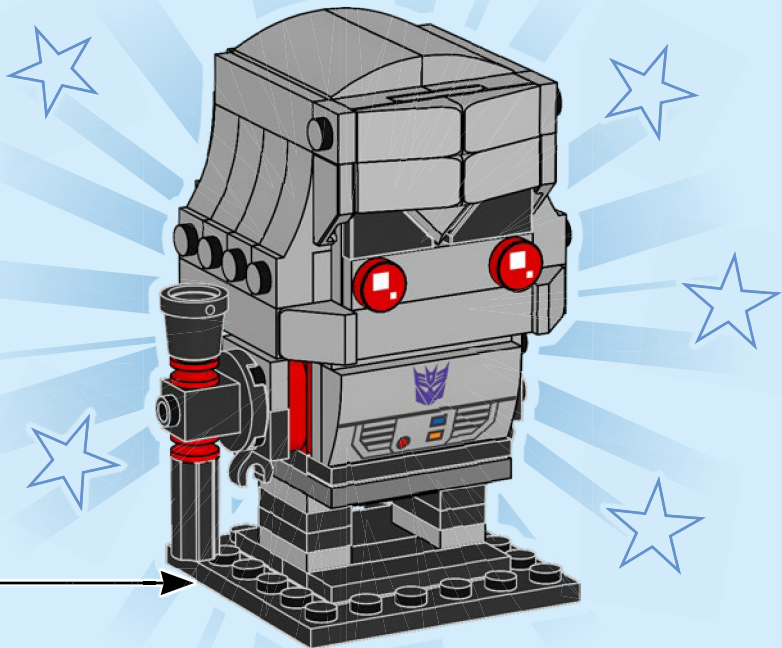



LEGO and the LEGO logo are trademarks of the/sont des marques de commerce du/
son marcas registradas de LEGO Group. ©2026 The LEGO Group.

TRANSFORMERS and HASBRO and all related trademarks and logos are trademarks of
Hasbro, Inc. ©2026 Hasbro.



6650669