



# BRICK HEADZ

40923



LEGO® Builder



### **Get excited about our new packaging!**

We're switching from plastic to paper-based packaging. That's why you might find a mix of paper and plastic in our boxes!

### **Nos nouveaux emballages vous emballeront !**

Nous passons des emballages en plastique aux emballages à base de papier. C'est pourquoi vous pourriez trouver un mélange de papier et de plastique dans nos boîtes !

### **¡Te presentamos nuestros nuevos empaques!**

Estamos sustituyendo las bolsas de plástico por bolsas con base de papel. ¡Por eso, puedes encontrar una mezcla de papel y de plástico en nuestras cajas!

**[LEGO.com/sustainable-packaging](https://www.lego.com/sustainable-packaging)**



LEGO® Builder

# BUILDER



Apple and the Apple logo are trademarks of Apple Inc., registered in the U.S. and other countries and regions. App Store is a service mark of Apple Inc. Google Play and the Google Play logo are trademarks of Google LLC. Tencent and the Tencent logo are trademarks of Tencent Inc.

**[LEGO.com/devicecheck](https://www.lego.com/devicecheck)**

**EN** Ask parents' permission before going online | **DE** Eltern um Erlaubnis bitten, bevor du online gehst | **FR** Demande l'autorisation d'un parent avant d'aller en ligne | **IT** Chiedi il permesso ai tuoi genitori prima di andare online | **ES** Pídeles permiso a tus papás antes de conectarte a Internet | **PT** Pede autorização aos teus pais antes de ficares online | **ZH** 上网前应先征得父母的同意 | **PL** Poproś rodziców o zgodę, zanim wejdiesz do Internetu | **CS** Než půjdeš na internet, požádej rodiče o svolení | **SK** Skôr než pôjdeš na internet, vypýtaj si povolenie od rodičov | **HU** Kérj szülői engedélyt, mielőtt online csatlakoznál! | **UA** Запитуйте дозволу батьків, перш ніж користуватися інтернетом | **RO** Cere permisiunea părinților înainte de a te conecta online | **BG** Поискайте разрешение от родител, преди да влезете онлайн | **LV** Pirms došanās tiešsaistē palūdz atļauju vecākiem | **ET** Enne Interneti kasutamist küsi vanematelt luba | **LT** Prieš prisijungdami prie interneto, atsiklauskite tėvų | **TR** İnternete girmeden önce anne babandan izin iste





1x



1x

1

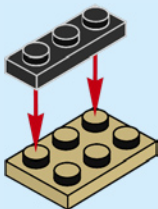

1x

2

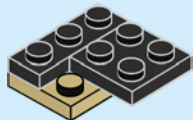



1x

3

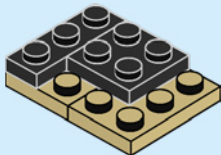

1x

4

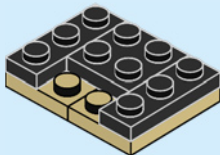



2x

5

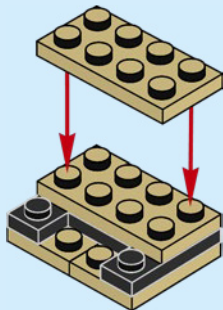

1x



2x

6

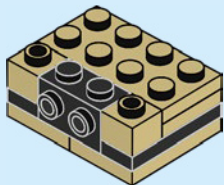



1x



1x

7

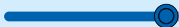
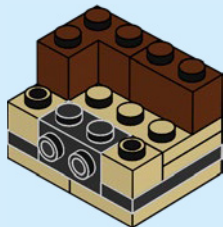



2x

8

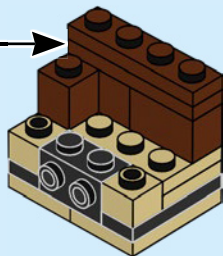
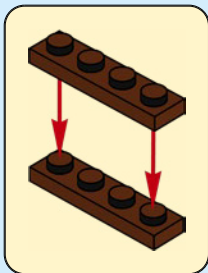



2x



1x

9

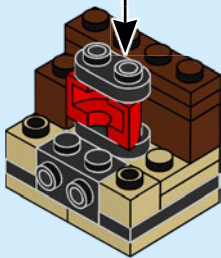
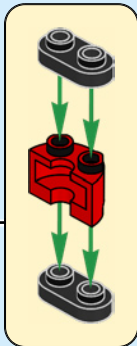



2x

10

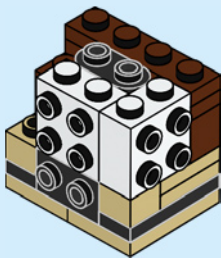

1x



1x

11

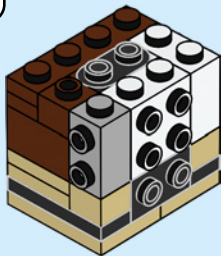

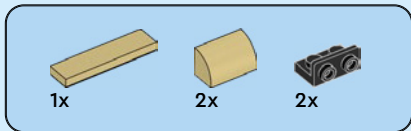

12

1

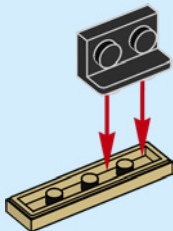

2

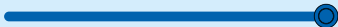
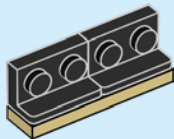

3

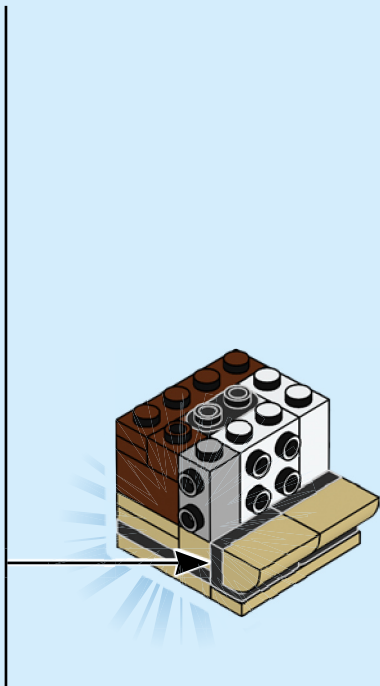
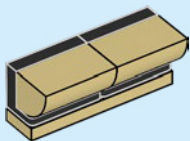

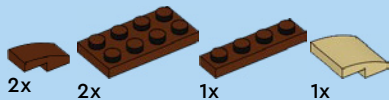

13

1

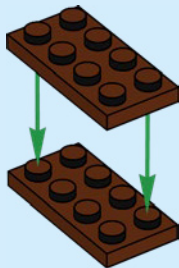

2

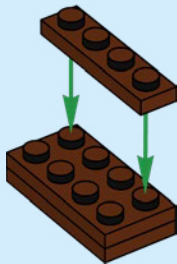

3

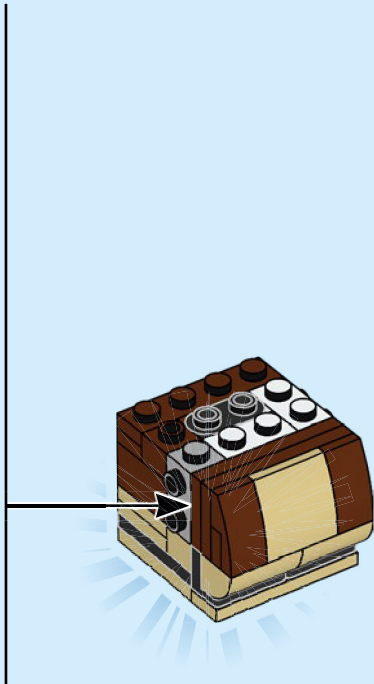



2x



2x



2x

14

1

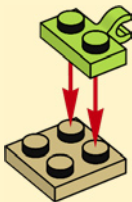

2

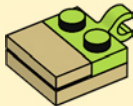

2x

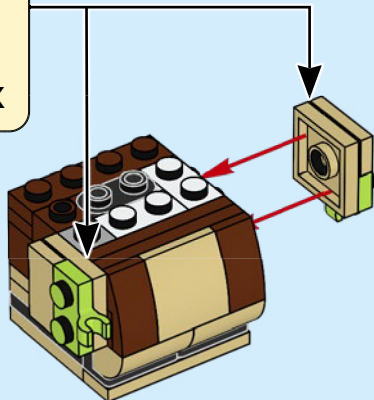

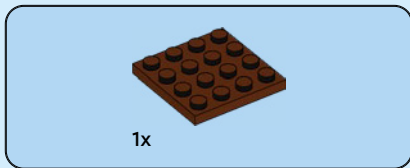

15

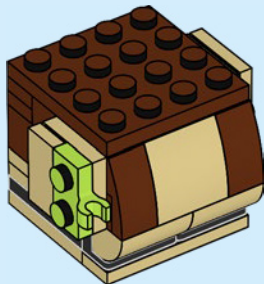



1x



2x

16

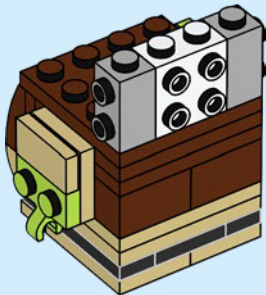



1x



2x

17

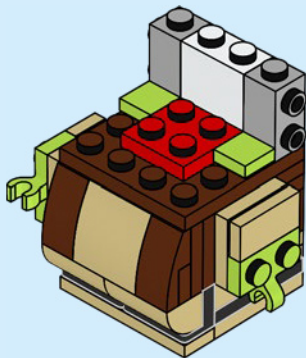



2x



2x

18



2x

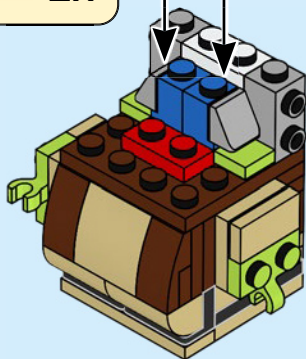



1x



2x

# 19

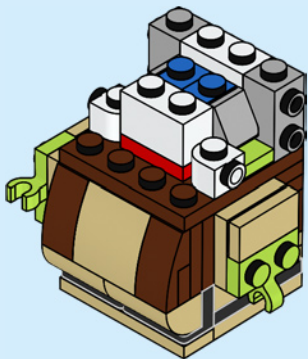

2x

# 20

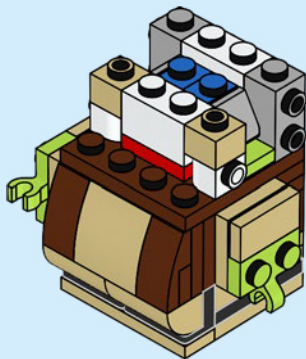



2x

21

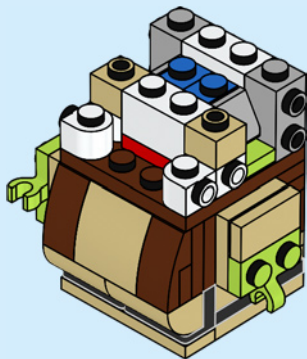

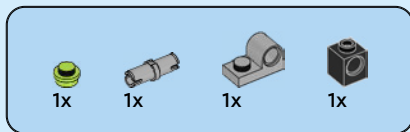

22

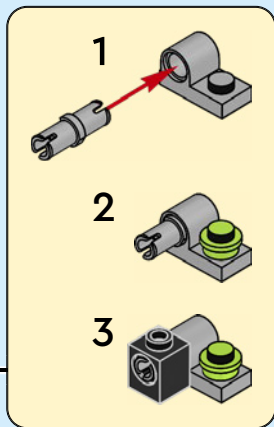
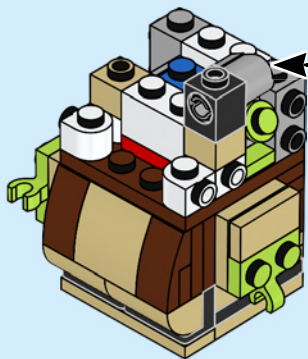

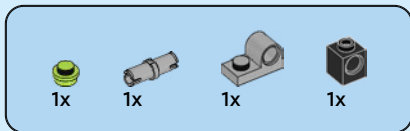

23

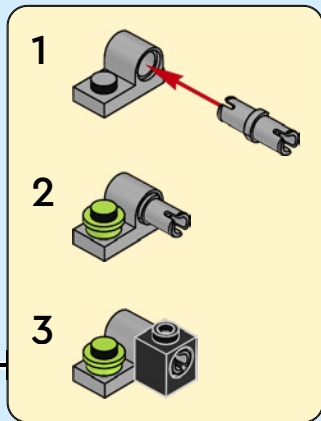
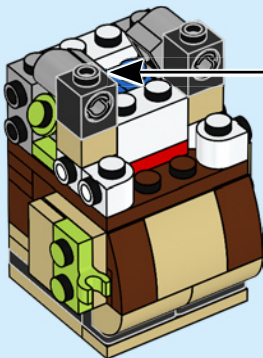
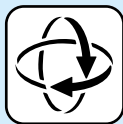



1x

24

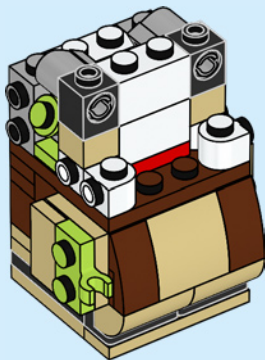



2x



1x

# 25

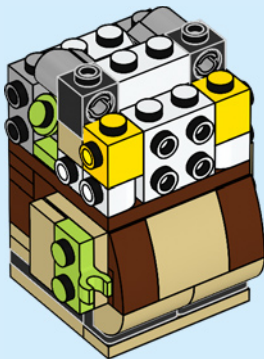



2x

26

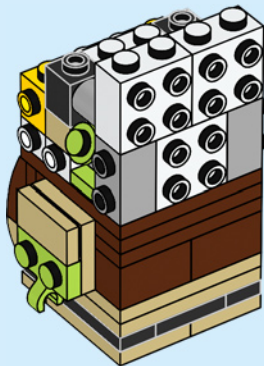
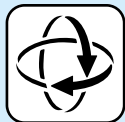



1x



2x

27

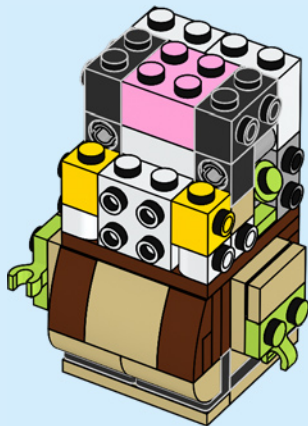
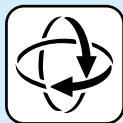



1x



2x

28

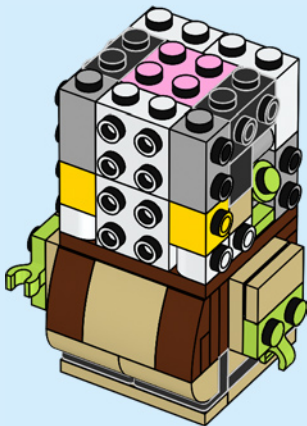

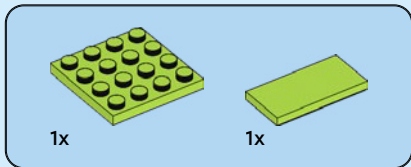

29

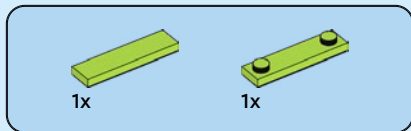
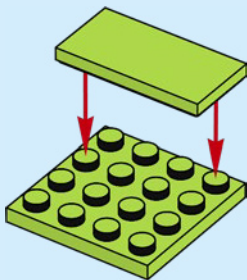

30

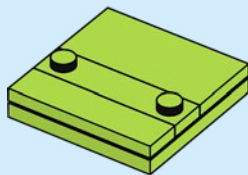



2x

31

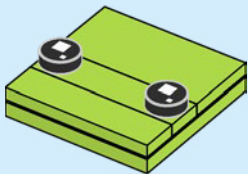

32

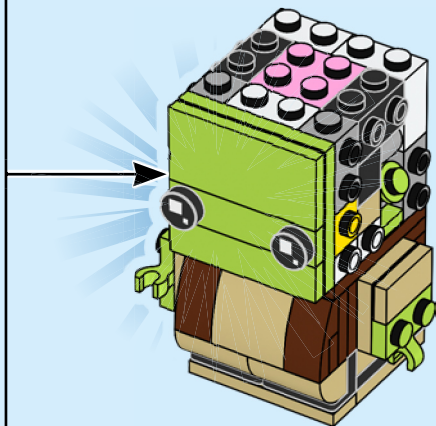



1x



1x

# 33

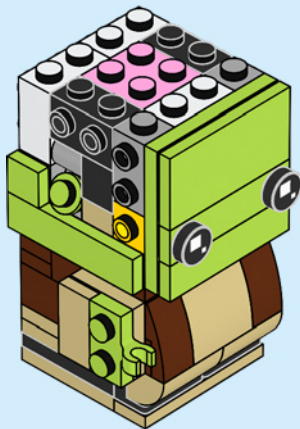



1x



1x

# 34

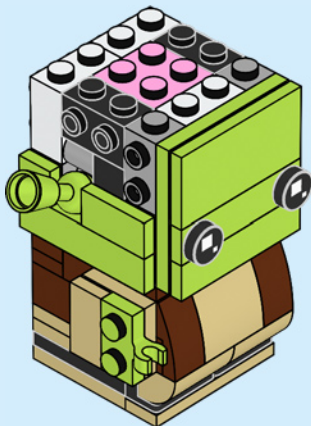

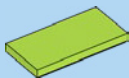

1x

35

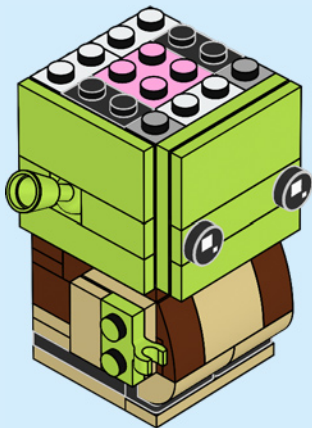

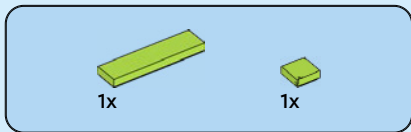

36

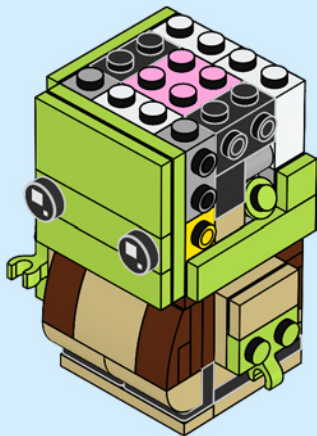



1x



1x

37

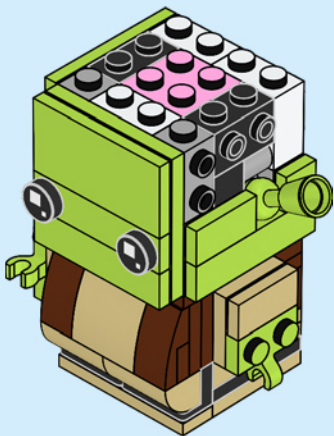

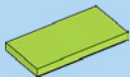

1x

38

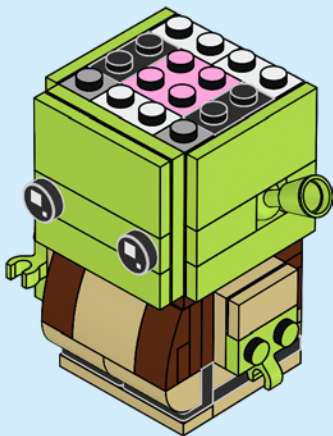

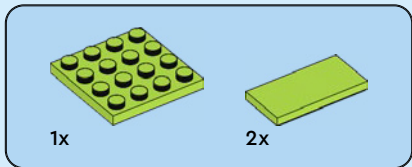

39

1

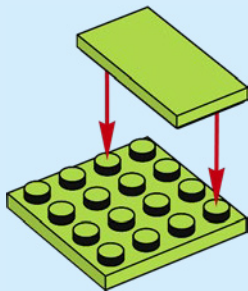

2

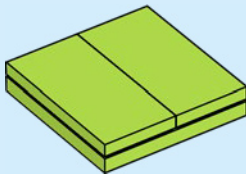

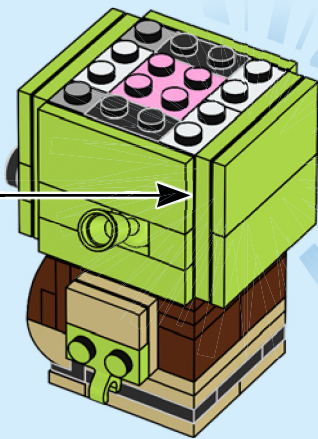

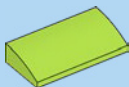

2x

40

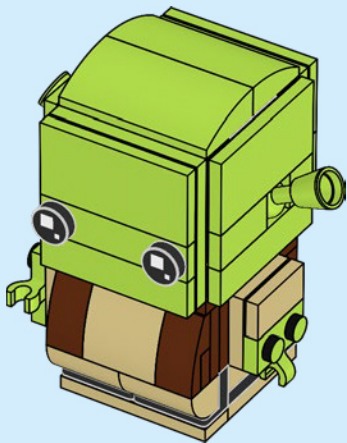



2x



2x

41



2x

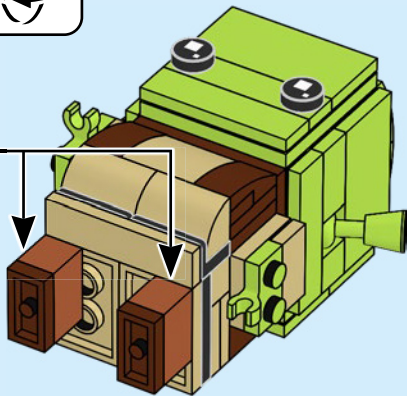

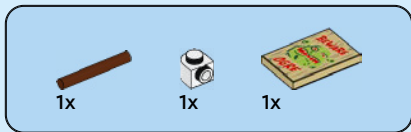

42

1

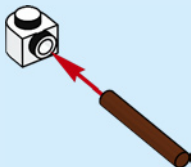

2



3

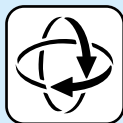

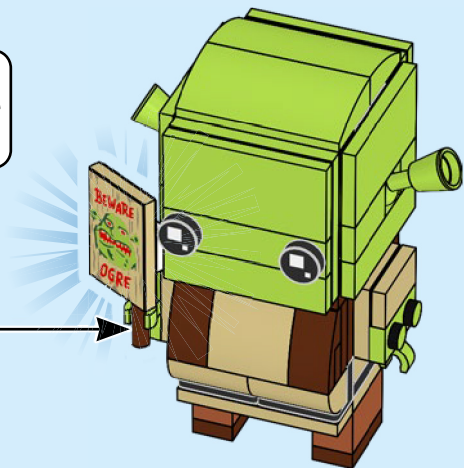
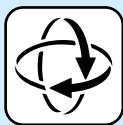

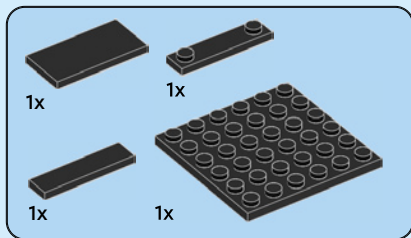

# 43

1

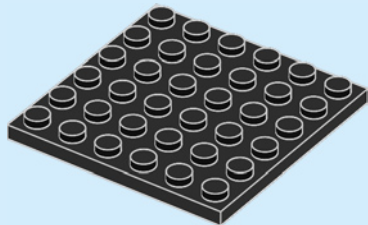

2

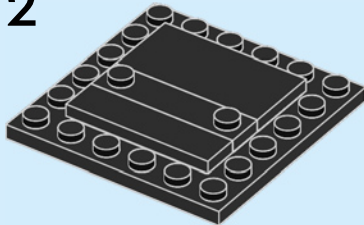

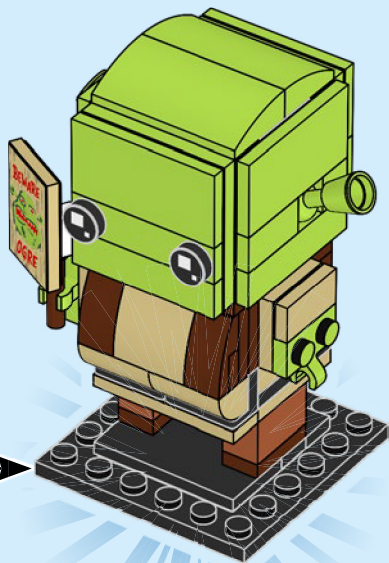

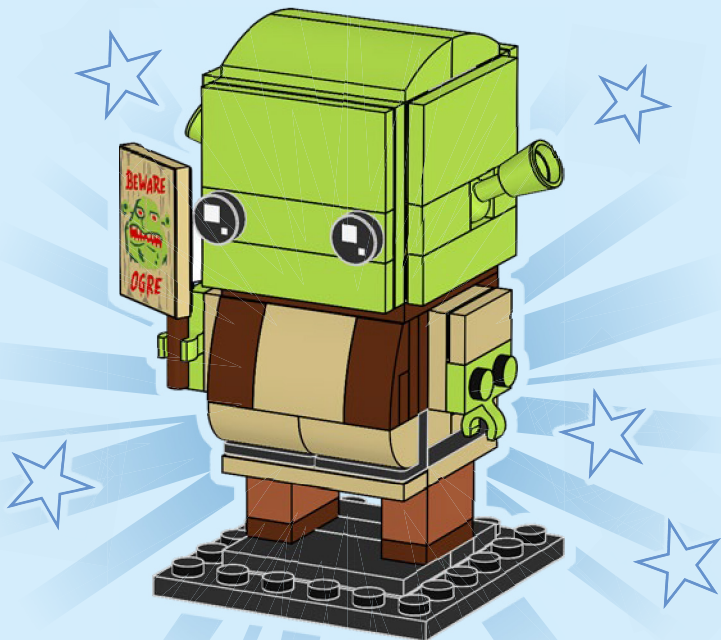



Rebuild  
the  
World 



LEGO and the LEGO logo are trademarks of the/son des marques de commerce du/  
son marcas registradas de LEGO Group. ©2026 The LEGO Group.

Dreamworks Shrek © DreamWorks Animation LLC. All Rights Reserved.



6650657