



FORTNITE®

77080



LEGO® Builder



Get excited about our new packaging!

We're switching from plastic to paper-based packaging. That's why you might find a mix of paper and plastic in our boxes!

Nos nouveaux emballages vous emballeront !

Nous passons des emballages en plastique aux emballages à base de papier. C'est pourquoi vous pourriez trouver un mélange de papier et de plastique dans nos boîtes !

¡Te presentamos nuestros nuevos empaques!

Estamos sustituyendo las bolsas de plástico por bolsas con base de papel. ¡Por eso, puedes encontrar una mezcla de papel y de plástico en nuestras cajas!

[LEGO.com/sustainable-packaging](https://www.lego.com/sustainable-packaging)

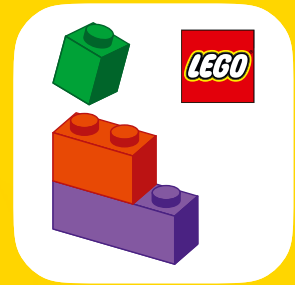

LEGO® Builder



BUILDER



Apple and the Apple logo are trademarks of Apple Inc., registered in the U.S. and other countries and regions. App Store is a service mark of Apple Inc. Google Play and the Google Play logo are trademarks of Google LLC. Tencent and the Tencent logo are trademarks of Tencent Inc.

LEGO.com/devicecheck

EN Ask parents' permission before going online | **DE** Eltern um Erlaubnis bitten, bevor du online gehst | **FR** Demande l'autorisation d'un parent avant d'aller en ligne | **IT** Chiedi il permesso ai tuoi genitori prima di andare online | **ES** Pídeles permiso a tus papás antes de conectarte a Internet | **PT** Pede autorização aos teus pais antes de ficares online | **ZH** 上网前应先征得父母的同意 | **PL** Poproś rodziców o zgodę, zanim wejdiesz do Internetu | **CS** Než půjdeš na internet, požádej rodiče o svolení | **SK** Skôr než pôjdeš na internet, vypýtaj si povolenie od rodičov | **HU** Kérj szülői engedélyt, mielőtt online csatlakoznál! | **UA** Запитуйте дозволу батьків, перш ніж користуватися інтернетом | **RO** Cere permisiunea părinților înainte de a te conecta online | **BG** Поискайте разрешение от родител, преди да влезете онлайн | **LV** Pirms došanās tiešsaistē palūdz atļauju vecākiem | **ET** Enne Interneti kasutamist küsi vanematelt luba | **LT** Prieš prisijungdami prie interneto, atsiklauskite tėvų | **TR** İnternete girmeden önce anne babadan izin iste



FORTNITE®

**REDEEM YOUR BONUS
IN-GAME DECOR PACK!**

**RÉCLAMEZ VOTRE
LOT D'OBJETS
DE DÉCORATION
EN PRIME DANS
LE JEU!**

1 Scan the QR code
and follow the steps



1 Balaie le code QR
et suis les étapes

**¡CANJEA TU PACK
DE DECORACIÓN
DE REGALO PARA
EL JUEGO!**

1 Escanea el código QR
y sigue los pasos

**Ask parents' permission
before going online**

Terms and Conditions apply



**2 Sign in/up and claim
your code to redeem**



**2 Connectez-vous ou
inscrivez-vous et utilisez votre
code pour recevoir votre prime**

**▶ Demande l'autorisation d'un
parent avant d'aller en ligne**

Des conditions s'appliquent

**2 Inicia sesión/regístrate para
recibir tu código y canjearlo**

**▶ Pídeles permiso a tus papás
antes de conectarte a
Internet**

Se aplican Términos y Condiciones

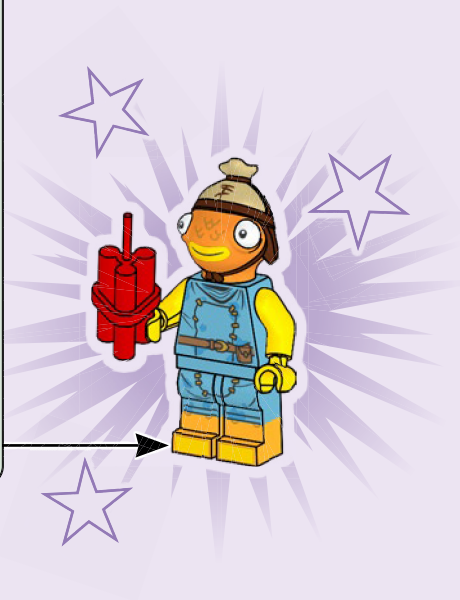
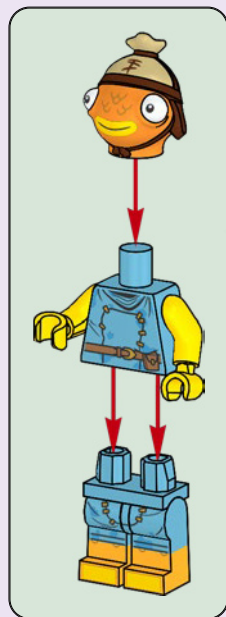
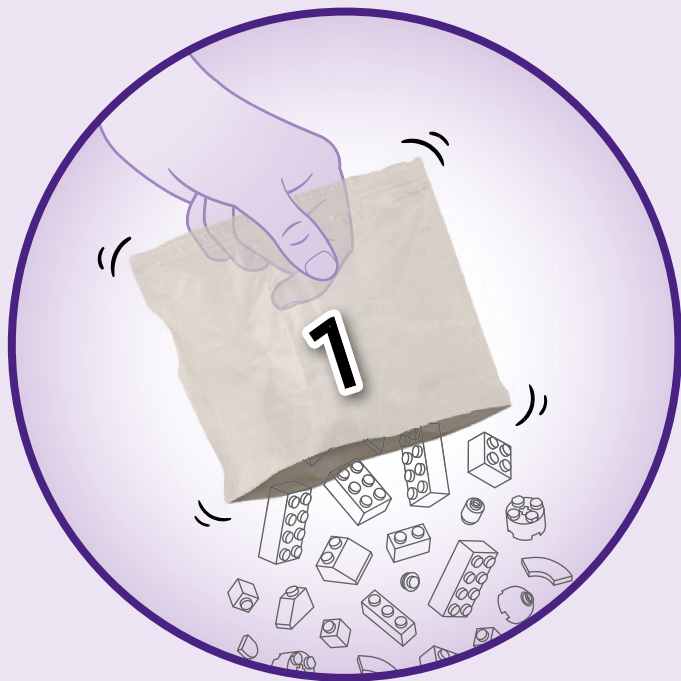

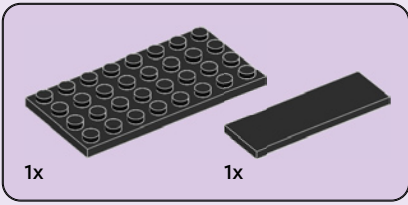

1

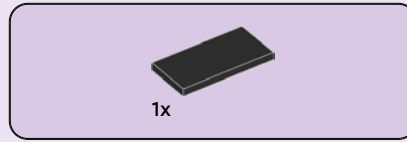
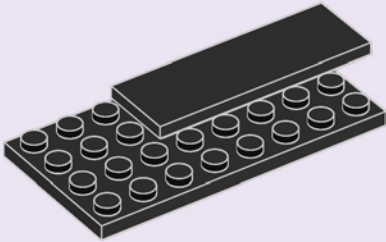

2

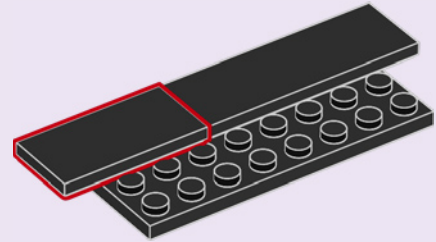

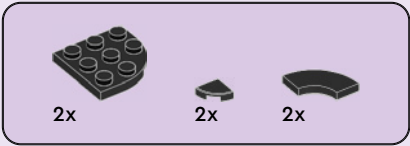

3

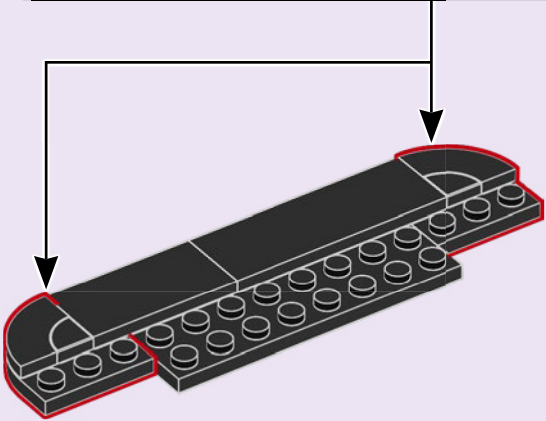
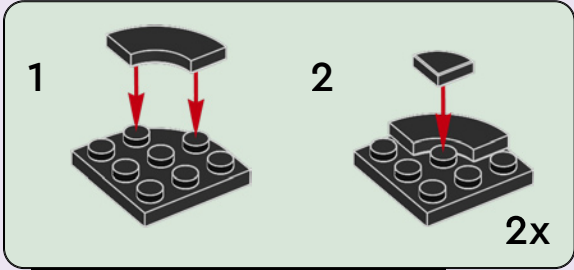

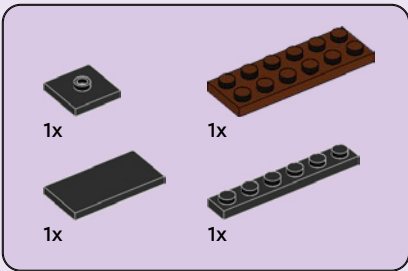

4

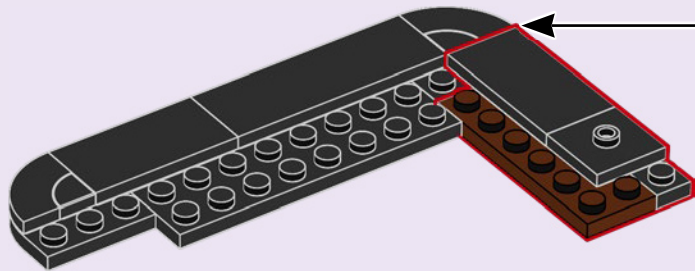
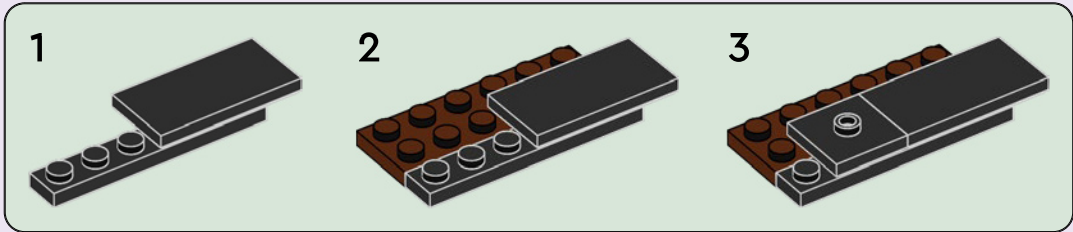

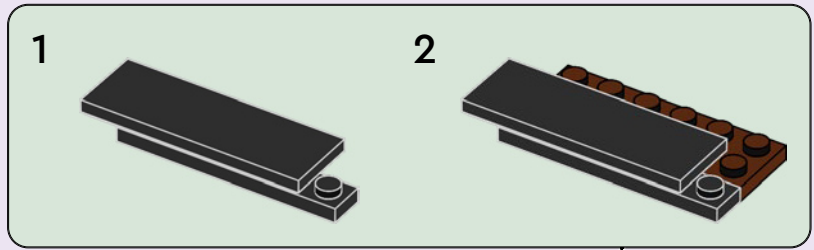
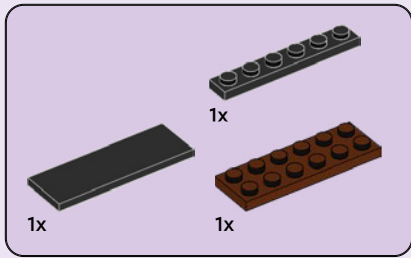

5

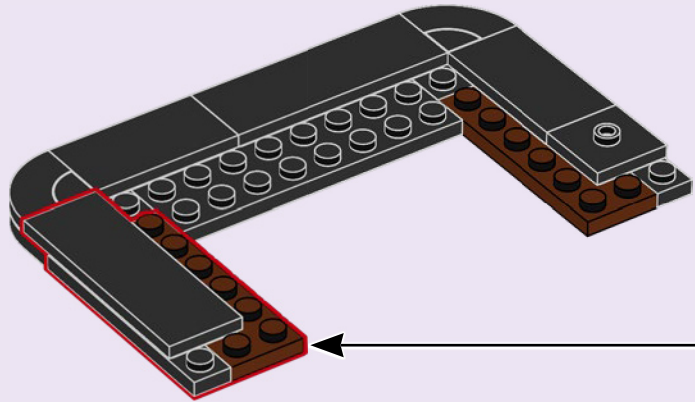



2x

6

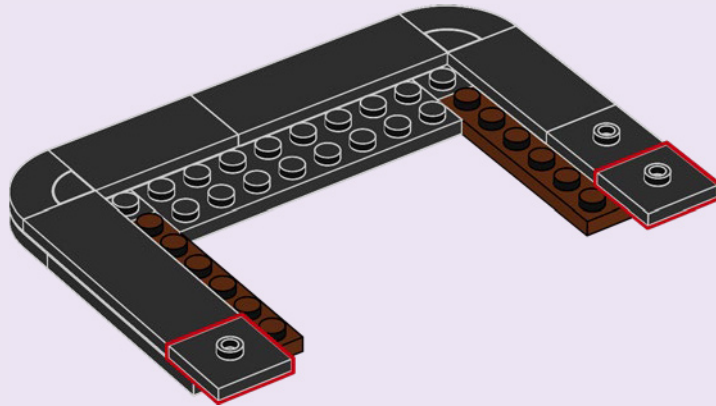

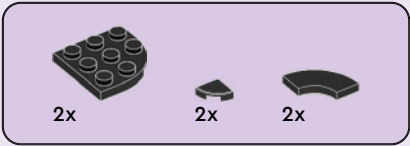

7

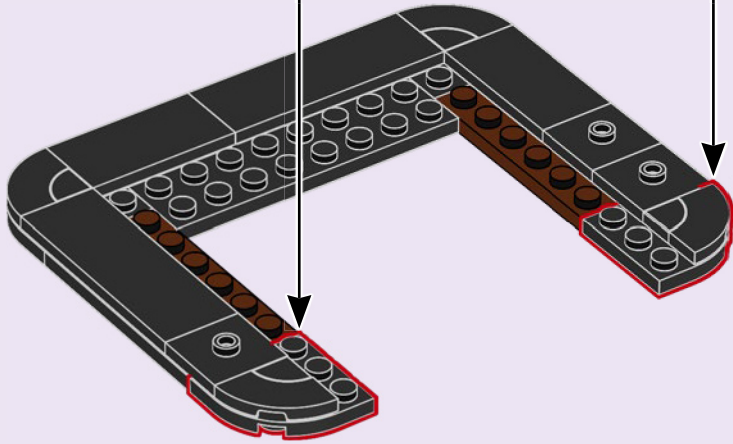
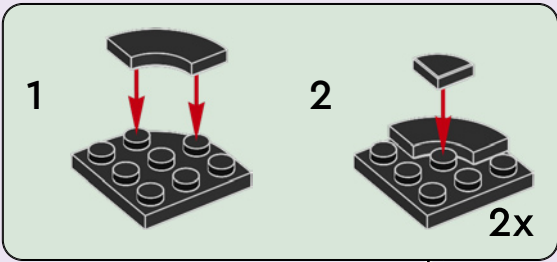

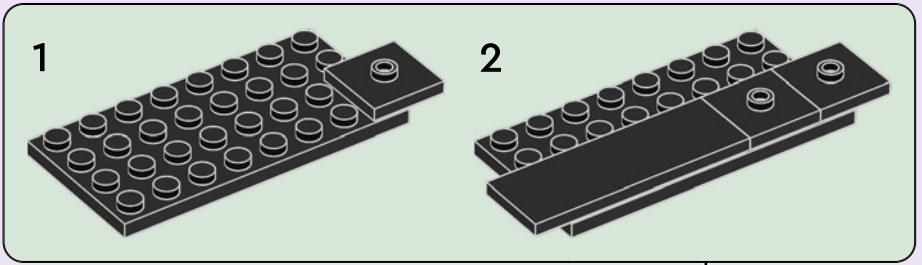
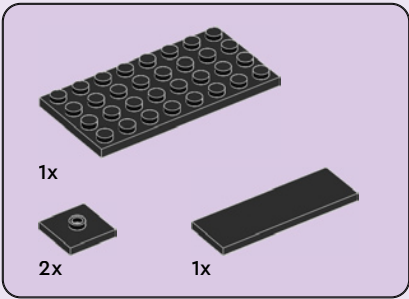

8

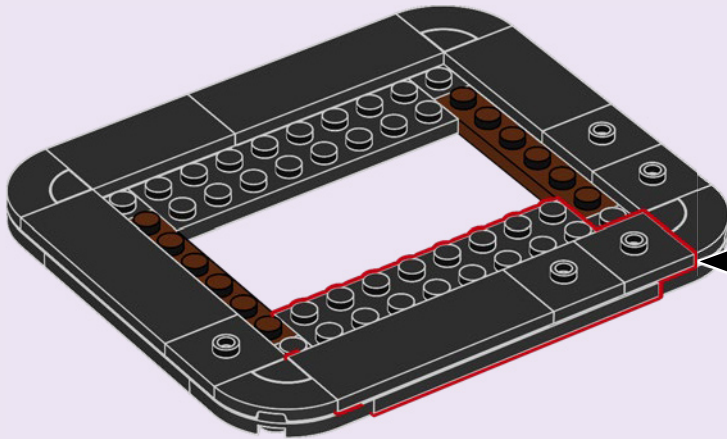

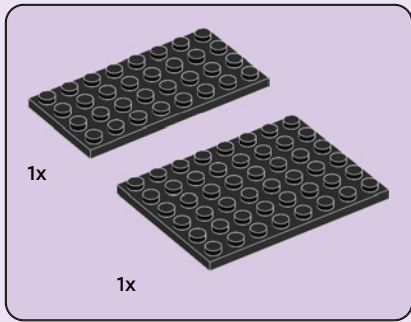

9

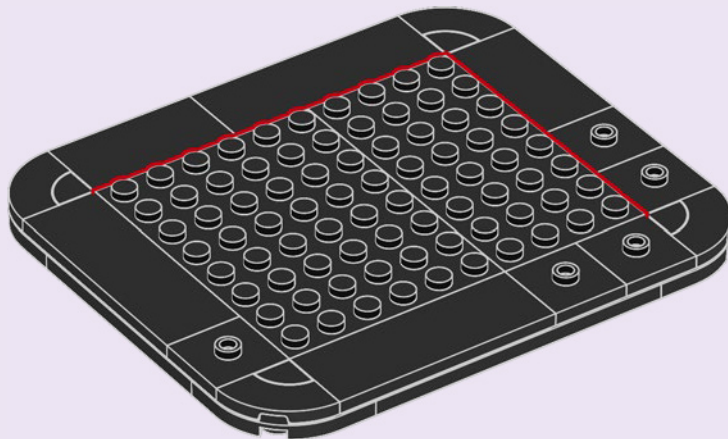

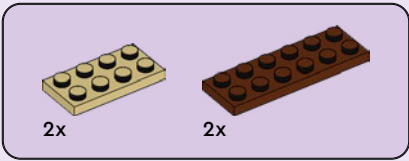

10

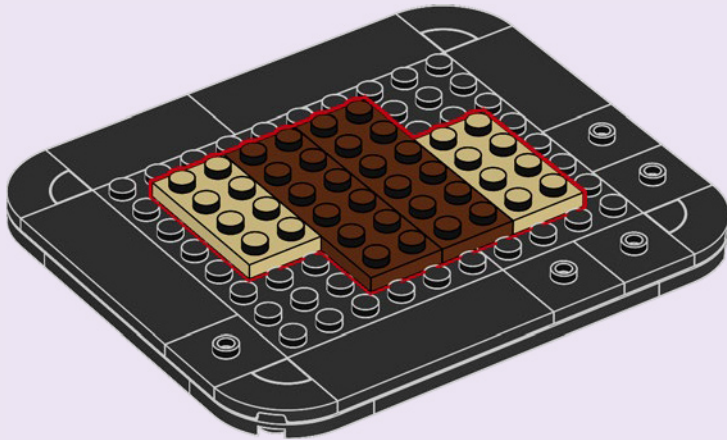

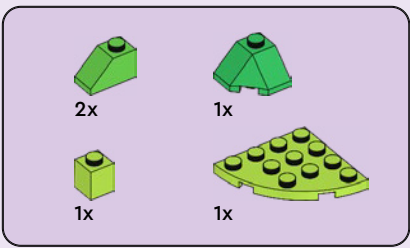

11

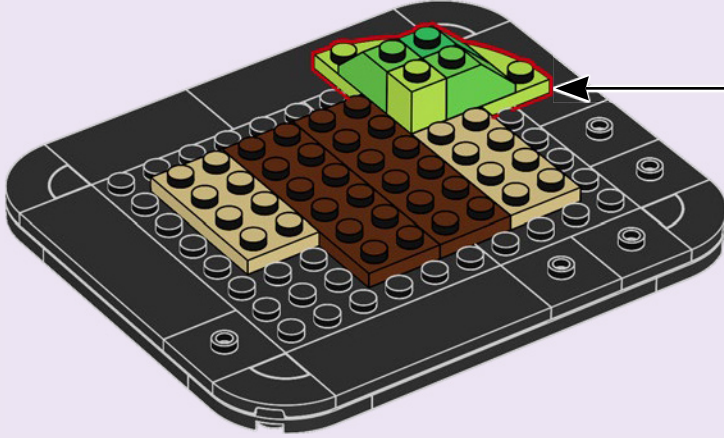
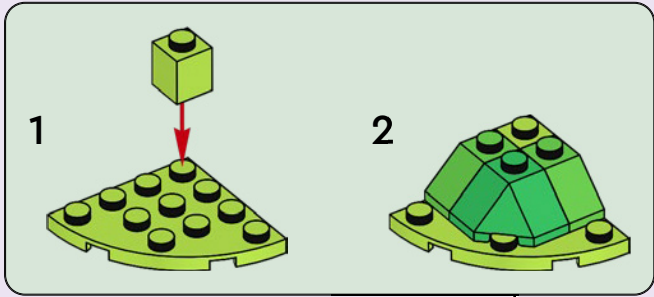

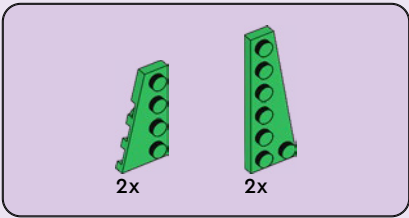

12

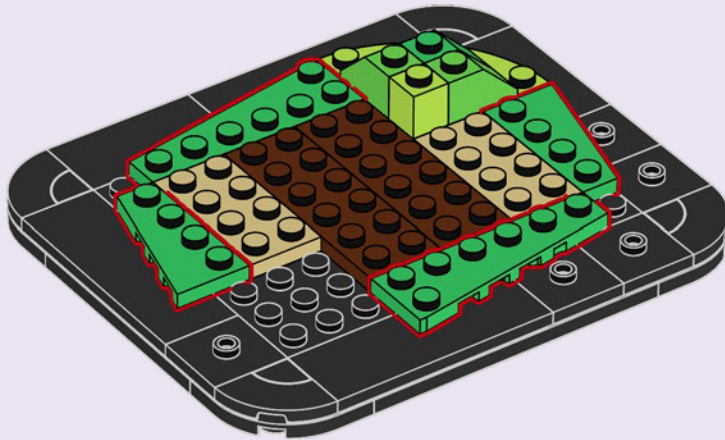



2x

13

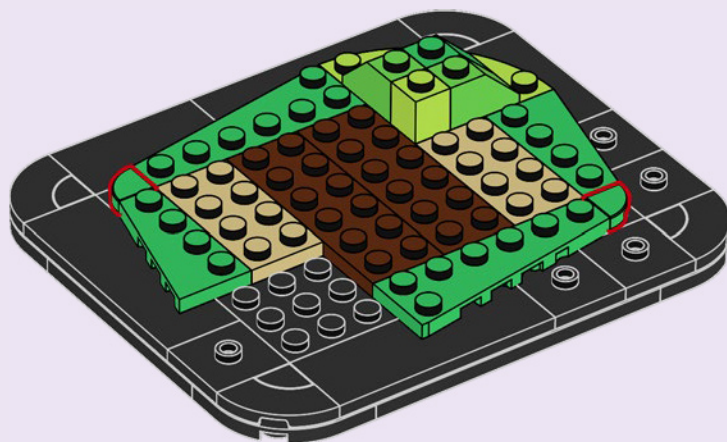



1x

14

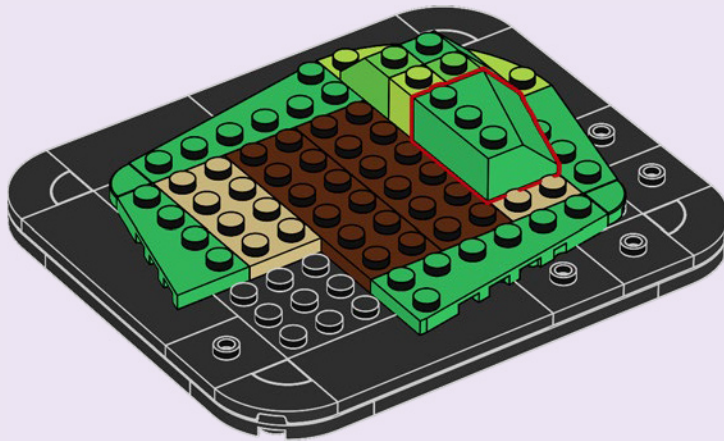

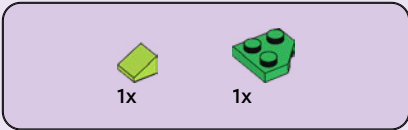

15

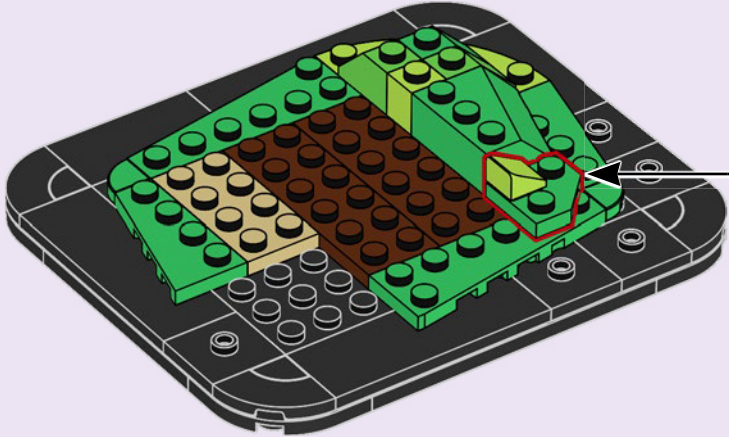
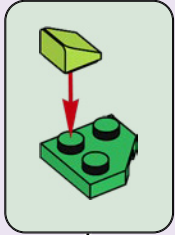

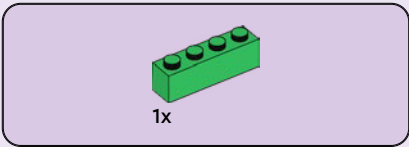

16

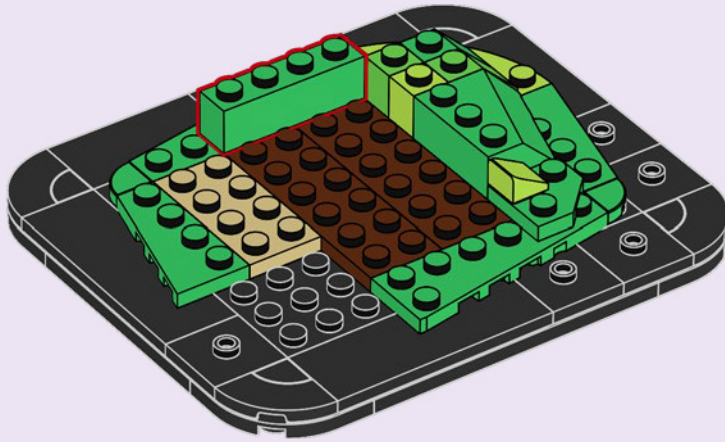



1x

17

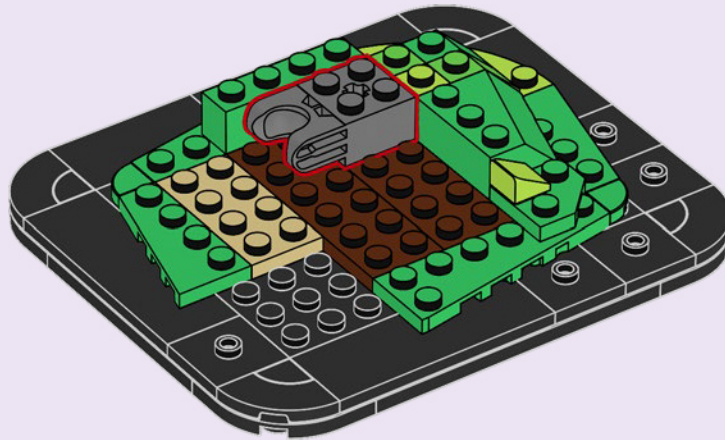

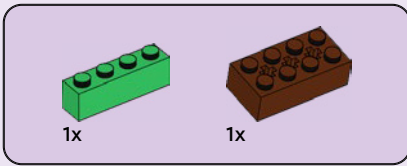

18

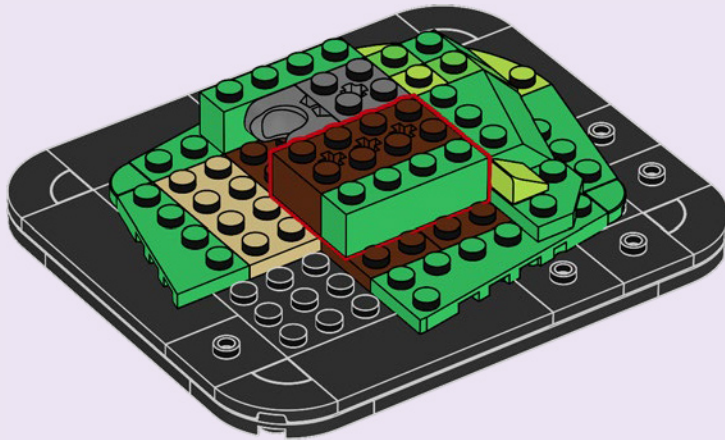

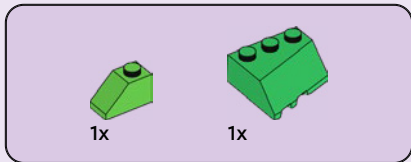

19

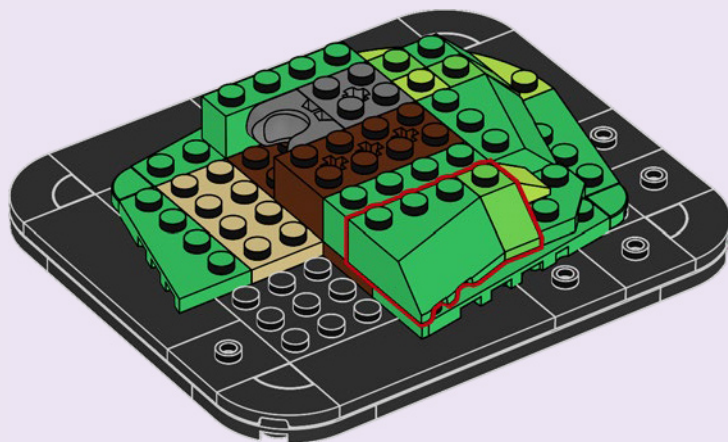

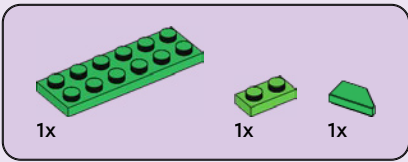

20

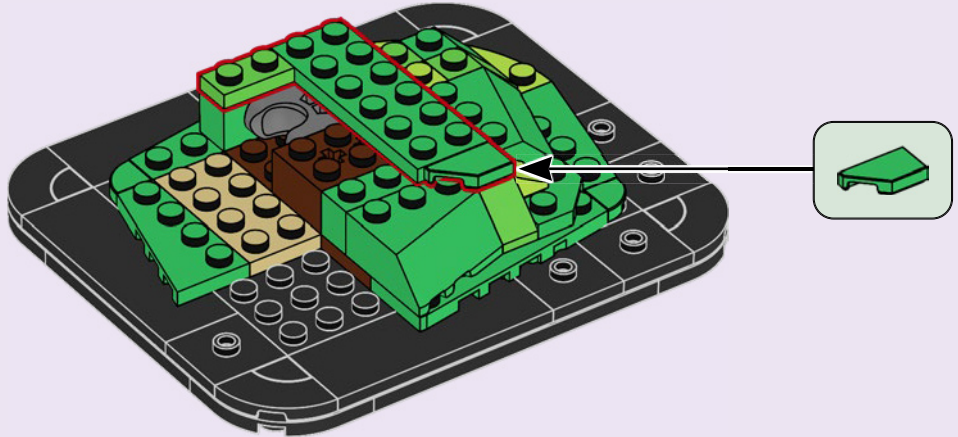

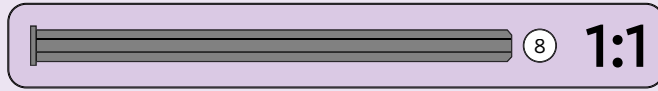
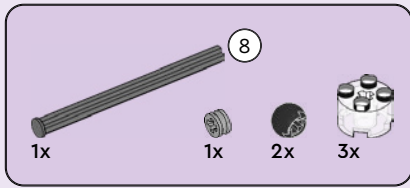

21

1

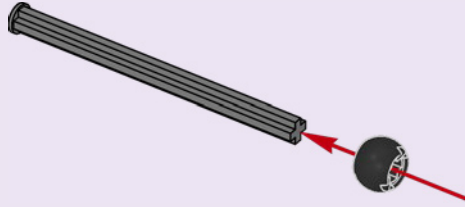

2

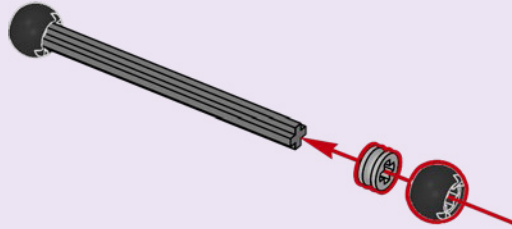

3

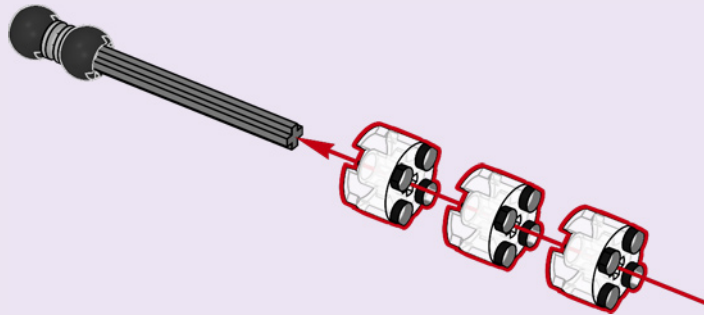

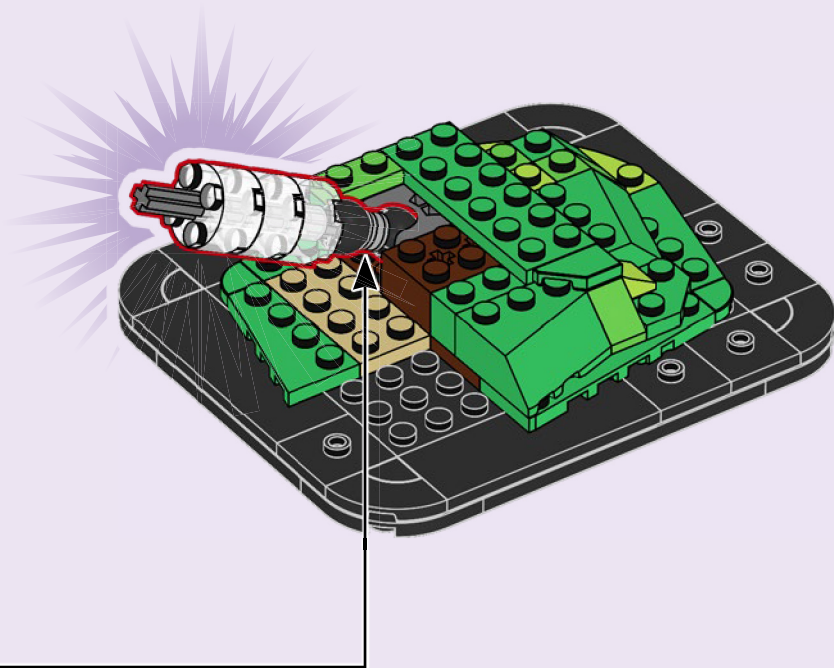

22

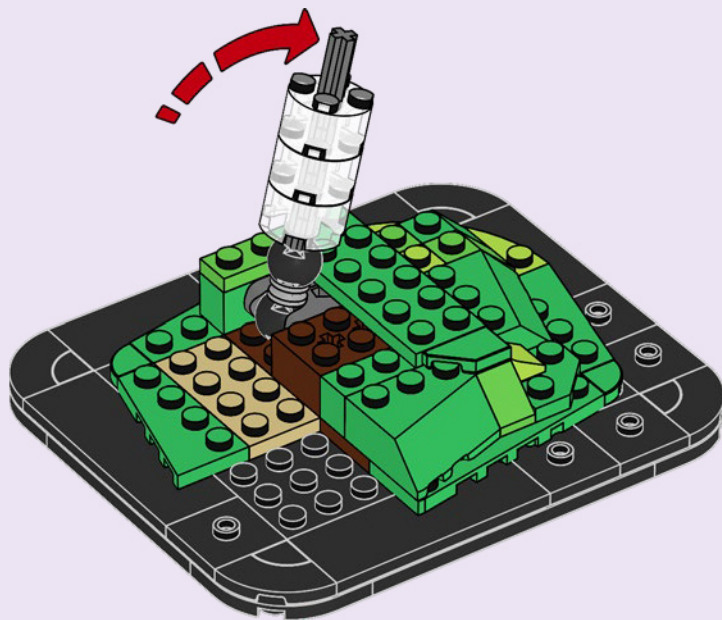

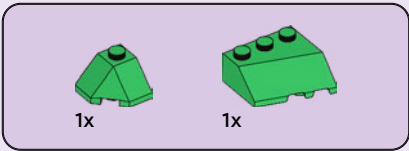

23

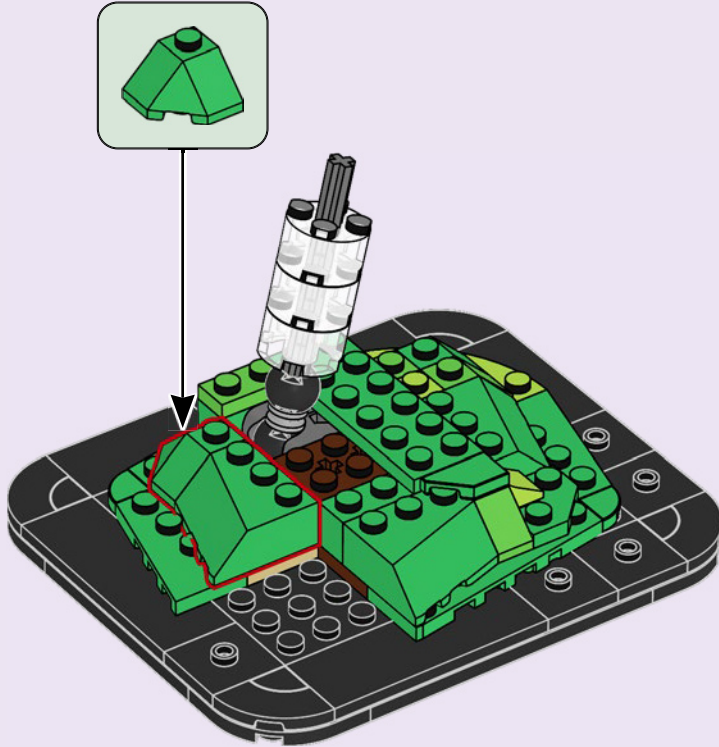

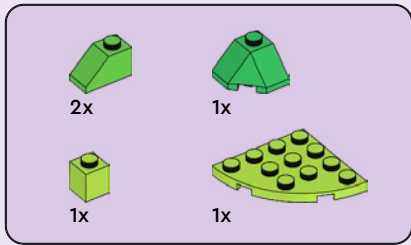

24

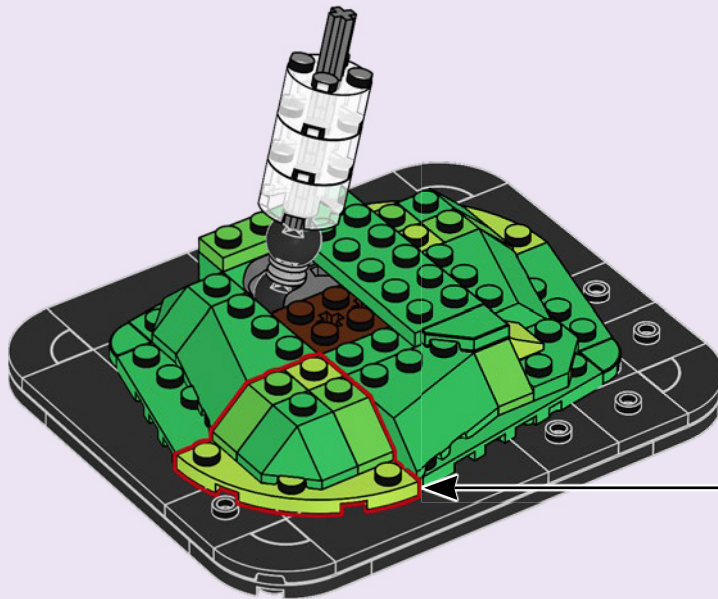
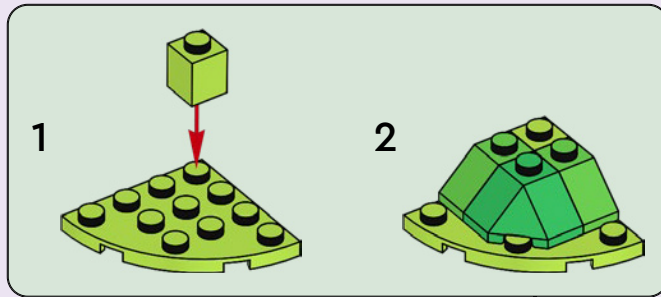



1x



1x

25

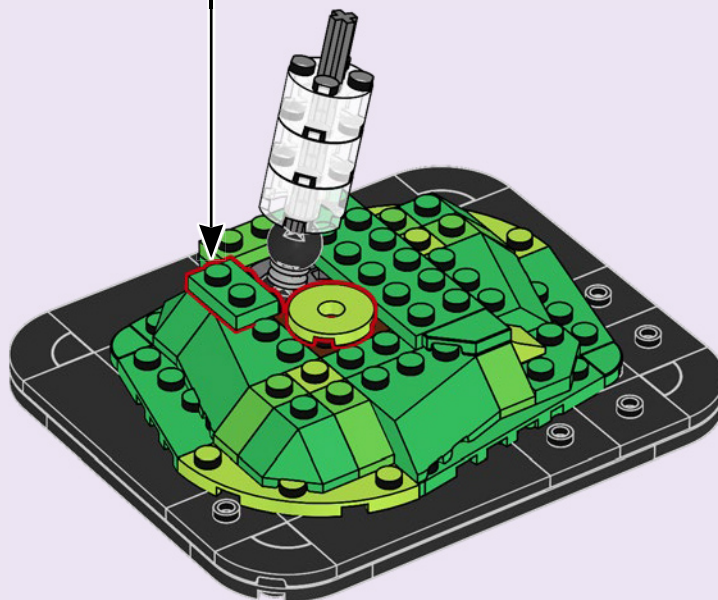
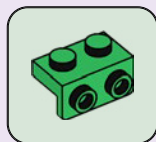



1x



2x

26

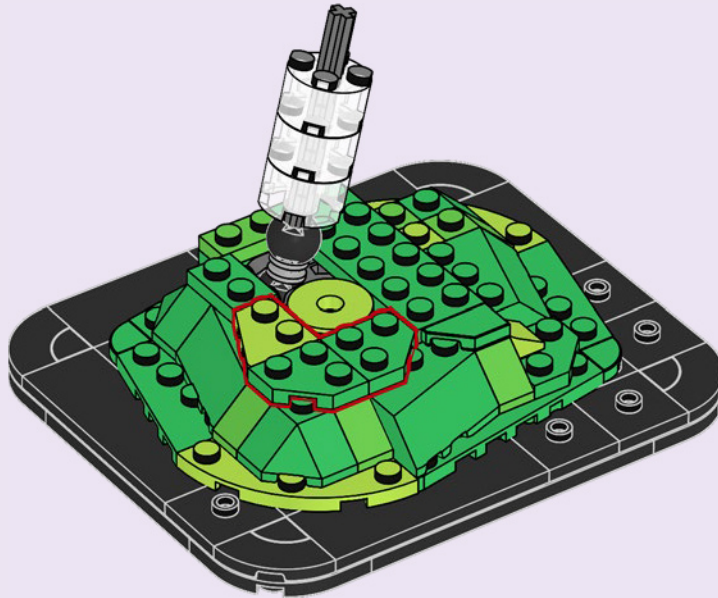

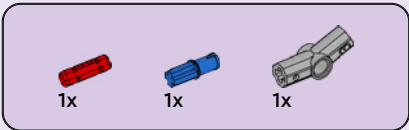

27

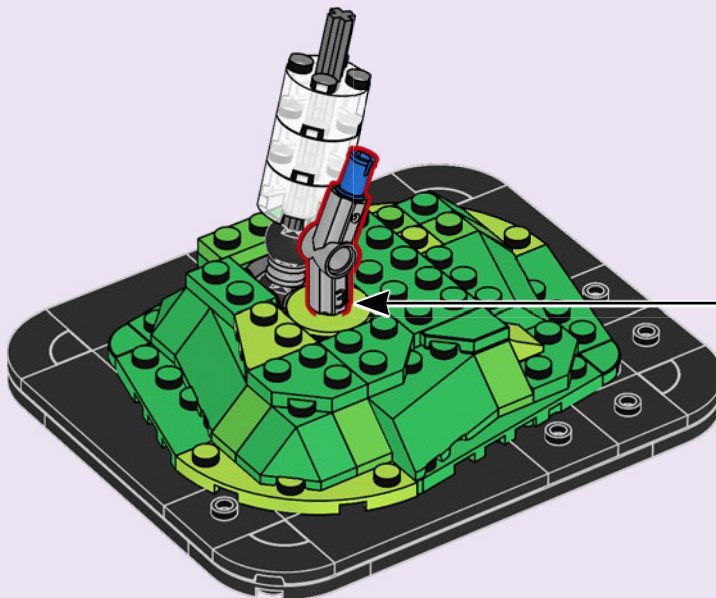
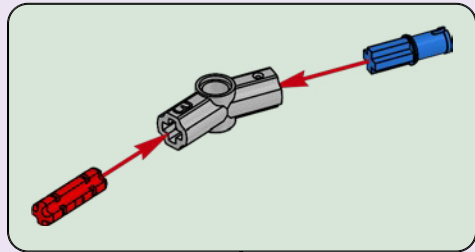



1x

28

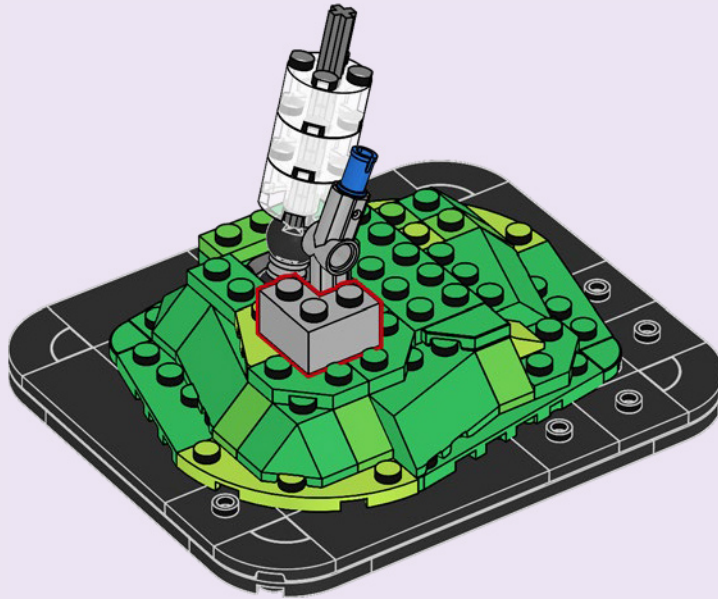



3x

29

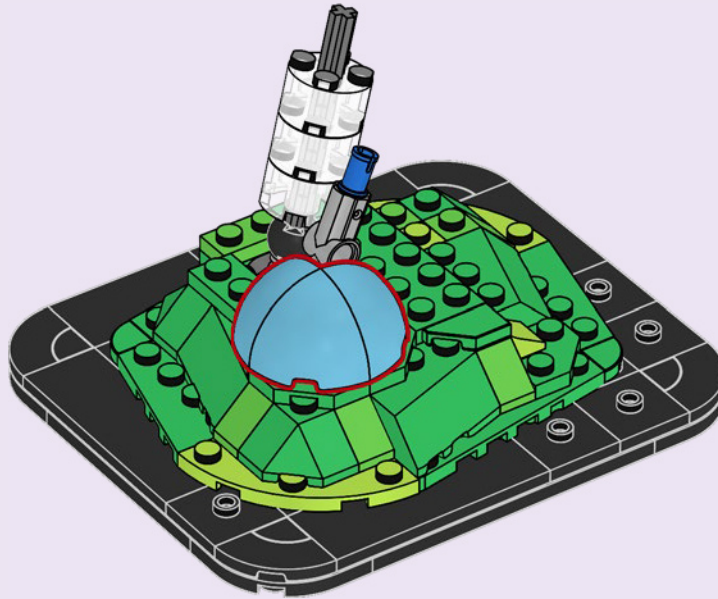



3x



3x

30

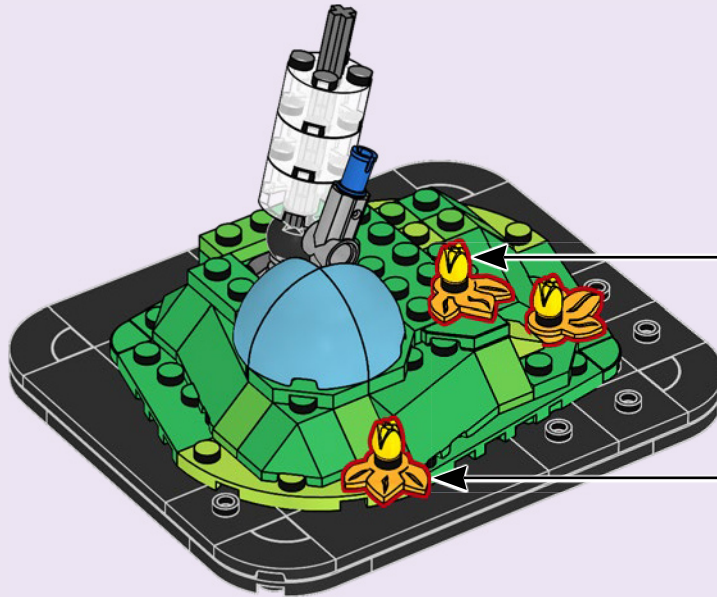

3x



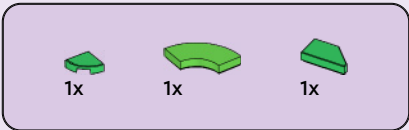

31

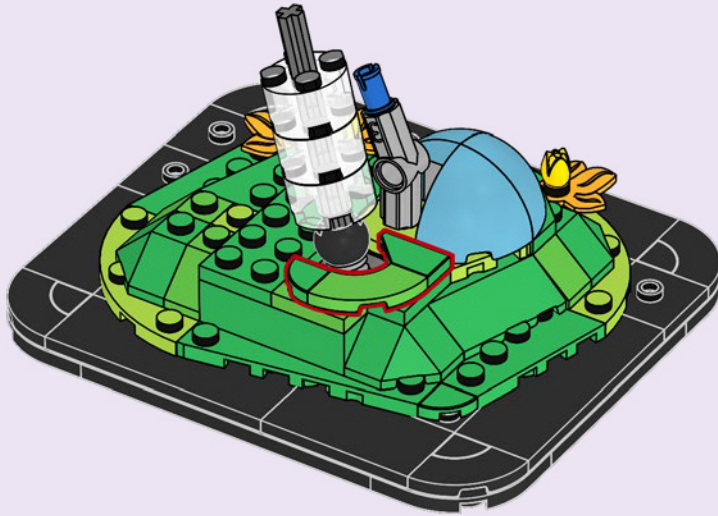

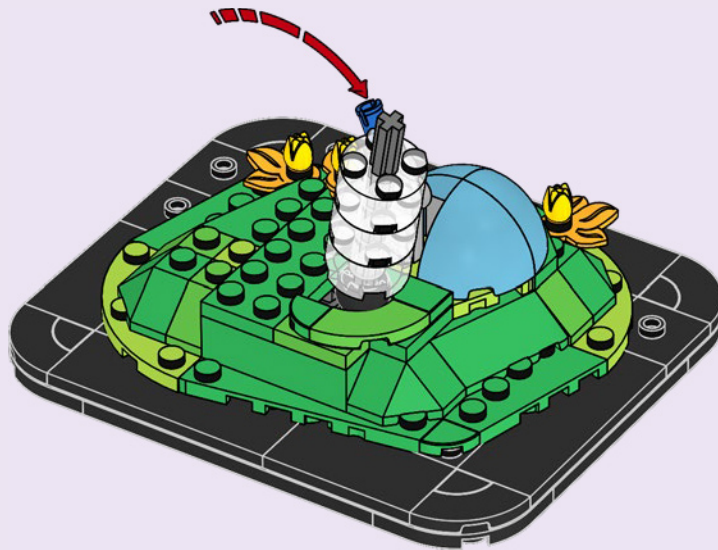

1x

1x

33

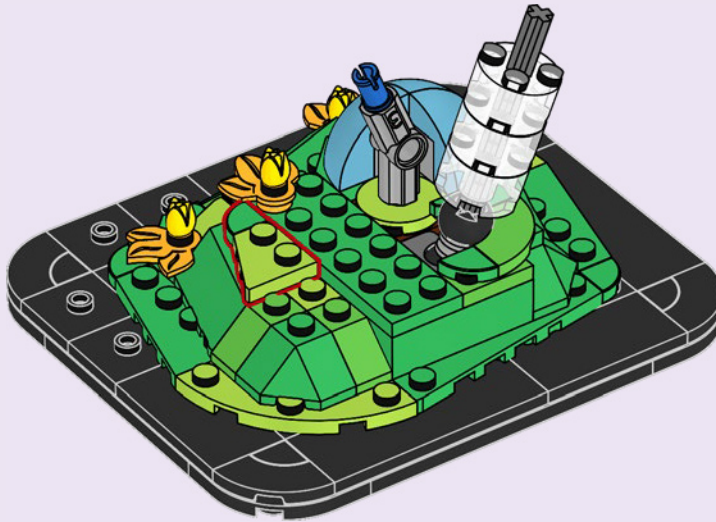

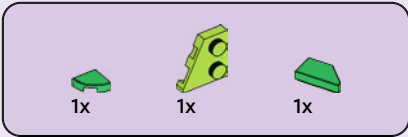

34

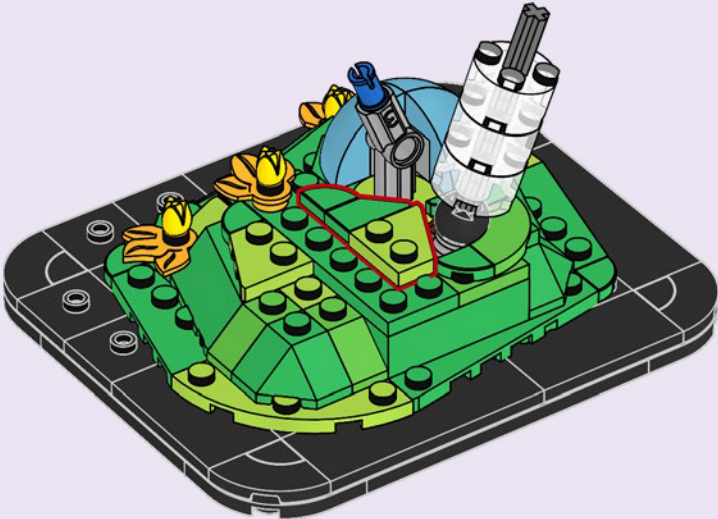

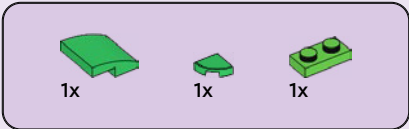

35

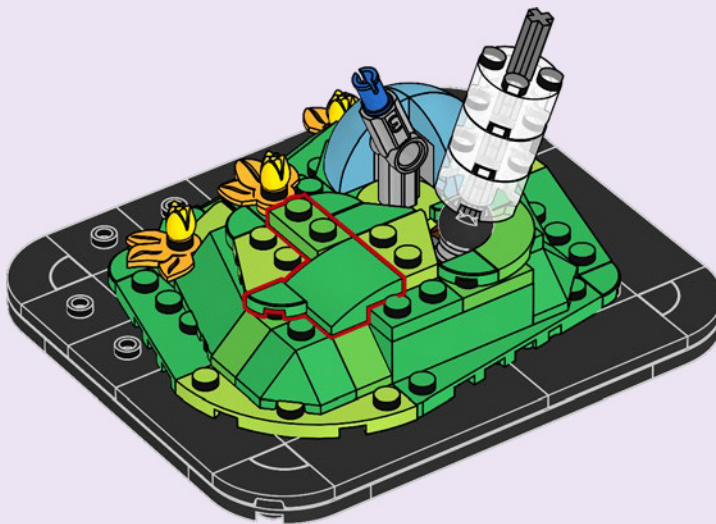

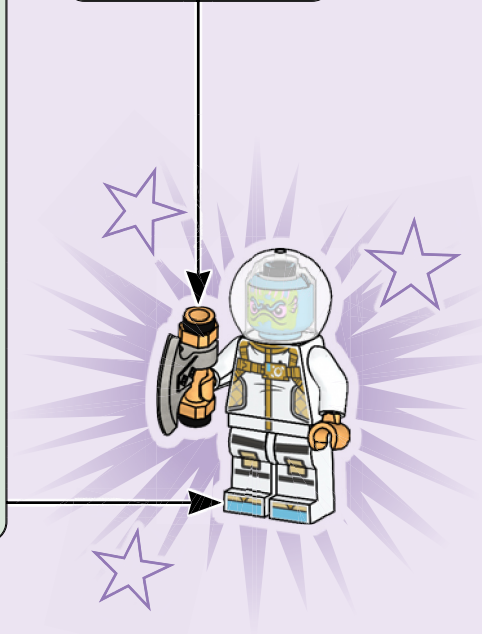
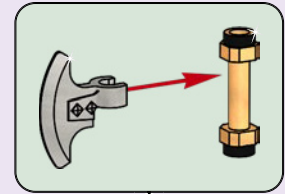
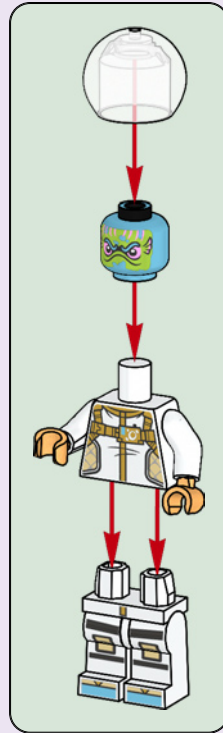

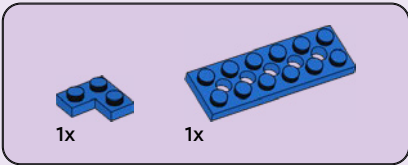
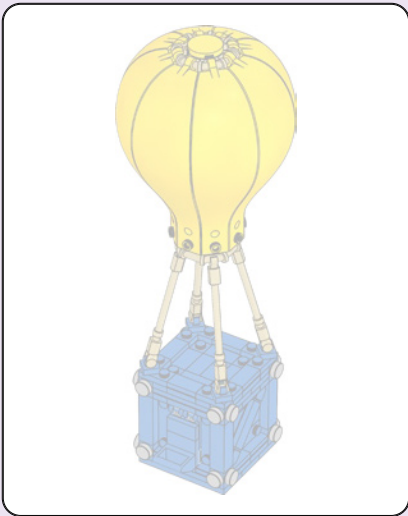

36

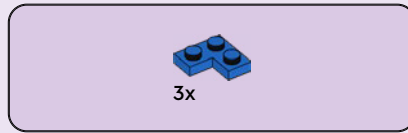
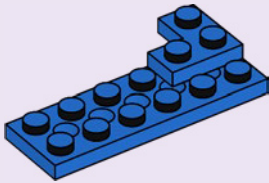

37

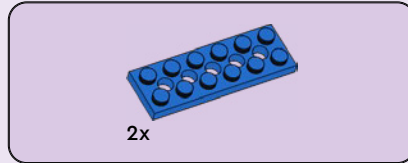
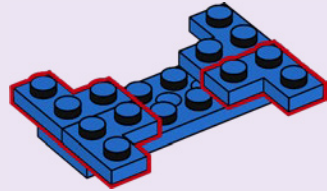

38

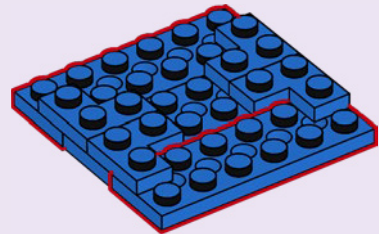

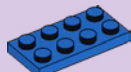

2x

39

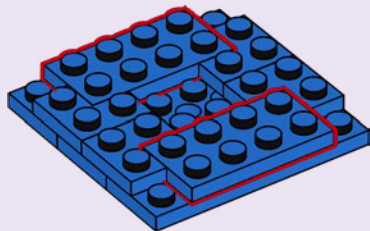

6x

40

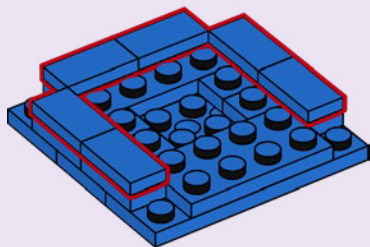

1x



2x

41

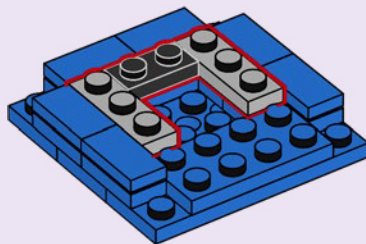

1x



2x

42

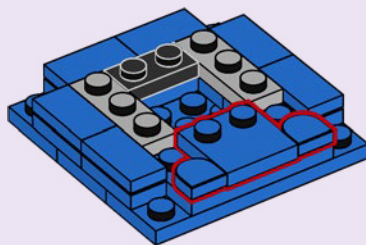

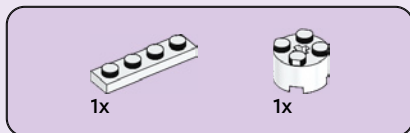

43

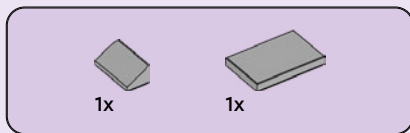
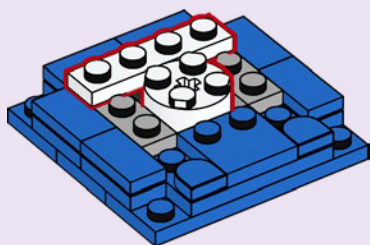

44

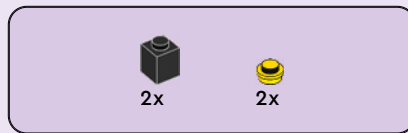
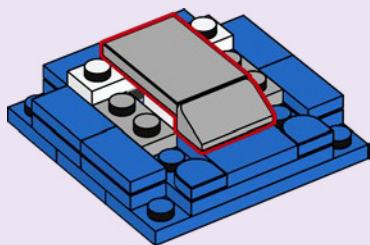

45

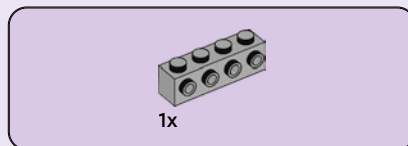
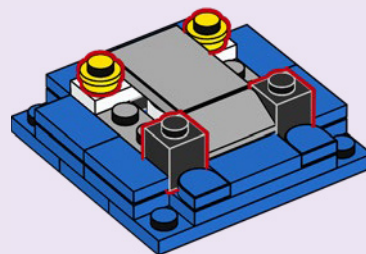

46

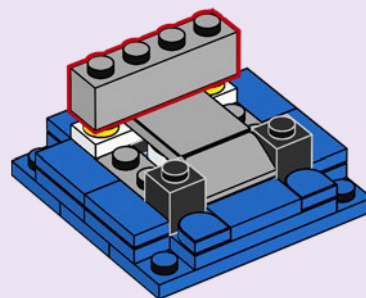



2x

47

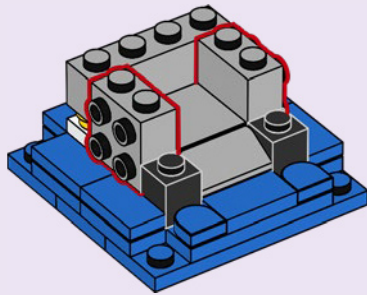

2x

48

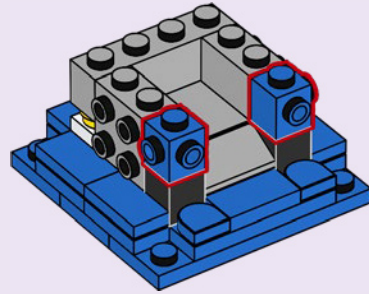

3x

49

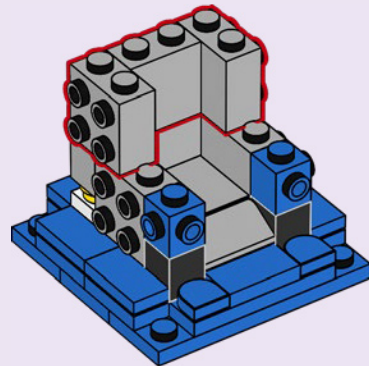



2x

50

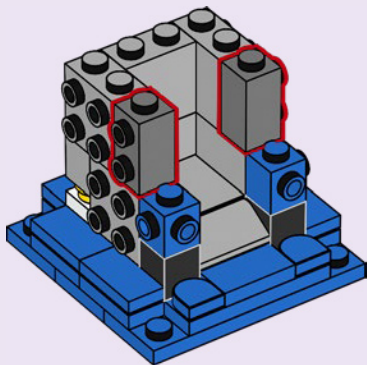

1x



1x



1x



2x

51

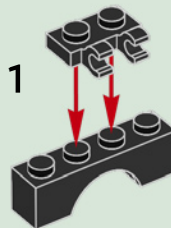

2



3

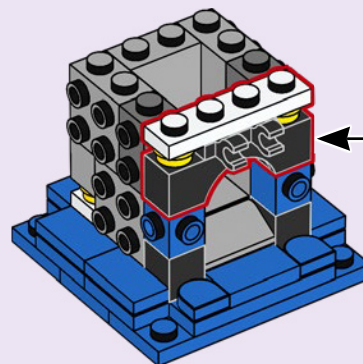
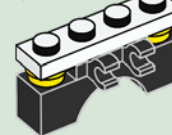



1x

54

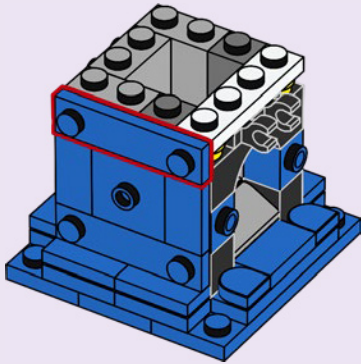

1x



2x

55

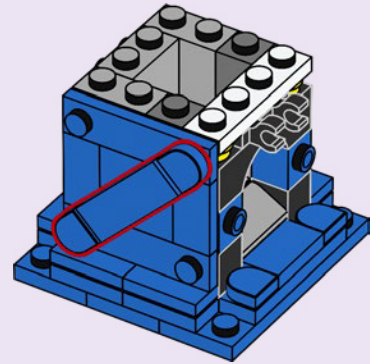

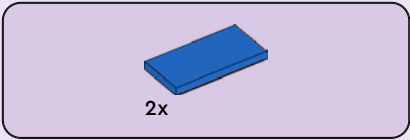

56

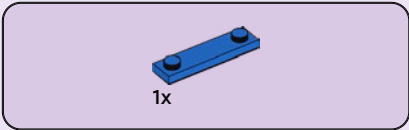
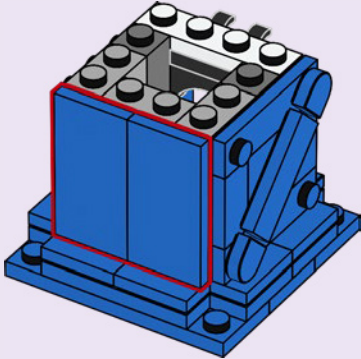

57

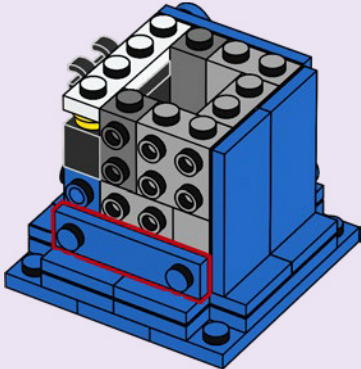

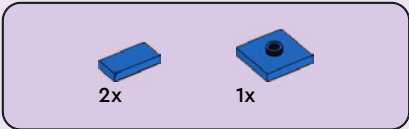

58

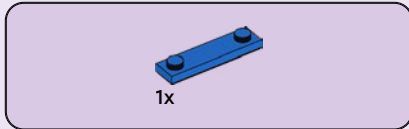
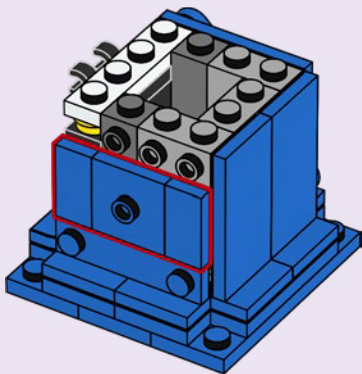

59

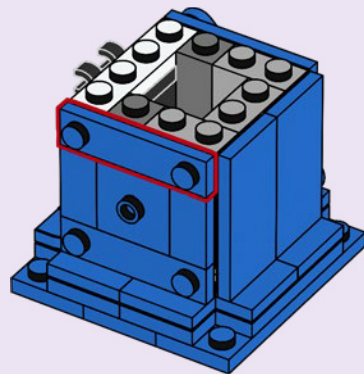

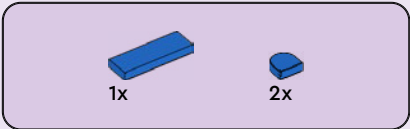

60

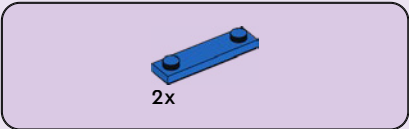
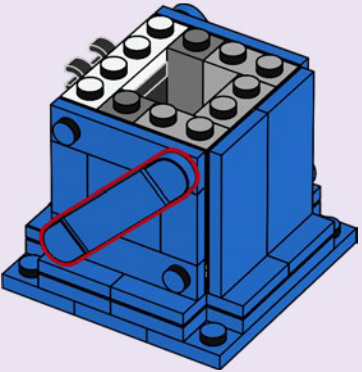

61

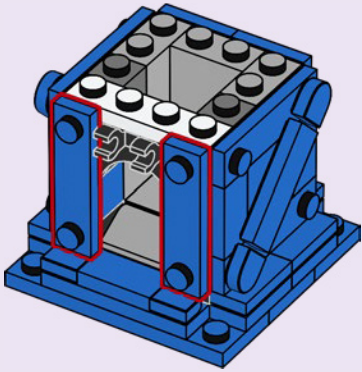

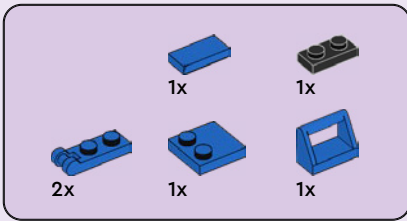

62

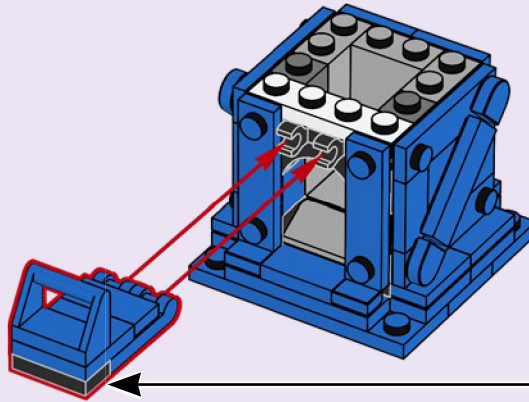
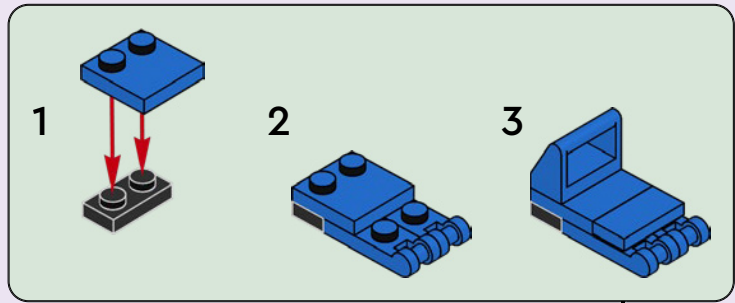



4x

63

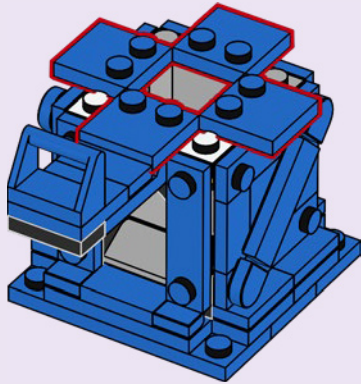

4x

64

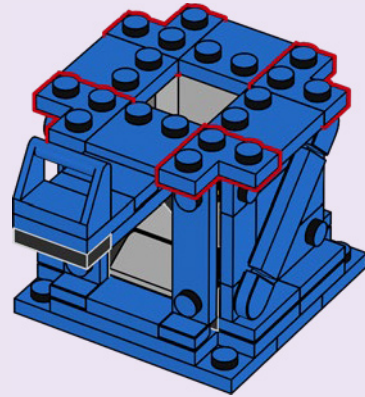

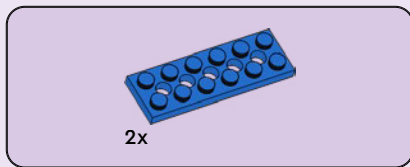

65

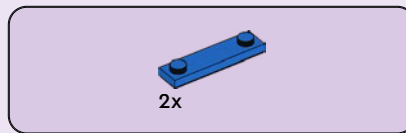
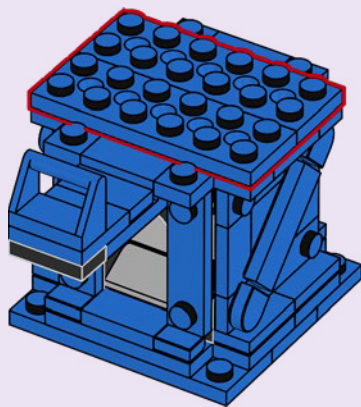

66

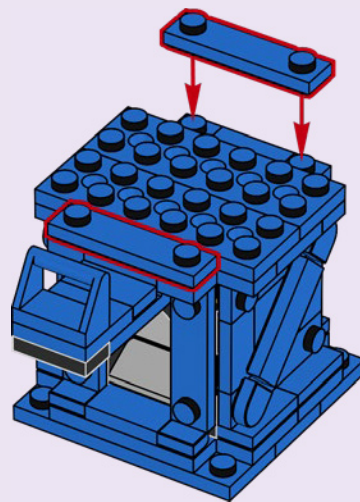

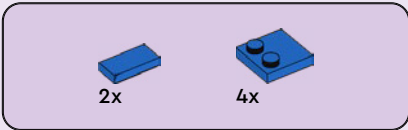

67

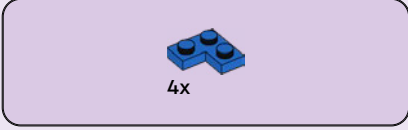
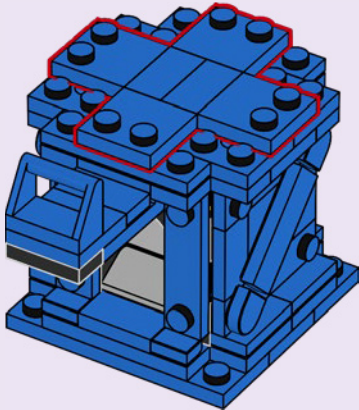

68

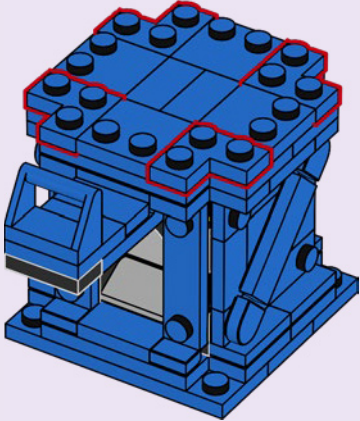

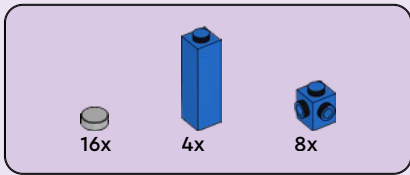

69

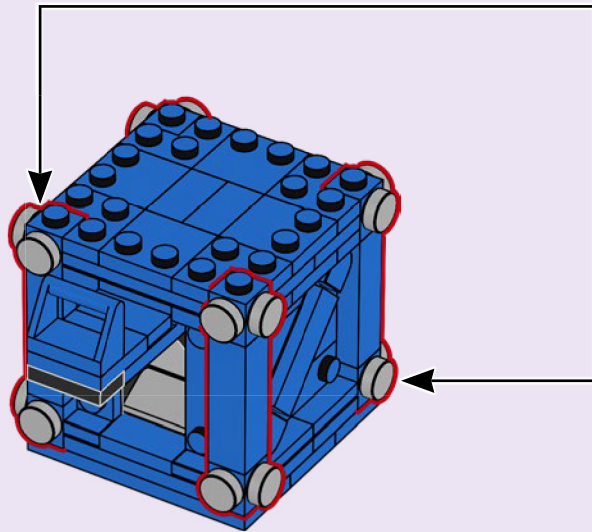
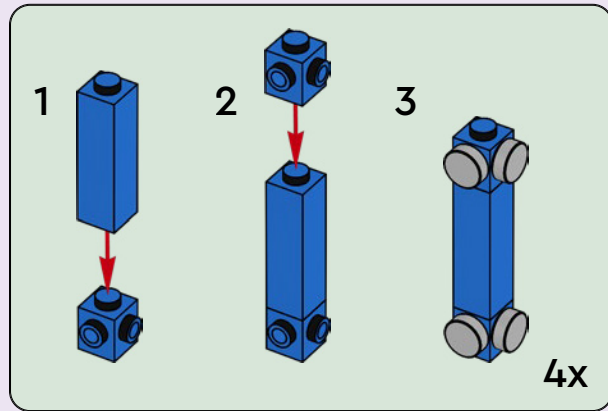



4x



4x

70

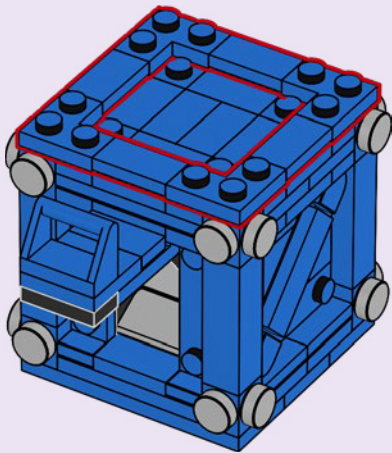

4x

71

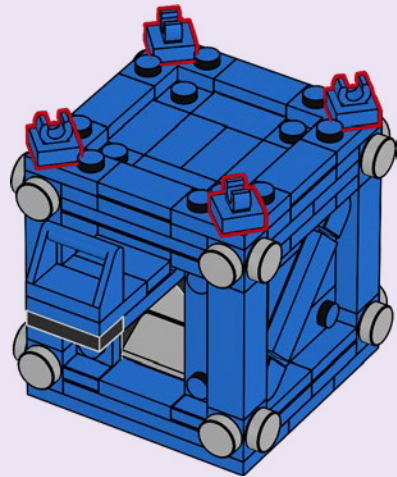



72

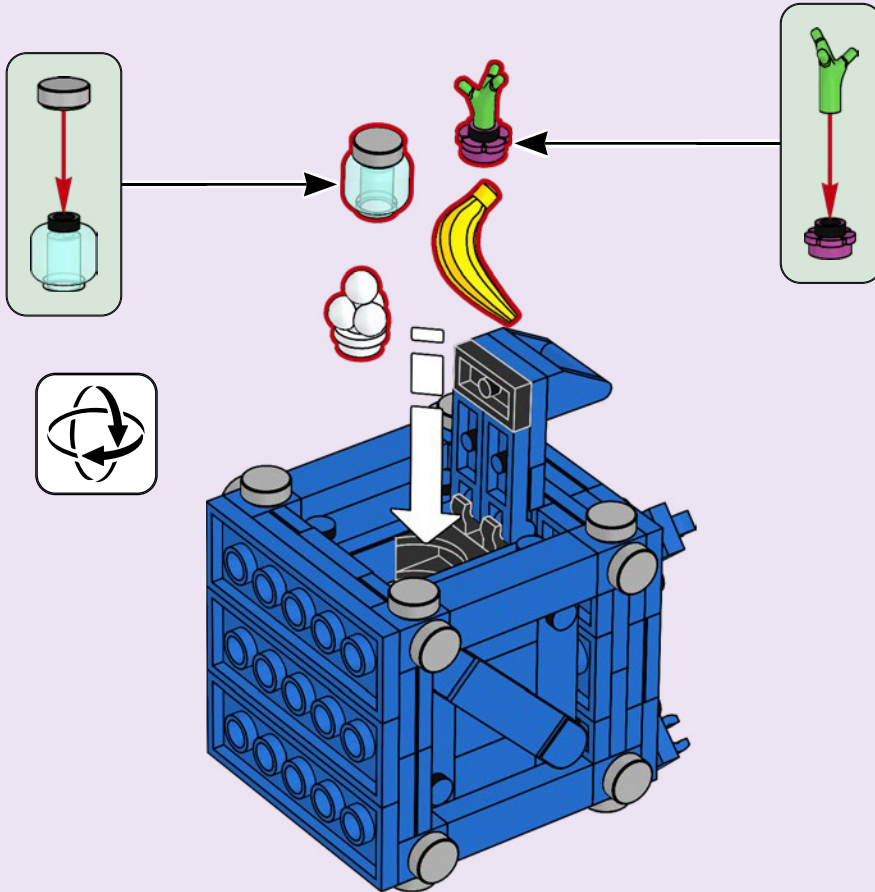

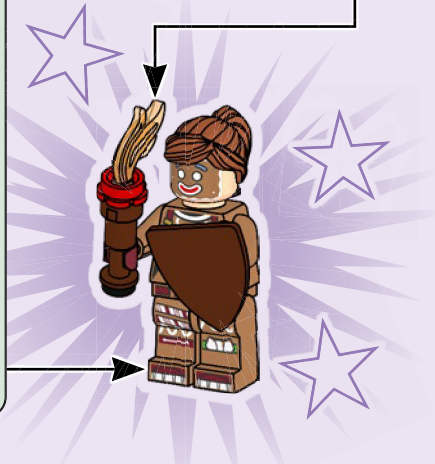
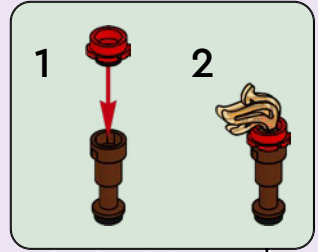
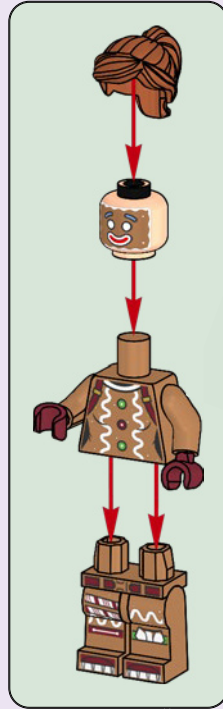
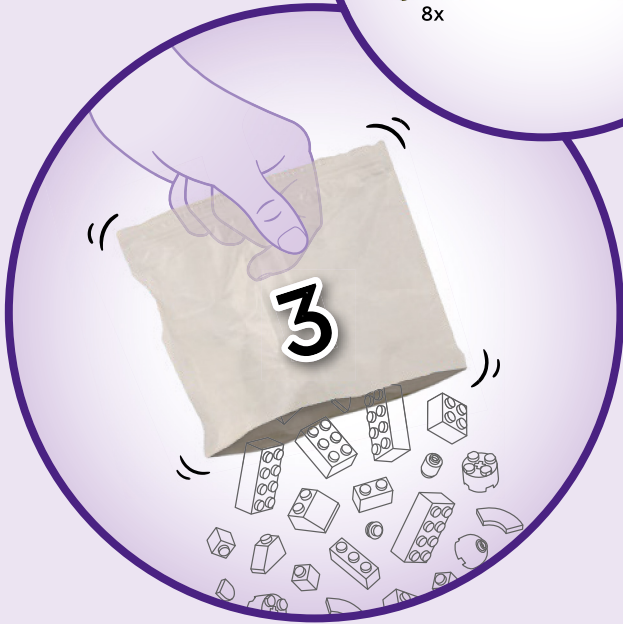
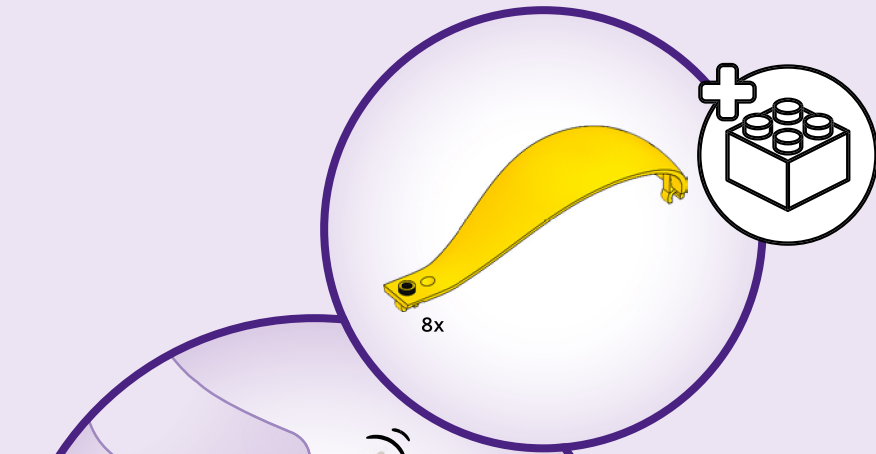

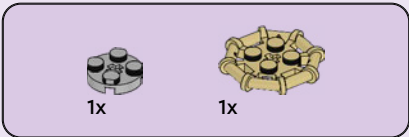
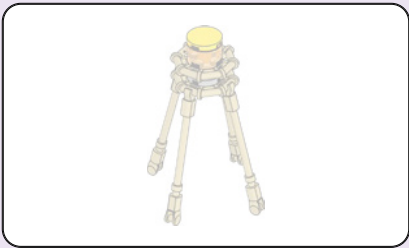

73

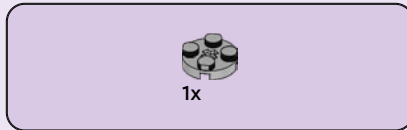
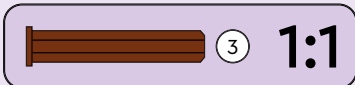
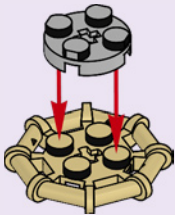

74

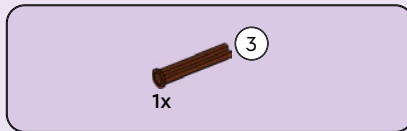
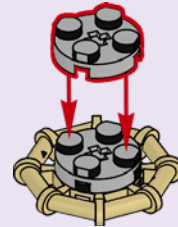

75

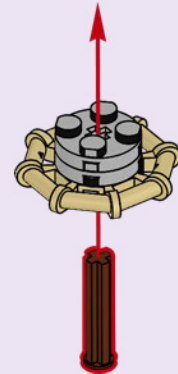

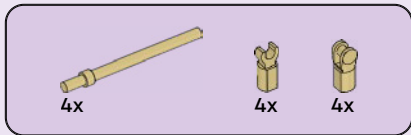

76

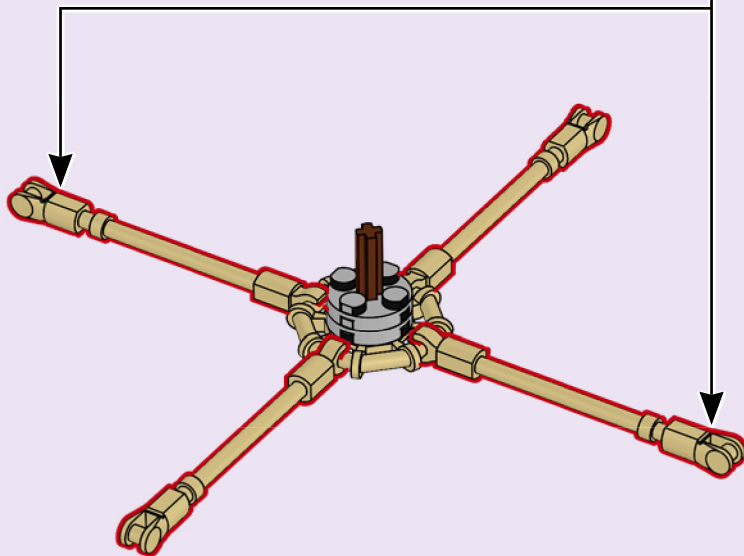
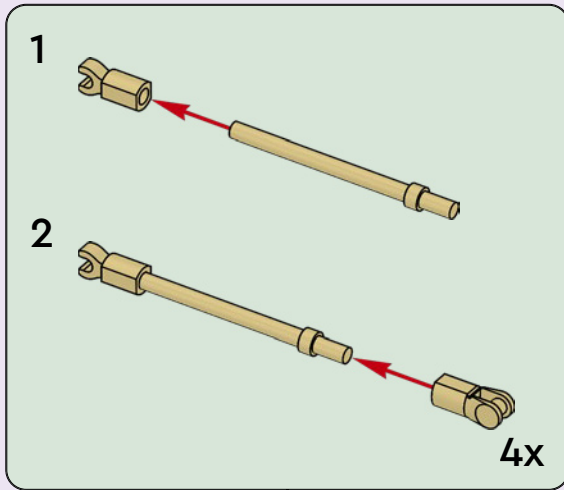



77

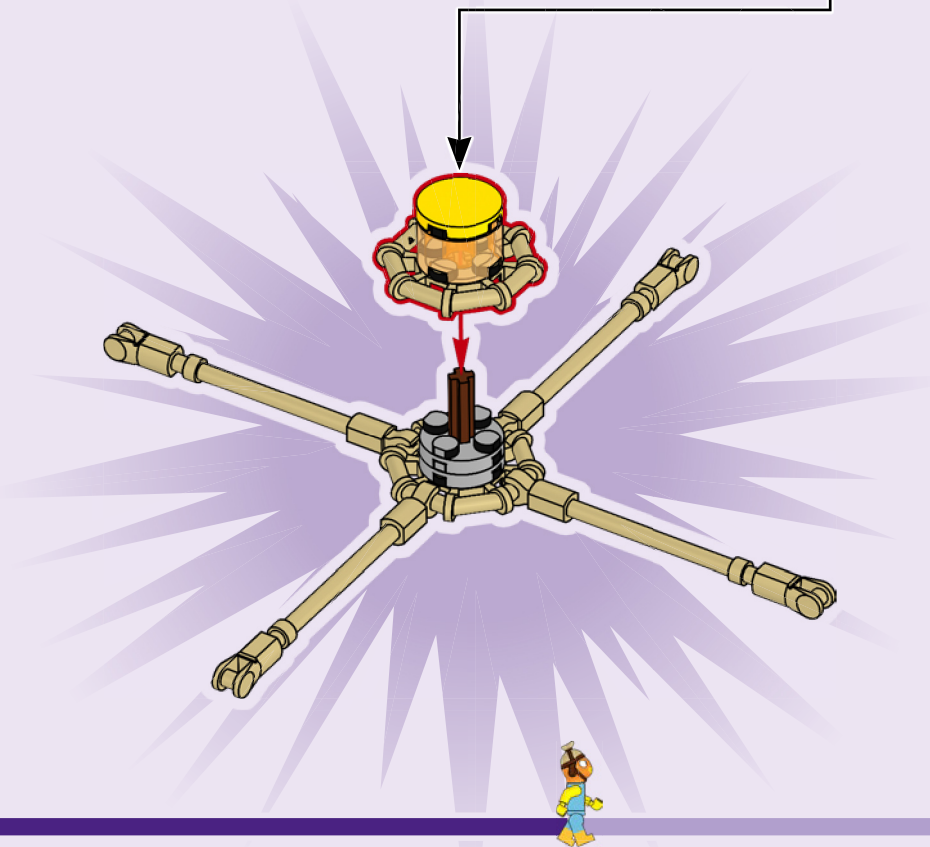
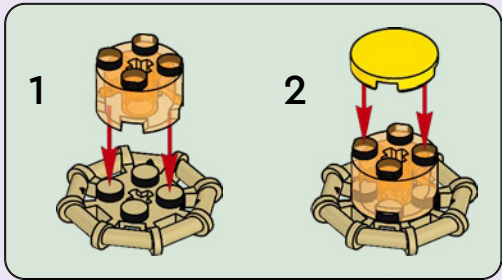

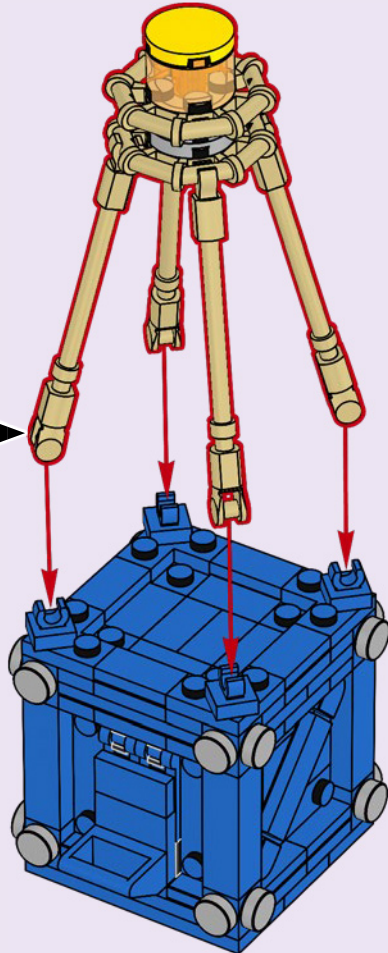

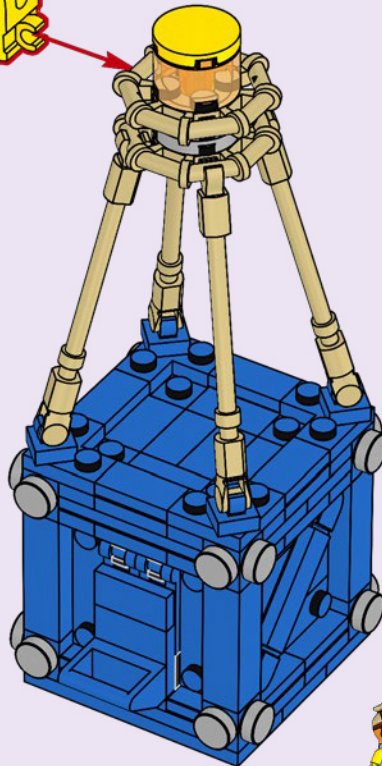
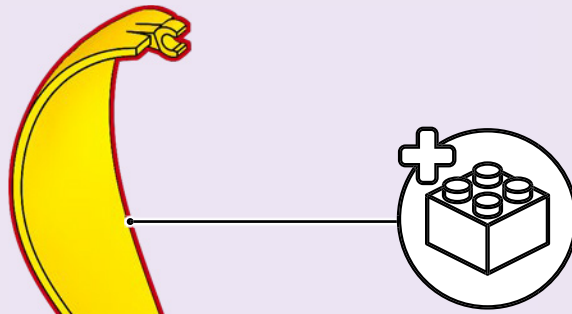

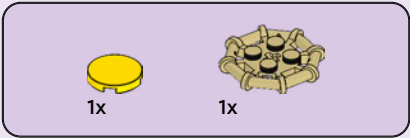

80

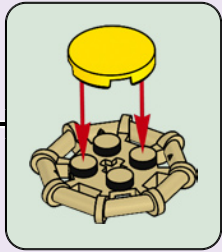
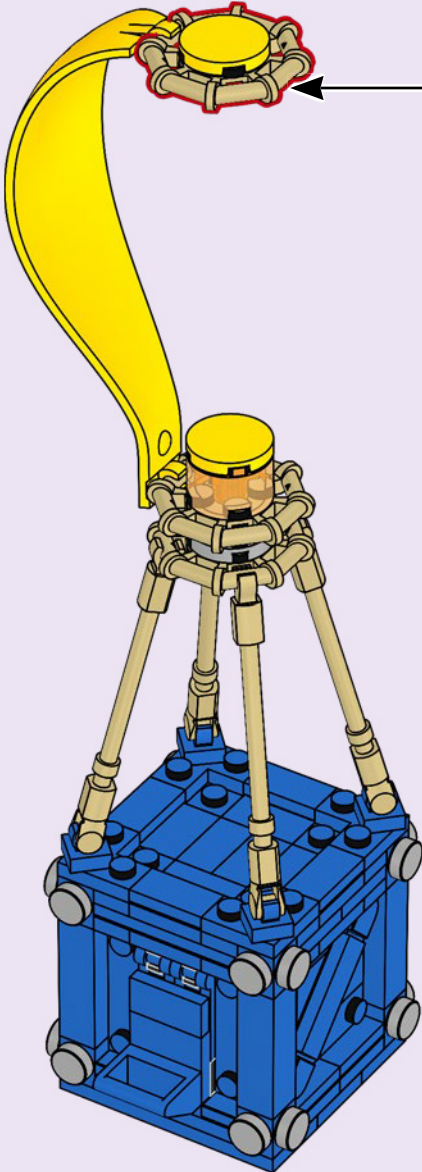

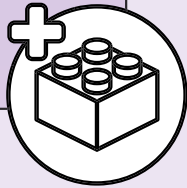
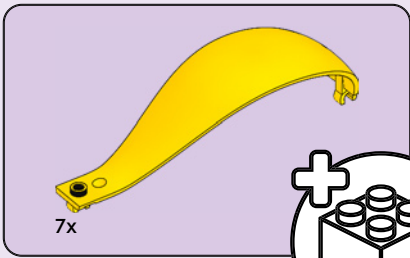

81

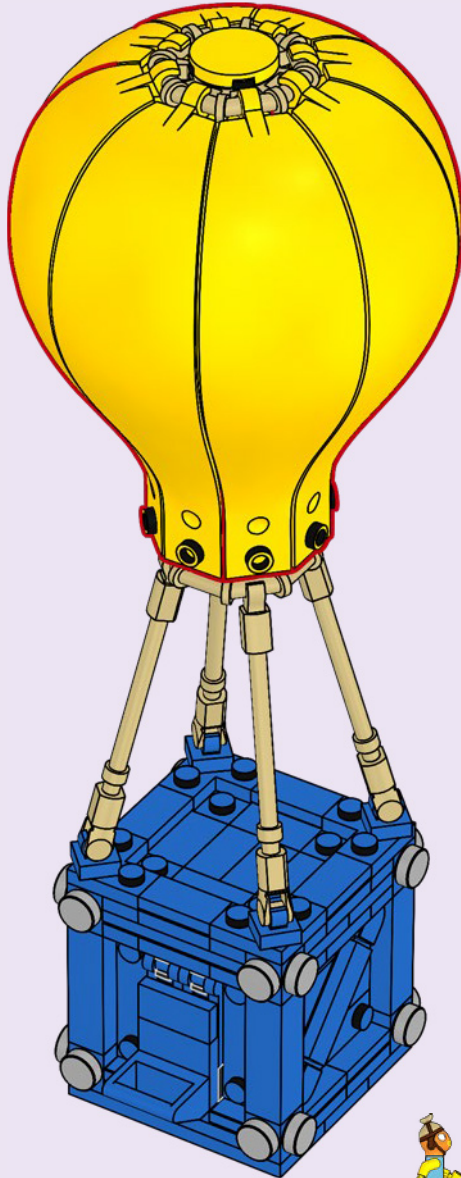

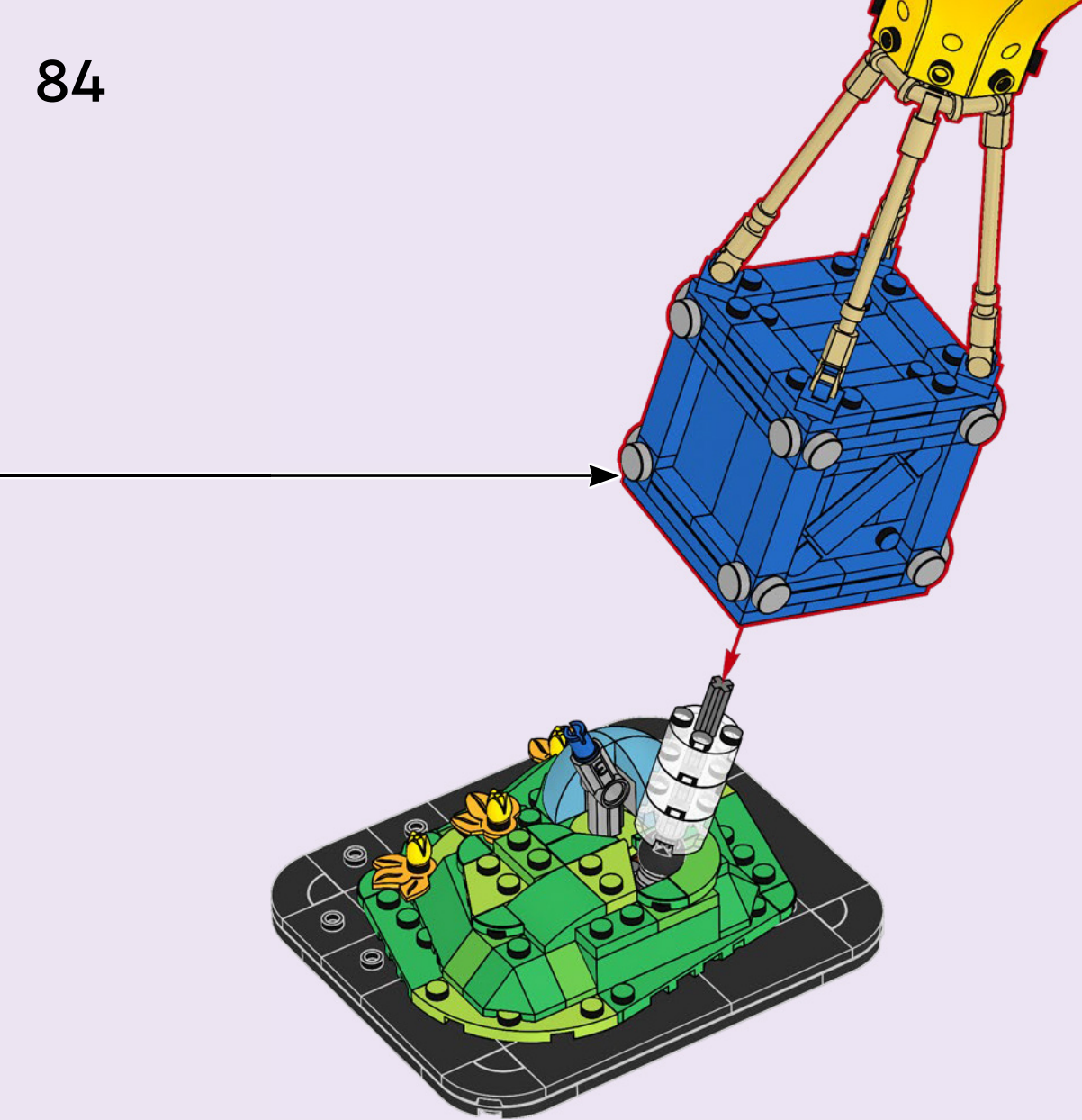

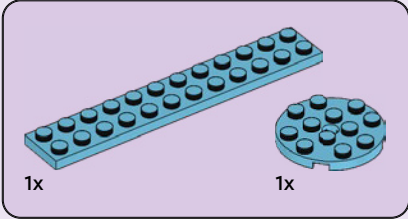
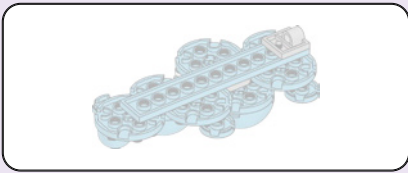

85

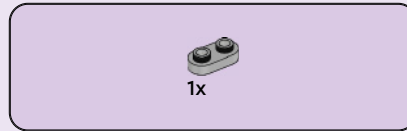
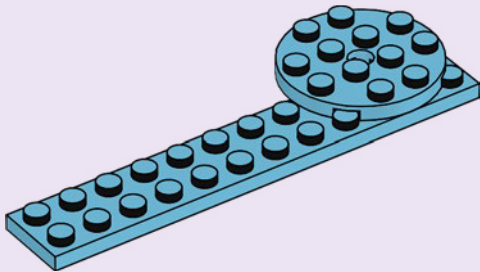

86

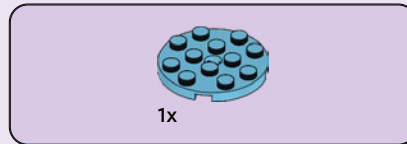
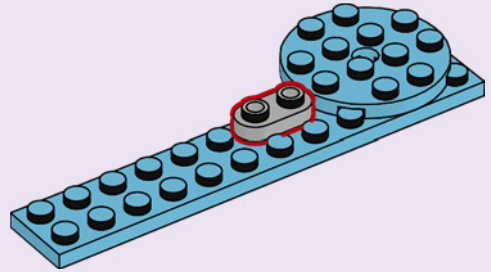

87

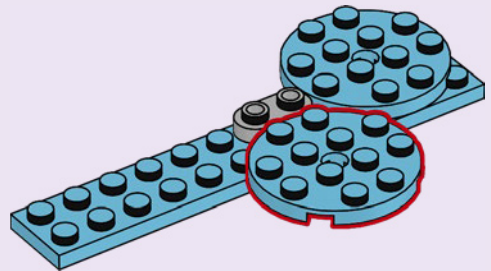



2x

88

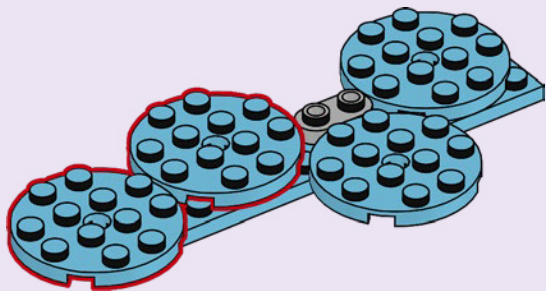

3x

89

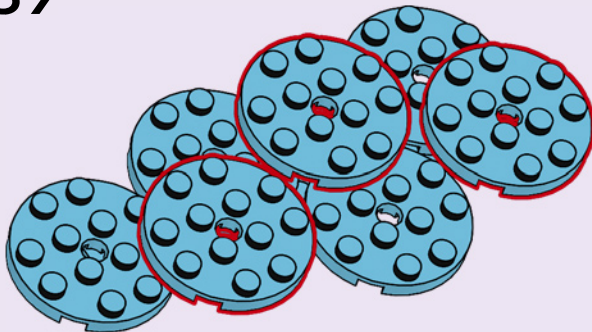

3x

90

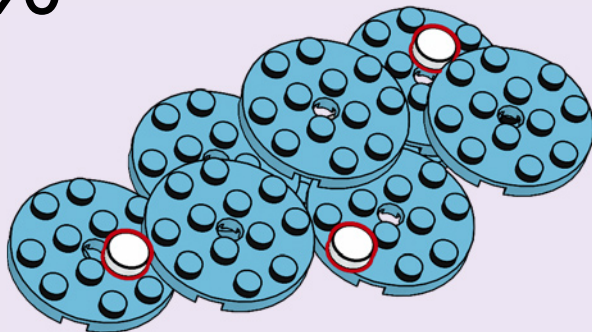

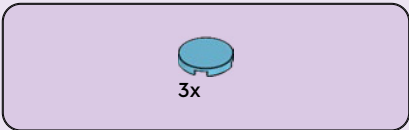

91

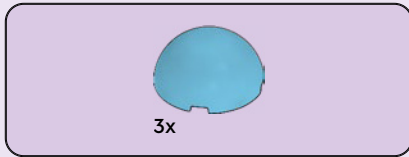
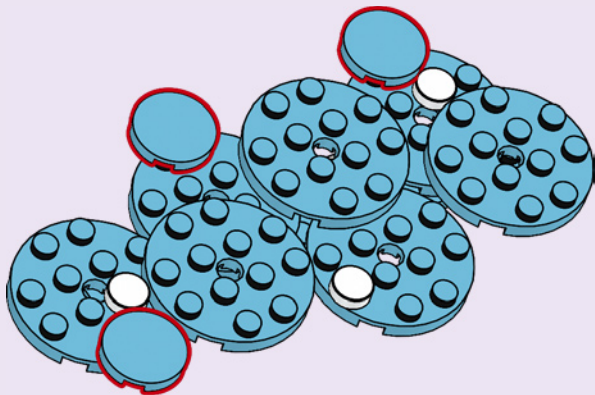

92

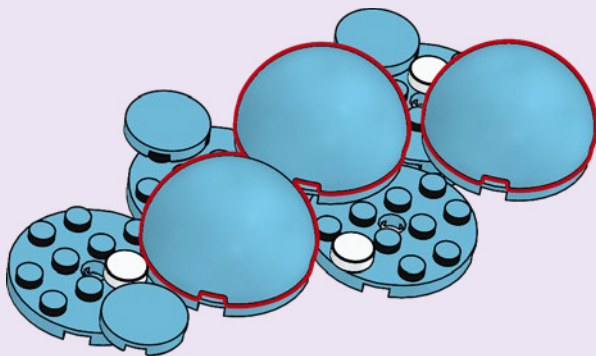



2x

93

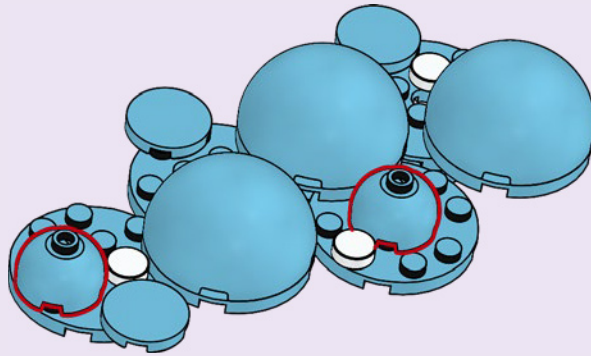



1x

94

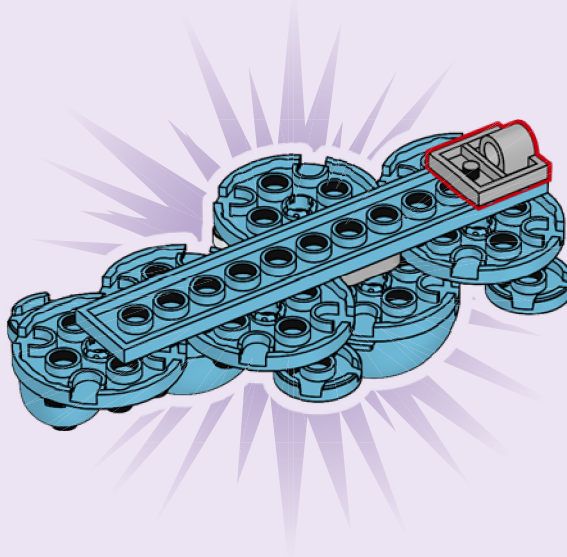

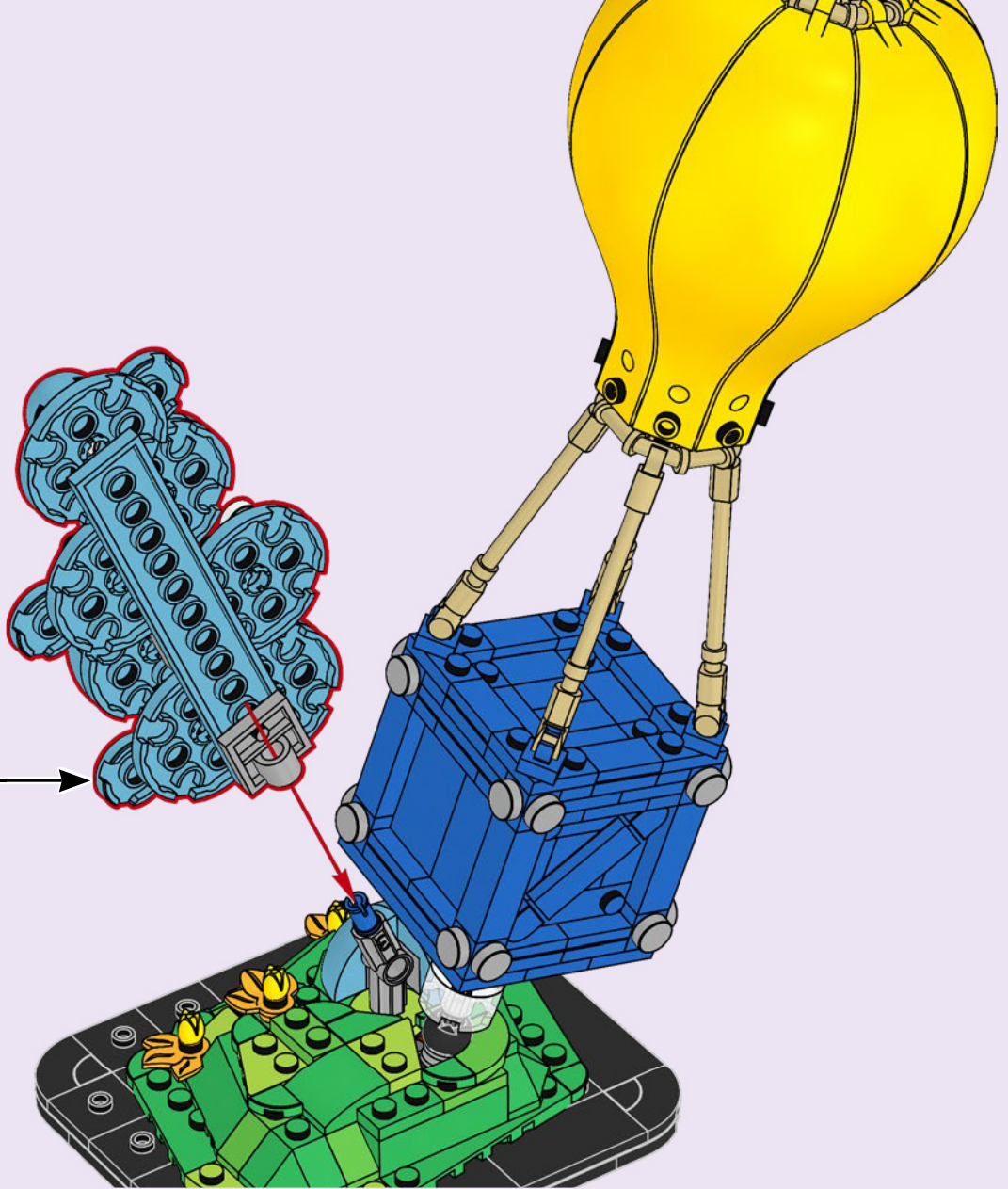

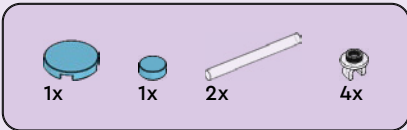

96

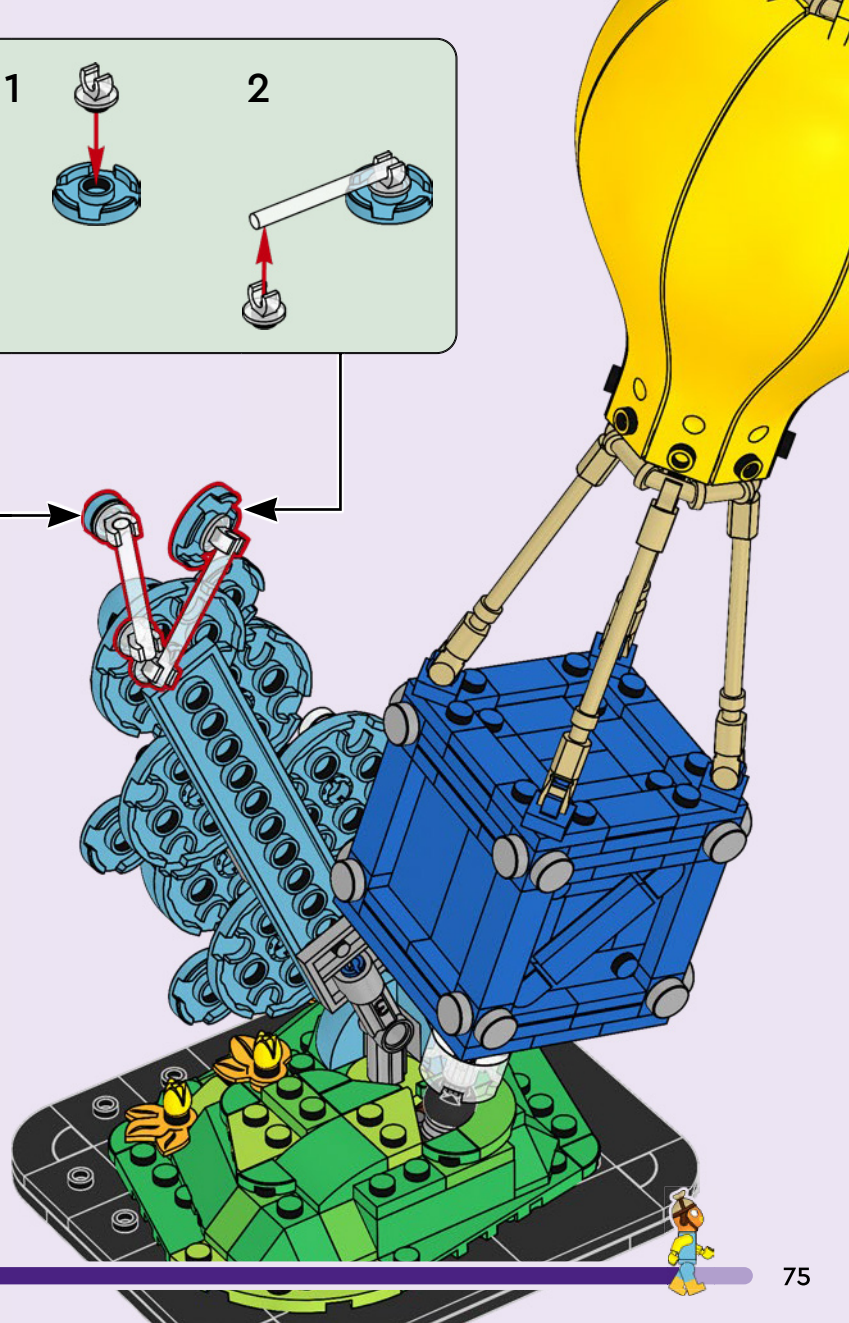
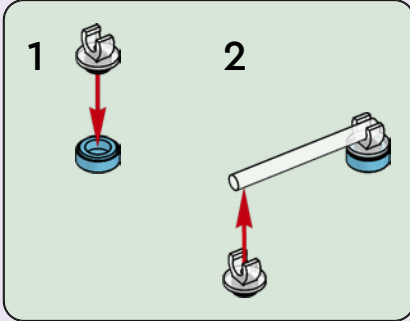
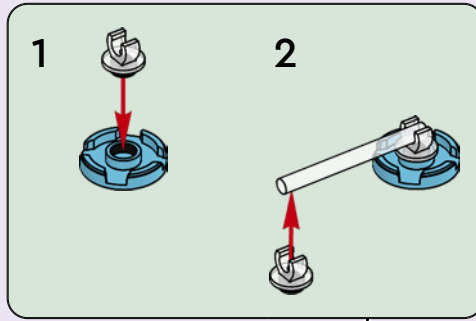

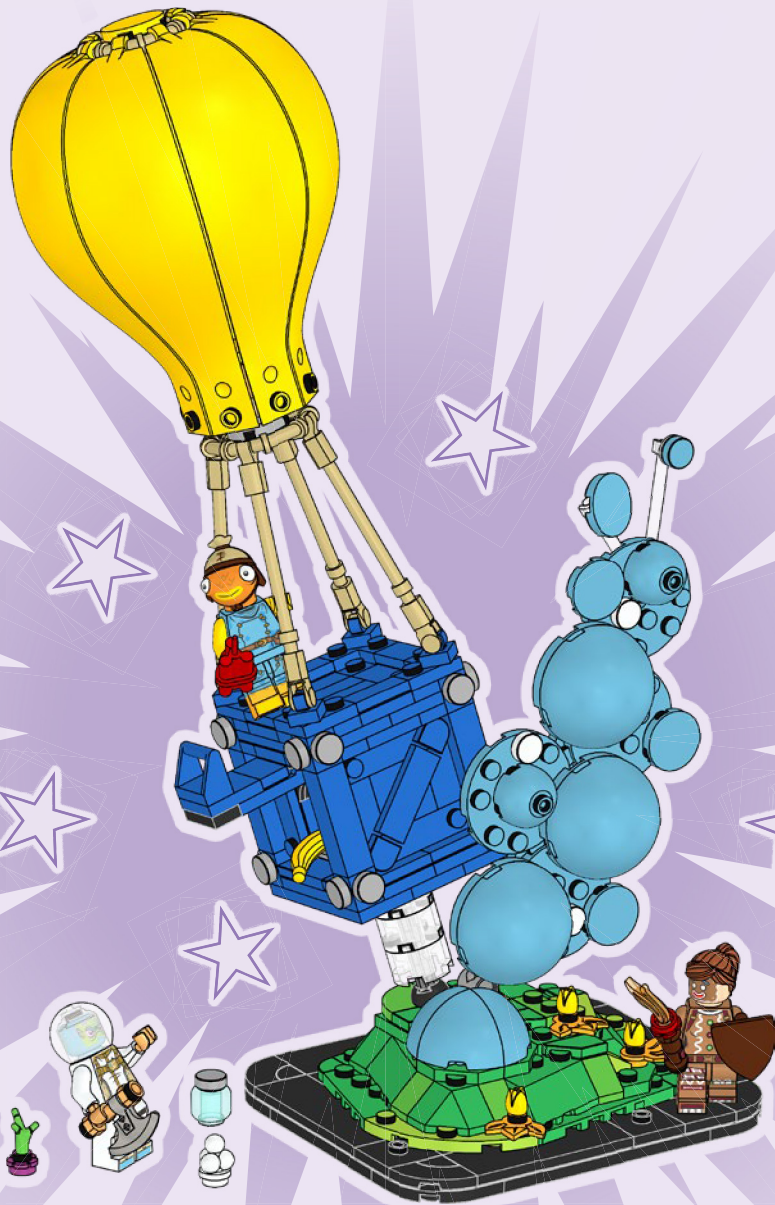



FORTNITE®



77079



77080



77081



77082

3x
6284572

1x
6458475

1x
6603617

1x
614301

1x
6603686

1x
6609705

2x
371001

4x
6337525



4x
6458391

3x
6575077

2x
4114309



4x
6254770

1x
6206148

1x
6270088

1x
4142865

6x
6268862

4x
6469934

4x
6344028

10x
6608463

1x
4206482

17x
306923

1x
243223

16x
242023

10x
6252060

2x
6126049

2x
6073890

2x
4587840

8x
6292291

2x
4560180

2x
302023

5x
4114027

3x
6500394

4x
614124

2x
6078279

1x
4114584

8x
6608461

2x
4286267

2x
300526

4x
6172383

2x
302326

1x
6310268

4x
6191630



5x
4565323

4x
4227392

1x
365926

2x
4560182

2x
366626

3x
6318582

3x
303526

1x
303626

6x
6150607

3x
6510137

2x
6385261

2x
4543262



3x
6311453

1x
6493699

1x
6116259

3x
6297286

1x
6404638

2x
4112838

2x
6404631

1x
379528

1x
6314353

1x
6514283

3x
6378797

1x
6223823

4x
6542392

1x
6514315

3x
6514281

2x
6507886

1x
6513993

2x
4220634

1x
4504372

3x
6258408

1x
6167483

2x
4504705

1x
6271165

17x
6284071

1x
6248890

1x
4568637

2x
4211475

5x
6123809

1x
6045988

1x
4211349

1x
6261387

2x
4211429

1x
6171894

1x
4211636

1x
6603687



1x
6378168

1x
6609579

1x
6603689

2x
6228923

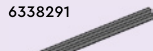
1x
6338291

1x
4499858

1x
6363145

1x
6209682

1x
6353186

1x
6310449

1x
6135494

1x
6365882

4x
4211247

1x
6434871

5x
6300148

2x
6343326

1x
6382958

1x
6322819

1x
6615222

4x
6145255

2x
6429058



1x
6603683

3x
6594033

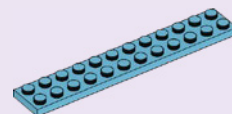

1x
6609526

7x
6102828

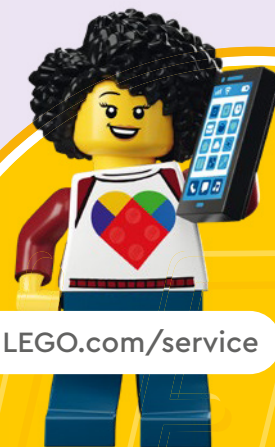

3x
6523577

1x
6344748

 [LEGO.com/service](https://www.LEGO.com/service)

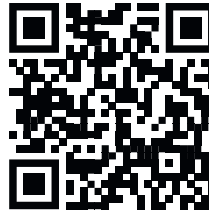

YOU COULD **WIN**



Scan this QR code or go to **LEGO.COM/PRODUCTFEEDBACK** and give us your short feedback about this LEGO® set for a chance to win a cool LEGO prize.

Terms and Conditions apply*

EN: YOU COULD WIN. Terms and Conditions apply* **DE: Du könntest GEWINNEN.** Es gelten die Teilnahmebedingungen* **FR: TU POURRAIS GAGNER.** Des conditions s'appliquent* **IT: Potresti VINCERE tu.** Termini e condizioni sono applicabili* **ES: PUEDES GANAR.** Aplican términos y condiciones* **PT: PODERÁ GANHAR.** Aplicam-se Termos e Condições* **ZH: 轻松获奖. 条款和条件适用*** **PL: Szansa na WYGRANĄ.** Obowiązuje regulamin* **CS: Máte šanci VYHRÁT.** Platí všeobecné smluvní podmínky* **SK: Máte šancu VYHRÁŤ.** Platia všeobecné zmluvné podmienky* **HU: TE IS NYERHETSZ!** Felhasználási feltételek érvényesek* **UA: ВИ МОЖЕТЕ ВИГРАТИ.** Застосовуються загальні положення та умови* **RO: Ai putea CÂȘTIGA.** Se aplică termeni și condiții* **BG: Можете да СПЕЧЕЛИТЕ.** Има определени правила и условия* **LV: Tu vari LAIMĒT.** Ir spēkā noteikumi un nosacījumi.* **ET: Sul on võimalus VÕITA.** Kehtivad tingimused* **LT: Jūs galite LAIMĖTI.** Taikomos sąlygos* **TR: KAZANABİLİRSİN.** Şartlar ve Koşullar geçerlidir*

*[LEGO.com/productfeedback-terms](https://www.lego.com/productfeedback-terms)

LEGO and the LEGO logo are trademarks of the/son des marques de commerce du/son marcas registradas de LEGO Group.
©2026 The LEGO Group.

© 2026 Epic Games, Inc. All rights reserved. Fortnite and its logo are trademarks of Epic Games, Inc. in the USA (Reg. U.S. Pat. & Tm. Off.) and elsewhere.