



FORTNITE®

77079



LEGO® Builder



Get excited about our new packaging!

We're switching from plastic to paper-based packaging. That's why you might find a mix of paper and plastic in our boxes!

Nos nouveaux emballages vous emballeront !

Nous passons des emballages en plastique aux emballages à base de papier. C'est pourquoi vous pourriez trouver un mélange de papier et de plastique dans nos boîtes !

¡Te presentamos nuestros nuevos empaques!

Estamos sustituyendo las bolsas de plástico por bolsas con base de papel. ¡Por eso, puedes encontrar una mezcla de papel y de plástico en nuestras cajas!

[LEGO.com/sustainable-packaging](https://www.lego.com/sustainable-packaging)



LEGO® Builder

BUILDER



Apple and the Apple logo are trademarks of Apple Inc., registered in the U.S. and other countries and regions. App Store is a service mark of Apple Inc. Google Play and the Google Play logo are trademarks of Google LLC. Tencent and the Tencent logo are trademarks of Tencent Inc.

LEGO.com/devicecheck

EN Ask parents' permission before going online | **DE** Eltern um Erlaubnis bitten, bevor du online gehst | **FR** Demande l'autorisation d'un parent avant d'aller en ligne | **IT** Chiedi il permesso ai tuoi genitori prima di andare online | **ES** Pídeles permiso a tus papás antes de conectarte a Internet | **PT** Pede autorização aos teus pais antes de ficares online | **ZH** 上网前应先征得父母的同意 | **PL** Poproś rodziców o zgodę, zanim wejdiesz do Internetu | **CS** Než půjdeš na internet, požádej rodiče o svolení | **SK** Skôr než pôjdeš na internet, vypýtaj si povolenie od rodičov | **HU** Kérj szülői engedélyt, mielőtt online csatlakoznál! | **UA** Запитуйте дозволу батьків, перш ніж користуватися інтернетом | **RO** Cere permisiunea părinților înainte de a te conecta online | **BG** Поискайте разрешение от родител, преди да влезете онлайн | **LV** Pirms došanās tiešsaistē palūdz atļauju vecākiem | **ET** Enne Interneti kasutamist küsi vanematelt luba | **LT** Prieš prisijungdami prie interneto, atsiklauskite tėvų | **TR** İnternete girmeden önce anne babandan izin iste



FORTNITE®

**REDEEM YOUR BONUS
IN-GAME DECOR PACK!**

1 Scan the QR code
and follow the steps



**RÉCLAMEZ VOTRE LOT
D'OBJETS DE DÉCORATION
EN PRIME DANS LE JEU!**

1 Balaie le code QR
et suis les étapes

**¡CANJEA TU PACK DE
DECORACIÓN DE REGALO
PARA EL JUEGO!**

1 Escanea el código QR
y sigue los pasos

**Ask parents' permission
before going online**

Terms and Conditions apply



**2 Sign in/up and claim
your code to redeem**

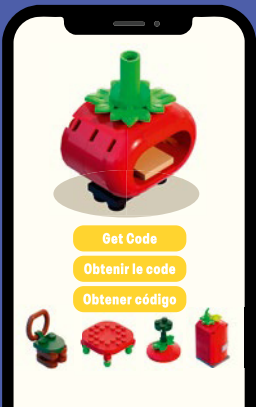

**2 Connectez-vous ou inscrivez-vous
et utilisez votre code pour recevoir
votre prime**

**▶ Demande l'autorisation d'un
parent avant d'aller en ligne**

Des conditions s'appliquent

**2 Inicia sesión/regístrate para
recibir tu código y canjearlo**

**▶ Pídeles permiso a tus papás
antes de conectarte a Internet**

Se aplican Términos y Condiciones



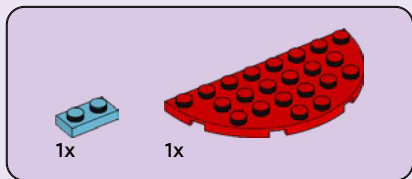

1

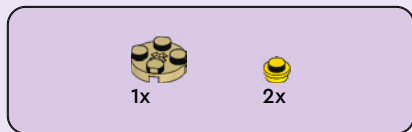
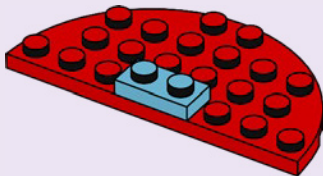

2

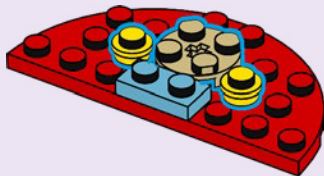



2x

3

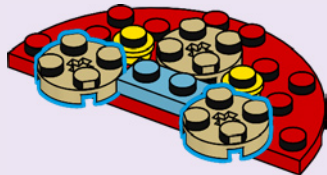

1x

4

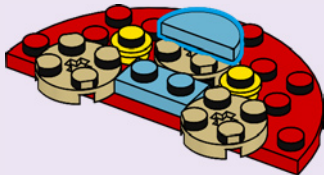



1x

5

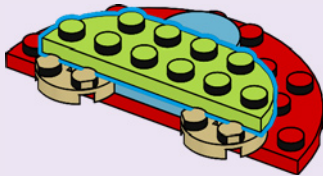

2x

6

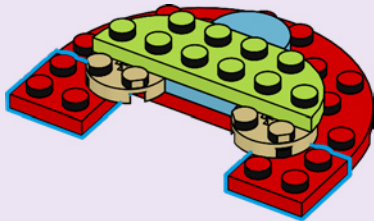

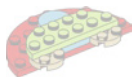

1x



1x

7

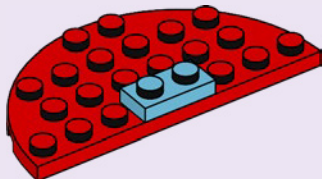

1x



2x

8

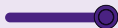
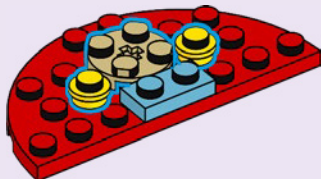



2x

9

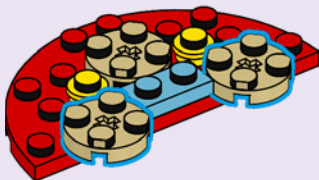

1x

10

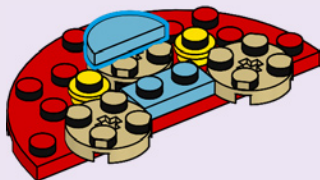

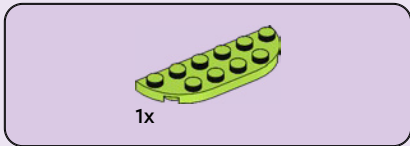

11

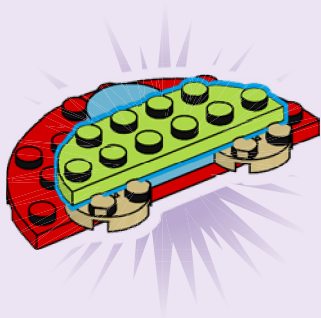

12

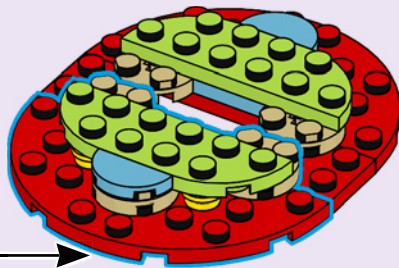



4x

13

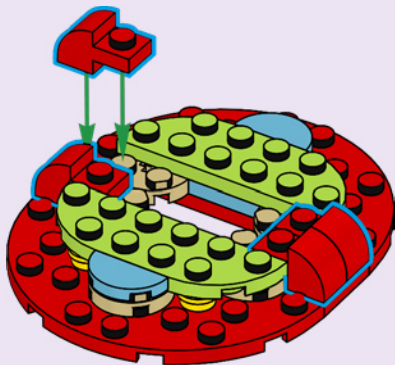

1x

14

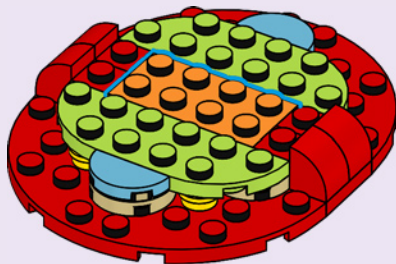



2x

15

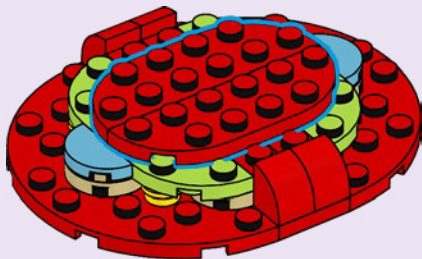

2x



4x

16

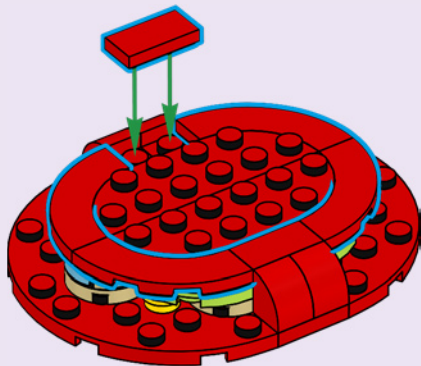

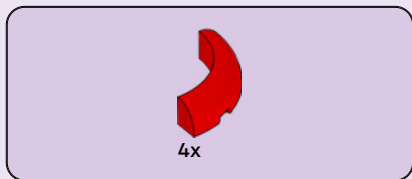

17

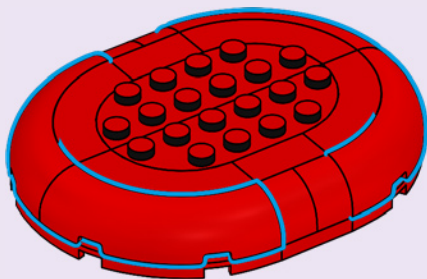



4x



2x

18



1

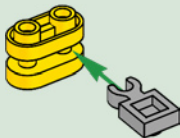

2

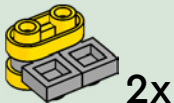

2x

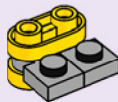
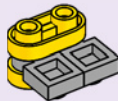
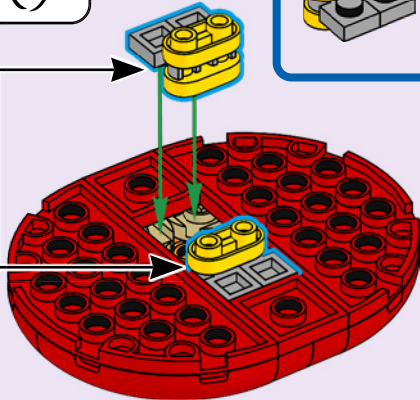



4x



2x

19

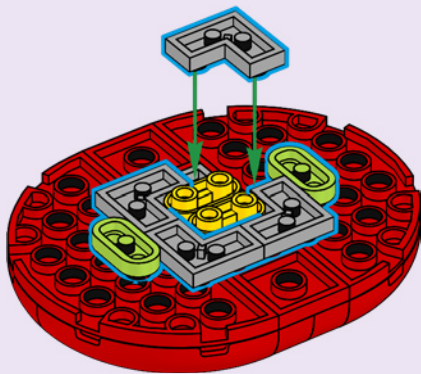



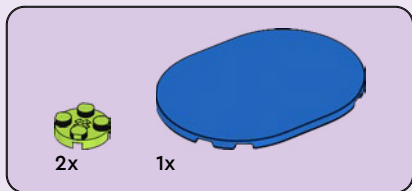
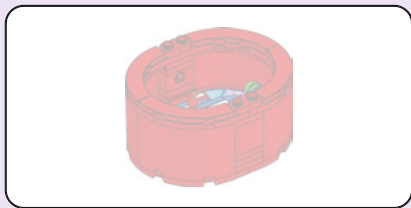

20

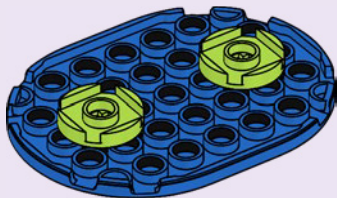

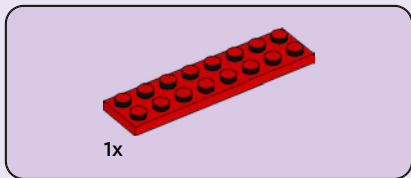

21

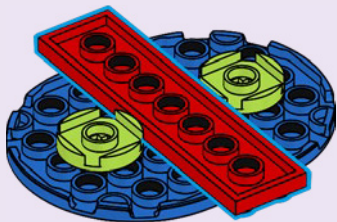

20

22

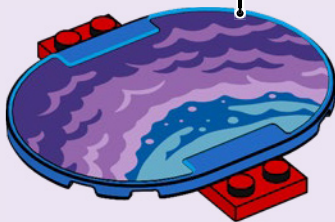
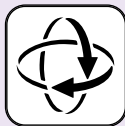

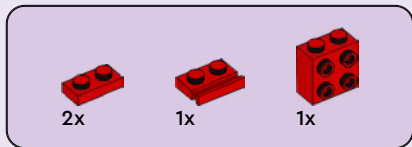

23

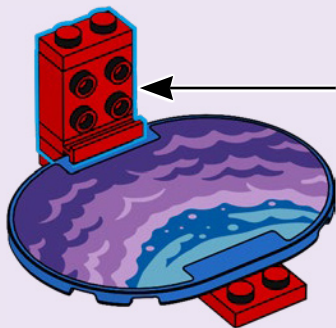
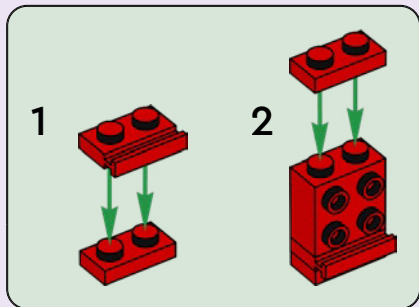

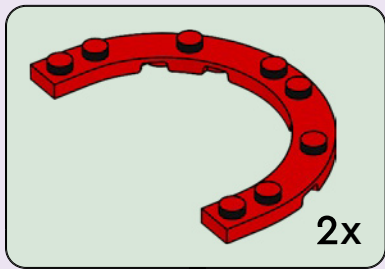
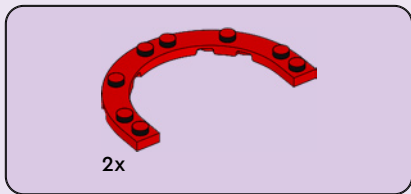

24

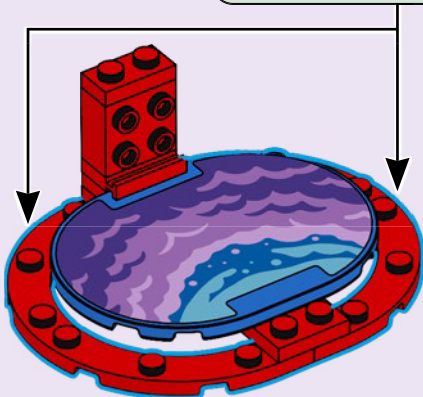

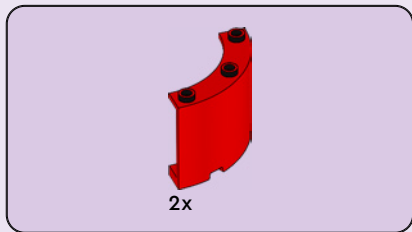

25

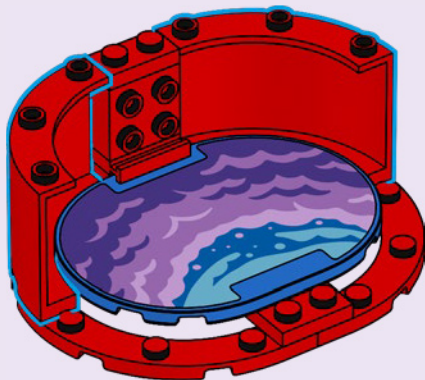



1x



1x

26

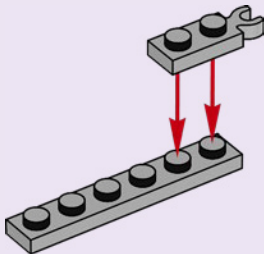



2x



1x



2x

27

1



2



3

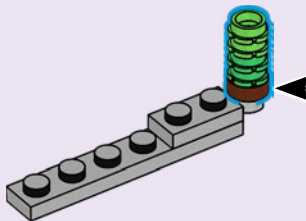



1x



1x

28

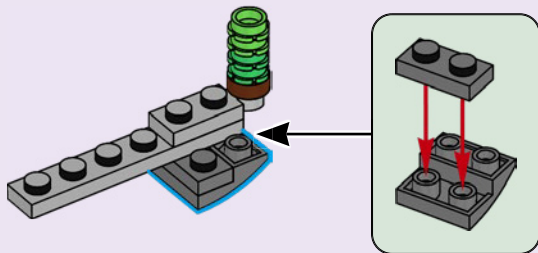

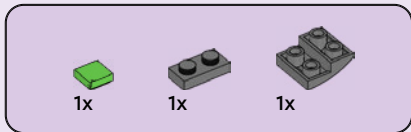

29

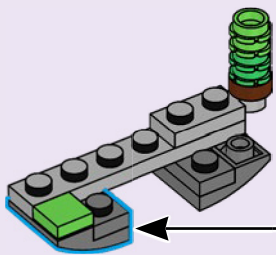
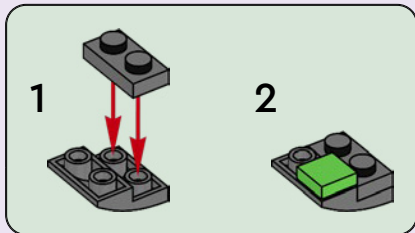

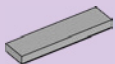

1x

30

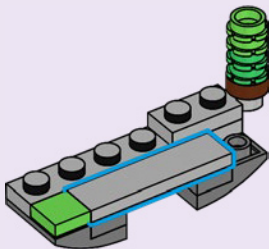

1x



2x

31

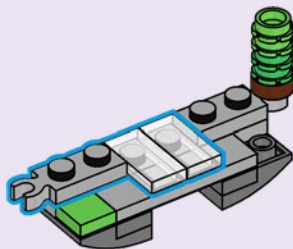



32

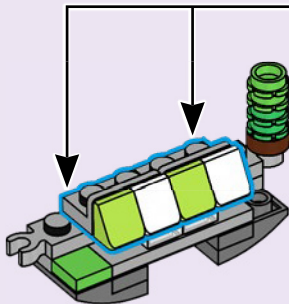
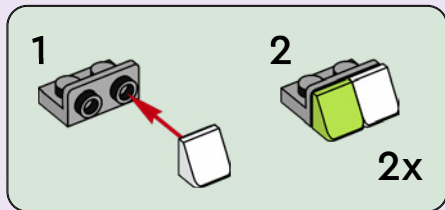



1x

33

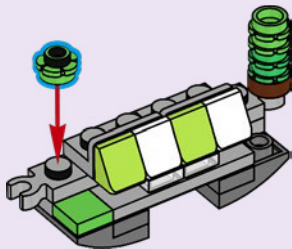

4x

34

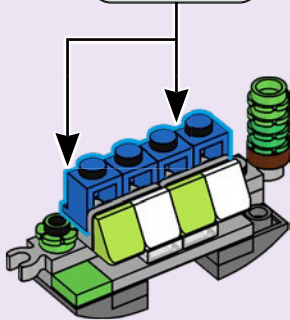



1x

35

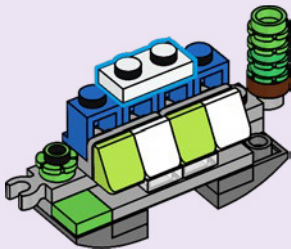

2x



1x



1x

36

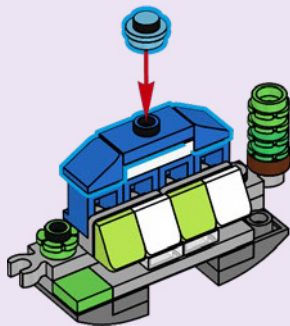



1x

37

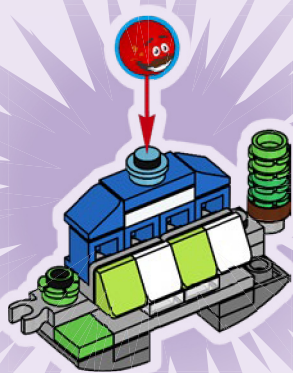



38

1

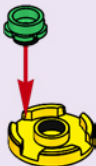

2



3

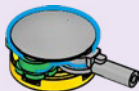



4

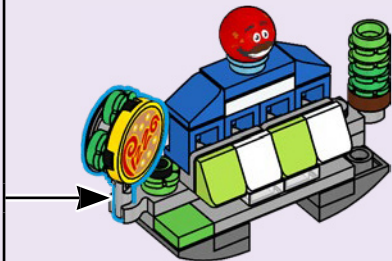

39

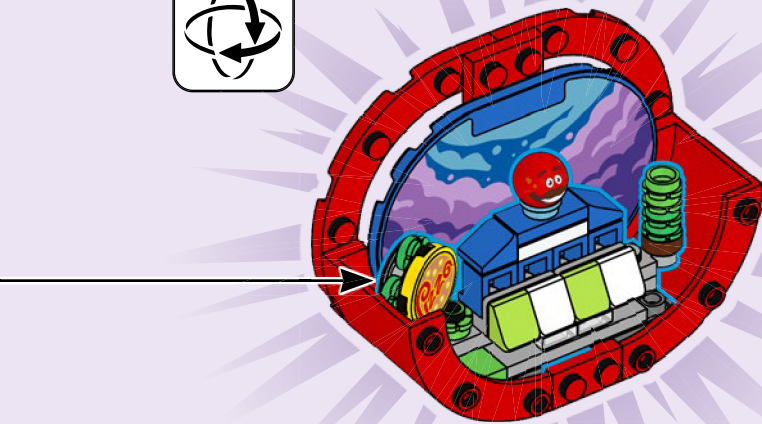

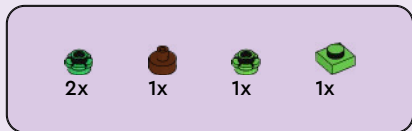

40

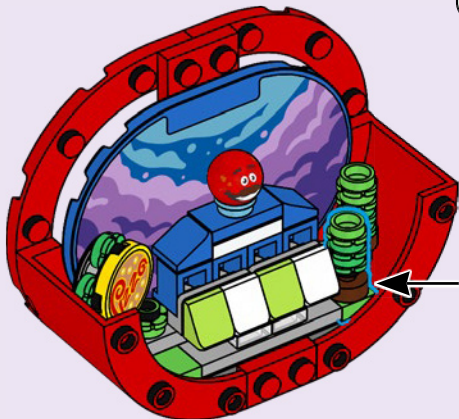
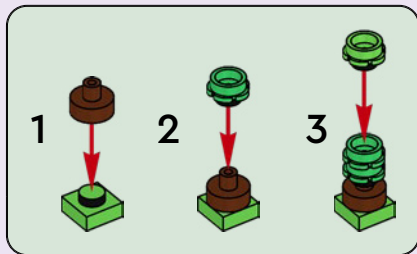

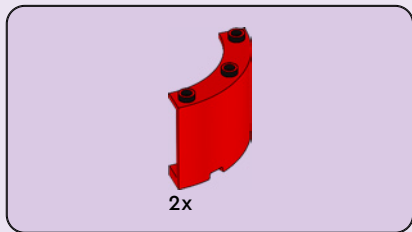

41

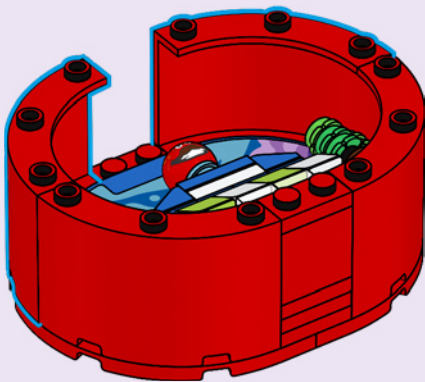
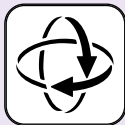



4x



1x



1x



1x

42

1

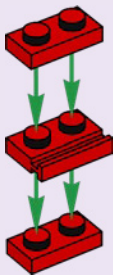

2

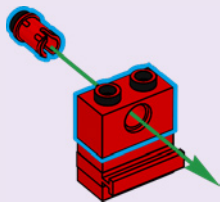

3

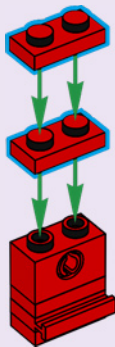

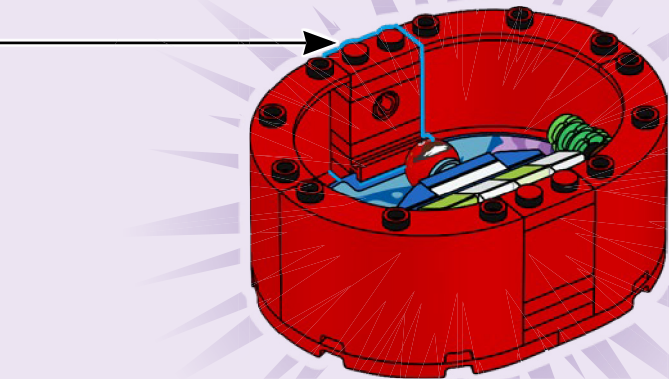

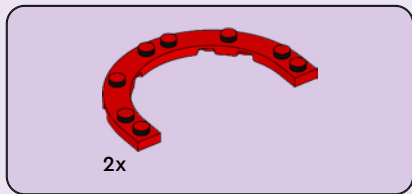

43

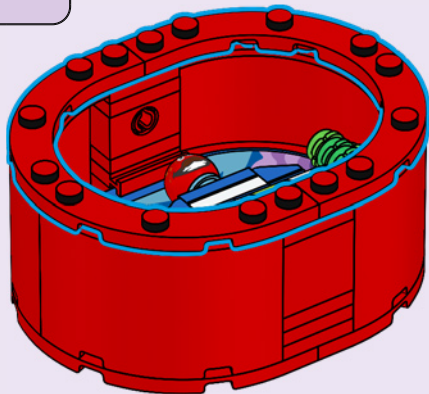



2x



4x

44

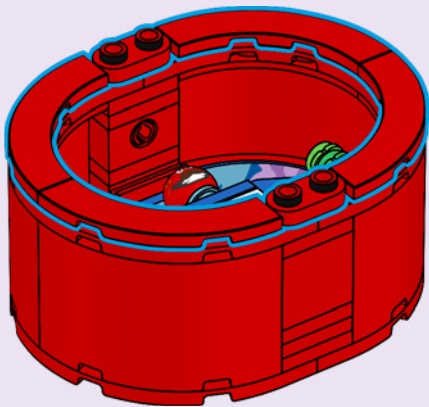

45

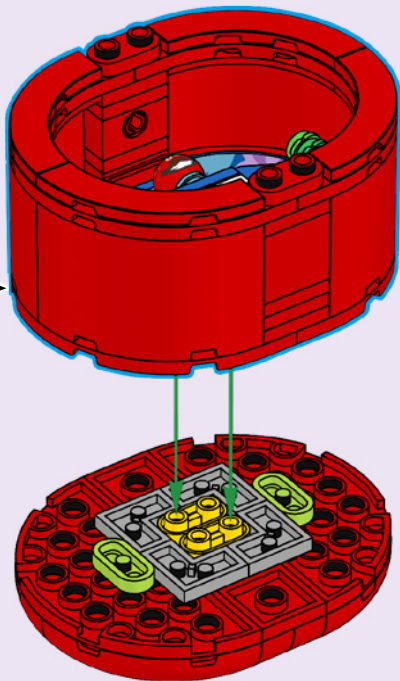



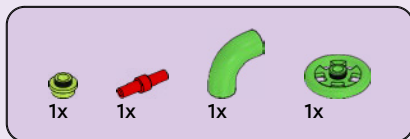

46

1

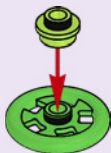

2

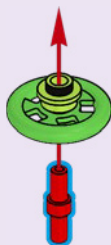

3



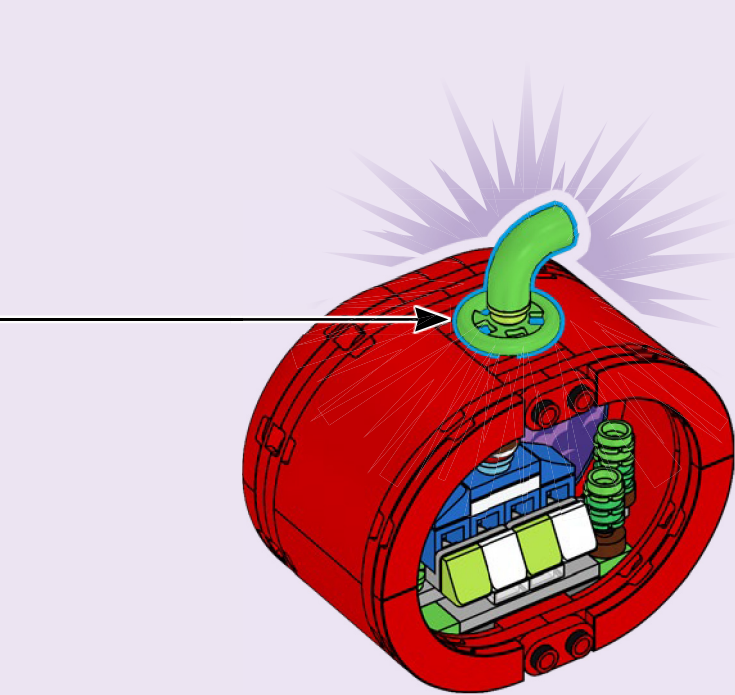



1x



1x

47

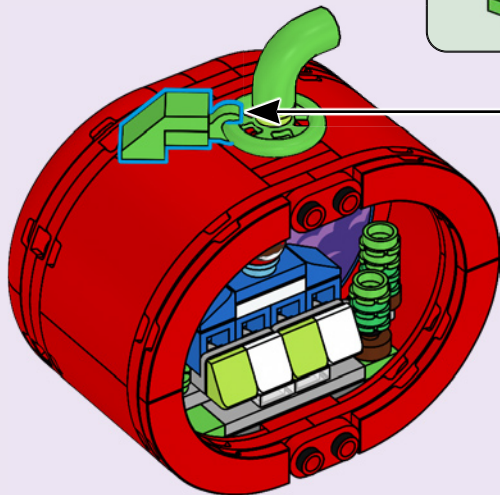
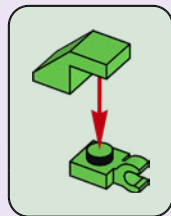



2x



2x

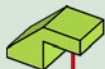

2x

48

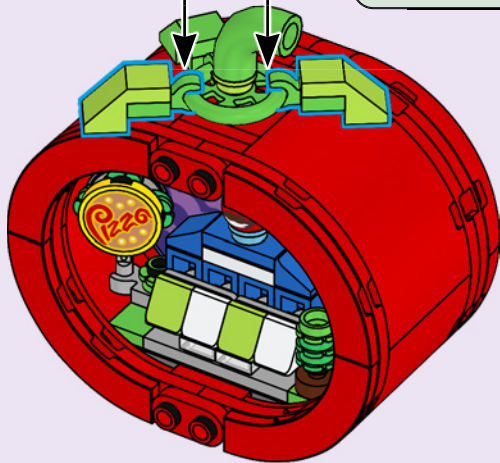



1x



1x

49

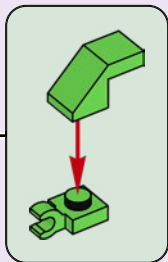
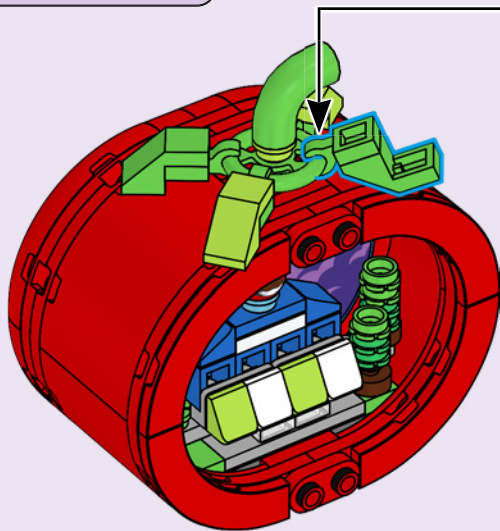

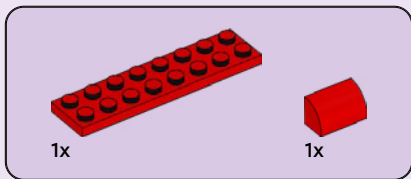

50

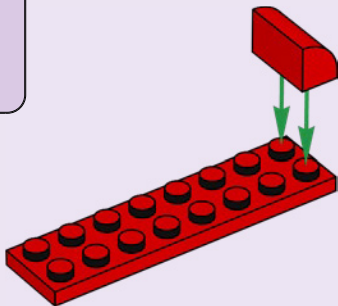

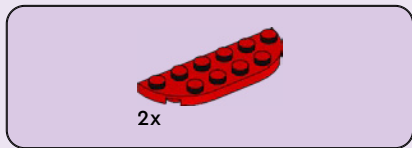

51

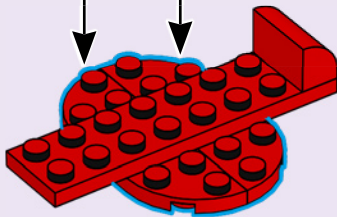
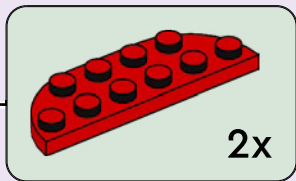

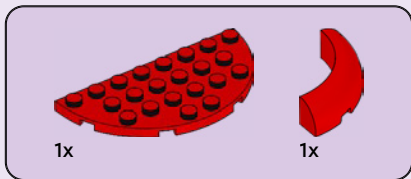

52

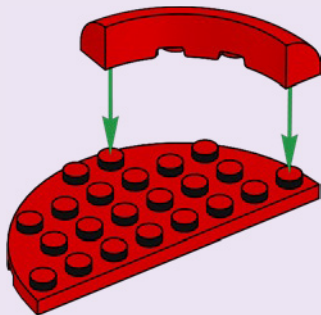

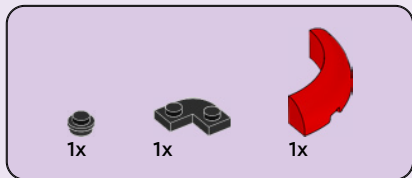

53

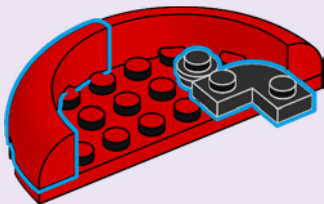

54

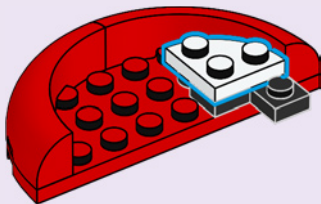



2x

55

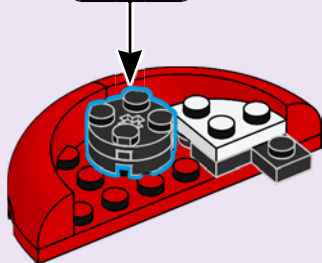
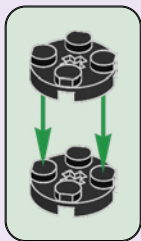



4x

56

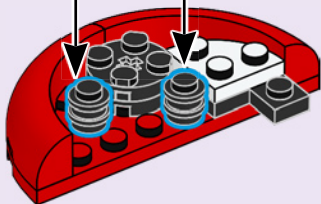
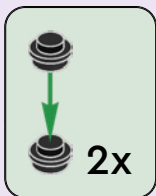

1x

57

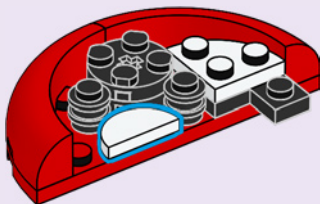



2x

58

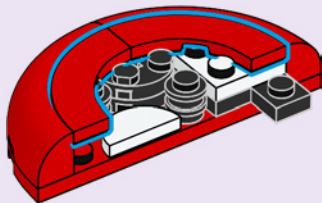

1x



1x

59

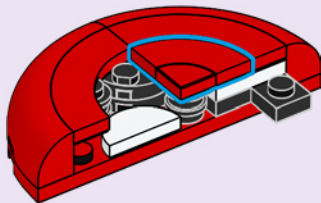

60

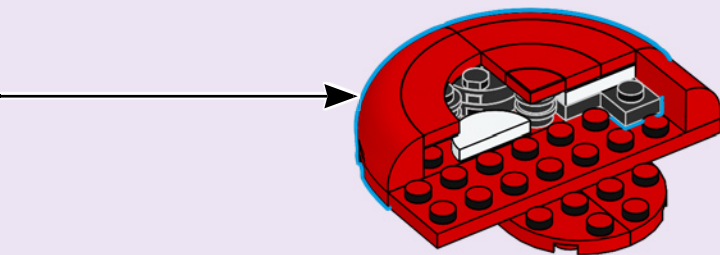



2x

61

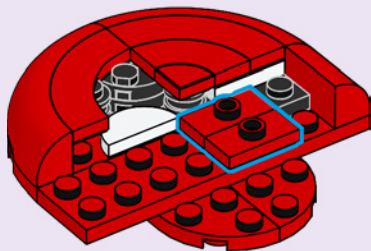

2x

62

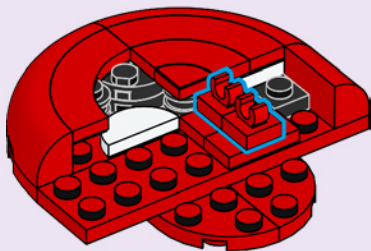

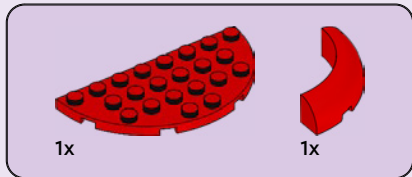
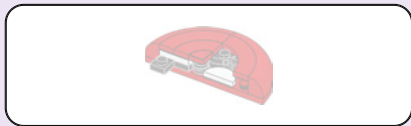

63

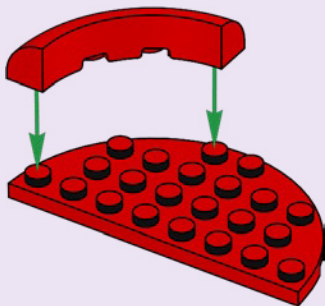

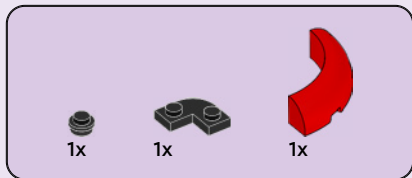

64

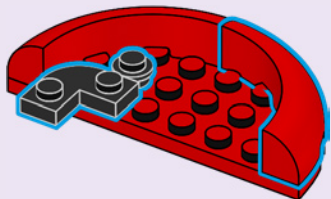

65

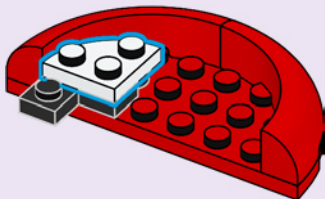



2x

66

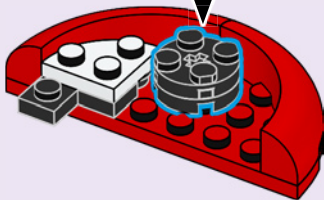
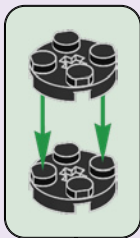



67

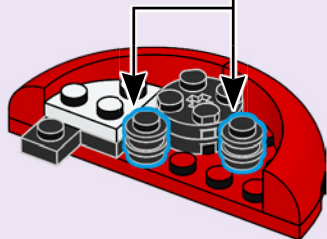
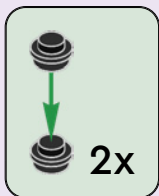

68

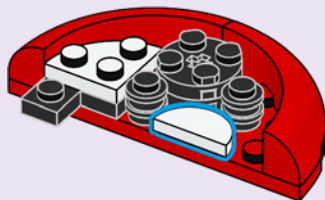



2x

69

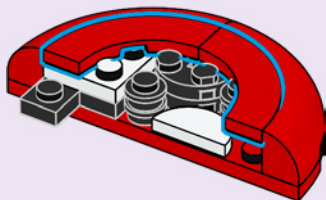

1x



1x

70

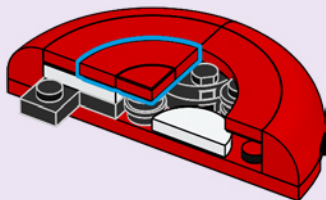

71

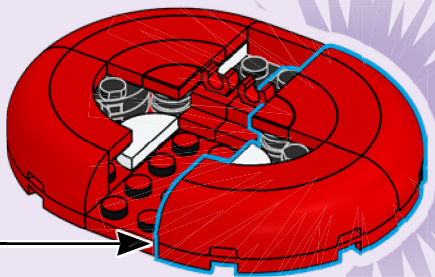



1x

72

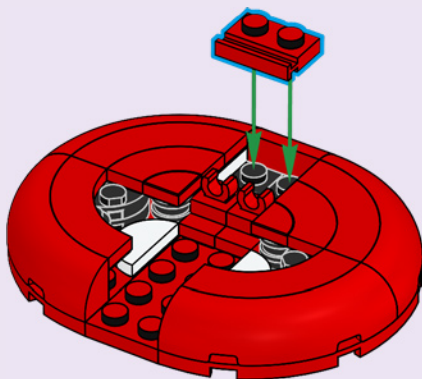



2x

73

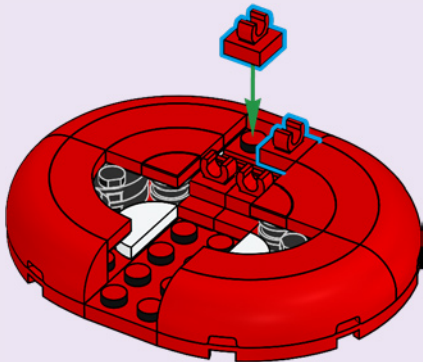



2x

74

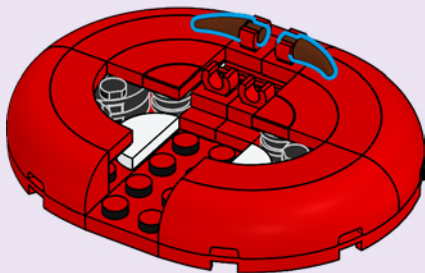



1x



2x

75

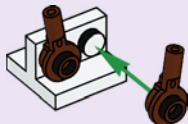

1x

76

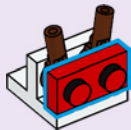



1x

77

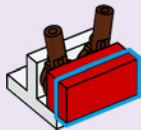

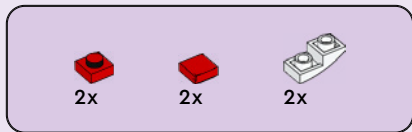

78

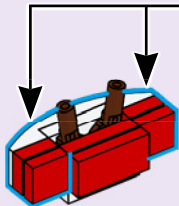
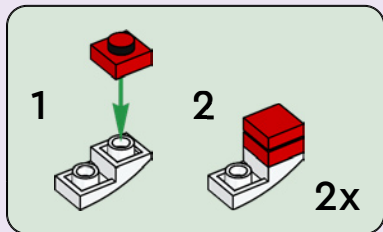

79

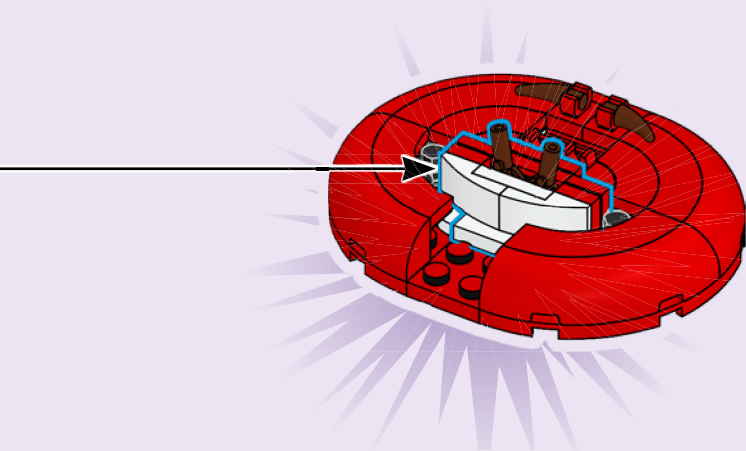



1x



2x

80

1

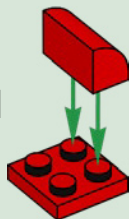

2

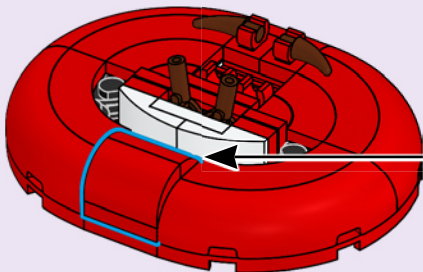
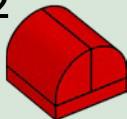

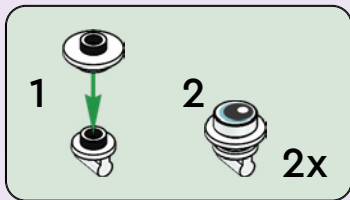
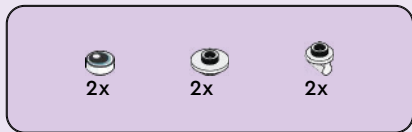

81

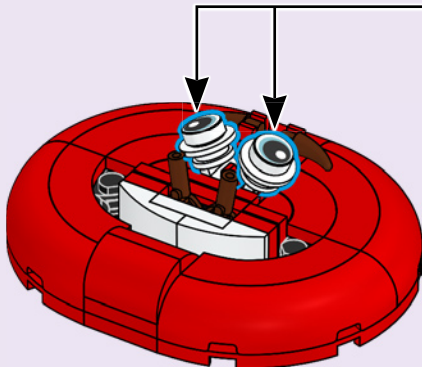

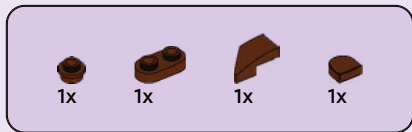

82

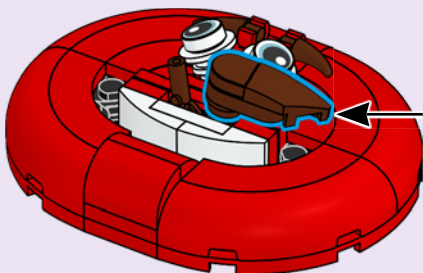
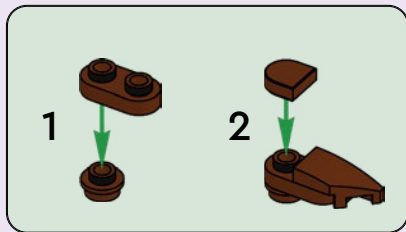

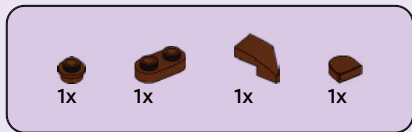

83

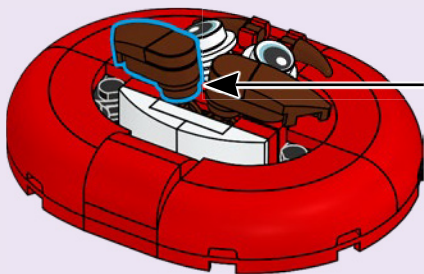
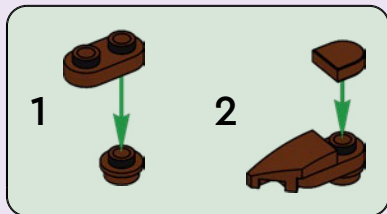

84

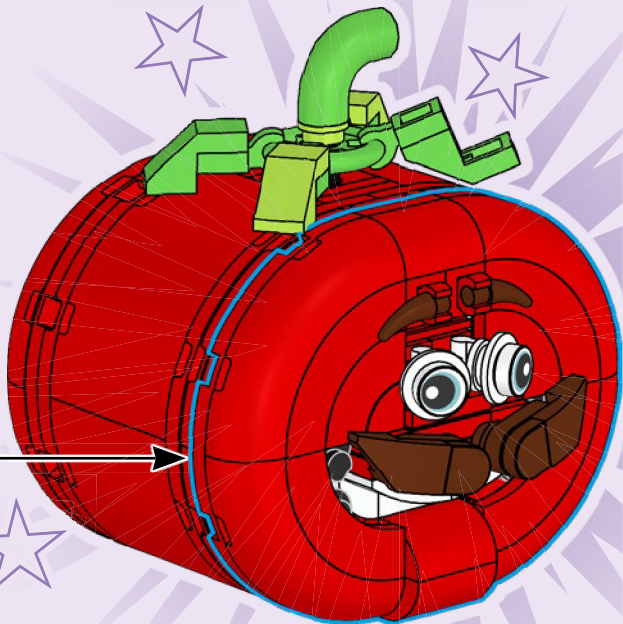



FORTNITE



77081



77080



77079



77082

2x
6485882

2x
6510221

2x
6508151

2x
4504369

2x
6510068

2x
6596745

2x
6172927

1x
6250019

78

1x
302301

6x
4140562

1x
6603593

1x
6378120

4x
6348058

2x
307021

2x
302421

2x
6170390

1x
6399645

2x
6210269

4x
6544439

3x
306921

1x
6135130

7x
302321

1x
370021

2x
6092565

3x
6252037

4x
6458177

8x
6544446

3x
4612575

3x
302221



2x
6310198

4x
6605709

8x
6375825

4x
6108802

4x
6501661

2x
303421

4x
6605710

1x
6566907

4x
407023

1x
6092582

2x
4504380

7x
6135287

4x
6206150

1x
6172375

1x
6401817

4x
6347296

1x
6526749

2x
6523383

1x
6584843

1x
6190251

2x
4504372

2x
6264062

2x
6314224

2x
6258413

2x
6173012

10x
614126

4x
403226

2x
6430580

4x
614124

2x
6529612

1x
6078279

2x
6514223

1x
4158355

1x
6290397

2x
6306775

2x
6248944

2x
6270115

4x
6296894

1x
4278273

2x
6004990

2x
6354568

1x
6227897

2x
6186673

2x
6215659

2x
6328180

1x
6290396

4x
4211353

1x
4211356

1x
4211438

2x
6344820

2x
4211063

1x
6102986

2x
6510074

2x
6097419

 [LEGO.com/service](https://www.LEGO.com/service)

YOU COULD **WIN**



Scan this QR code or go to **LEGO.COM/PRODUCTFEEDBACK** and give us your short feedback about this LEGO® set for a chance to win a cool LEGO prize.

Terms and Conditions apply*

EN: YOU COULD WIN. Terms and Conditions apply* **DE: Du könntest GEWINNEN.** Es gelten die Teilnahmebedingungen* **FR: TU POURRAIS GAGNER.** Des conditions s'appliquent* **IT: Potresti VINCERE tu.** Termini e condizioni sono applicabili* **ES: PUEDES GANAR.** Aplican términos y condiciones* **PT: PODERÁ GANHAR.** Aplicam-se Termos e Condições* **ZH: 轻松获奖.** 条款和条件适用* **PL: Szansa na WYGRANA.** Obowiązuje regulamin* **CS: Máte šanci VYHRÁT.** Platí všeobecné smluvní podmínky* **SK: Máte šancu VYHRÁŤ.** Platia všeobecné zmluvné podmienky* **HU: TE IS NYERHETSZ!** Felhasználási feltételek érvényesek* **UA: ВИ МОЖЕТЕ ВИГРАТИ.** Застосовуються загальні положення та умови* **RO: Ai putea CÂȘTIGA.** Se aplică termenii și condițiile* **BG: Можете да СПЕЧЕЛИТЕ.** Има определени правила и условия* **LV: Tu vari LAIMĒT.** Ir spēkā noteikumi un nosacījumi.* **ET: Sul on võimalus VÕITA.** Kehtivad tingimused* **LT: Jūs galite LAIMĖTI.** Taikomos sąlygos* **TR: KAZANABİLİRSİN.** Şartlar ve Koşullar geçerlidir*

*[LEGO.com/productfeedback-terms](https://www.lego.com/productfeedback-terms)

LEGO and the LEGO logo are trademarks of the/
sont des marques de commerce du/son marcas
registradas de LEGO Group. ©2026 The LEGO Group.

© 2026 Epic Games, Inc. All rights reserved.
Fortnite and its logo are trademarks of Epic
Games, Inc. in the USA (Reg. U.S. Pat. & Tm. Off.)
and elsewhere.



6650641