



FORTNITE®

77080



LEGO® Builder



LEGO.com/sustainable-packaging



FR
DONNEZ
OU
RECYCLEZ



ASSOCIATION

OU



MAGASIN

OU



DÉCHÈTERIE

Adresses sur quefairedemesdechets.fr

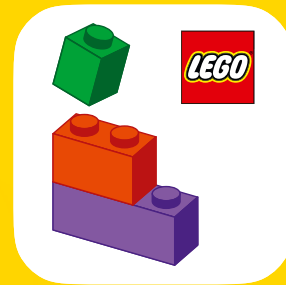

LEGO® Builder



BUILDER



Apple and the Apple logo are trademarks of Apple Inc., registered in the U.S. and other countries and regions. App Store is a service mark of Apple Inc. Google Play and the Google Play logo are trademarks of Google LLC. Tencent and the Tencent logo are trademarks of Tencent Inc.

LEGO.com/devicecheck

EN Ask parents' permission before going online | **DE** Eltern um Erlaubnis bitten, bevor du online gehst | **FR** Demande l'autorisation d'un parent avant d'aller en ligne | **IT** Chiedi il permesso ai tuoi genitori prima di andare online | **ES** Pídeles permiso a tus papás antes de conectarte a Internet | **PT** Pede autorização aos teus pais antes de ficares online | **ZH** 上网前应先征得父母的同意 | **PL** Poproś rodziców o zgodę, zanim wejdiesz do Internetu | **CS** Než půjdeš na internet, požádej rodiče o svolení | **SK** Skôr než pôjdeš na internet, vypýtaj si povolenie od rodičov | **HU** Kérj szülői engedélyt, mielőtt online csatlakoznál! | **UA** Запитуйте дозволу батьків, перш ніж користуватися інтернетом | **RO** Cere permisiunea părinților înainte de a te conecta online | **BG** Поискайте разрешение от родител, преди да влезете онлайн | **LV** Pirms došanās tiešsaistē palūdz atļauju vecākiem | **ET** Enne Interneti kasutamist küsi vanematelt luba | **LT** Prieš prisijungdami prie interneto, atsiklauskite tėvų | **TR** İnternete girmeden önce anne babandan izin iste

LEGO**FORTNITE**®**REDEEM YOUR BONUS
IN-GAME DECOR PACK!**

Offer not available in China

**1 Scan the QR code
and follow the steps**

REDEEM YOUR BONUS IN-GAME DECOR PACK!
 HOL DIR DEIN IN-GAME DEKO-PAKET ALS BONUS!
 RÉCUPÉREZ VOTRE PACK DÉCO IN-GAME BONUS!
 RISCATTA IL TUO PACCHETTO DI DECORAZIONI BONUS IN-GAME!
 ¡CAN JEA TU PACK DE DECORACIÓN DE REGALO PARA EL JUEGO!
 RESGATE O SEU PACK DE DECORAÇÃO NO JOGO DE BÔNUS!
 兑换游戏中奖励的装饰包吧!
 ODBIERZ SWÓJ BONUSOWY PAKIET DEKORACJI DO GRY!
 VYUŽIJTE SVŮJ BONUS V PODOBĚ BALÍČKU DEKORACE DO HRY!
 UPLATNITE BONUSOVÝ BALÍČEK DOPLNKNO VO VIDEOHRE!
 VÁLTSD BE A BÓNUSZ KJEGÉSZÍTŐIDET A VIDEOJÁTÉKBAN!
 АКТИВИРУЙТЕ СВОЙ ДЕКОРАТИВНИ ЕЛЕМЕНТИ!
 REVENDICÁ-TE SERIA DECORATIVÁ BONUS DIN JOS!
 ВЗЬМЕТЕ БОНУСНИА СИ ПАКЕТ С ДЕКОРАЦИИ В ИГРТА!
 IZMANTO SAVU SPĚLES BONUSA DEKORU PAKU!
 LUNASTA OMA MĀNGUSISENE BOONUS: KAUNISTUSPAKKI
 GAUKITE PREMIJĄ – ŻĄDIMO DEKORO RINKIN!
 BONUS OYUN İÇİ DEKOR PAKETİNİZİ ALIN!

Offer not available in China
 Das Angebot ist in China nicht verfügbar
 Offre non disponible en Chine
 Offerta non disponibile in Cina
 Oferta no disponible en China
 Oferta não disponível na China
 中国は対象外です
 优惠不适用于中国
 중국에서는 본 제안이 적용되지 않습니다
 Oferta nie jest dostępna w Chinach
 Nabídka neplatí v Číně
 Ponuka nie je k dispozícii v Číne
 Az ajánlat Kínában nem érhető el.
 Пропозиция недоступна в Китай
 Oferta nu este disponibilă în China
 Предложението не е налично в Китай
 Piedāvājums nav pieejams Ķīnā
 Pakkumīne pole Hiinas saadaval
 Pasiūlymas nepasiekiamas Kinijoje
 Kampanya, Çin'de geçerli değildir

- 1 Scan the QR code and follow the steps
- 1 Scanne den QR-Code und folge der Anleitung
- 1 Scannez le QR code et suivez ces étapes
- 1 Scansiona il codice QR e seguì i passaggi
- 1 Escanea el código QR y síguelos pasos
- 1 Faça scan do código QR e siga os passos
- 1 扫描二维码并按步骤操作
- 1 Zeskanuj kod QR i wykonaj opisane kroki
- 1 Naskenujte QR kód a postupujte podle návodu
- 1 Naskenujte QR kód a postupujte podľa pokynov
- 1 Olvasd be a QR-kódot és kövesd a lépéseket!
- 1 Просканируйте QR-код та виконайте дії
- 1 Scanează codul QR și urmează pașii
- 1 Сканируйте QR кода и следвайте стъпките
- 1 Skenē QR kodu un veic šīs darbības
- 1 Skaneeri QR-kood ja järgi edasisi samme
- 1 Nuskaitykite QR kodą ir atlikite reikiamus veiksmus
- 1 Karekodu tarayın ve adımları izleyin

Ask parents' permission before going online



Ask parents' permission before going online
Eltern um Erlaubnis bitten, bevor du online gehst
Demande l'autorisation d'un parent avant d'aller en ligne

Chiedi il permesso ai tuoi genitori prima di andare online

Pideles permiso a tus papás antes de conectarte a Internet

Pede autorização aos teus pais antes de ficares online

上网前应先征得父母的同意

Poproś rodziców o zgodę, zanim wejdziesz do Internetu

Než půjdeš na internet, požádej rodiče o svolení

Skôr než pôjdeš na internet, vypýtaj si povolenie od rodičov

Kérj szülői engedélyt, mielőtt online csatlakoznál!

Запитуйте дозволу батьків, перш ніж користуватися інтернетом
Cere permisiunea părinților înainte de a te conecta online

Поискайте разрешение от родител, преди да влезете онлайн

Pirms došanās tiešsaistē palūdz atļauju vecākiem

Enne Interneti kasutamist küsi vanematelt luba

Prieš prisijungdami prie interneto, atsiklauskite tėvų

Internetne girmeden önce anne babandan izin iste

Terms and Conditions apply

2 Sign in/up and claim your code to redeem

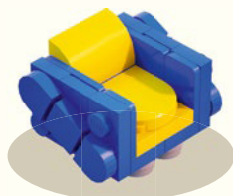

Get Code



Terms and Conditions apply
Es gelten die Teilnahmebedingungen.
Offre soumise à conditions
Termini e condizioni sono applicabili
Sujeto a Términos y Condiciones
Aplicam-se Termos e Condições
《条款和条件》适用
Obowiązuje Regulamin
Platí všeobecné smluvní podmínky

Platia všeobecné zmluvné podmienky
A Felhasználási feltételek érvényesek.
Застосовуються Умови та положення
Se aplică termene și condiții
Прилагат се правила и условията
Ir spēkā noteikumi un nosacījumi
Kehtivad tingimused
Taikomos sąlygos
Şartlar ve Koşullar geçerlidir

Get Code / Code erhalten / Obtenir le code / Ottieni il codice / Obter código / Obter código / 获取编号 / Zdobądź kod / Získat kód / Získat kód / Kérem a kódot / Отримати код / Obține codul / Вземете код / Saņemt kodu / Hangi kood / Gaukiete kodą / Kodu Al

- 2 Sign in/up and claim your code to redeem
- 2 Melde dich an/logge dich ein und hol dir deinen Code
- 2 Inscris-toi/connecte-toi et demande ton code bonus
- 2 Accedi/registrati e richiedi il tuo codice per riscattarlo
- 2 Inicia sesión/regístrate para recibir tu código y canjearlo
- 2 Registe-se ou inicie sessão e peça o seu código para resgatar
- 2 登录/注册并申请代码进行兑换
- 2 Zarejestruj się lub zaloguj i odbierz swój kod
- 2 Zaregistrujte se/přihlaste se a uplatněte svůj kód
- 2 Přihlaste sa alebo si vytvorte účet a uplatnite svoj kód
- 2 Jelentkezz be/Regisztrálj, és igényeld a kódot a beváltáshoz!
- 2 Увійдіть/зареєструйтеся та отримайте свій код активації
- 2 Conectează-te/Înregistrează-te și revendică-ți codul pentru a-l folosi
- 2 Влезте в профила си/регистрайте се и потърсете вашия код, за да вземете
- 2 Piesakies/registrējies un saņem kodu, lai izmantotu
- 2 Liitu / logi sisse ja hangi lunastamiseks kood
- 2 Prisijunkite / užsiregistruokite ir gaukite kodą
- 2 Oturum açın/kaydolun ve kodunuzu alın

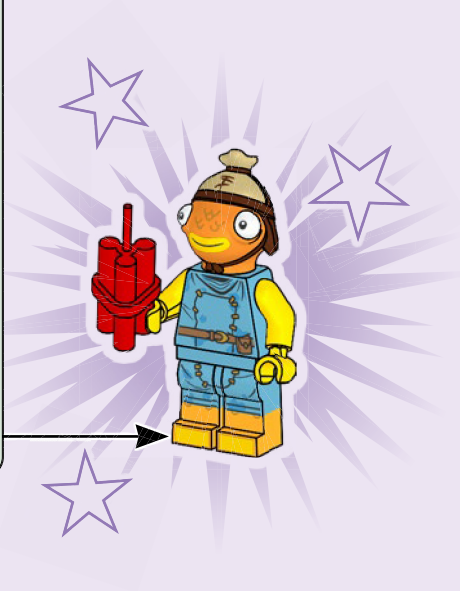
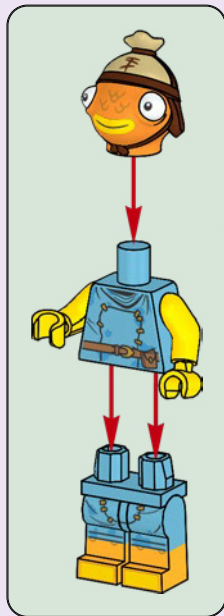
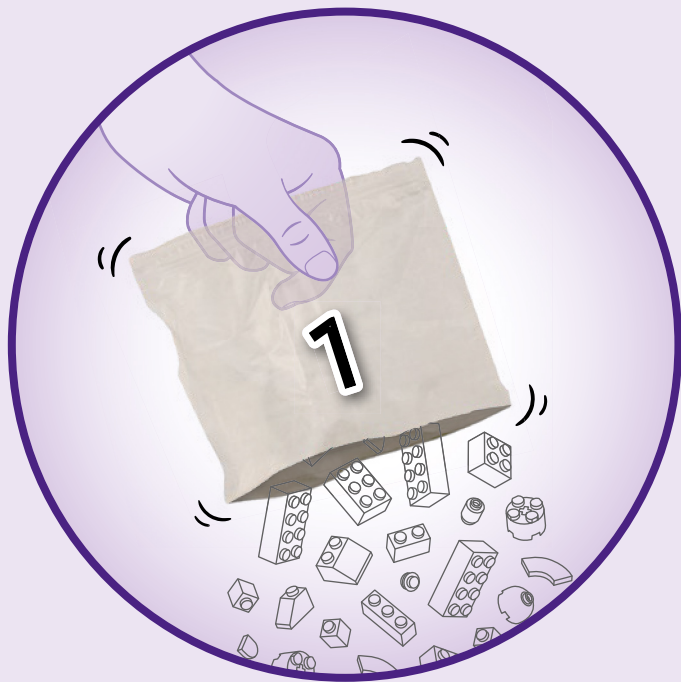

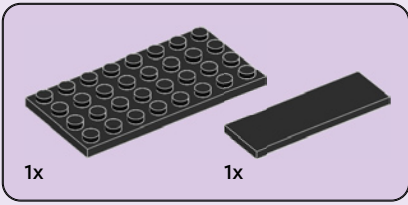

1

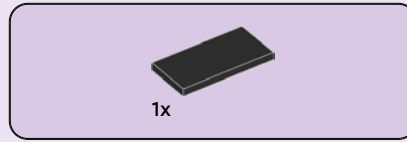
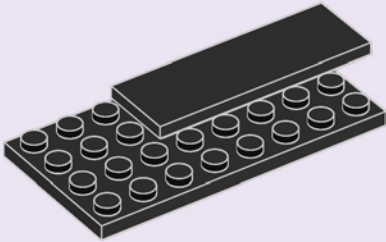

2

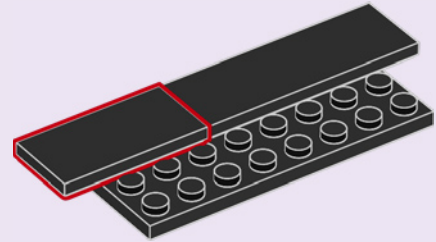

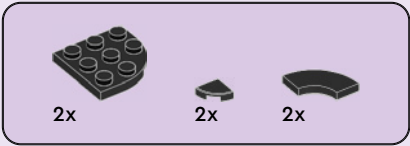

3

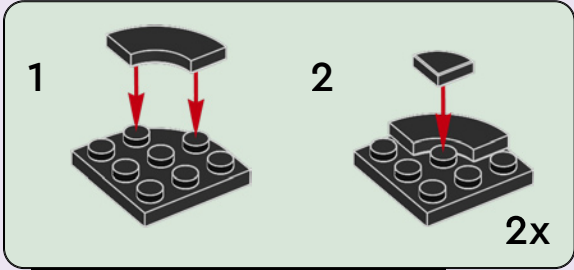

2

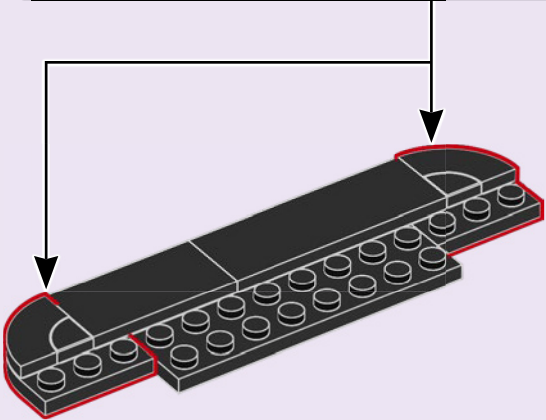
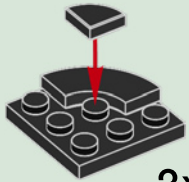

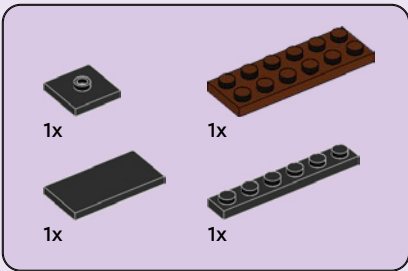

4

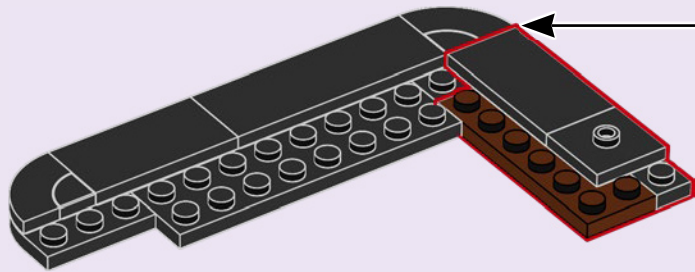
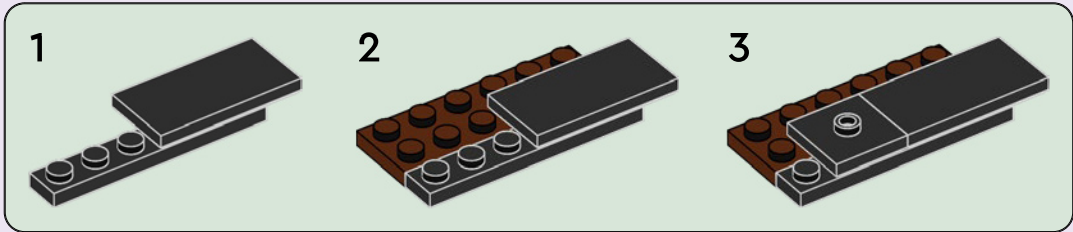

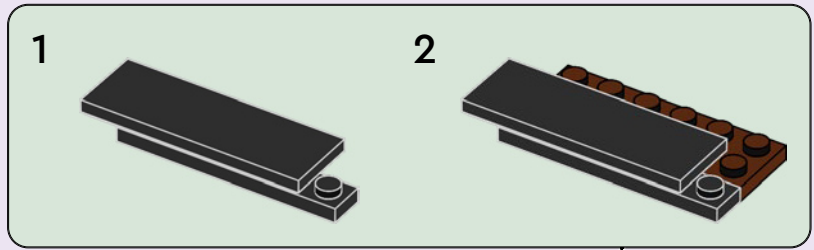
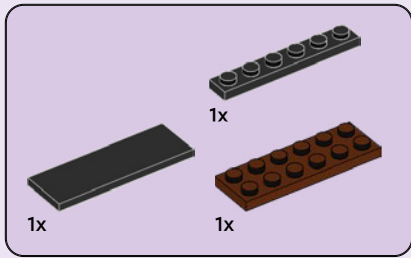

5

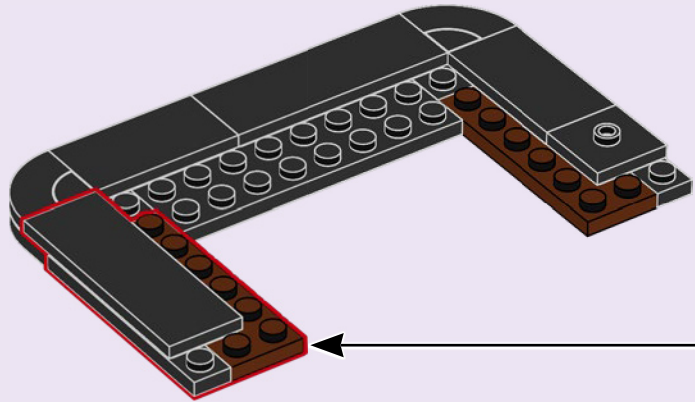



2x

6

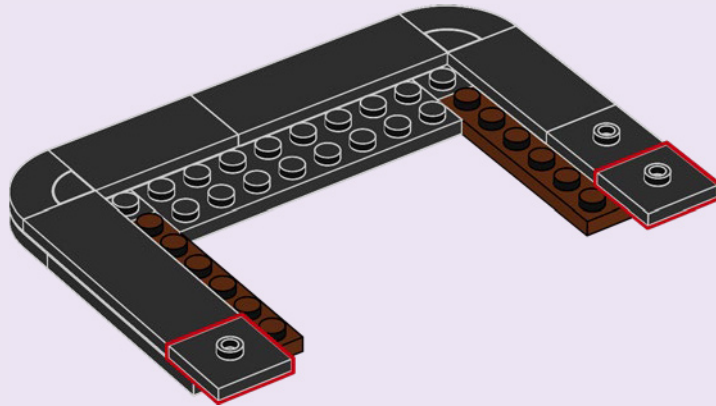

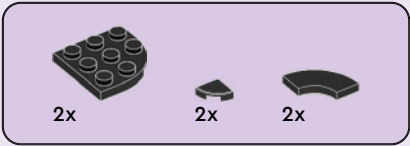

7

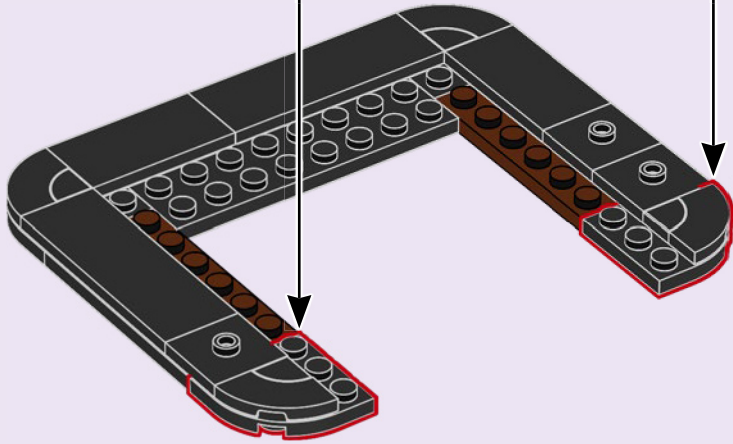
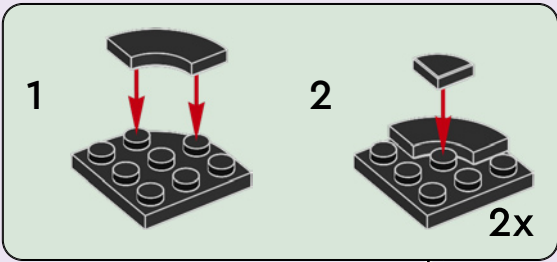

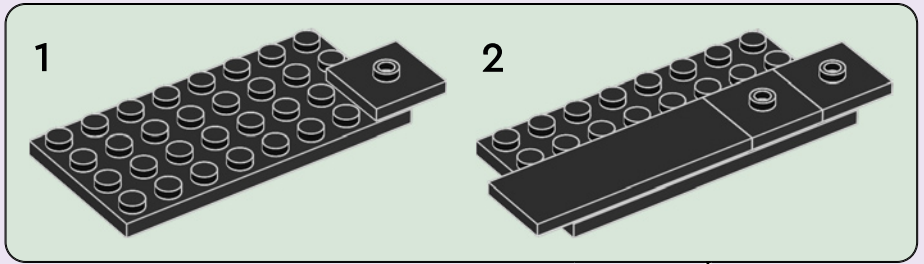
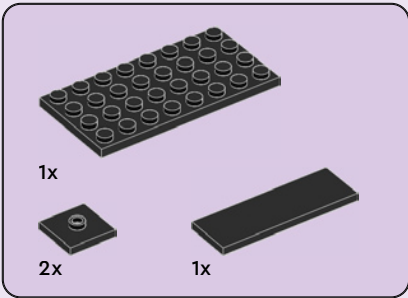

8

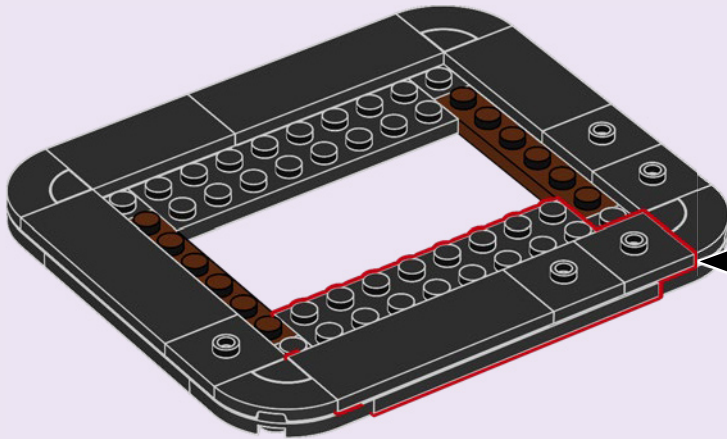

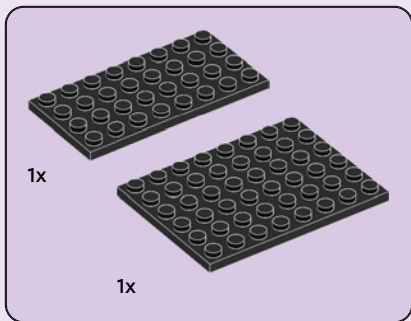

9

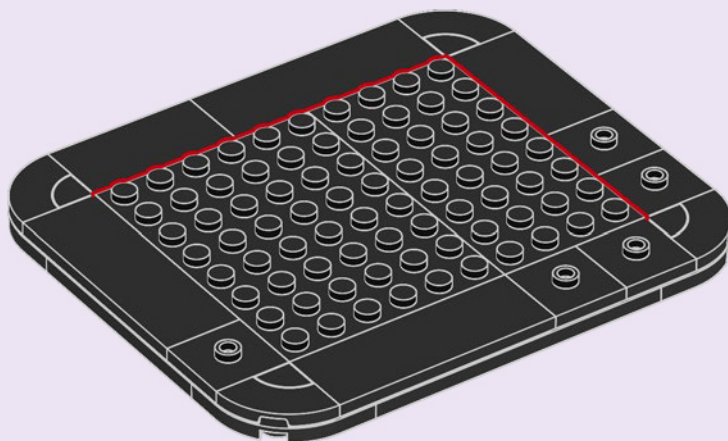

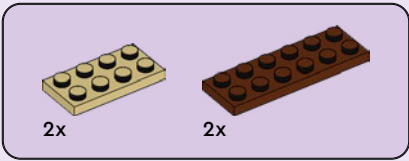

10

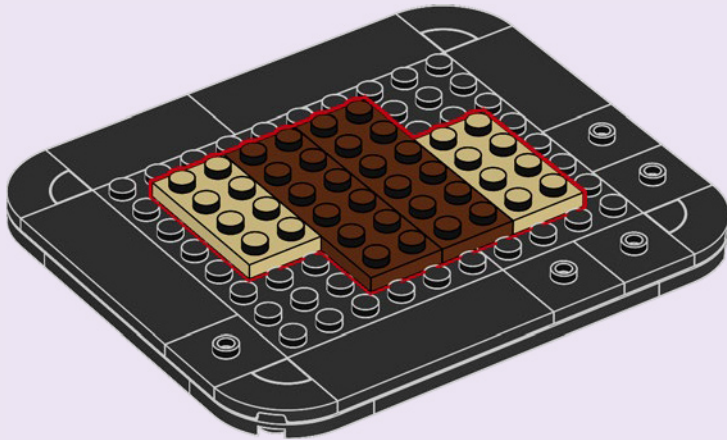

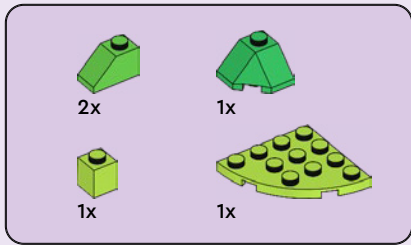

11

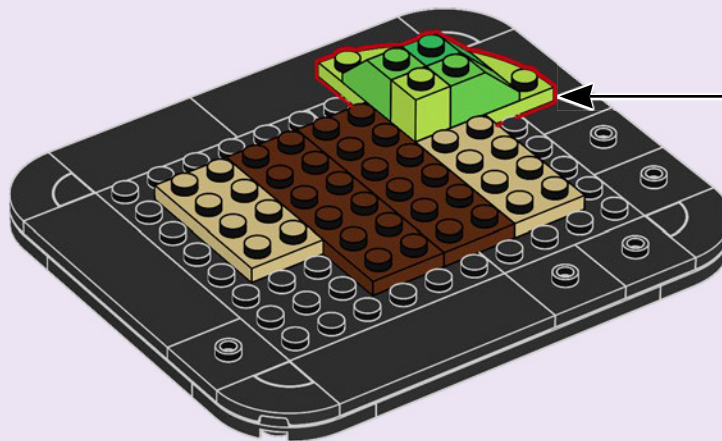
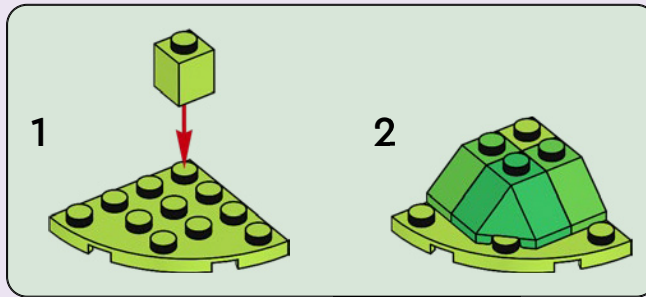

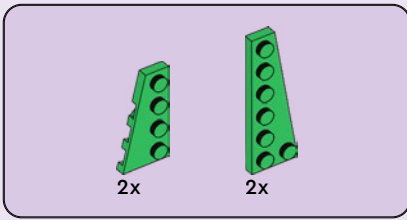

12

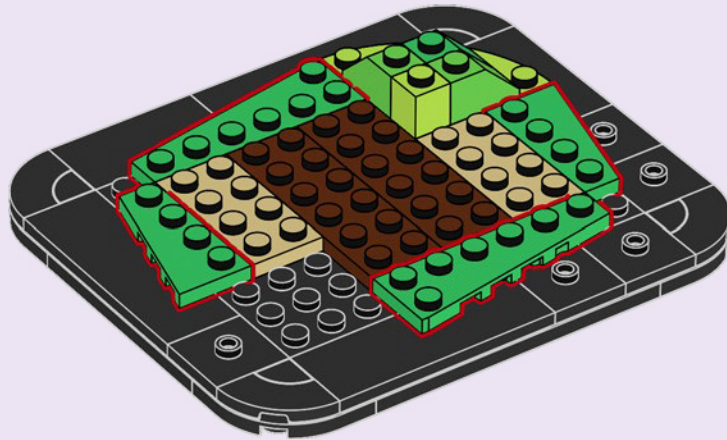



2x

13

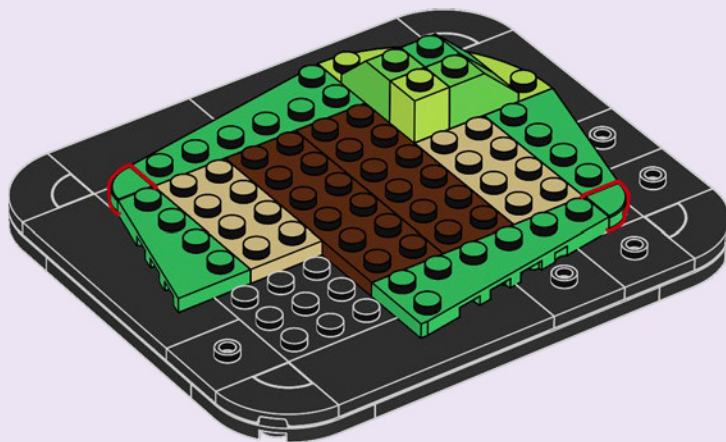



1x

14

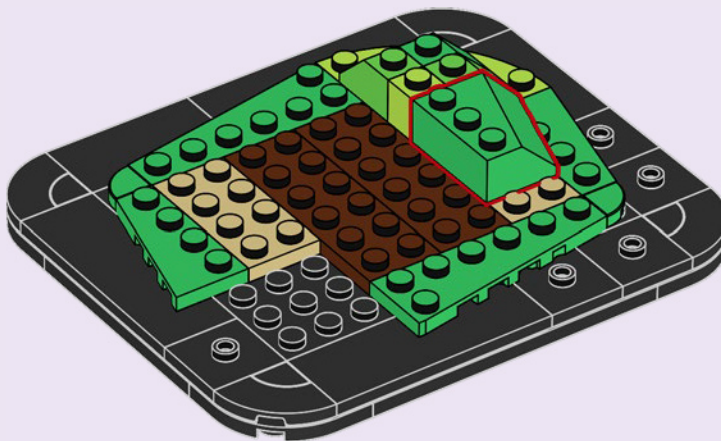

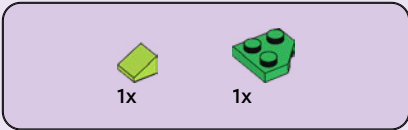

15

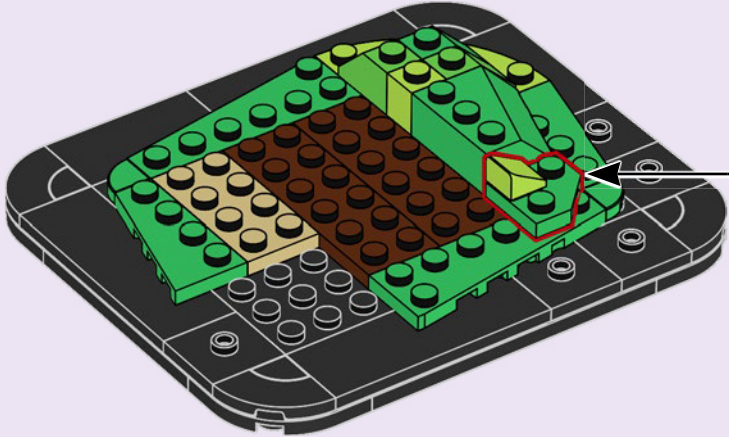
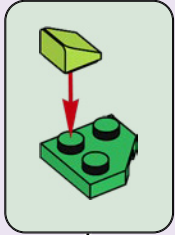

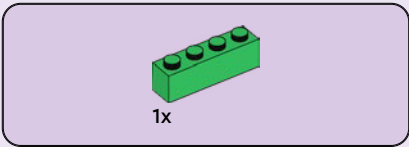

16

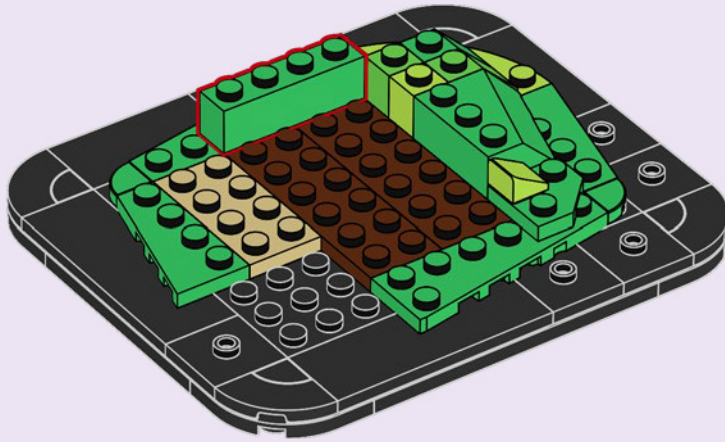



1x

17

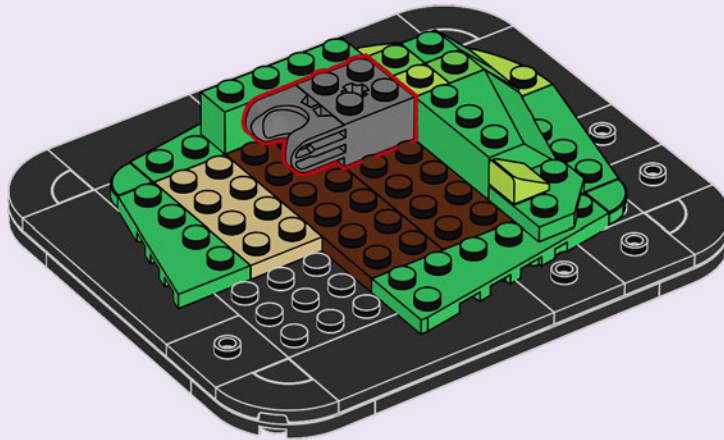

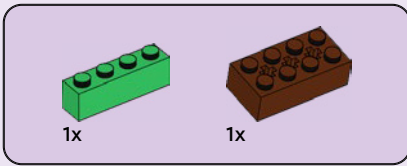

18

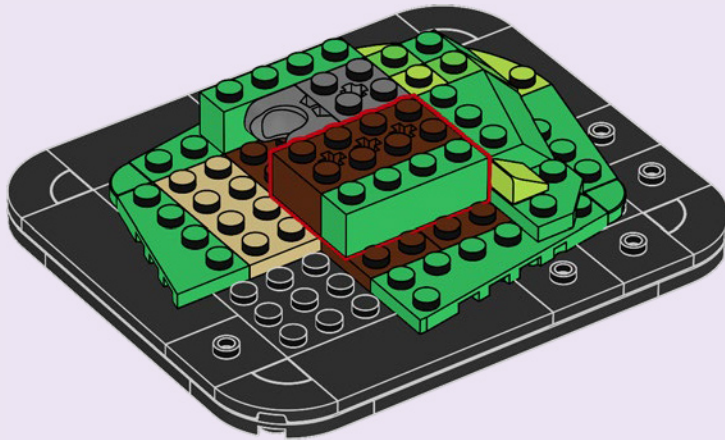

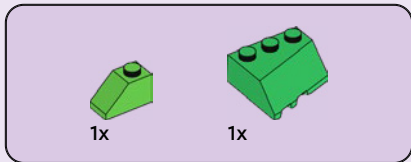

19

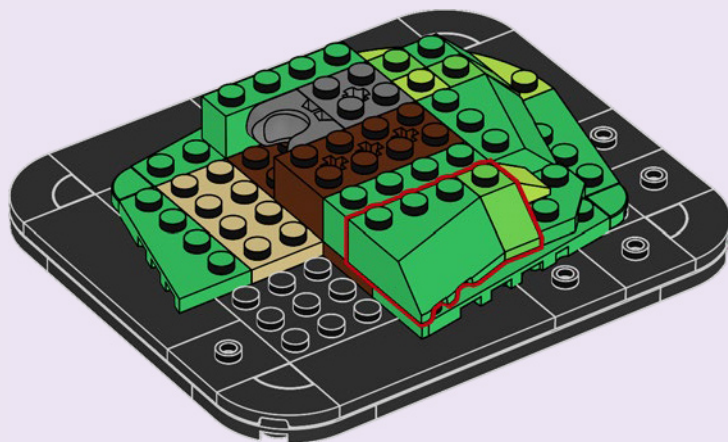

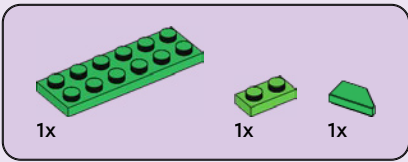

20

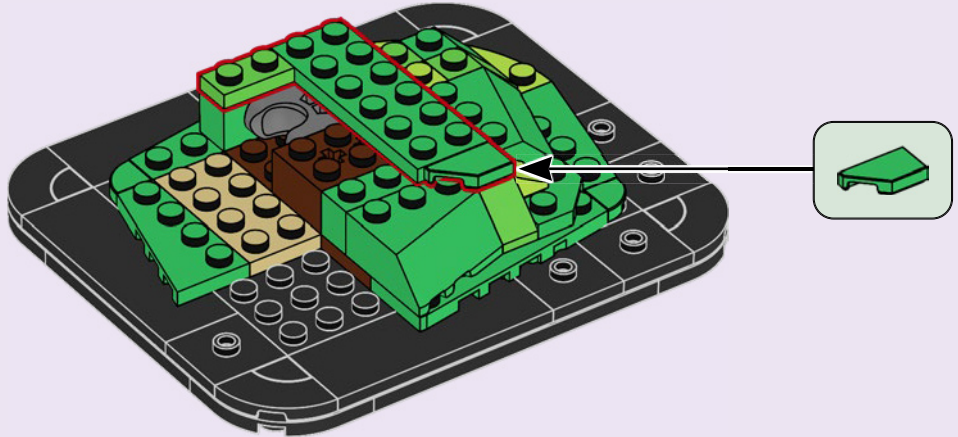

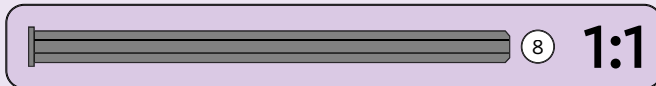
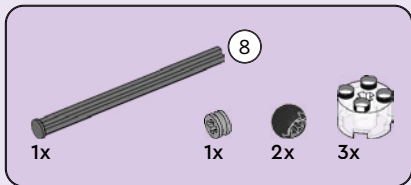

21

1

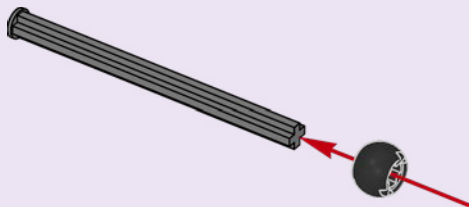

2

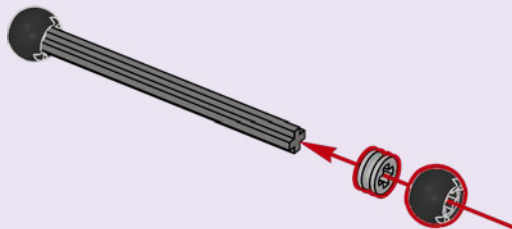

3

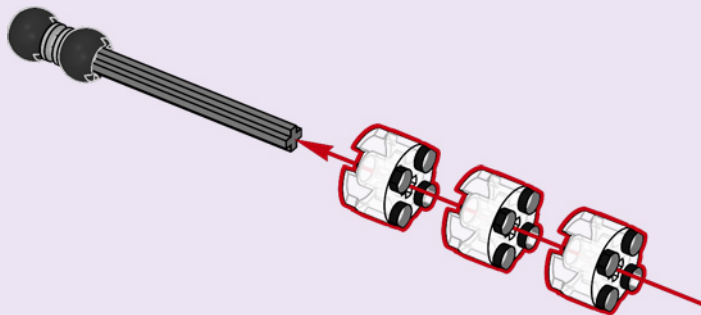

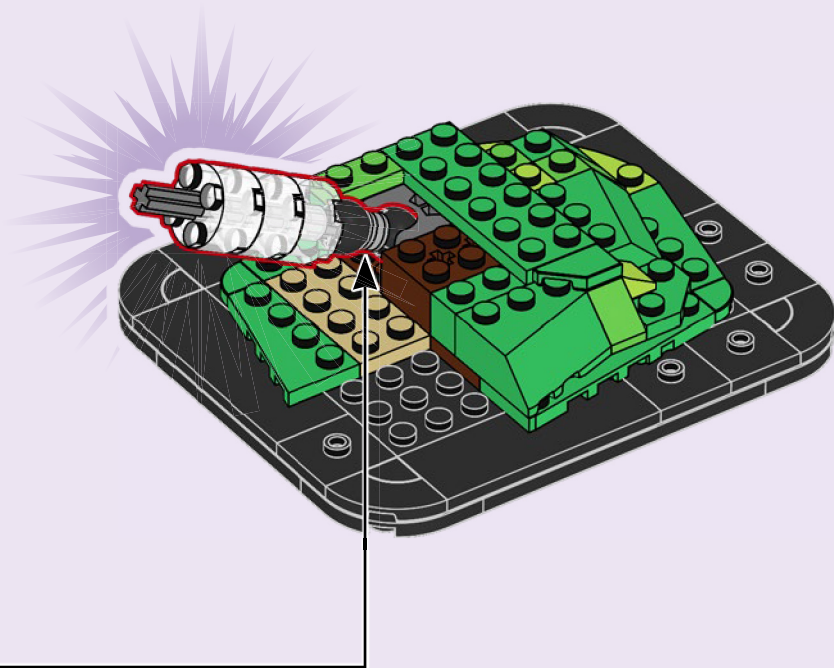

22

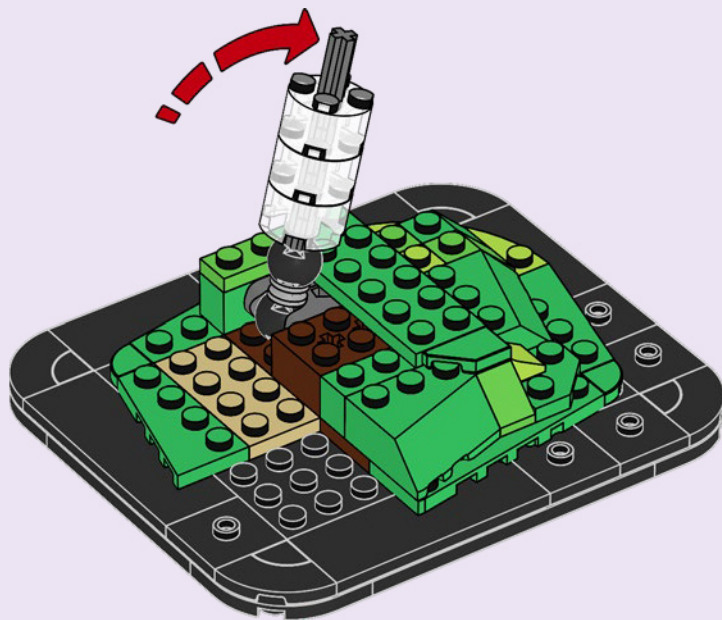

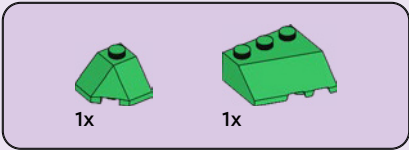

23

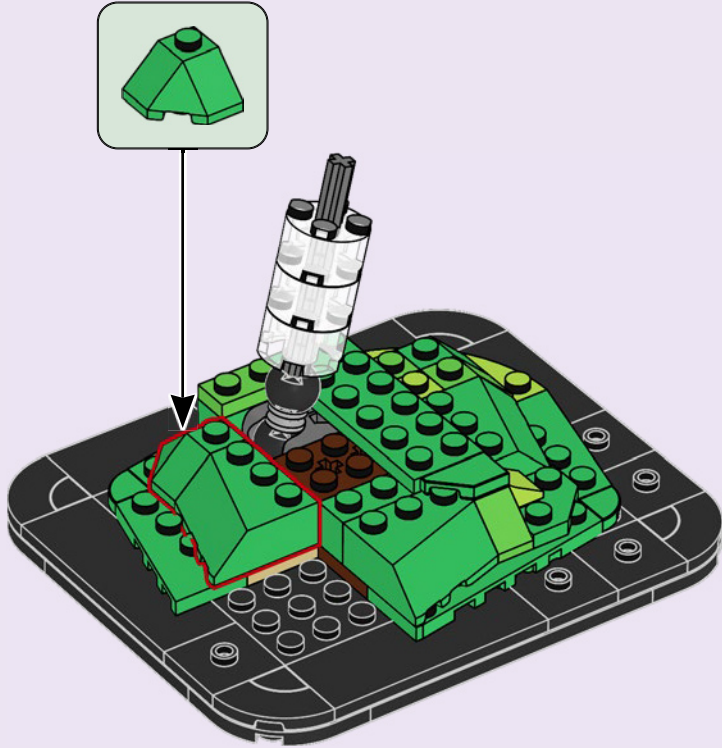

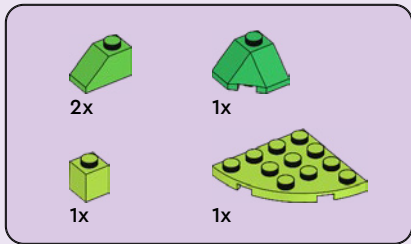

24

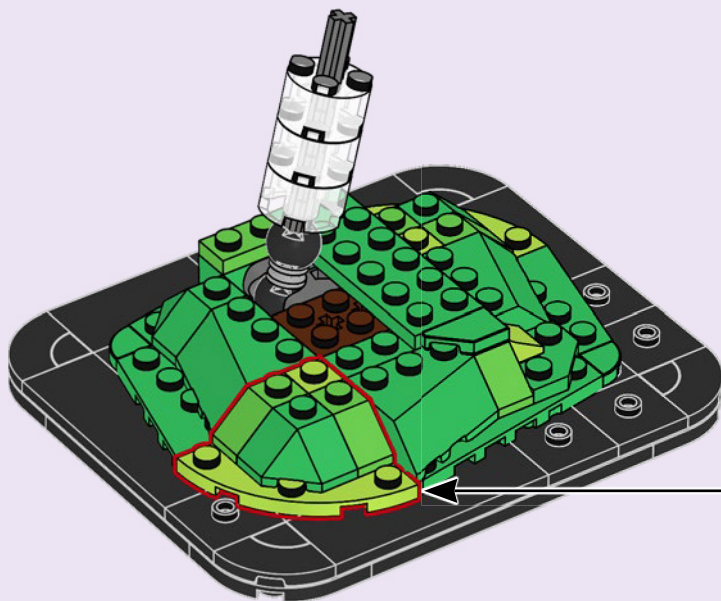
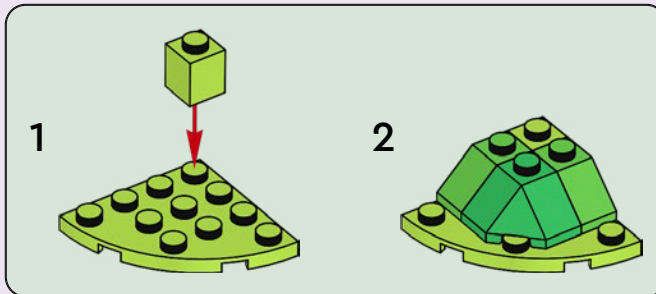



1x



1x

25

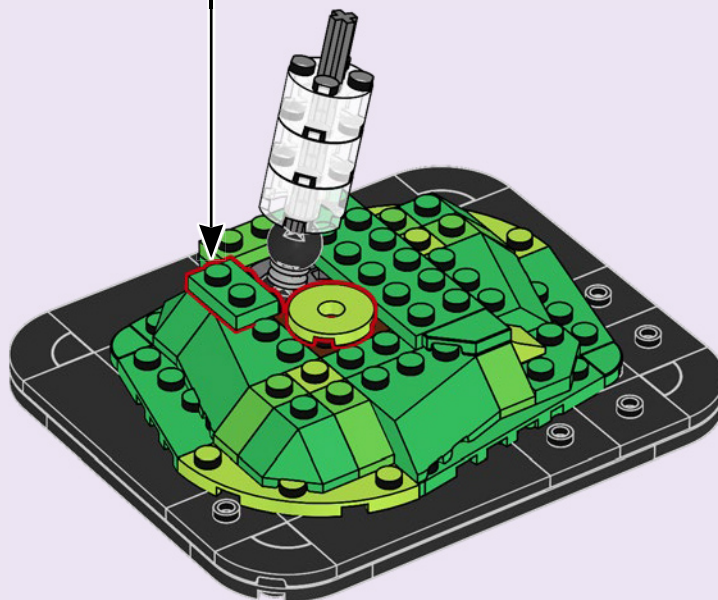
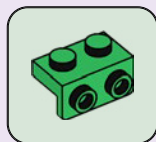



1x



2x

26

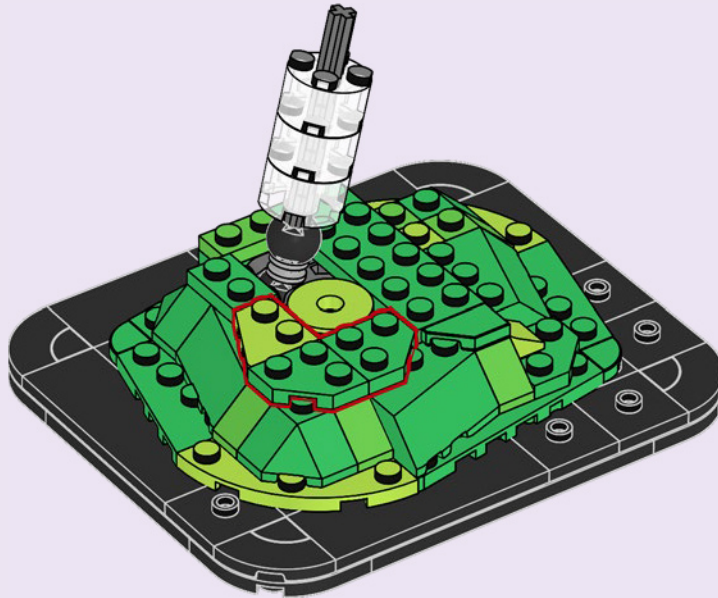

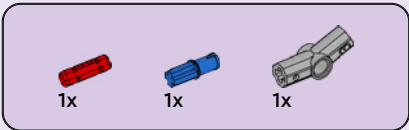

27

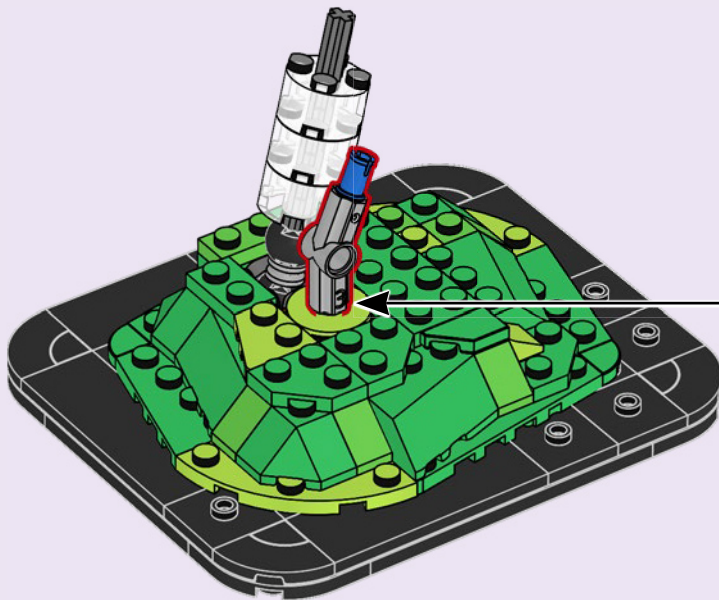
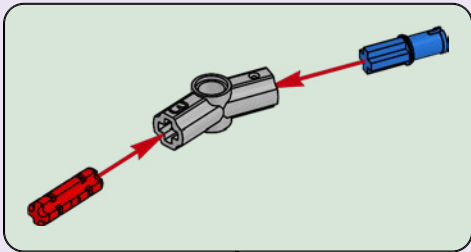



1x

28

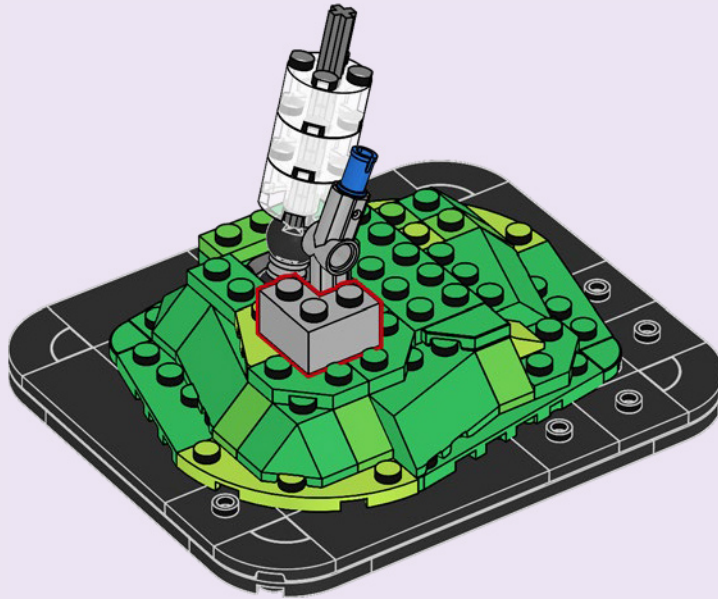



3x

29

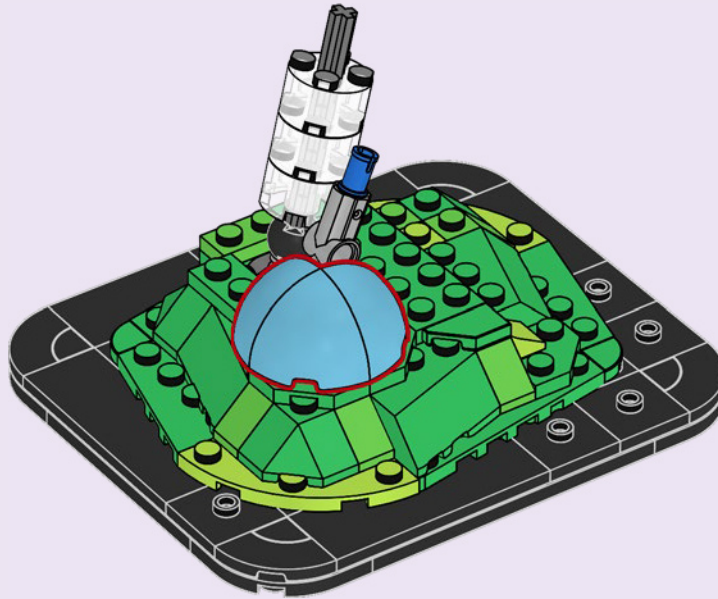



3x



3x

30

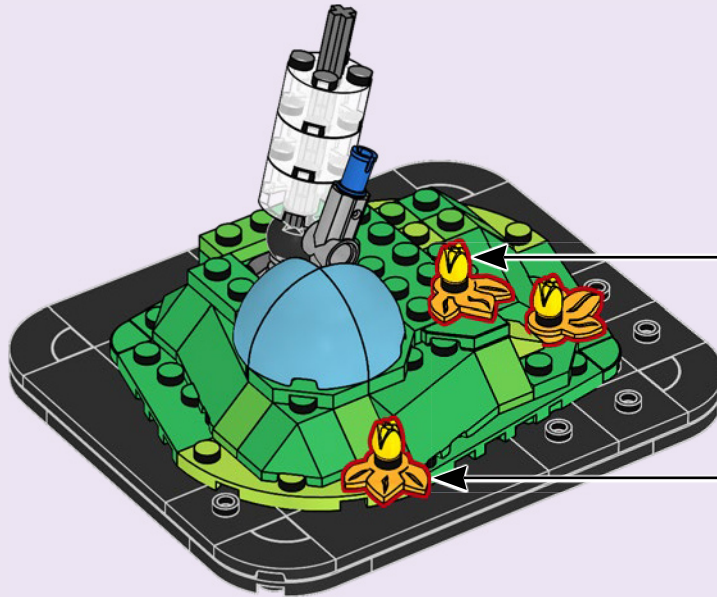

3x



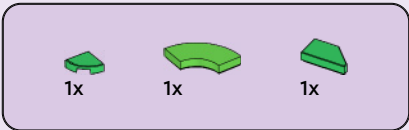

31

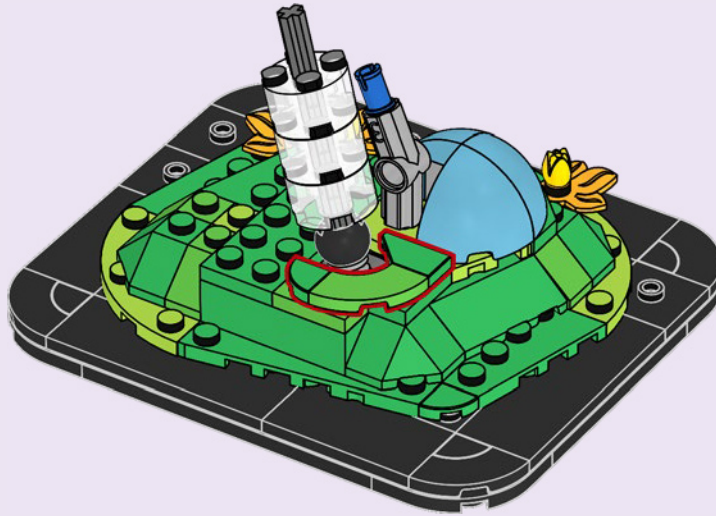

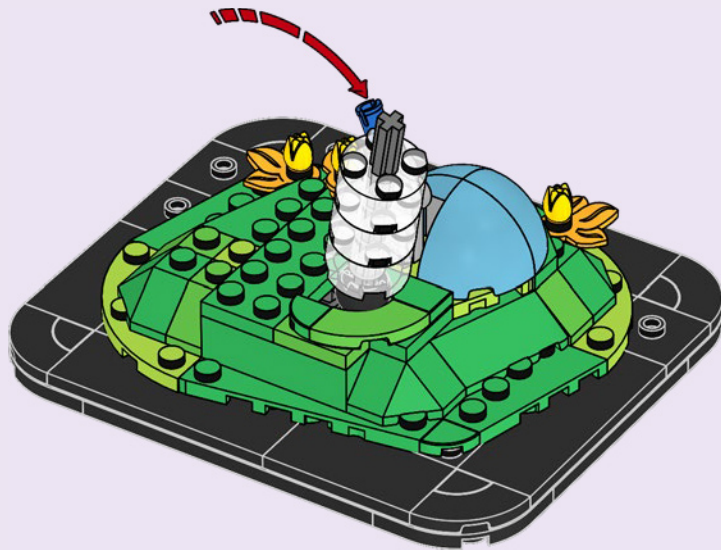

1x

1x

33

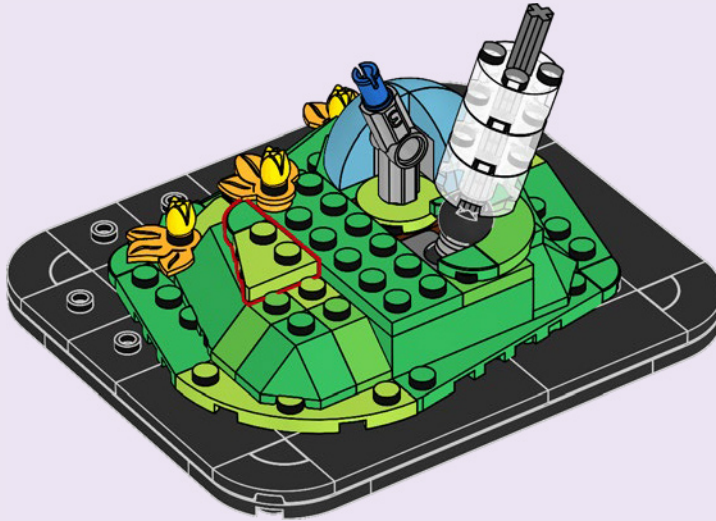

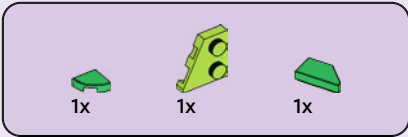

34

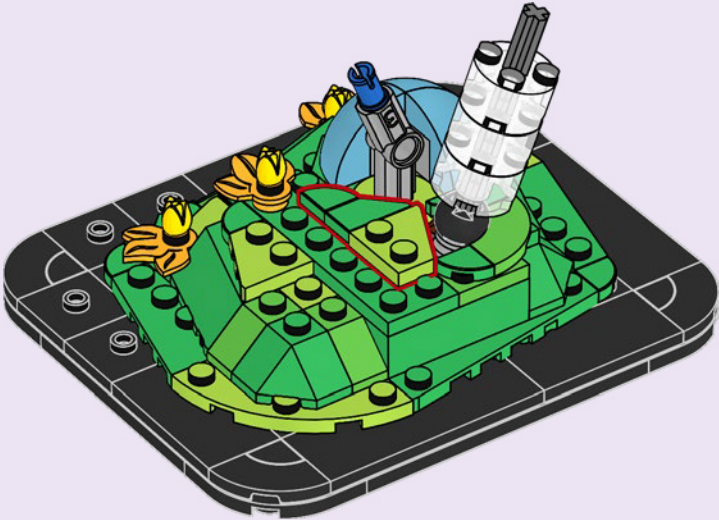

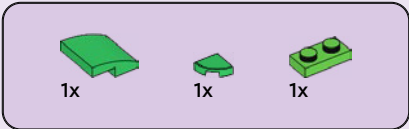

35

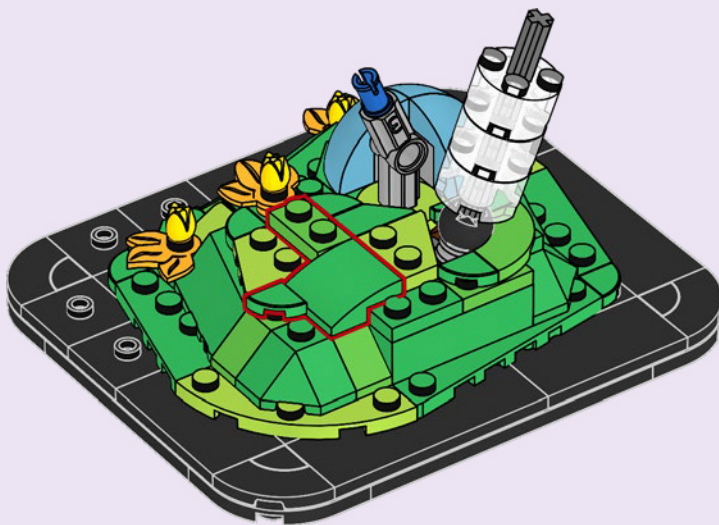

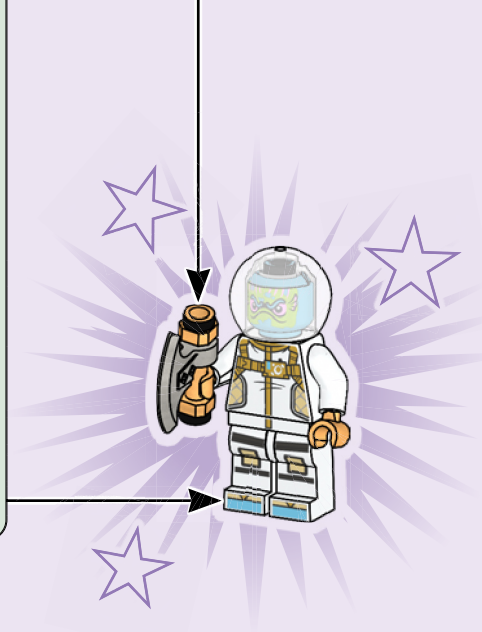
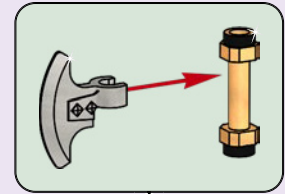
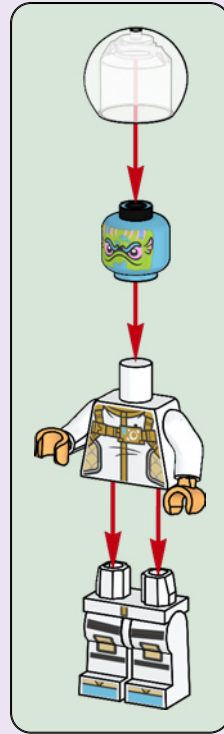

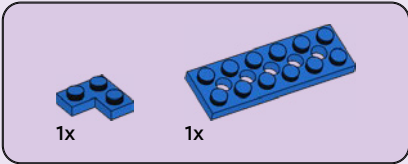
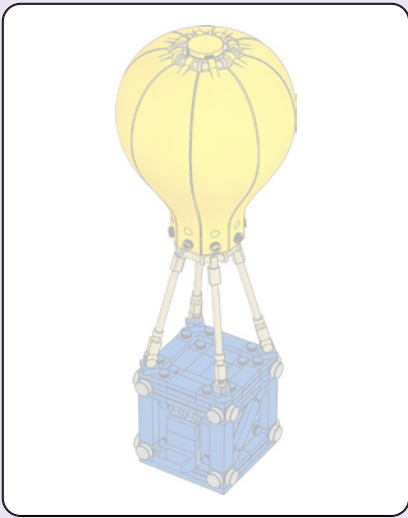

36

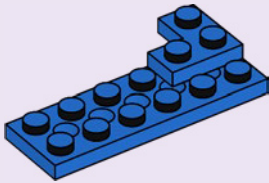

37

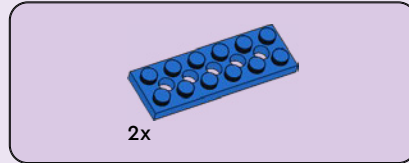
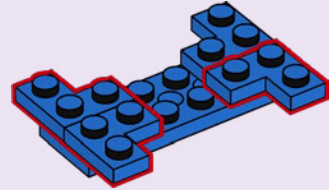

38

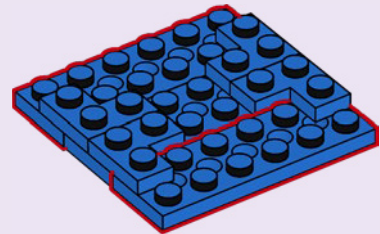

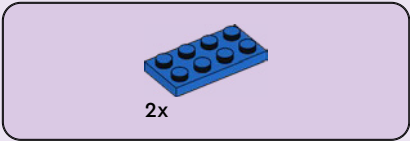

39

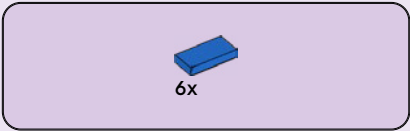
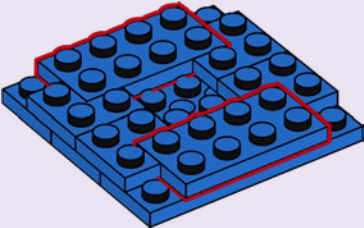

40

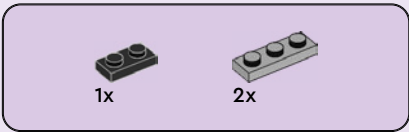
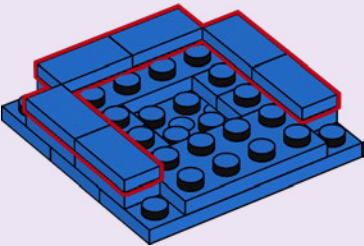

41

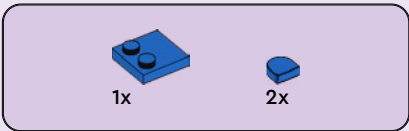
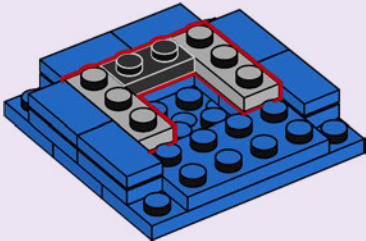

42

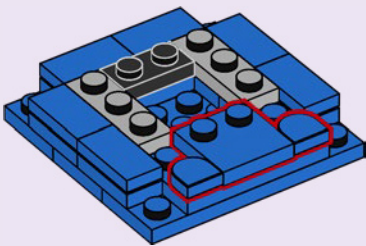

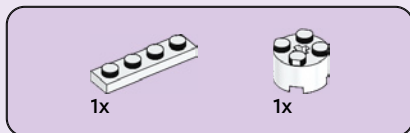

43

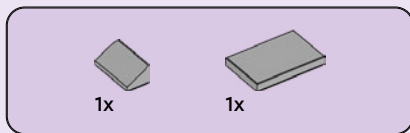
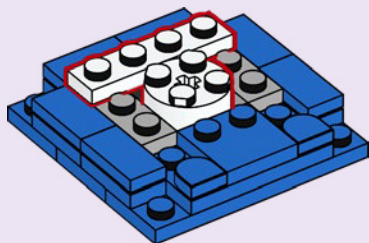

44

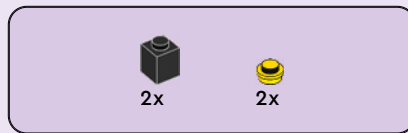
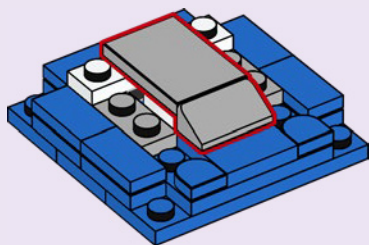

45

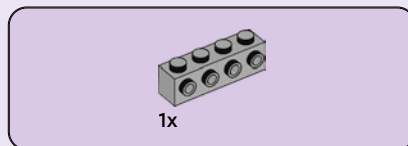
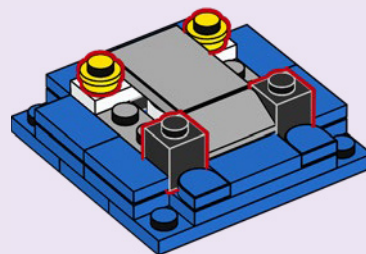

46

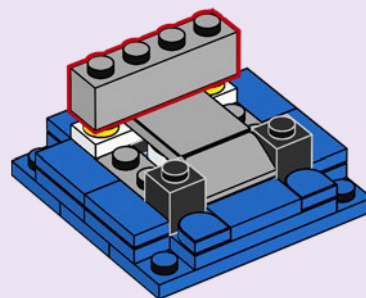



2x

47

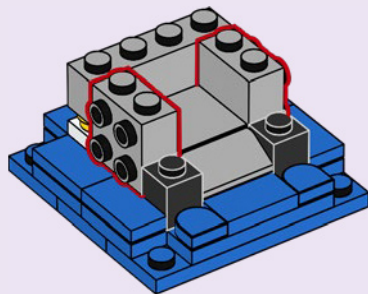

2x

48

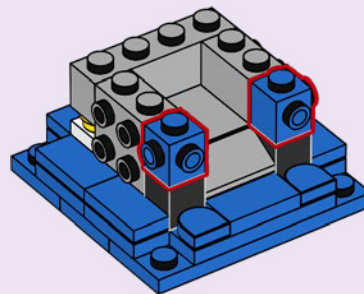

3x

49

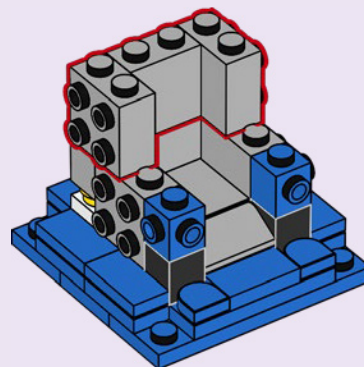



2x

50

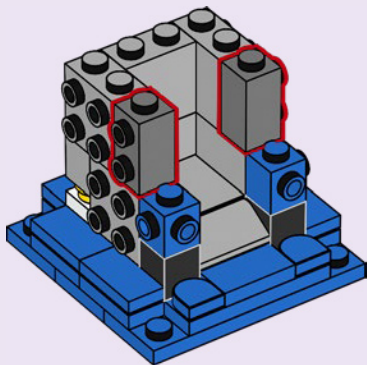

1x



1x



1x



2x

51

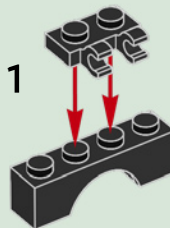

1

2

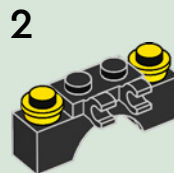

3

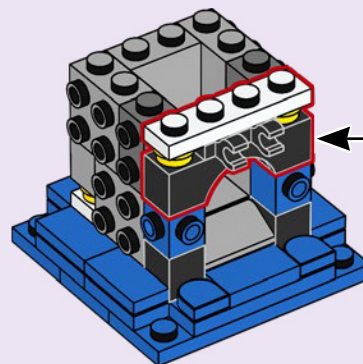
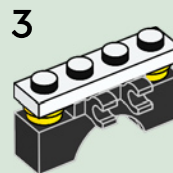

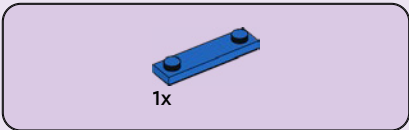

54

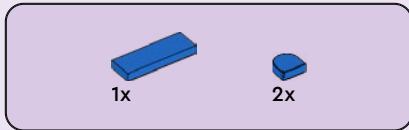
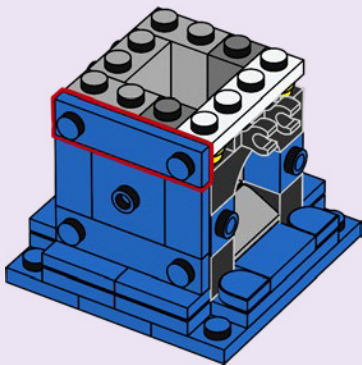

55

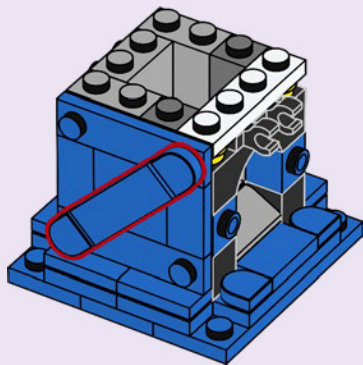

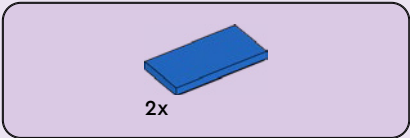

56

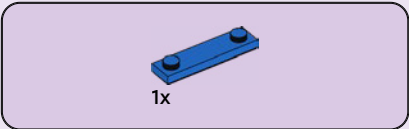
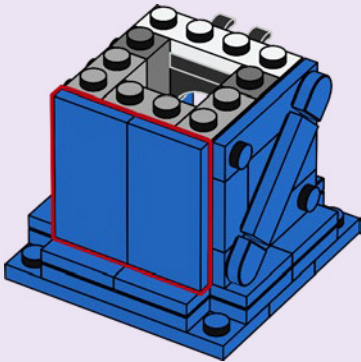

57

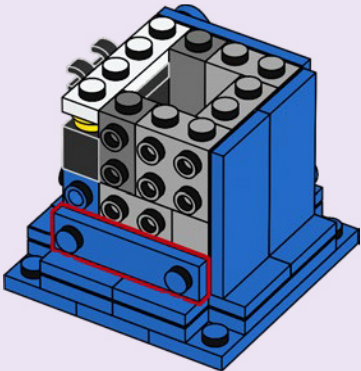

2x



1x



58

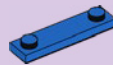
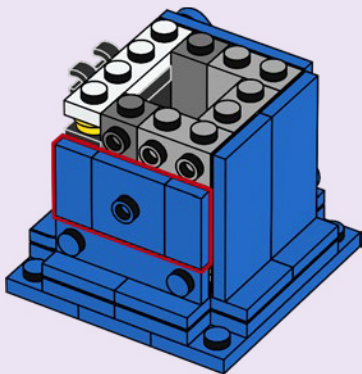

1x

59

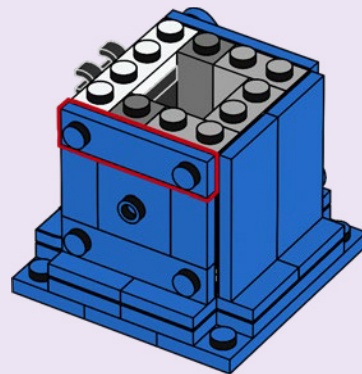

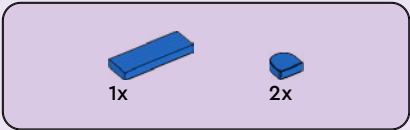

60

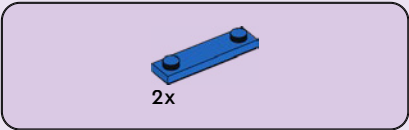
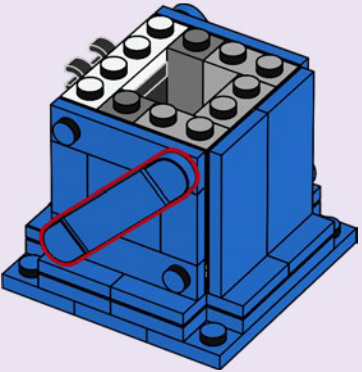

61

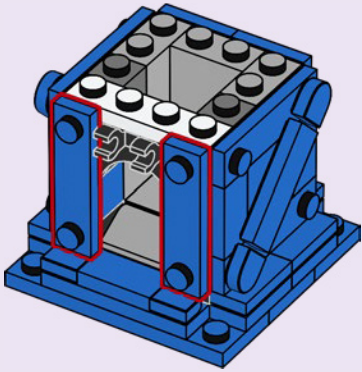

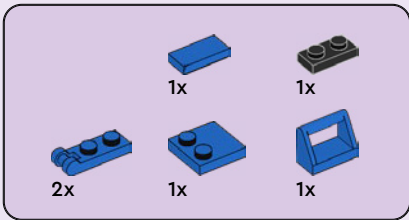

62

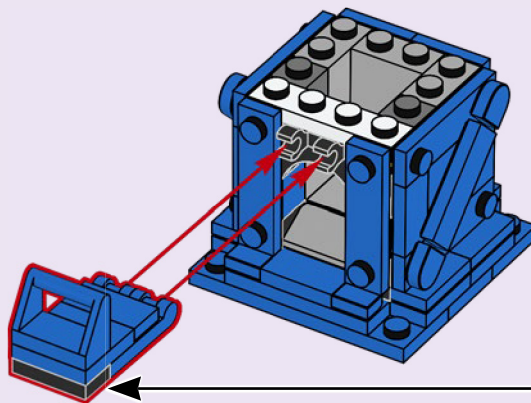
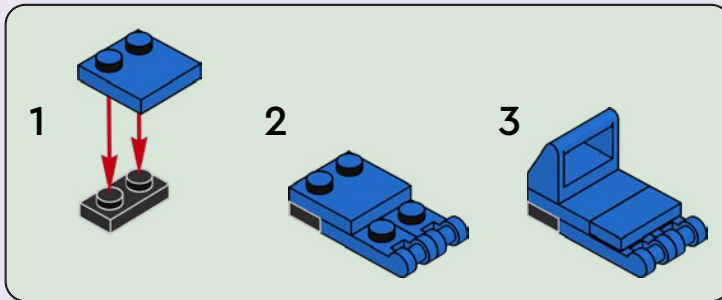



4x

63

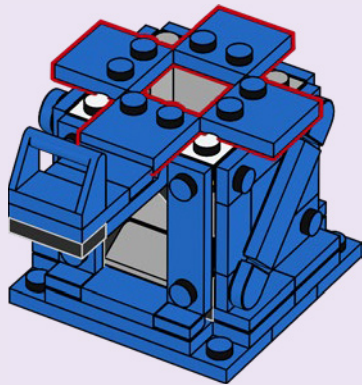

4x

64

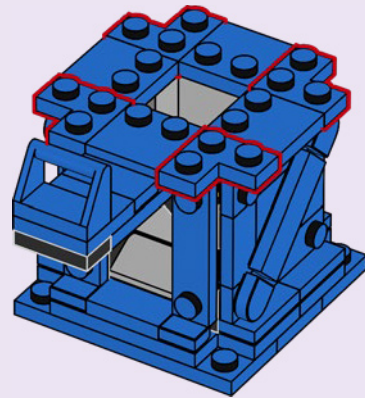

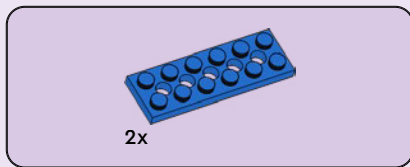

65

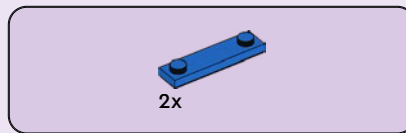
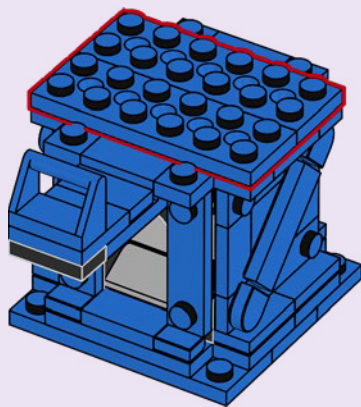

66

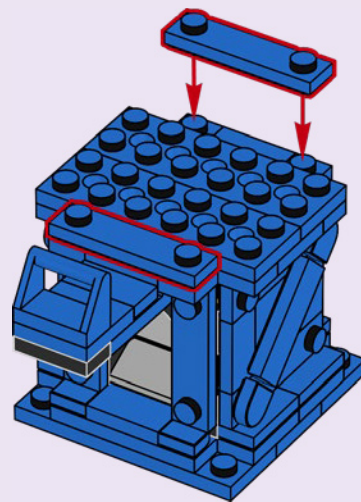

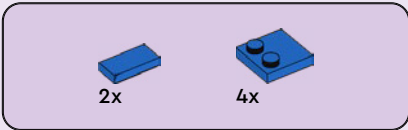

67

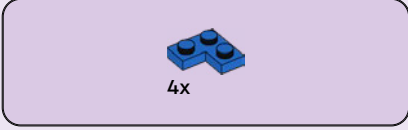
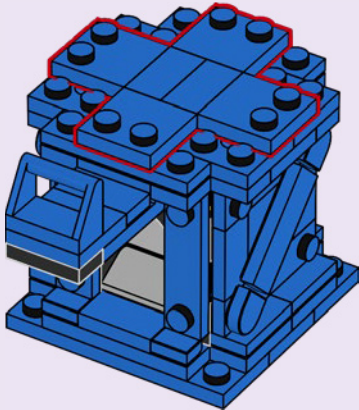

68

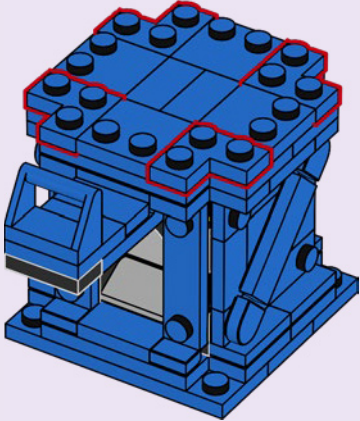

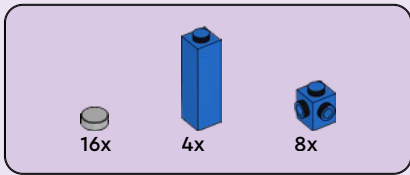

69

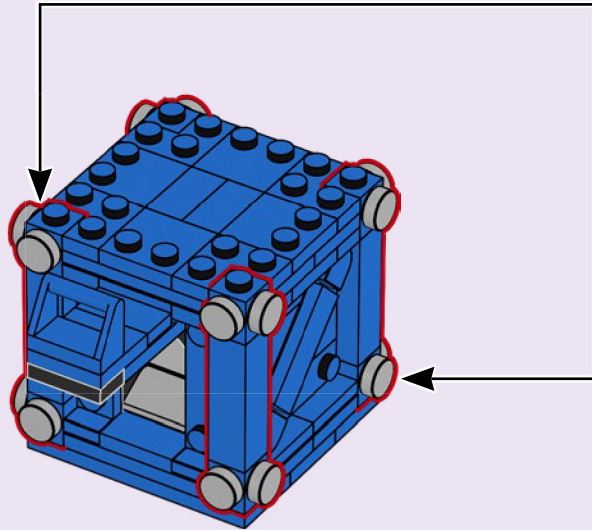
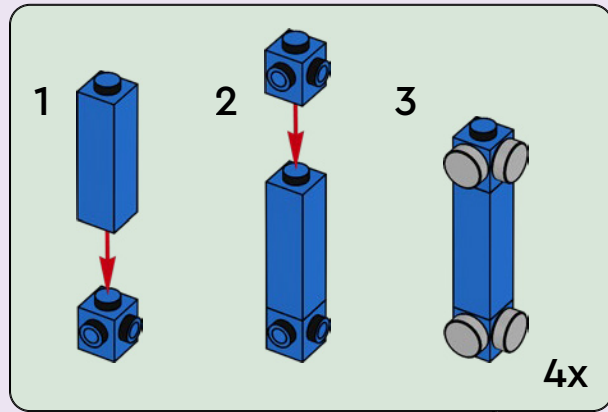



4x



4x

70

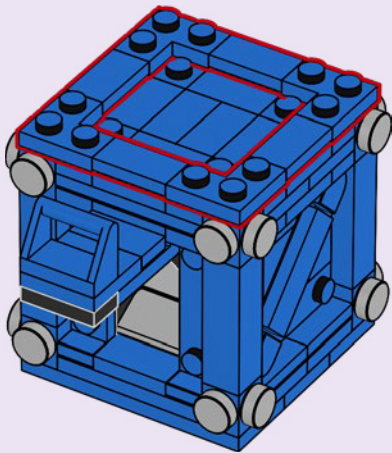

4x

71

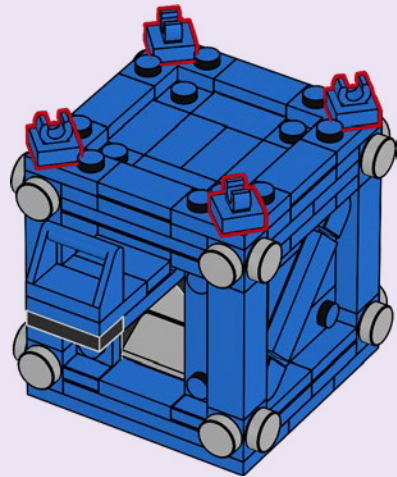



72

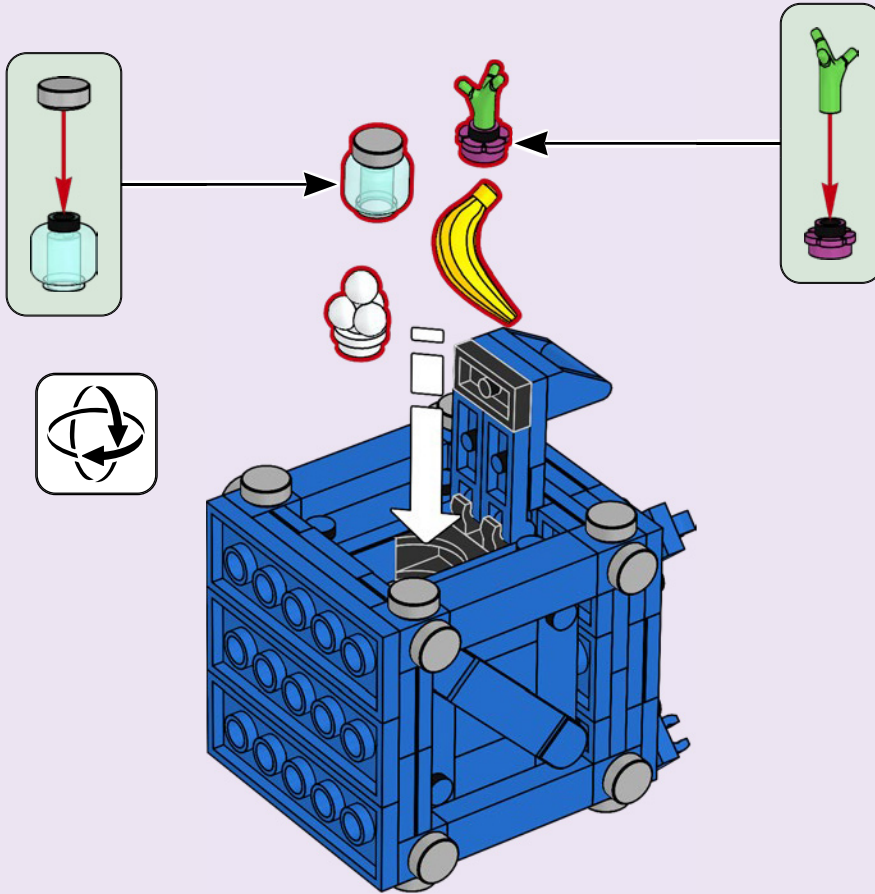

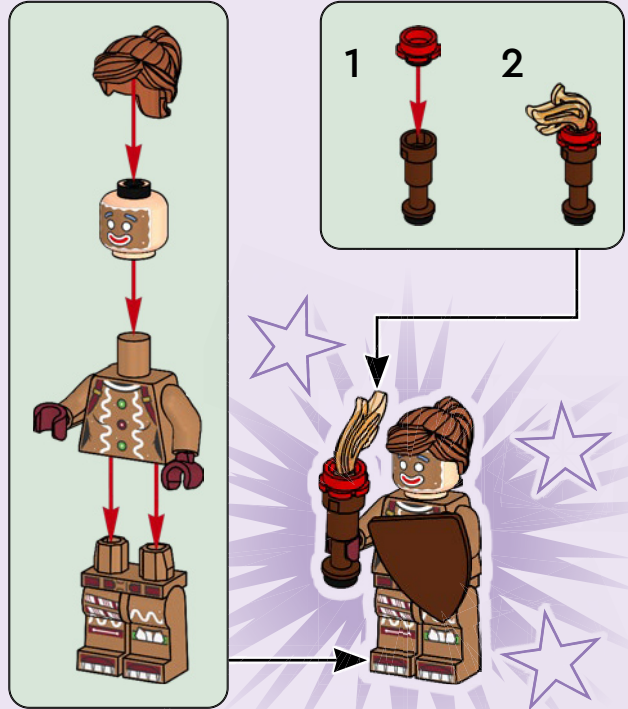
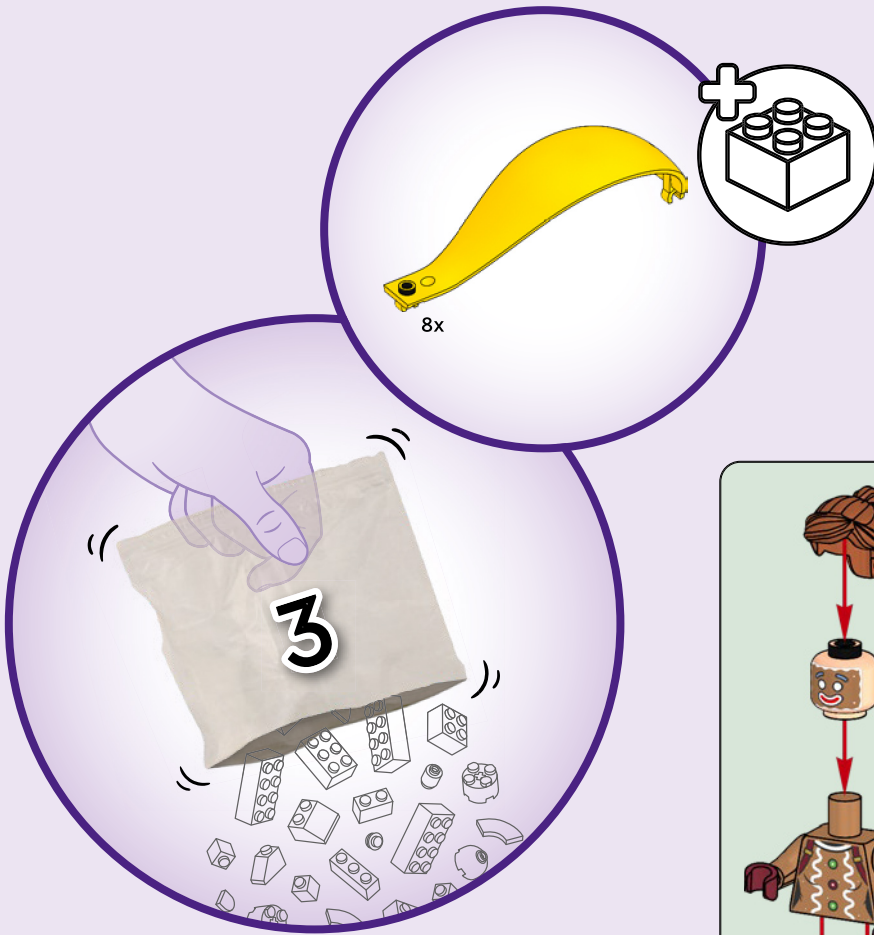

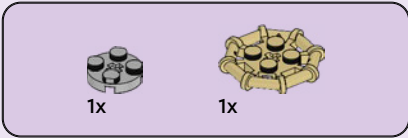
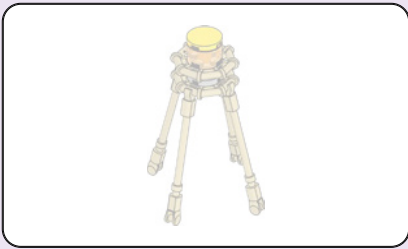

73

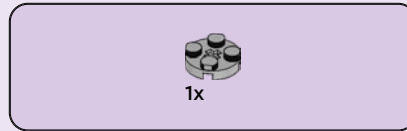
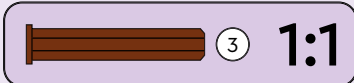
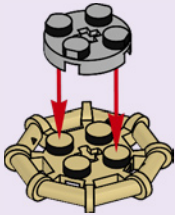

74

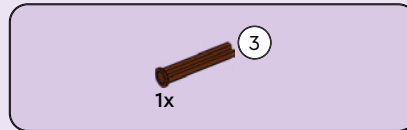
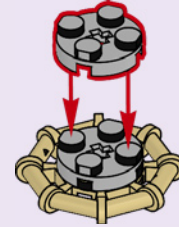

75

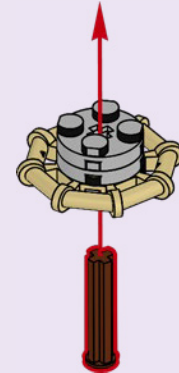

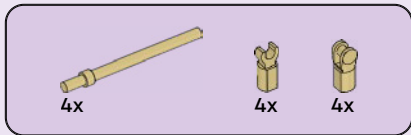

76

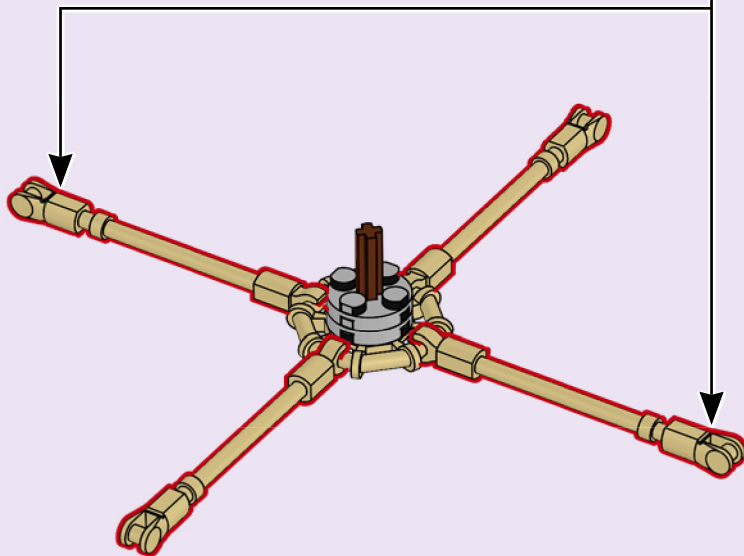
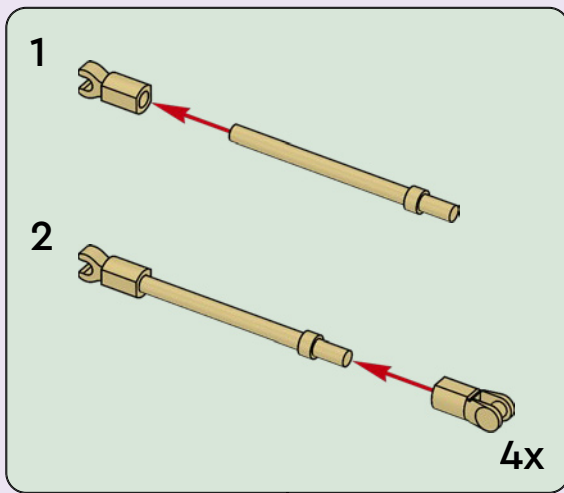



77

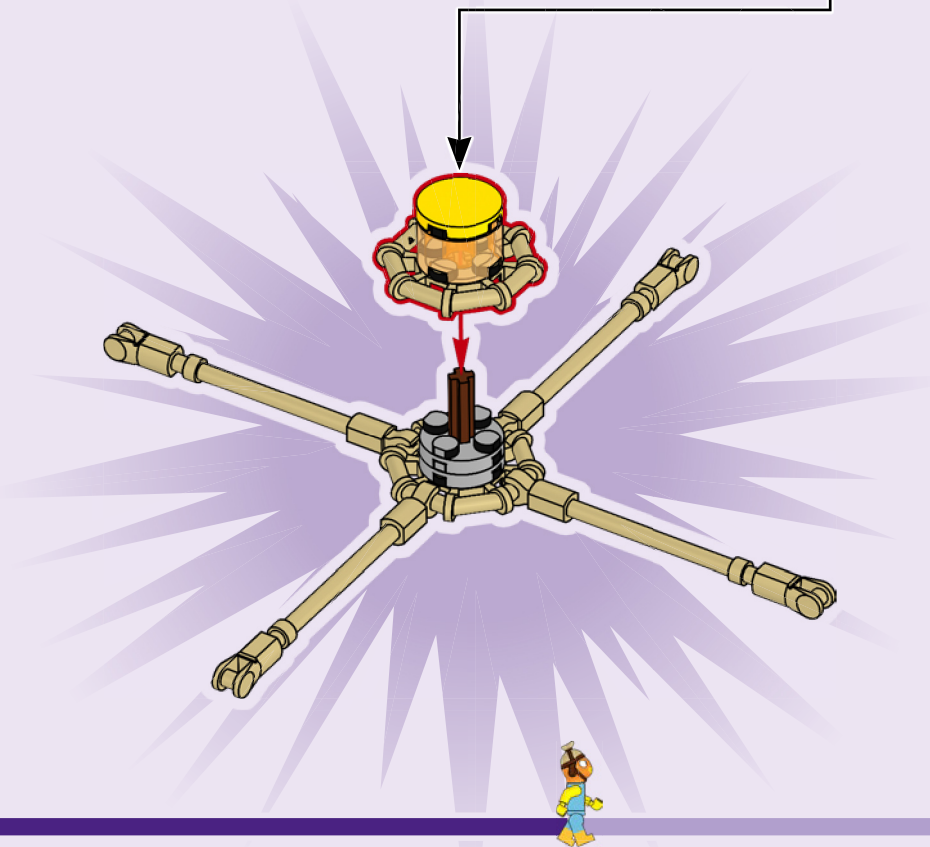
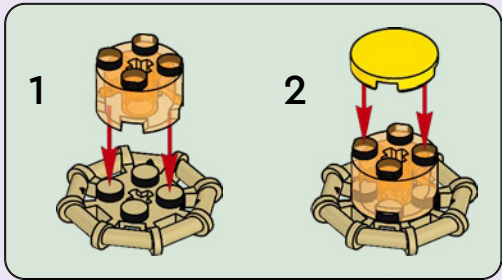

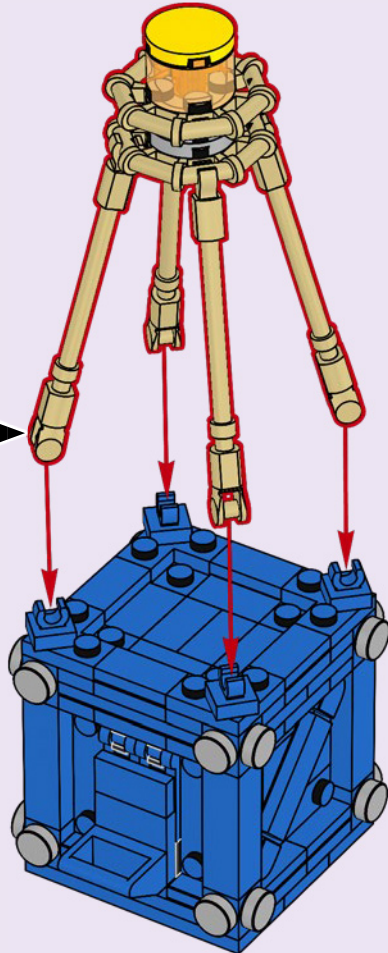

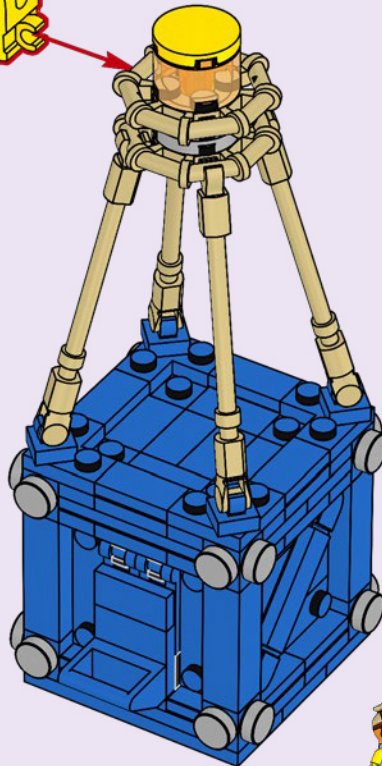
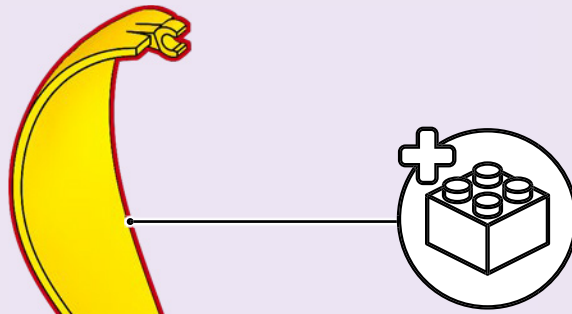

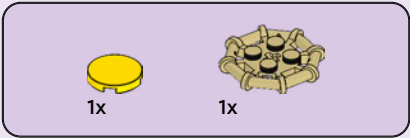

80

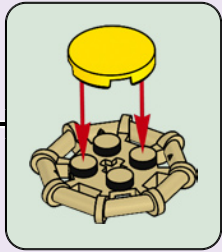
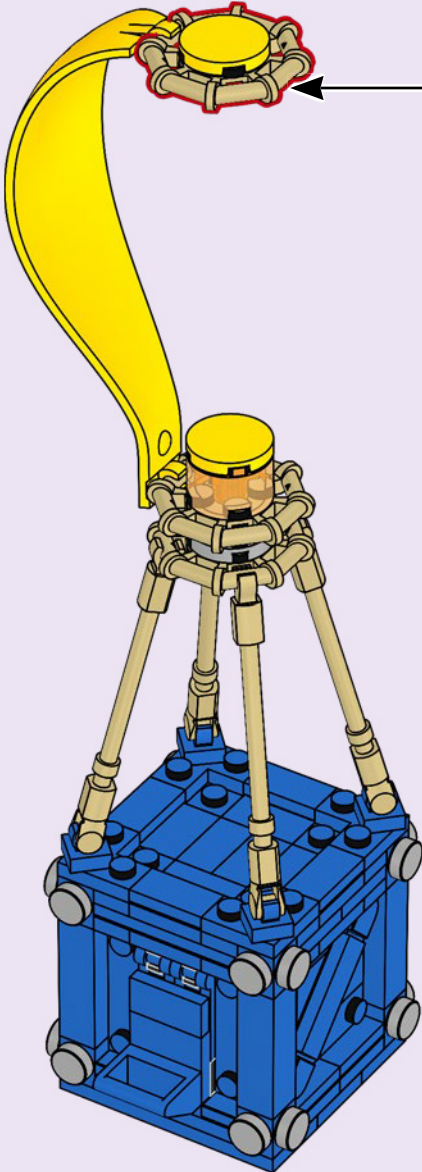

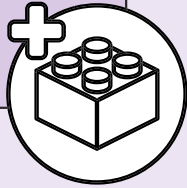
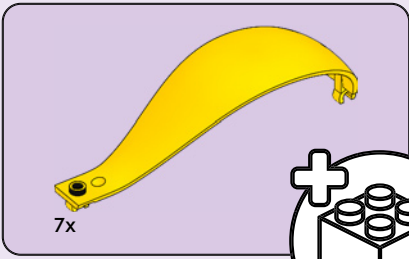

81

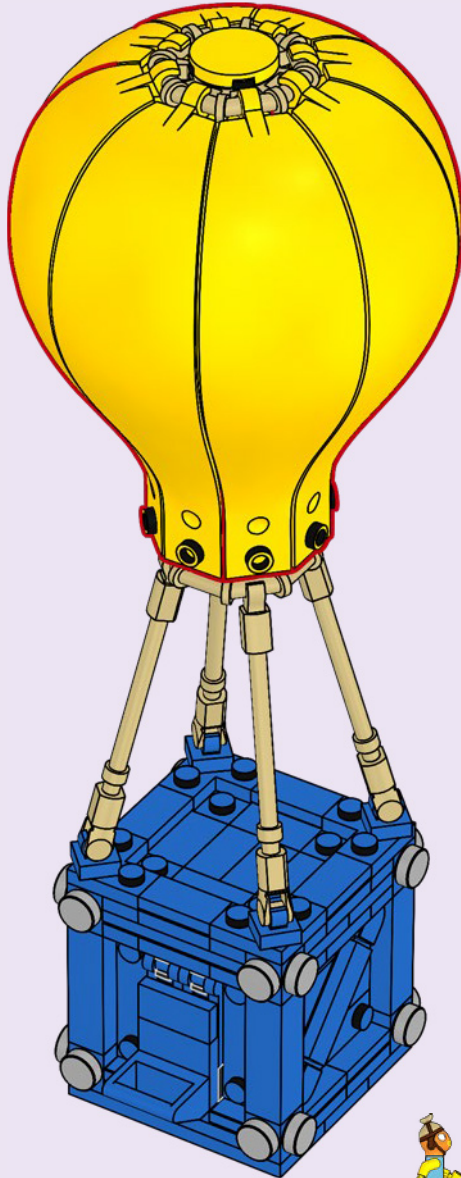

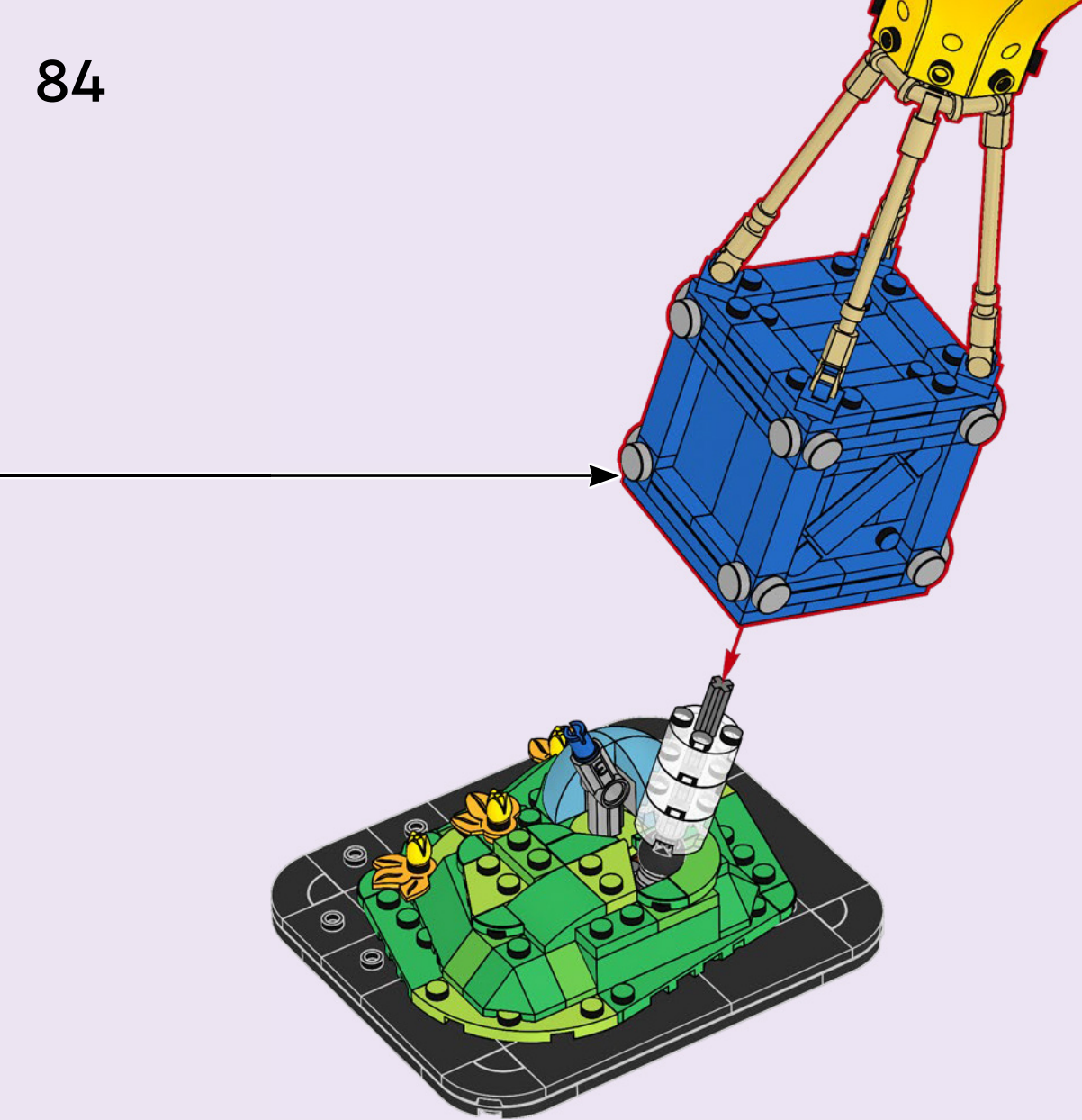

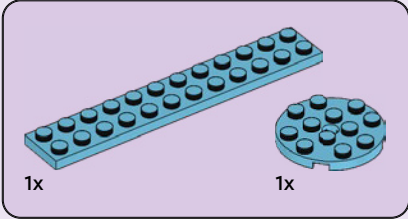
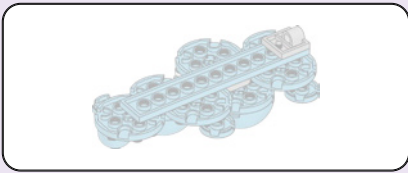

85

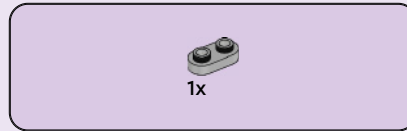
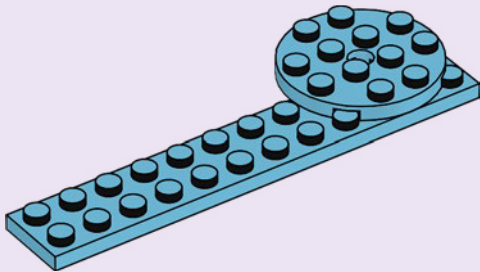

86

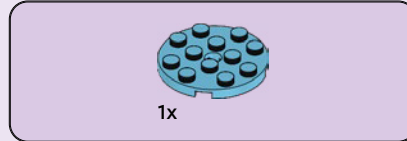
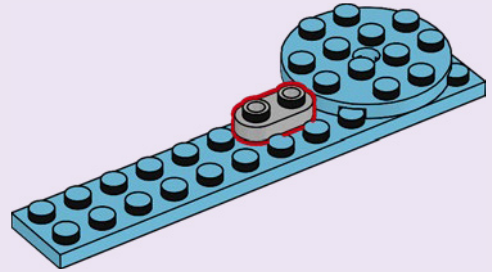

87

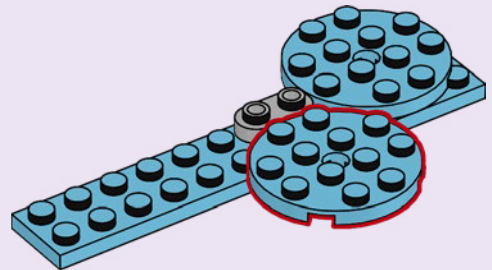



2x

88

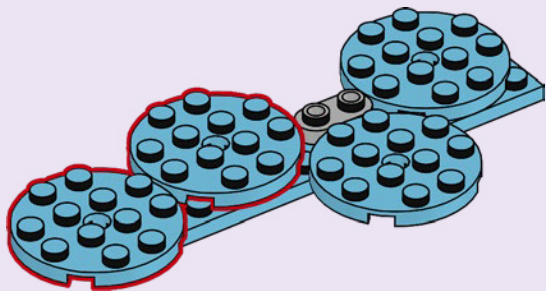

3x

89

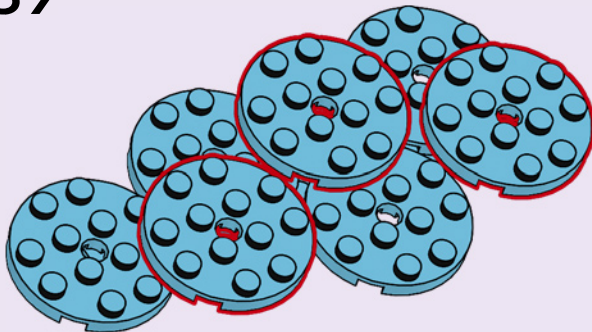

3x

90

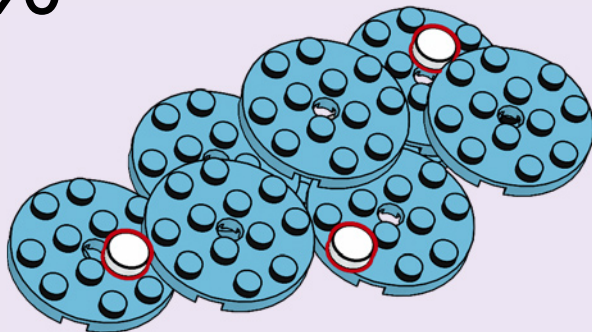

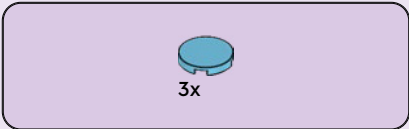

91

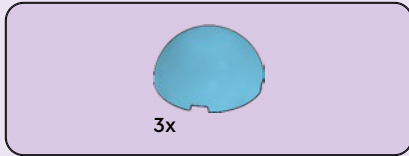
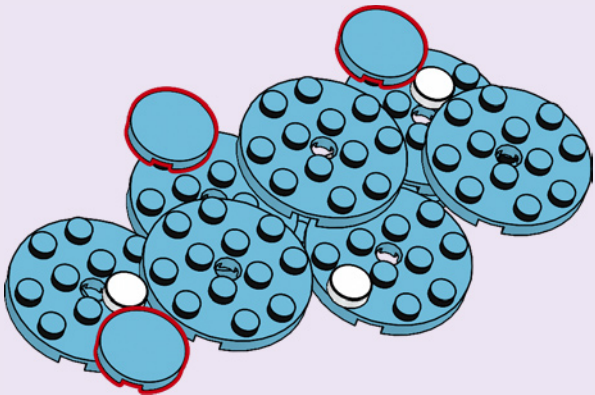

92

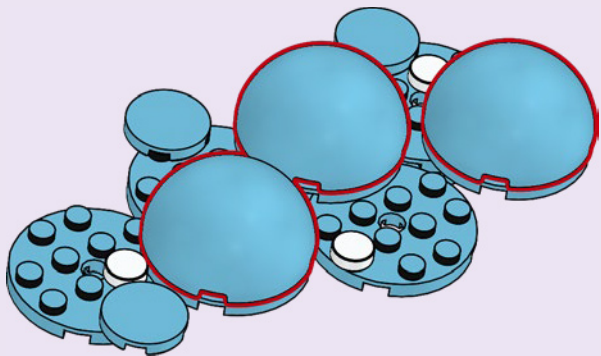



2x

93

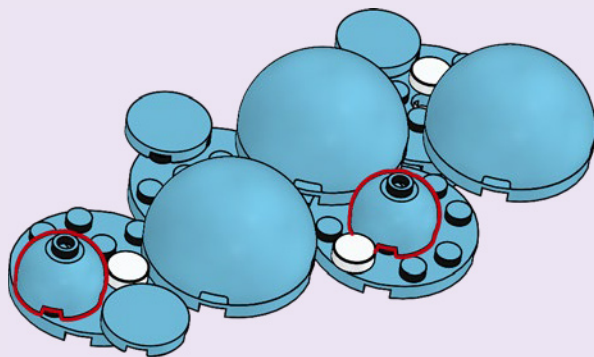



1x

94

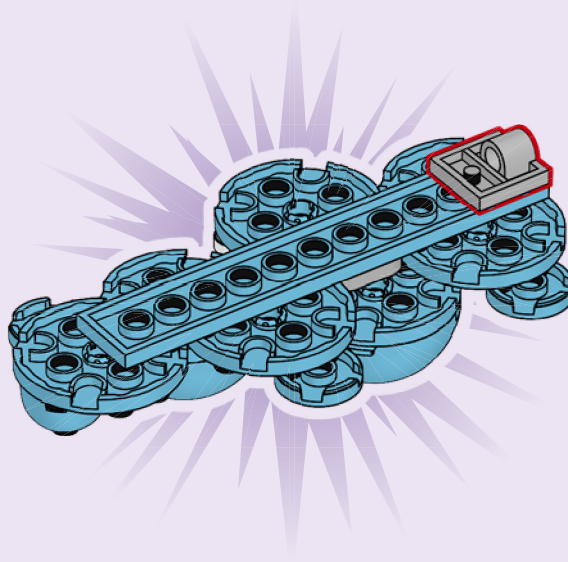

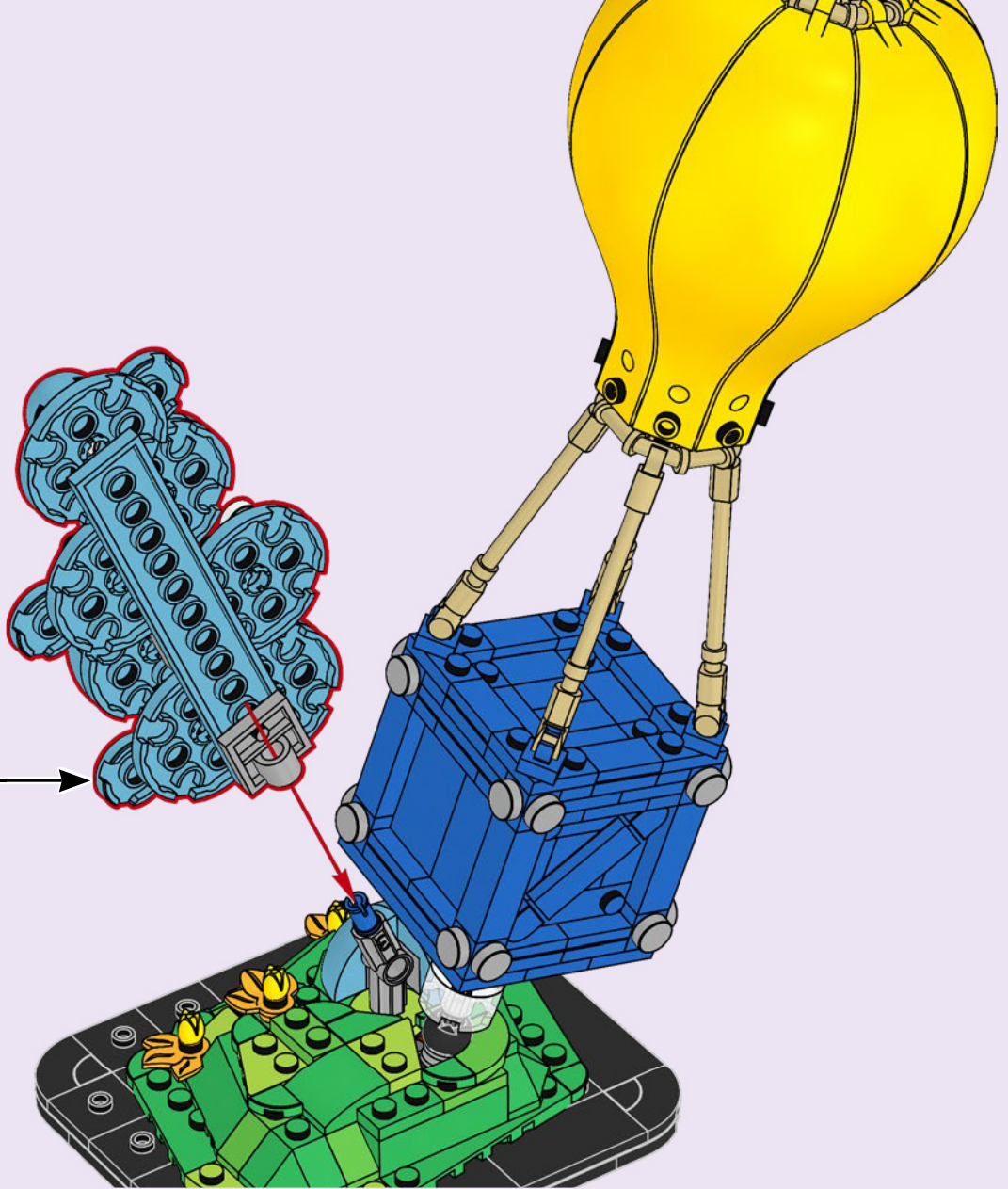

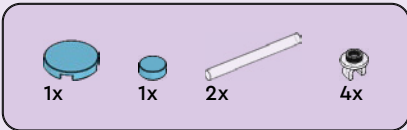

96

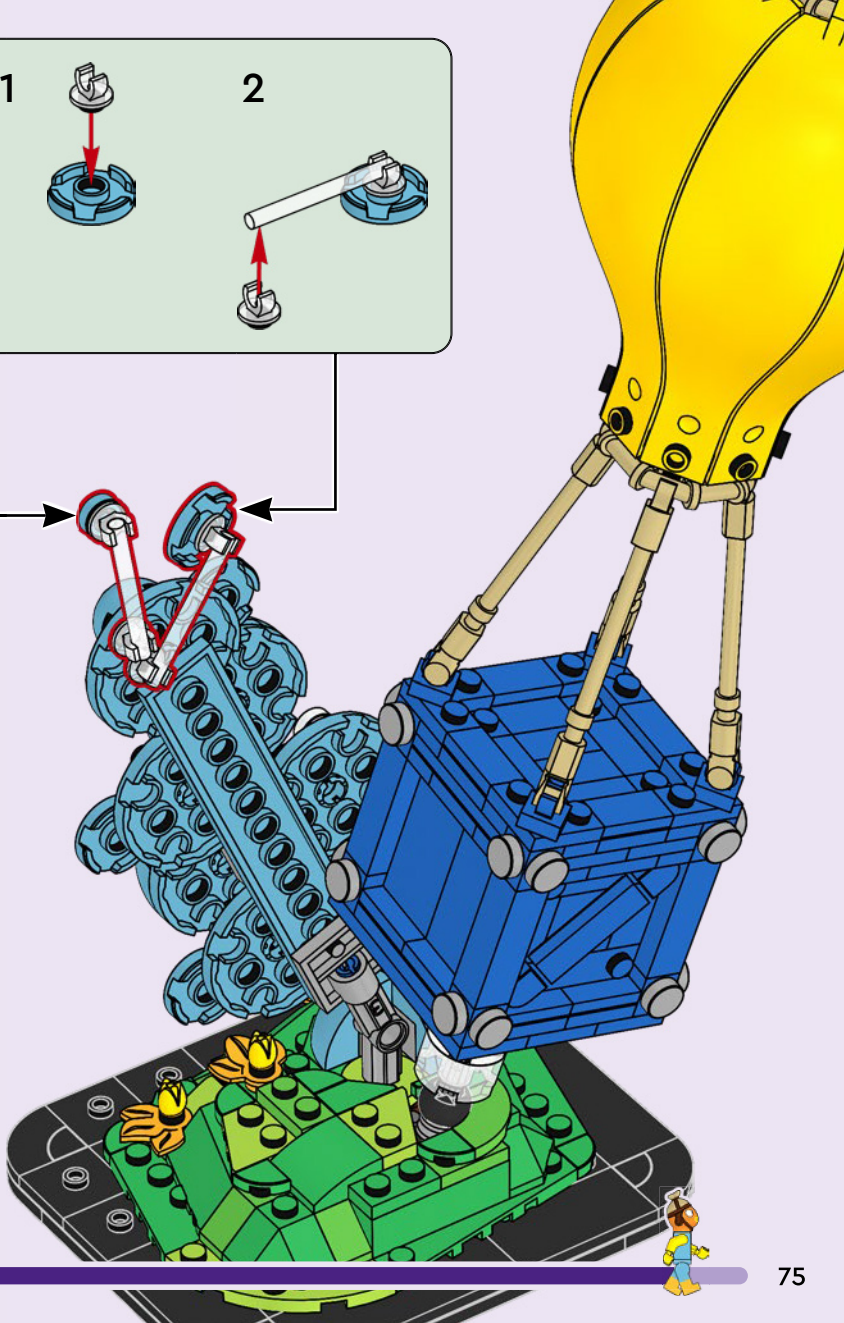
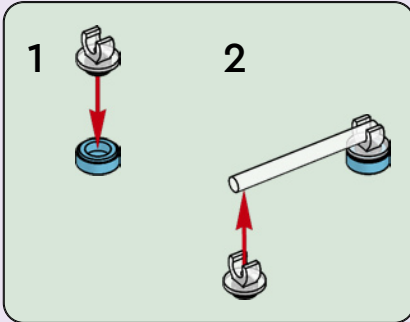
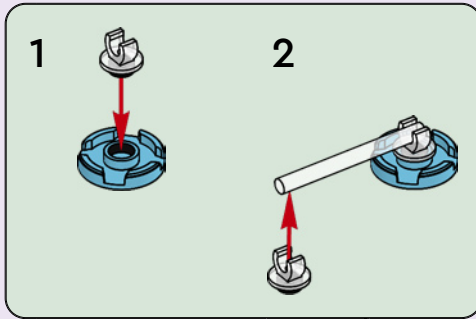

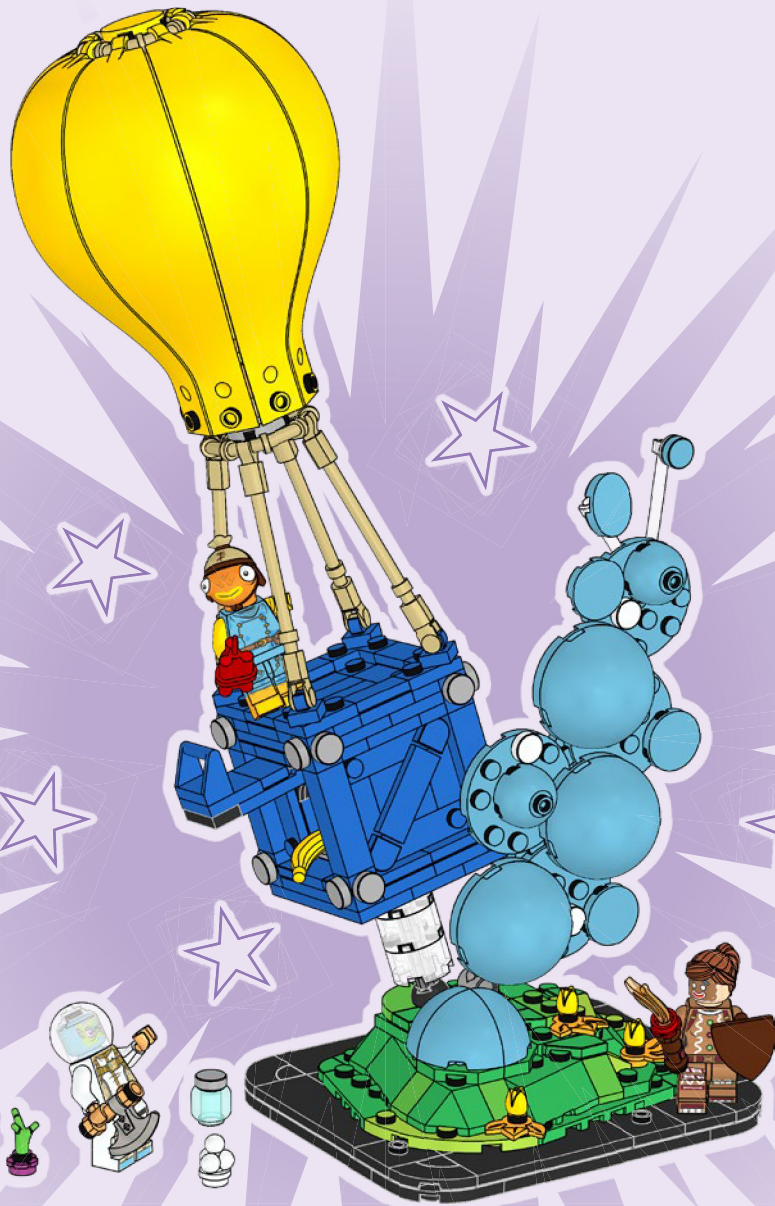



FORTNITE®



77079



77080



77081



77082

3x
6284572

1x
6458475

1x
6603617

1x
614301

1x
6603686

1x
6609705

2x
371001

4x
6337525



4x
6458391

3x
6575077

2x
4114309



4x
6254770

1x
6206148

1x
6270088

1x
4142865

6x
6268862

4x
6469934

4x
6344028

10x
6608463

1x
4206482

17x
306923

1x
243223

16x
242023

10x
6252060

2x
6126049

2x
6073890

2x
4587840

8x
6292291

2x
4560180

2x
302023

5x
4114027

3x
6500394

4x
614124

2x
6078279

1x
4114584

8x
6608461

2x
4286267

2x
300526

4x
6172383

2x
302326



1x
6310268

4x
6191630



5x
4565323

4x
4227392

1x
365926

2x
4560182

2x
366626



3x
6318582

3x
303526

1x
303626

6x
6150607

3x
6510137

2x
6385261

2x
4543262



3x
6311453

1x
6493699

1x
6116259

3x
6297286

1x
6404638

2x
4112838

2x
6404631

1x
379528

1x
6314353

1x
6514283

3x
6378797

1x
6223823

4x
6542392

1x
6514315

3x
6514281

2x
6507886

1x
6513993

2x
4220634

1x
4504372

3x
6258408

1x
6167483

2x
4504705

1x
6271165

17x
6284071

1x
6248890

1x
4568637

2x
4211475

5x
6123809

1x
6045988

1x
4211349

1x
6261387

2x
4211429

1x
6171894

1x
4211636

1x
6603687



1x
6378168

1x
6609579

1x
6603689

2x
6228923

1x
6338291

1x
4499858

1x
6363145

1x
6209682

1x
6353186

1x
6310449

1x
6135494

1x
6365882

4x
4211247

1x
6434871

5x
6300148

2x
6343326

1x
6382958

1x
6322819

1x
6615222

4x
6145255

2x
6429058



1x
6603683



3x
6594033

1x
6609526

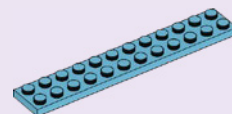
7x
6102828

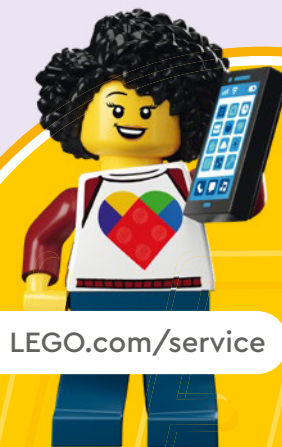

3x
6523577

1x
6344748

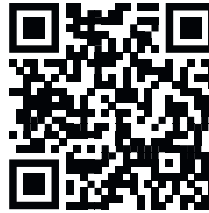

 [LEGO.com/service](https://www.LEGO.com/service)

YOU COULD **WIN**



Scan this QR code or go to **LEGO.COM/PRODUCTFEEDBACK** and give us your short feedback about this LEGO® set for a chance to win a cool LEGO prize.

Terms and Conditions apply*

EN: YOU COULD WIN. Terms and Conditions apply* **DE: Du könntest GEWINNEN.** Es gelten die Teilnahmebedingungen* **FR: TU POURRAIS GAGNER.** Des conditions s'appliquent* **IT: Potresti VINCERE tu.** Termini e condizioni sono applicabili* **ES: PUEDES GANAR.** Aplican términos y condiciones* **PT: PODERÁ GANHAR.** Aplicam-se Termos e Condições* **ZH: 轻松获奖. 条款和条件适用*** **PL: Szansa na WYGRANĄ.** Obowiązuje regulamin* **CS: Máte šanci VYHRÁT.** Platí všeobecné smluvní podmínky* **SK: Máte šancu VYHRÁŤ.** Platia všeobecné zmluvné podmienky* **HU: TE IS NYERHETSZ!** Felhasználási feltételek érvényesek* **UA: ВИ МОЖЕТЕ ВИГРАТИ.** Застосовуються загальні положення та умови* **RO: Ai putea CÂȘTIGA.** Se aplică termeni și condiții* **BG: Можете да СПЕЧЕЛИТЕ.** Има определени правила и условия* **LV: Tu vari LAIMĒT.** Ir spēkā noteikumi un nosacījumi.* **ET: Sul on võimalus VÕITA.** Kehtivad tingimused* **LT: Jūs galite LAIMĖTI.** Taikomos sąlygos* **TR: KAZANABİLİRSİN.** Şartlar ve Koşullar geçerlidir*

*[LEGO.com/productfeedback-terms](https://www.lego.com/productfeedback-terms)

LEGO and the LEGO logo are trademarks of the LEGO Group. ©2026 The LEGO Group.

© 2026 Epic Games, Inc. All rights reserved. Fortnite and its logo are trademarks of Epic Games, Inc. in the USA (Reg. U.S. Pat. & Tm. Off.) and elsewhere.

6650638