



Harry Potter

76475



LEGO® Builder



Get excited about our new packaging!

We're switching from plastic to paper-based packaging. That's why you might find a mix of paper and plastic in our boxes!

Nos nouveaux emballages vous emballeront !

Nous passons des emballages en plastique aux emballages à base de papier. C'est pourquoi vous pourriez trouver un mélange de papier et de plastique dans nos boîtes !

¡Te presentamos nuestros nuevos empaques!

Estamos sustituyendo las bolsas de plástico por bolsas con base de papel. ¡Por eso, puedes encontrar una mezcla de papel y de plástico en nuestras cajas!

[LEGO.com/sustainable-packaging](https://www.lego.com/sustainable-packaging)

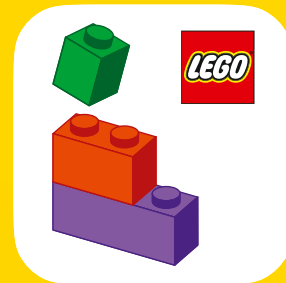

LEGO® Builder



BUILDER



Apple and the Apple logo are trademarks of Apple Inc., registered in the U.S. and other countries and regions. App Store is a service mark of Apple Inc. Google Play and the Google Play logo are trademarks of Google LLC. Tencent and the Tencent logo are trademarks of Tencent Inc.

LEGO.com/devicecheck

EN Ask parents' permission before going online | **DE** Eltern um Erlaubnis bitten, bevor du online gehst | **FR** Demande l'autorisation d'un parent avant d'aller en ligne | **IT** Chiedi il permesso ai tuoi genitori prima di andare online | **ES** Pídeles permiso a tus papás antes de conectarte a Internet | **PT** Pede autorização aos teus pais antes de ficares online | **ZH** 上网前应先征得父母的同意 | **PL** Poproś rodziców o zgodę, zanim wejdiesz do Internetu | **CS** Než půjdeš na internet, požádej rodiče o svolení | **SK** Skôr než pôjdeš na internet, vypýtaj si povolenie od rodičov | **HU** Kérj szülői engedélyt, mielőtt online csatlakoznál! | **UA** Запитуйте дозволу батьків, перш ніж користуватися інтернетом | **RO** Cere permisiunea părinților înainte de a te conecta online | **BG** Поискайте разрешение от родител, преди да влезете онлайн | **LV** Pirms došanās tiešsaistē palūdz atļauju vecākiem | **ET** Enne Interneti kasutamist küsi vanematelt luba | **LT** Prieš prisijungdami prie interneto, atsiklauskite tėvų | **TR** İnternete girmeden önce anne babadan izin iste

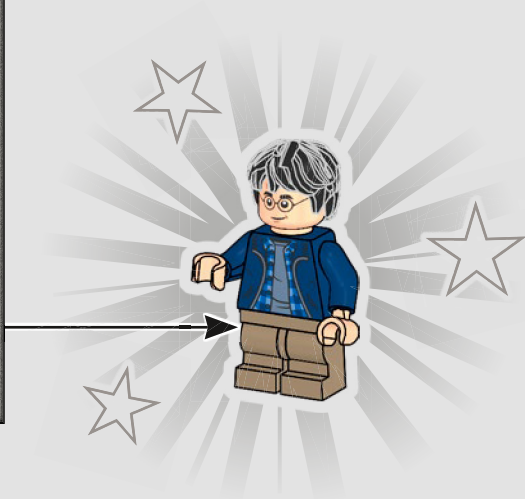
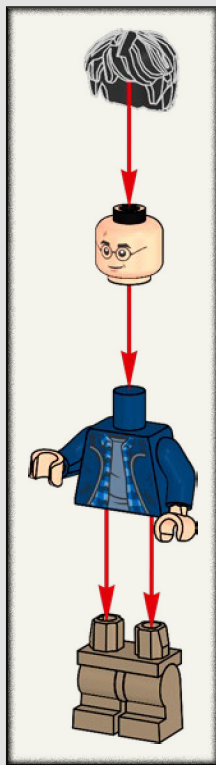

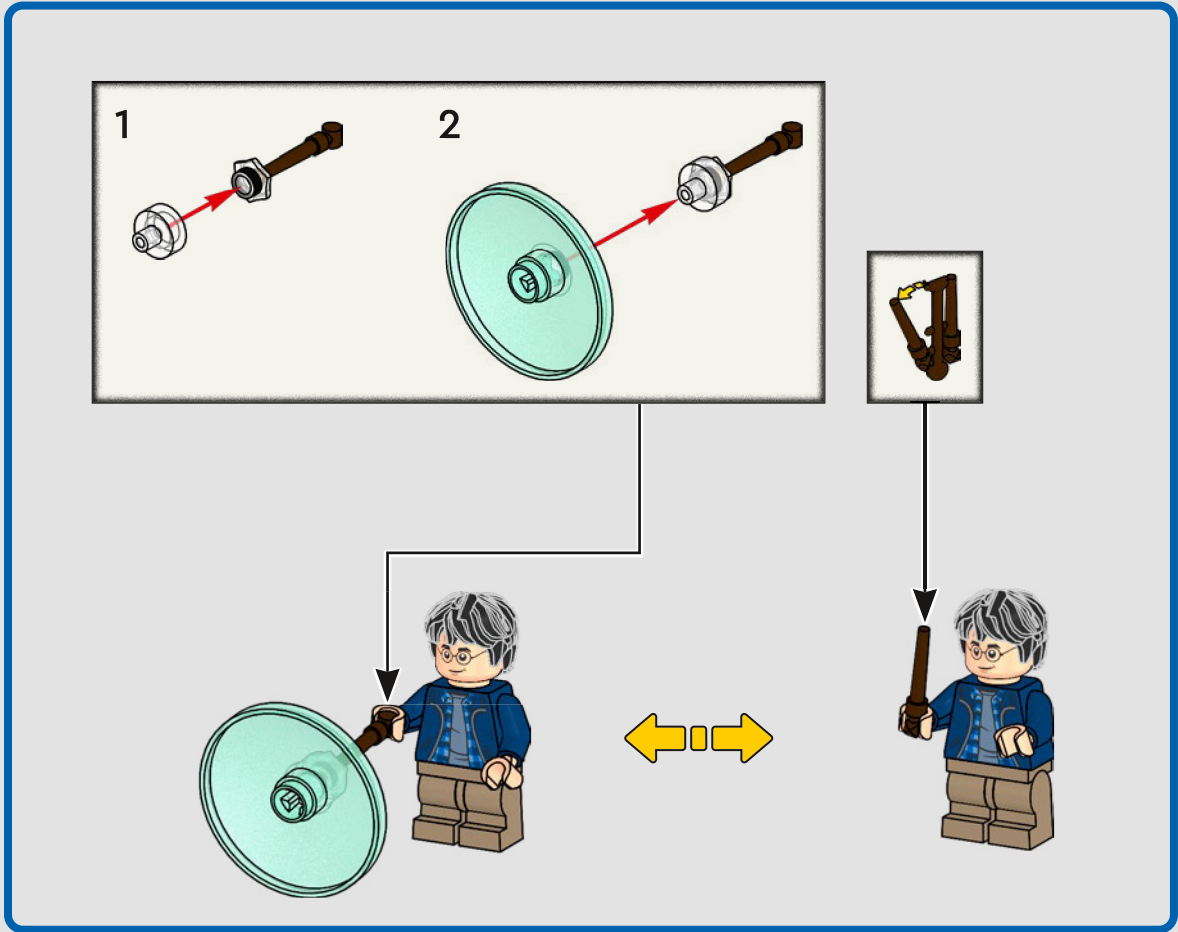

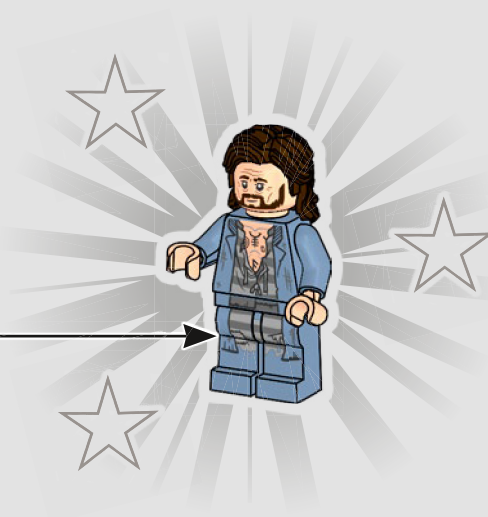
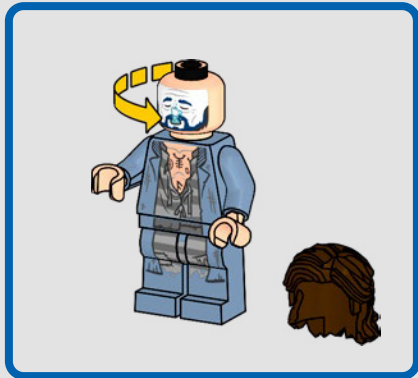
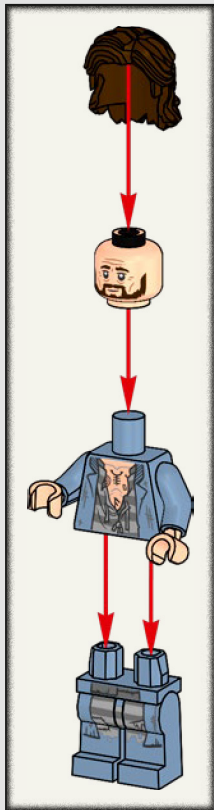

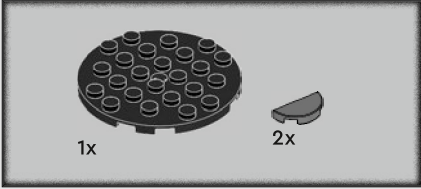

1

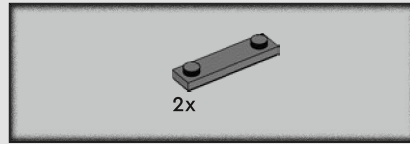
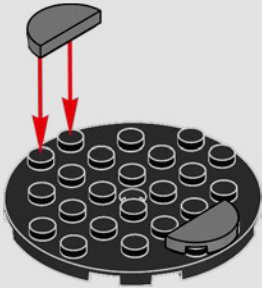

2

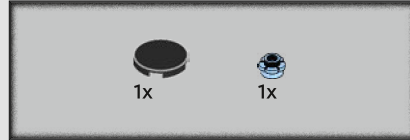
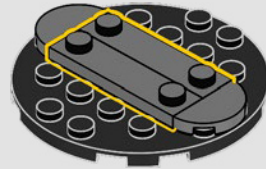

3

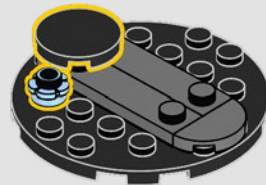

4

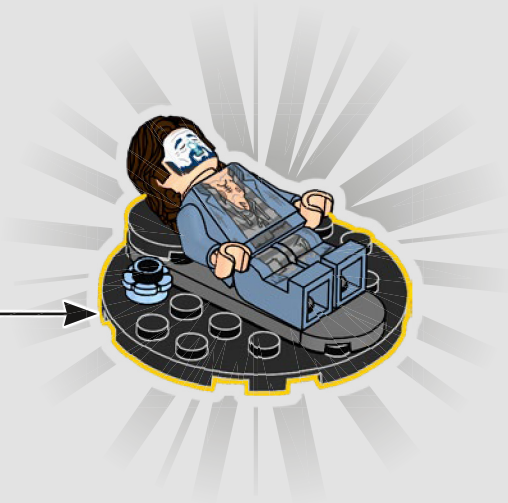

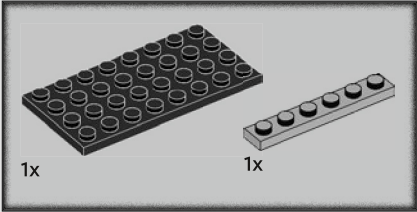
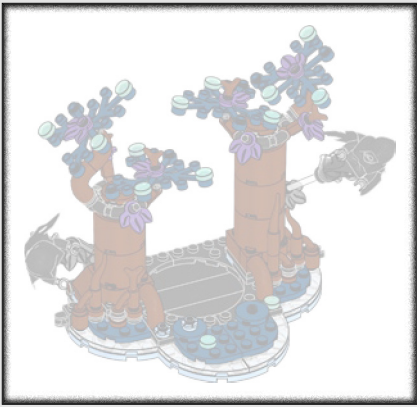

1

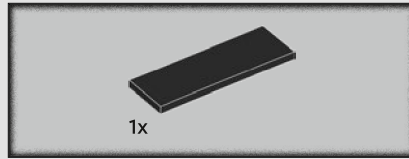
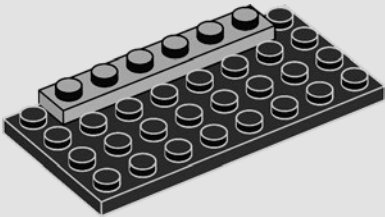

2

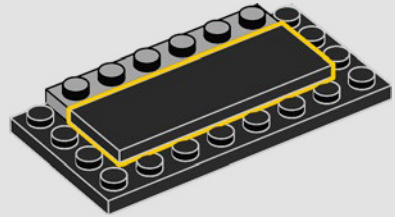

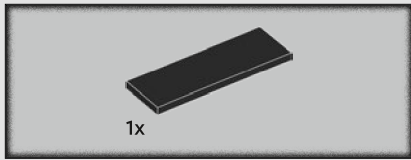

3

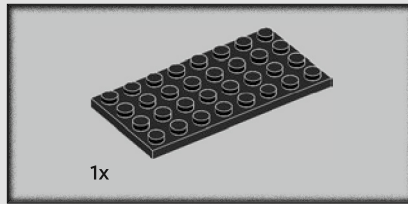
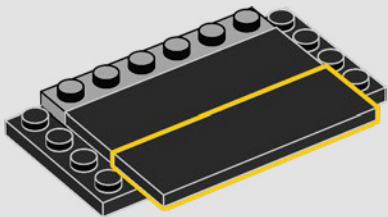

4

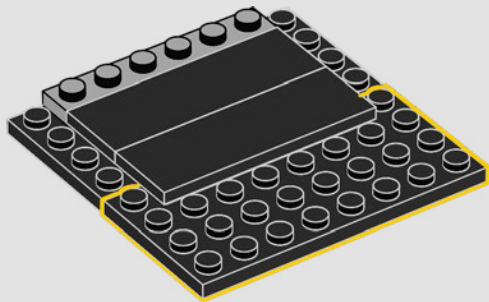

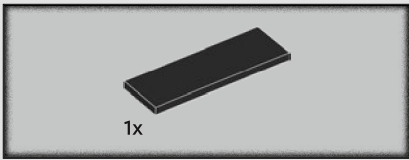

5

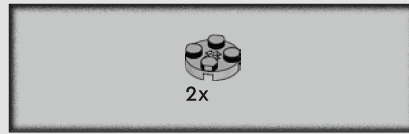
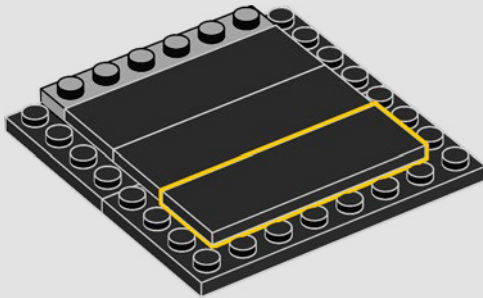

6

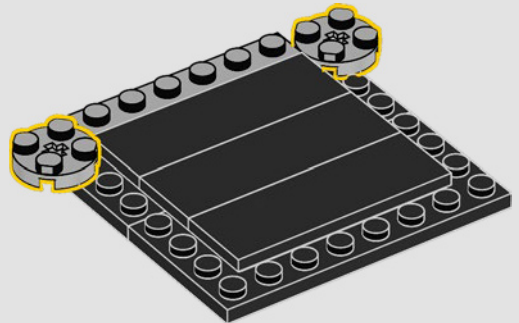

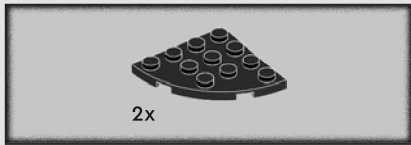

7

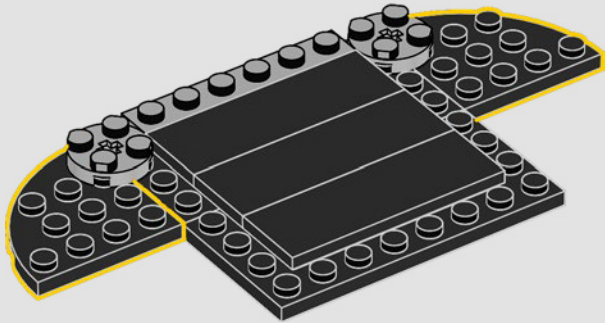

8

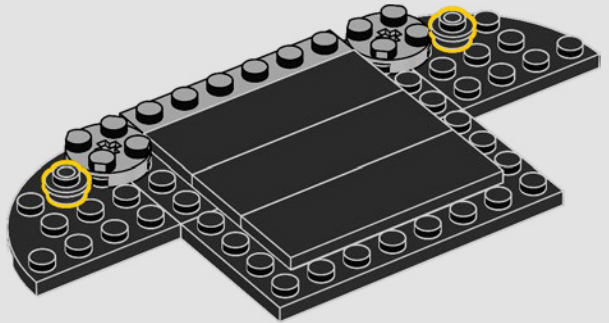

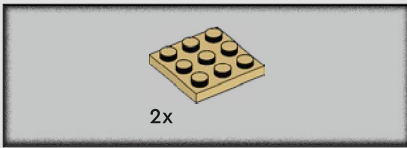

9

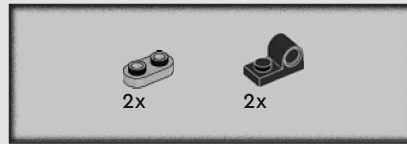
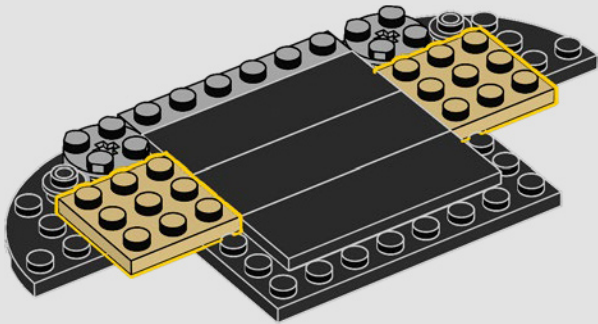

10

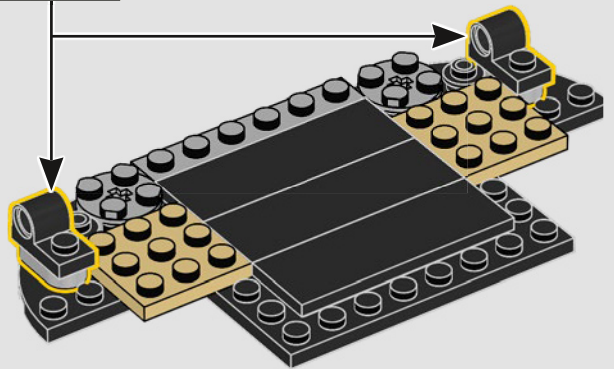
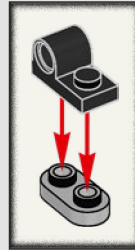

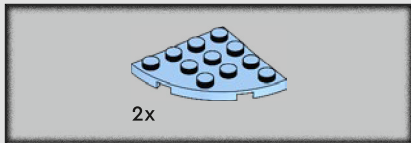

11

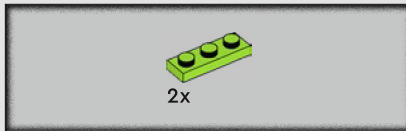
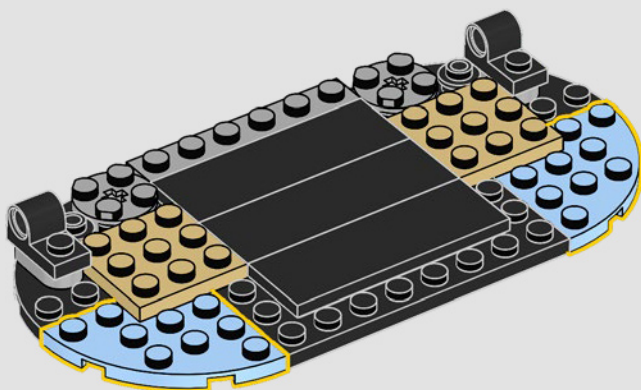

12

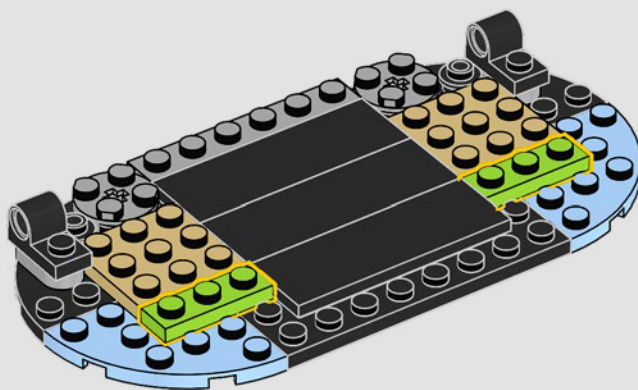



13

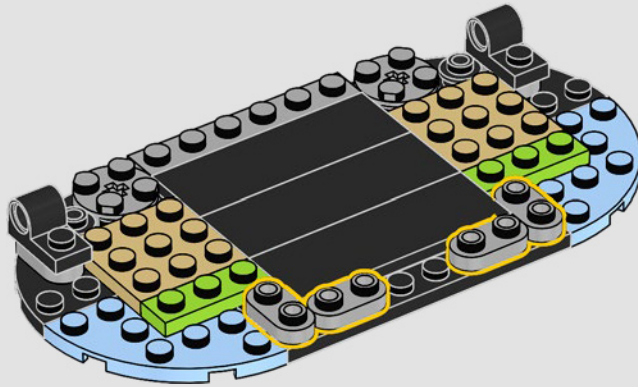

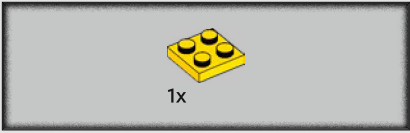

14

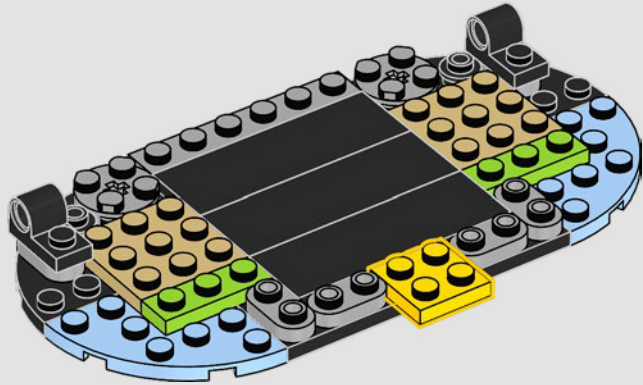

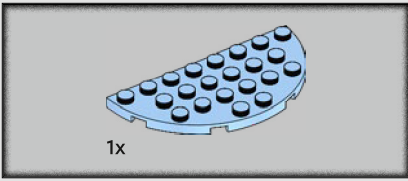

15

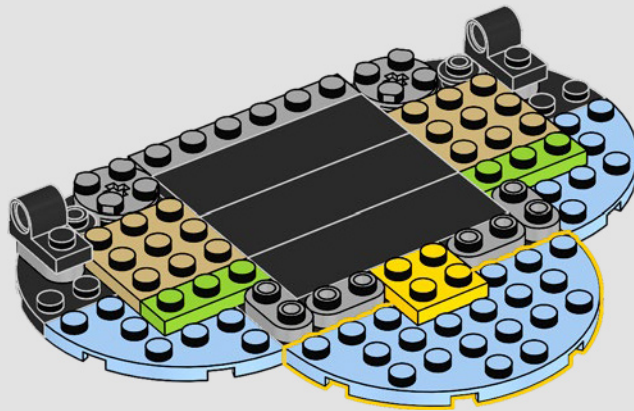

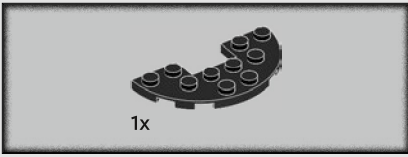

16

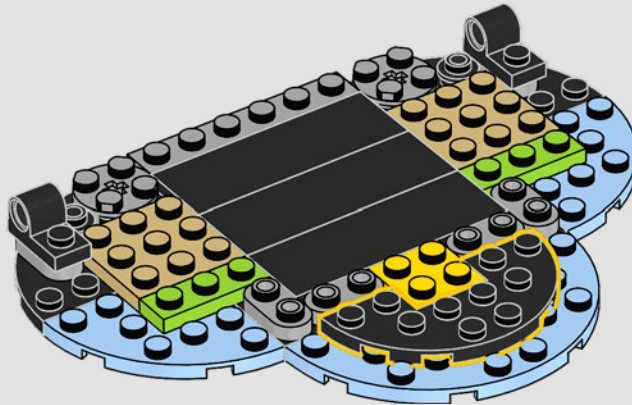

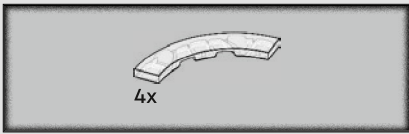

17

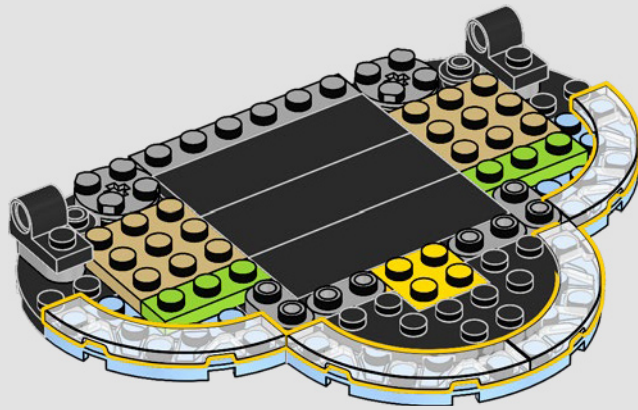

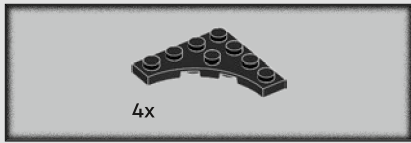

18

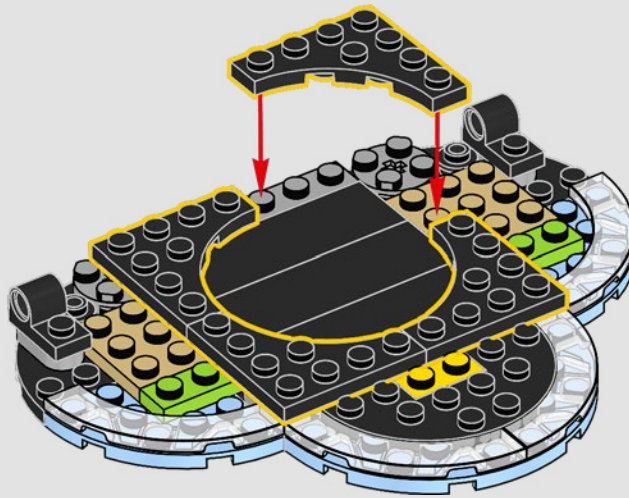

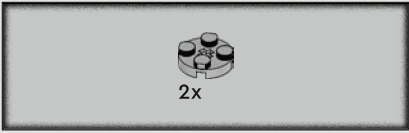

19

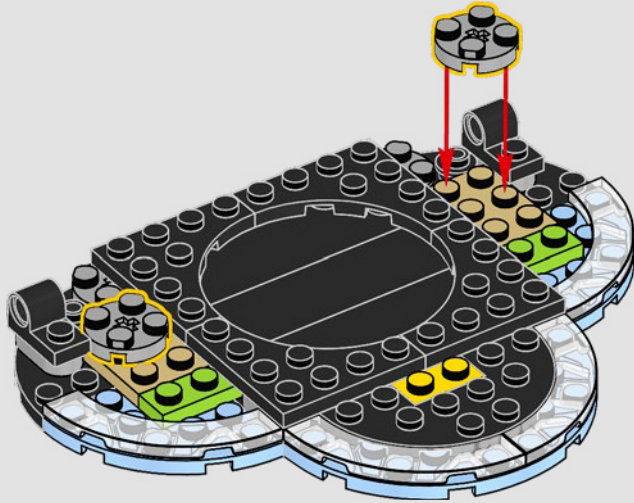

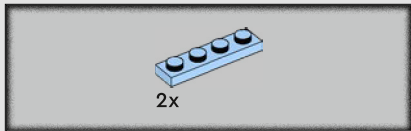

20

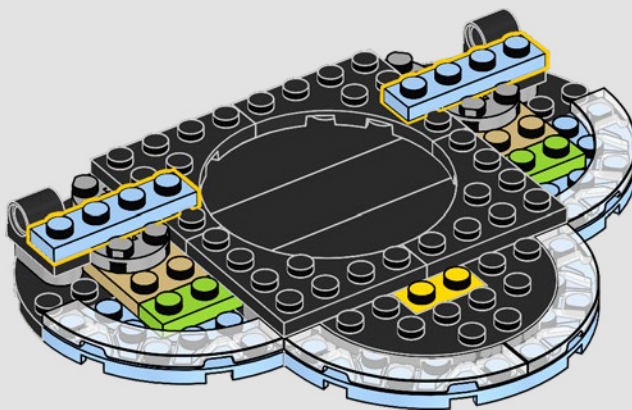

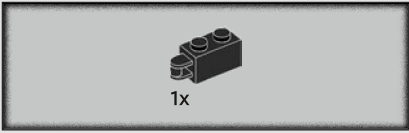

21

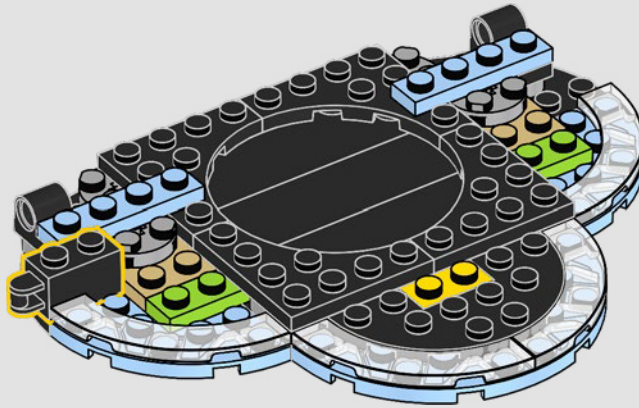

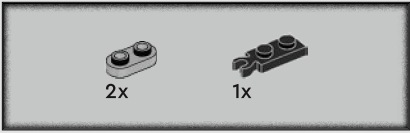

22

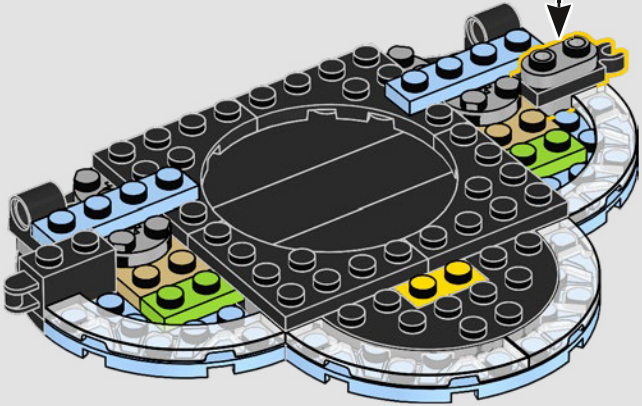
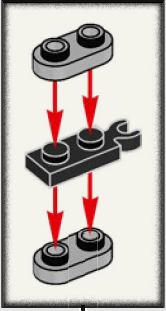

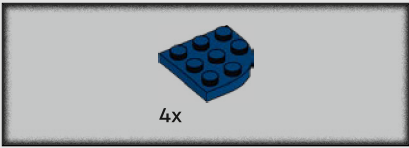

23

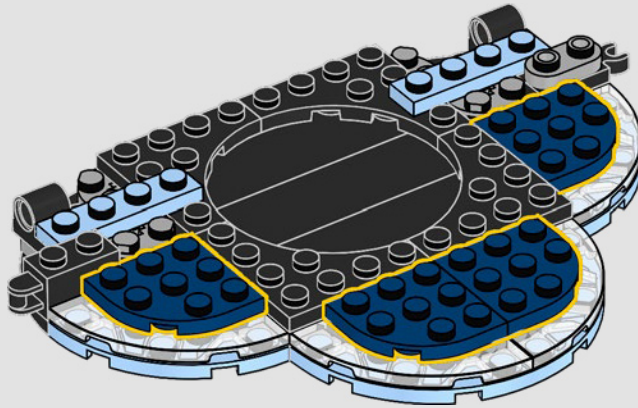

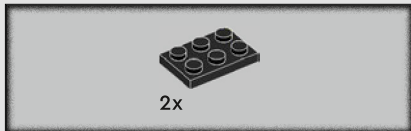

24

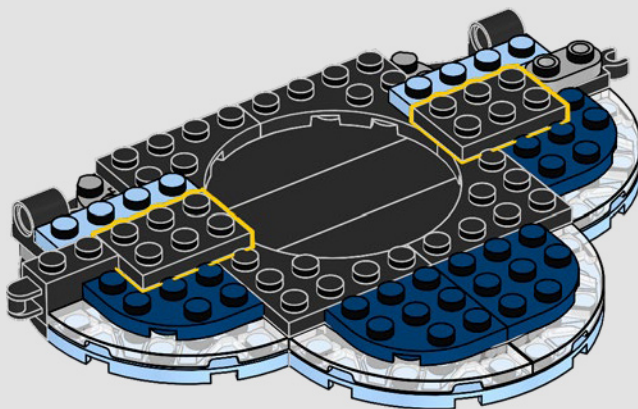



25

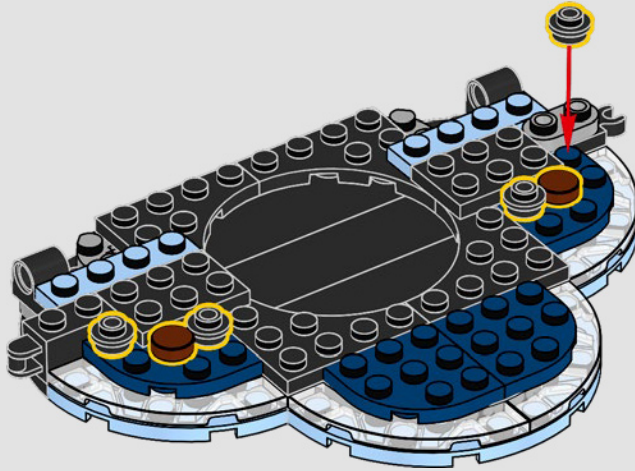



26

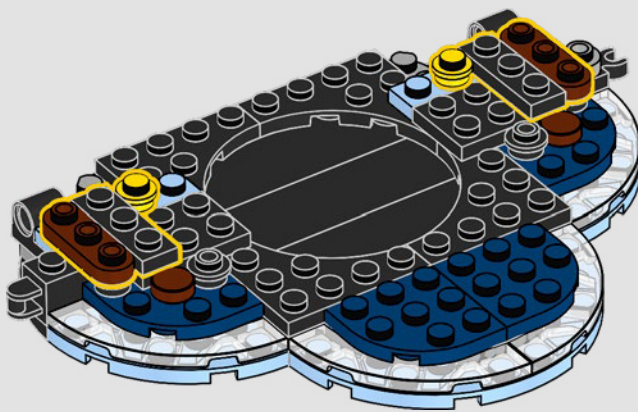

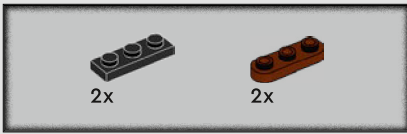

27

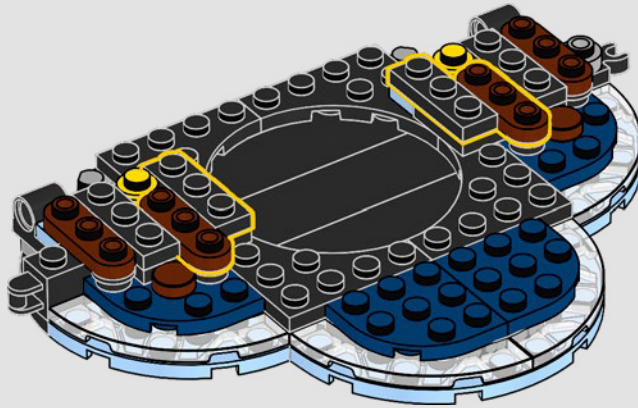

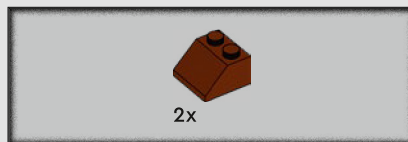

28

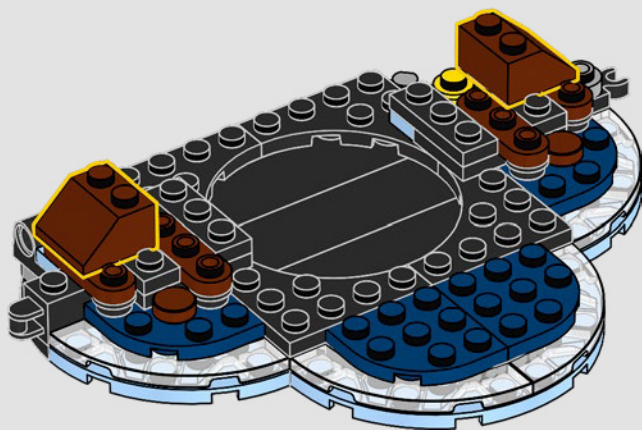

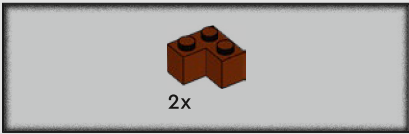

29

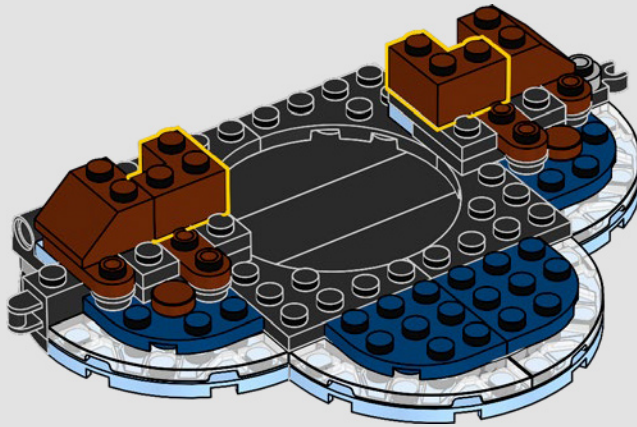

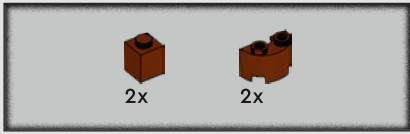

30

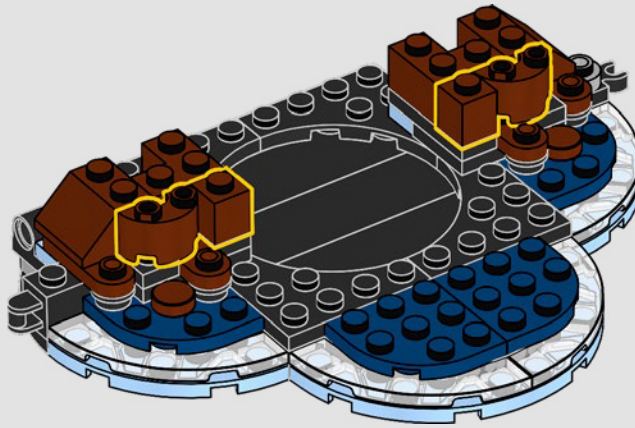

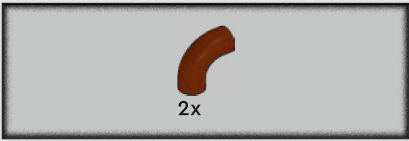

31

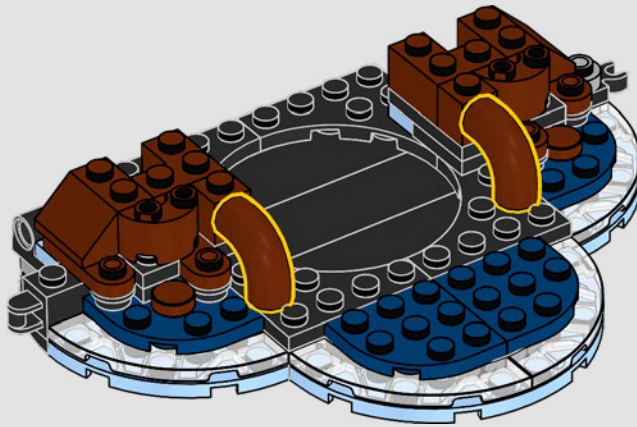



2x

32

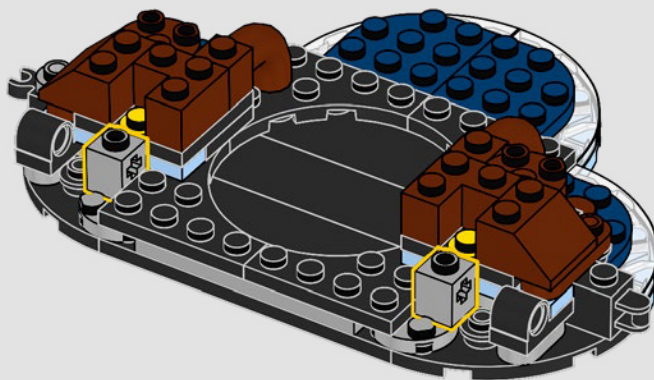

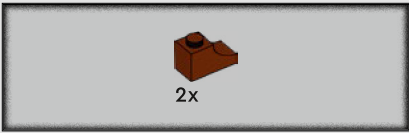

33

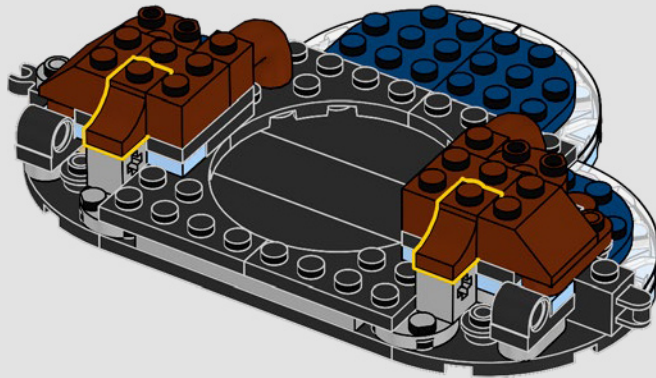

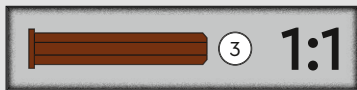
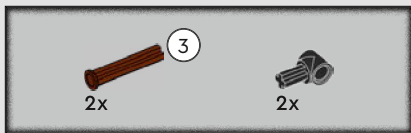

34

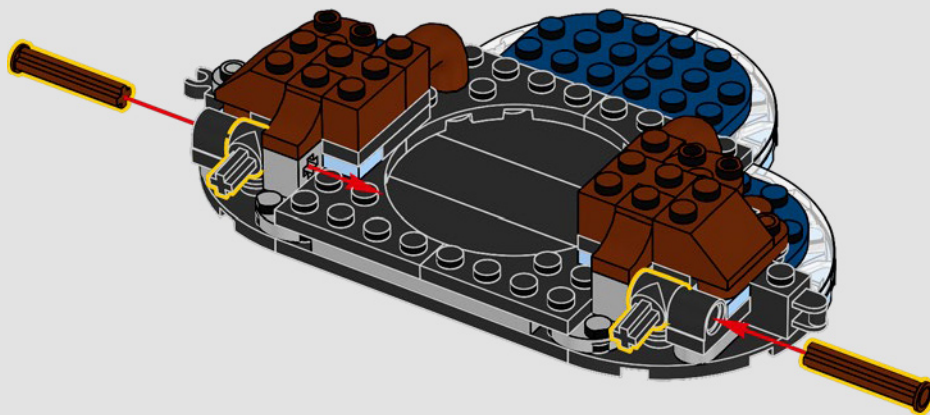

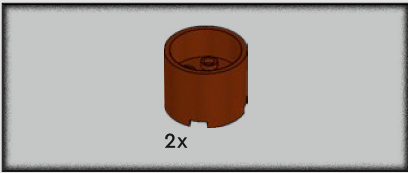

35

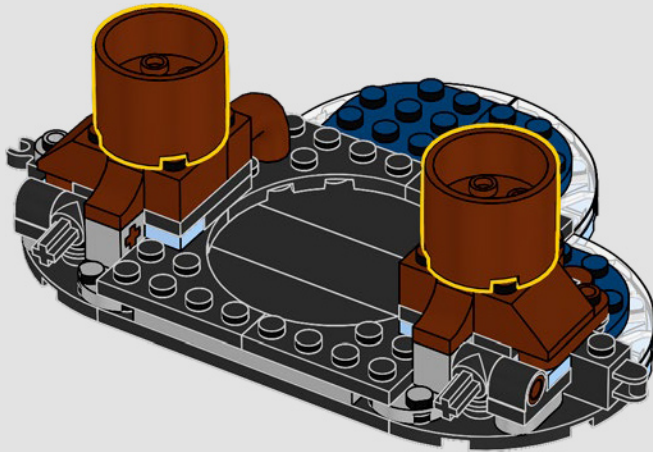

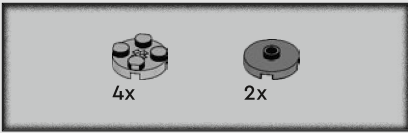

36

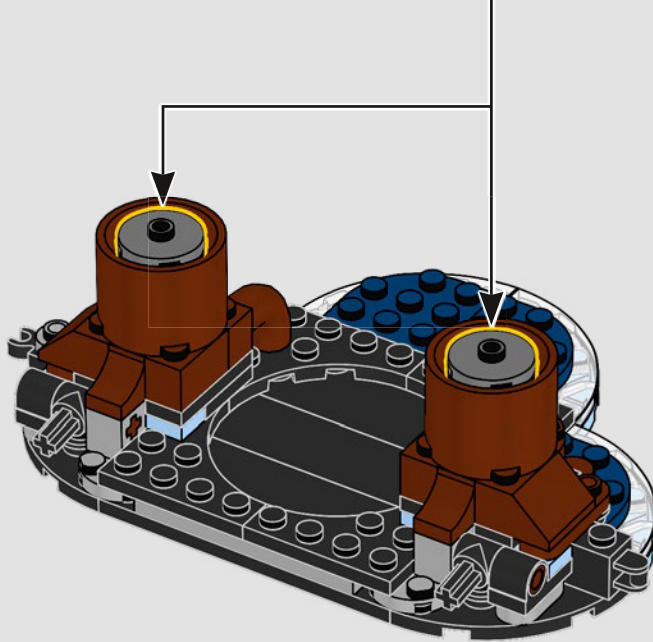
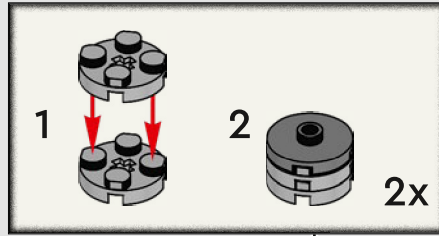

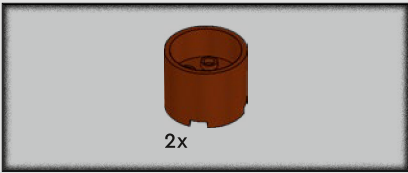

37

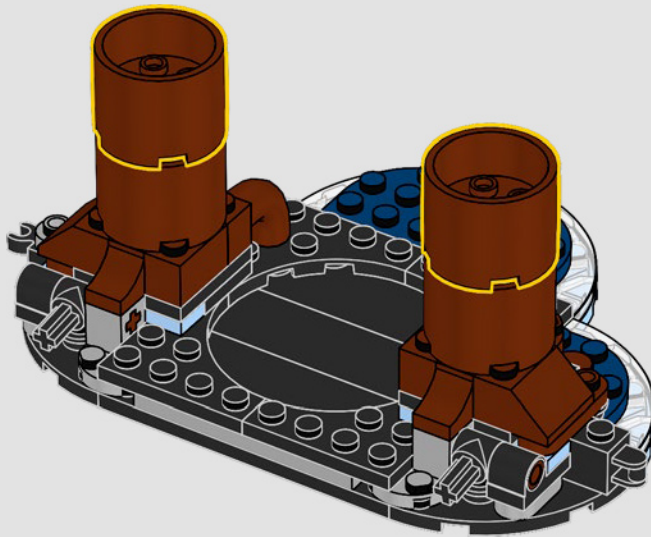

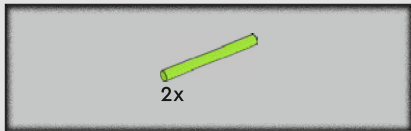

38

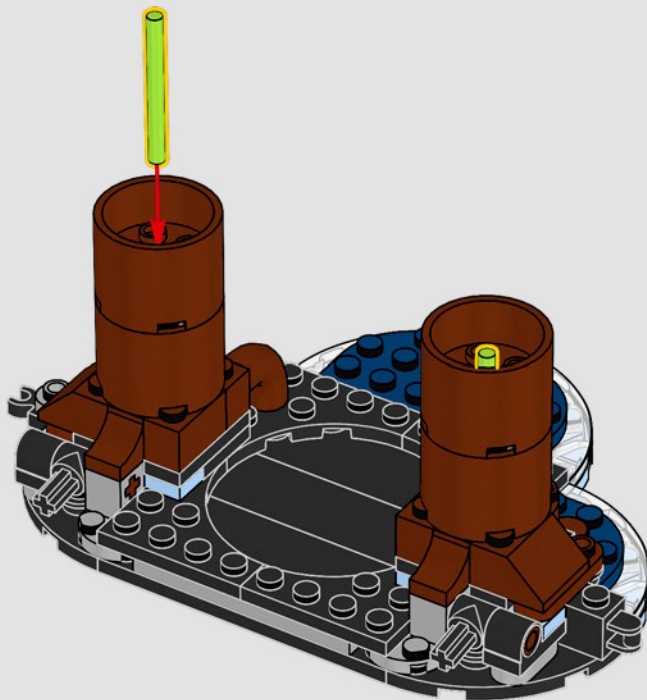

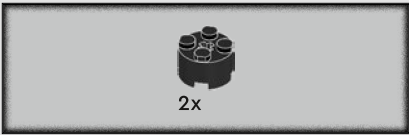

39

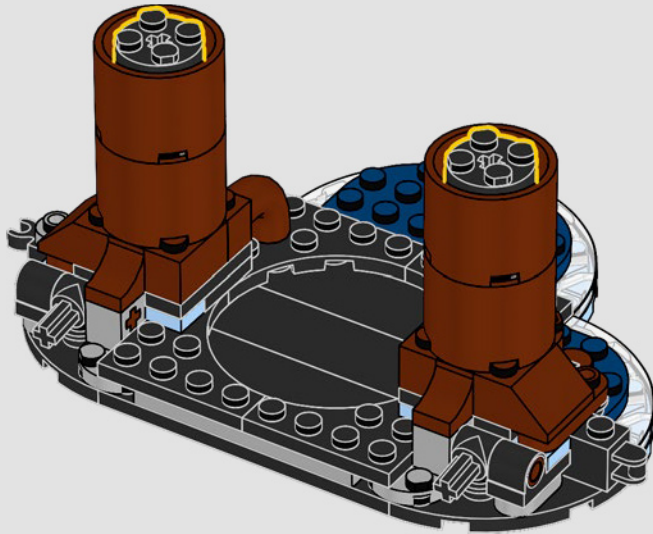

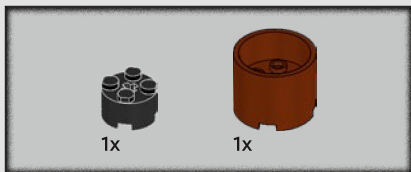

40

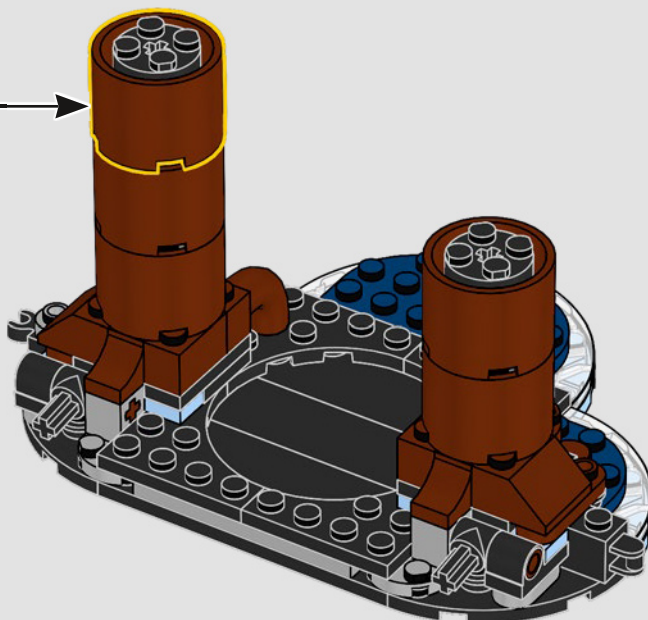
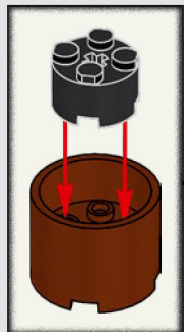

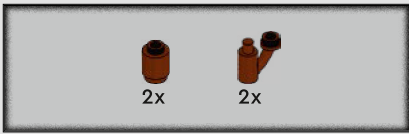

41

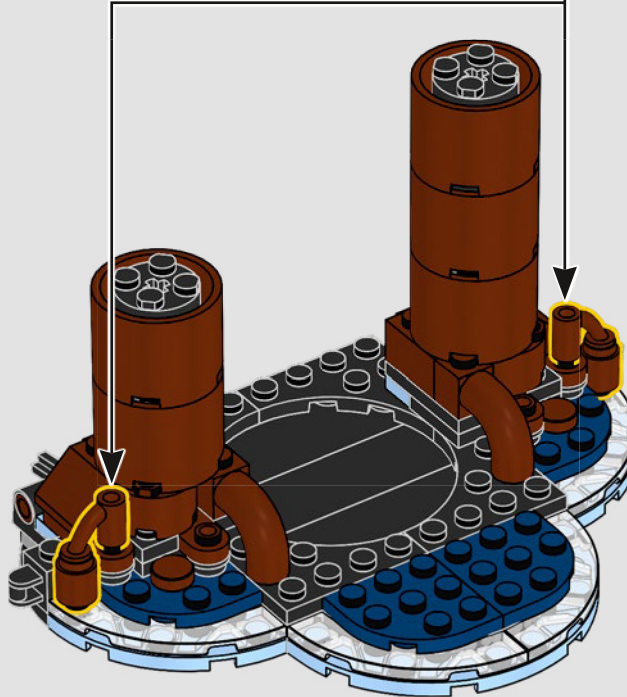
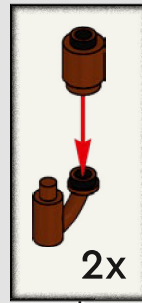



42

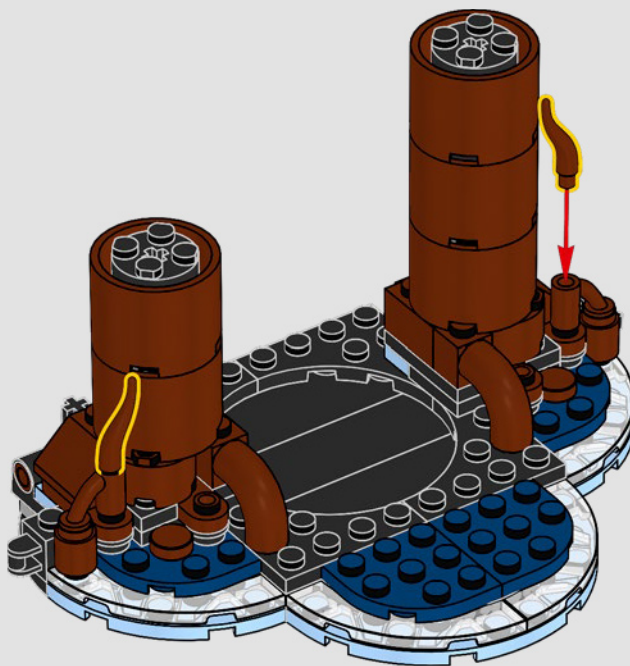

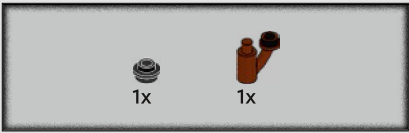

43

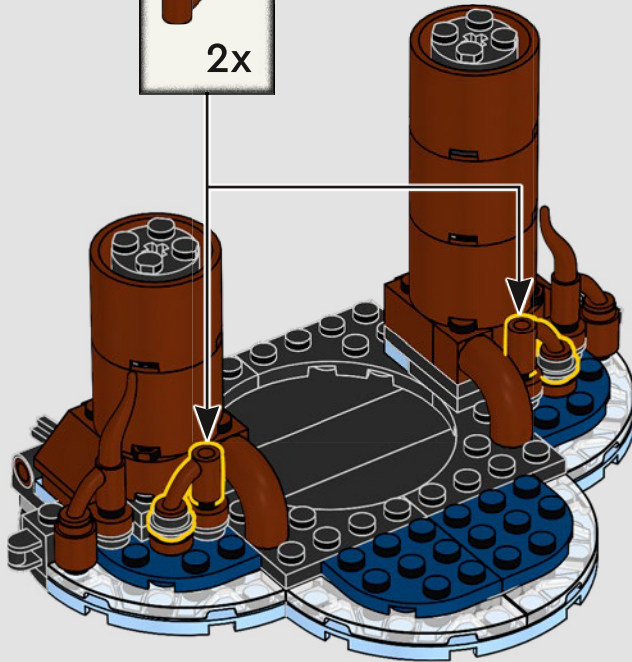
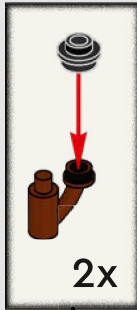

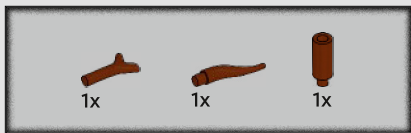

44

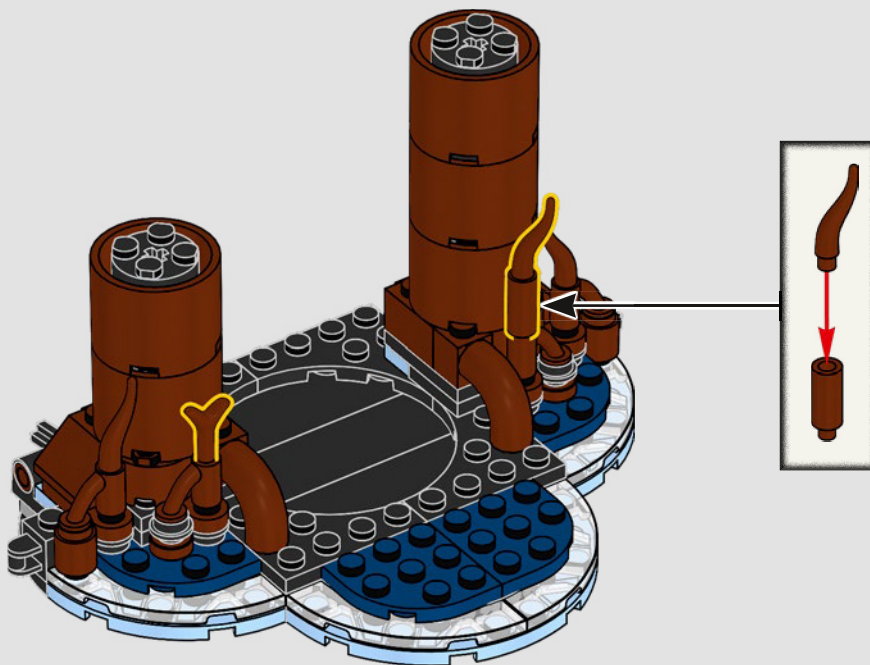



45

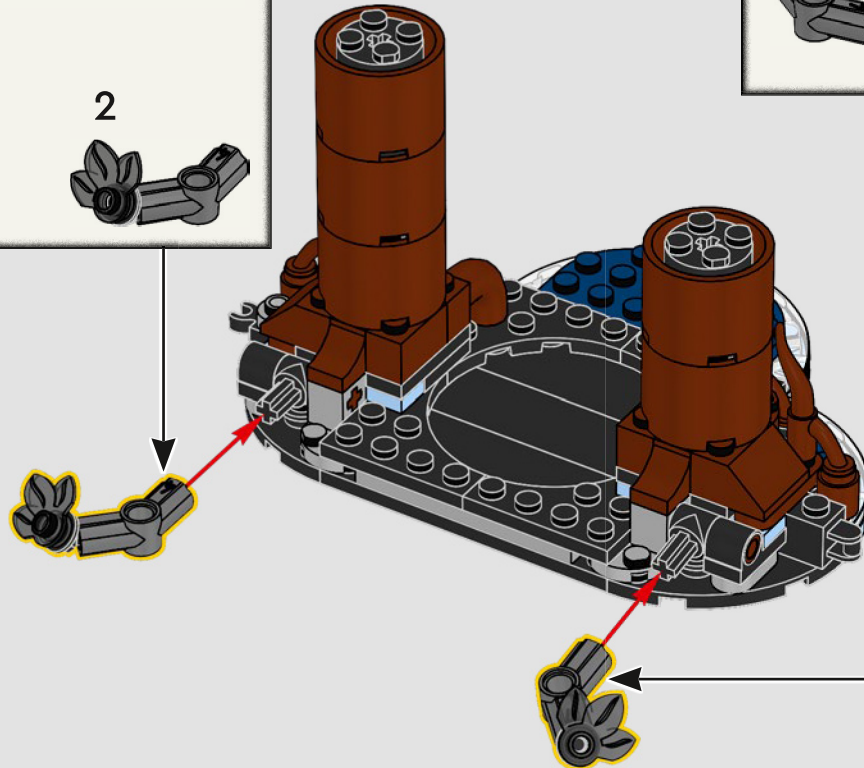
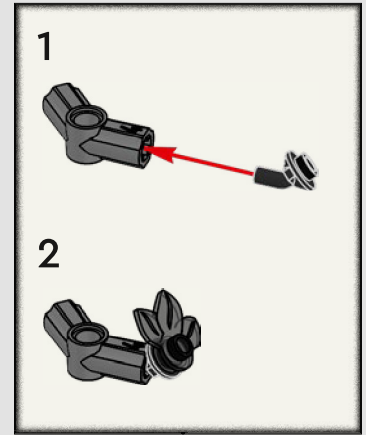
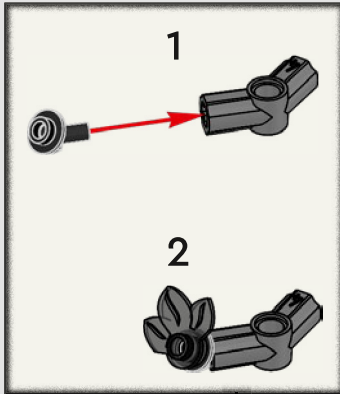

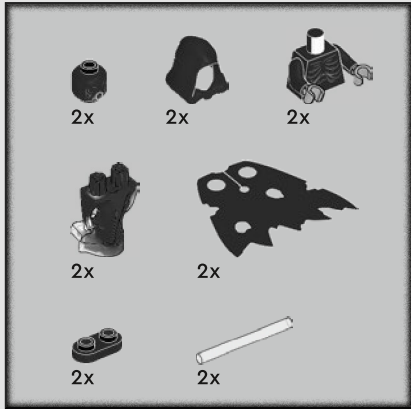
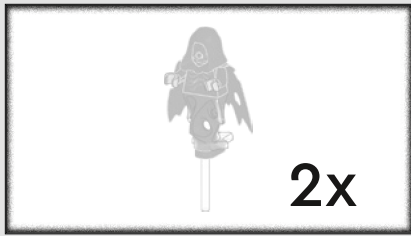

46

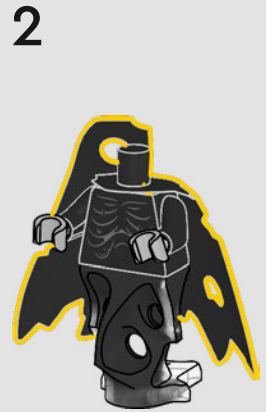
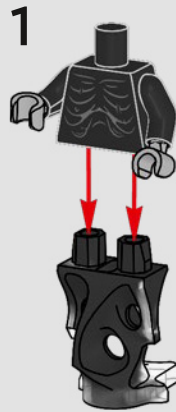

3

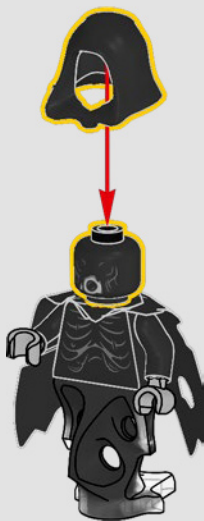

4

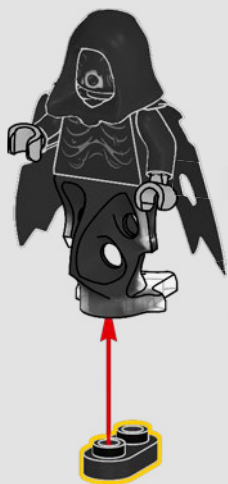

5



2x



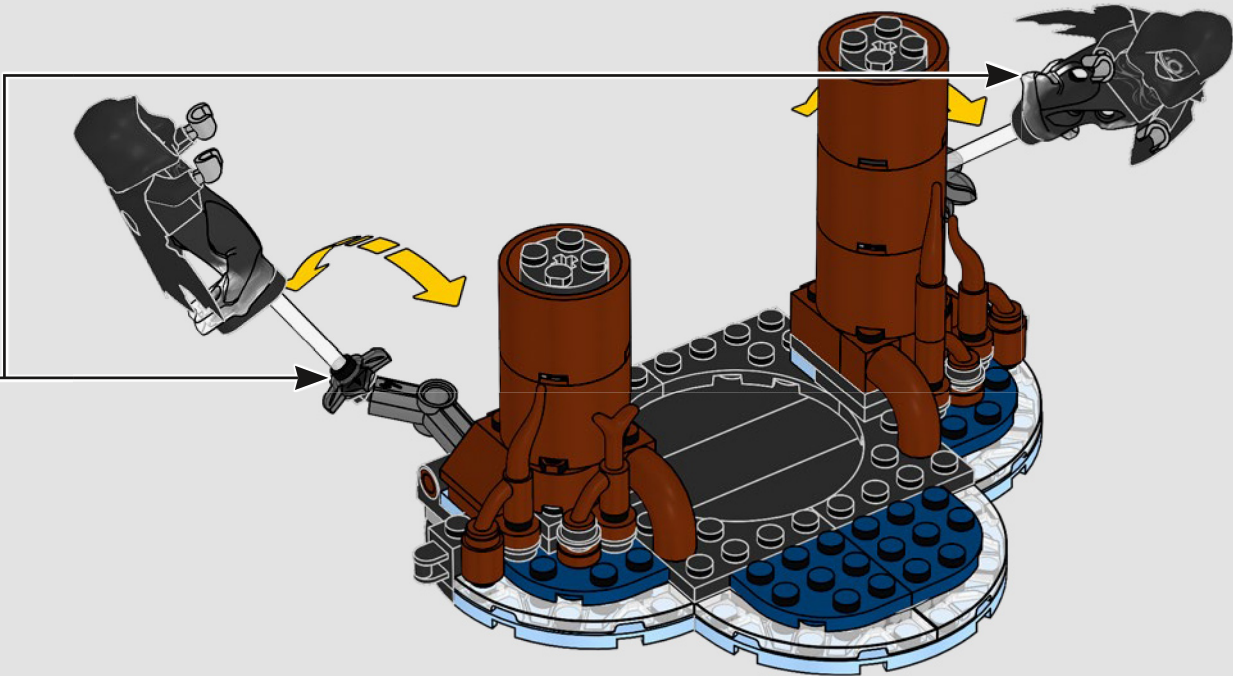





2x

47

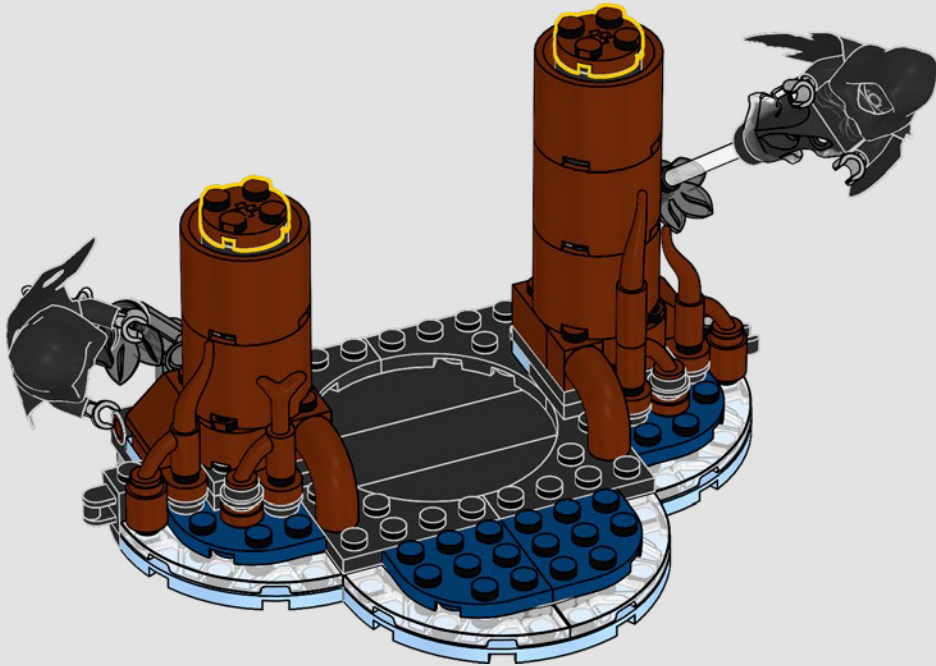



48

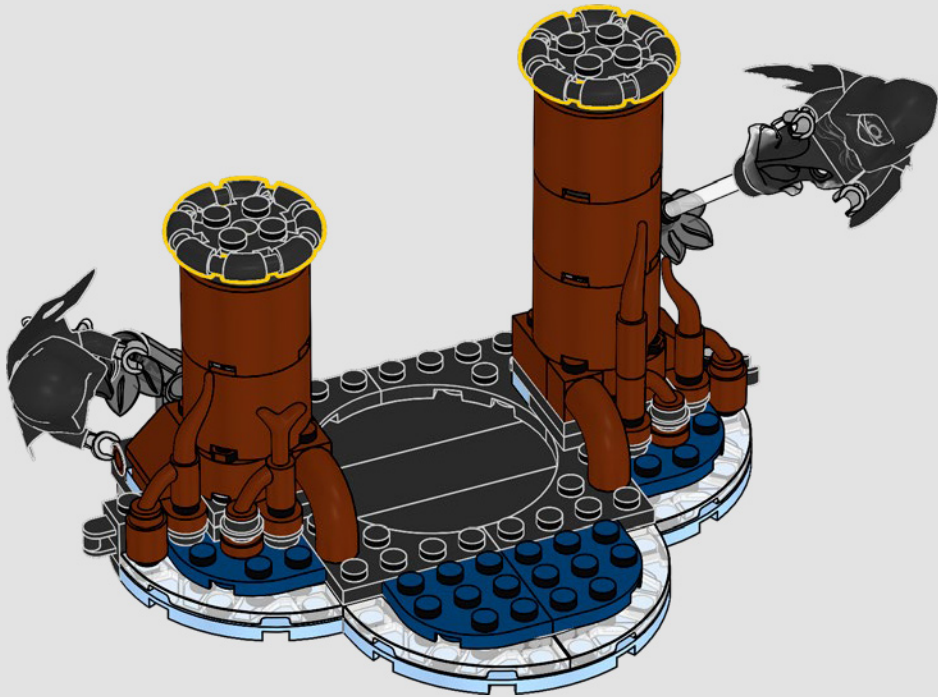



49

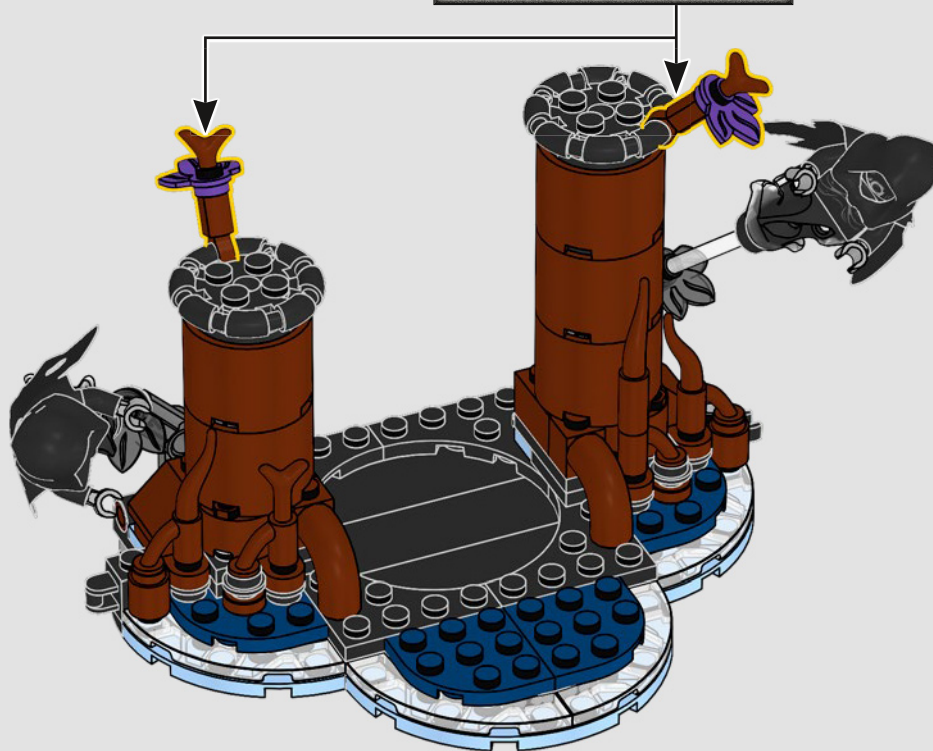
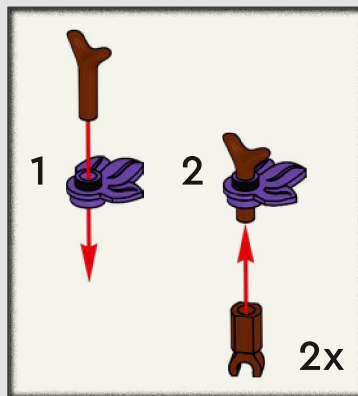



50

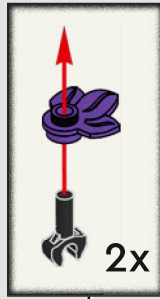

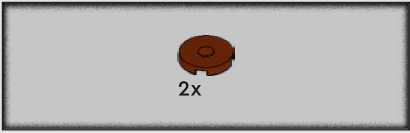

51



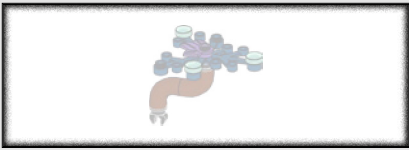

52

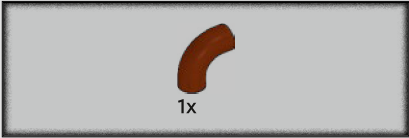

53

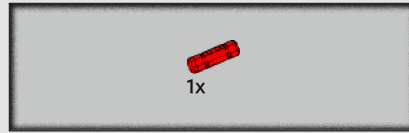
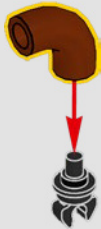

54



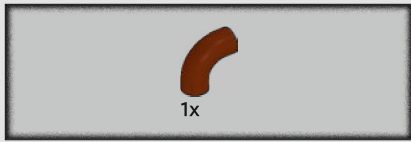

55

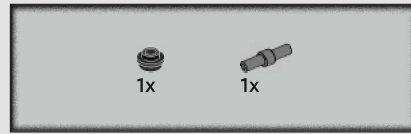
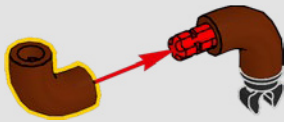

56

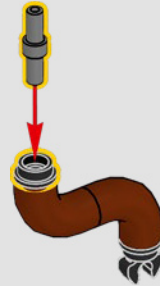

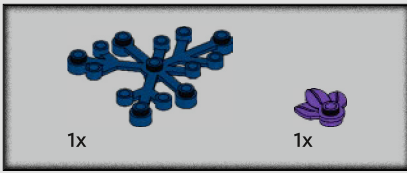

57

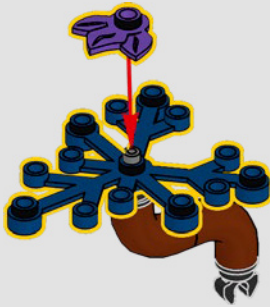

58

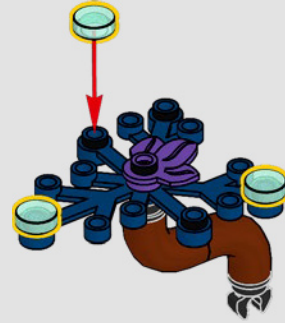

59



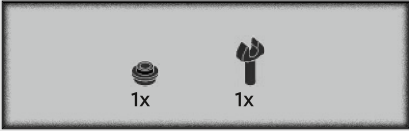

60



61

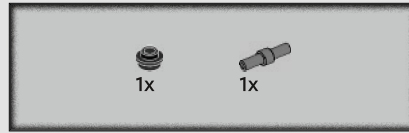

62

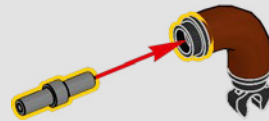

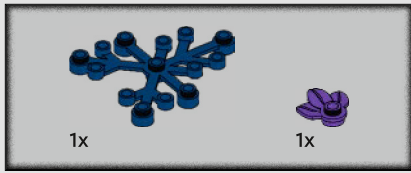

63



64

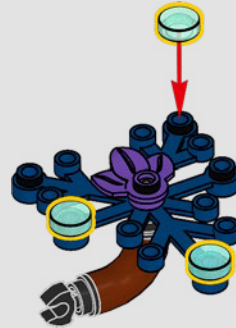





66

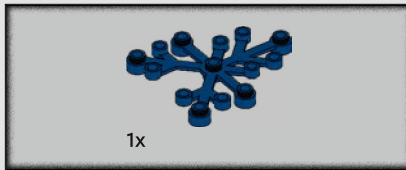

67



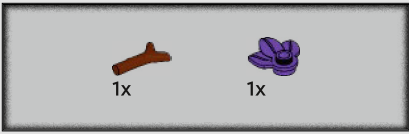

68



69

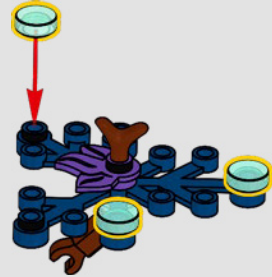

2x





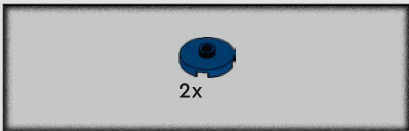

71





2x



2x

72



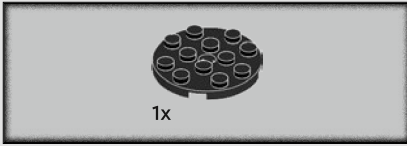

73

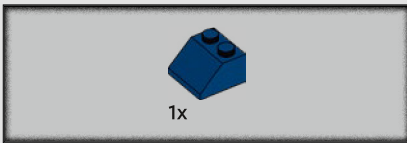

74

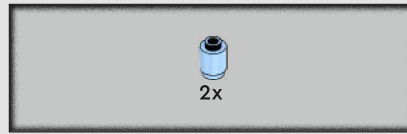

75



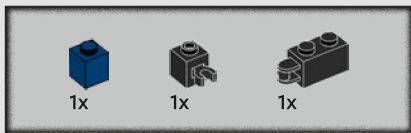

76

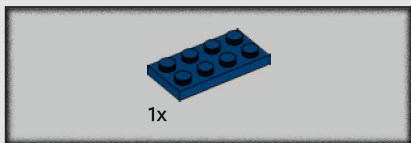
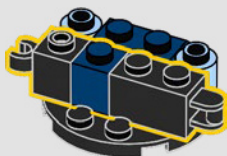

77

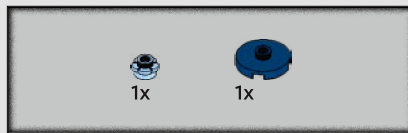
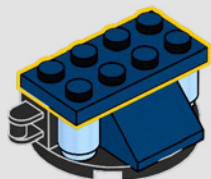

78

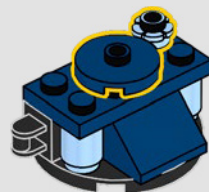

2x

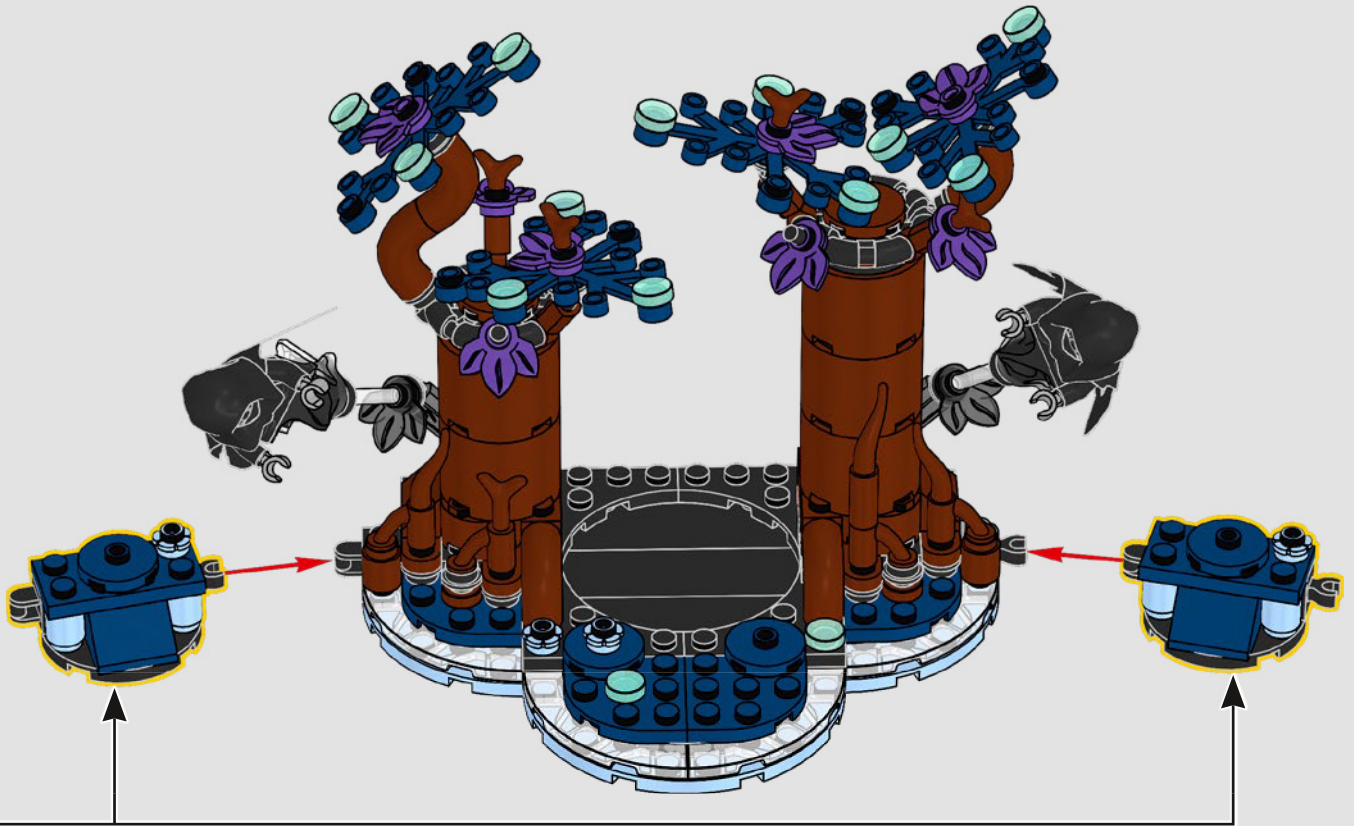



1x

80



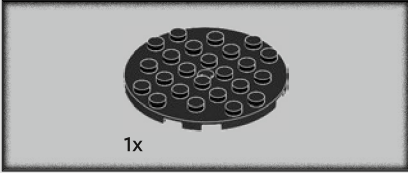
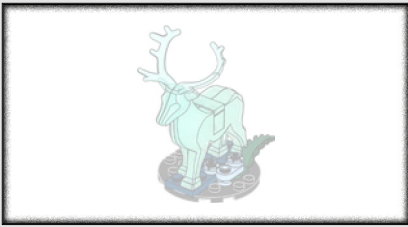

81

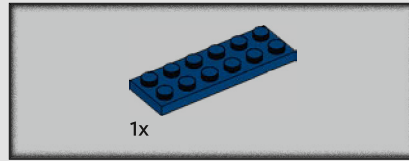
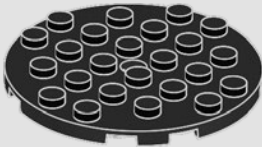

82

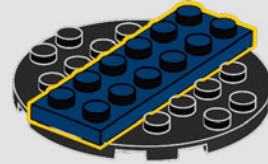

83

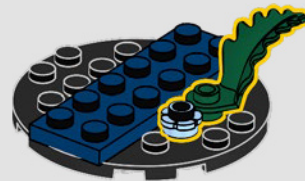



84

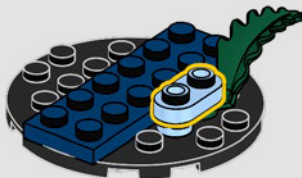

85



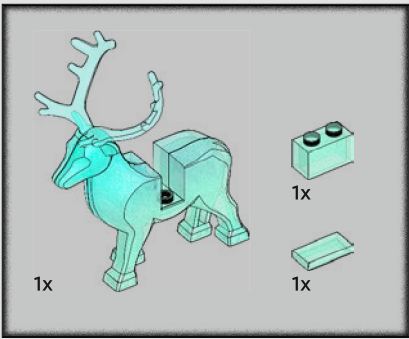

86

1

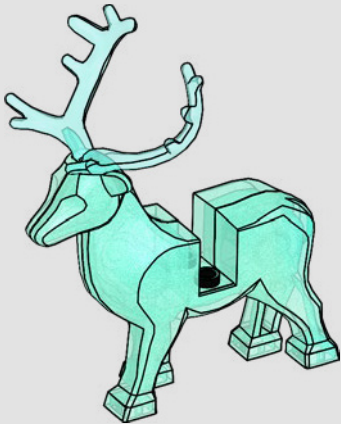

2

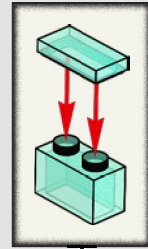
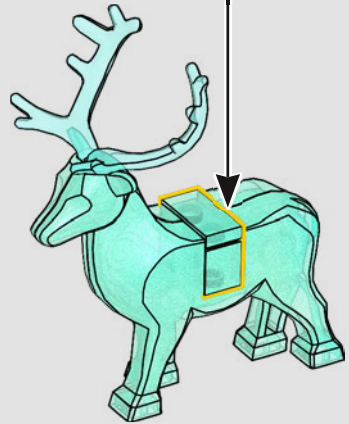



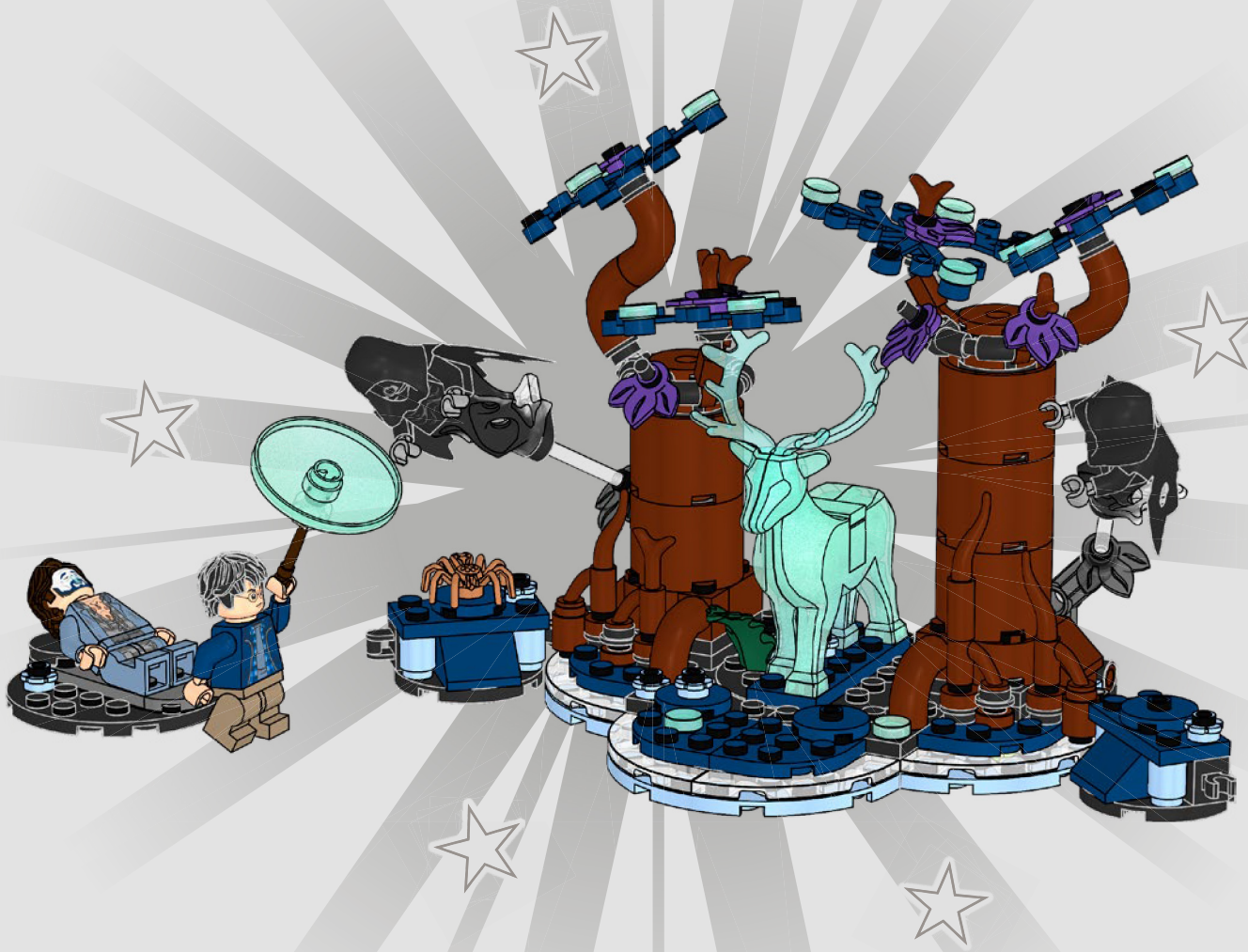



Harry Potter



76435



76463

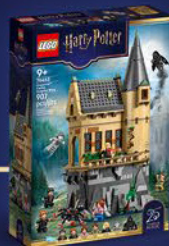

76445



Build the most detailed
HOGWARTS™
CASTLE

Construisez
**LE CHÂTEAU
DE POUDLARD**
le plus détaillé

Construye
**EL CASTILLO
DE HOGWARTS™**
más detallado



76454



76473



76447



Each set sold separately and available for
different periods of time

Les ensembles sont vendus séparément et à des
périodes différentes.

Cada set se vende por separado y está disponible
durante un cierto periodo de tiempo.



76464



76460



76463



76473



25
ANS DE
MAGIE

25
AÑOS DE
MAGIA

25
YEARS OF
MAGIC

Collectible
PATRONUSES

PATRONUS
à collectionner

PATRONUS
coleccionables

76475



76467



76471



76478



Each set sold separately and available for different periods of time
Les ensembles sont vendus séparément et à des périodes différentes.
Cada set se vende por separado y está disponible durante un cierto período de tiempo.



2x
6578978



2x
6016279



4x
6439039



2x
614124



1x
4142865



2x
4255413



4x
6510193



3x
6391341



2x
6253260



1x
302224



2x
6336539



4x
6253885



12x
6168646



4x
362326



2x
6210270



8x
6482646



8x
6248890



2x
4153653



1x
6350725



2x
302126



1x
6070695



1x
6581728



8x
4211475



1x
6529704



2x
6114987



3x
6318582



2x
6336977



1x
6612521



1x
4211438



4x
6251836



3x
614326



1x
6138405



1x
6233922



1x
6614733



2x
4210210



2x
4667595



4x
6208787



2x
6101857



2x
6537354



1x
6509114



2x
6327442



4x
6478110



2x
303526



2x
6594403



2x
6187587



2x
6115031



1x
6097420

1x
6422088

2x
4211159

1x
6507895

1x
6597878

14x
6514199

2x
6510078

4x
6341968

5x
6407771

2x
6507886

1x
6265371

1x
6514227

2x
6350724

2x
6284586

3x
6269077

4x
6544432

1x
6480597

1x
6514272

2x
6115080

2x
4211183

4x
6551600

2x
6504014

1x
6270032

1x
6622495

2x
6262899

4x
6433717

2x
6135494

4x
6215387

1x
6605239

1x
6578808

2x
6257592

2x
4211242

2x
4211200

8x
6209683

1x
6234805

1x
6372122

2x
6514463

2x
6092568

5x
6078605

2x
6478179

2x
6365885

2x
4211202

2x
6361988

2x
6383102

1x
6387468

5x
6559244



 [LEGO.com/service](https://www.LEGO.com/service)

YOU COULD **WIN**



Scan this QR code or go to **LEGO.COM/PRODUCTFEEDBACK** and give us your short feedback about this LEGO® set for a chance to win a cool LEGO prize.

Terms and Conditions apply*

EN: YOU COULD WIN. Terms and Conditions apply* **DE: Du könntest GEWINNEN.** Es gelten die Teilnahmebedingungen* **FR: TU POURRAIS GAGNER.** Des conditions s'appliquent* **IT: Potresti VINCERE tu.** Termini e condizioni sono applicabili* **ES: PUEDES GANAR.** Aplican términos y condiciones* **PT: PODERÁ GANHAR.** Aplicam-se Termos e Condições* **ZH: 轻松获奖. 条款和条件适用*** **PL: Szansa na WYGRANĄ.** Obowiązuje regulamin* **CS: Máte šanci VYHRÁT.** Platí všeobecné smluvní podmínky* **SK: Máte šancu VYHRÁŤ.** Platia všeobecné zmluvné podmienky* **HU: TE IS NYERHETSZ!** Felhasználási feltételek érvényesek* **UA: ВИ МОЖЕТЕ ВИГРАТИ.** Застосовуються загальні положення та умови* **RO: Ai putea CÂȘTIGA.** Se aplică termeni și condiții* **BG: Можете да СПЕЧЕЛИТЕ.** Има определени правила и условия* **LV: Tu vari LAIMĒT.** Ir spēkā noteikumi un nosacījumi.* **ET: Sul on võimalus VÕITA.** Kehtivad tingimused* **LT: Jūs galite LAIMĖTI.** Taikomos sąlygos* **TR: KAZANABİLİRSİN.** Şartlar ve Koşullar geçerlidir*

*[LEGO.com/productfeedback-terms](https://www.lego.com/productfeedback-terms)

LEGO and the LEGO logo are trademarks of the/son des marques de commerce du/son marcas registradas de LEGO Group. ©2026 The LEGO Group.

All HARRY POTTER characters and elements © & ™ Warner Bros. Entertainment Inc. Publishing Rights © JKR. All Rights Reserved. Used with permission. (s26)

 6650629