

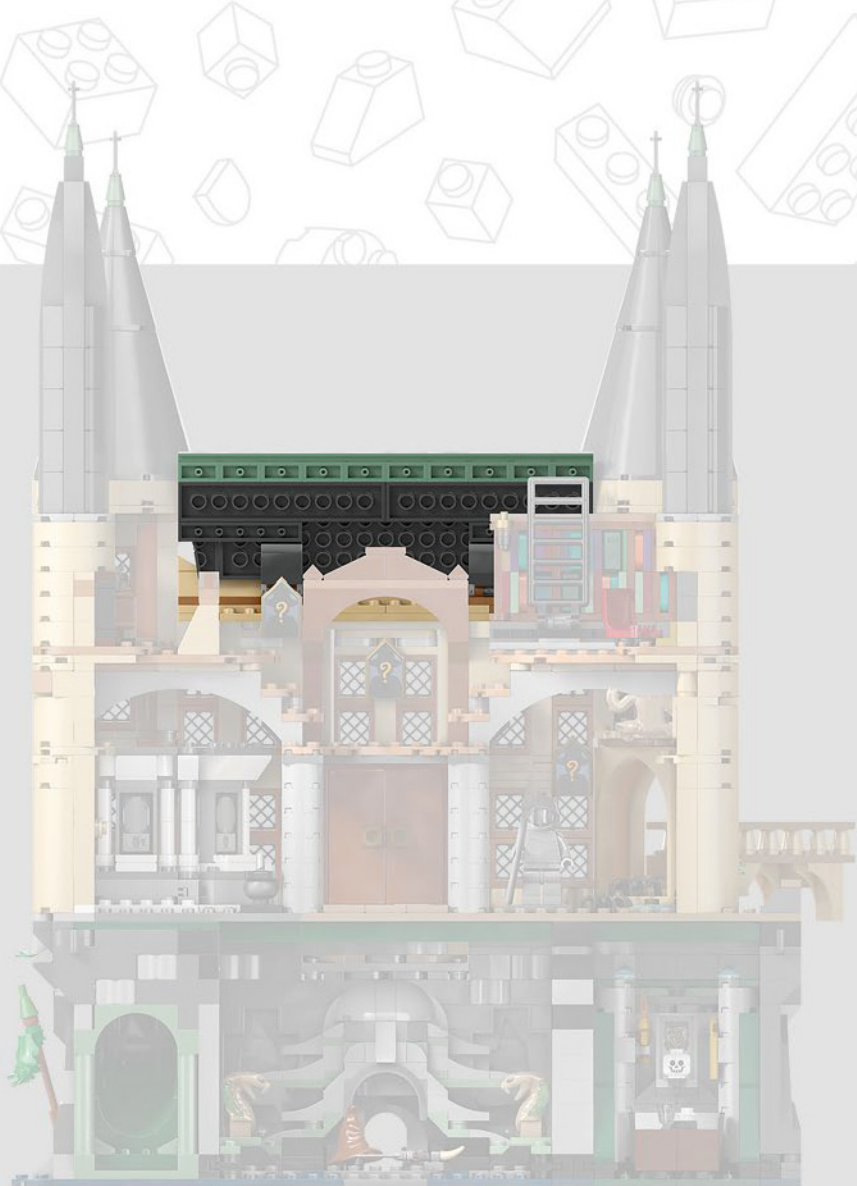

Harry Potter

76473



13

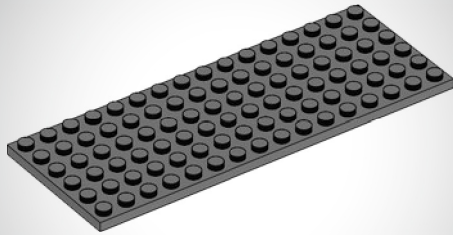
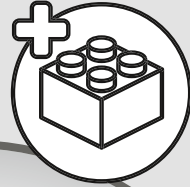

1x

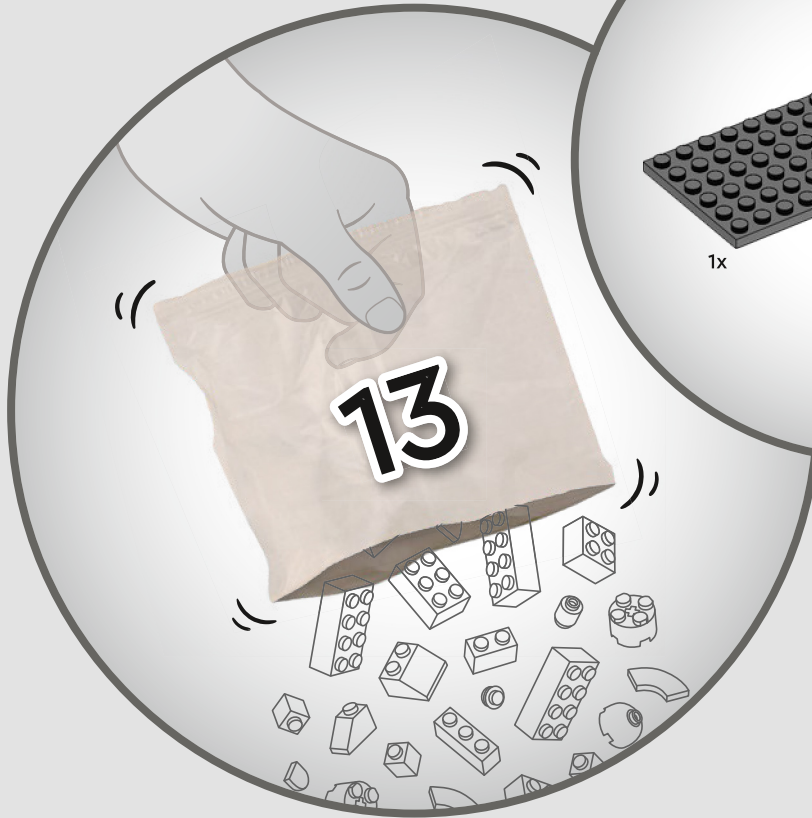

1

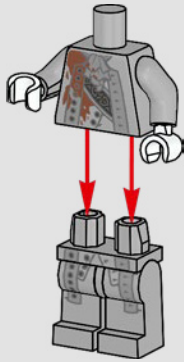

2

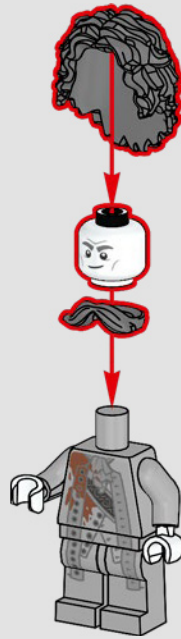

3



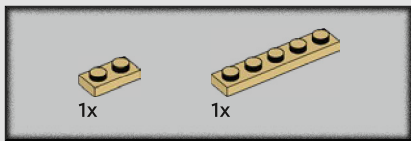

1

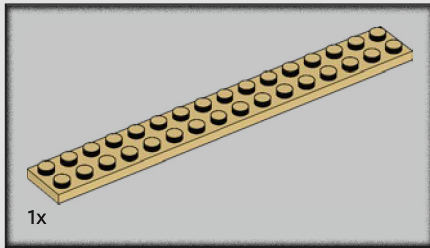
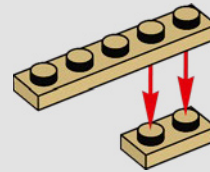

2

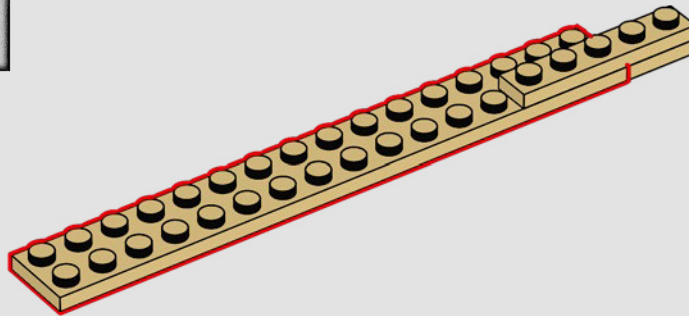

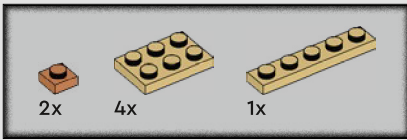

3

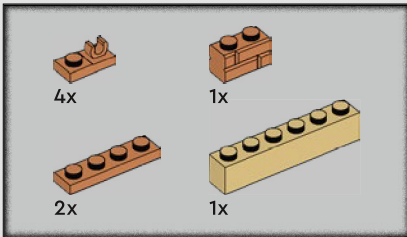
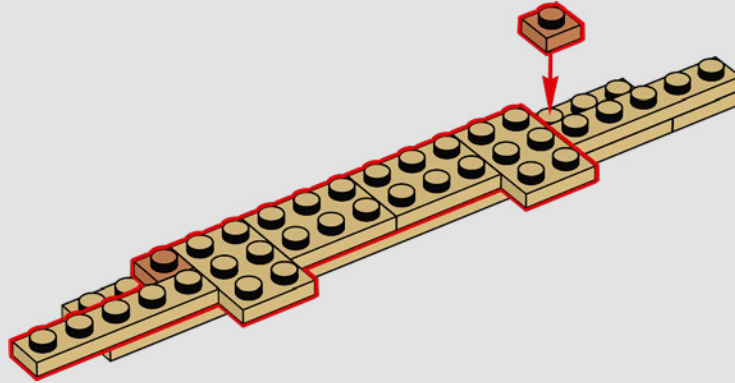

4

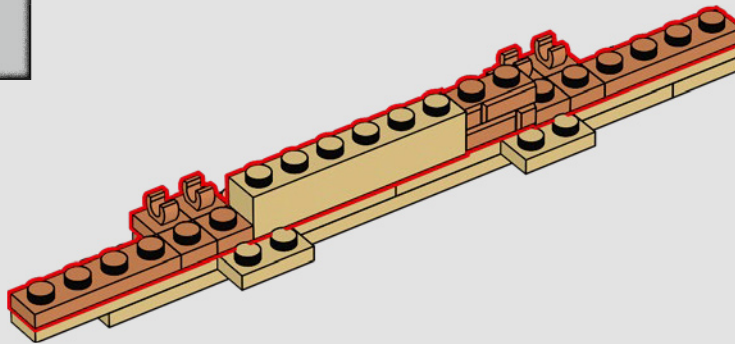

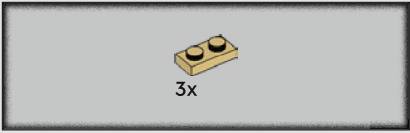

5

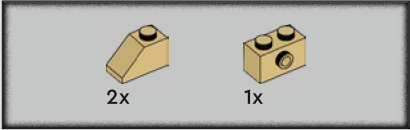
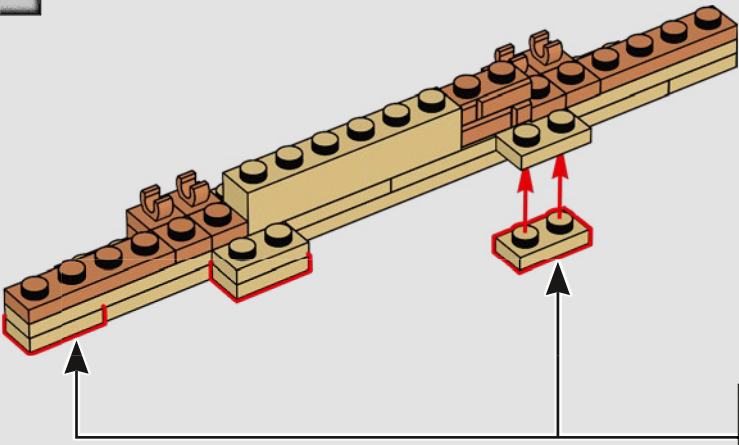

6

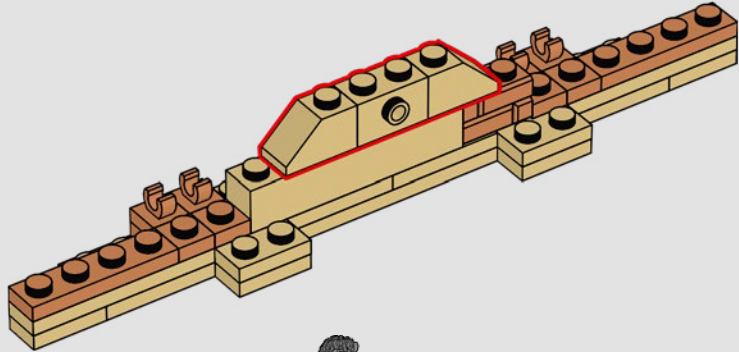

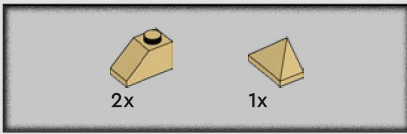

7

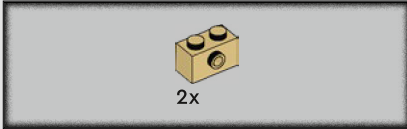
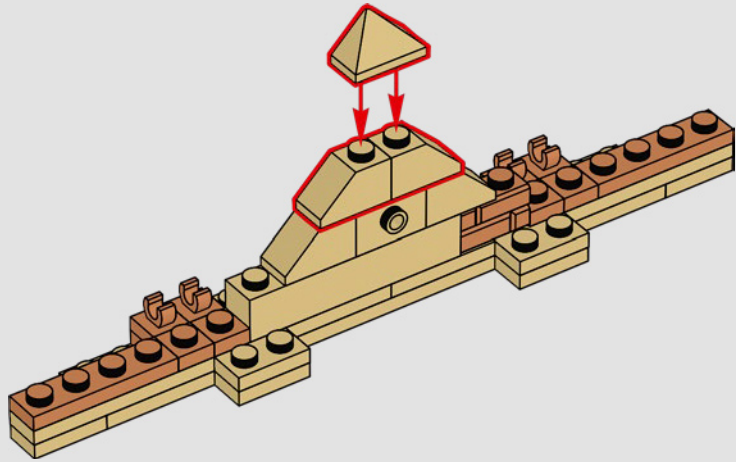

8

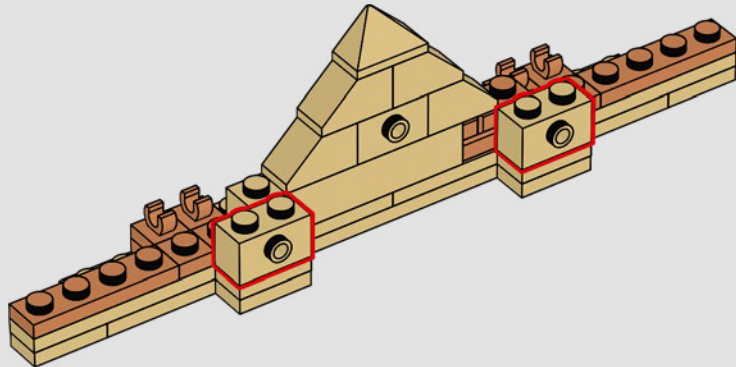

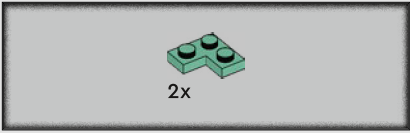

9

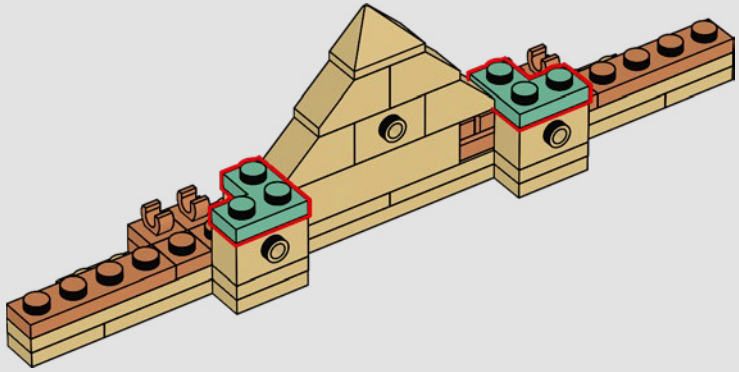

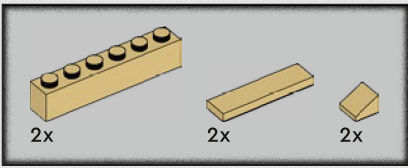

10

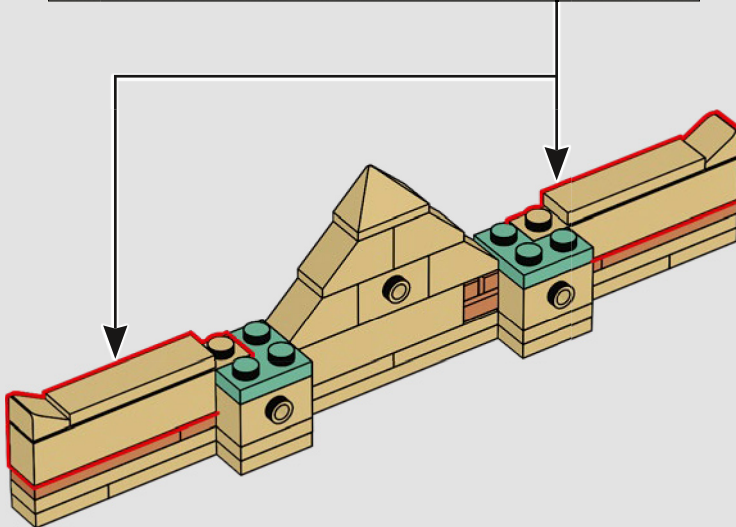
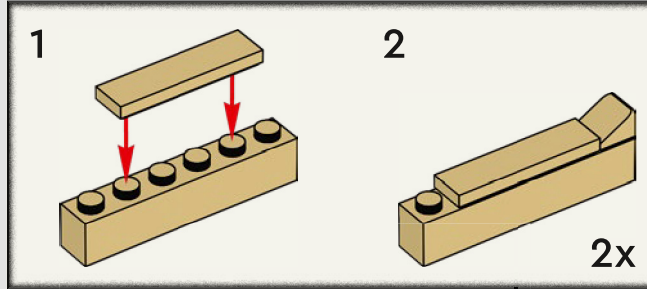

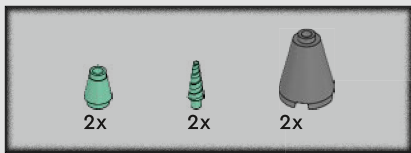

11

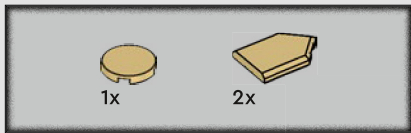
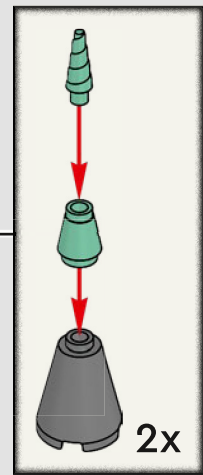
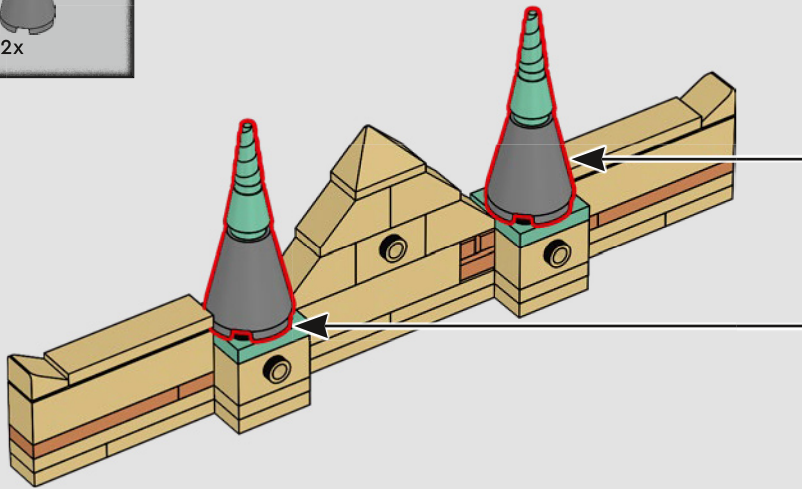

12

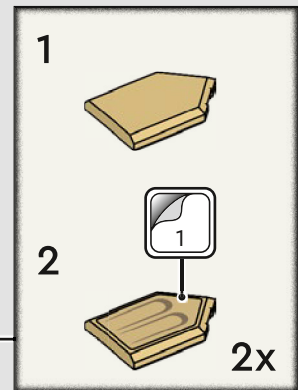
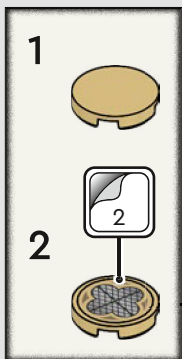
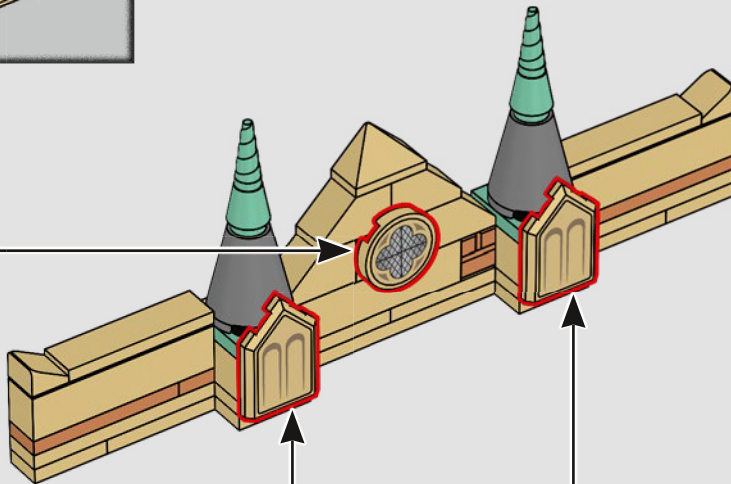

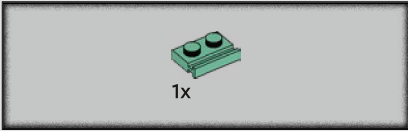
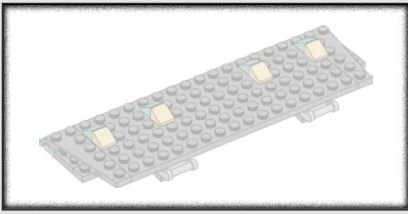

1x

13

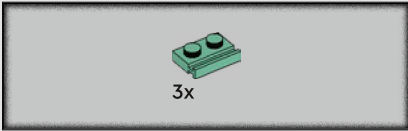
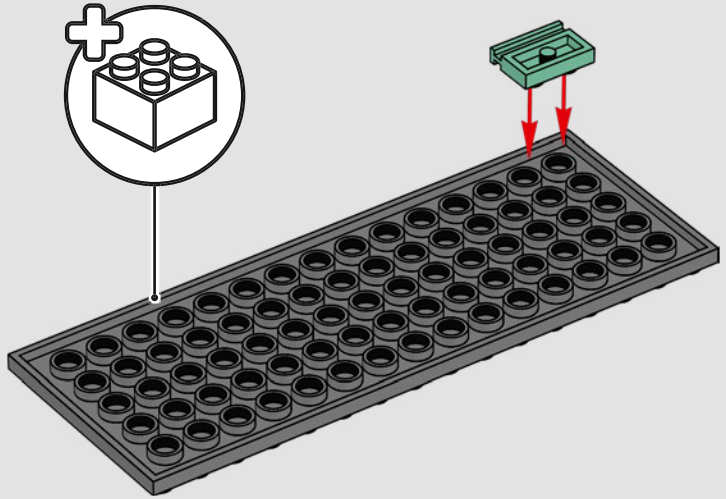

3x

14

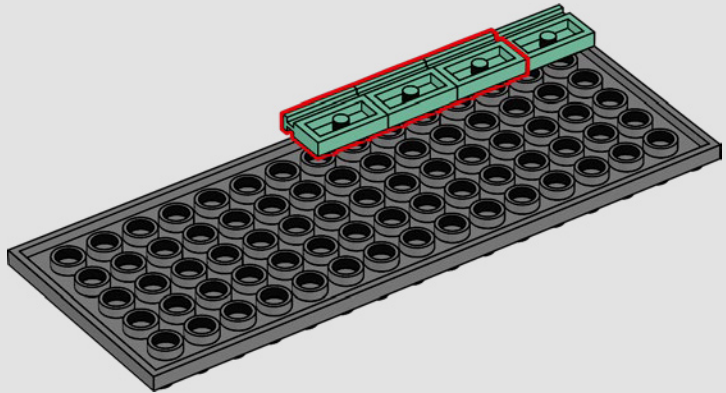

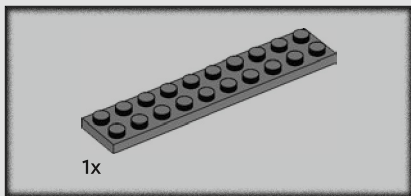

15

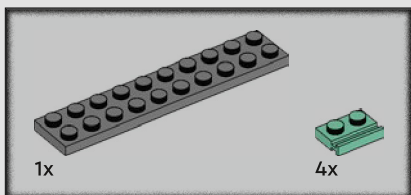
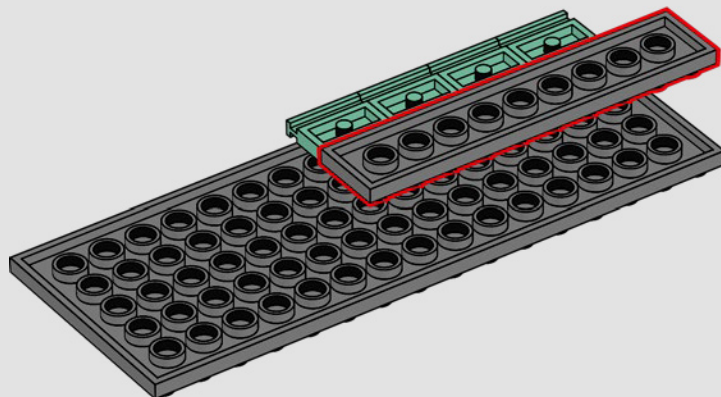

16

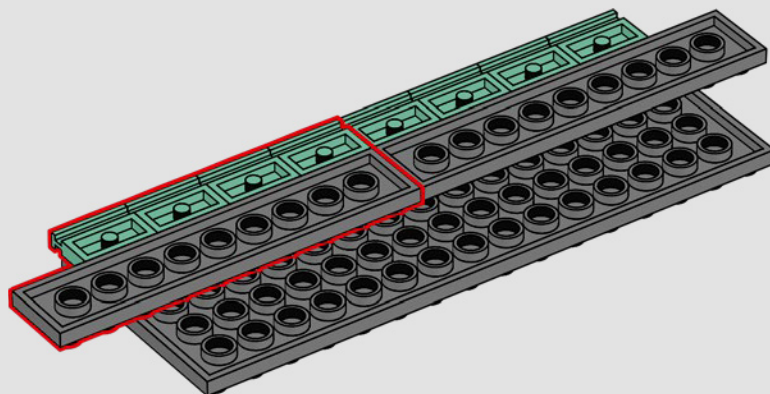

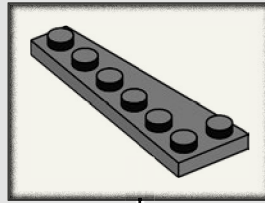
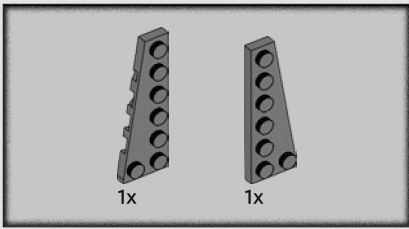

17

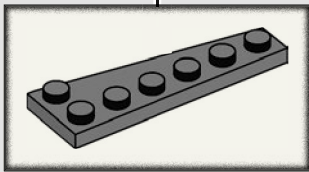
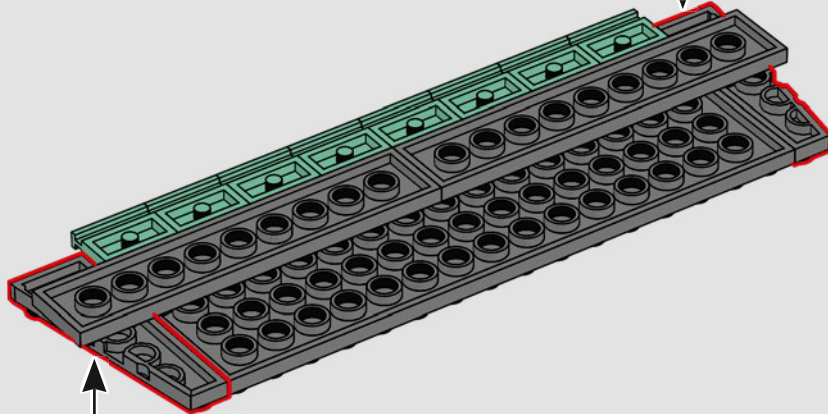

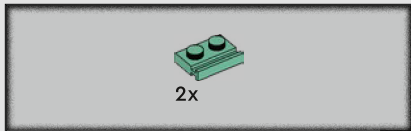

18

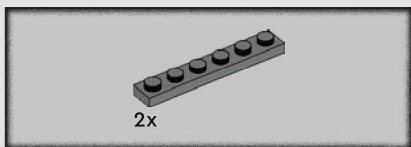
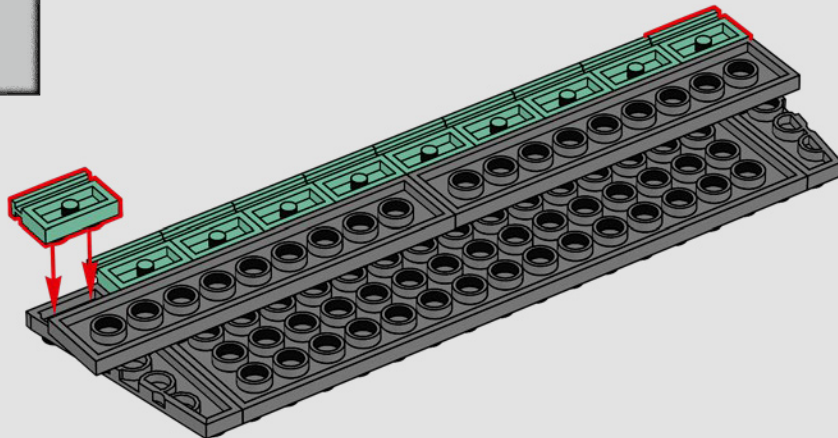

19

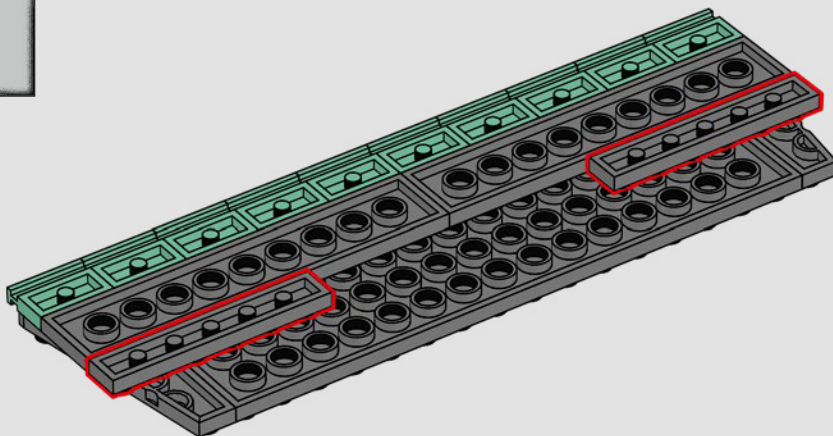

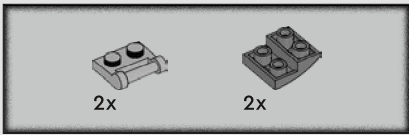

20

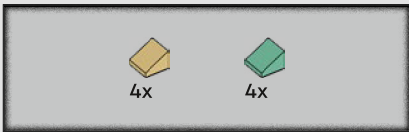
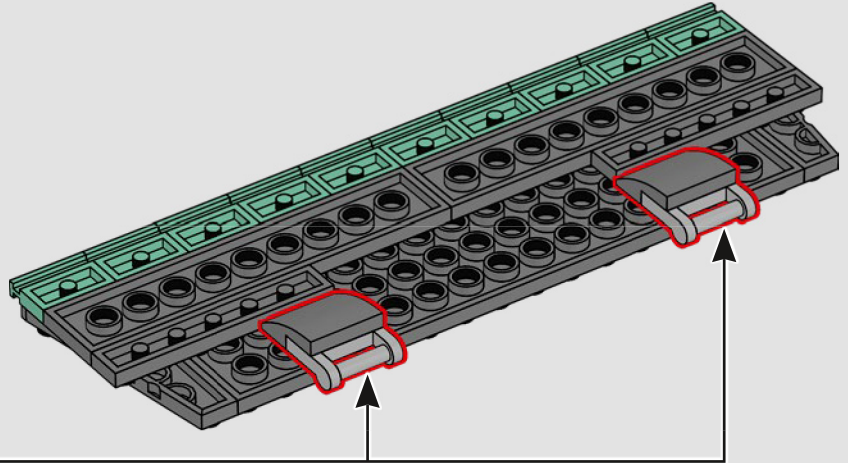
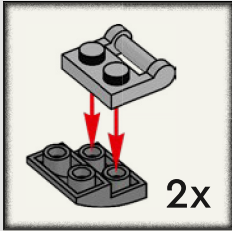

21

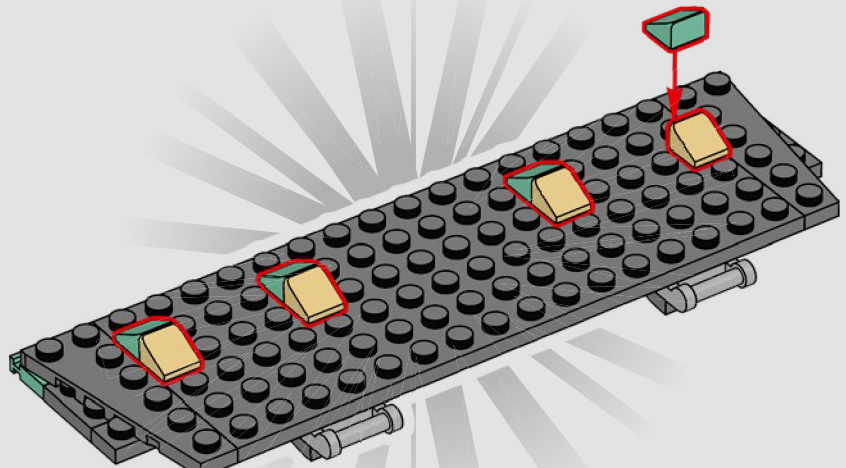

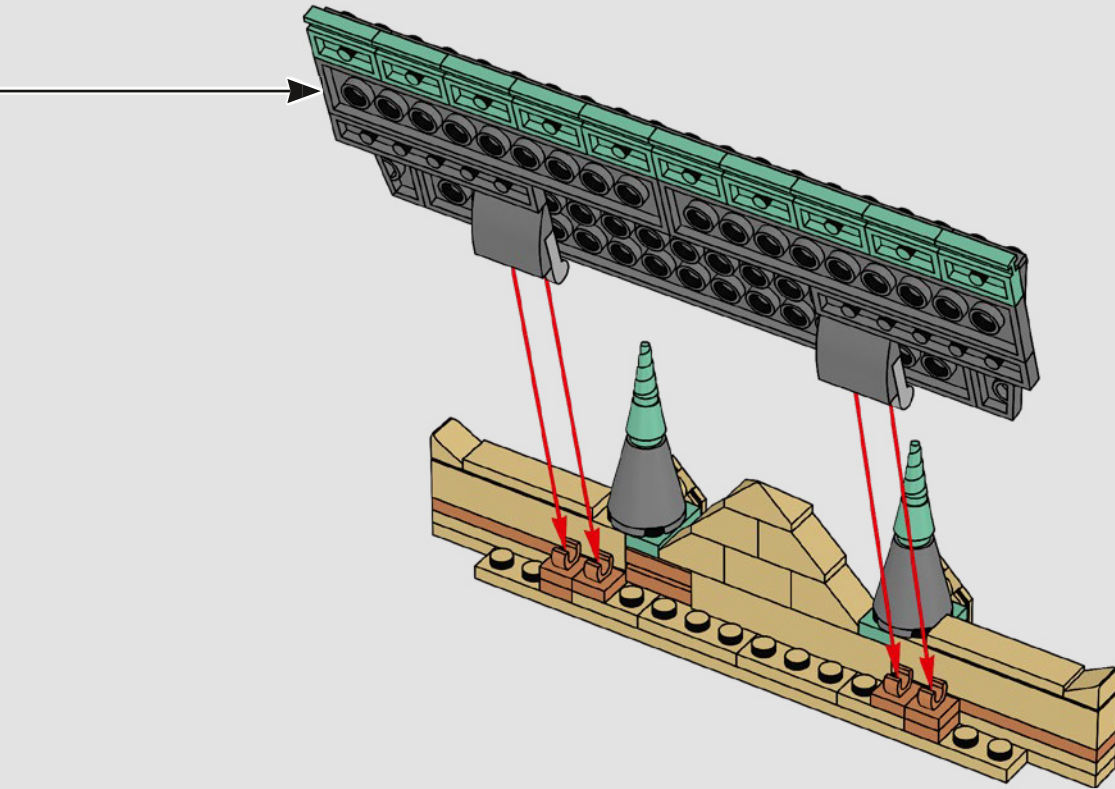

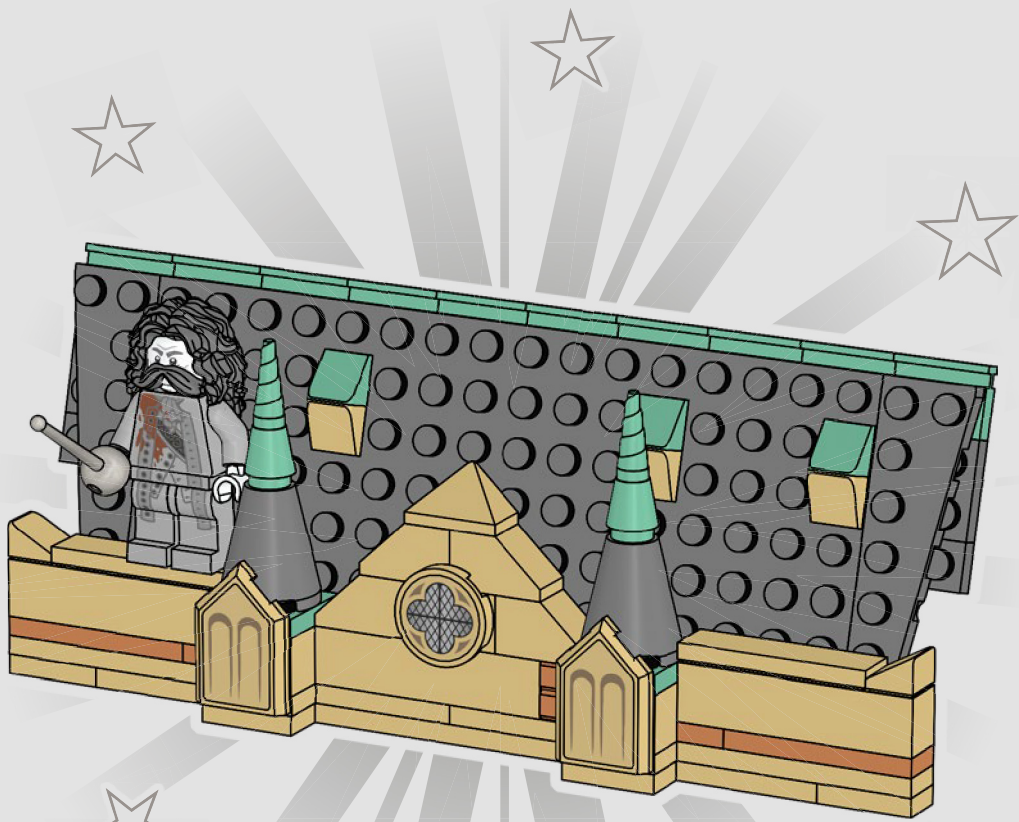

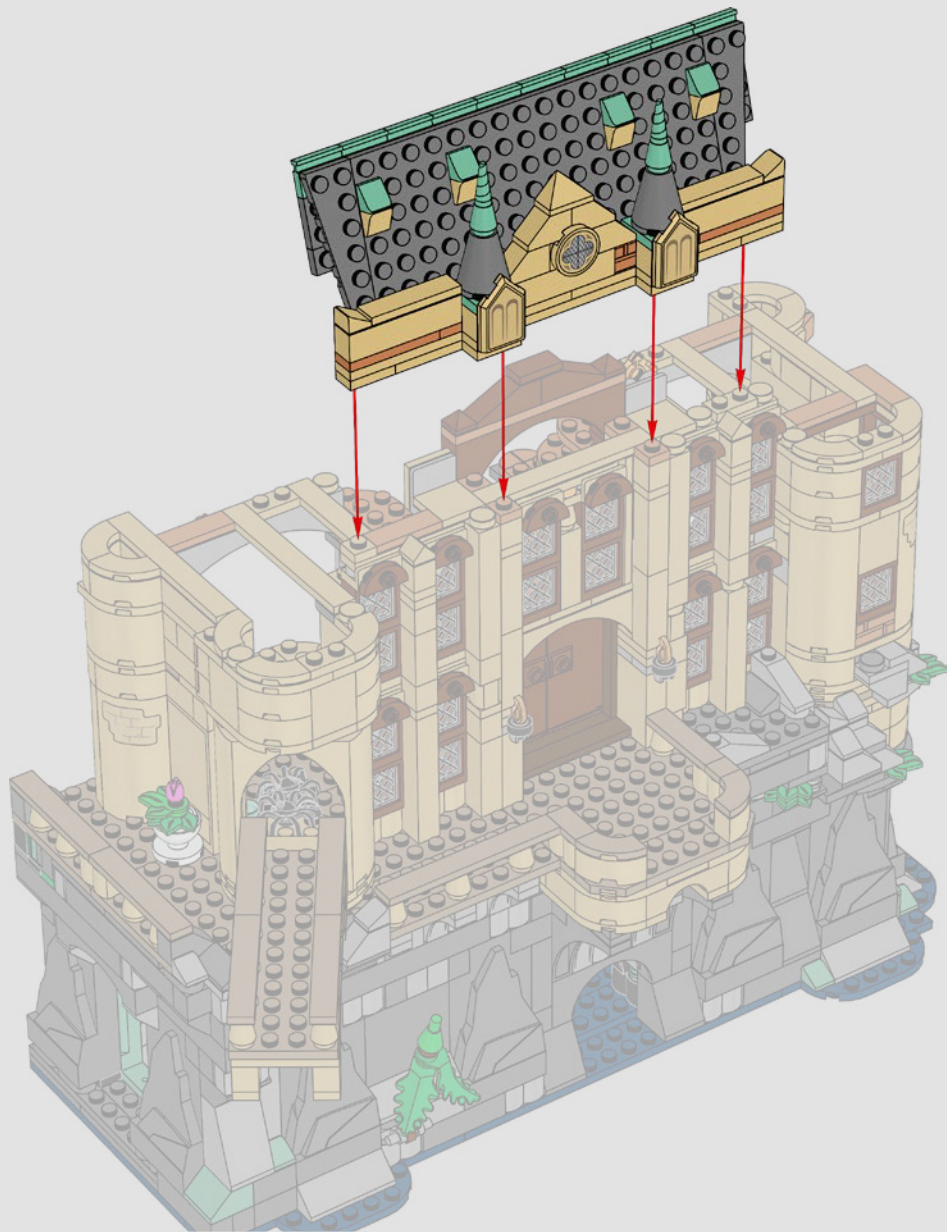





LEGO and the LEGO logo are trademarks of the/son des marques de commerce du/son marcas registradas de LEGO Group. ©2026 The LEGO Group.

All HARRY POTTER characters and elements © & ™ Warner Bros. Entertainment Inc. Publishing Rights © JKR. All Rights Reserved. Used with permission. (s26)