



# Harry Potter

76475



LEGO® Builder



LEGO.com/sustainable-packaging



FR  
**DONNEZ**  
OU  
**RECYCLEZ**



OU



OU



ASSOCIATION

MAGASIN

DÉCHÈTERIE

Adresses sur [quefairedemesdechets.fr](http://quefairedemesdechets.fr)

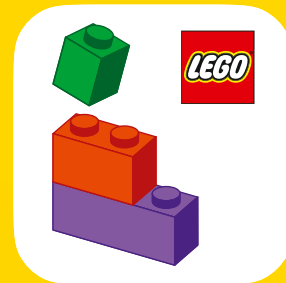

LEGO® Builder



# BUILDER



Apple and the Apple logo are trademarks of Apple Inc., registered in the U.S. and other countries and regions. App Store is a service mark of Apple Inc. Google Play and the Google Play logo are trademarks of Google LLC. Tencent and the Tencent logo are trademarks of Tencent Inc.

[LEGO.com/devicecheck](http://LEGO.com/devicecheck)

**EN** Ask parents' permission before going online | **DE** Eltern um Erlaubnis bitten, bevor du online gehst | **FR** Demande l'autorisation d'un parent avant d'aller en ligne | **IT** Chiedi il permesso ai tuoi genitori prima di andare online | **ES** Pídeles permiso a tus papás antes de conectarte a Internet | **PT** Pede autorização aos teus pais antes de ficares online | **ZH** 上网前应先征得父母的同意 | **PL** Poproś rodziców o zgodę, zanim wejdiesz do Internetu | **CS** Než půjdeš na internet, požádej rodiče o svolení | **SK** Skôr než pôjdeš na internet, vypýtaj si povolenie od rodičov | **HU** Kérj szülői engedélyt, mielőtt online csatlakoznál! | **UA** Запитуйте дозволу батьків, перш ніж користуватися інтернетом | **RO** Cere permisiunea părinților înainte de a te conecta online | **BG** Поискайте разрешение от родител, преди да влезете онлайн | **LV** Pirms došanās tiešsaistē palūdz atļauju vecākiem | **ET** Enne Interneti kasutamist küsi vanematelt luba | **LT** Prieš prisijungdami prie interneto, atsiklauskite tėvų | **TR** İnternete girmeden önce anne babadan izin iste

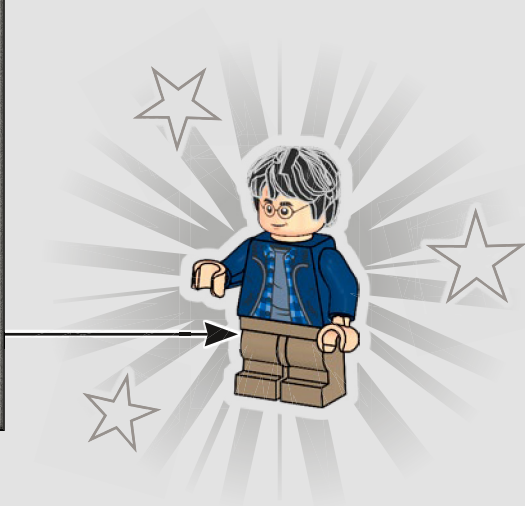
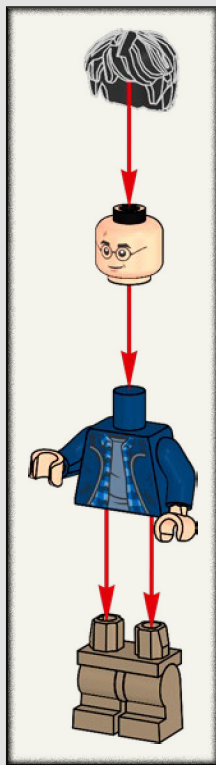

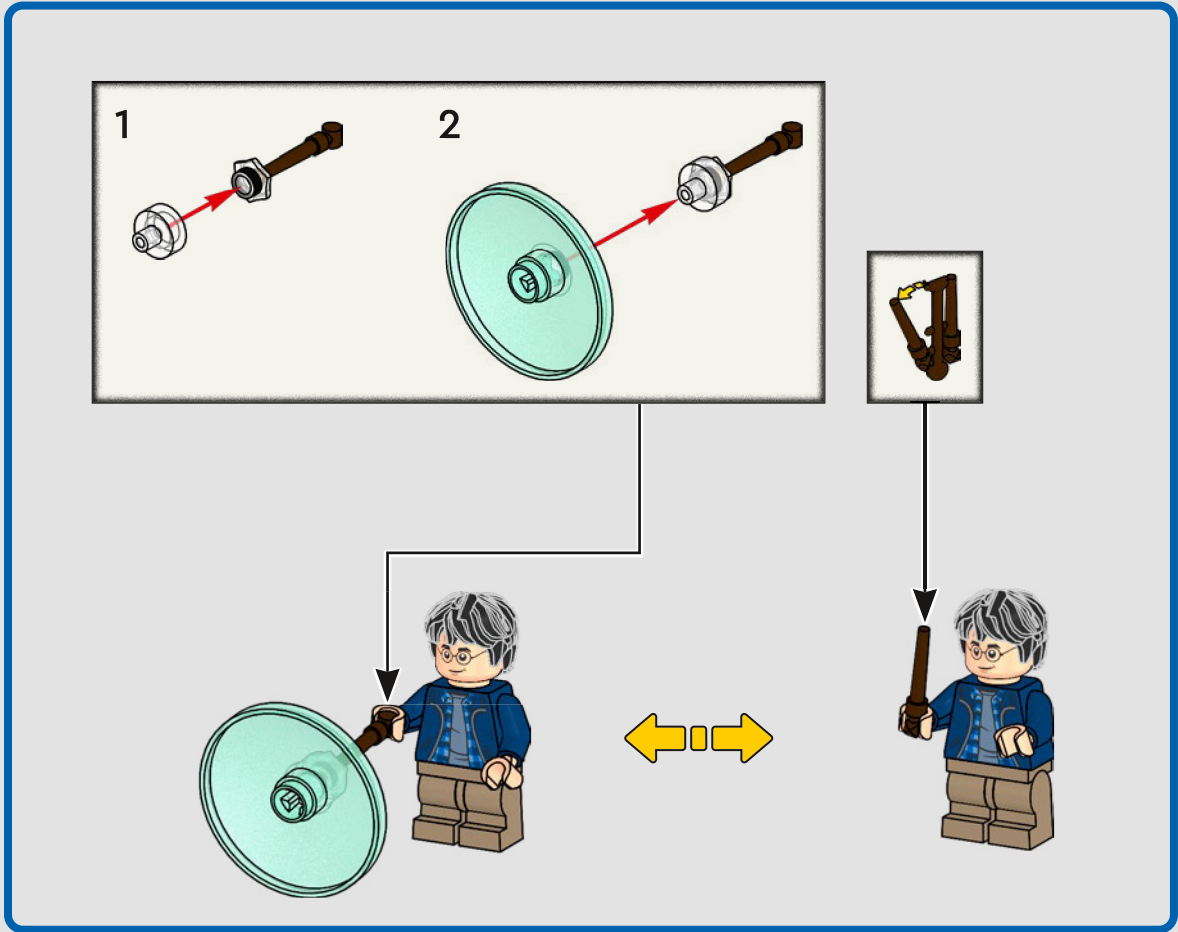

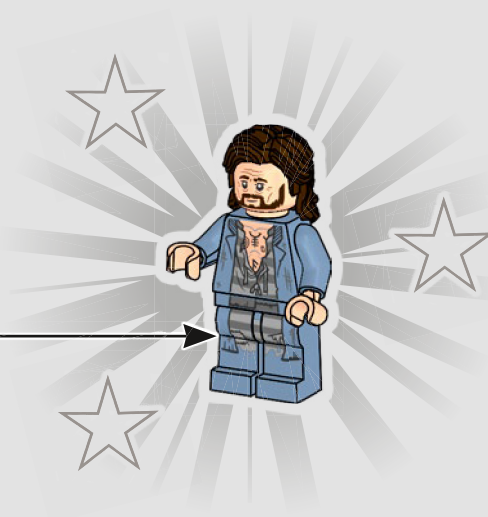
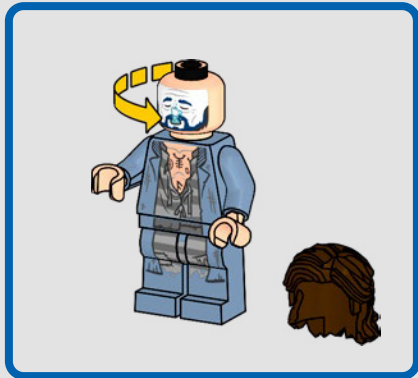
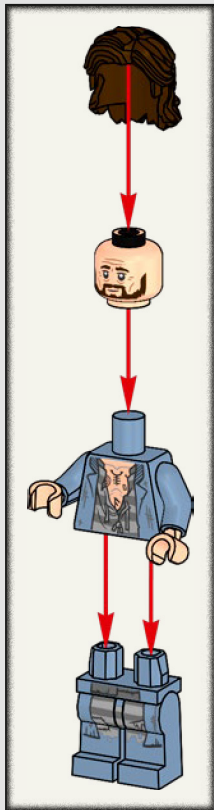

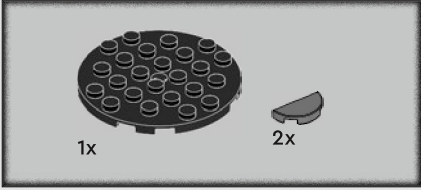

1

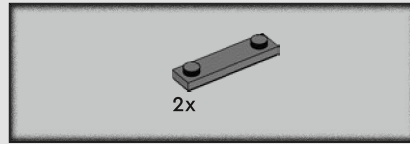
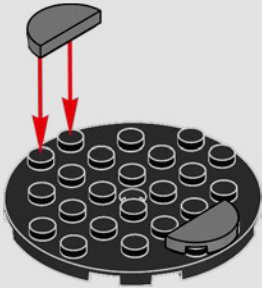

2

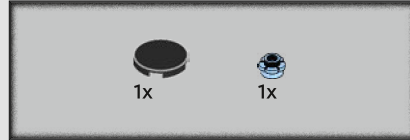
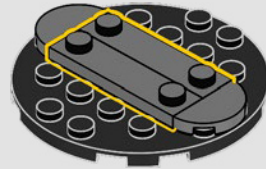

3

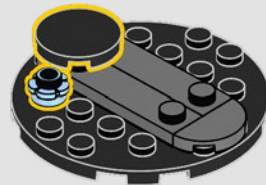

4

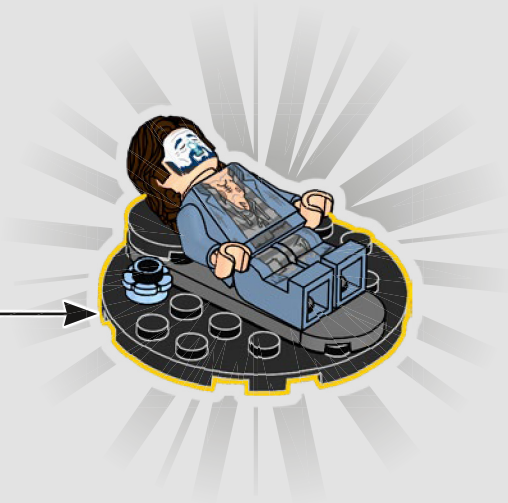

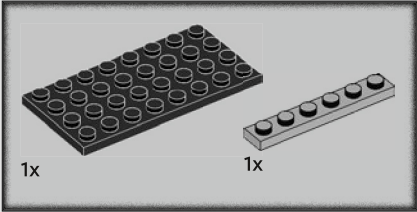
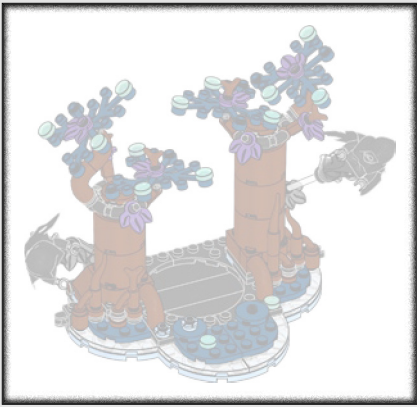

1

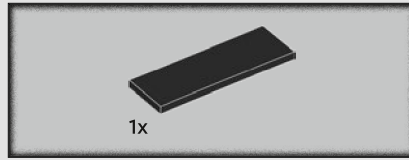
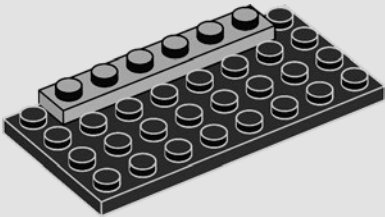

2

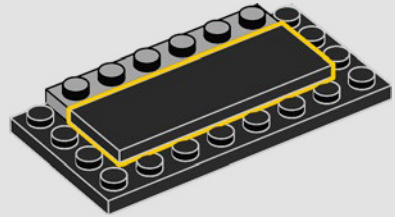

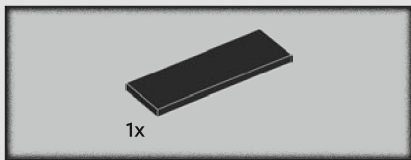

3

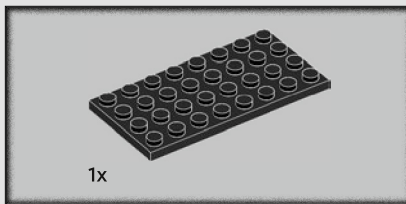
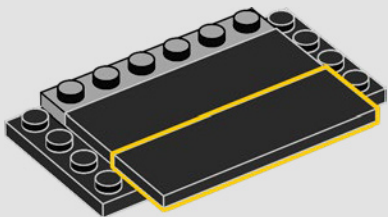

4

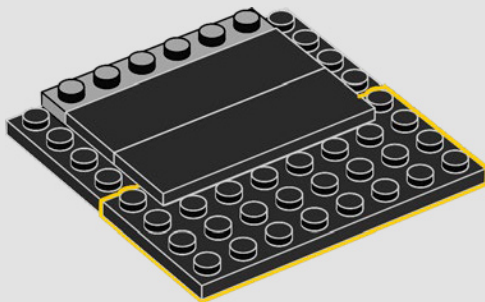

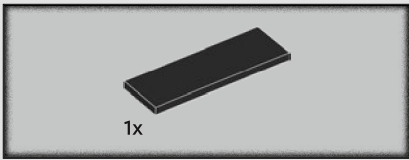

5

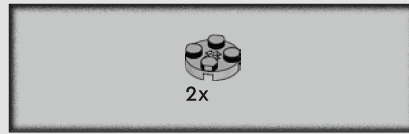
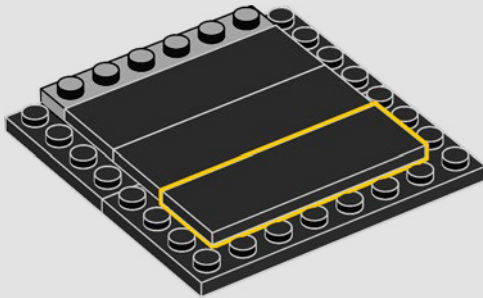

6

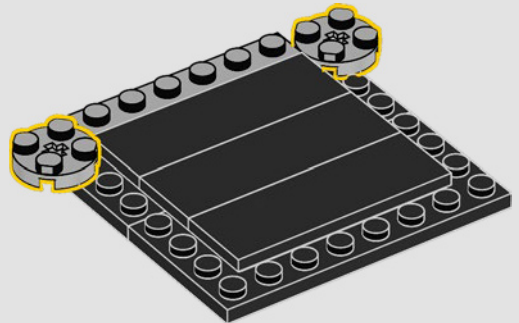

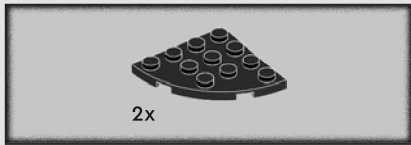

7

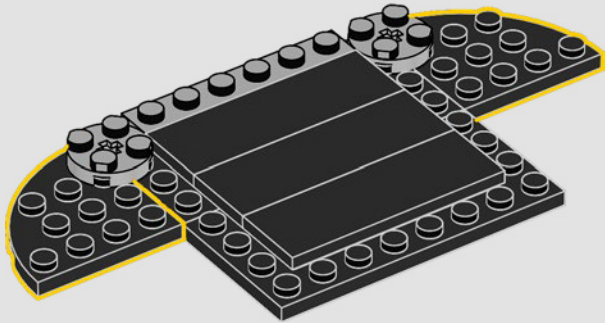

8

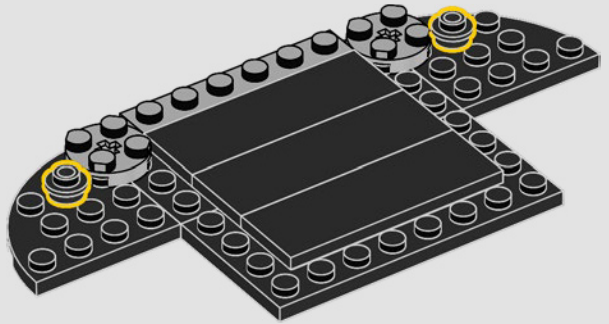

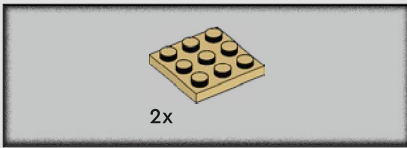

9

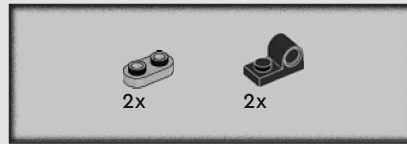
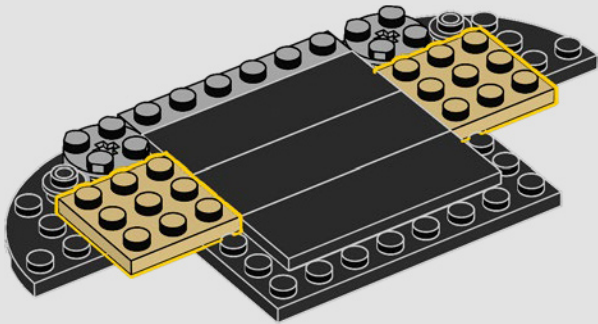

10

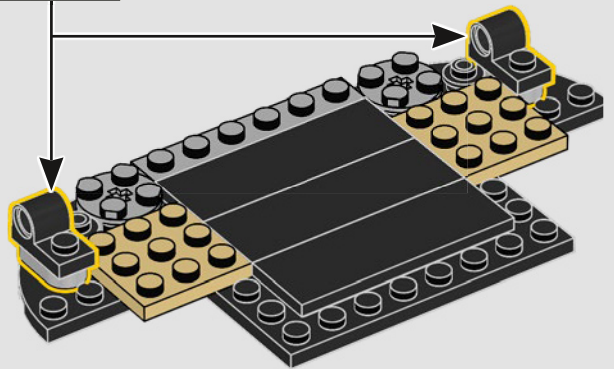
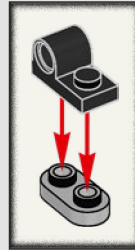

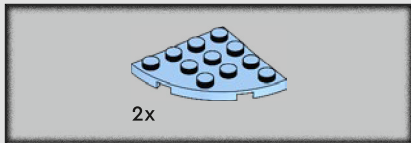

11

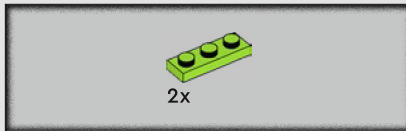
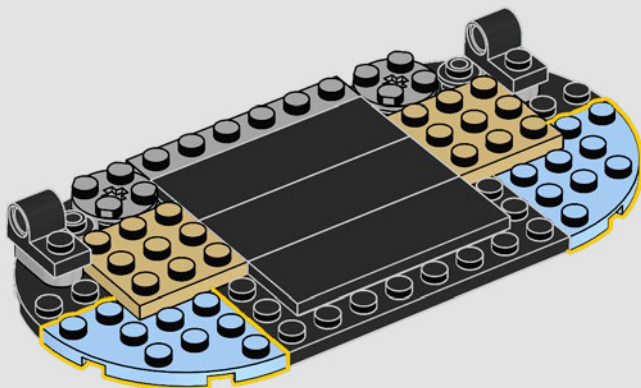

12

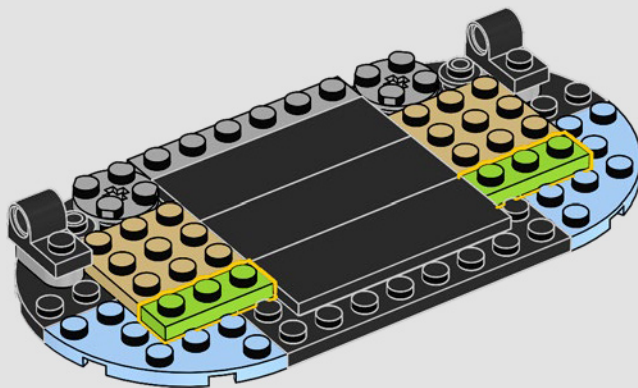



13

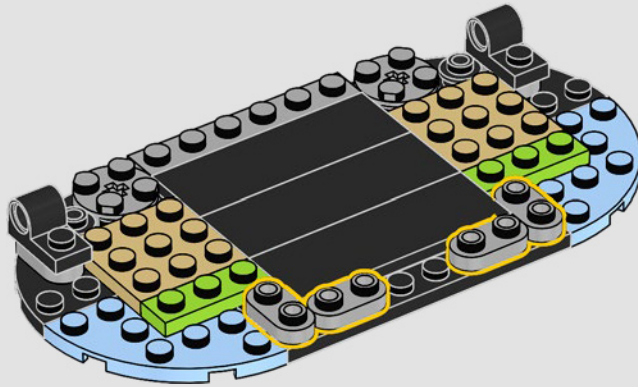

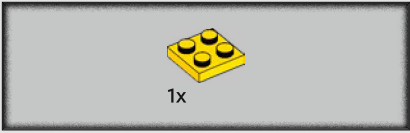

14

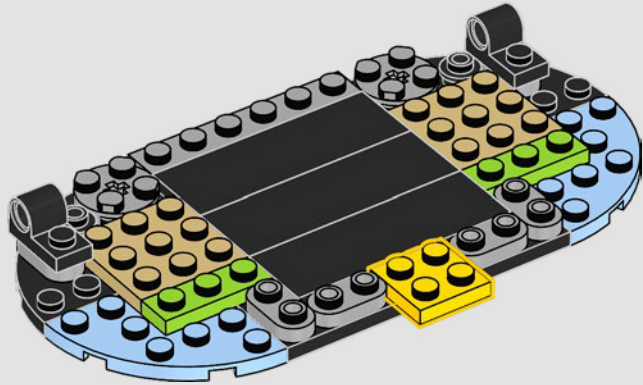

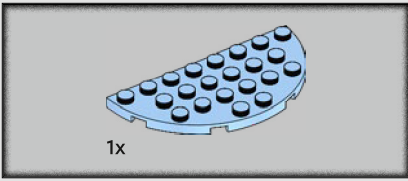

15

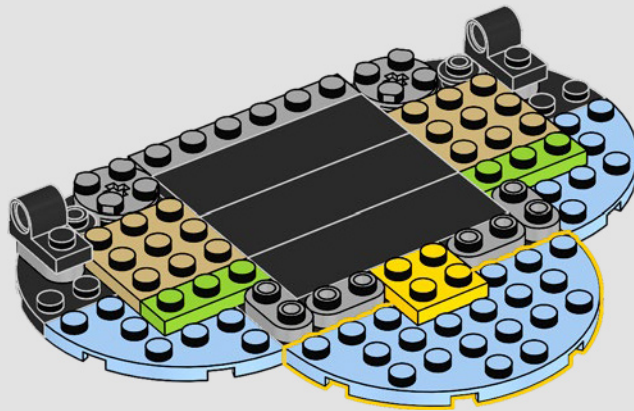

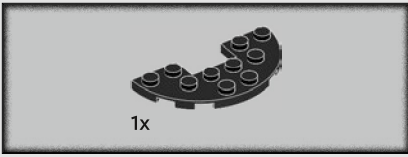

16

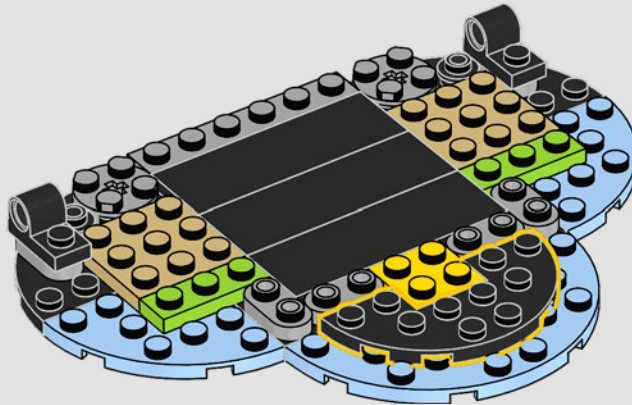

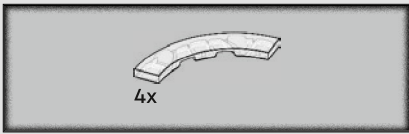

17

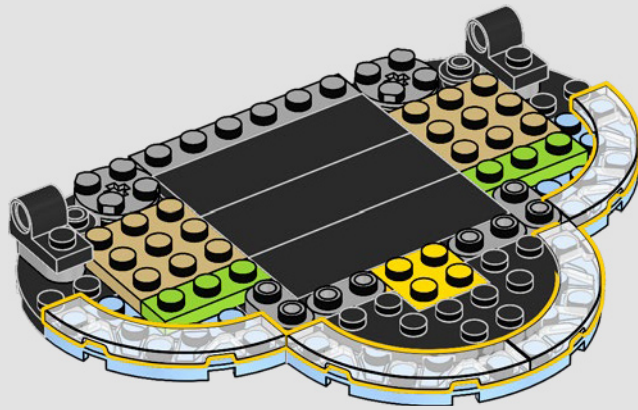

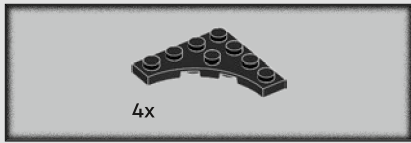

18

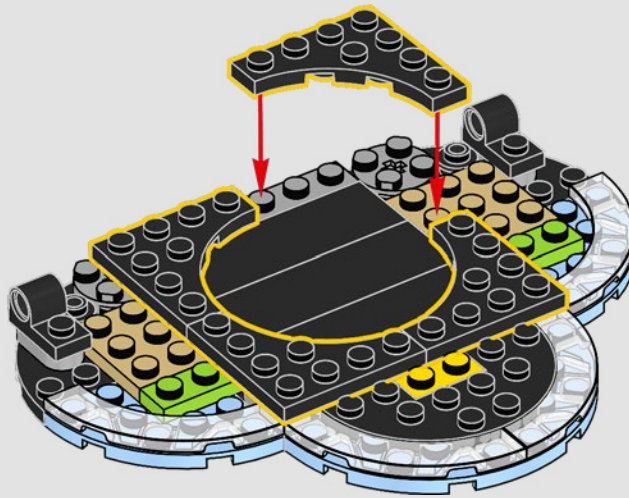

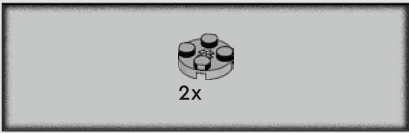

19

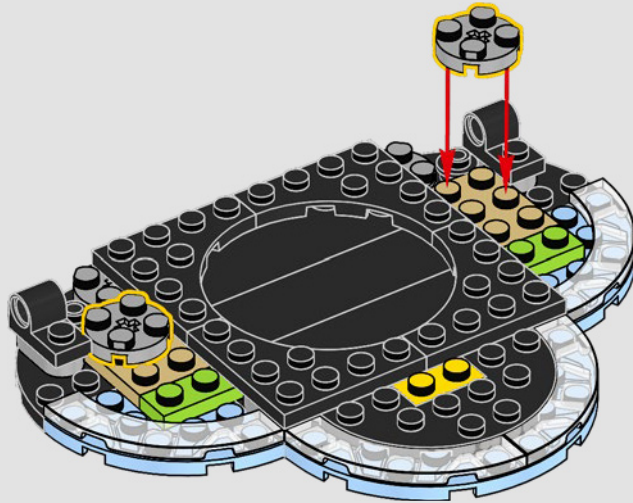

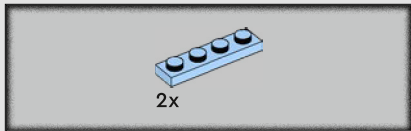

20

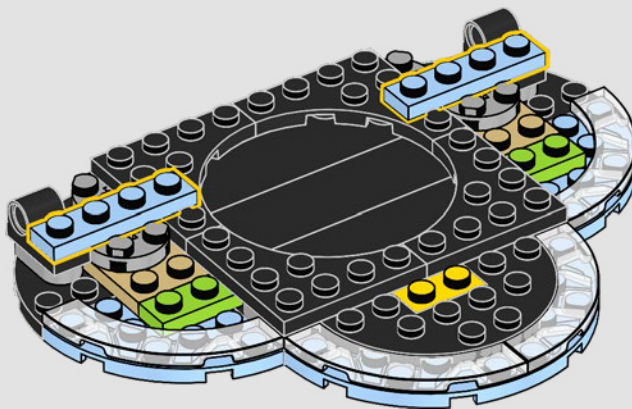

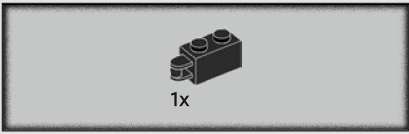

21

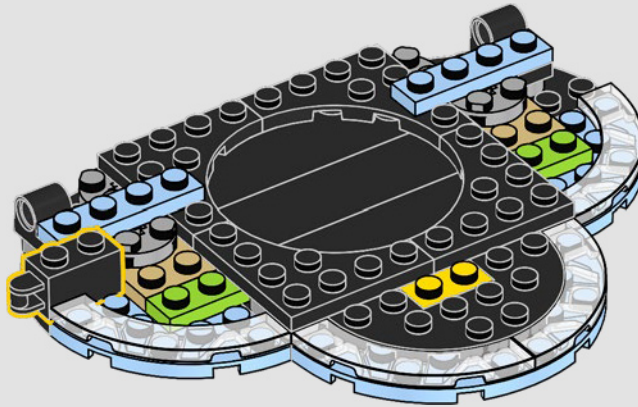

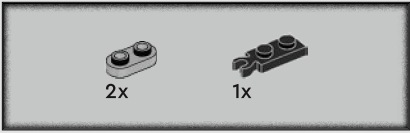

22

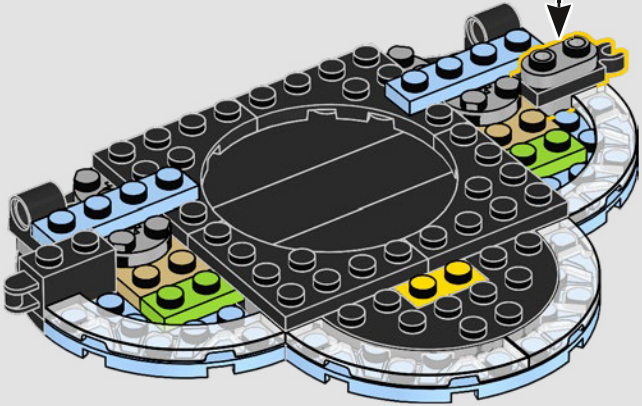
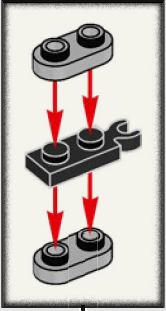

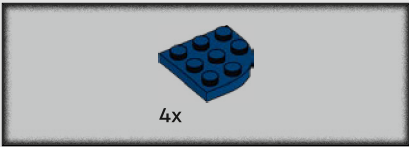

23

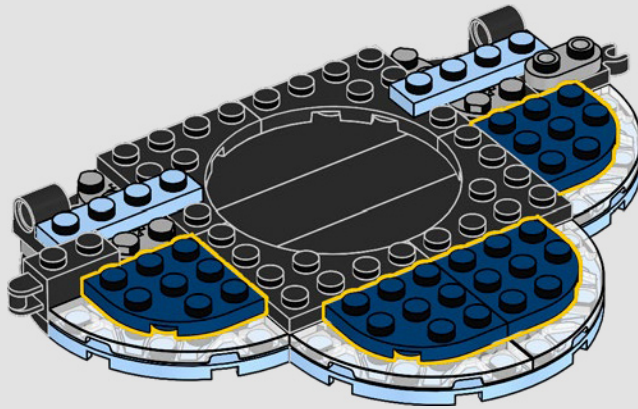

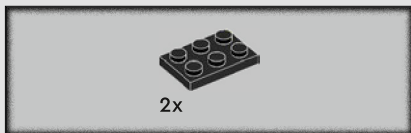

24

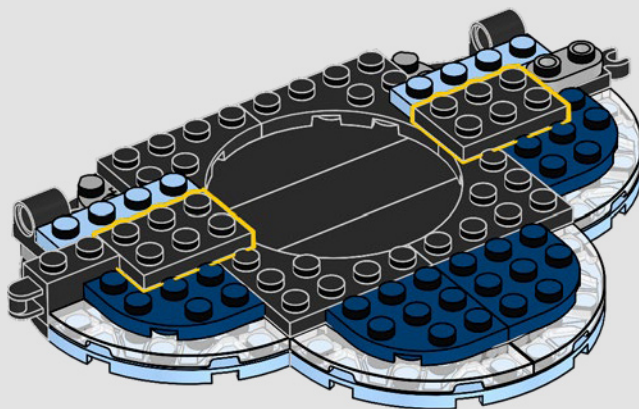



25

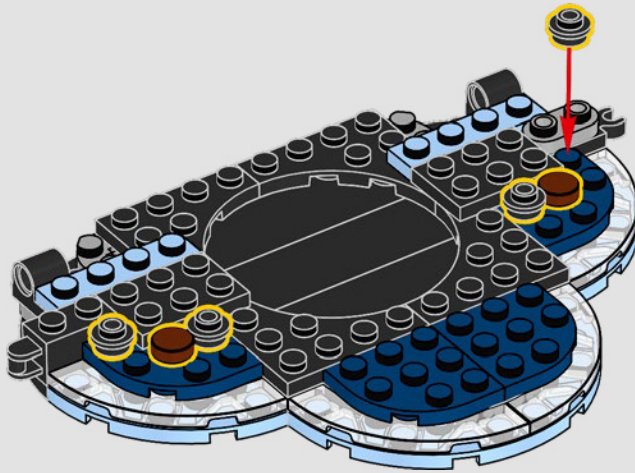



26

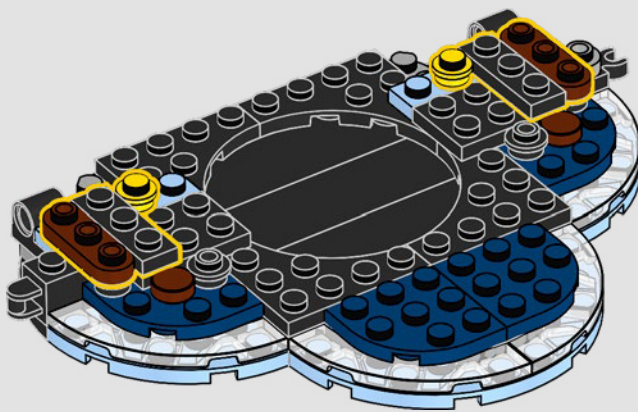



27

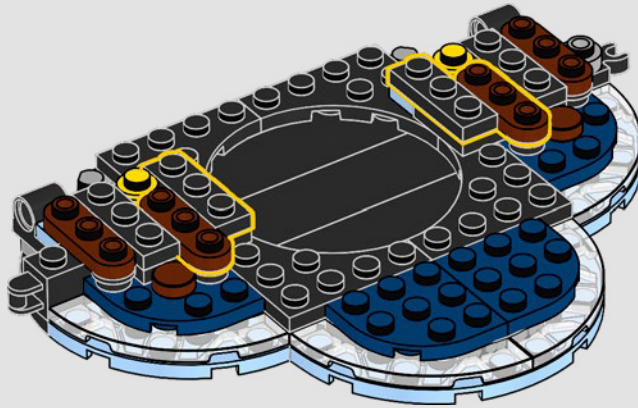

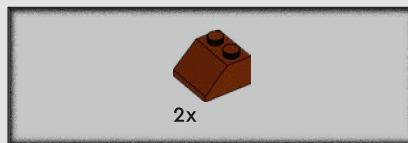

28

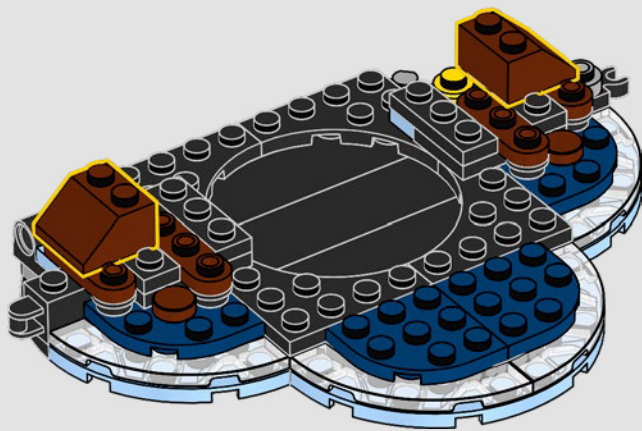

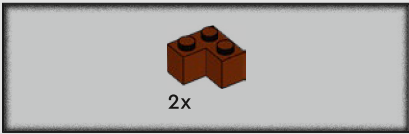

29

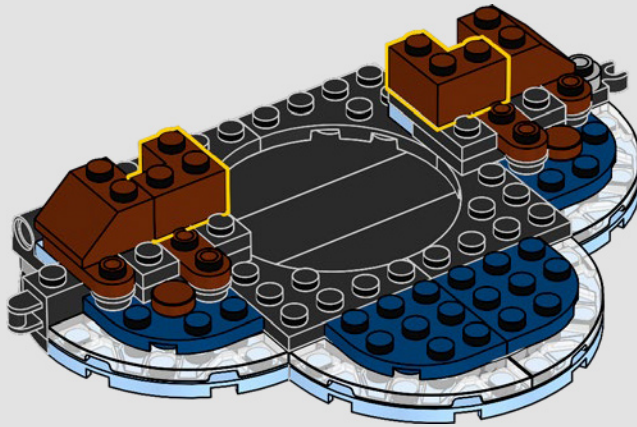

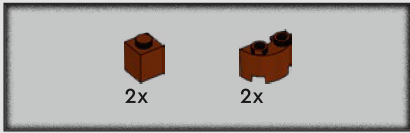

30

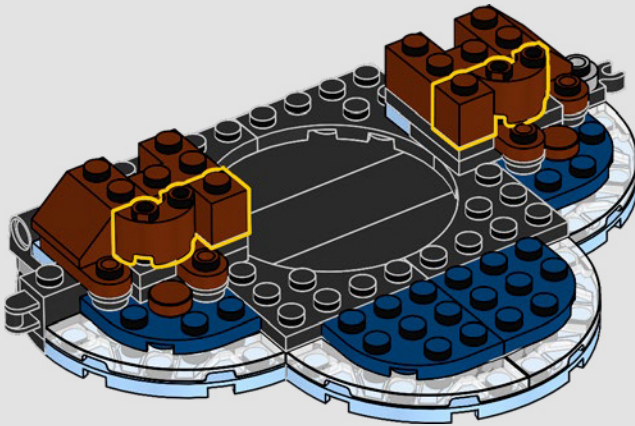

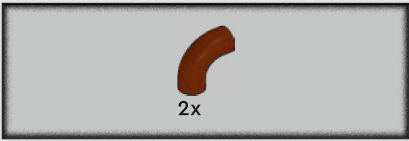

31

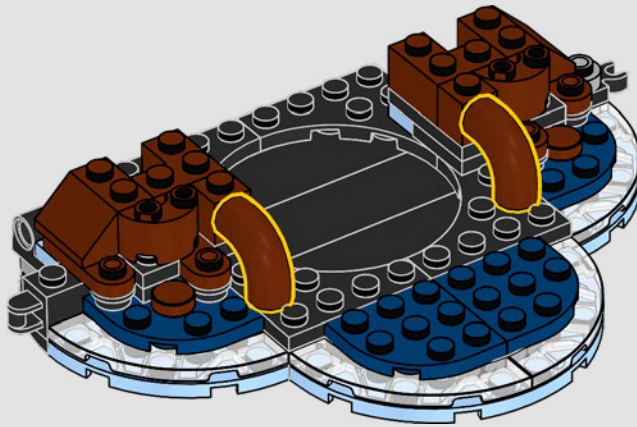



2x

32

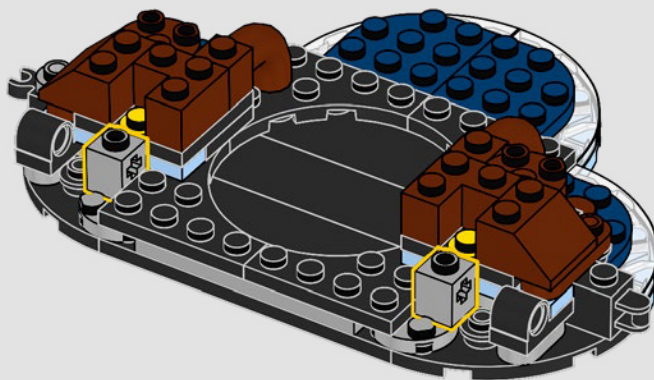

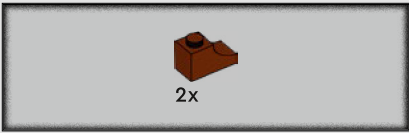

33

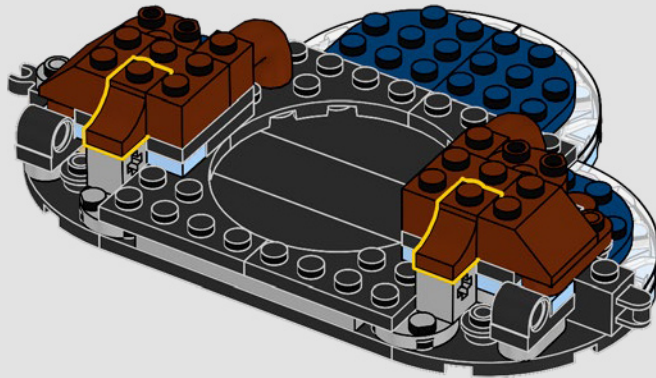

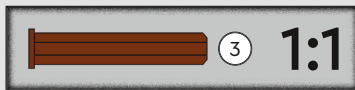
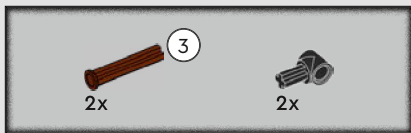

34

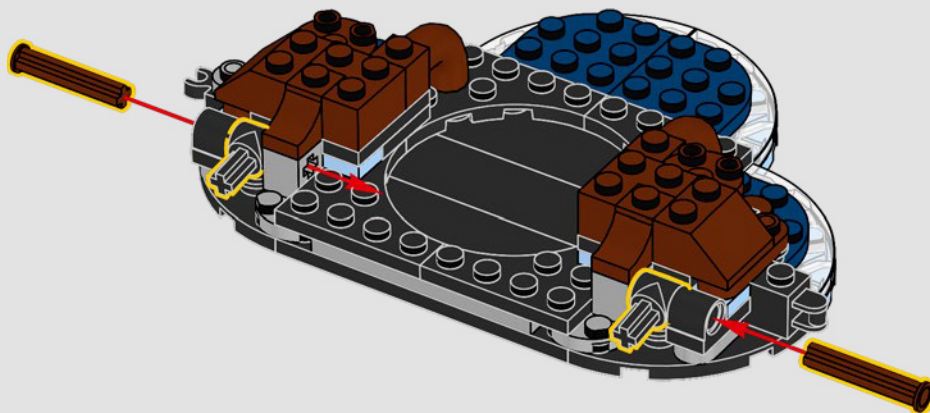

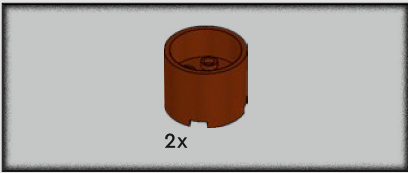

35

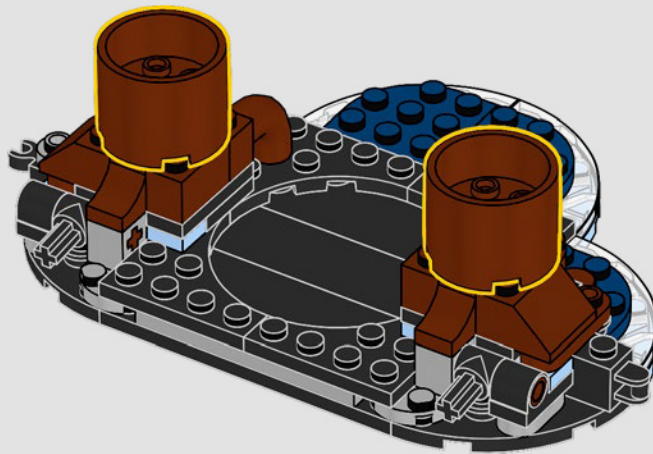

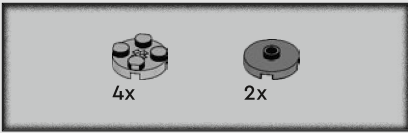

36

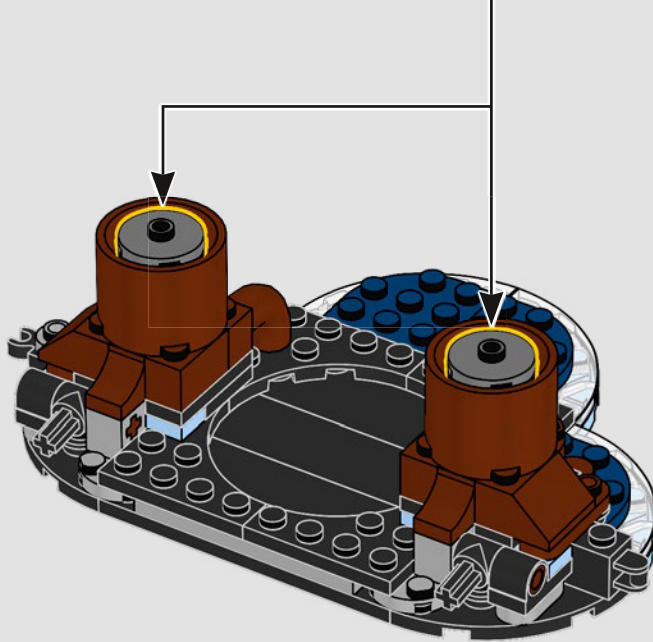
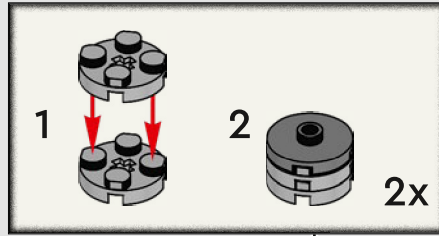

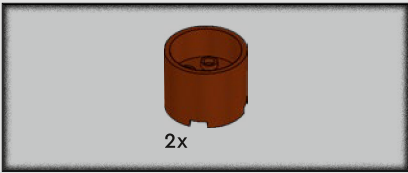

37

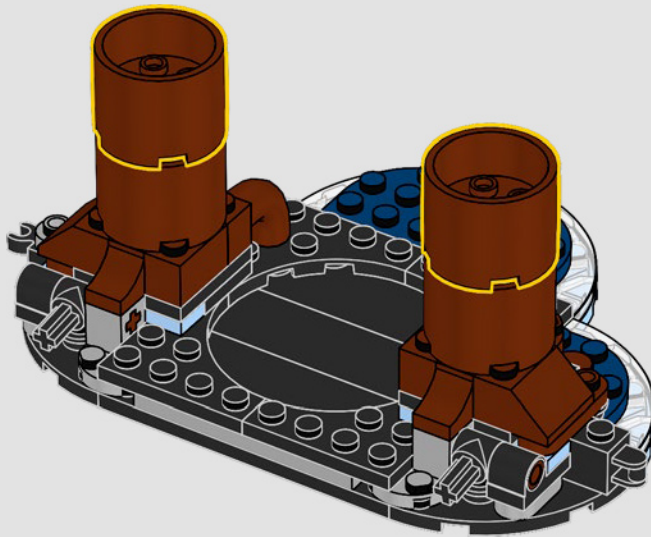

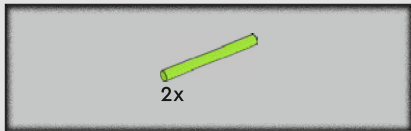

38

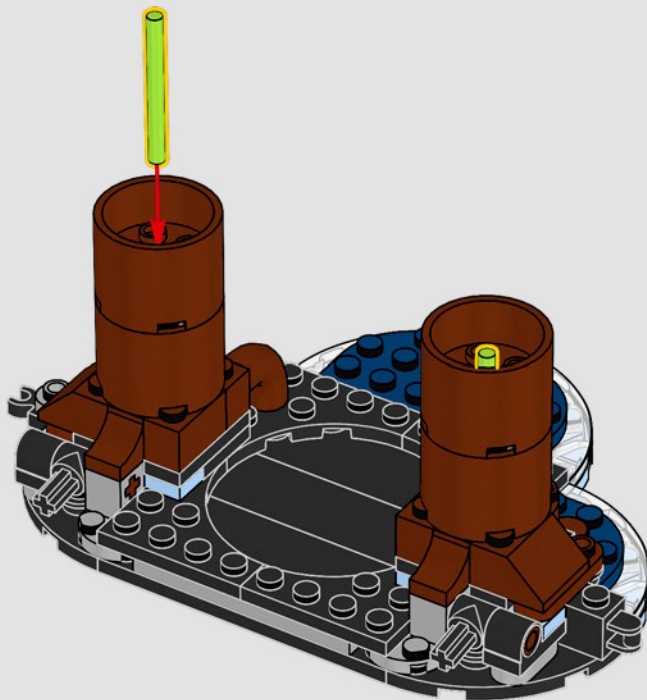

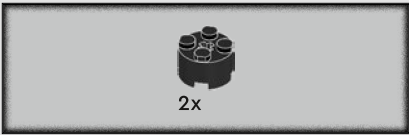

39

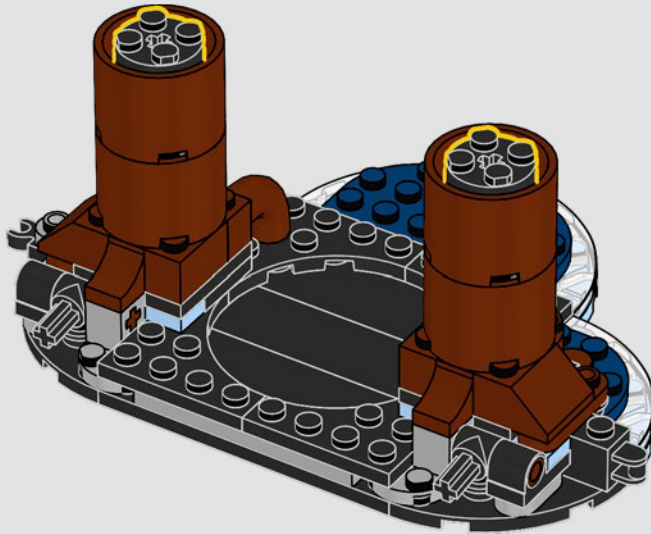

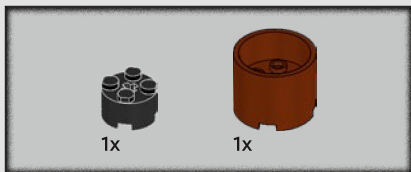

40

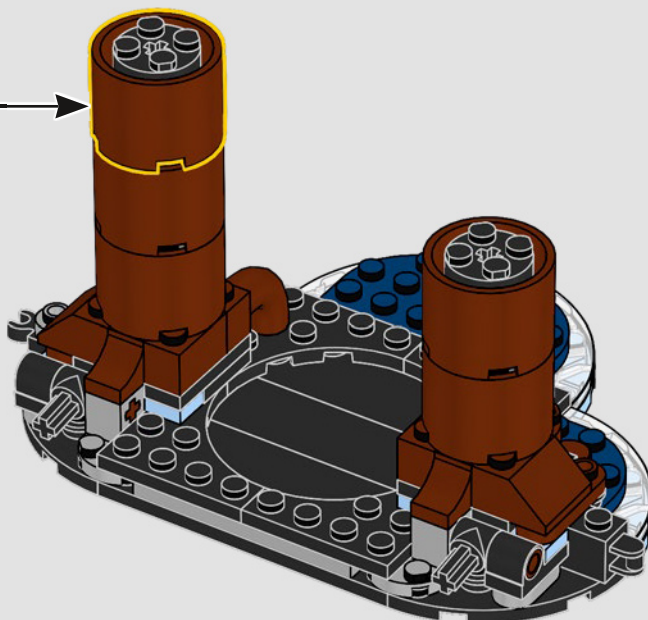
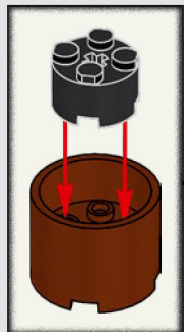

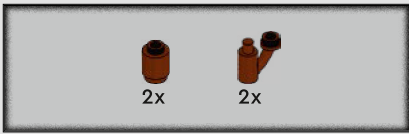

41

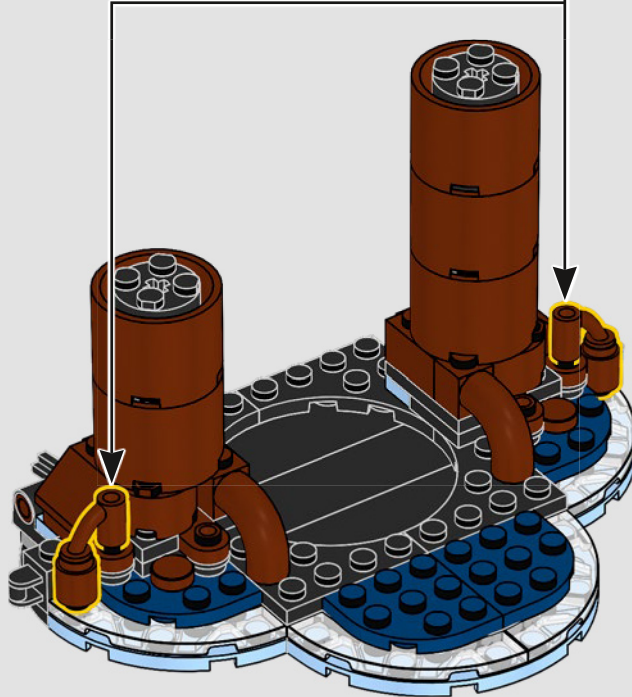
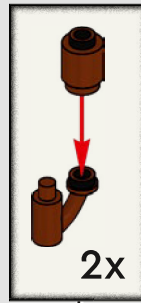



42

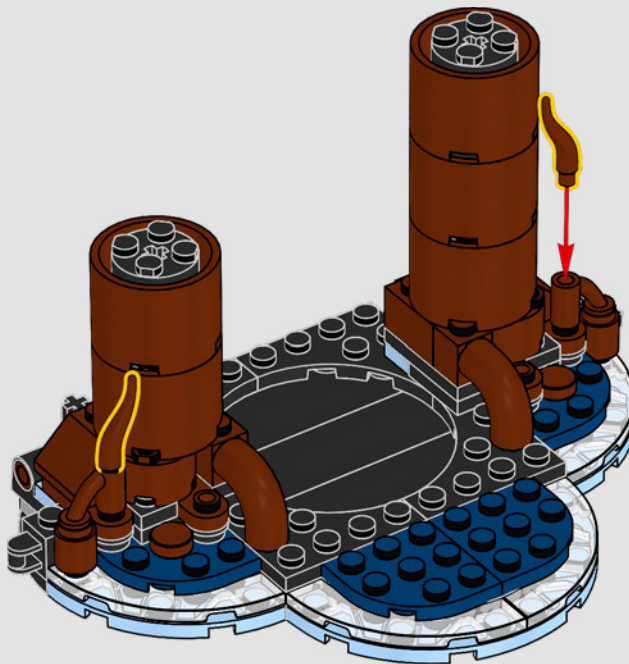

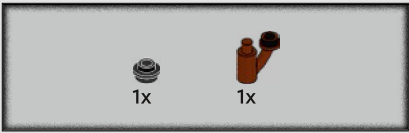

43

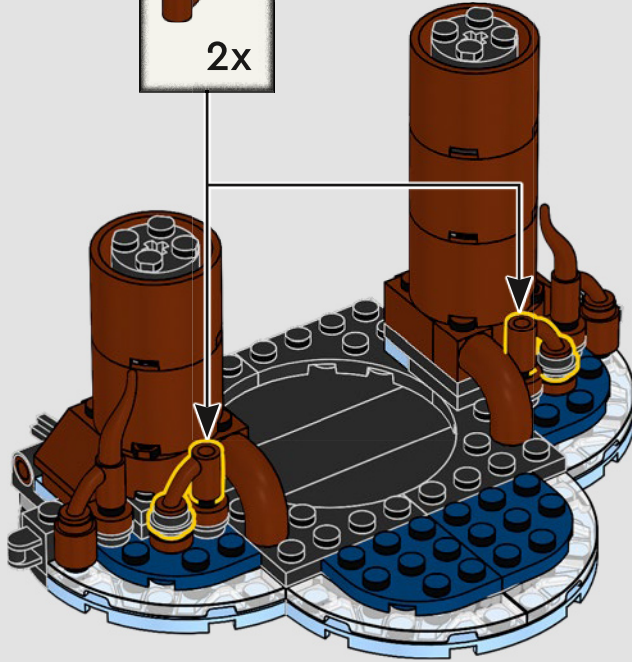
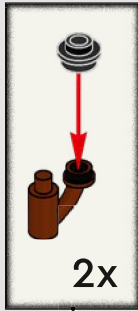

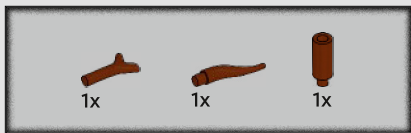

44

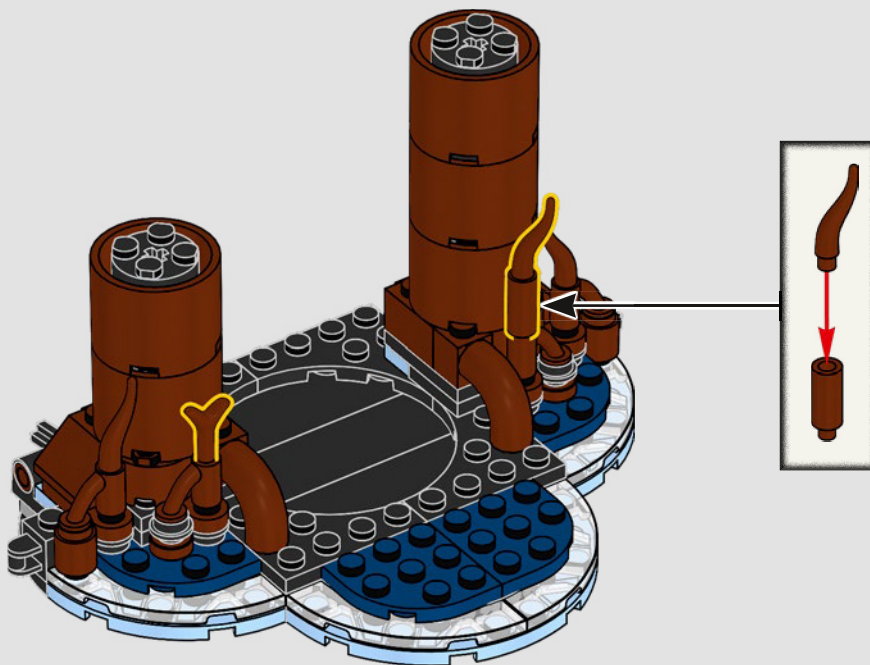



45

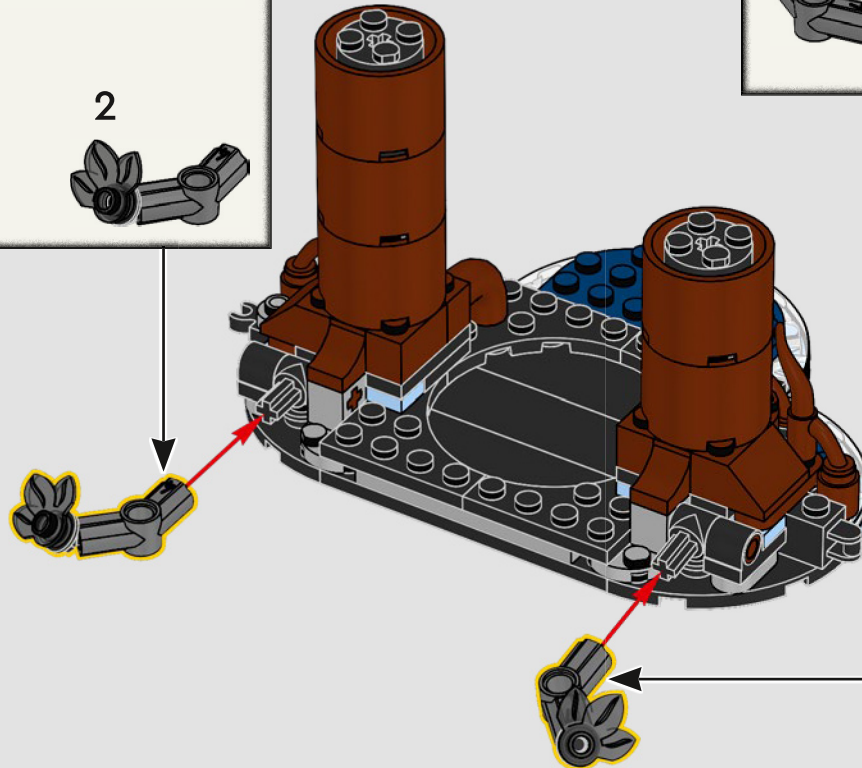
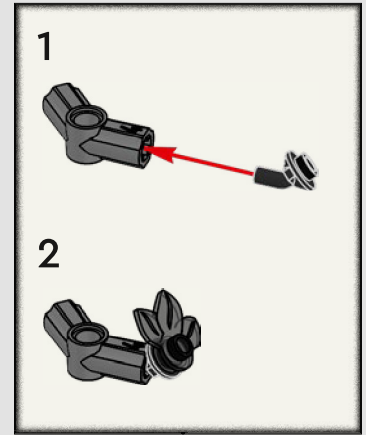
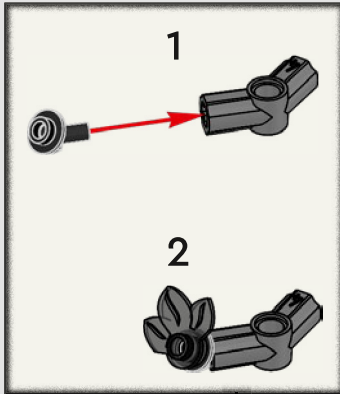

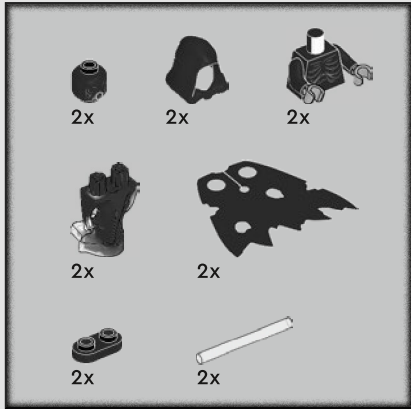
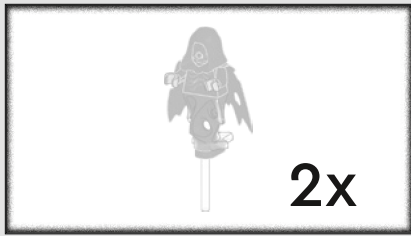

46

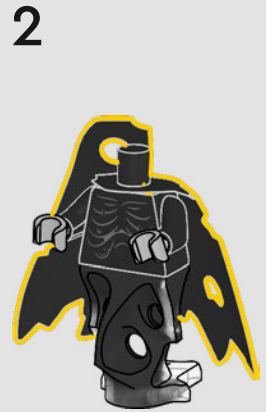
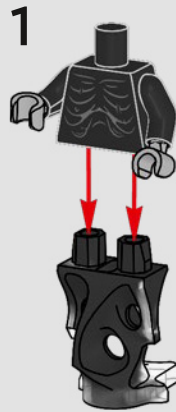

3

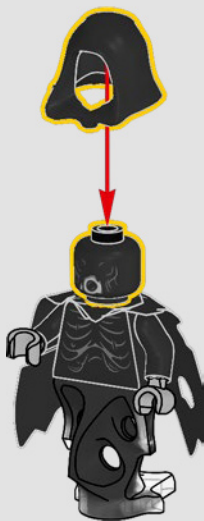

4

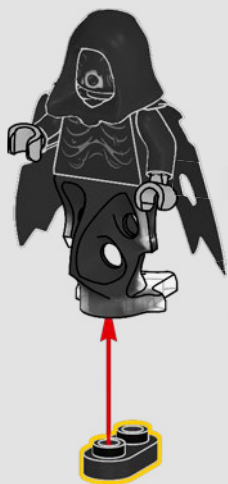

5



2x



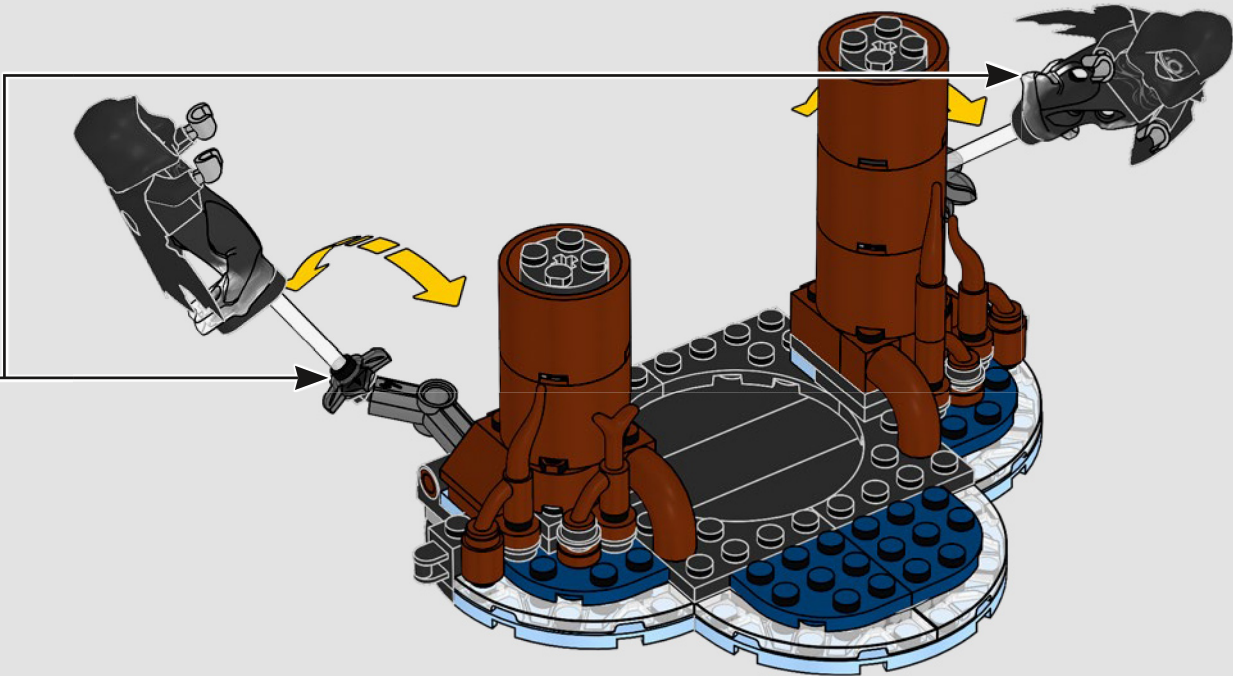





2x

47

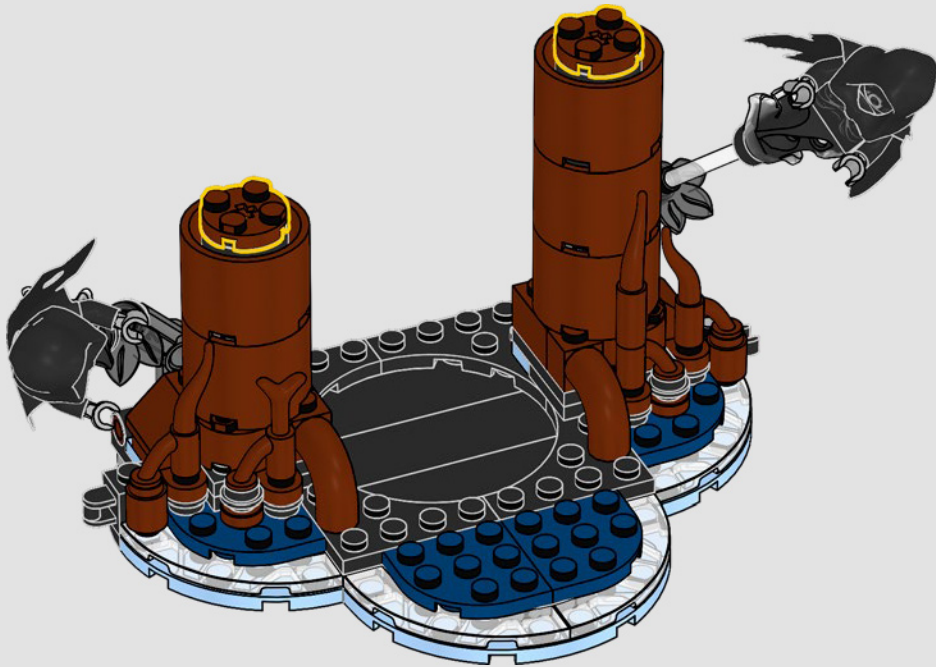



48

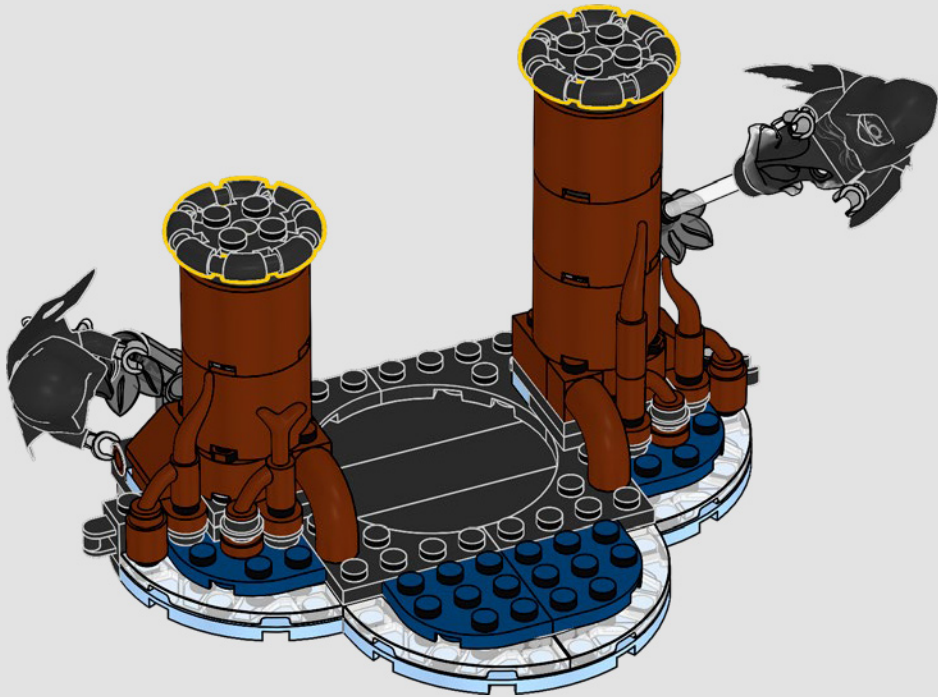



49

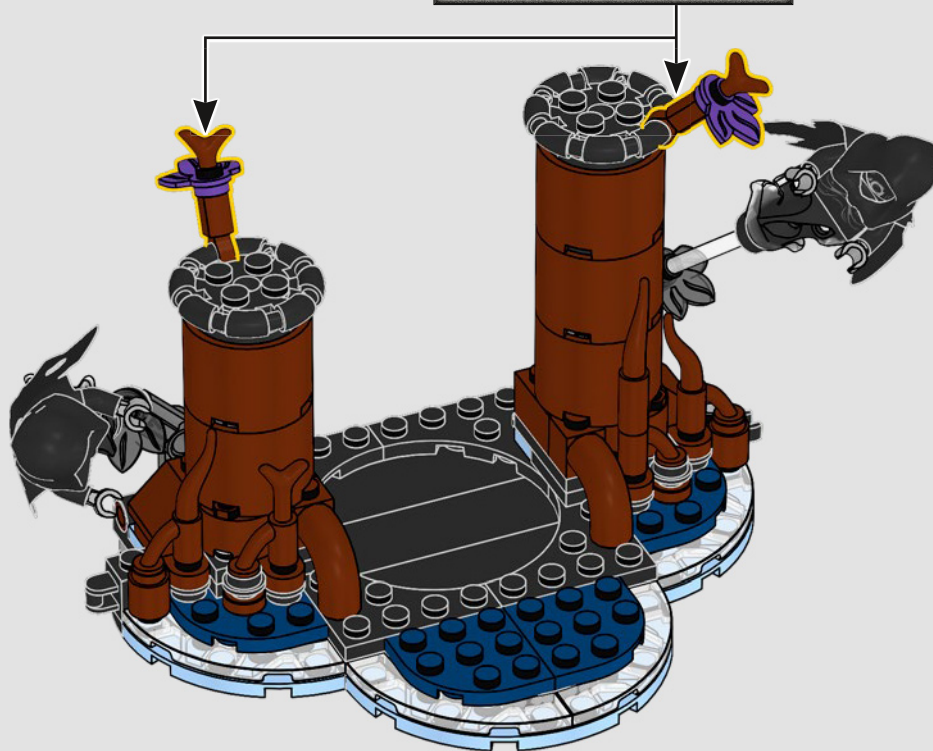
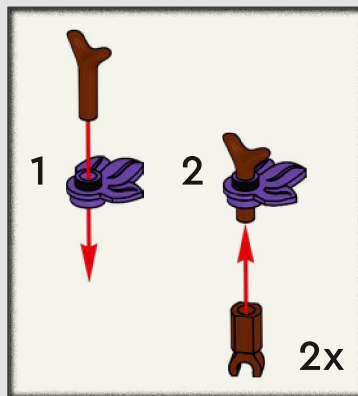



50

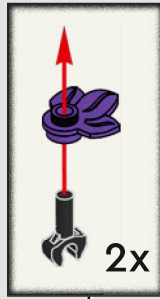

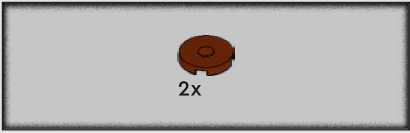

51



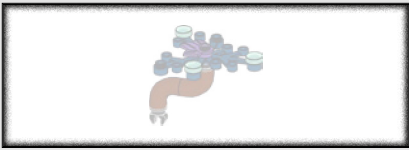

52

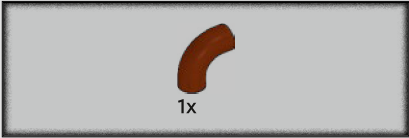

53

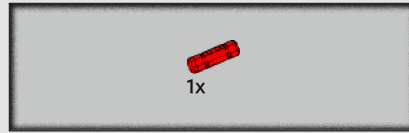
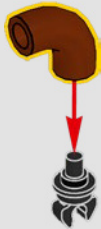

54



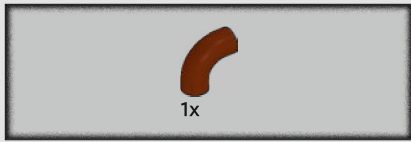

55

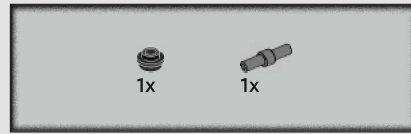
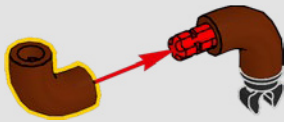

56

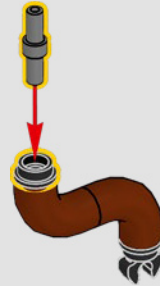

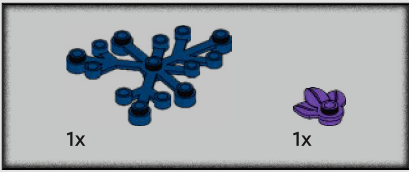

57

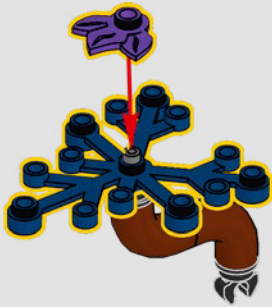

58

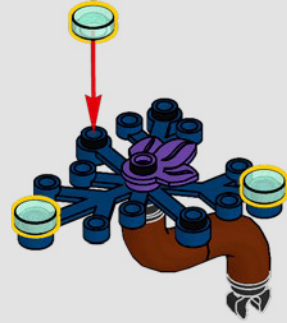

59



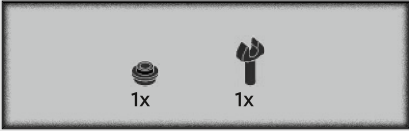

60



61

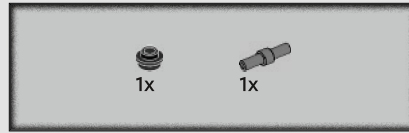

62

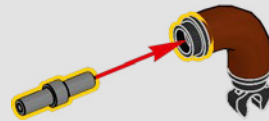

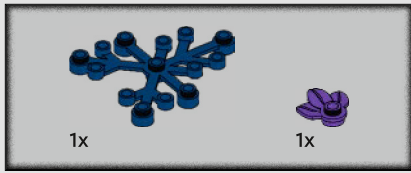

63



64

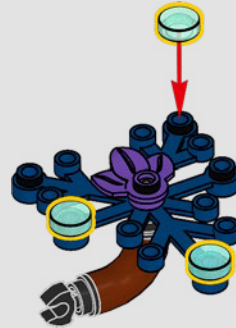





66

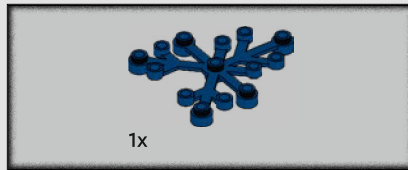

67



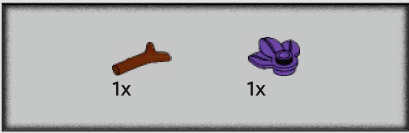

68



69

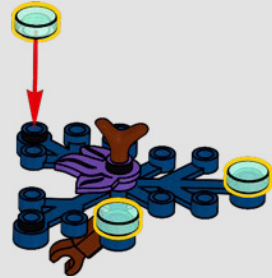

2x





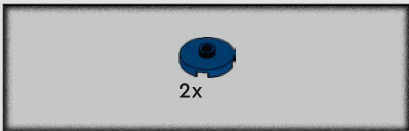

71





2x



2x

72



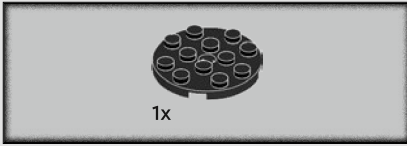

73

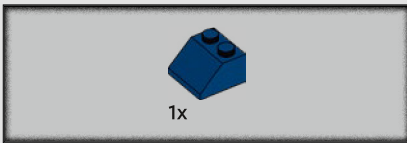

74

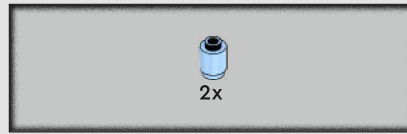

75



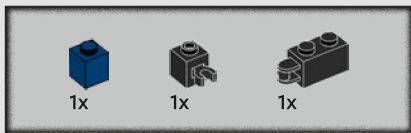

76

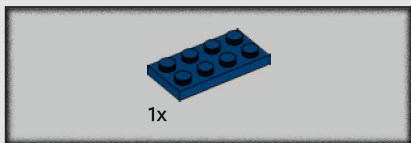
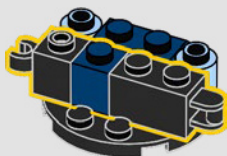

77

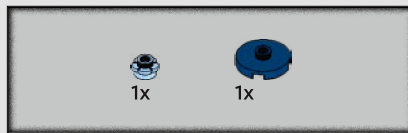
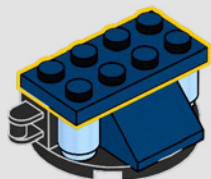

78

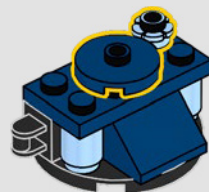

2x

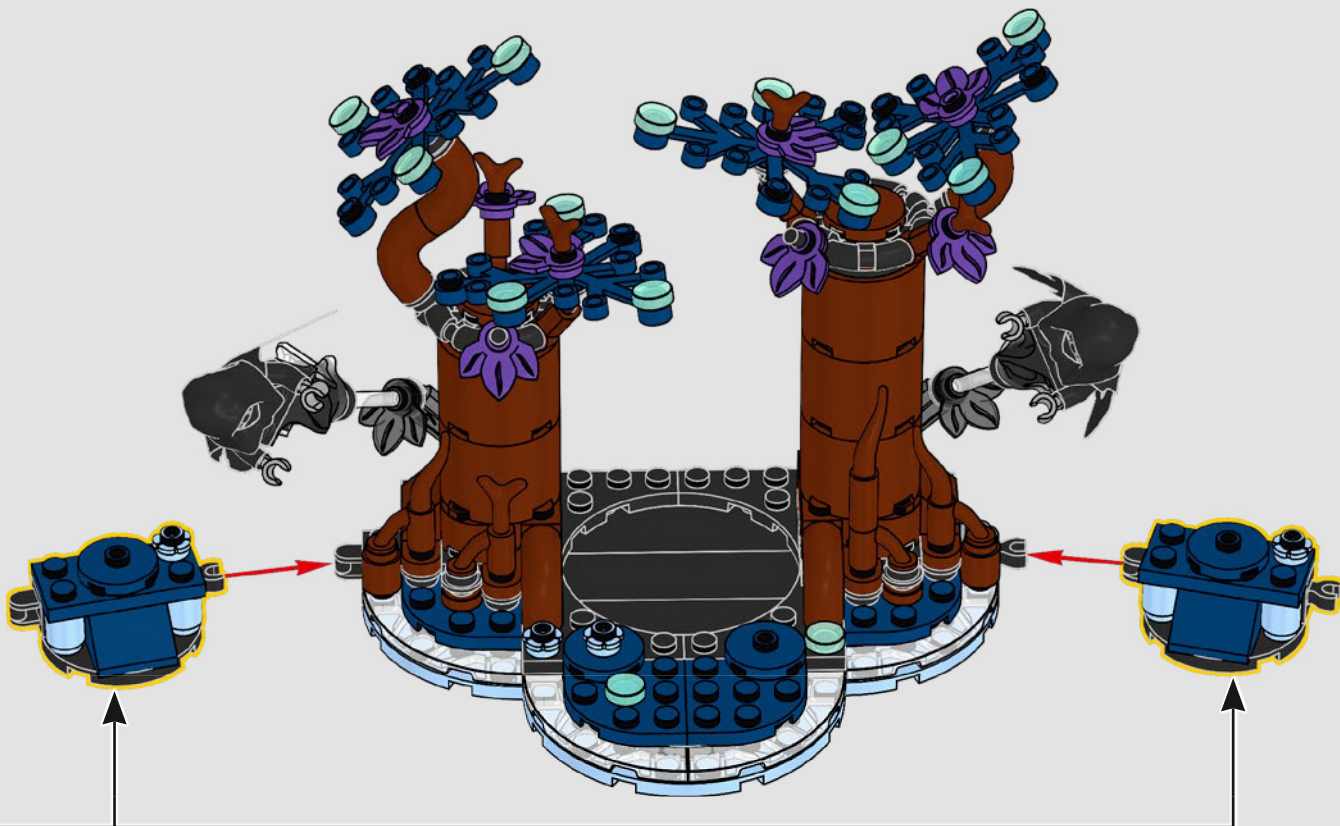



1x

80



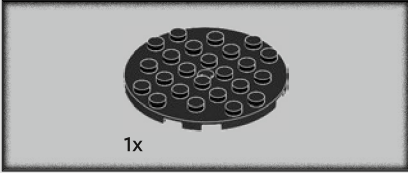
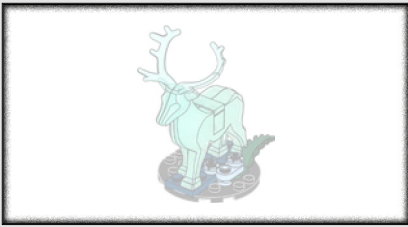

81

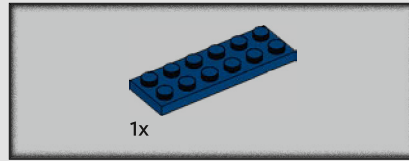
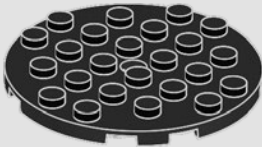

82

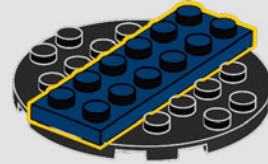

83

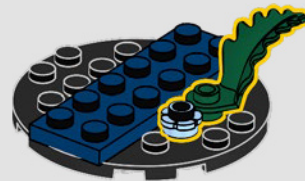



84

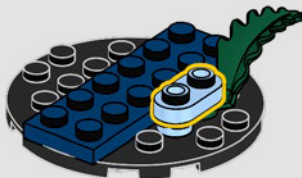

85

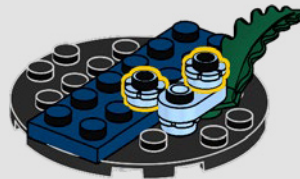

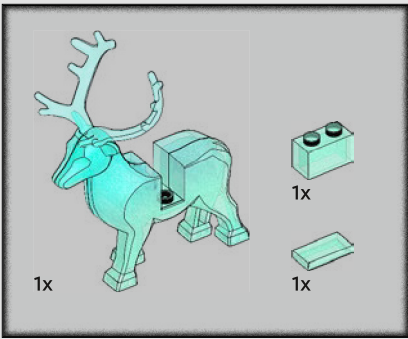

86

1

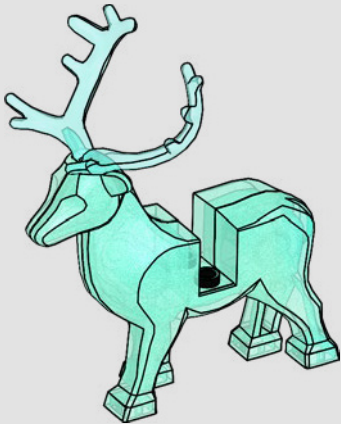

2

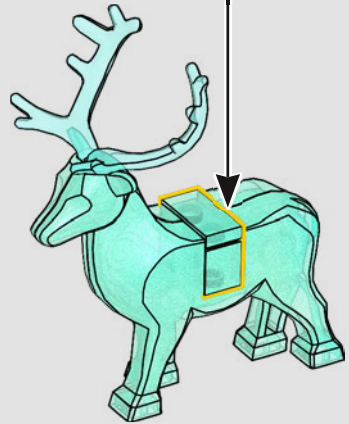



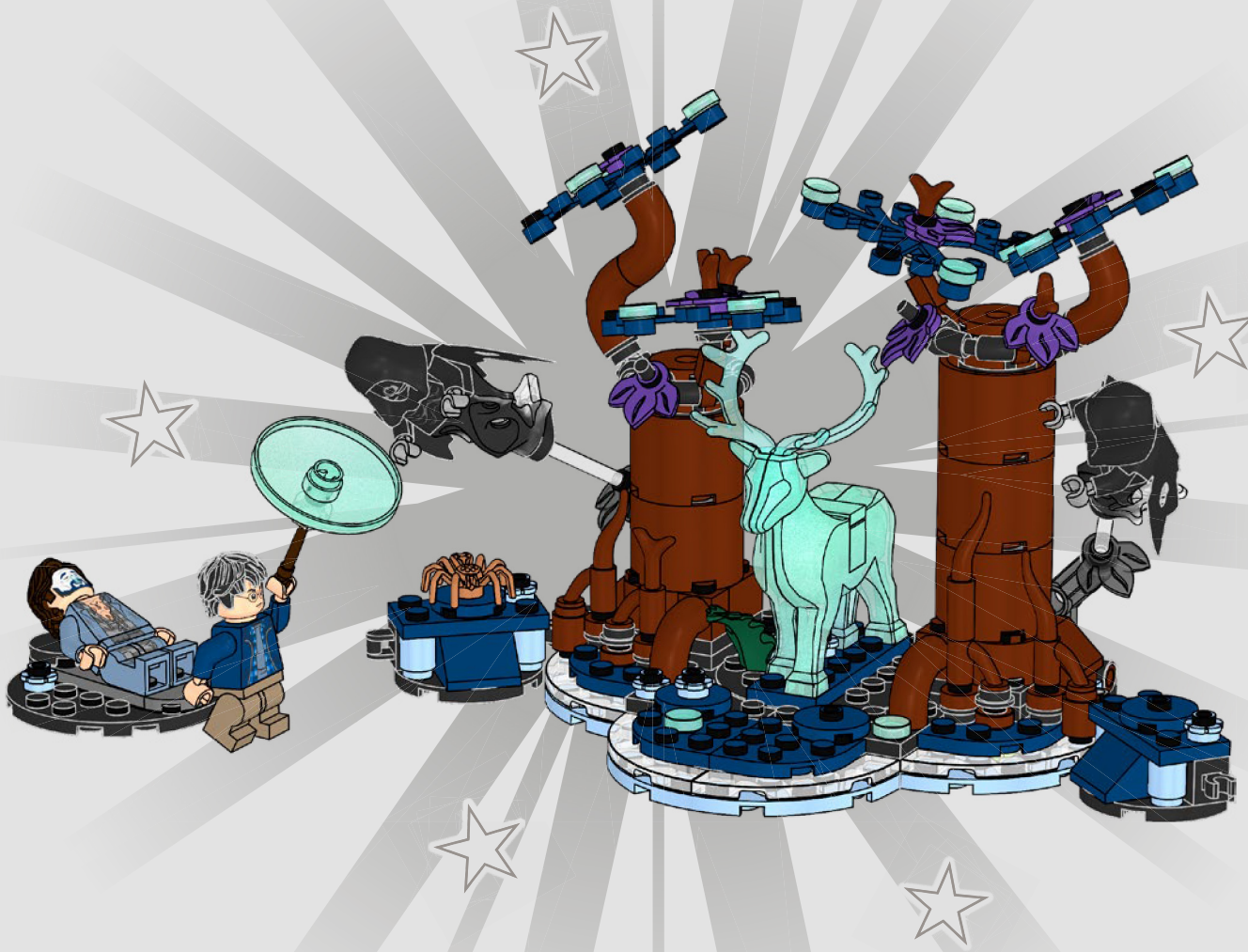



# Harry Potter™

Build the most detailed Hogwarts™ Castle  
 Baue das detailreiche Schloss Hogwarts™  
 Construisez le château de Poudlard le plus détaillé  
 Costruisci il Castello di Hogwarts™ più dettagliato di sempre  
 Construye el Castillo de Hogwarts™ más detallado  
 Construa o mais detalhado Castelo de Hogwarts™

拼搭精美的霍格沃茨™城堡

Zbuduj najbardziej szczegółowy zamek Hogwarts™

Postavte si ten najdetailnejší Bradavický hrad

Postavte si najdetailnejši Rokfortský hrad

Építsd meg a legrészletgazdagabb Roxfort™ kastélyt!

Побудуйте найдетальніший замок Гогвортс

Construieste cel mai detaliat Castel Hogwarts™

Постройте най-детальніша версія на замка Хогвортс

Uzbtvė visdetalizėtako Sūkkārpas pilį

Pane kokku kõige üksikasjalikum Sigatüüka™ loss

Sukonstruokite nepaprastai detalią Hogwartso pilį

En detaylı Hogwarts™ Şatosunu inşa et

Each set sold separately and available for different periods of time / Jedes Set ist separat und in unterschiedlichen Zeiträumen erhältlich. / Chaque set est vendu séparément et sera disponible à des périodes différentes. / Ogni set è venduto separatamente ed è disponibile per periodi di tempo diversi. / Cada set se vende por separado y está disponible durante un cierto periodo de tiempo. / Os sets são vendidos separadamente e estão disponíveis por diferentes períodos de tempo. / 每款套装于不同时间段单独出售。 / Zestawy są sprzedawane osobno i są dostępne w różnym czasie / Každá stavebnice se prodává samostatně a je k dispozici v různých časových obdobích / Každá stavebnica sa predáva samostatne a je k dispozícii v rôznych časových obdobiach / Minden egyes készlet külön-külön és más-más időszakban kapható. / Кожен набір продається окремо і доступний протягом різних періодів часу / Seturile se vând separat și sunt disponibile pentru perioade diferite de timp / Всеки комплект се продава отделно и е наличен за различен период от време. / Katrs komplekts tiek pārdots atsevišķi, un to pieejamības periodi atšķiras. / Kõik komplektid on müügil eraldi ja saadaval erinevates ajavahemikes. / Kiekvienas rinkinys parduodamas atskirai ir tik ribotą laiką / Her set ayrı satılır ve farklı sürelerde mevcuttur



76435



76463



76445



Build the most detailed  
**HOGWARTS™ CASTLE**



76454



76473



76447



Collectable  
**PATRONUSES**



76464



76460



76473



76463



**25**  
YEARS OF  
MAGIC

76475



76467



76471



76478

25 Years of Magic / 25 Jahre Magie / 25 ans de magie / 25 anni di Magia /  
 25 Años de Magia / 25 Anos de Magia / 25 年魔法 / 25 lat magii /  
 25 let kouzel / 25 rokov kúziel / A varázslat 25 éve / 25 років магії /  
 25 de ani de magie / 25 години магия / 25 maģijas gadi / 25 aastat maagiat /  
 25 maģijos metai / Sihirdi 25 Yil

Each set sold separately and available for different periods of time / Jedes Set ist separat und in unterschiedlichen Zeiträumen erhältlich. / Chaque set est vendu séparément et sera disponible à des périodes différentes. / Ogni set è venduto separatamente ed è disponibile per periodi di tempo diversi. / Cada set se vende por separado y está disponible durante un cierto periodo de tiempo. / Os sets são vendidos separadamente e estão disponíveis por diferentes períodos de tempo. / 每款套装于不同时间段单独出售。 / Zestawy są sprzedawane osobno i są dostępne w różnym czasie. / Každá stavebnice se prodává samostatně a je k dispozici v různých časových obdobích / Každá stavebnica sa predáva samostatne a je k dispozícii v rôznych časových obdobiach / Minden egyes készlet külön-külön és más-más időszakra kapható. / Кожен набір продається окремо і доступний протягом різних періодів часу / Seturile se vând separat și sunt disponibile pentru perioade diferite de timp / Всеки комплект се продава отделно и е наличен за различен период от време. / Kats komplekts tiek pārdots atsevišķi, un to pieejamības periodi atšķiras. / Koik komplektid on müügil eraldi ja saadaval erinevates ajavahemikes. / Kiekvienas rinkinys parduodamas atskirai ir tik ribotą laiką / Her set ayrı satılır ve farklı sürelerde mevcuttur

Collectable Patronuses / Patronusse zum Sammeln / Des Patronus à collectionner / Patronus collezionabili / Patronus coleccionables / Patronus coleccionáveis / 具有收藏价值的守护神 / Patronusy do kolekcjonowania / Sběratelné patronůsk / Zberateľské patronusy / Gyűjthető patronusok / Колекційні патронуси / Figurine Patronus de colecție / Колекционерски фигури на покровители / Kolekcionérjmi aizstāvji / Kogutavad Patronused / Kolekciniai Gynėjai / Koleksiyonluk Patronuslar



2x  
6578978



2x  
6016279



4x  
6439039



2x  
614124



1x  
4142865



2x  
4255413



4x  
6510193



3x  
6391341



2x  
6253260



1x  
302224



2x  
6336539



4x  
6253885



12x  
6168646



4x  
362326



2x  
6210270



8x  
6482646



8x  
6248890



2x  
4153653



1x  
6350725



2x  
302126



1x  
6070695



1x  
6581728



8x  
4211475



1x  
6529704



2x  
6114987



3x  
6318582



2x  
6336977



1x  
6612521



1x  
4211438



4x  
6251836



3x  
614326



1x  
6138405



1x  
6233922



1x  
6614733



2x  
4210210



2x  
4667595



4x  
6208787



2x  
6101857



2x  
6537354



1x  
6509114



2x  
6327442



4x  
6478110

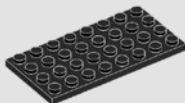

2x  
303526



2x  
6594403



2x  
6187587



2x  
6115031



1x  
6097420

1x  
6422088

2x  
4211159

1x  
6507895

1x  
6597878

14x  
6514199

2x  
6510078

4x  
6341968

5x  
6407771

2x  
6507886

1x  
6265371

1x  
6514227

2x  
6350724

2x  
6284586

3x  
6269077

4x  
6544432

1x  
6480597

1x  
6514272

2x  
6115080

2x  
4211183

4x  
6551600

2x  
6504014

1x  
6270032

1x  
6622495

2x  
6262899

4x  
6433717

2x  
6135494

4x  
6215387

1x  
6605239

1x  
6578808

2x  
6257592

2x  
4211242

2x  
4211200

8x  
6209683

1x  
6234805

1x  
6372122

2x  
6514463

2x  
6092568

5x  
6078605

2x  
4211202

2x  
6361988

2x  
6383102

2x  
6478179

5x  
6559244

1x  
6387468

2x  
6365885



 [LEGO.com/service](https://www.LEGO.com/service)

YOU COULD **WIN**



Scan this QR code or go to **LEGO.COM/PRODUCTFEEDBACK** and give us your short feedback about this LEGO® set for a chance to win a cool LEGO prize.

Terms and Conditions apply\*



**EN: YOU COULD WIN.** Terms and Conditions apply\* **DE: Du könntest GEWINNEN.** Es gelten die Teilnahmebedingungen\* **FR: TU POURRAIS GAGNER.** Des conditions s'appliquent\* **IT: Potresti VINCERE tu.** Termini e condizioni sono applicabili\* **ES: PUEDES GANAR.** Aplican términos y condiciones\* **PT: PODERÁ GANHAR.** Aplicam-se Termos e Condições\* **ZH: 轻松获奖. 条款和条件适用\*** **PL: Szansa na WYGRANĄ.** Obowiązuje regulamin\* **CS: Máte šanci VYHRÁT.** Platí všeobecné smluvní podmínky\* **SK: Máte šancu VYHRÁŤ.** Platia všeobecné zmluvné podmienky\* **HU: TE IS NYERHETSZ!** Felhasználási feltételek érvényesek\* **UA: ВИ МОЖЕТЕ ВИГРАТИ.** Застосовуються загальні положення та умови\* **RO: Ai putea CÂȘTIGA.** Se aplică termeni și condiții\* **BG: Можете да СПЕЧЕЛИТЕ.** Има определени правила и условия\* **LV: Tu vari LAIMĒT.** Ir spēkā noteikumi un nosacījumi.\* **ET: Sul on võimalus VÕITA.** Kehtivad tingimused\* **LT: Jūs galite LAIMĖTI.** Taikomos sąlygos\* **TR: KAZANABİLİRSİN.** Şartlar ve Koşullar geçerlidir\*

\*[LEGO.com/productfeedback-terms](https://www.lego.com/productfeedback-terms)

LEGO and the LEGO logo are trademarks of the LEGO Group. ©2026 The LEGO Group.

All HARRY POTTER characters and elements © & ™ Warner Bros. Entertainment Inc. Publishing Rights © JKR. All Rights Reserved. Used with permission. (s26)

 6650612