



# Harry Potter

76471



2

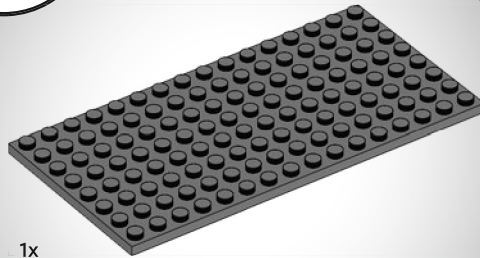
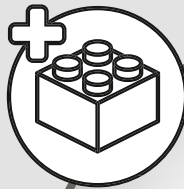

1x

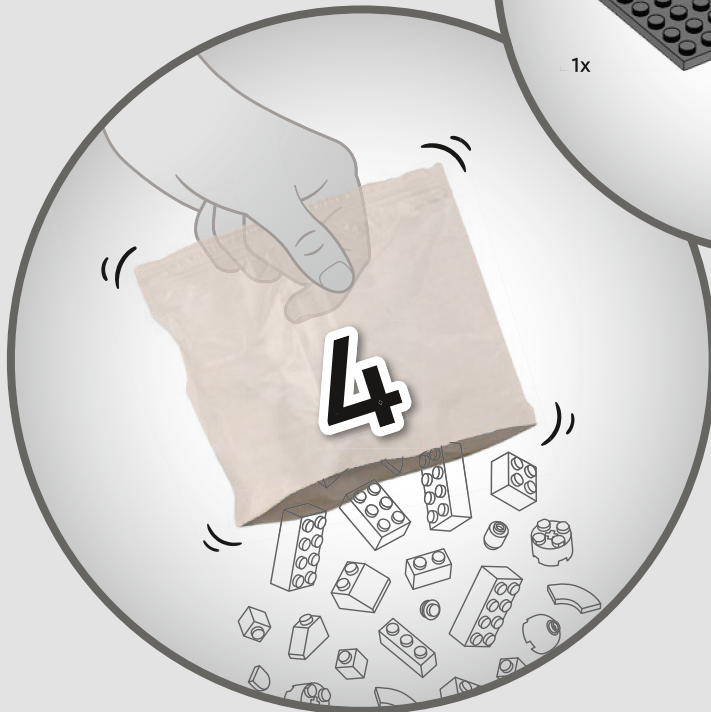

4



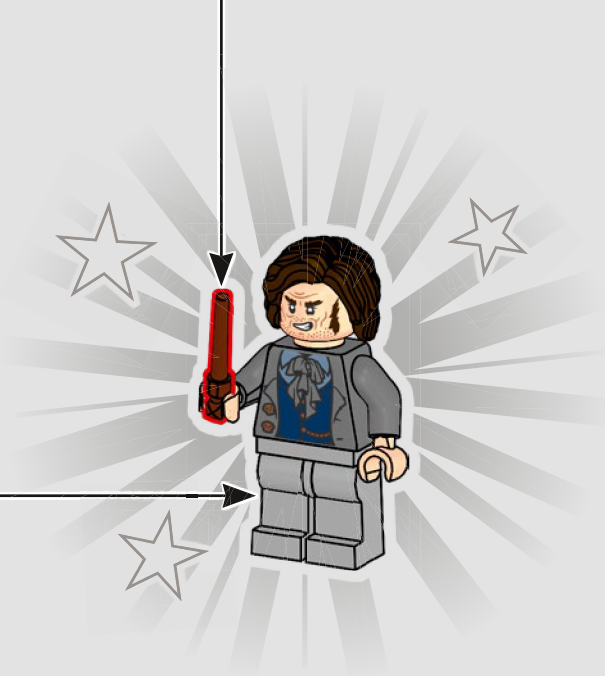
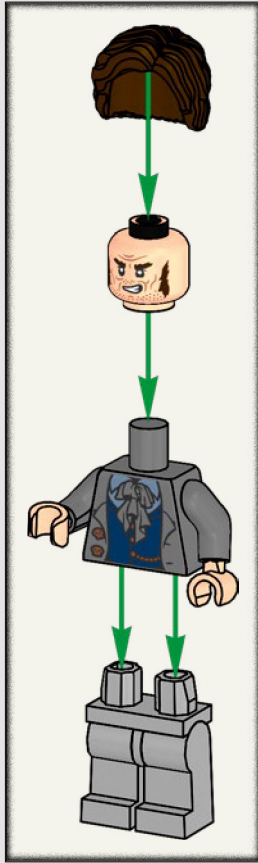

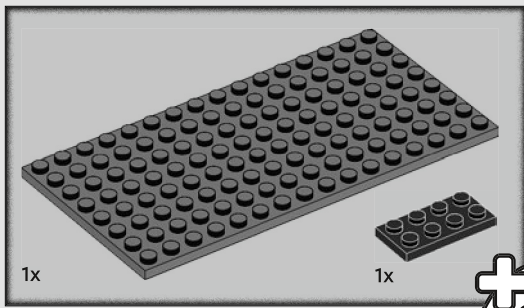

1

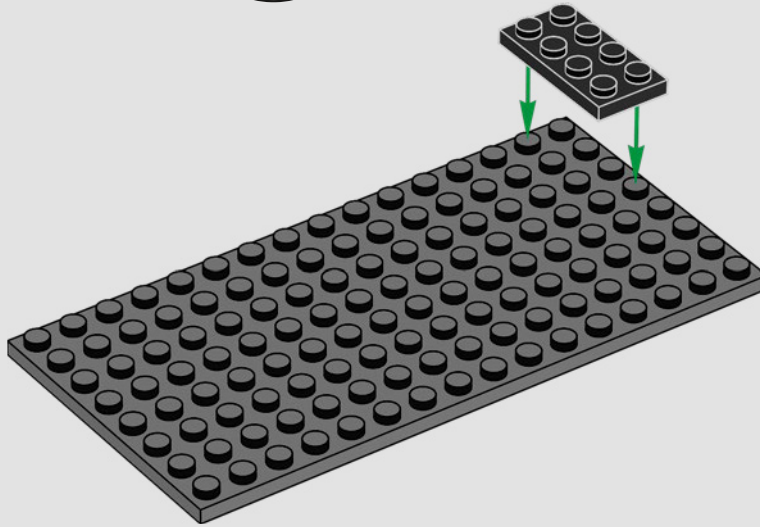
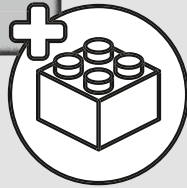

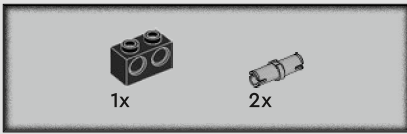

2

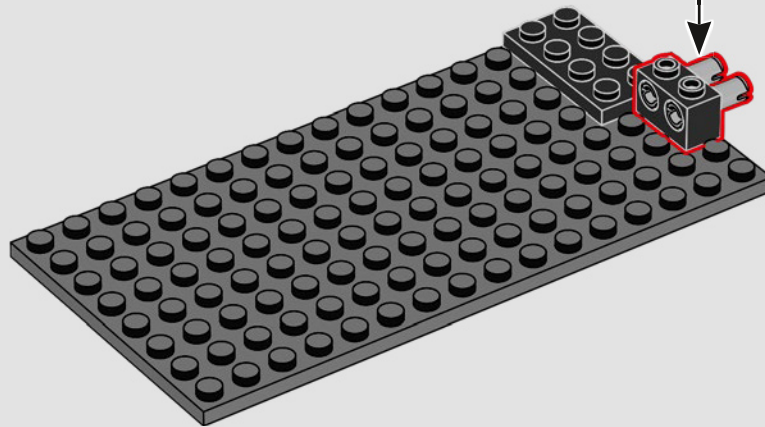
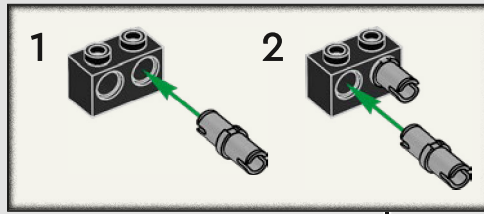

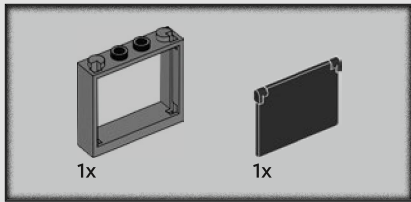

3

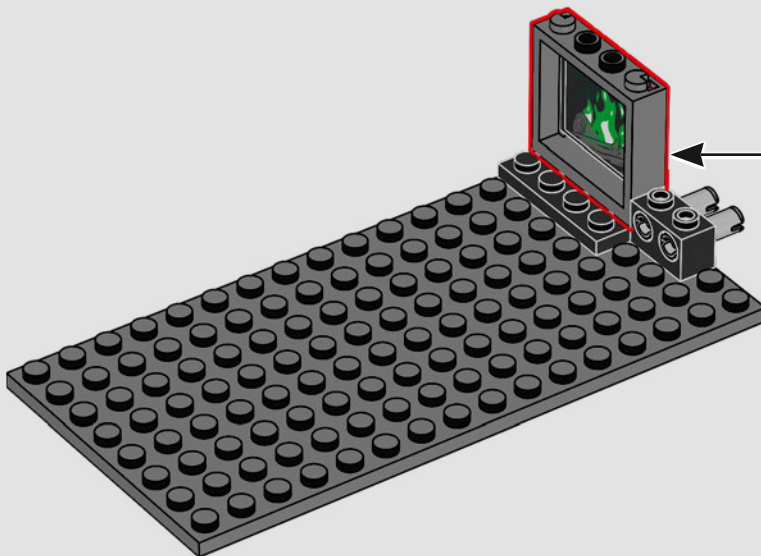
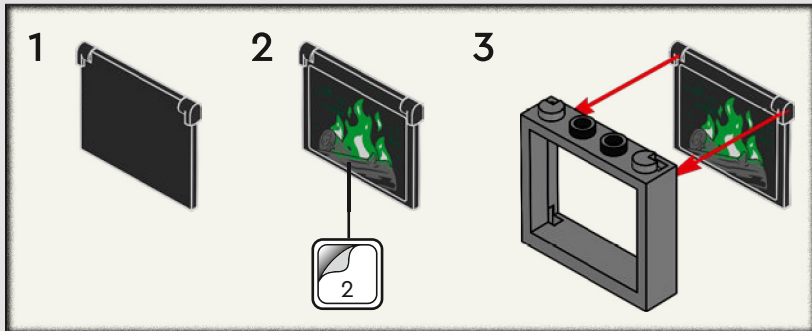

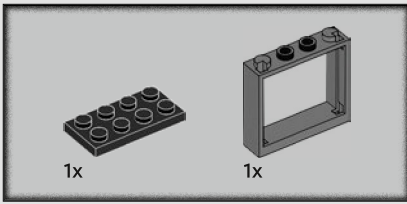

4

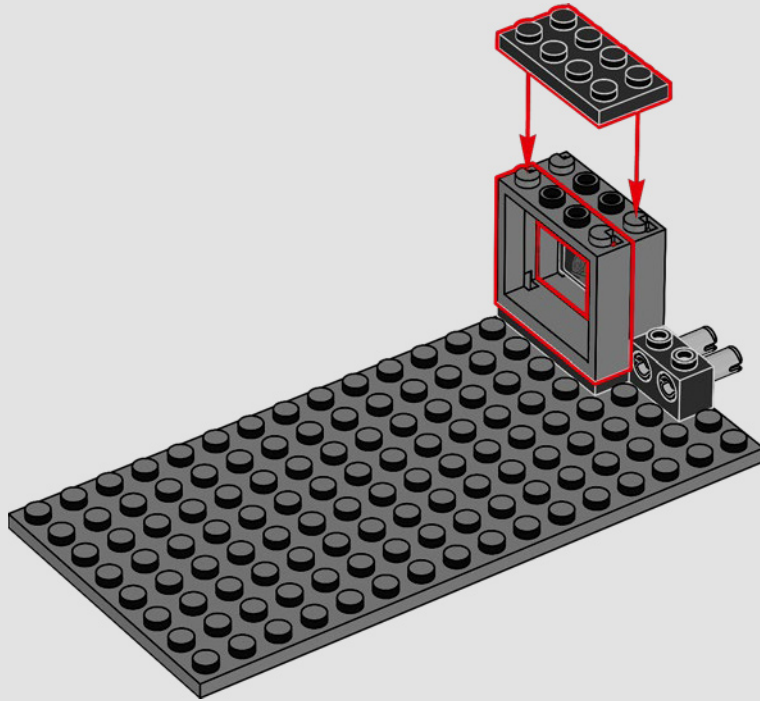

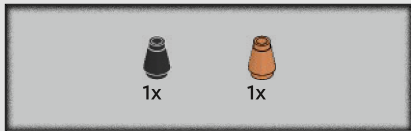

5

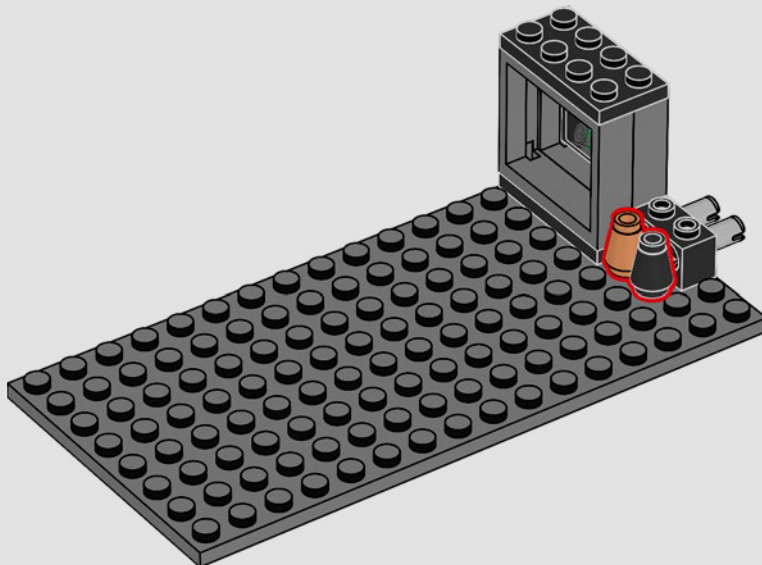

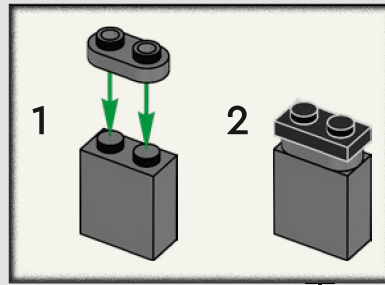
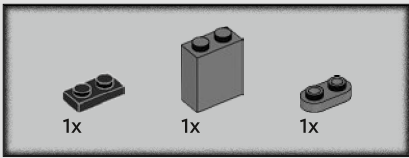

6

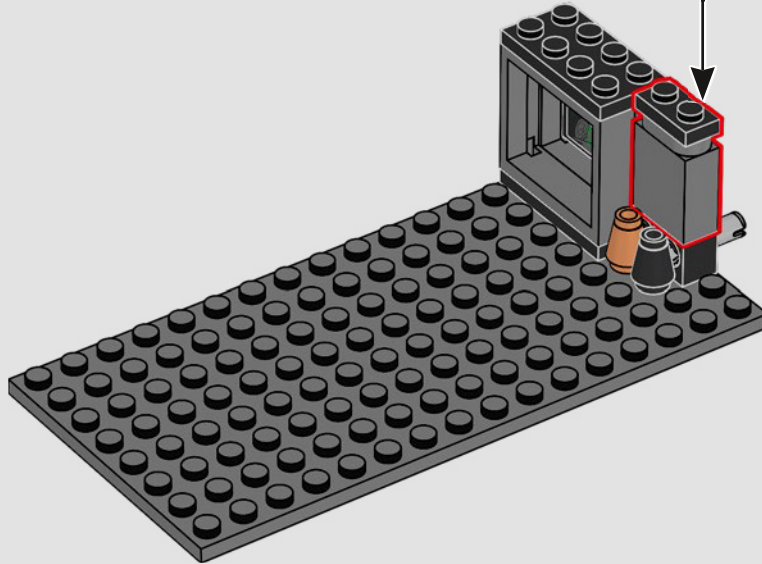



7

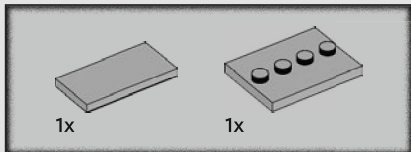
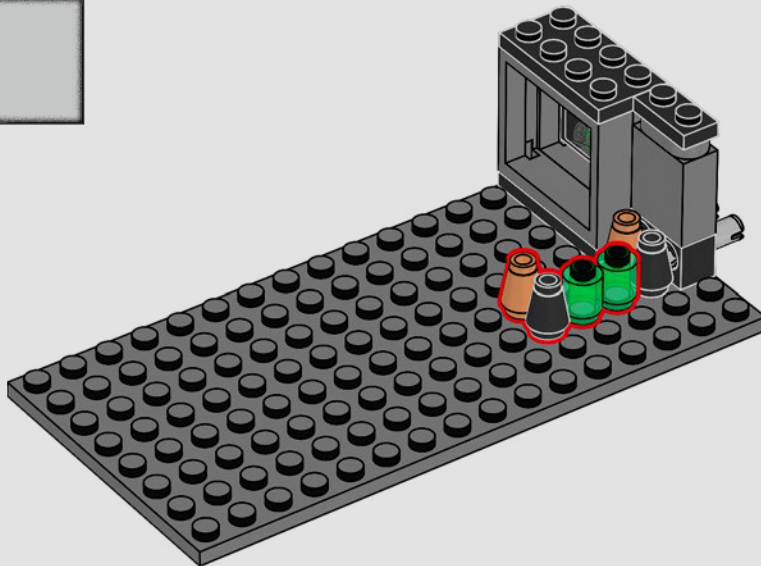

8

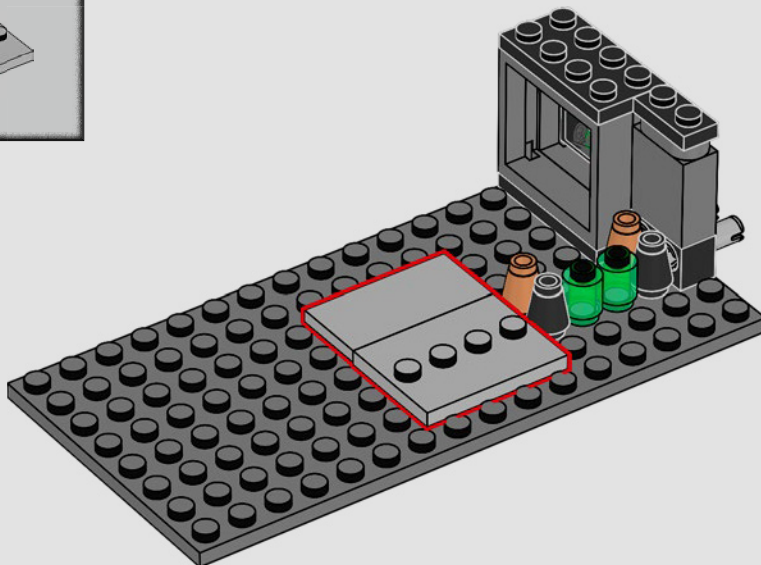

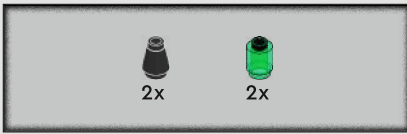

9

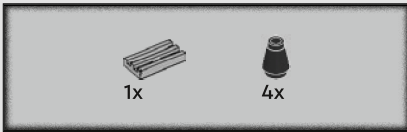
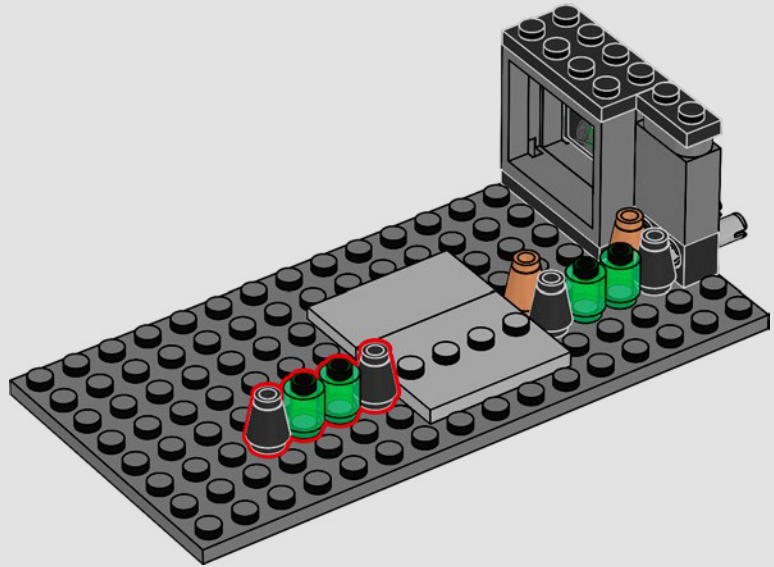

10

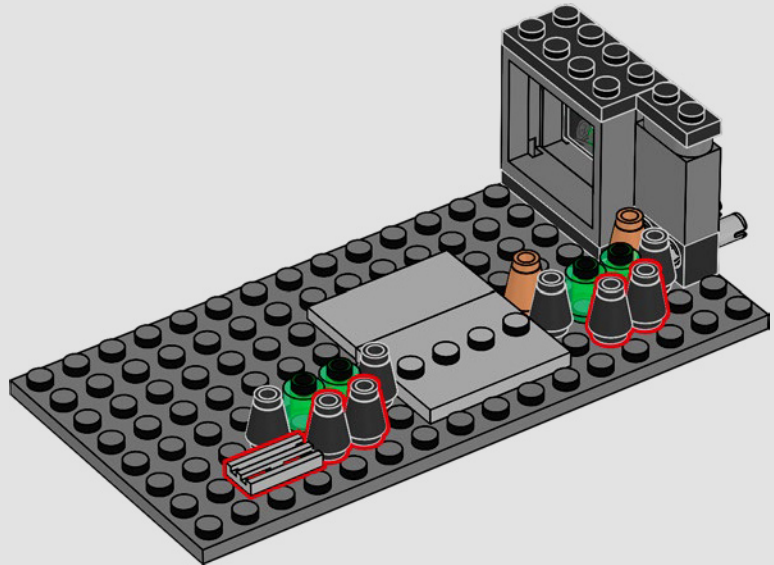



11

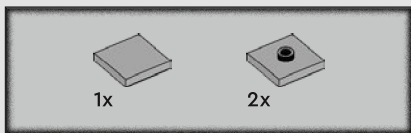
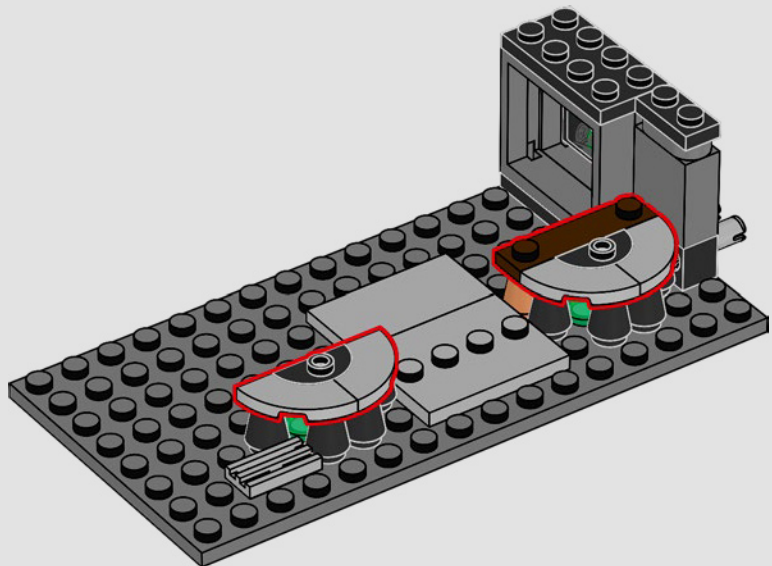

12

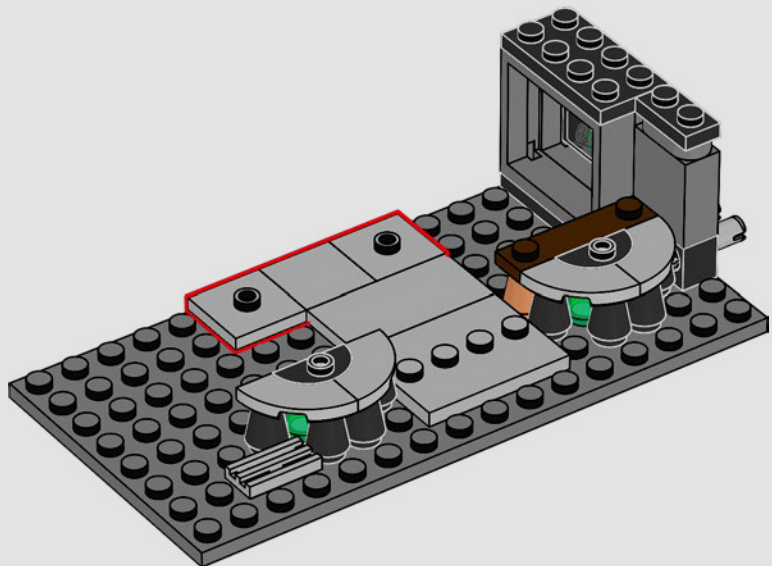

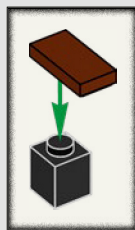
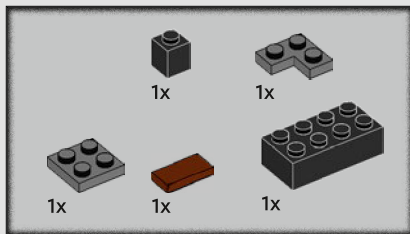

13

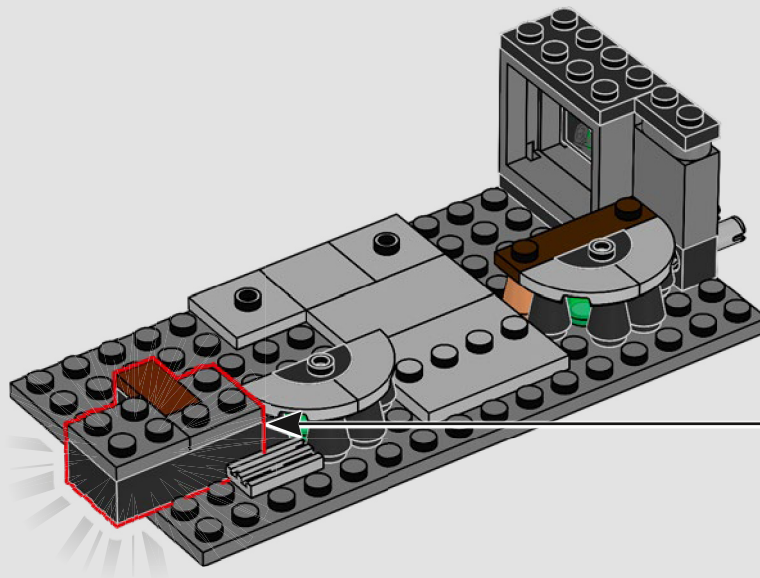
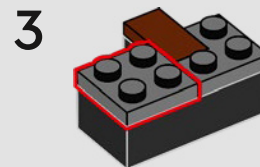
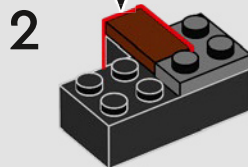
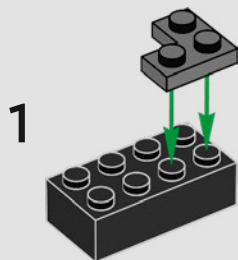

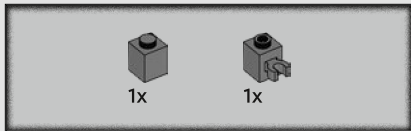

14

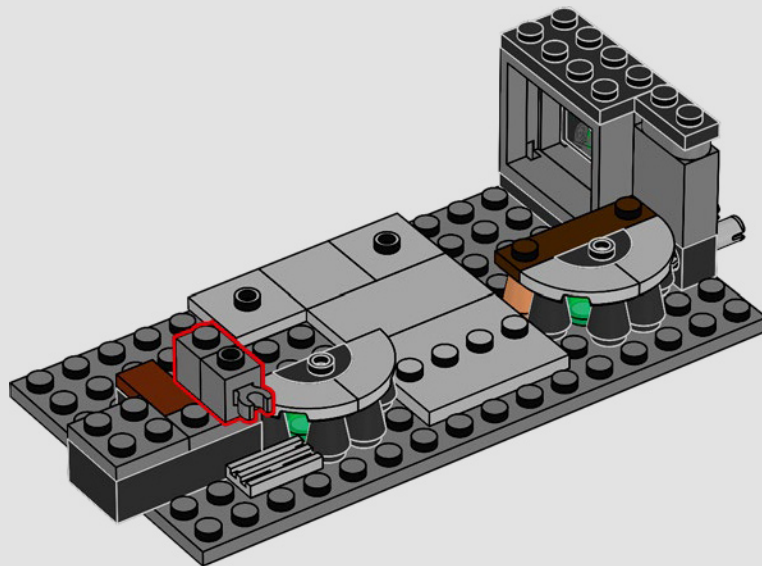

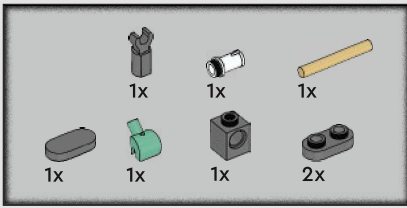

15

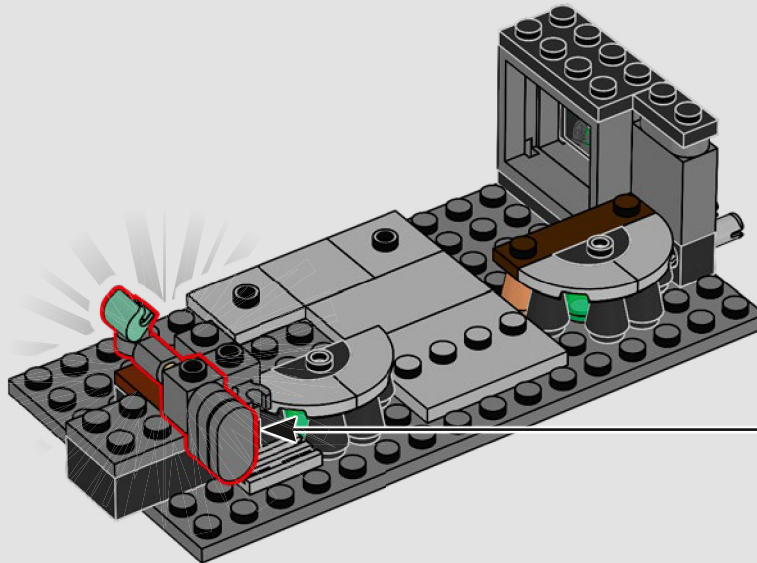
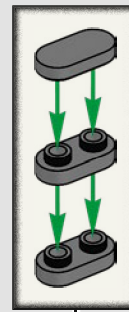
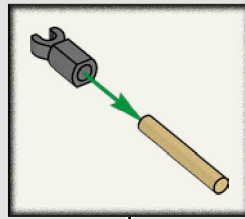
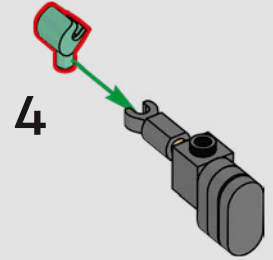
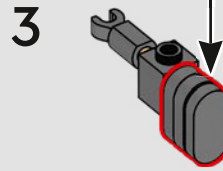
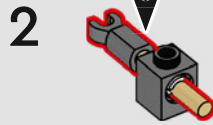
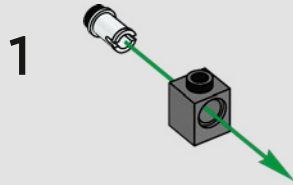





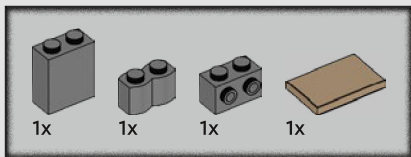

19

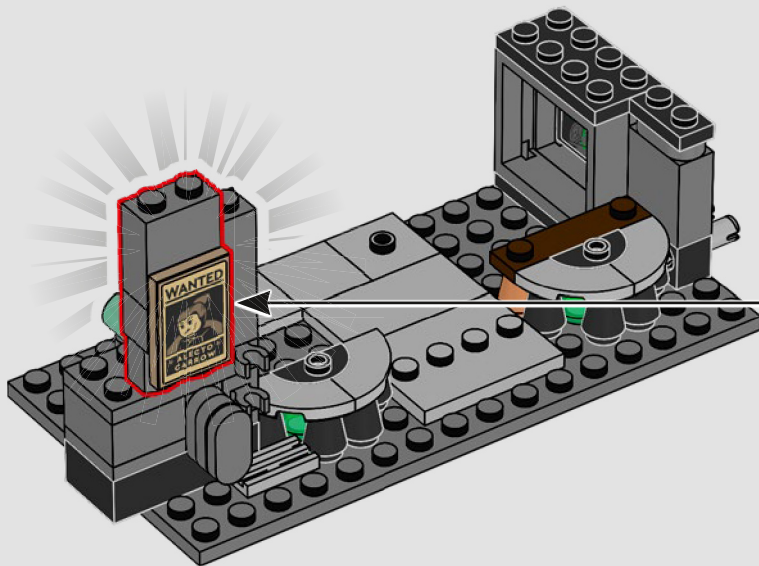
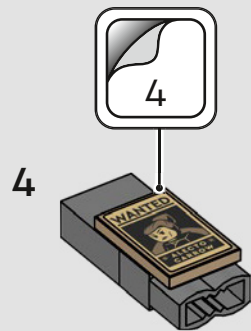
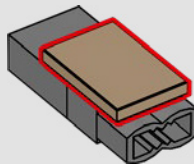
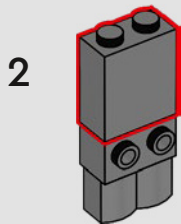
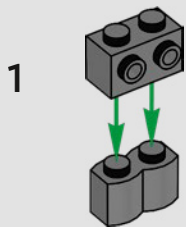

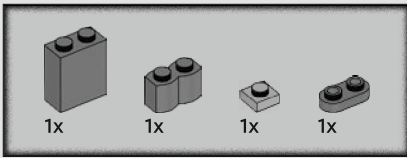

20

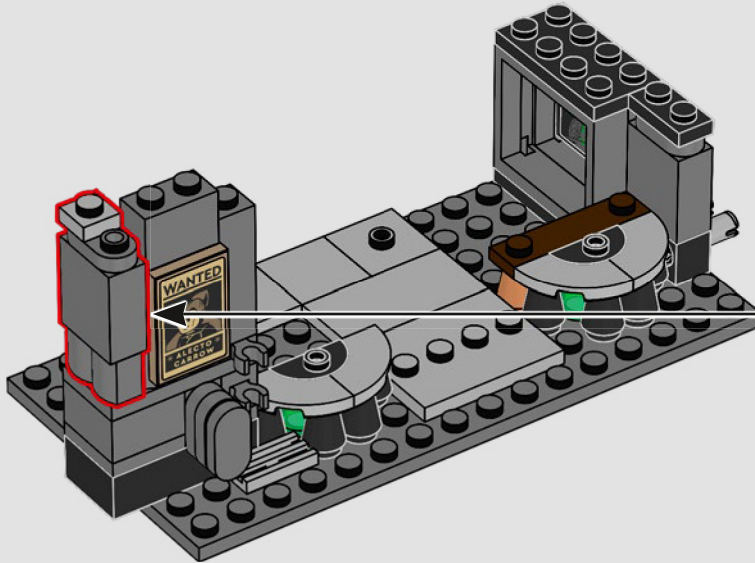
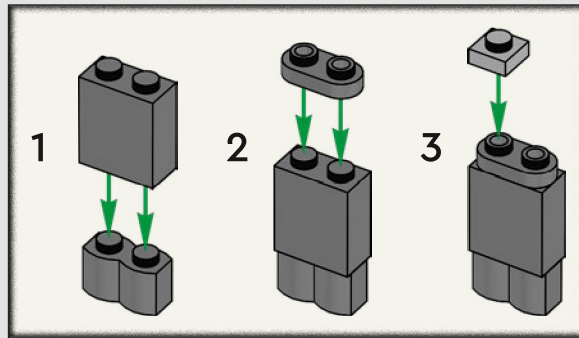

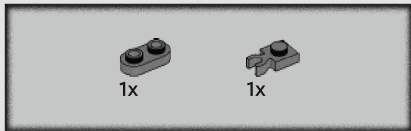

21

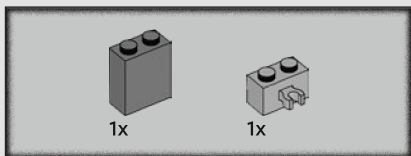
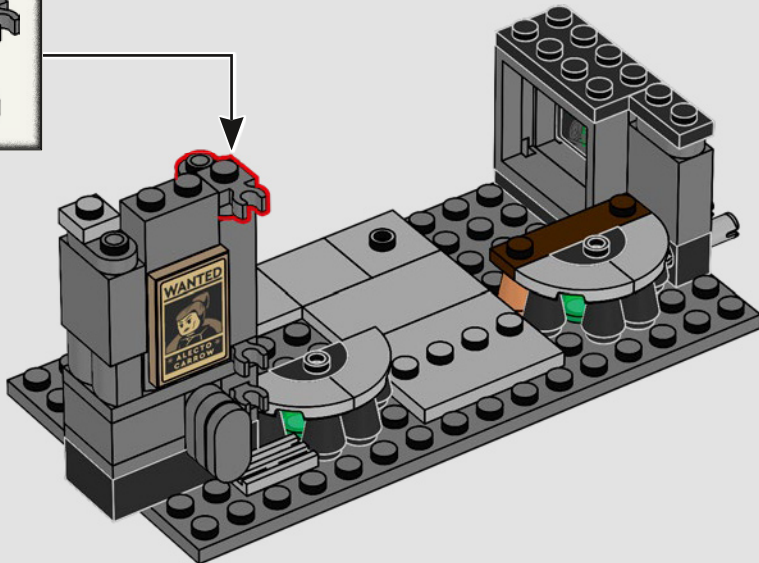
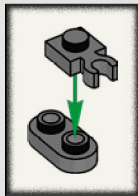

22

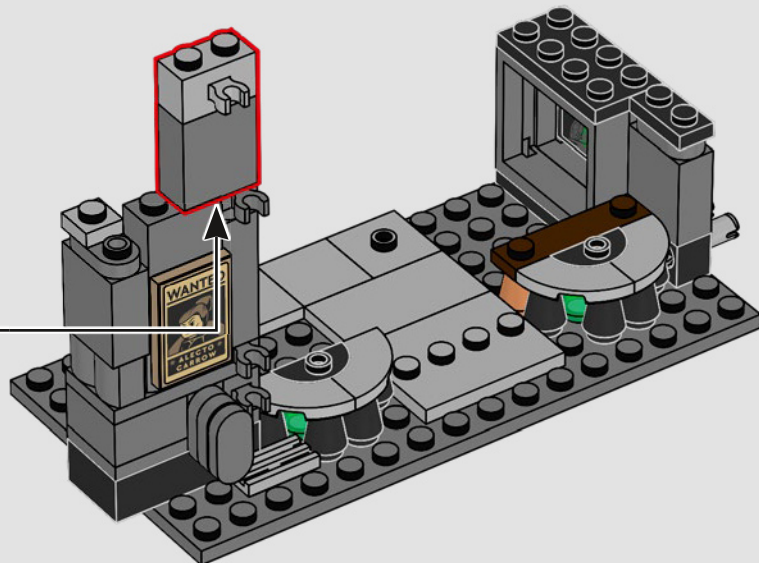
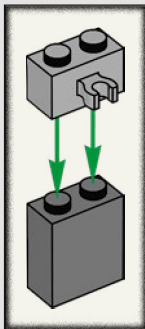

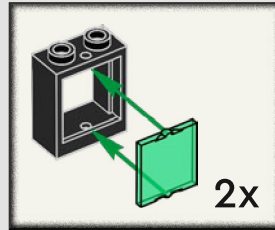
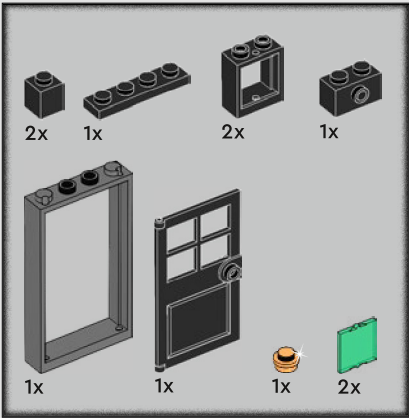
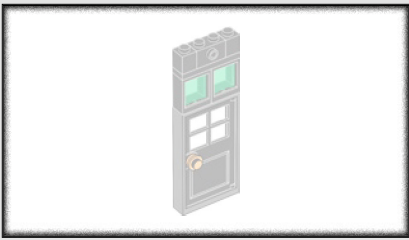

# 23

1

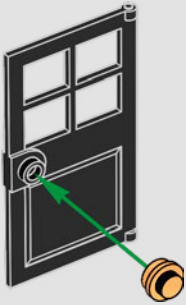

2

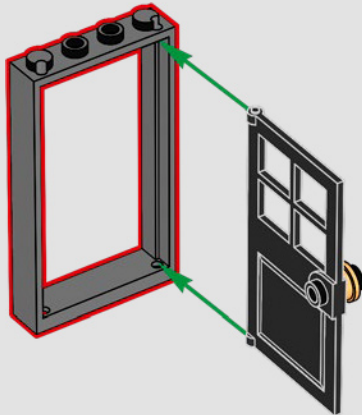

3



4



5

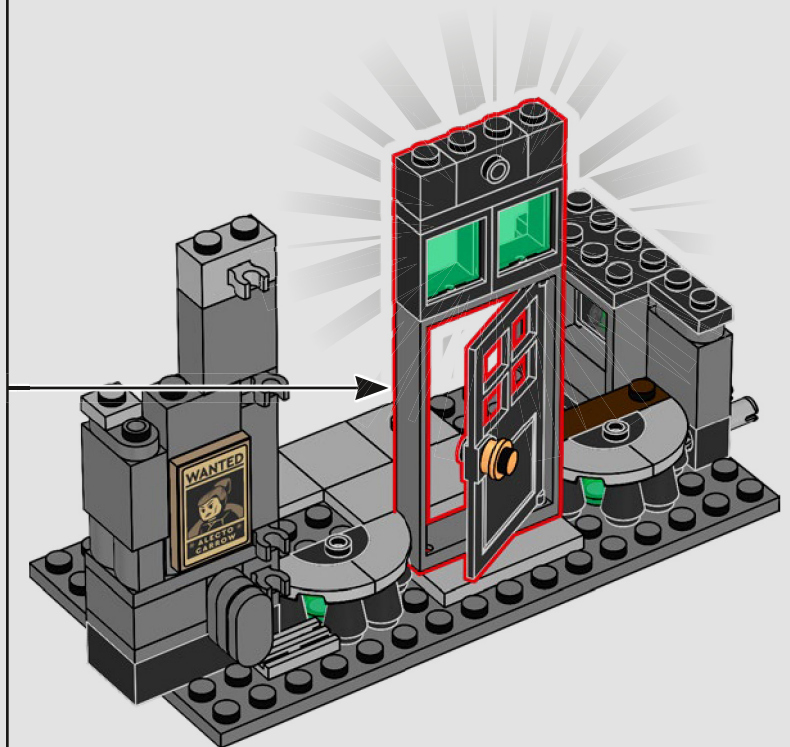
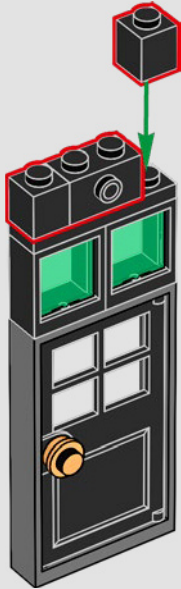

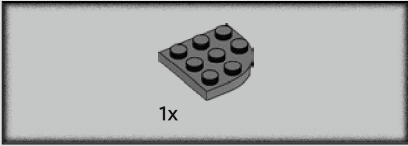
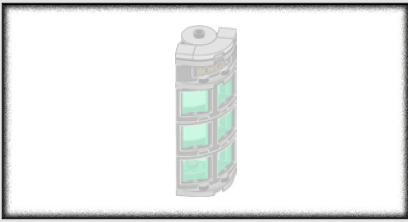

24

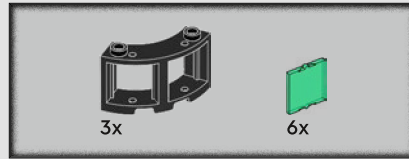

25

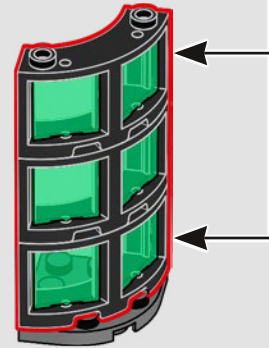
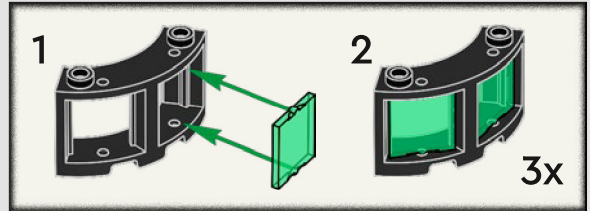

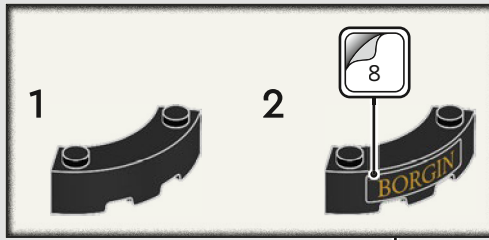
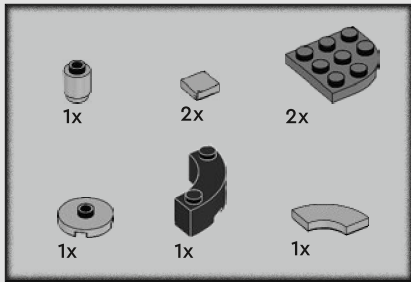

26

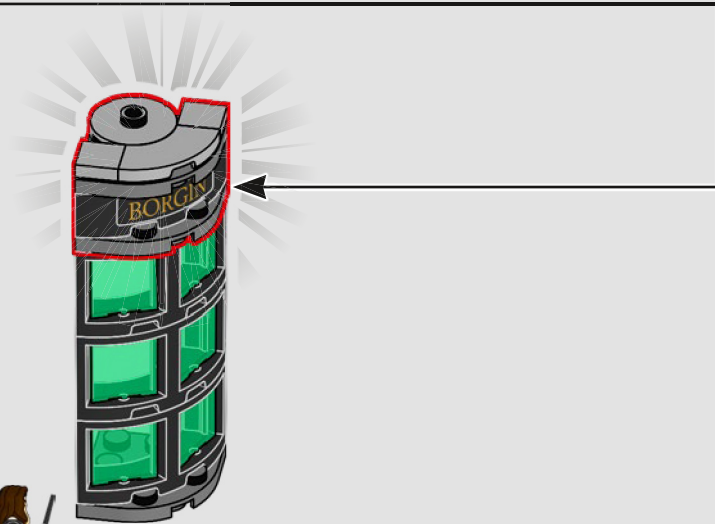
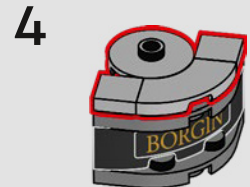
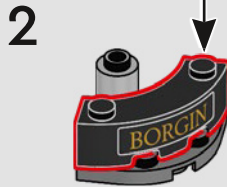
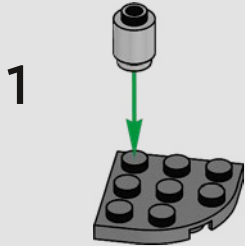

27

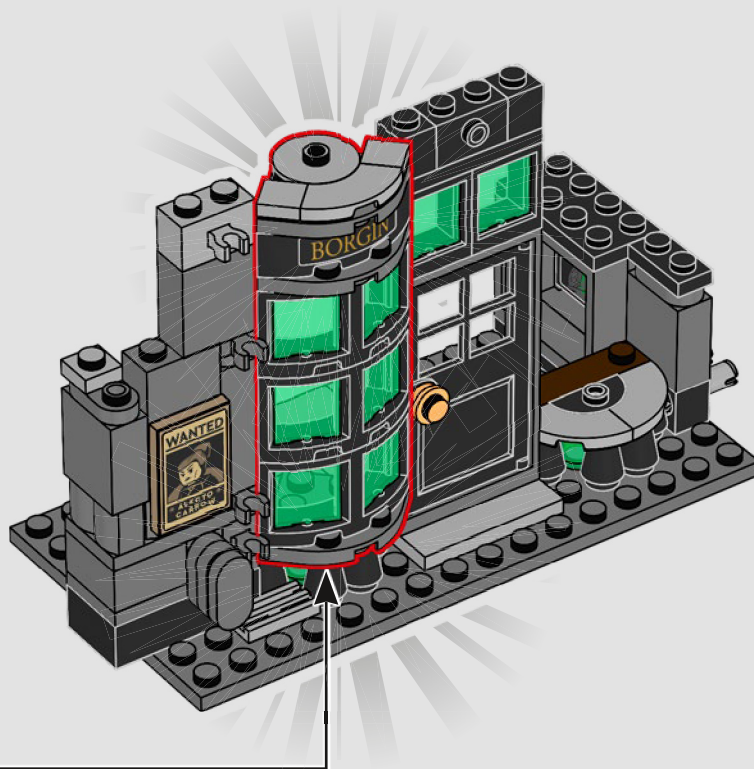

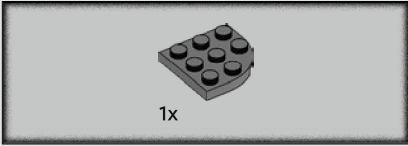
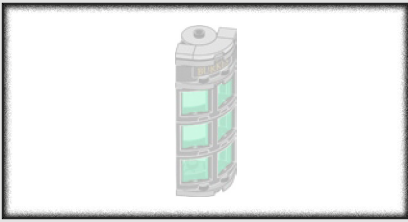

1x

28

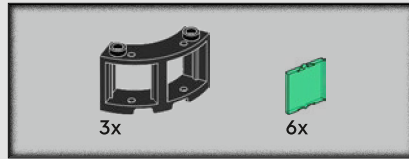

3x

6x

29

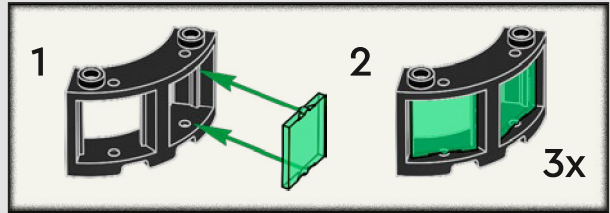

1

2

3x

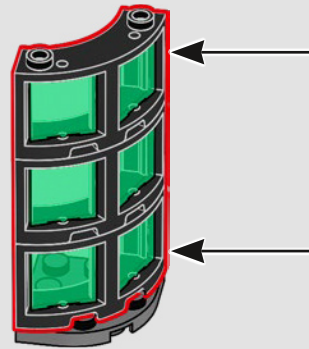

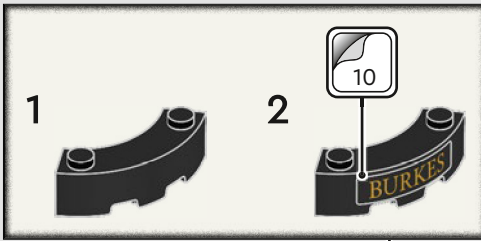
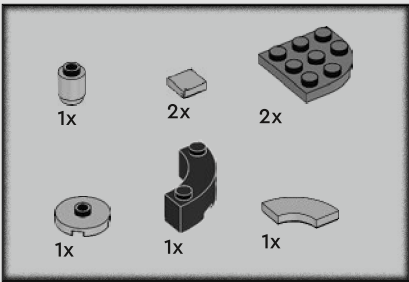

30

1

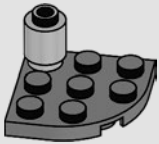

2



3

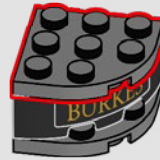

4

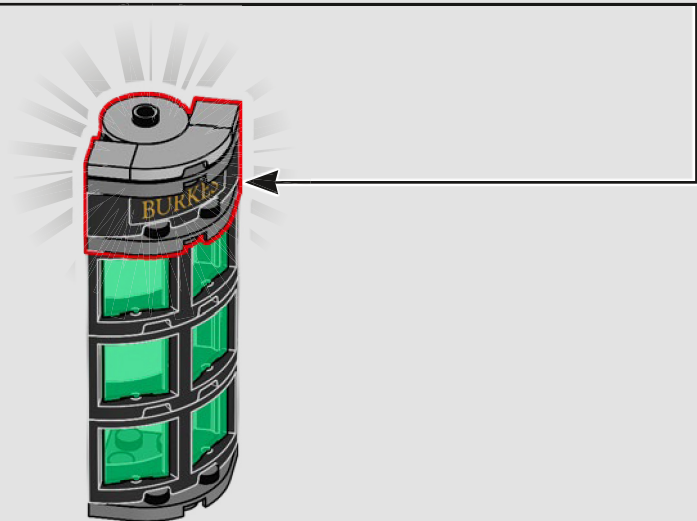

31

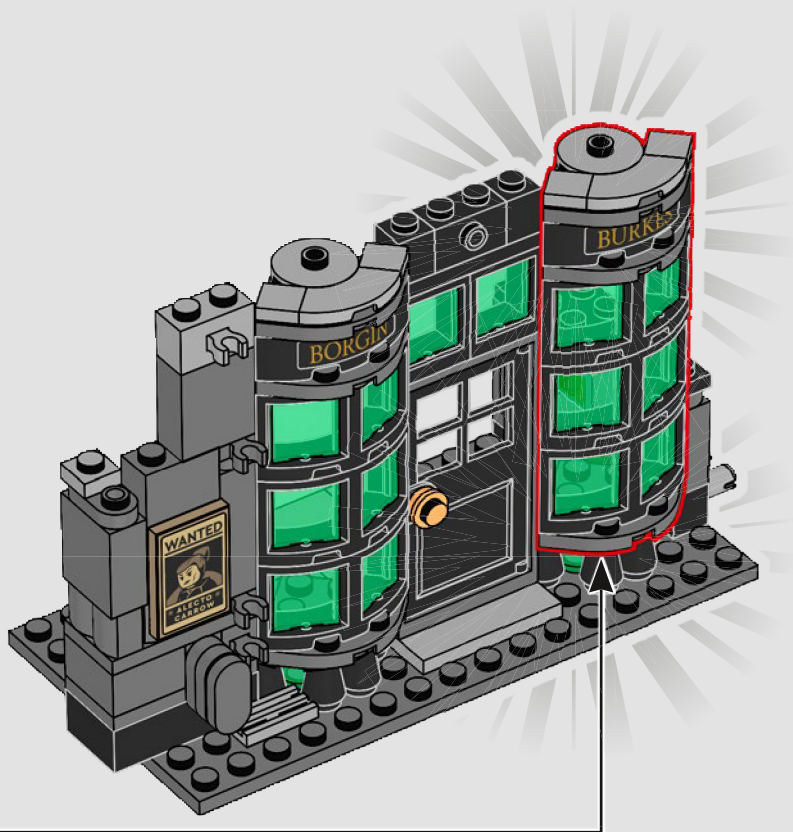

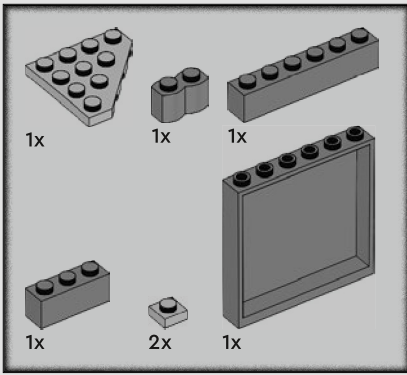

32

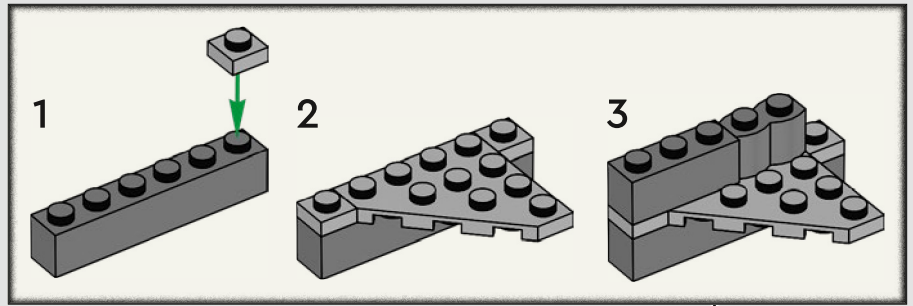

1

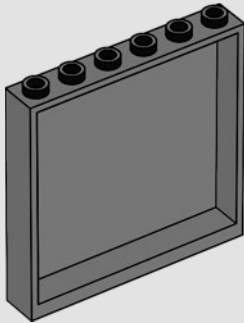

2

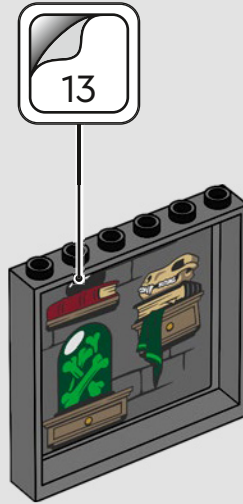

3

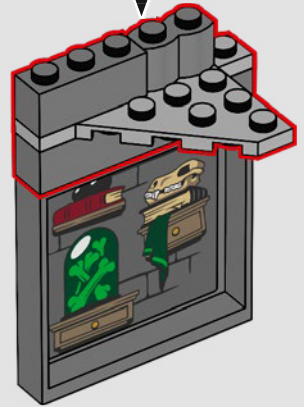

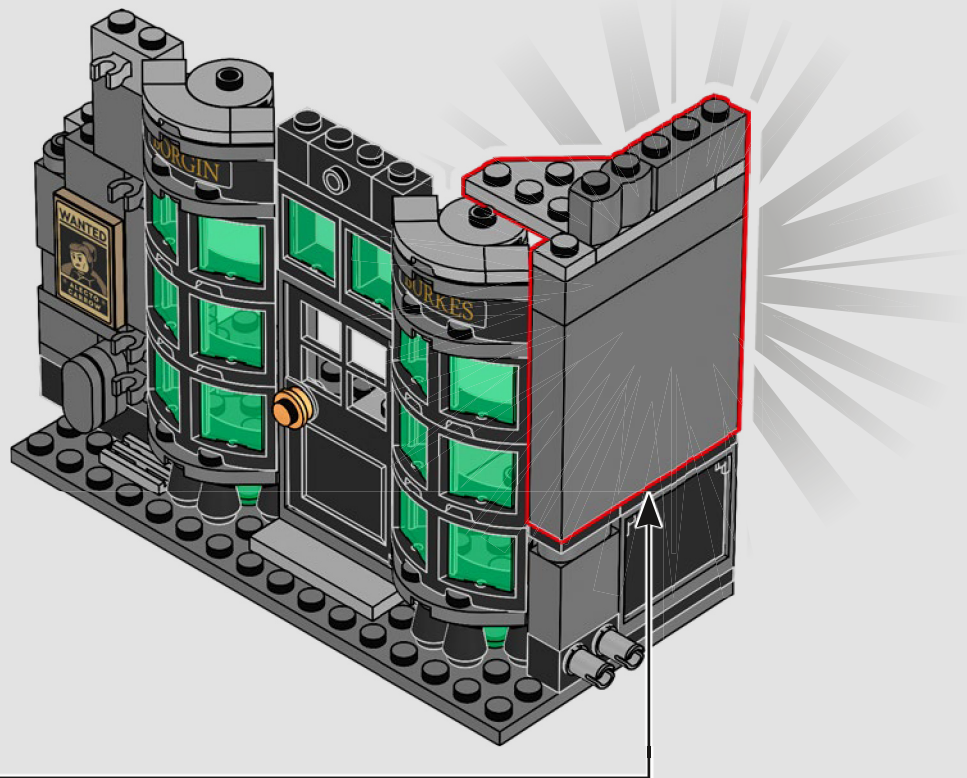

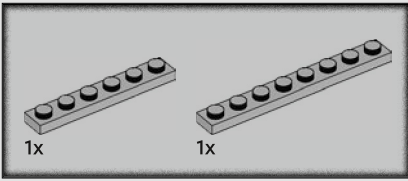

33

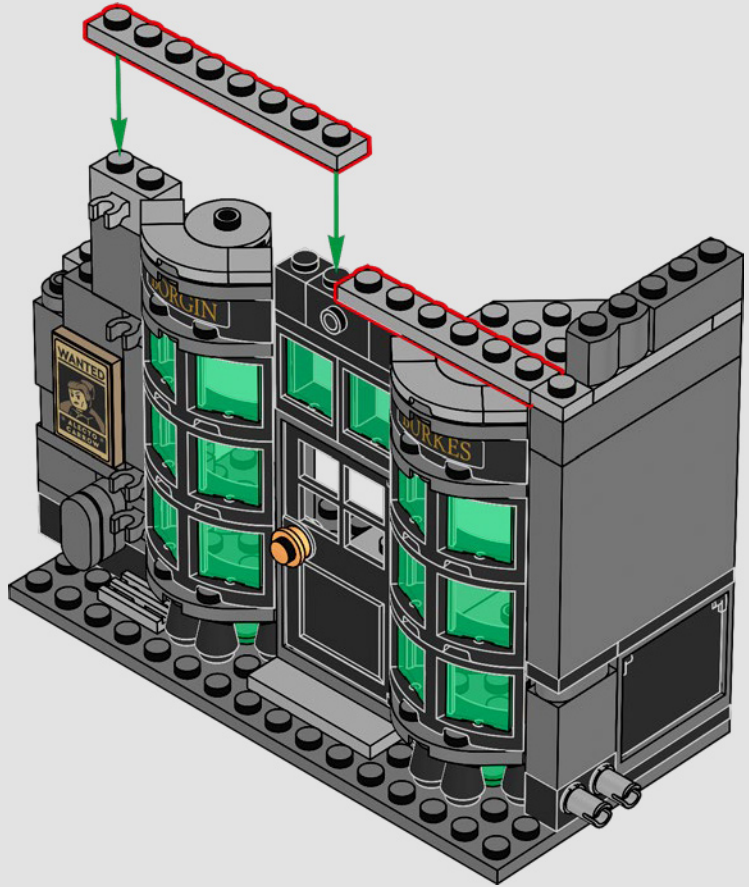

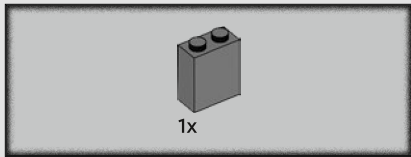

34

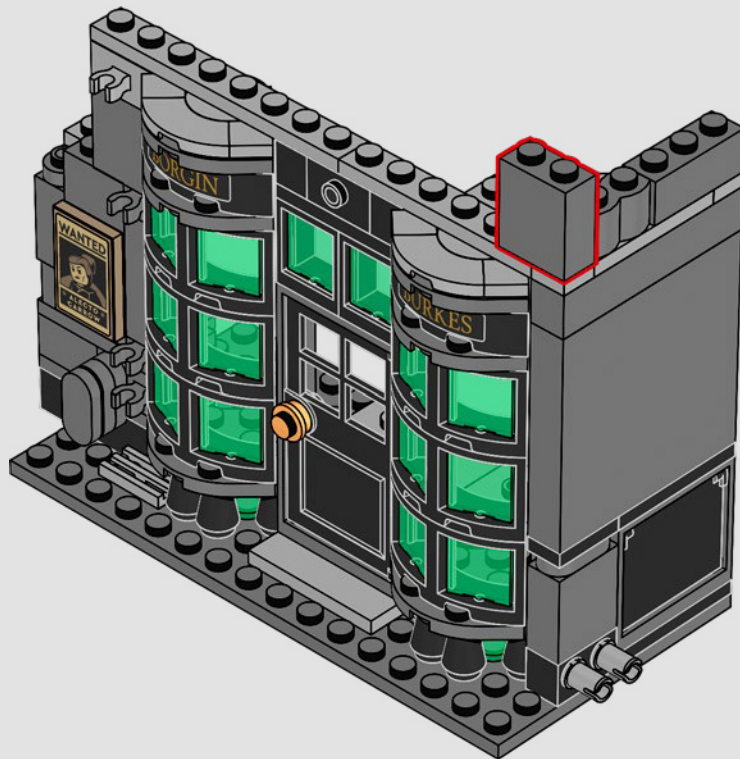

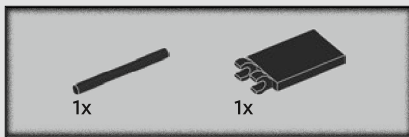

35

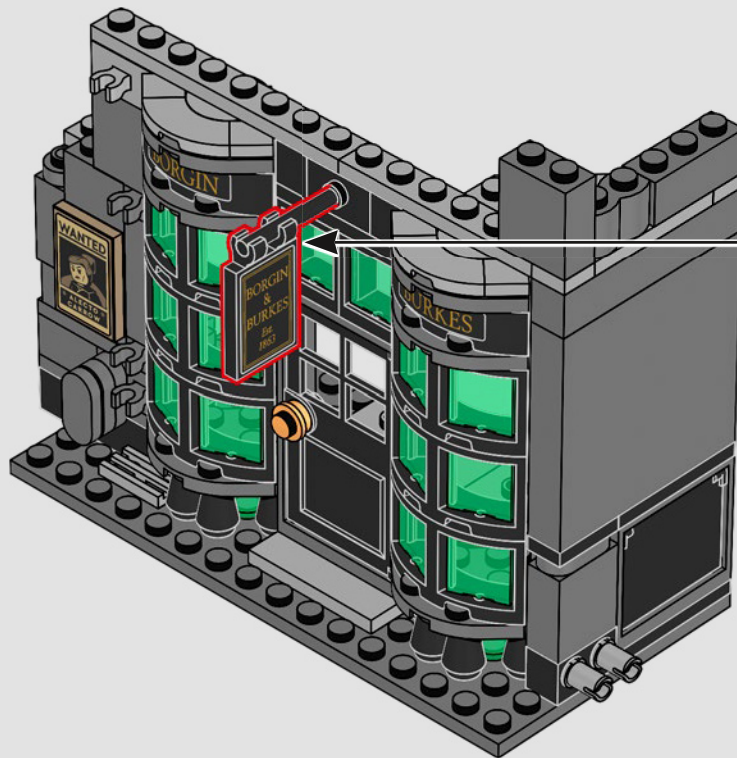
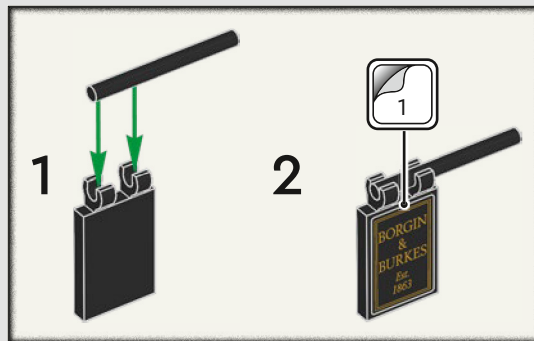

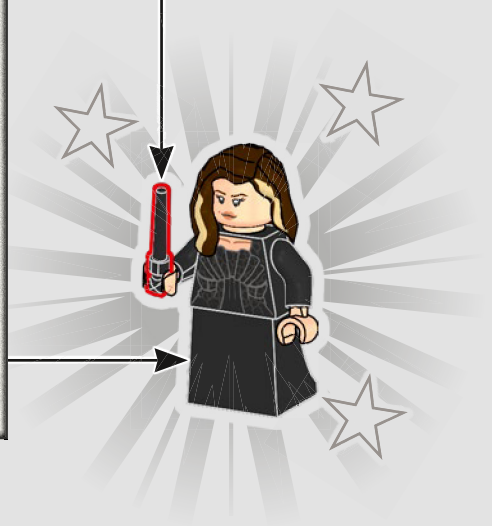
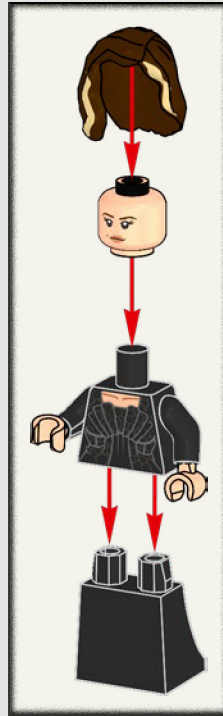

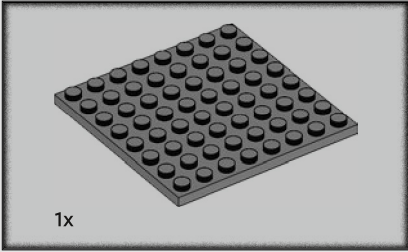
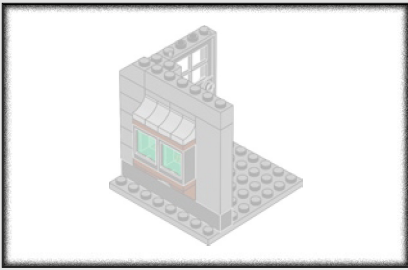

36

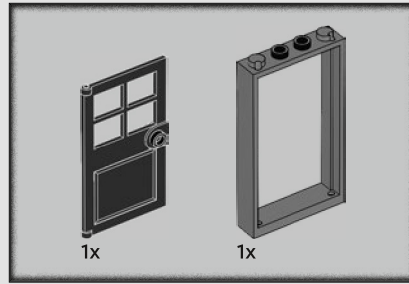
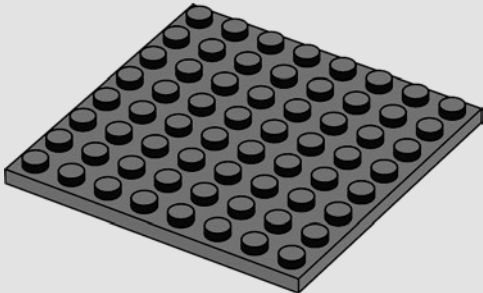

37

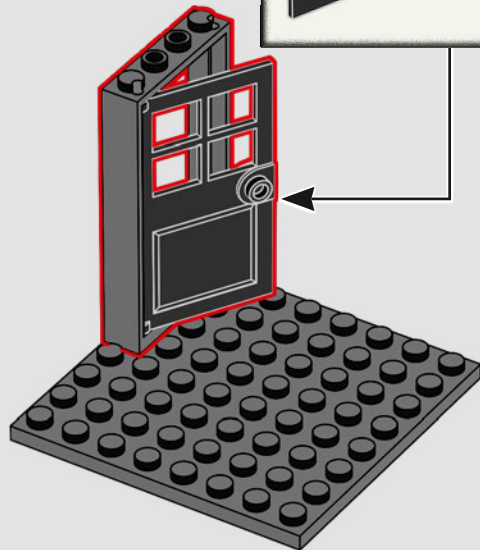
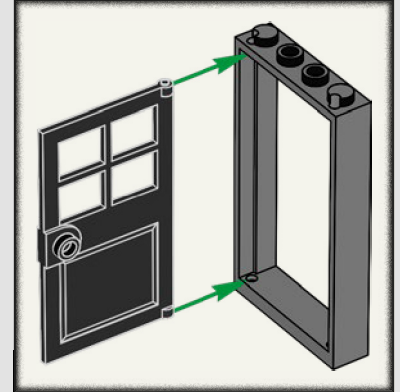

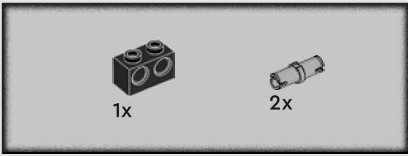

38

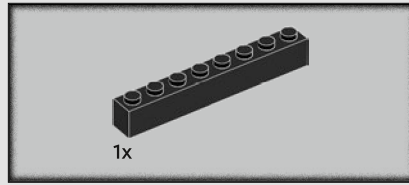
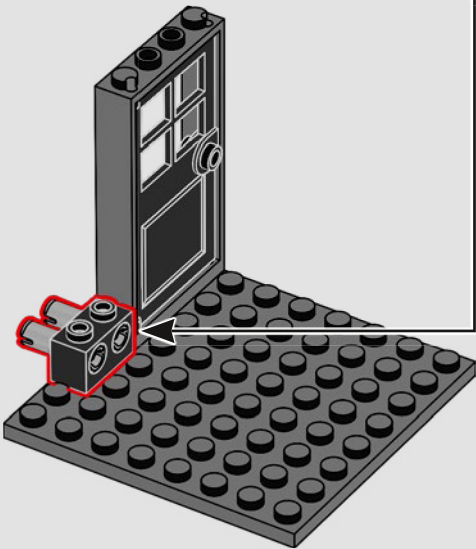
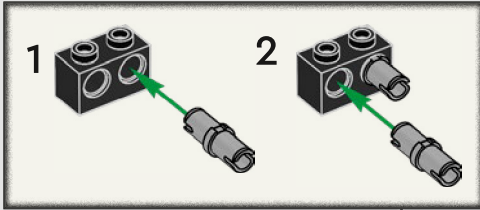

39

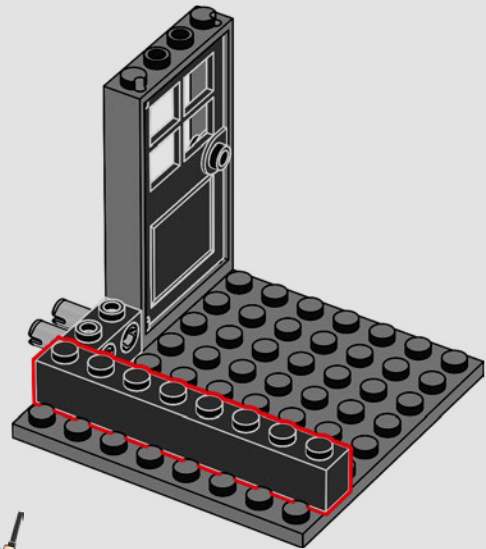

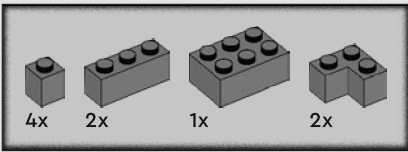

40

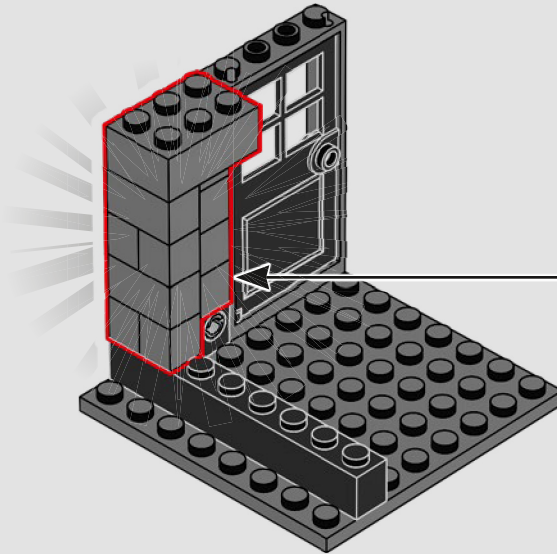
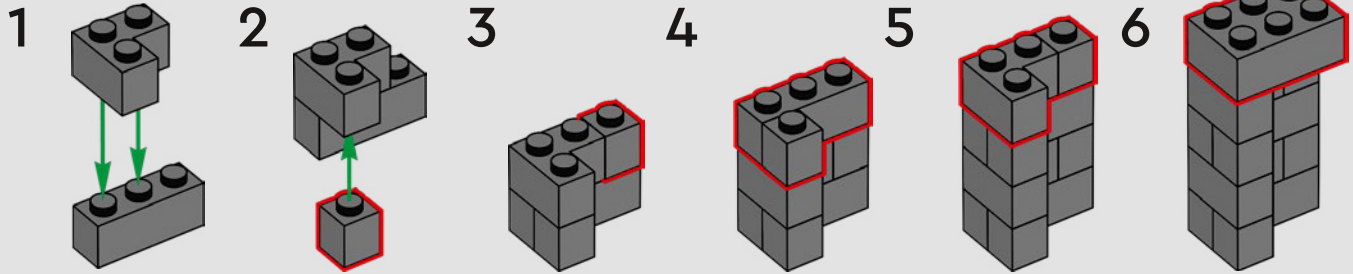

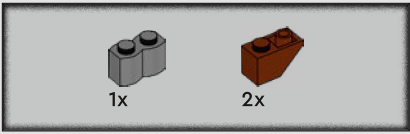

41

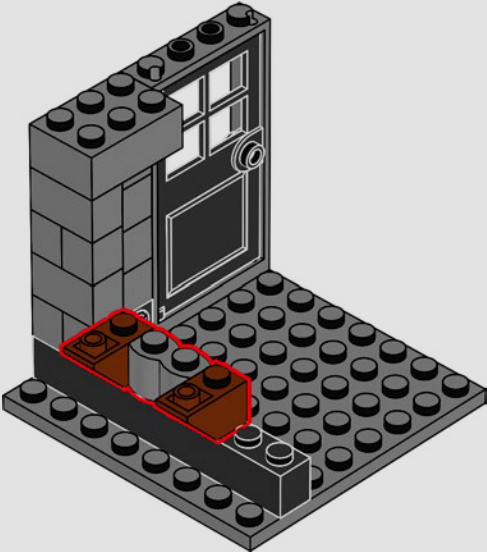

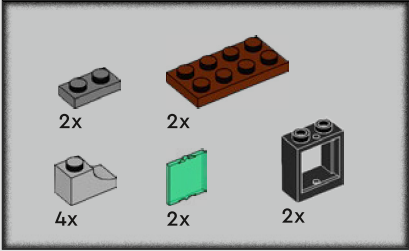
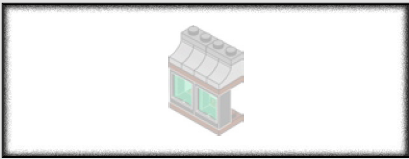

42

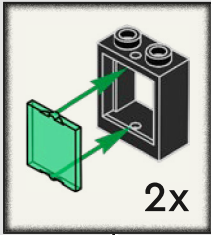
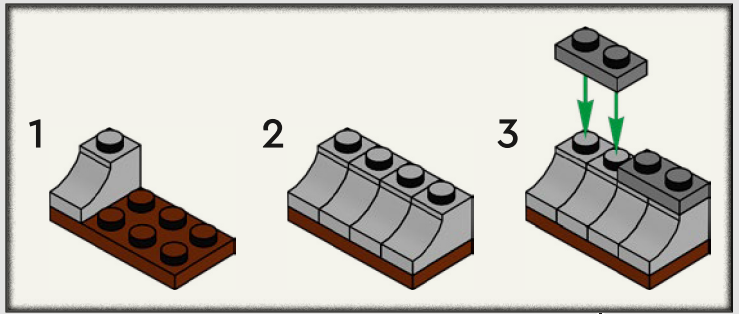

1

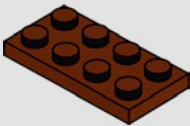

2

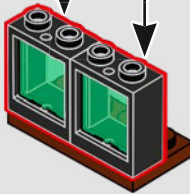

3



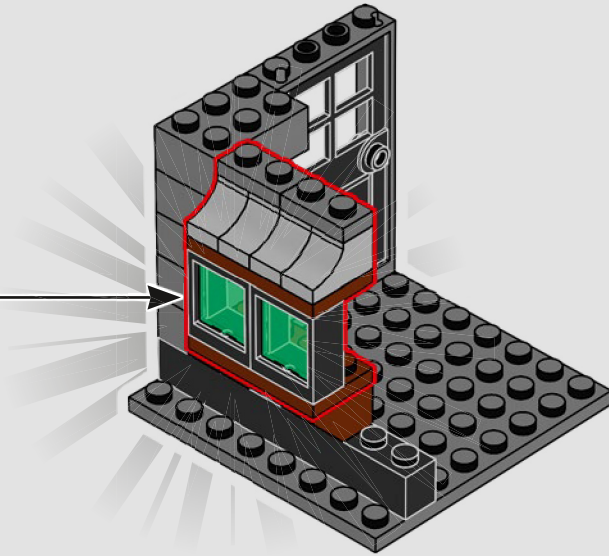

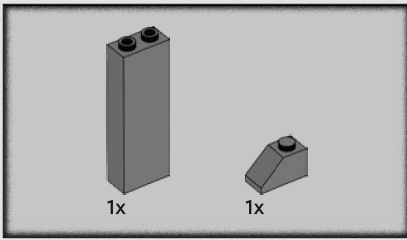

43

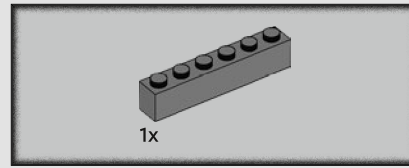
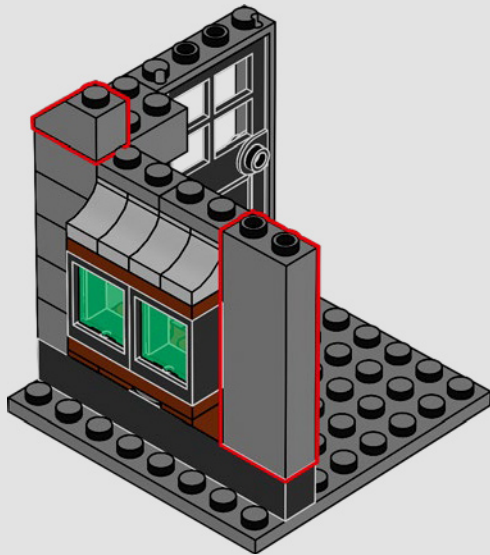

44

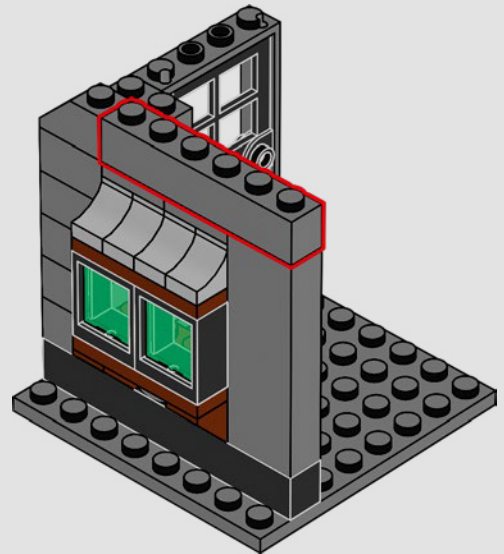



45

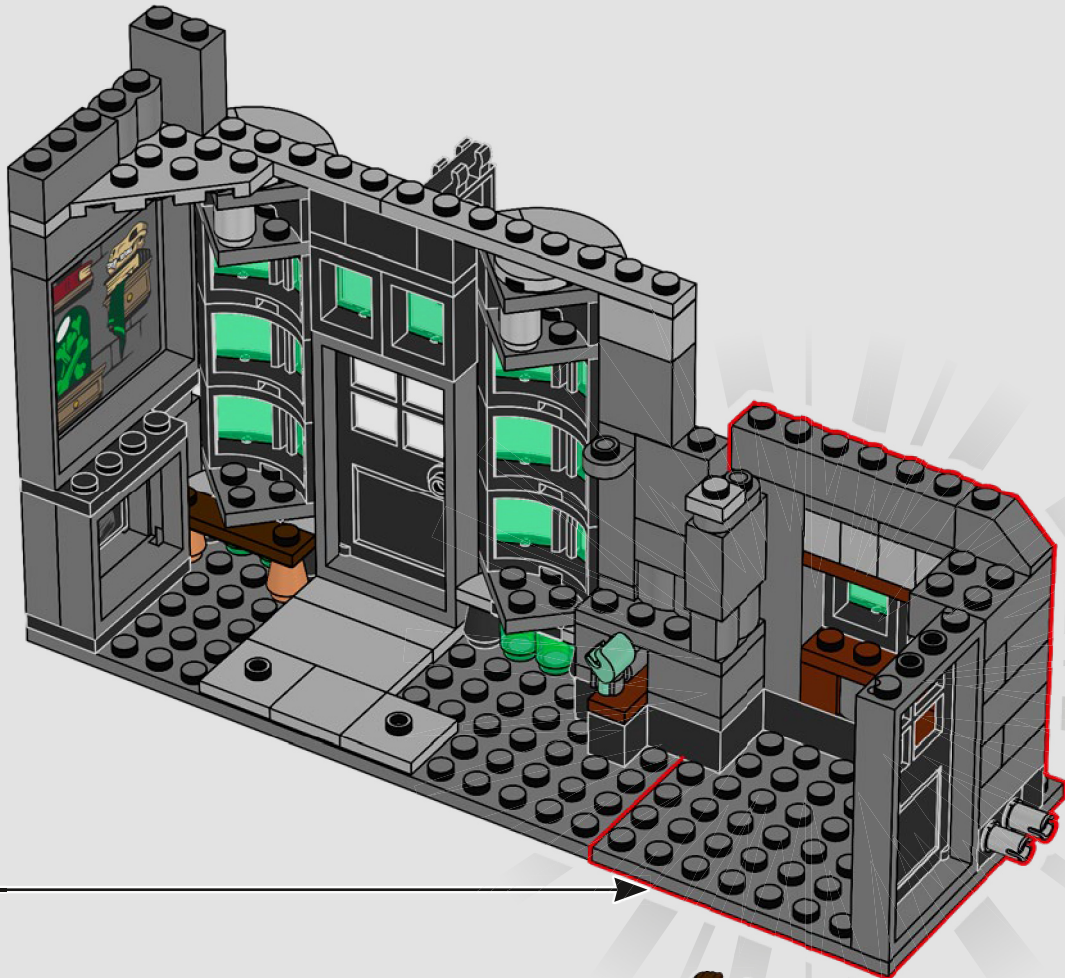

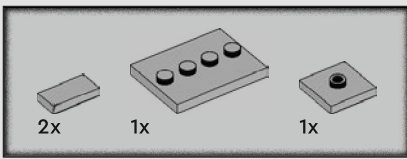

46

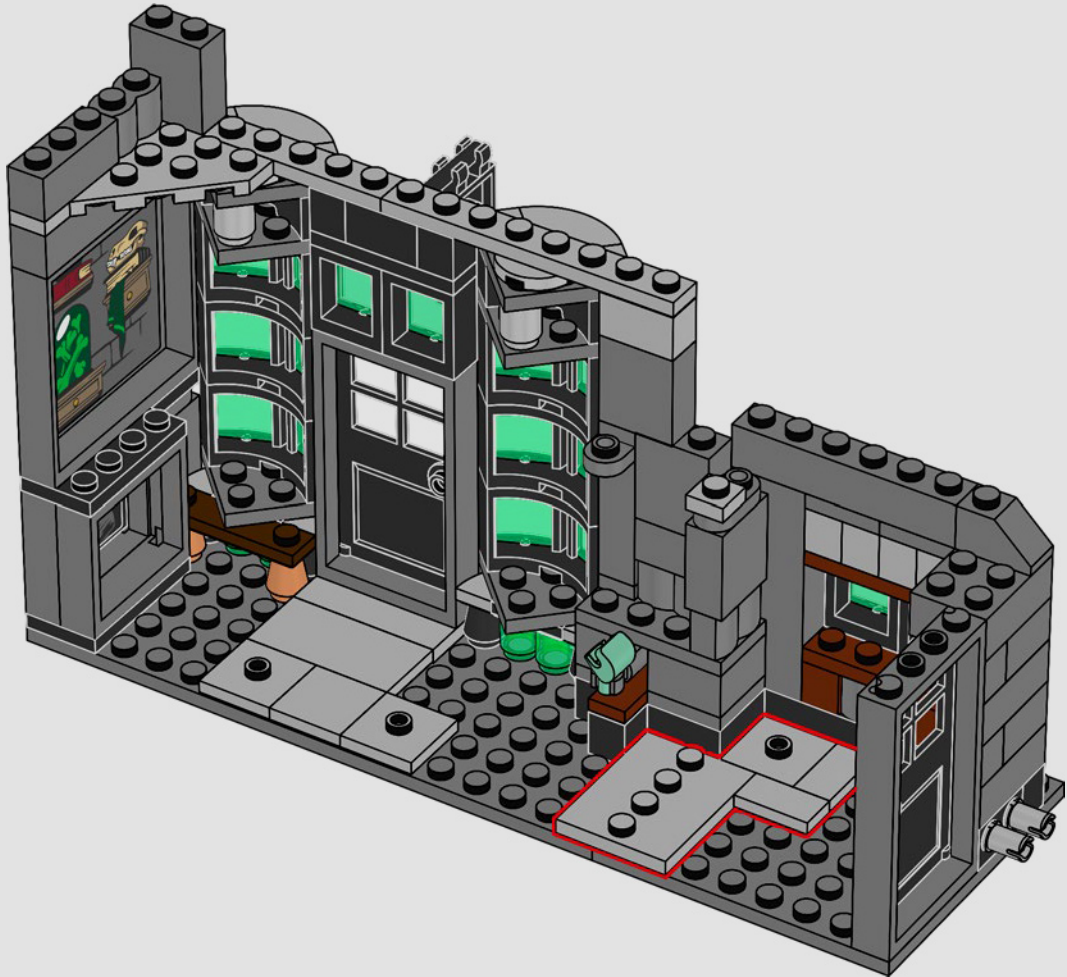

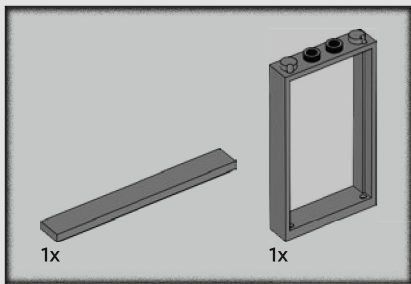

47

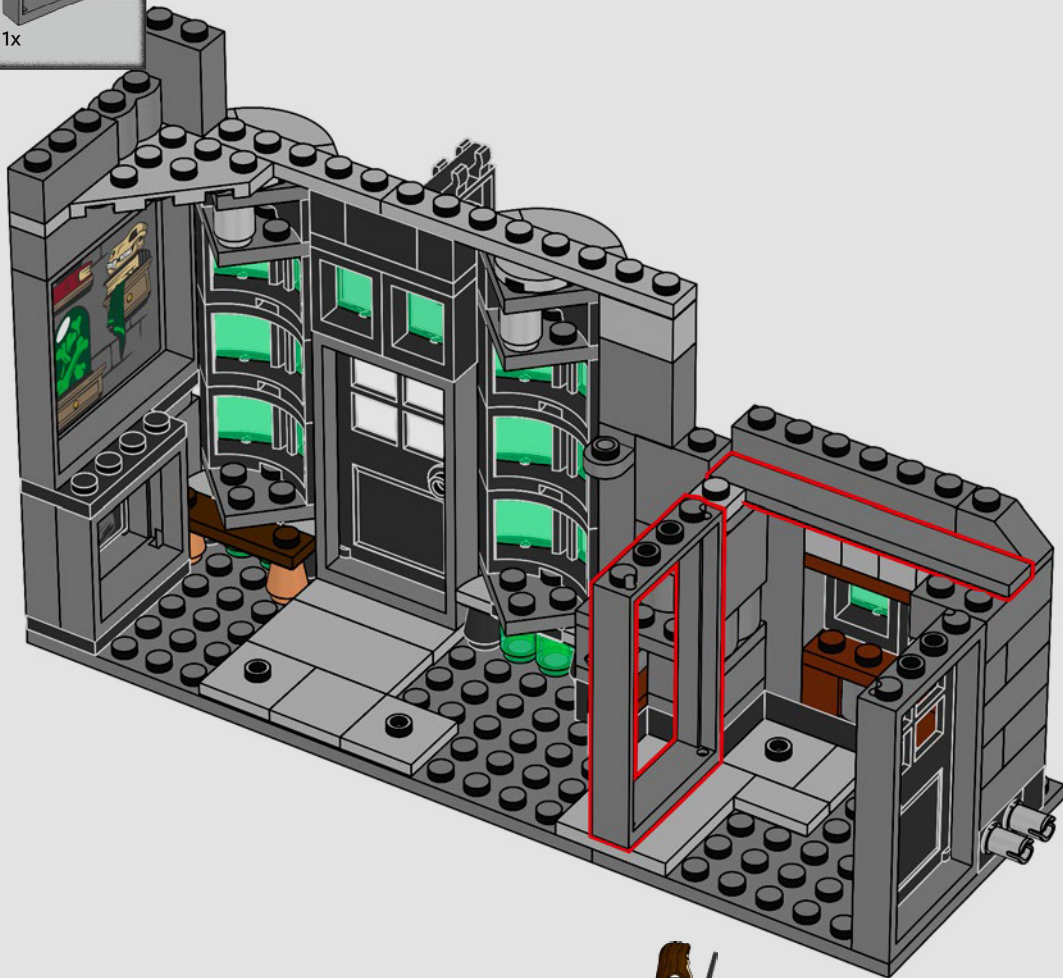

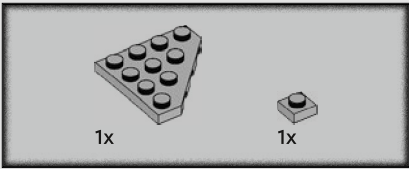

48

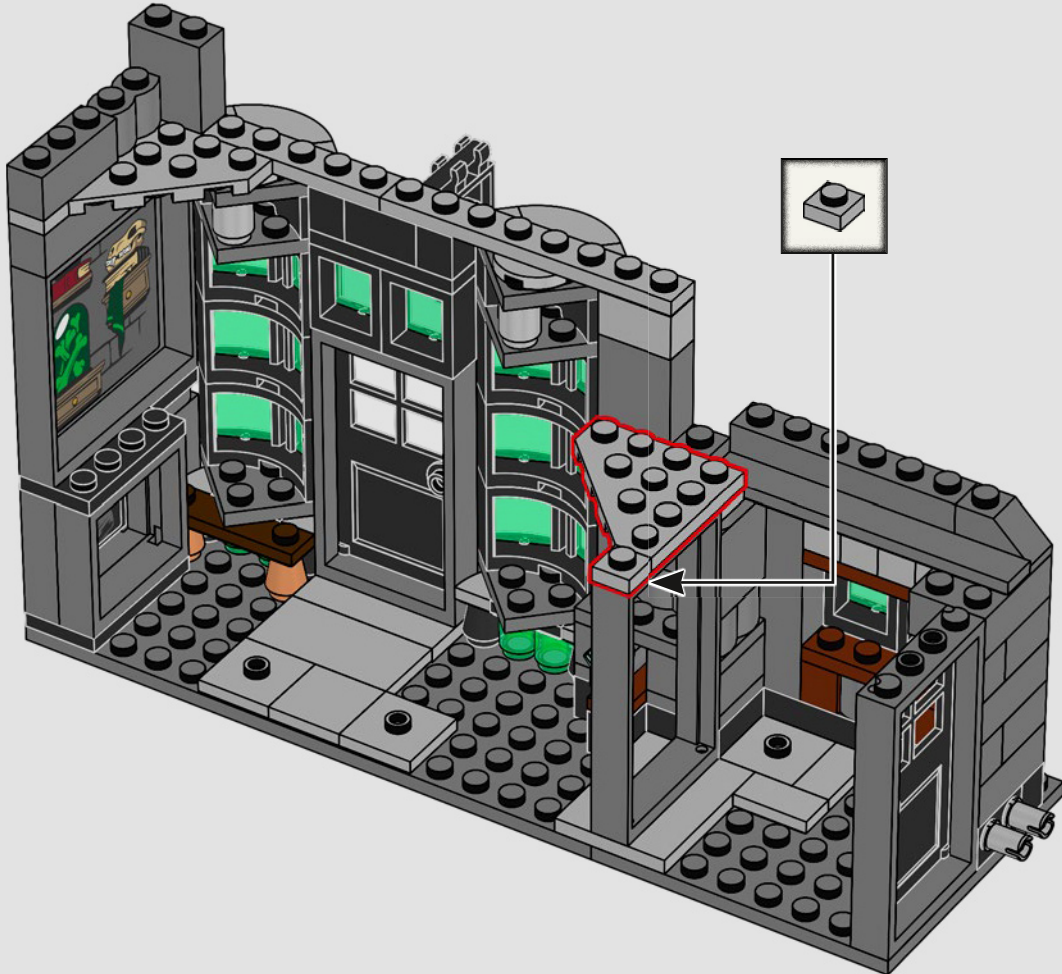

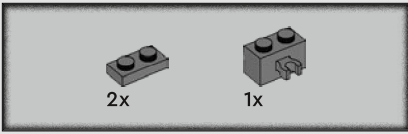

49

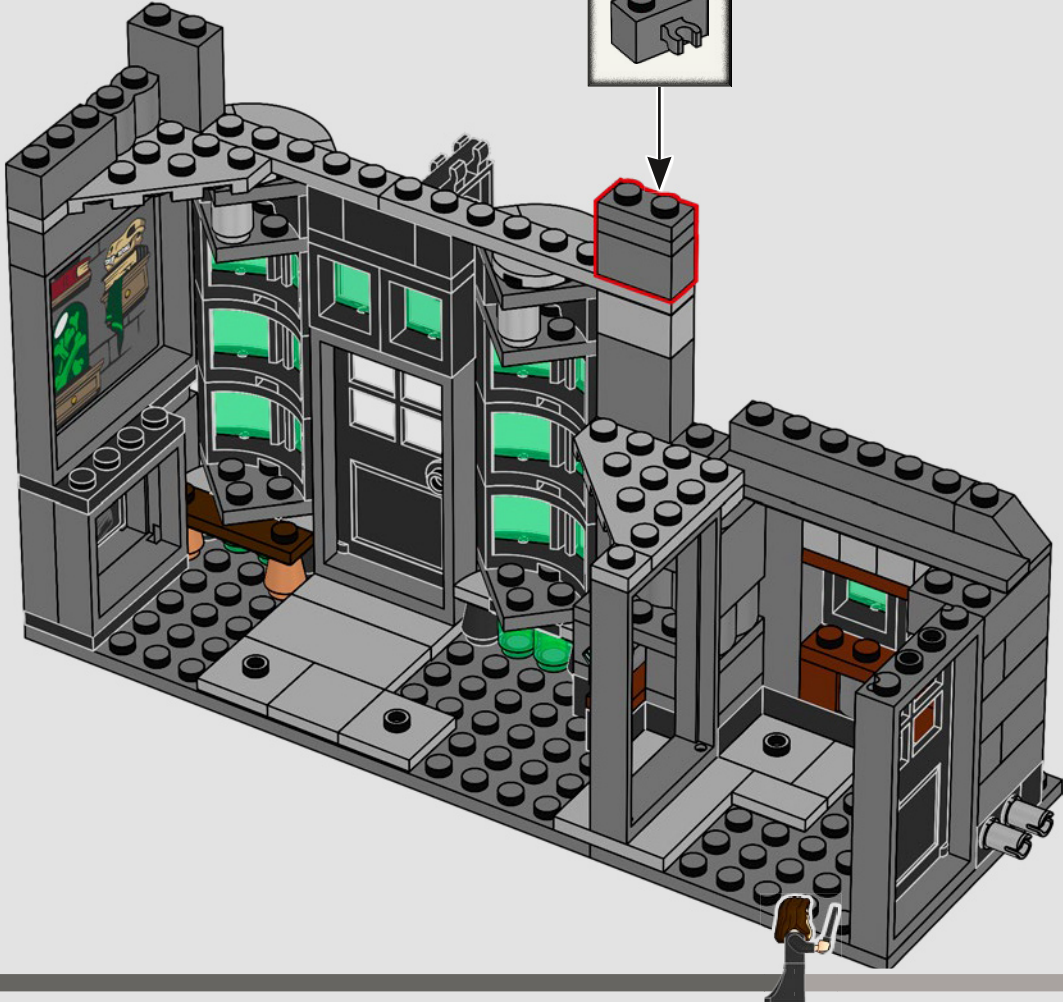
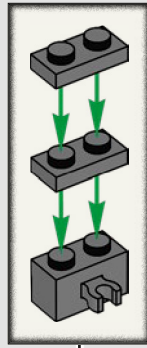

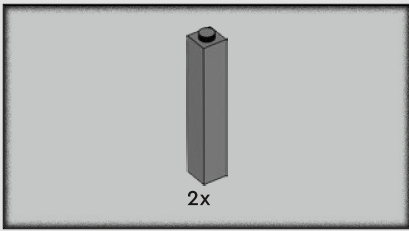

50

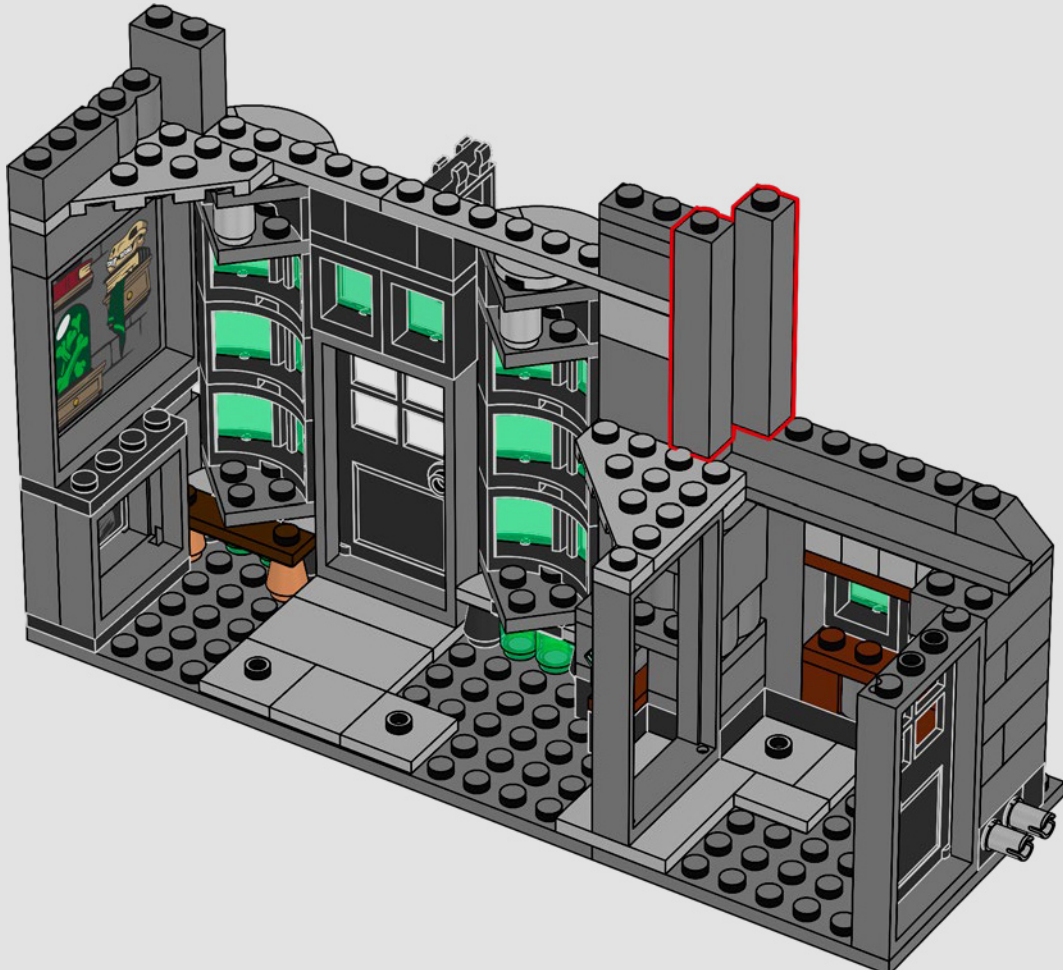

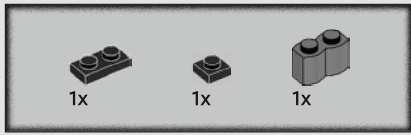

51

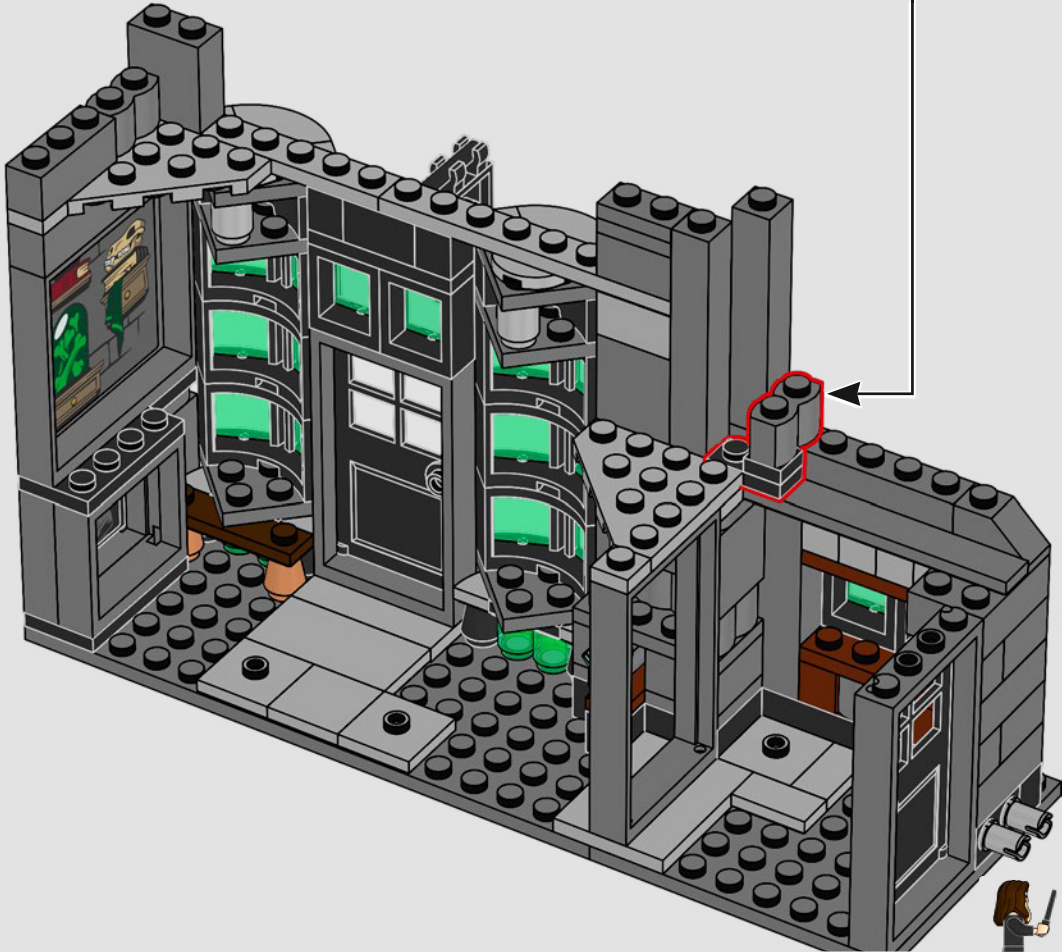
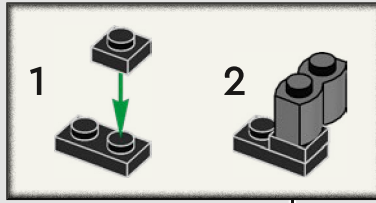

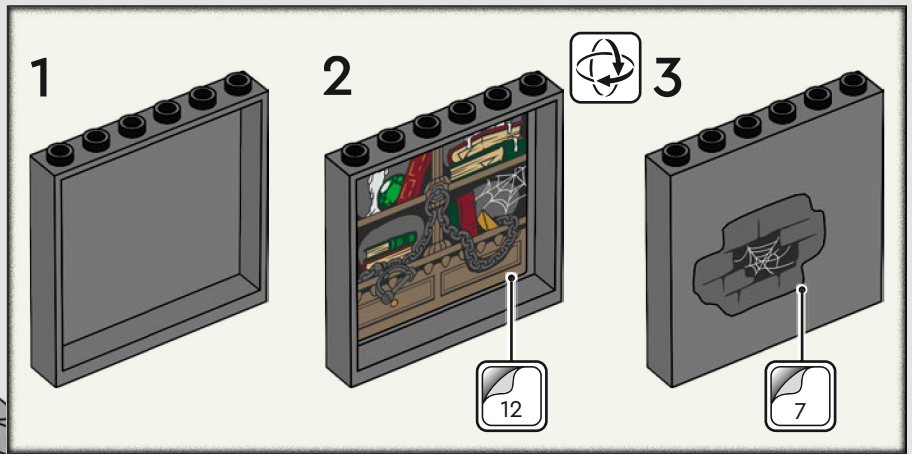
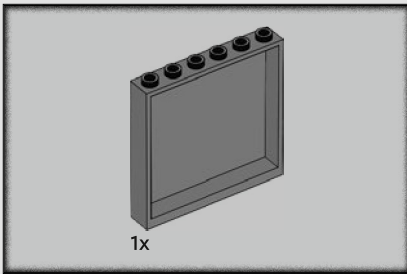

52

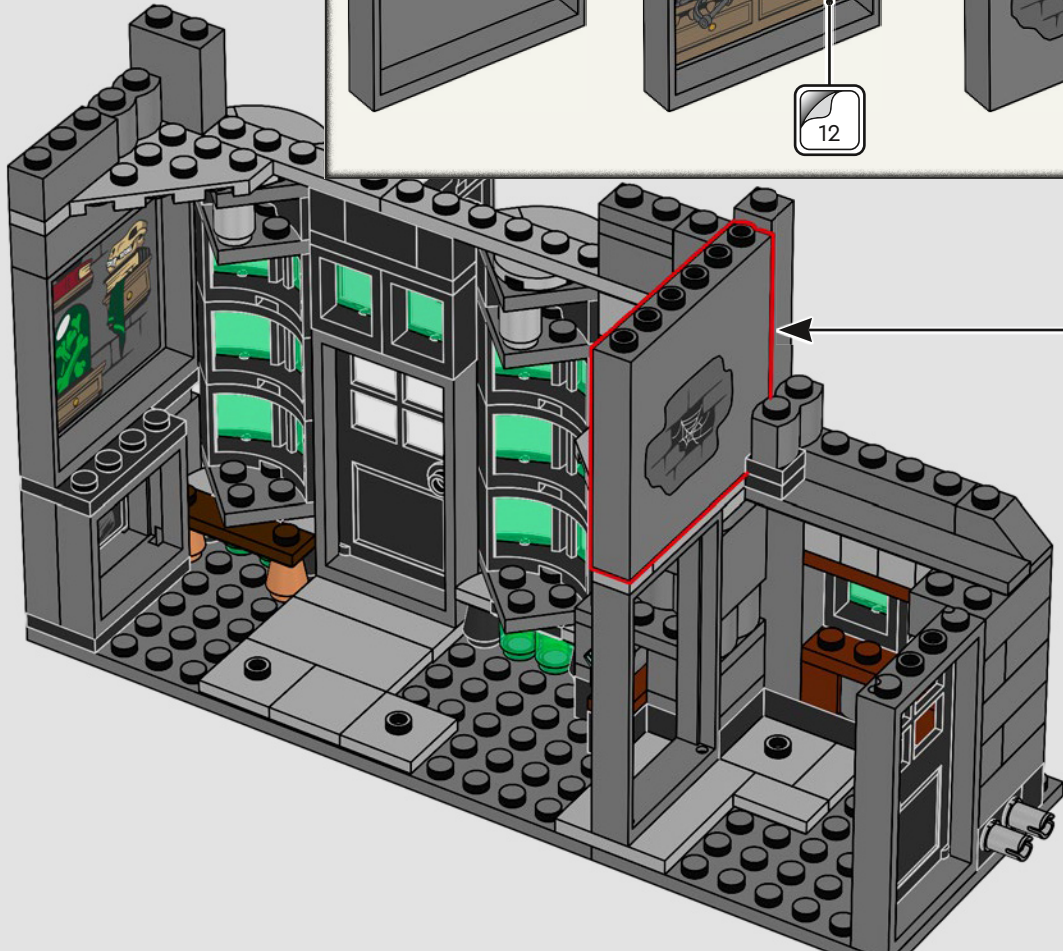

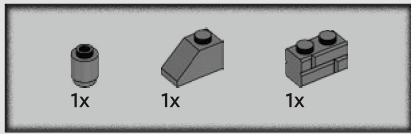

53

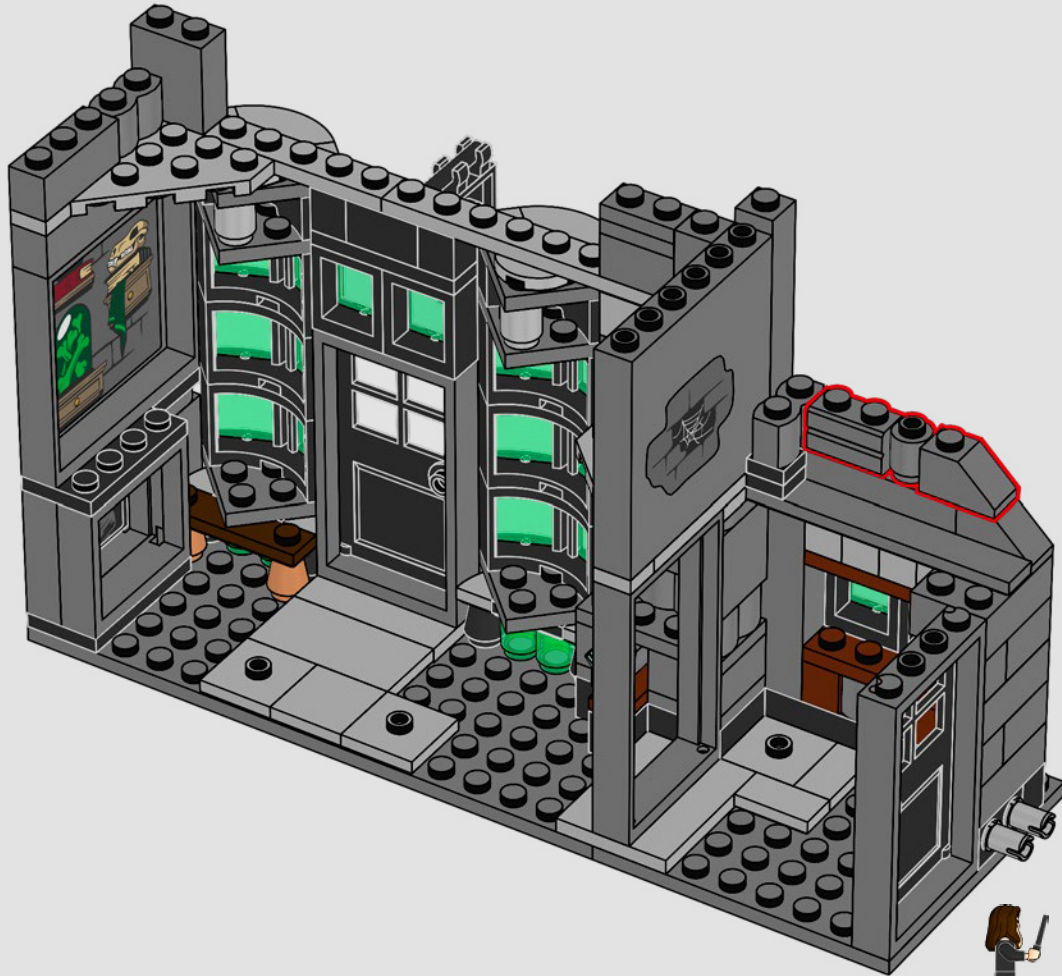

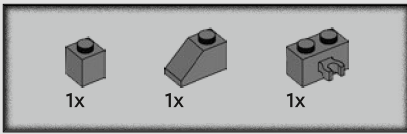

54

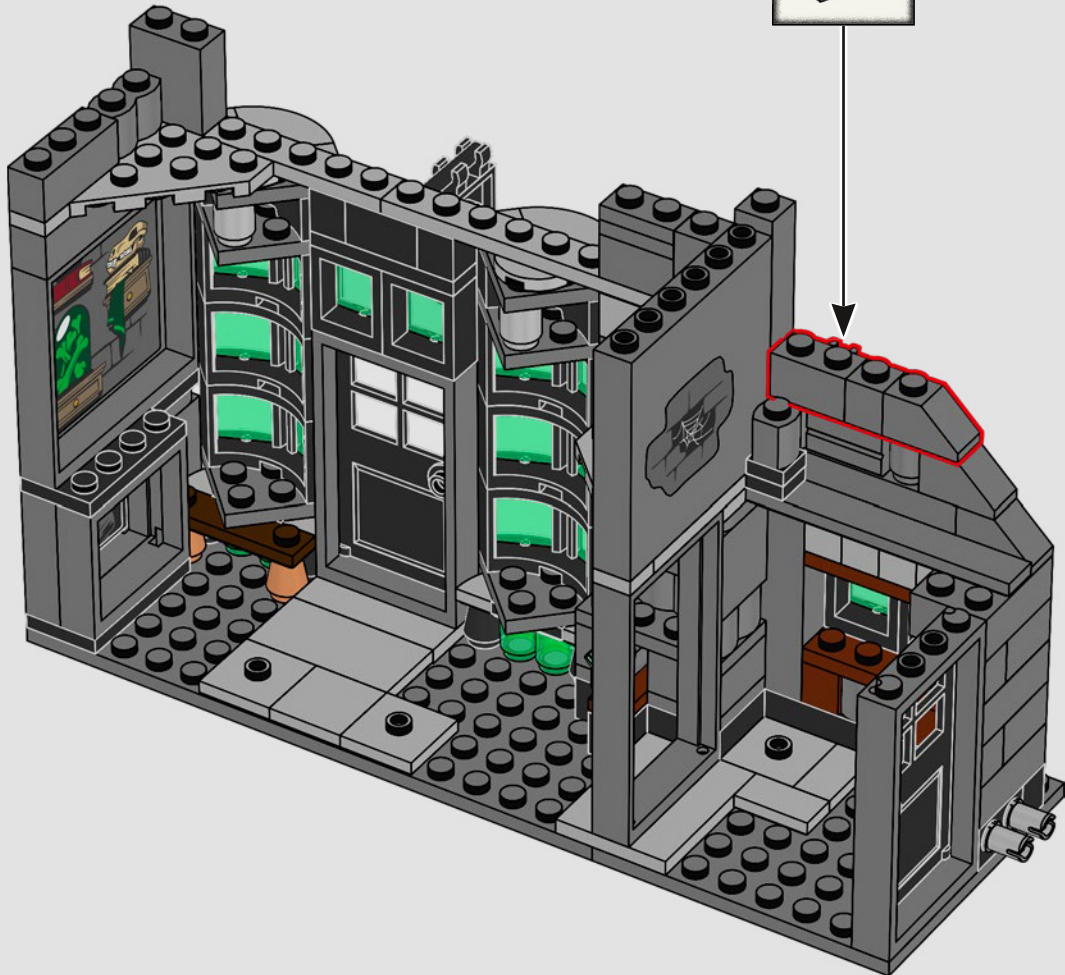
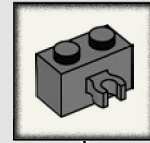

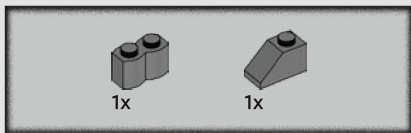

55

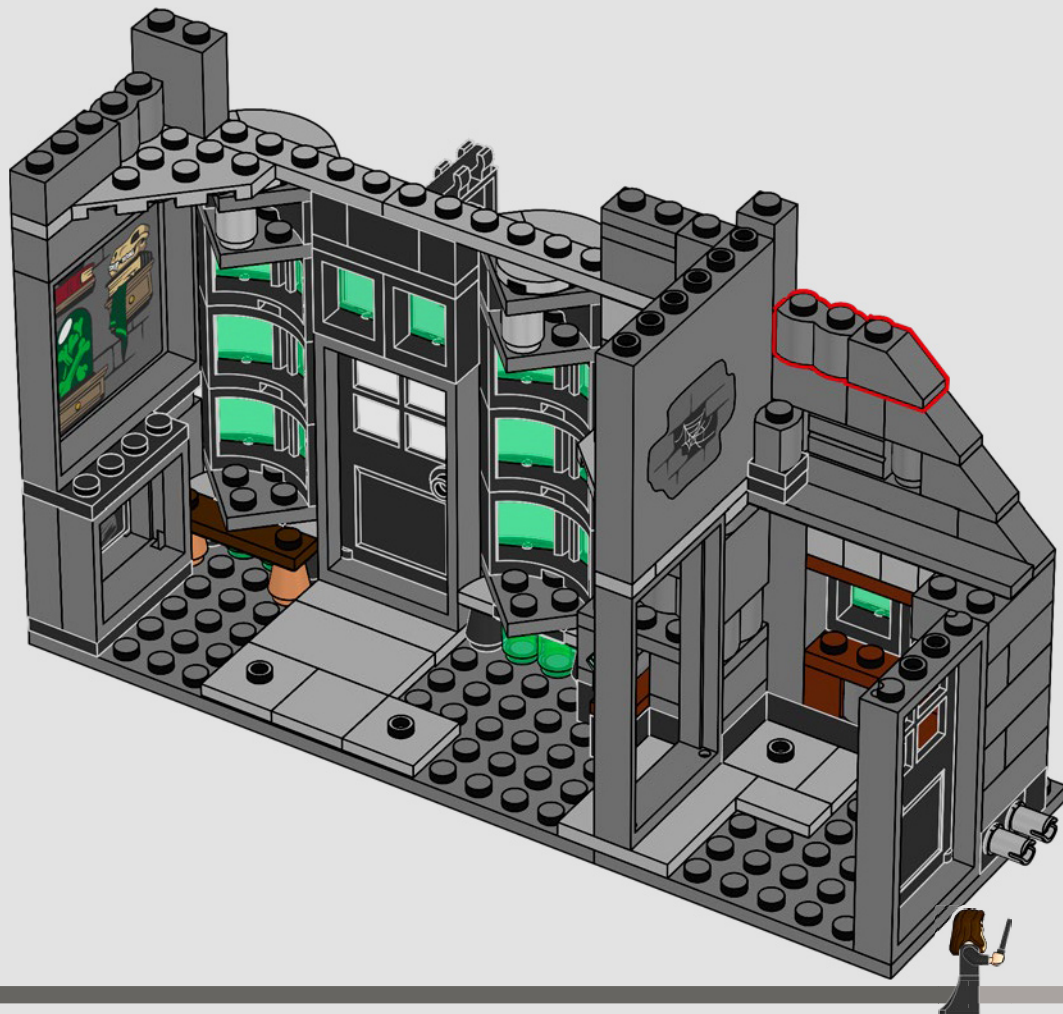

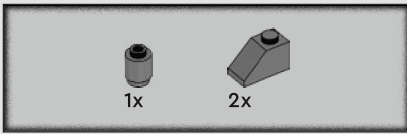

56

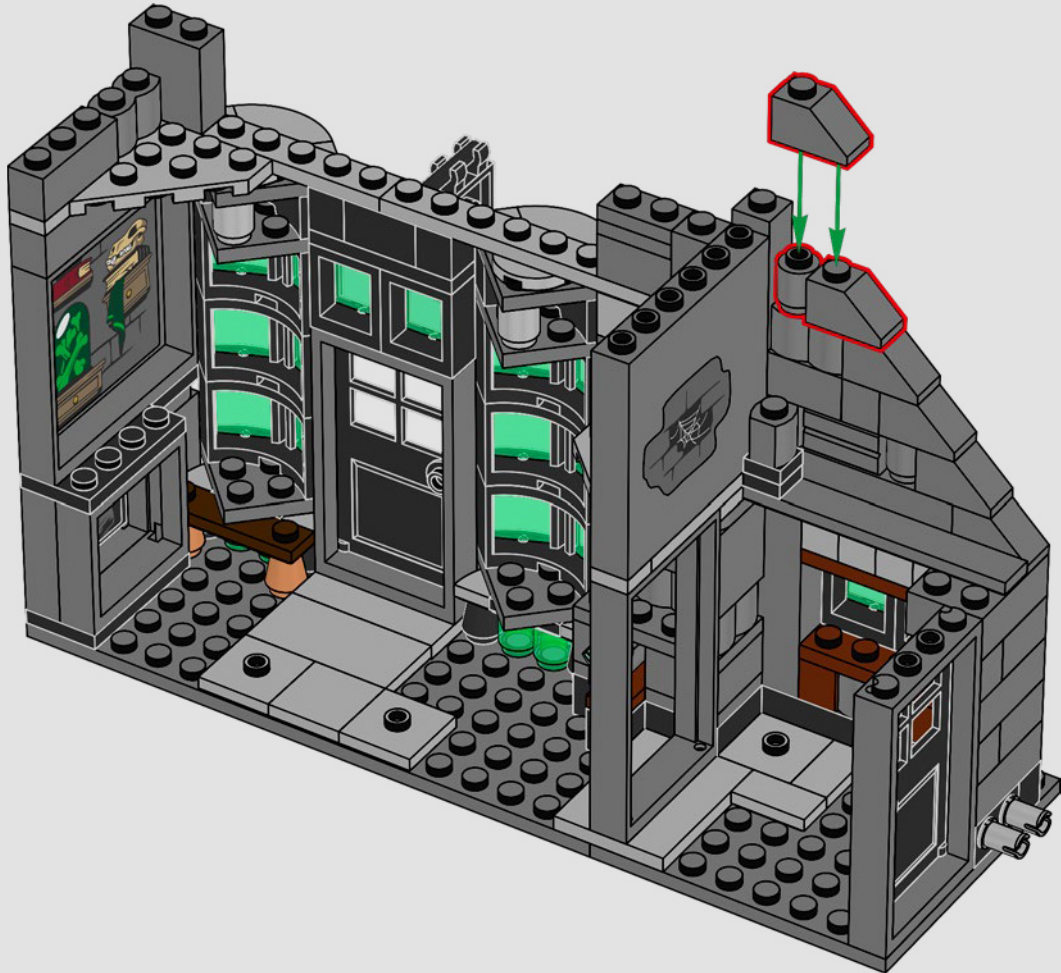

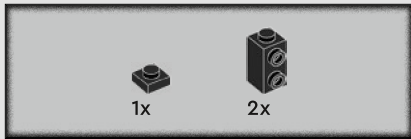

57

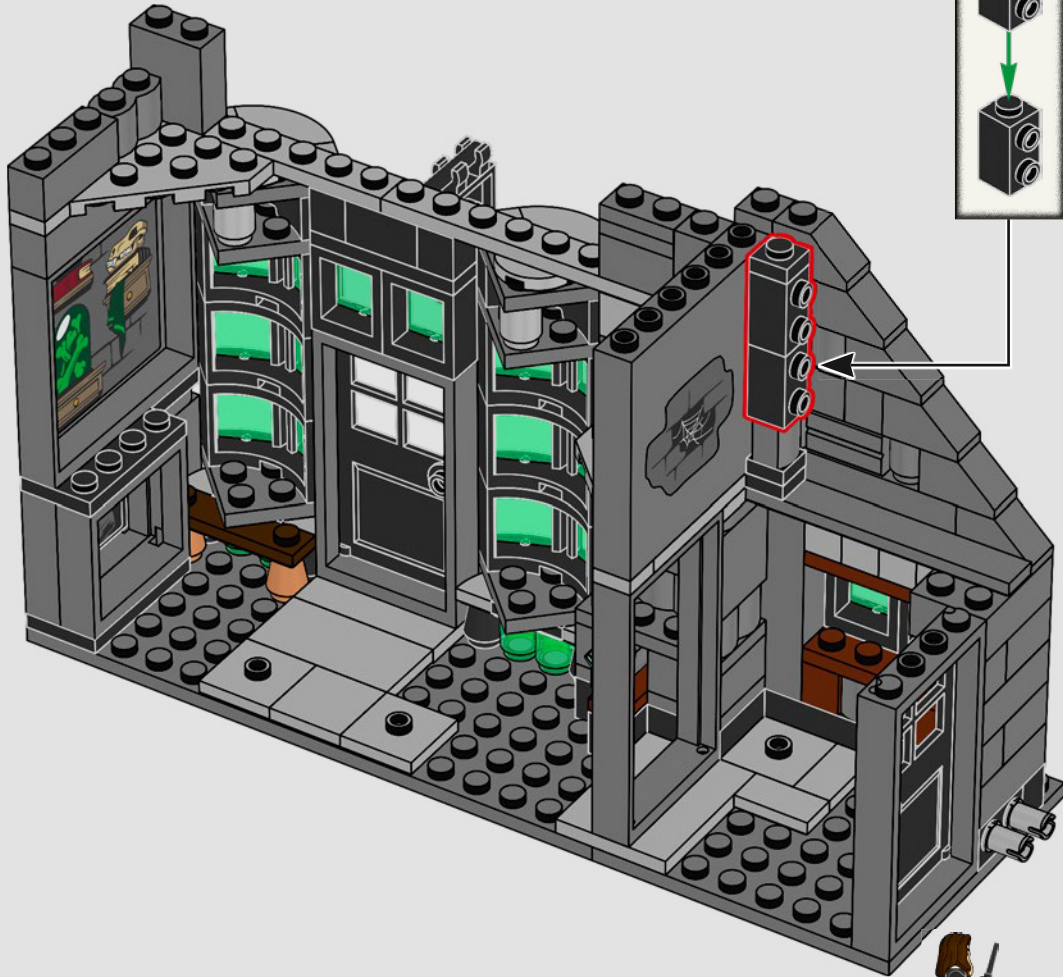

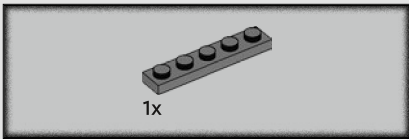

58

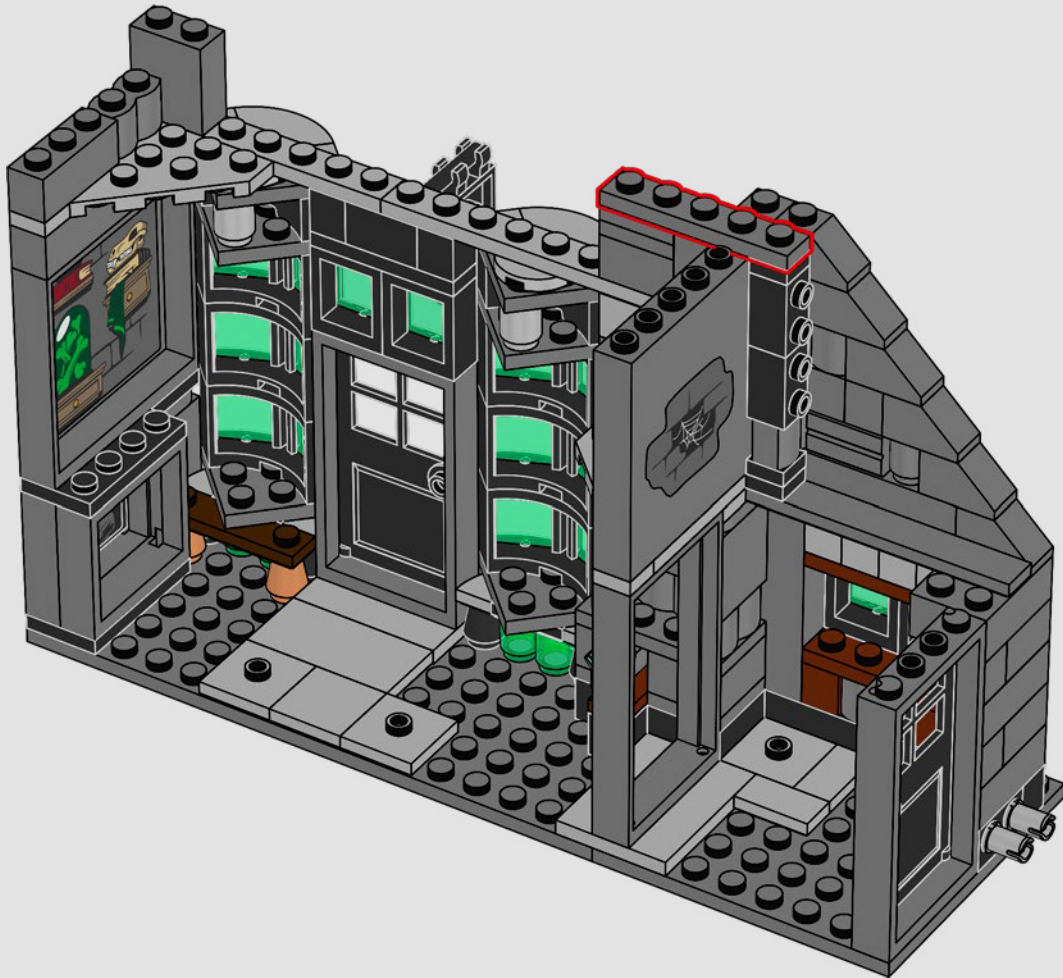

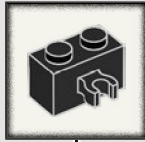
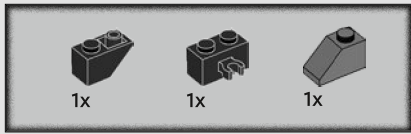

59

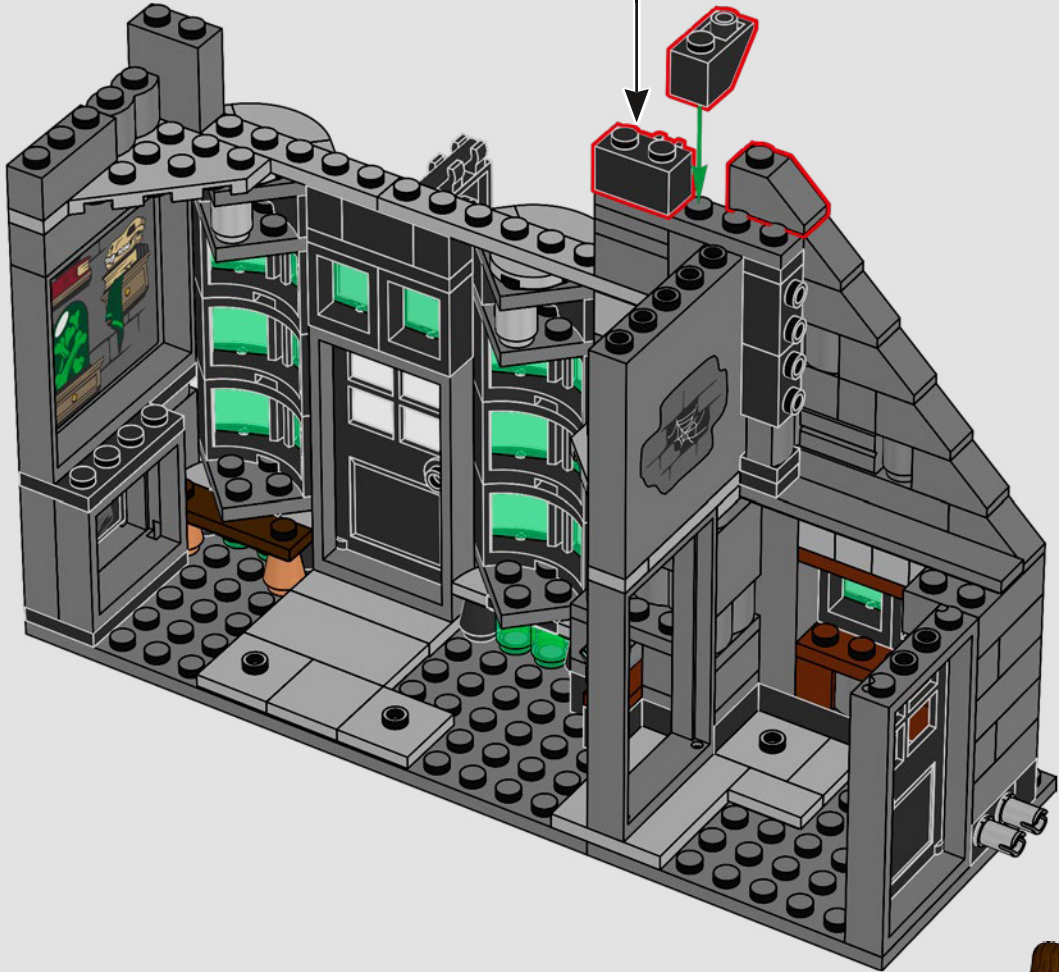

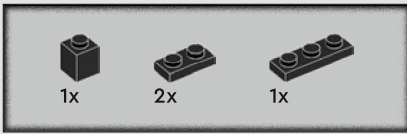

60

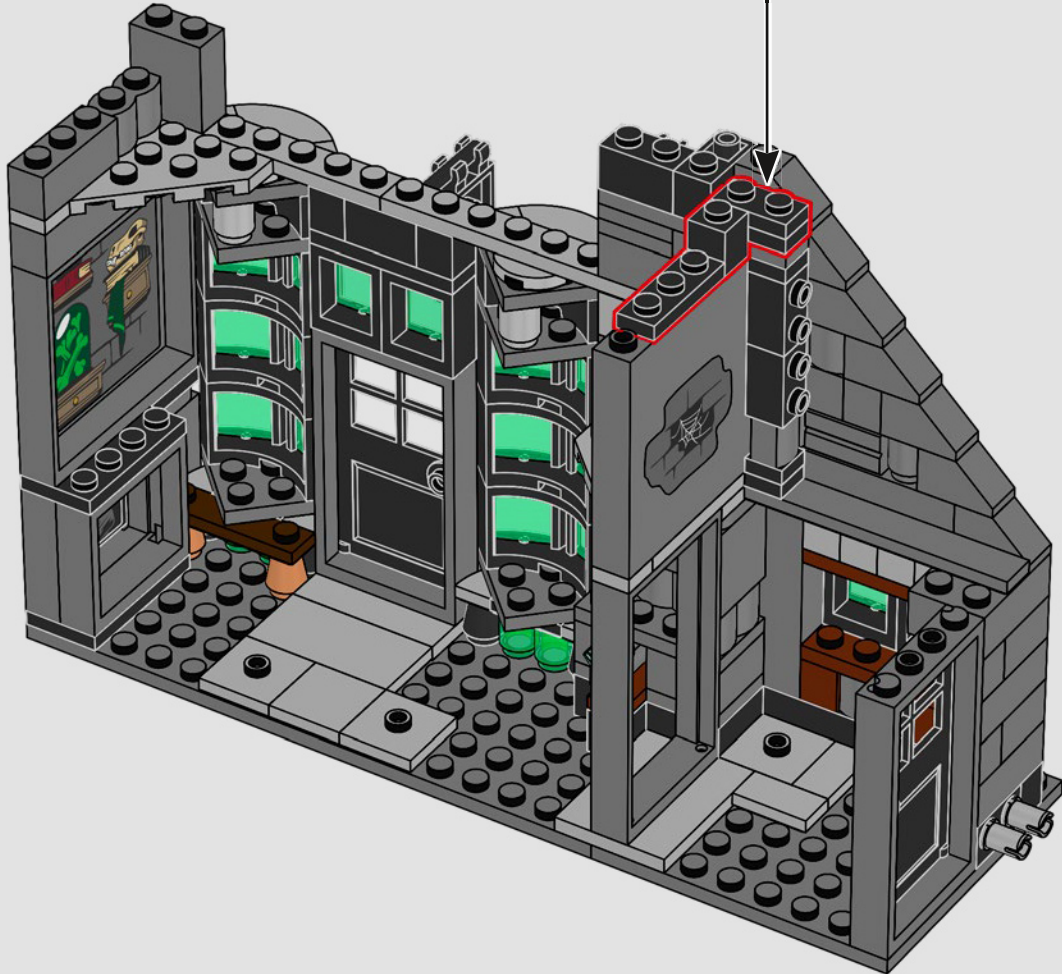
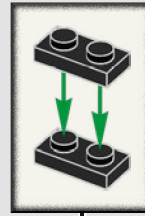

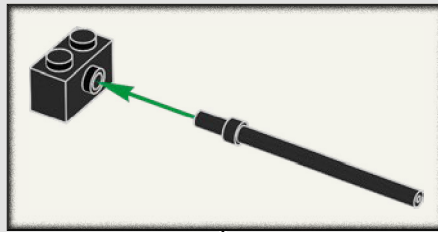

61

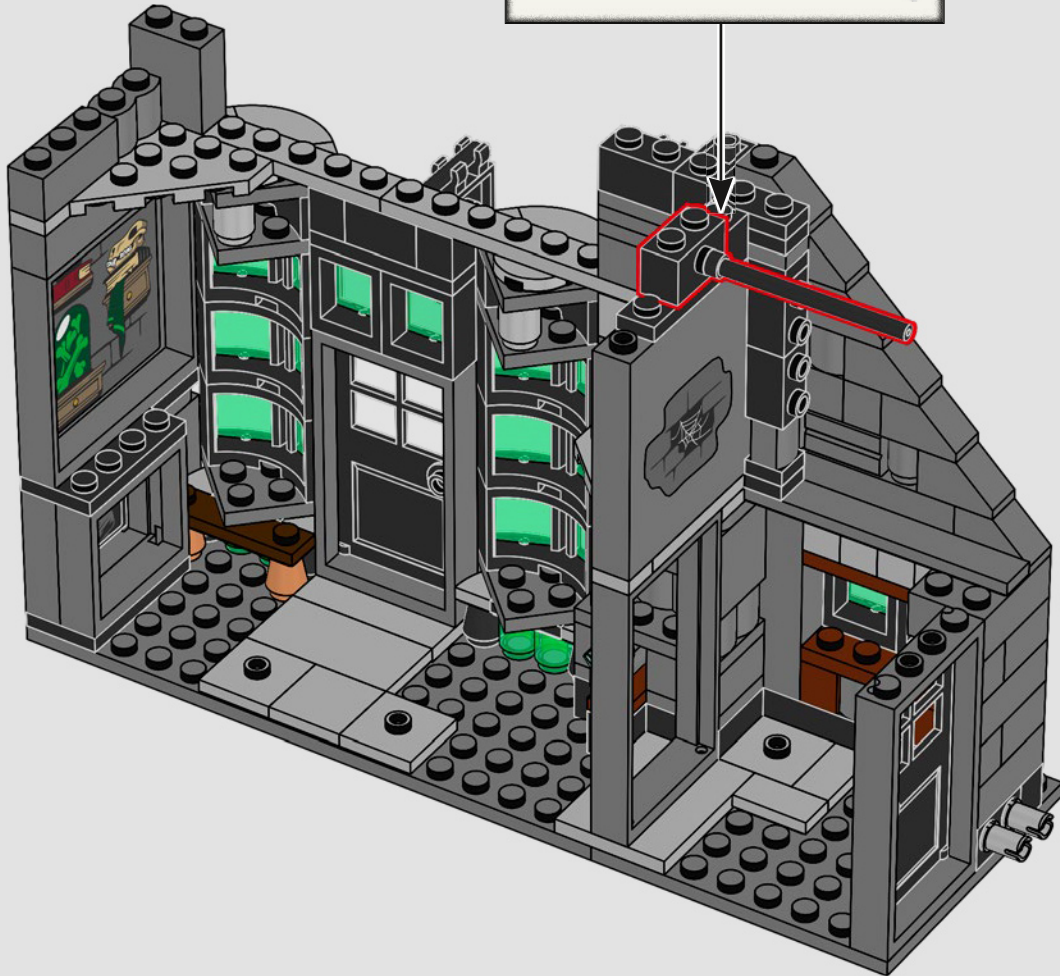

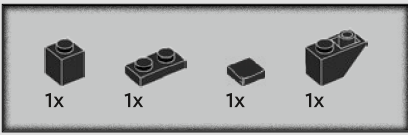

62

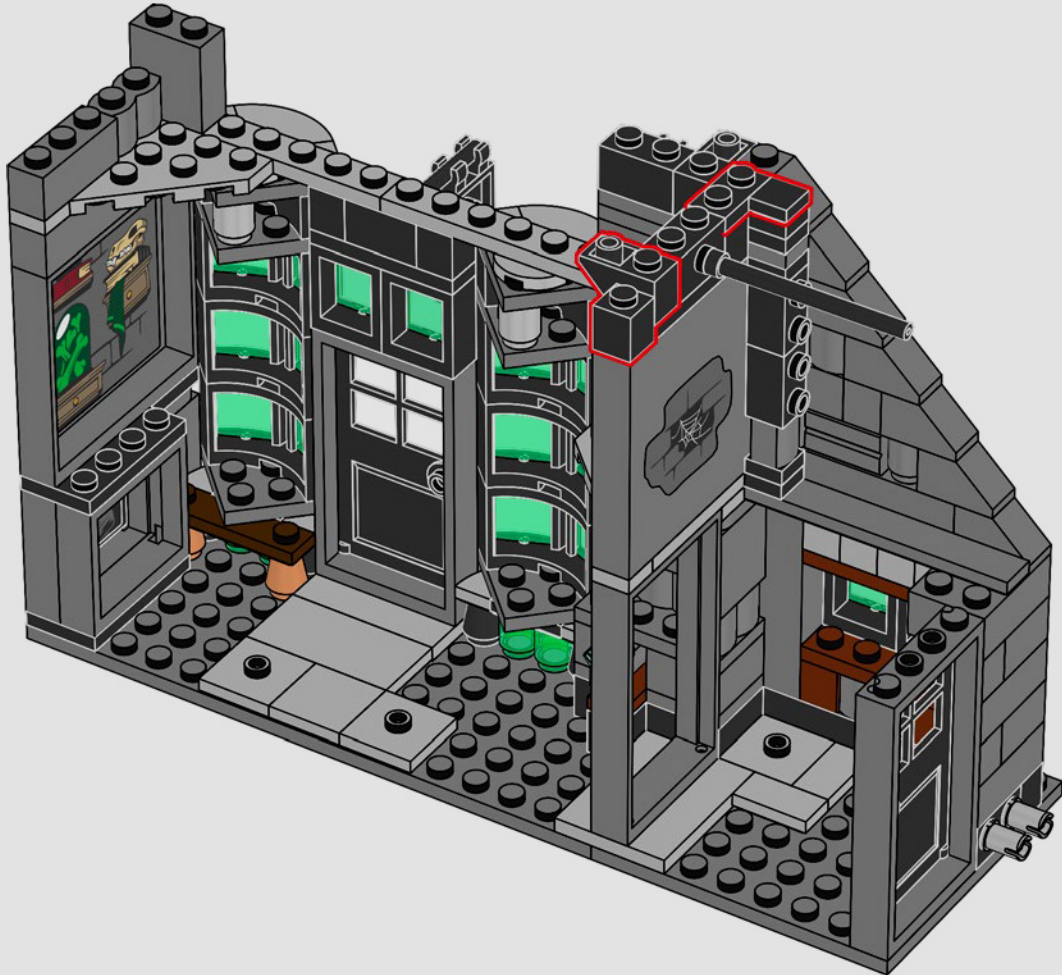



63

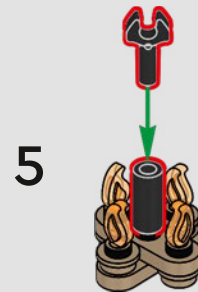
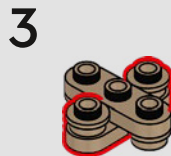
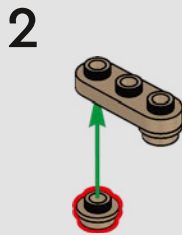
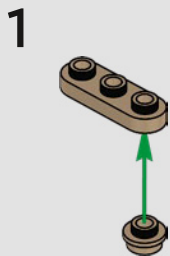
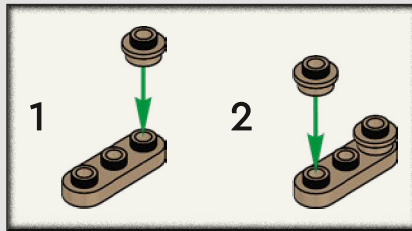

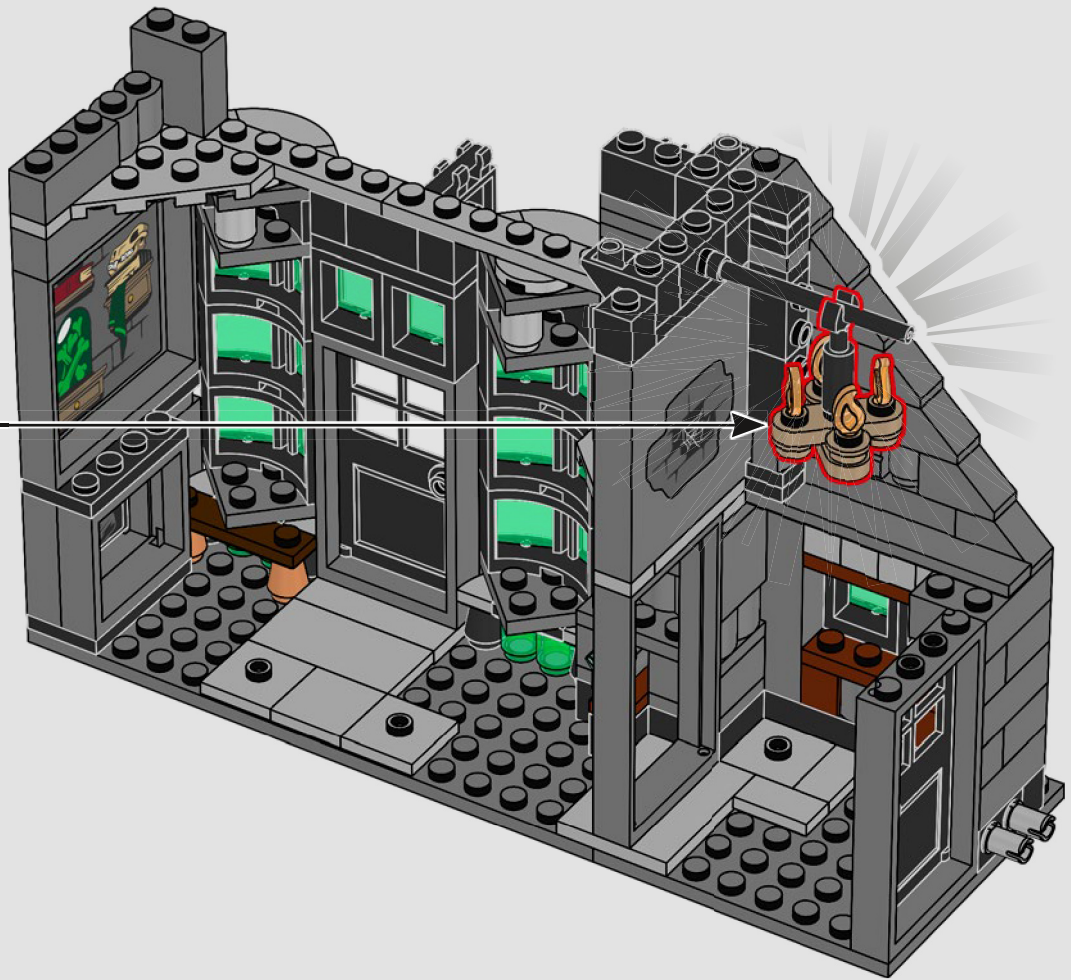

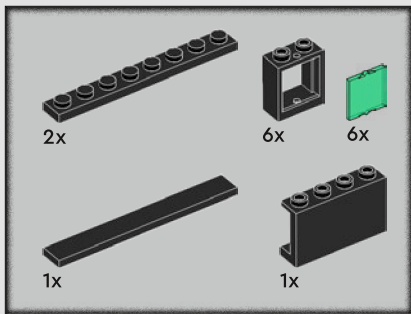

64

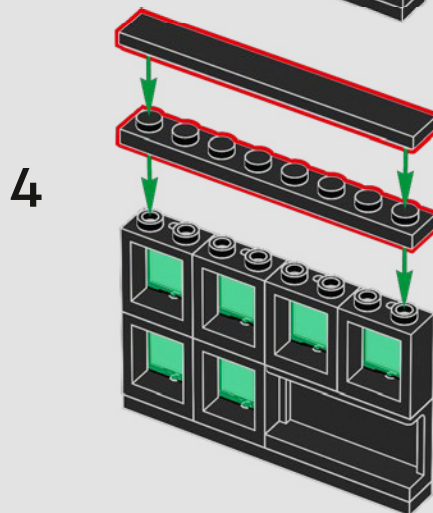
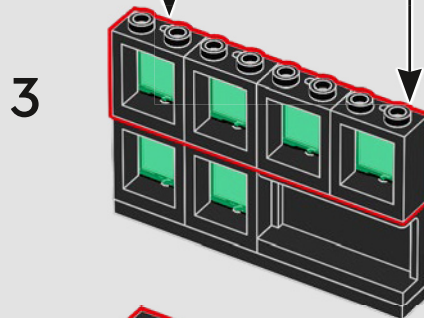
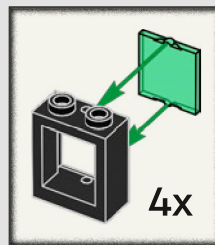
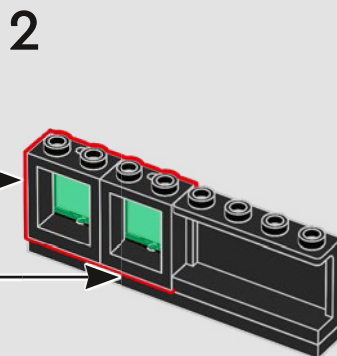
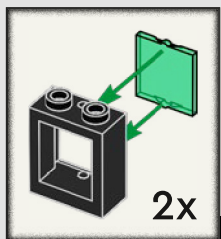
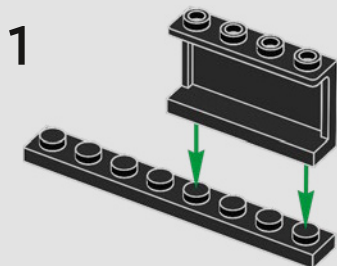

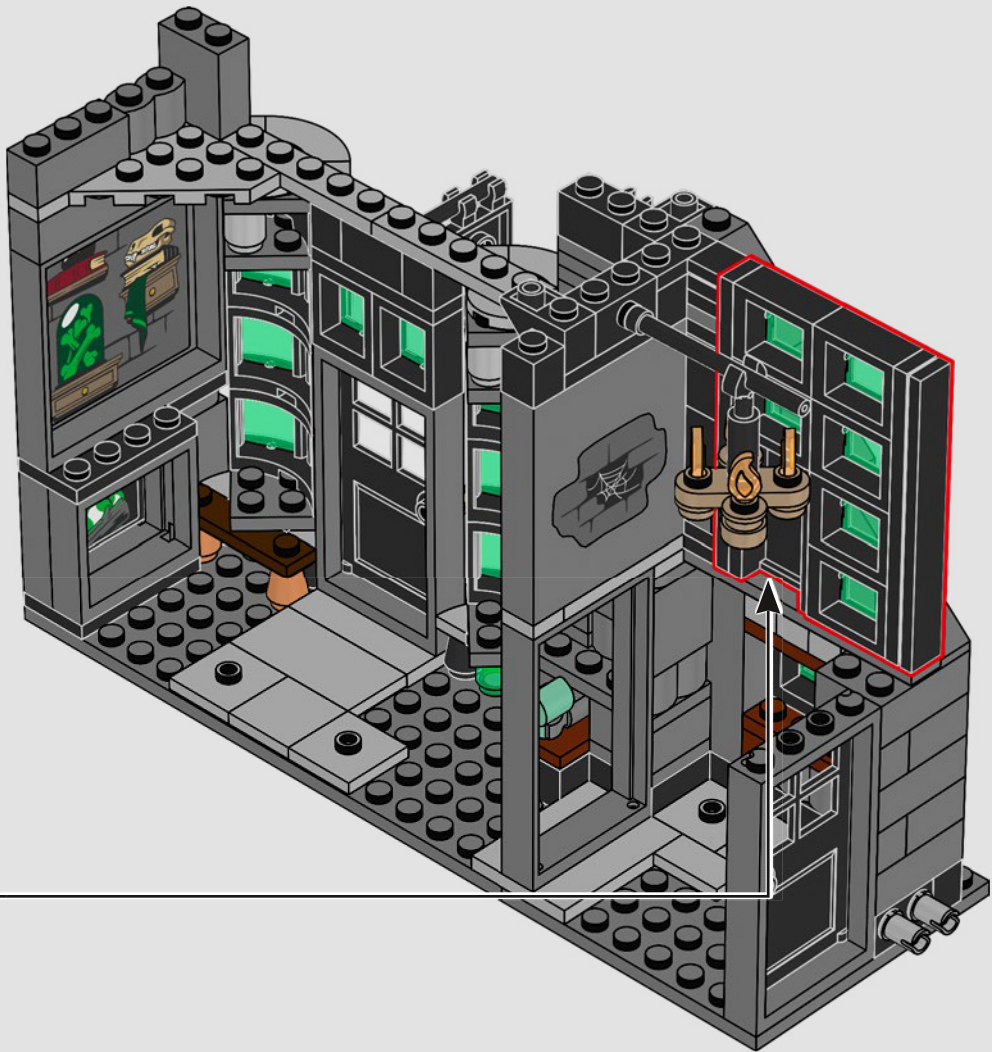

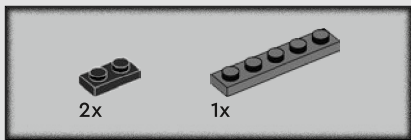

65

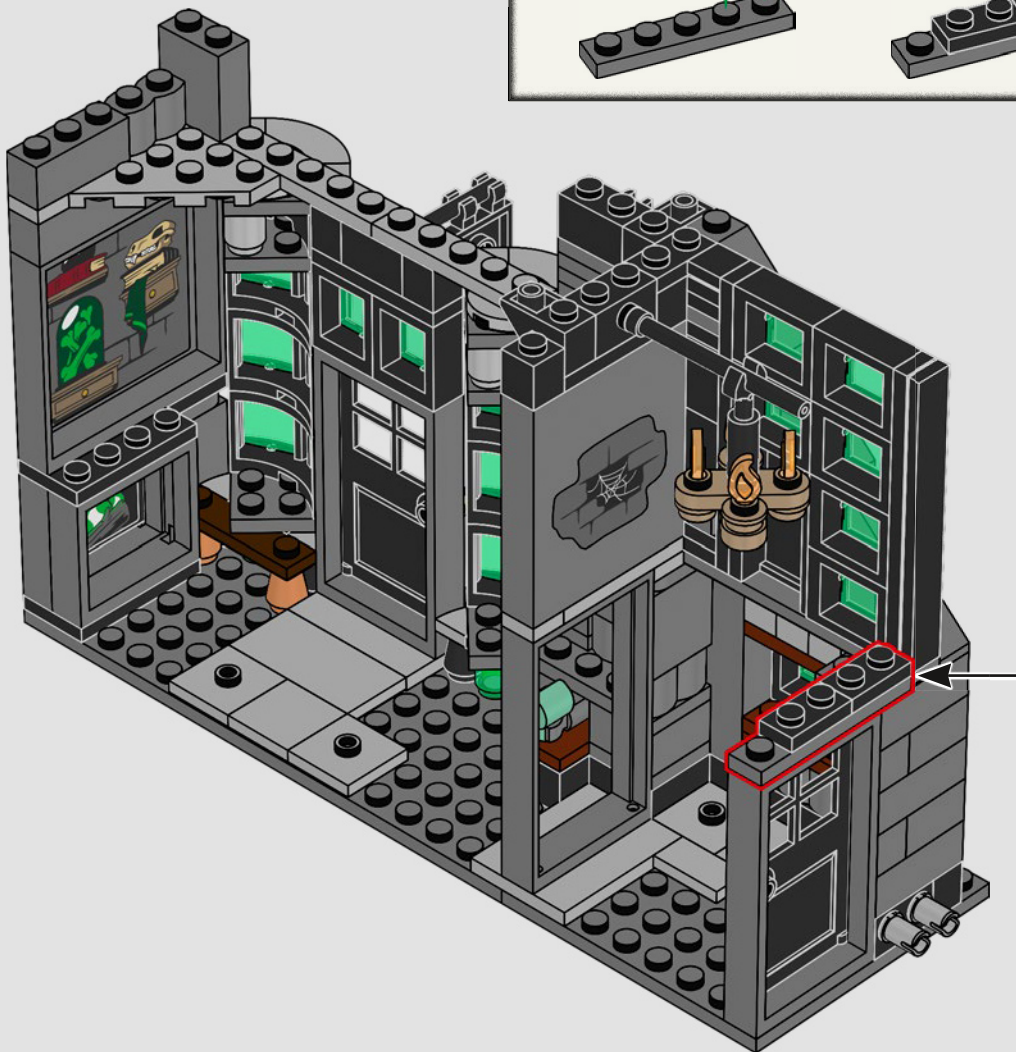
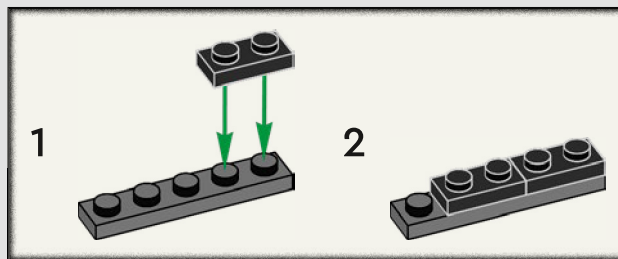

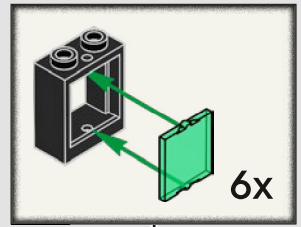
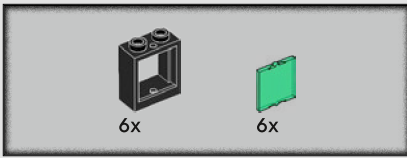

66

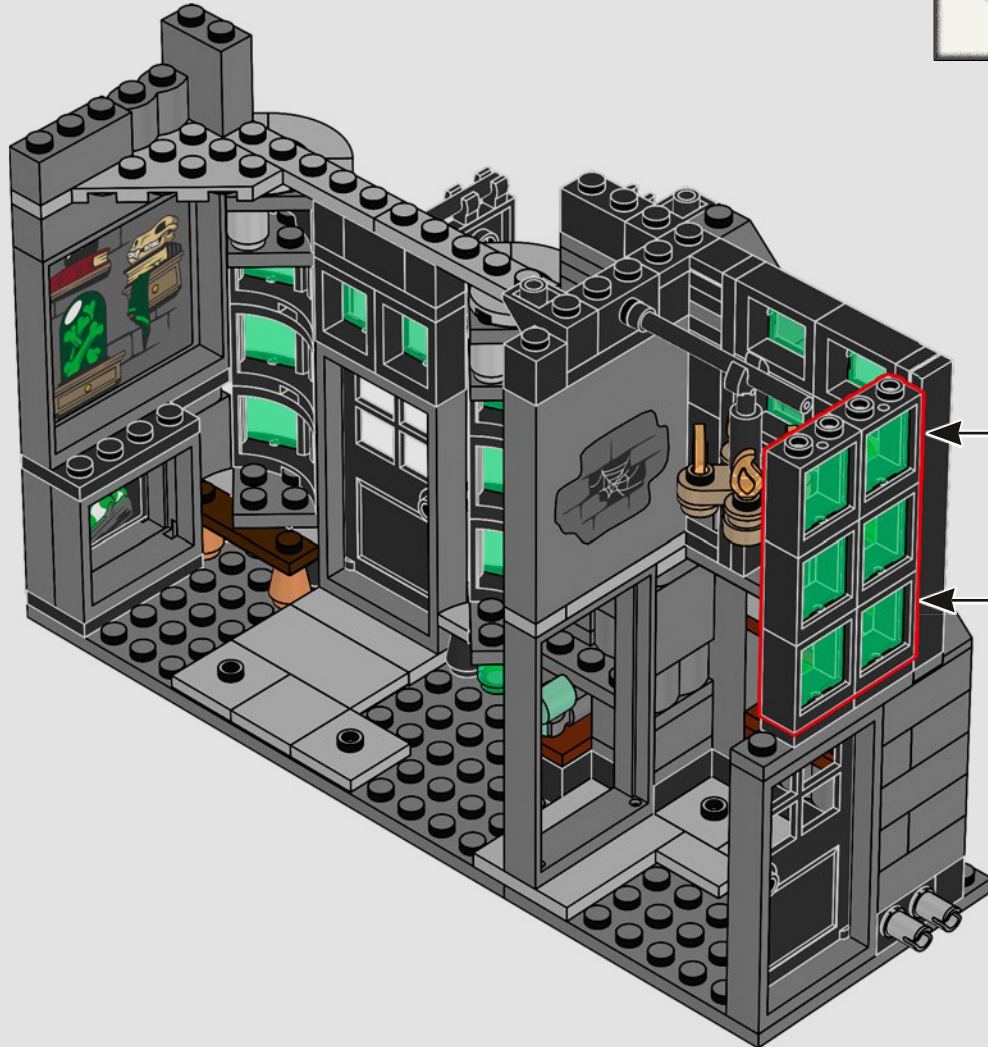

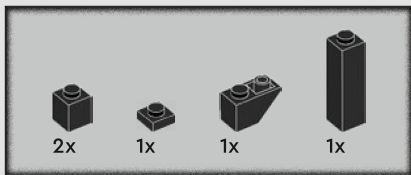

67

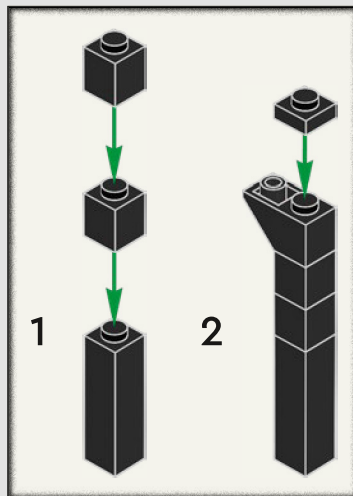
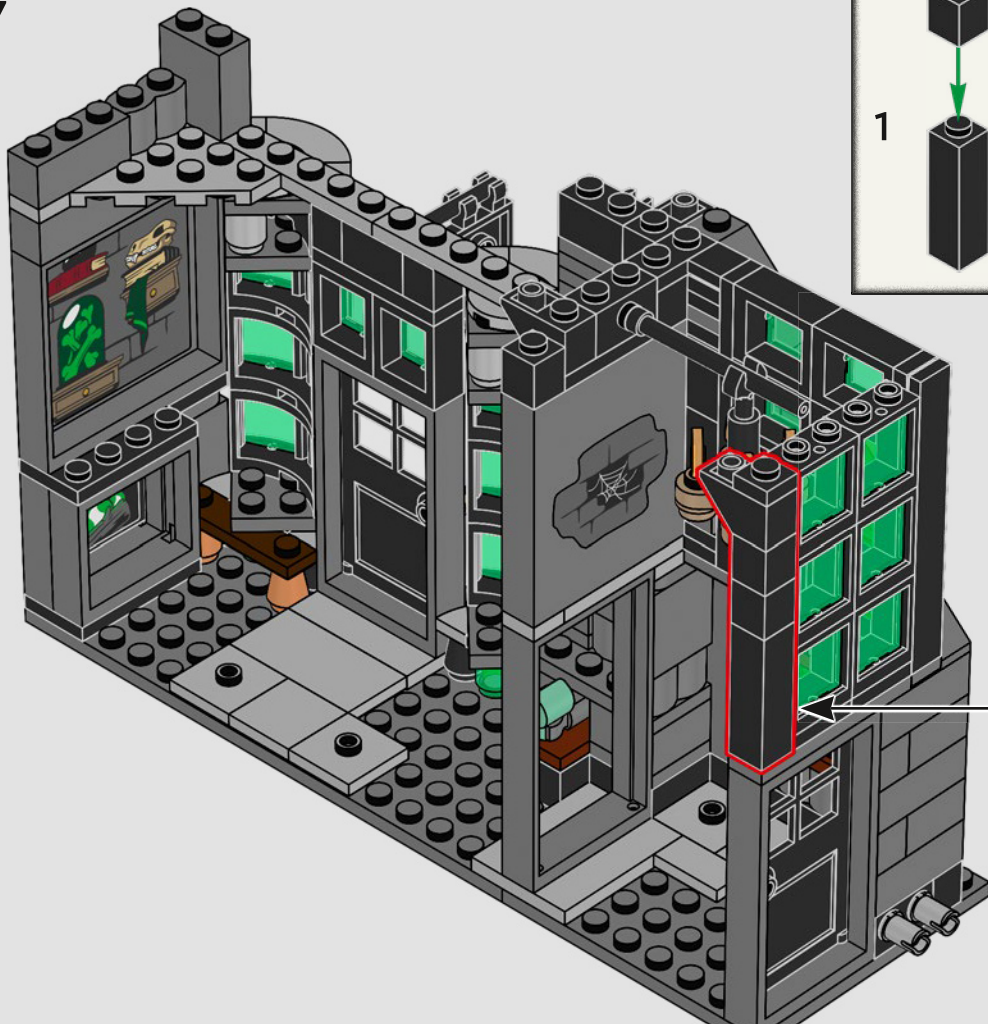

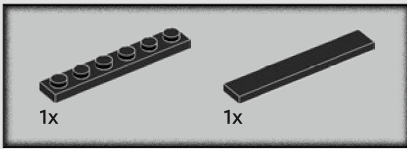

68

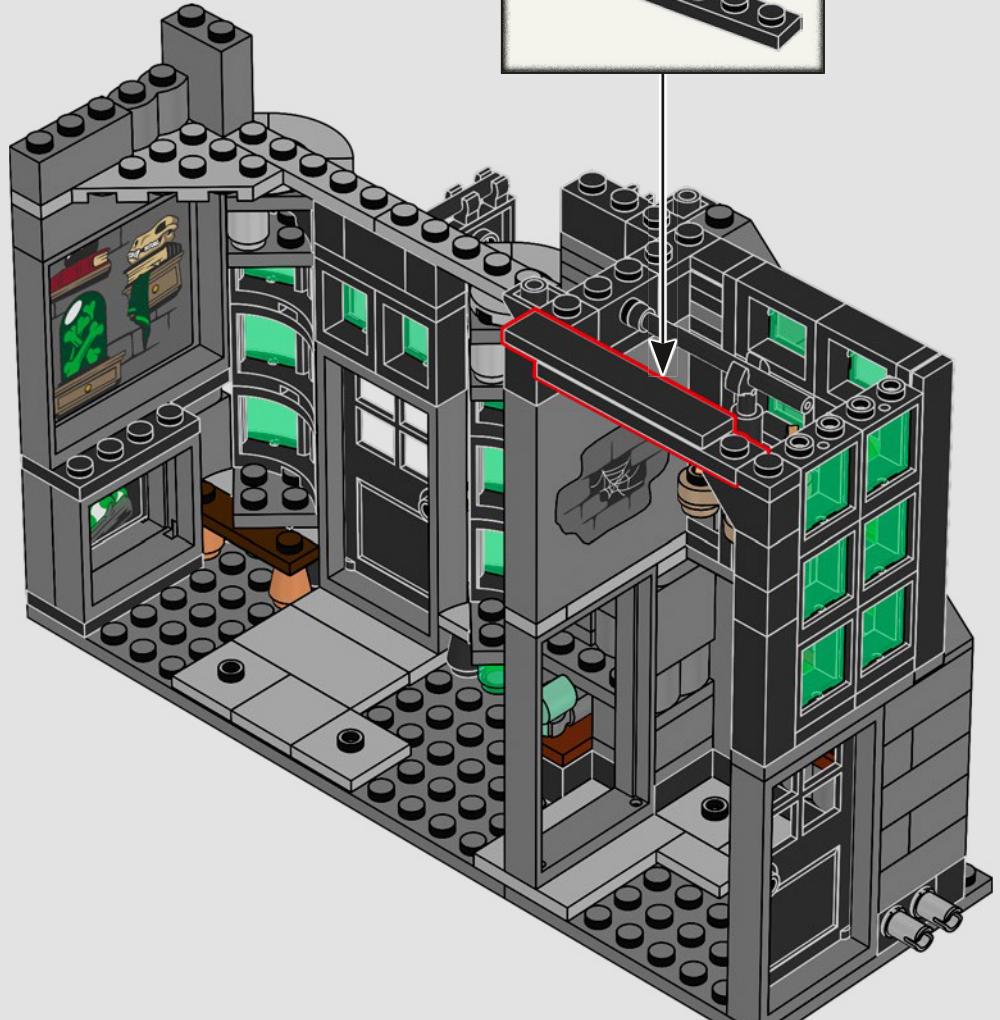
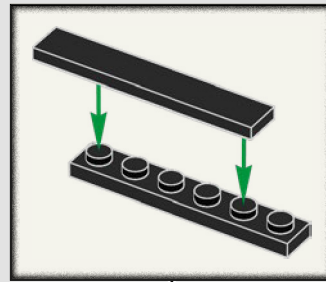

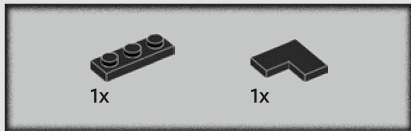

69

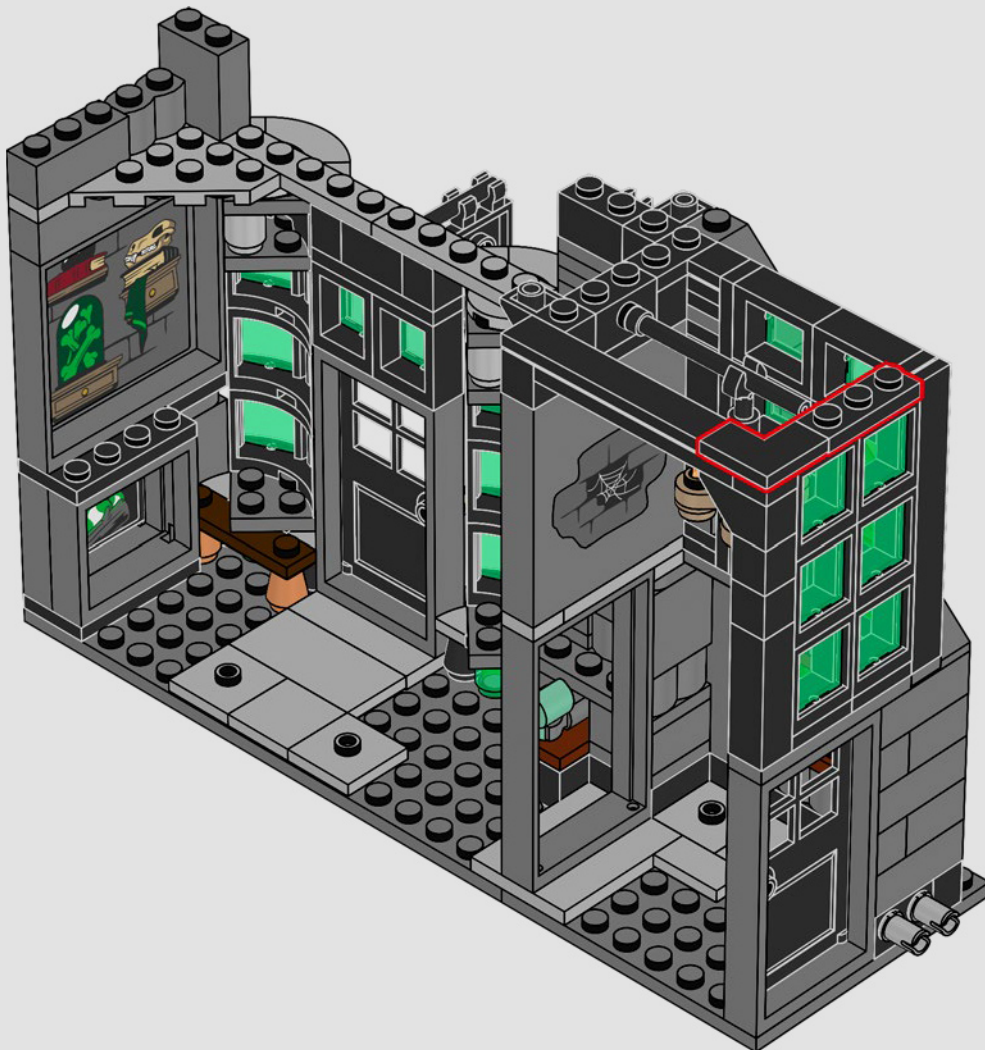

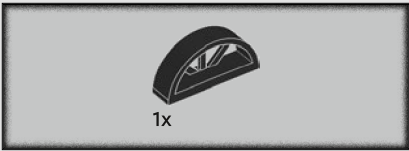

70

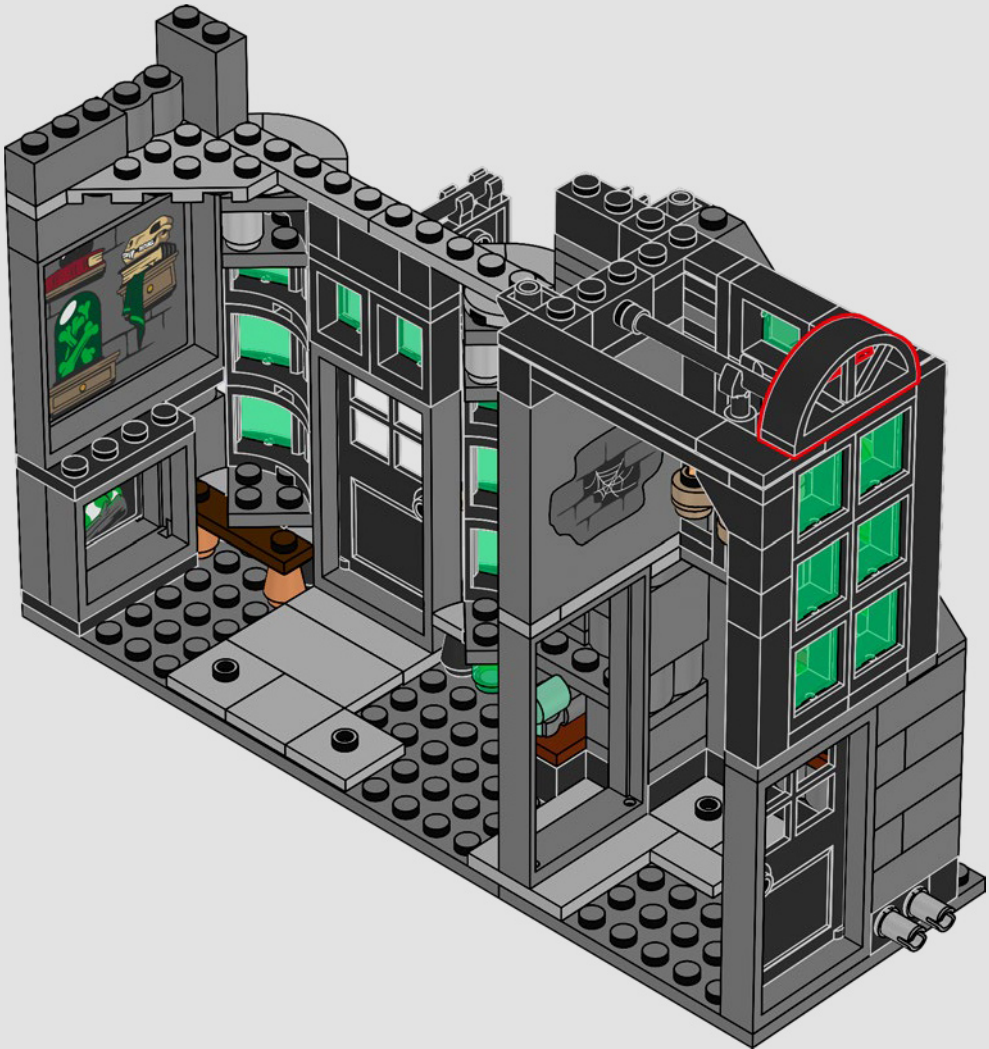

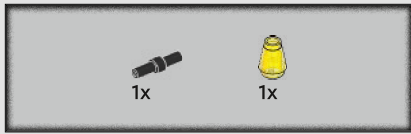

71

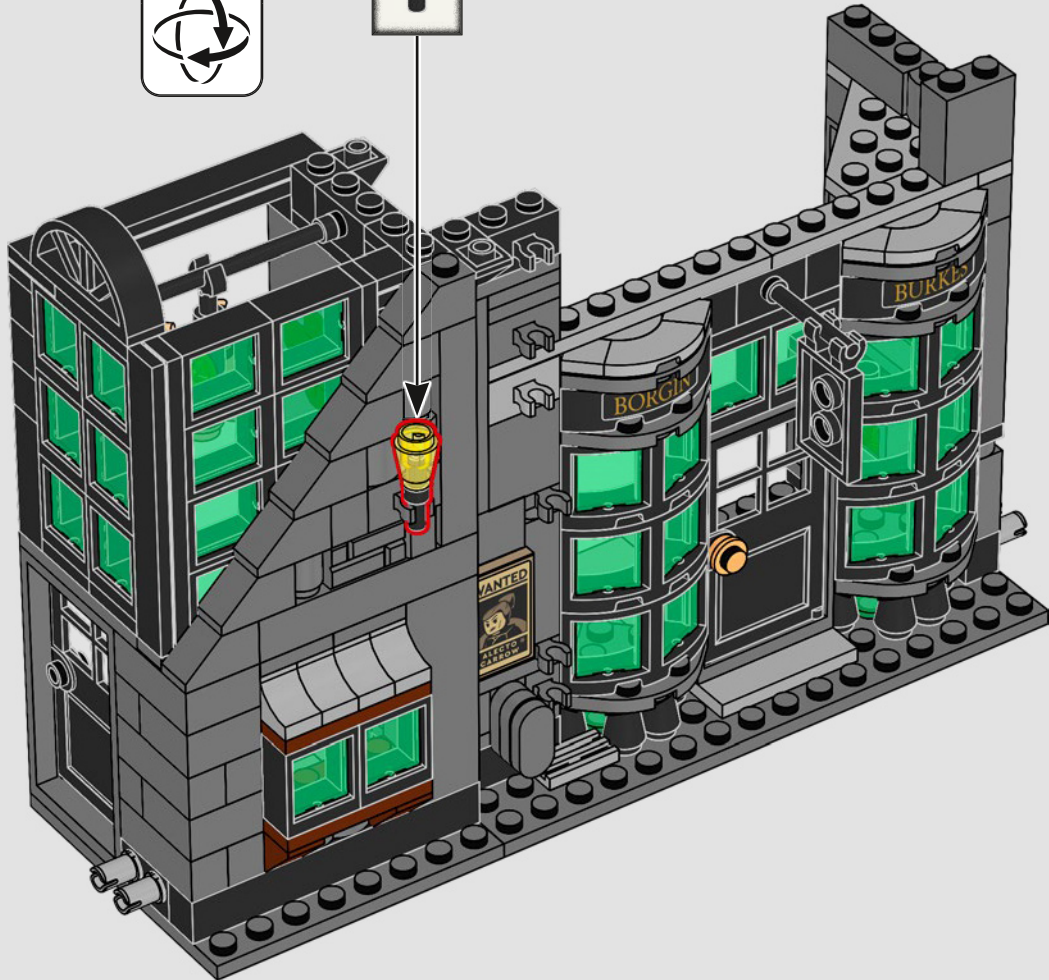
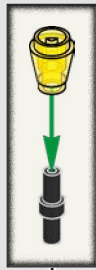

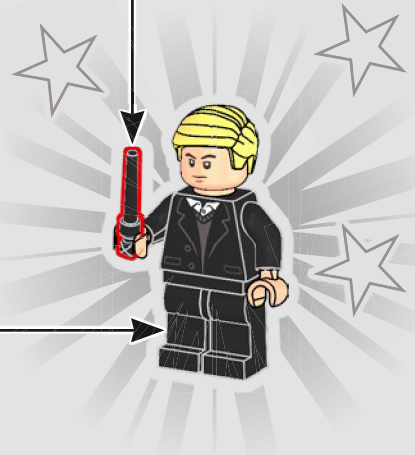
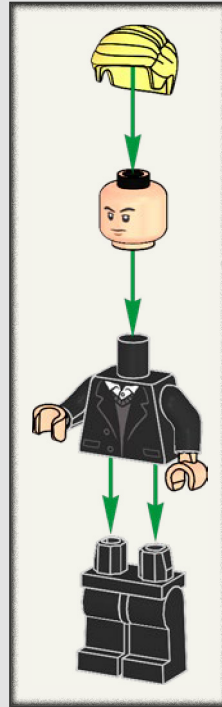

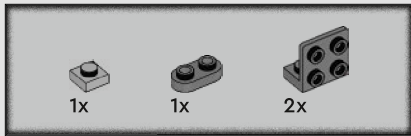

72

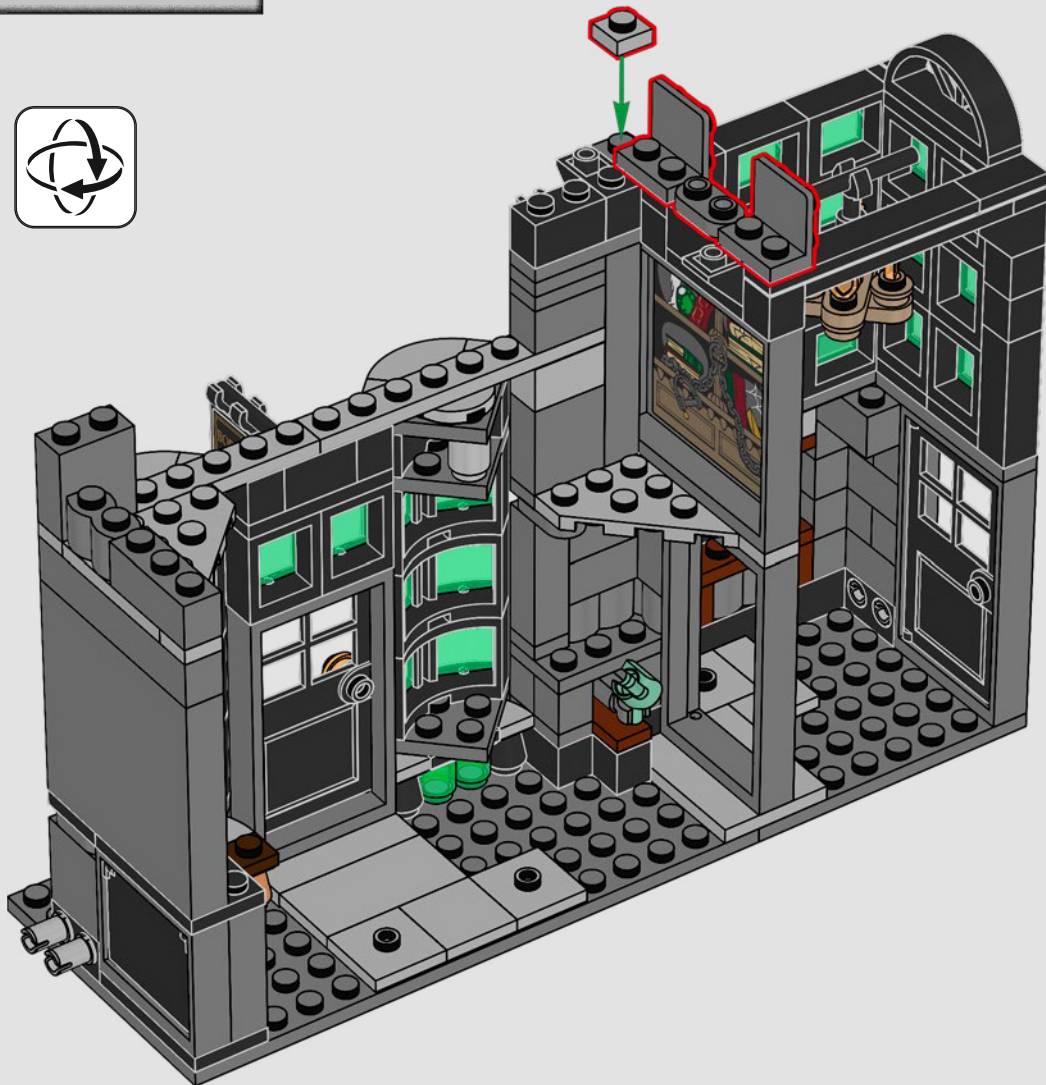

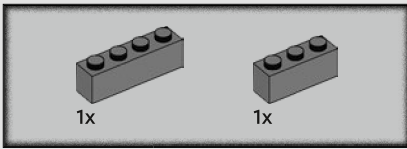

73

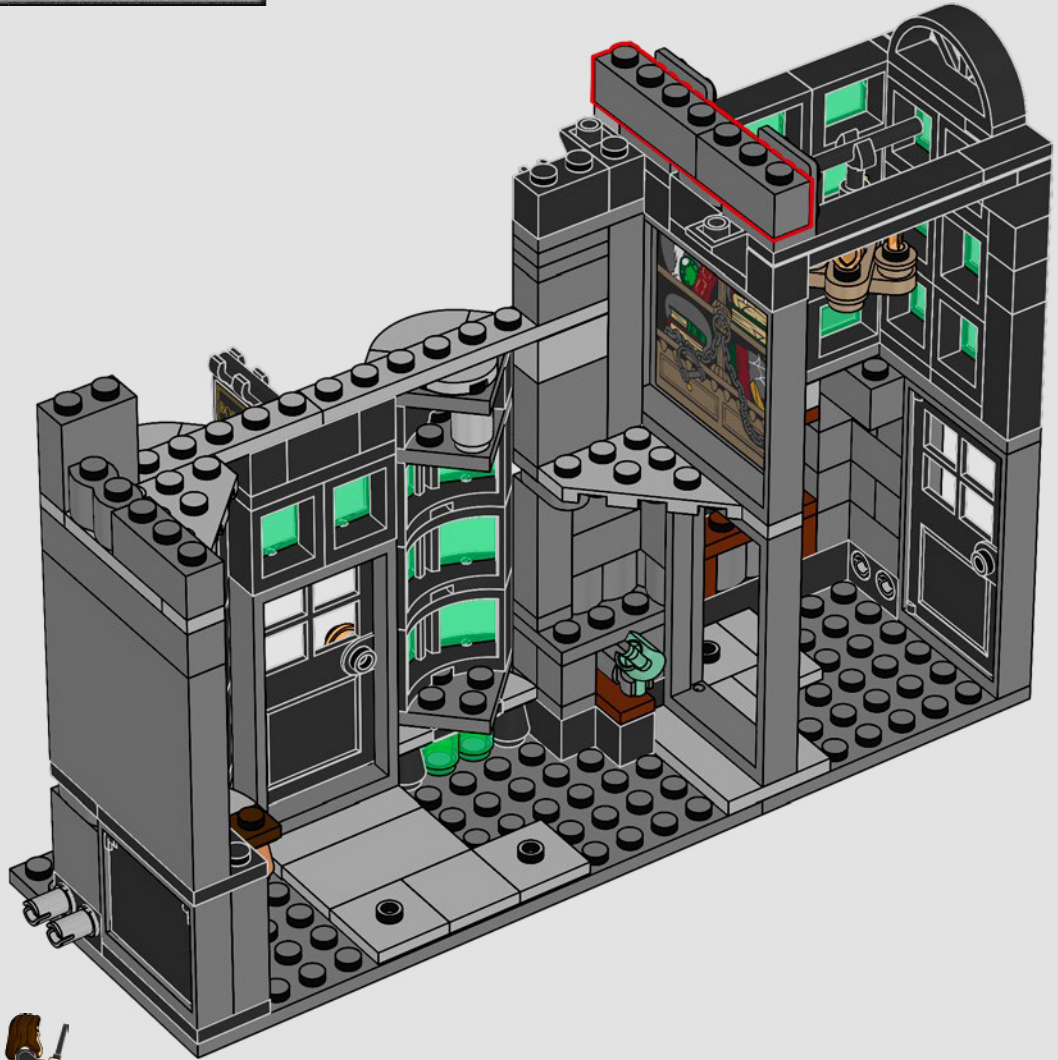

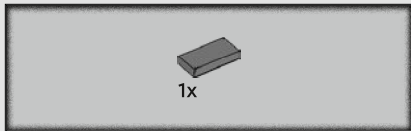

74

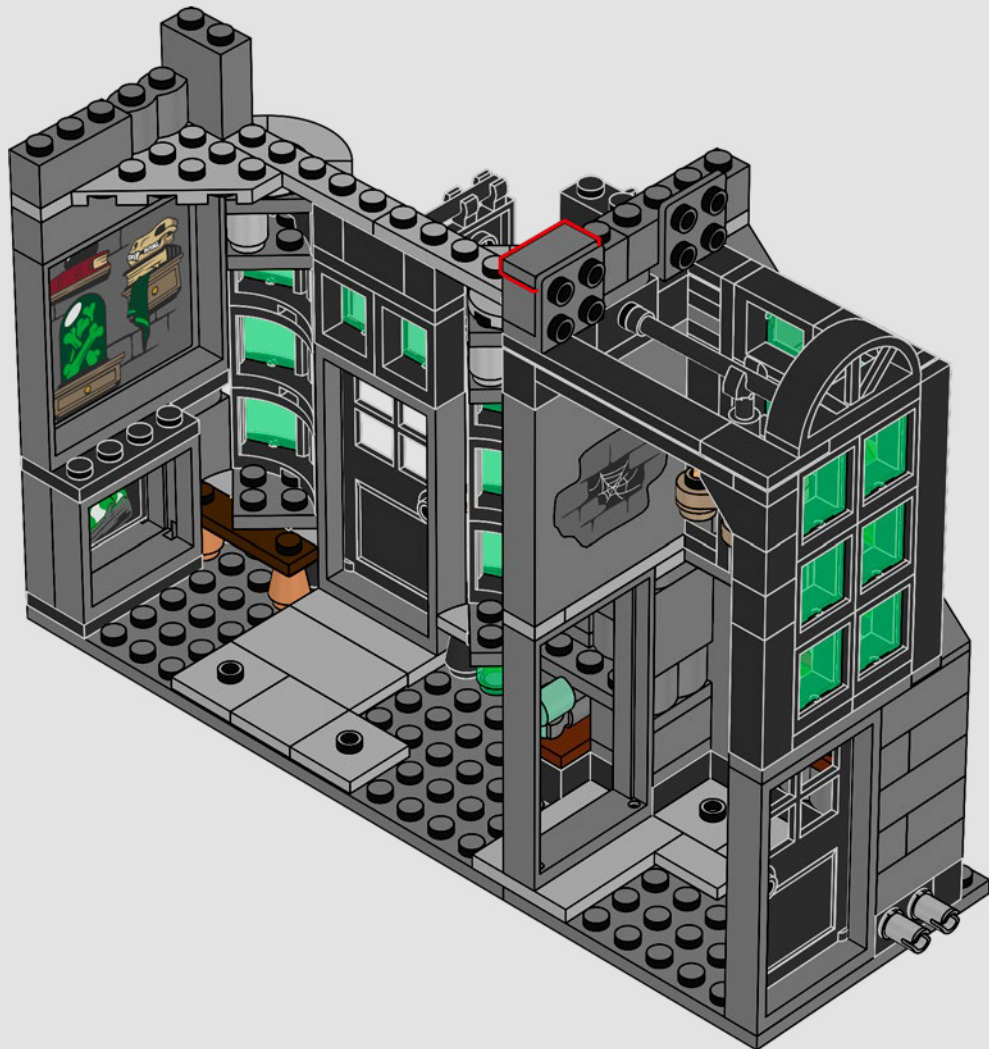

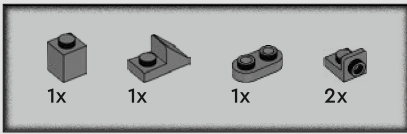

75

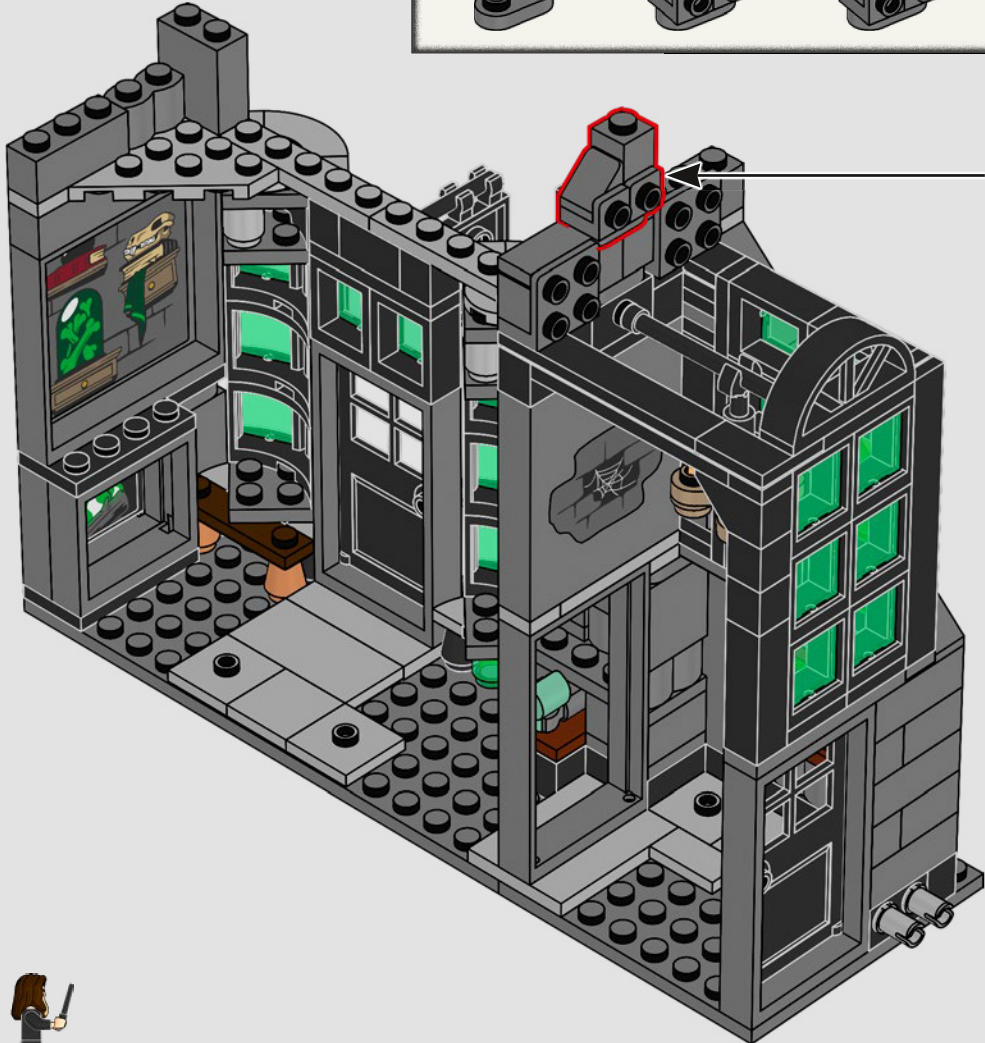
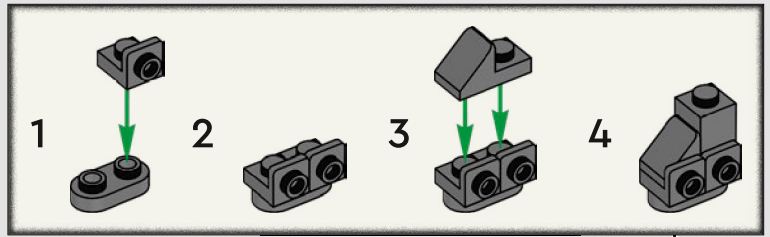

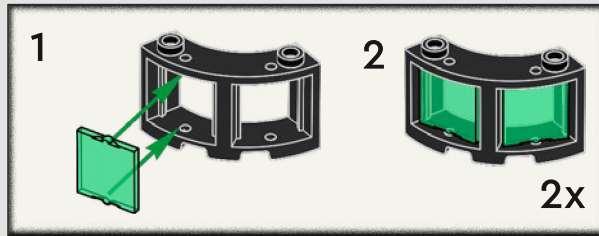
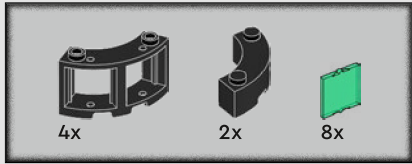
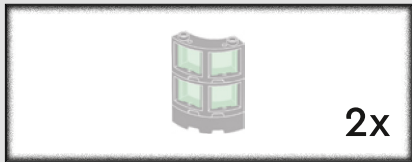

76

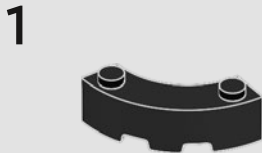

2x

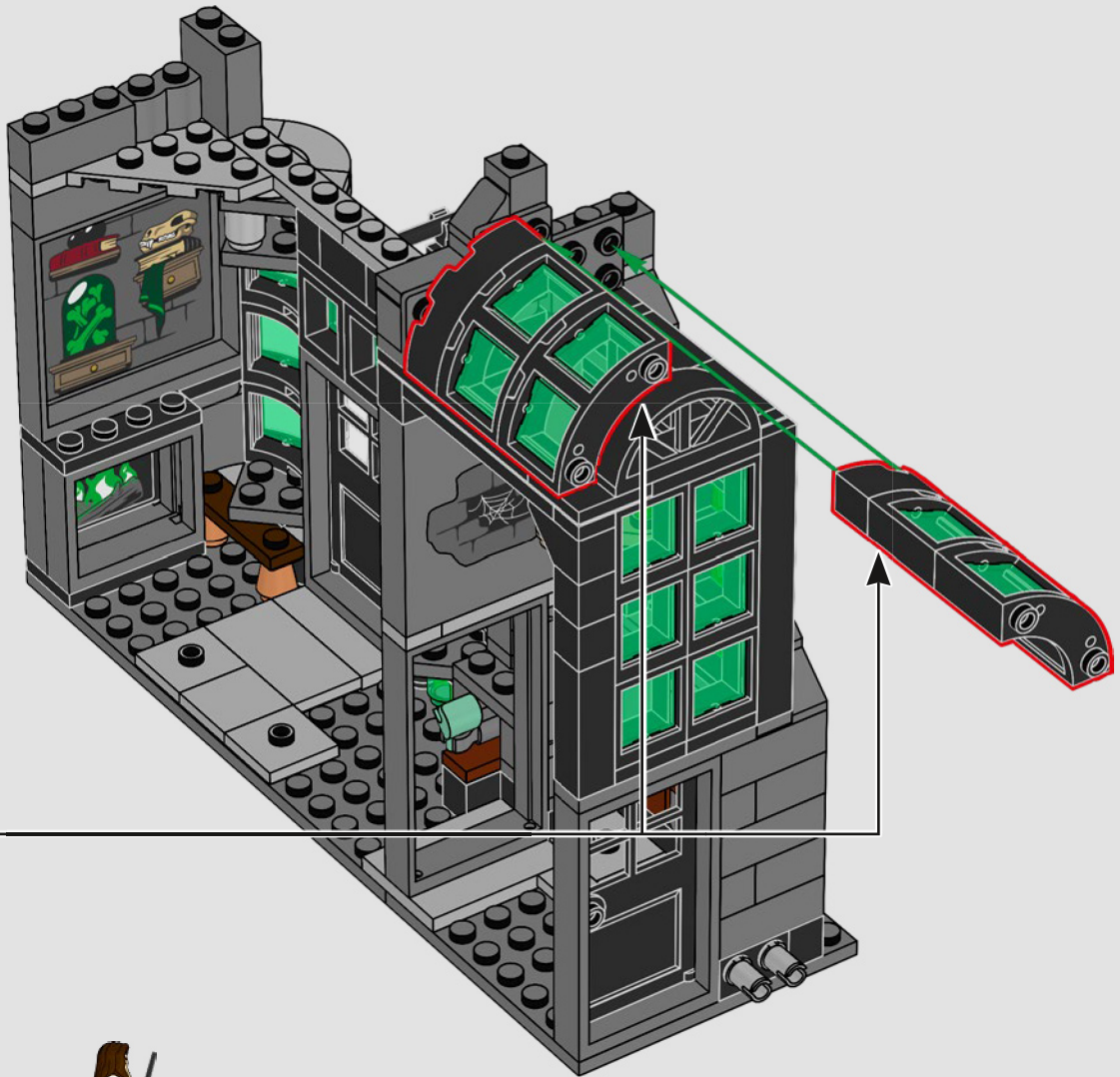



2x



1x

77

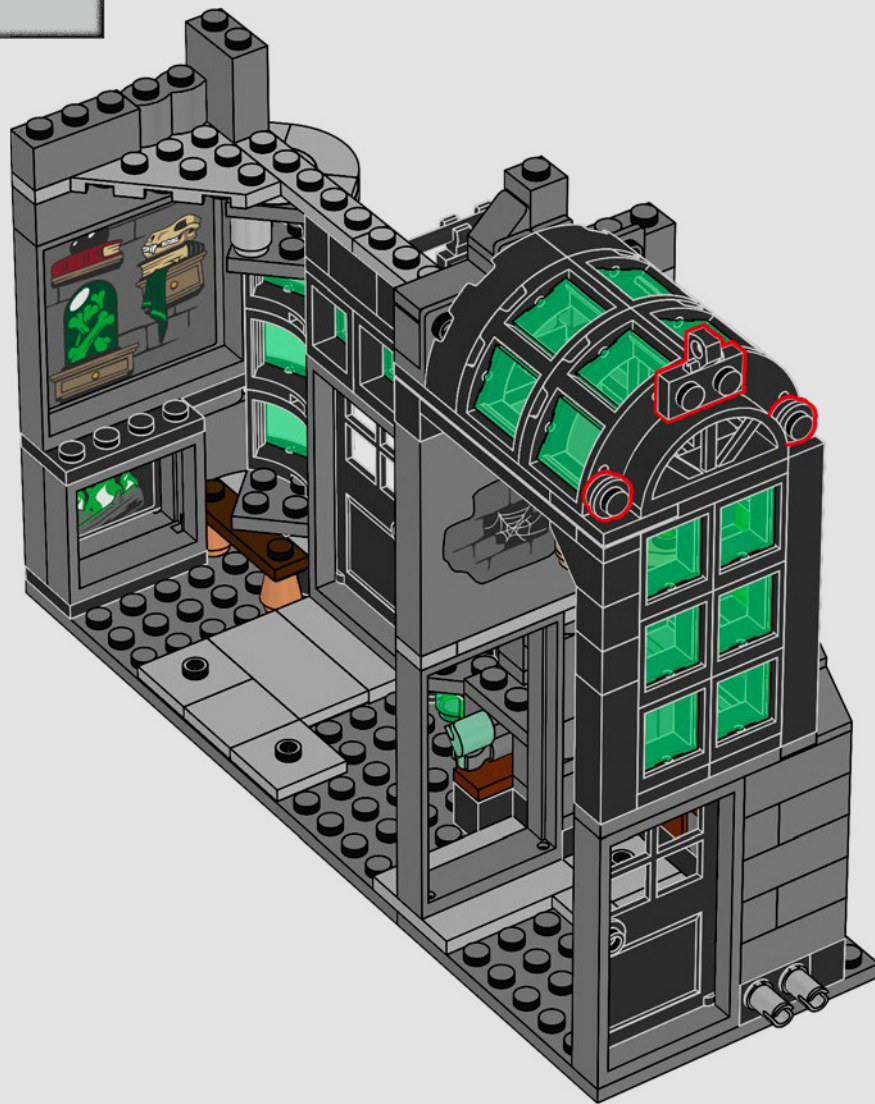

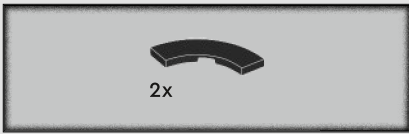

78

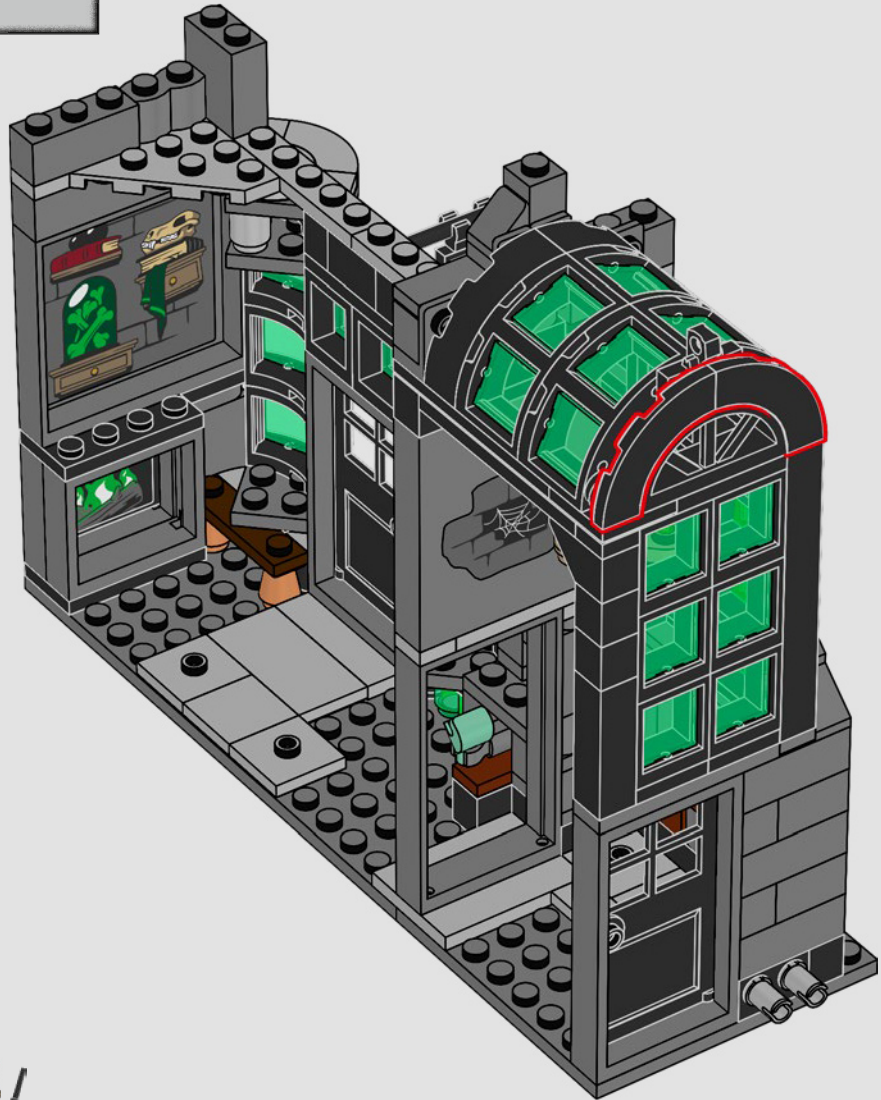

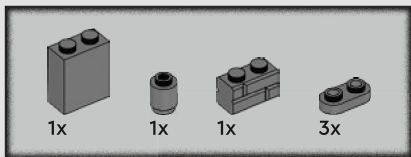

79

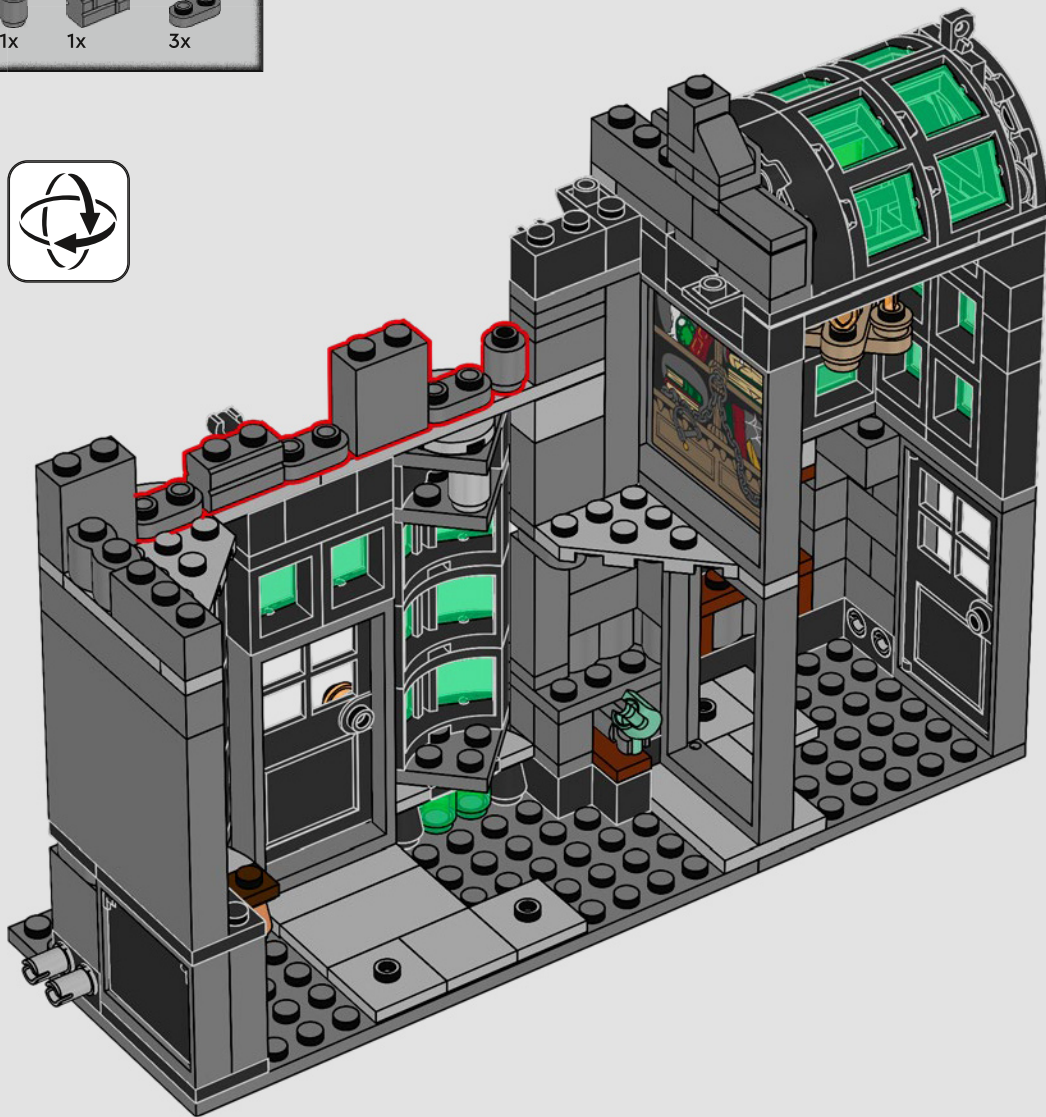

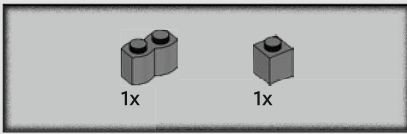

80

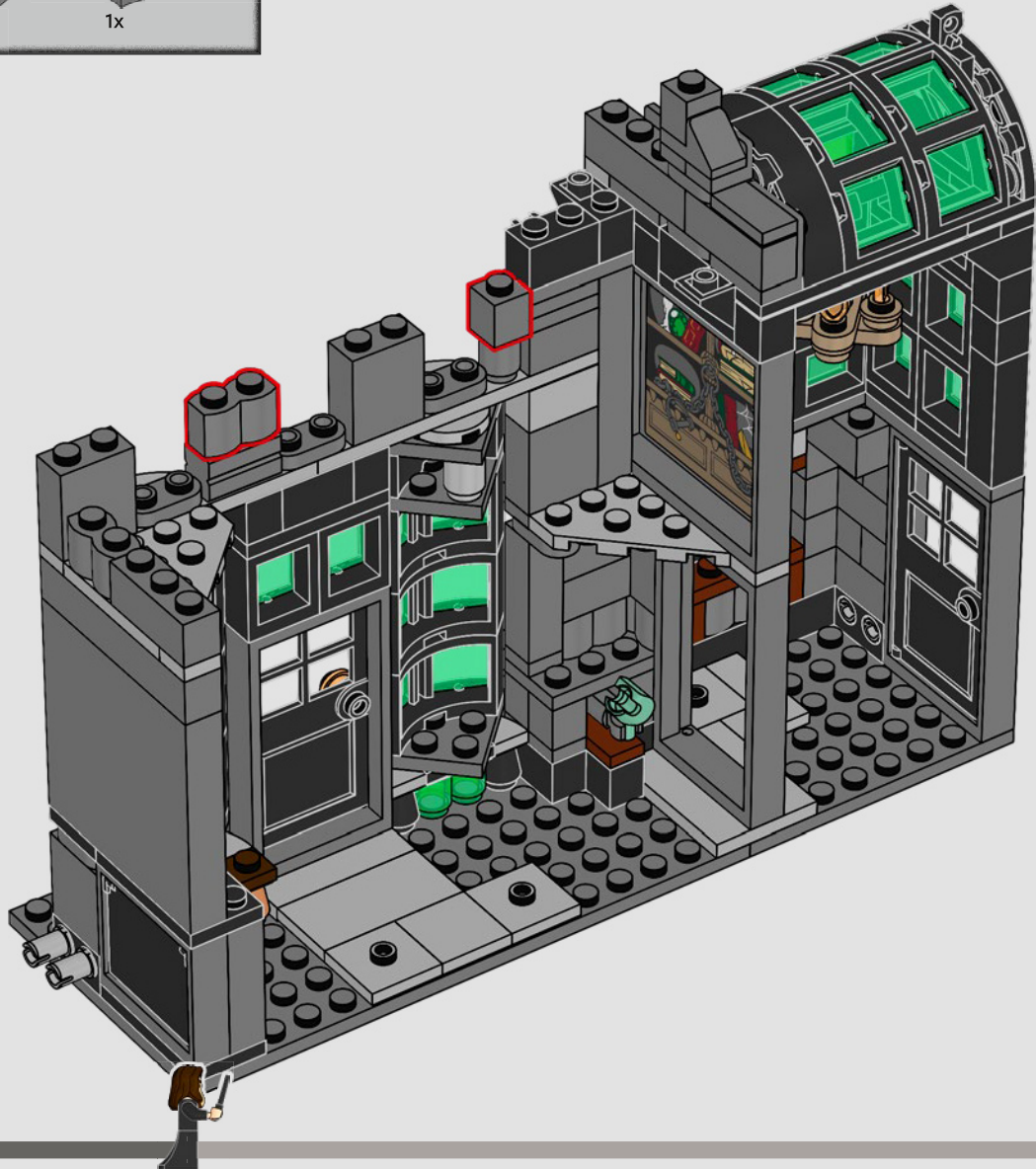

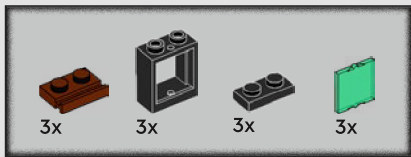
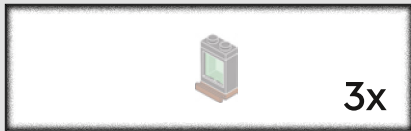

81

1

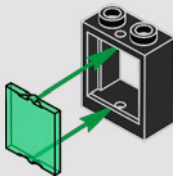

2

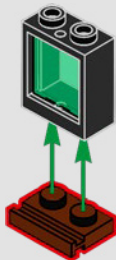

3

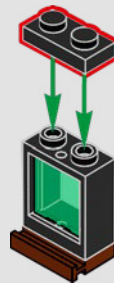

3x

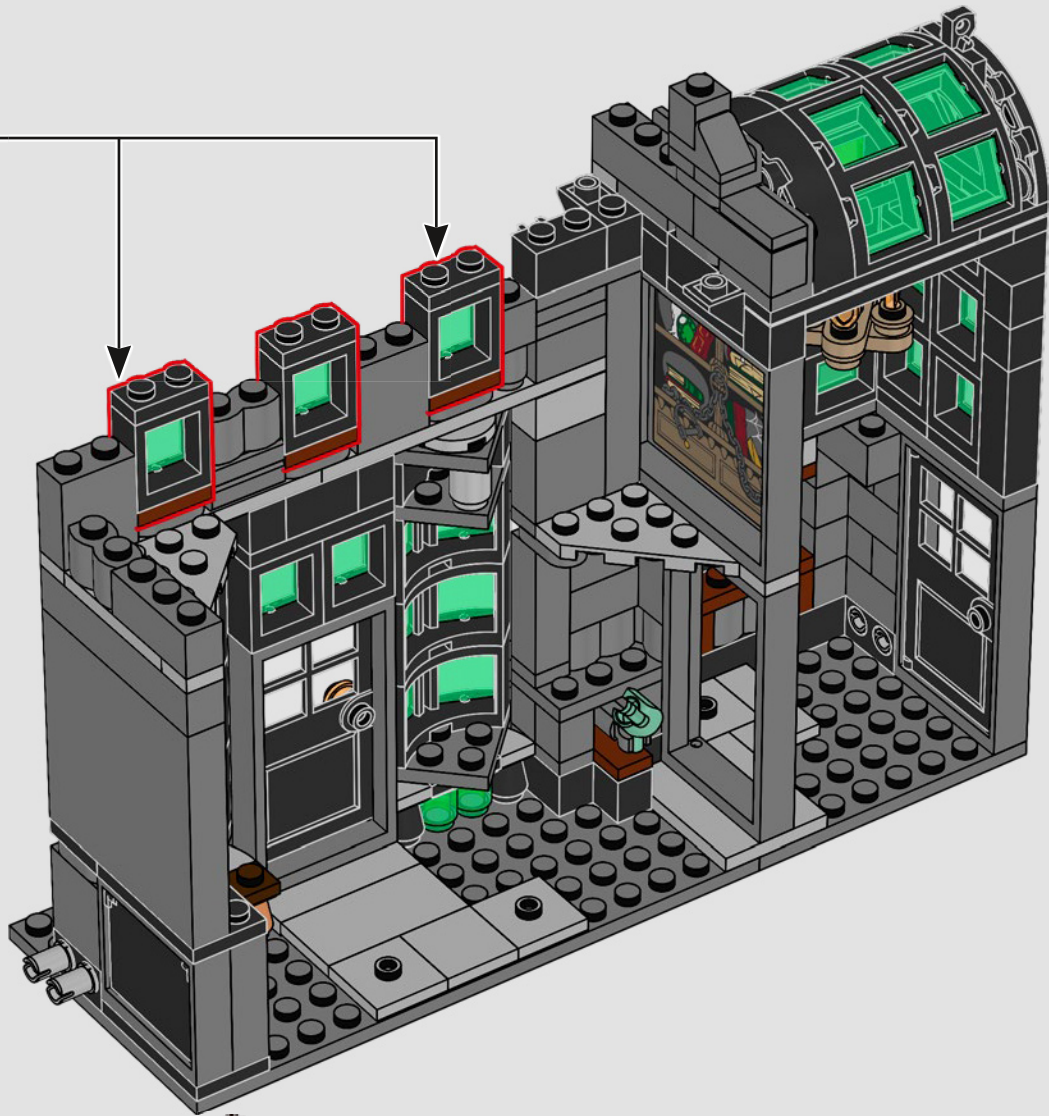

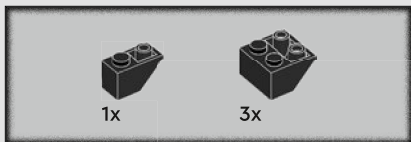

82

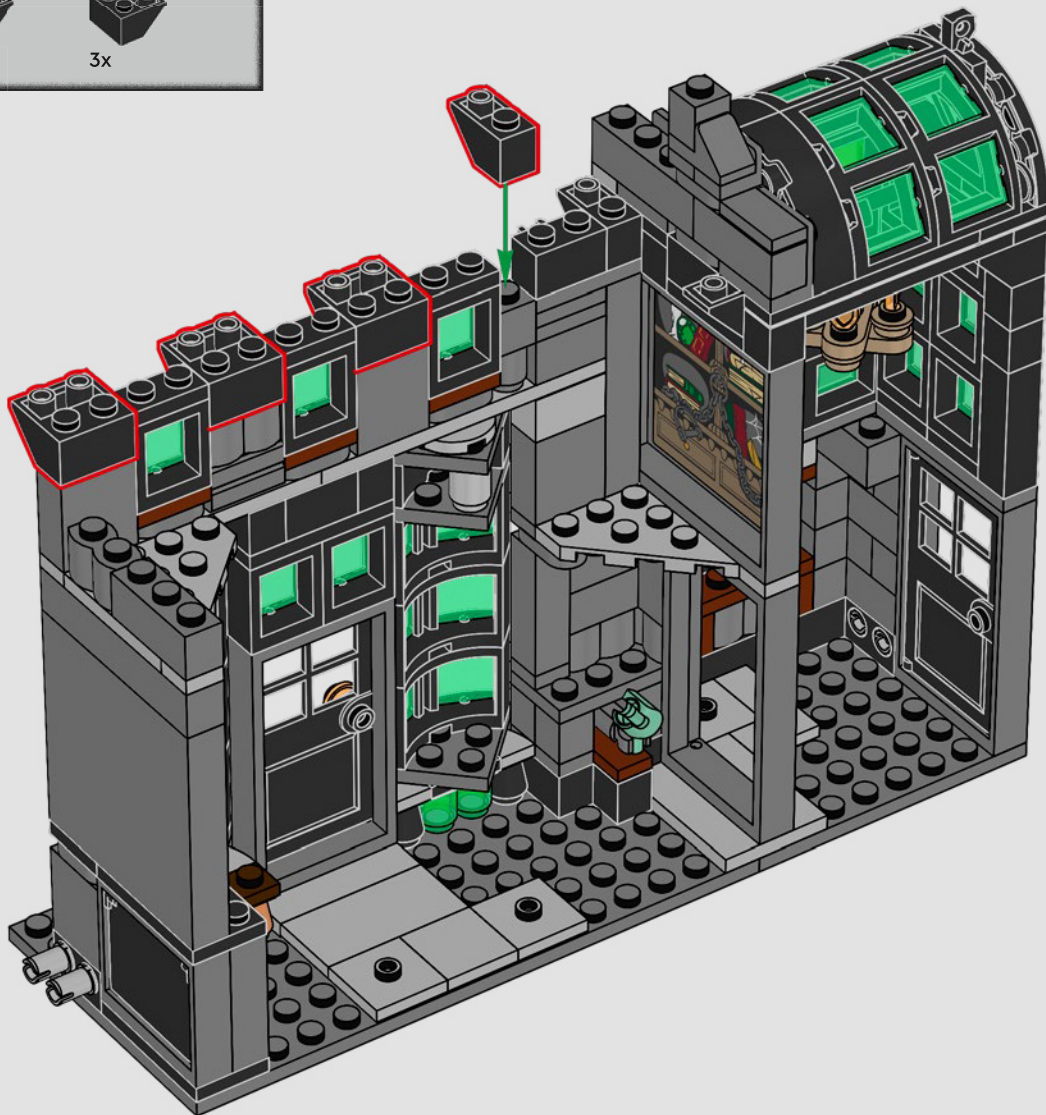

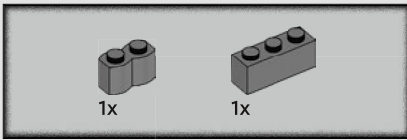

83

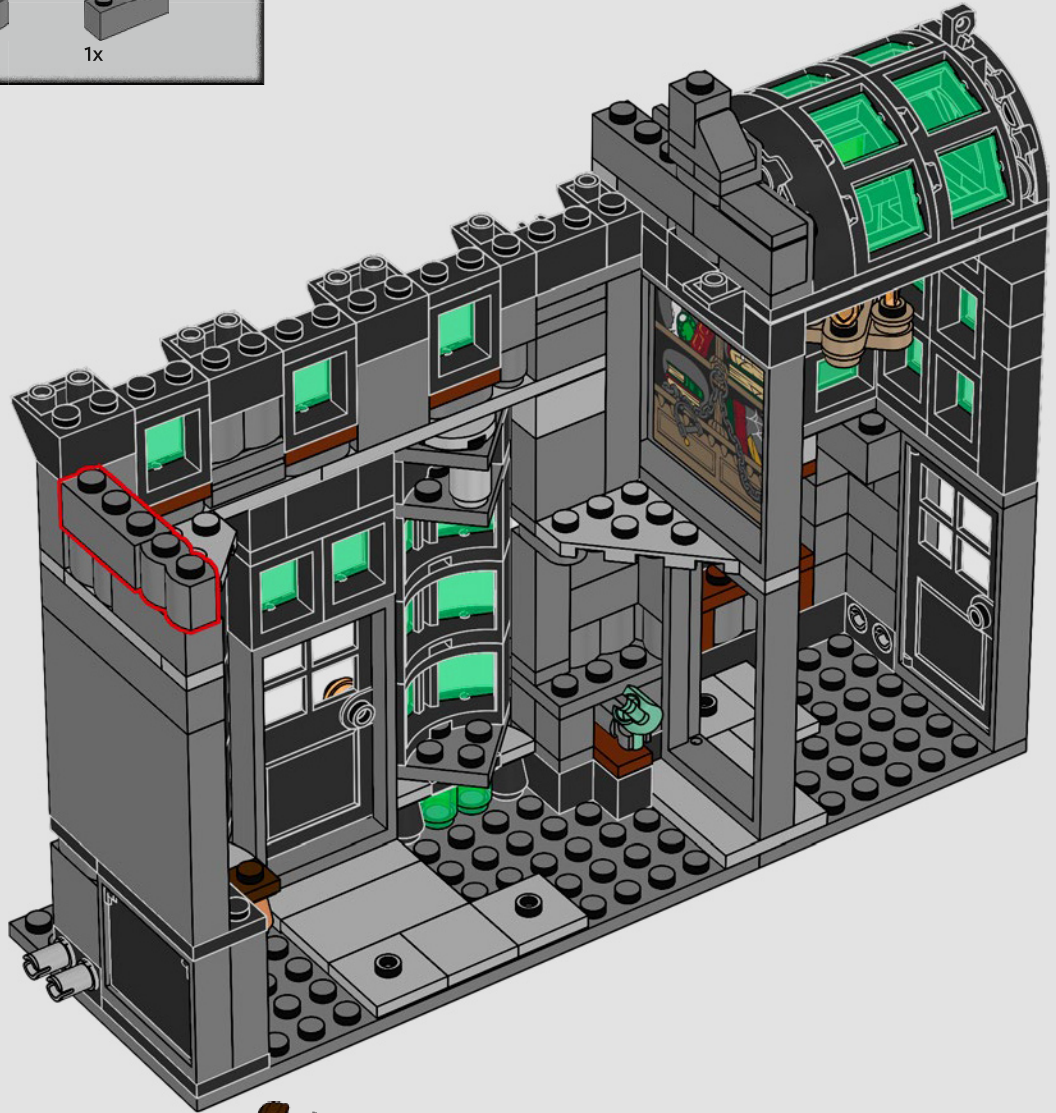

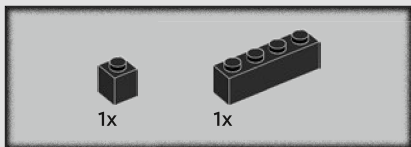

84

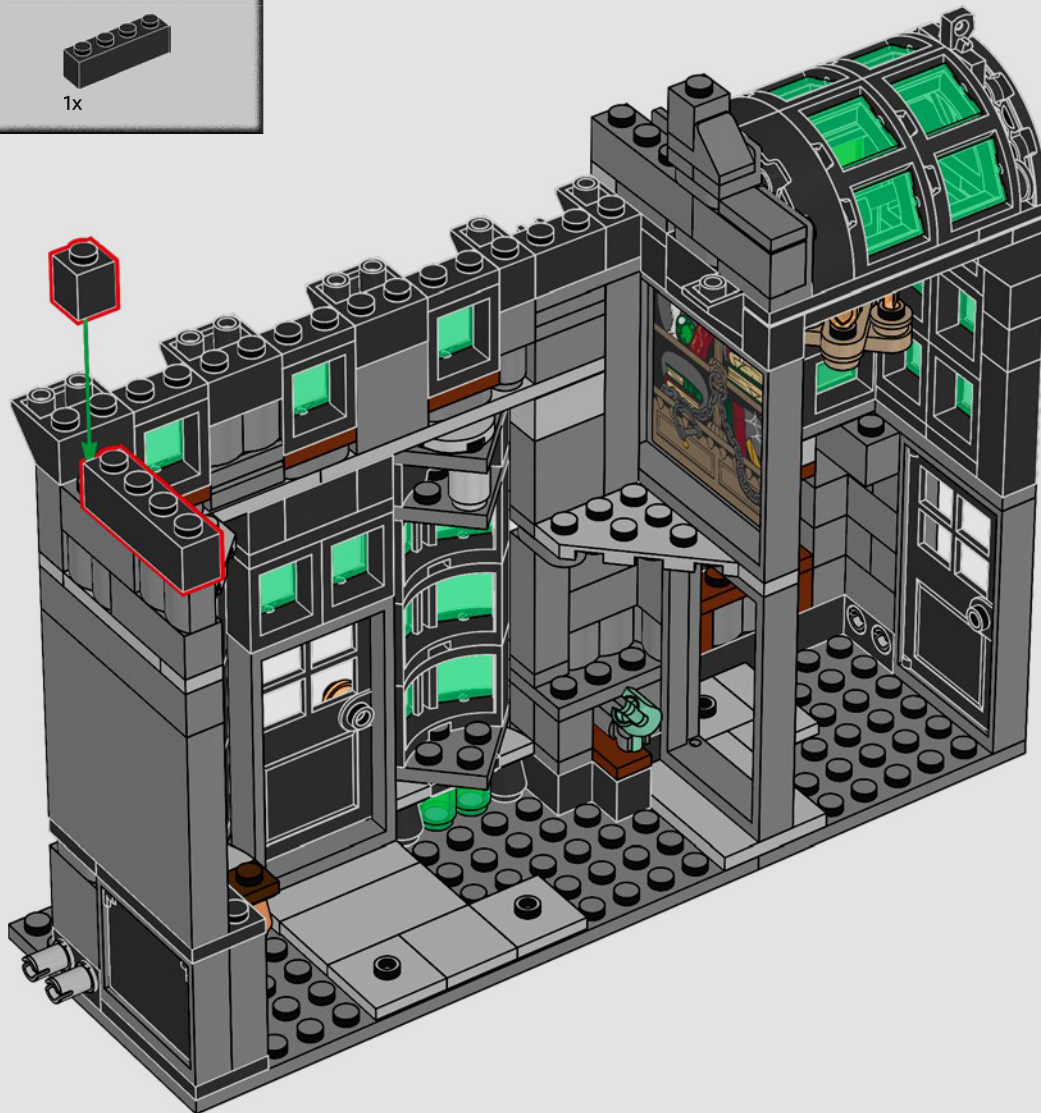

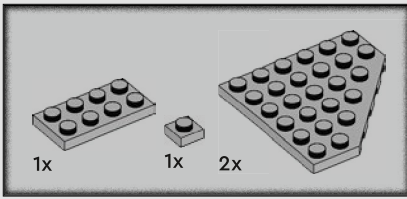

85

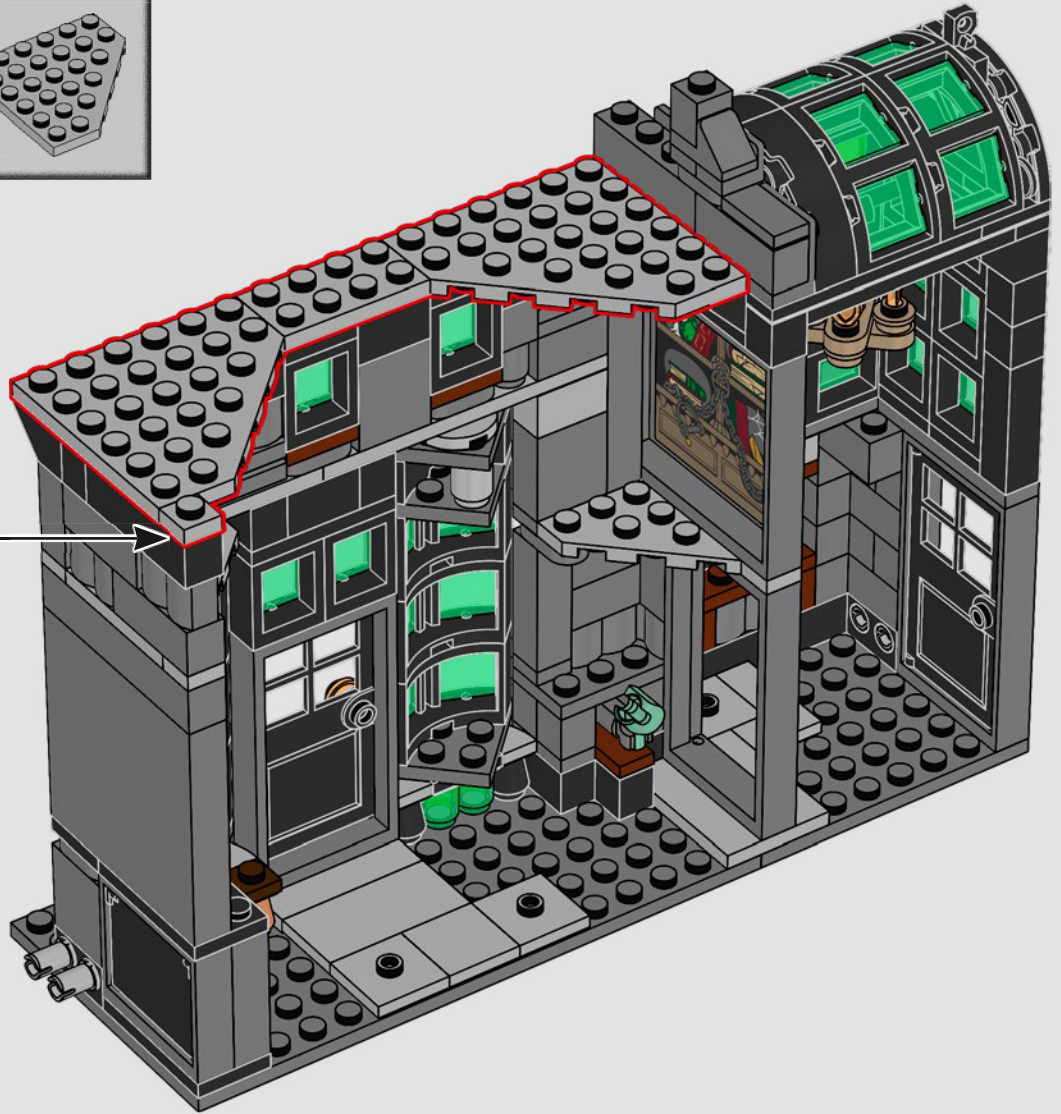
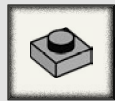

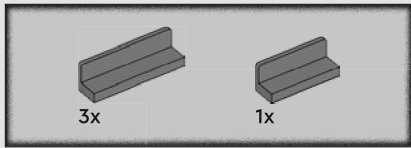

86

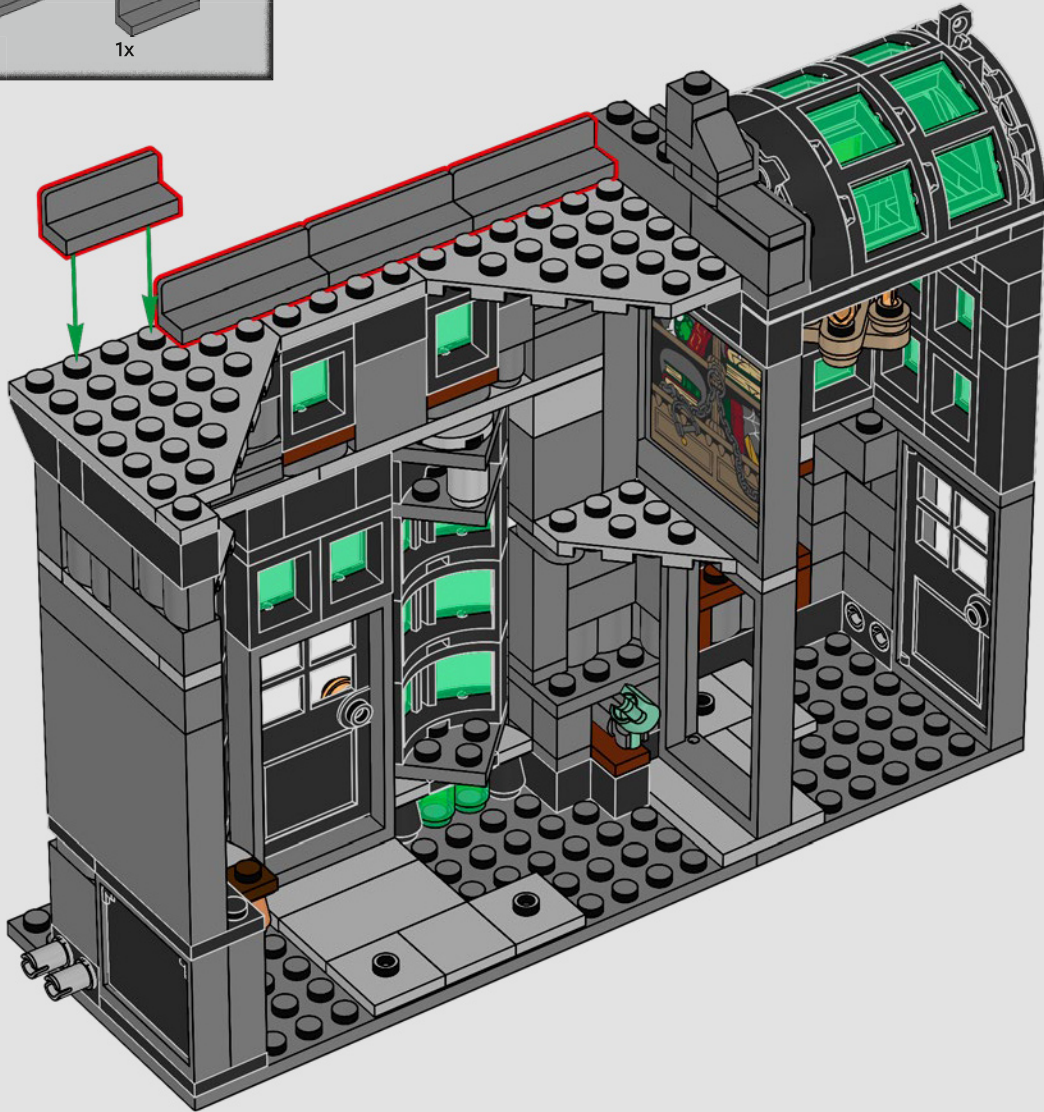

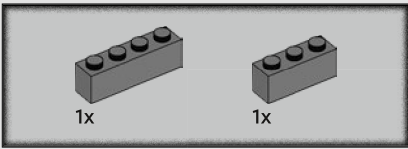

87

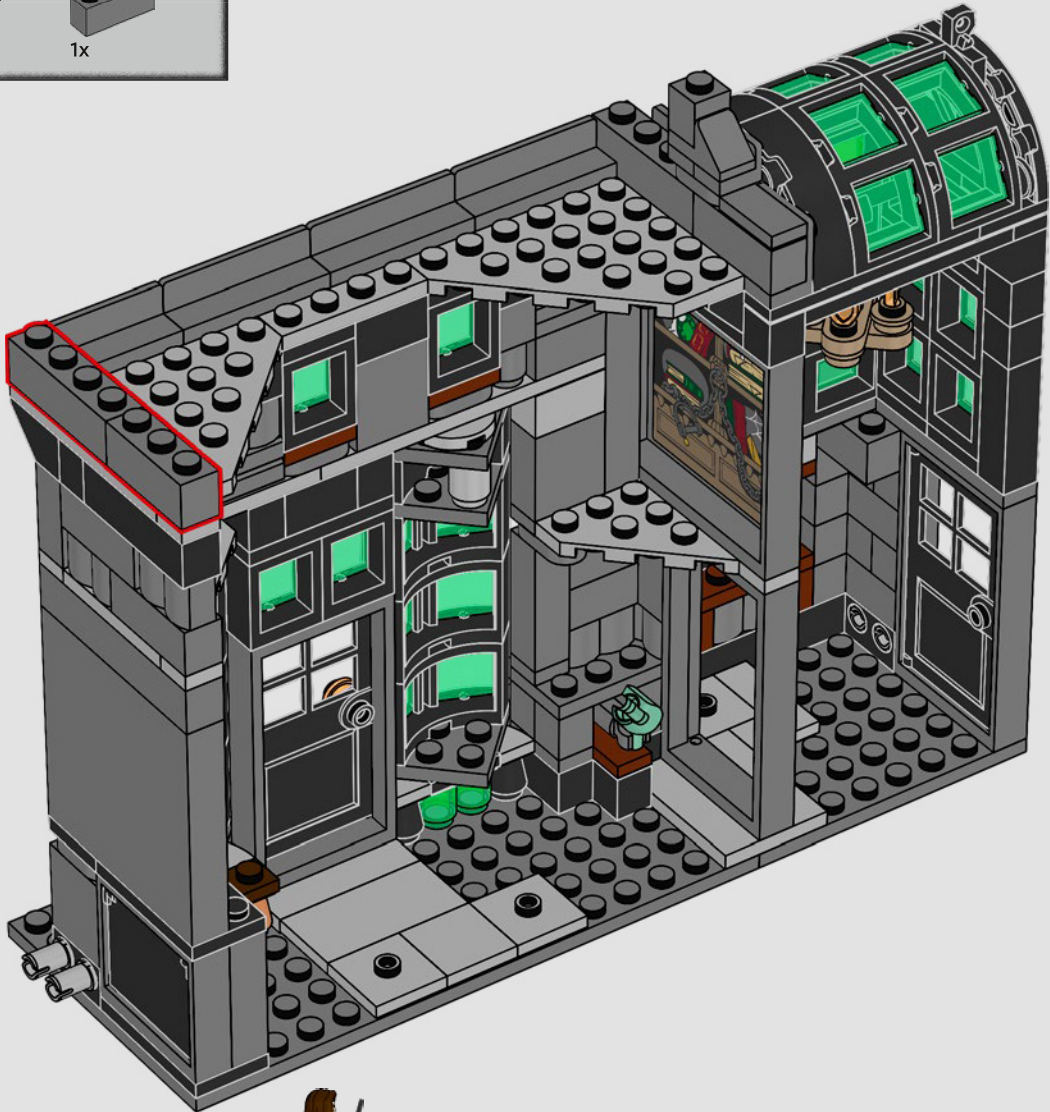

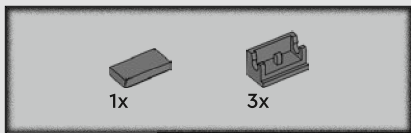

88

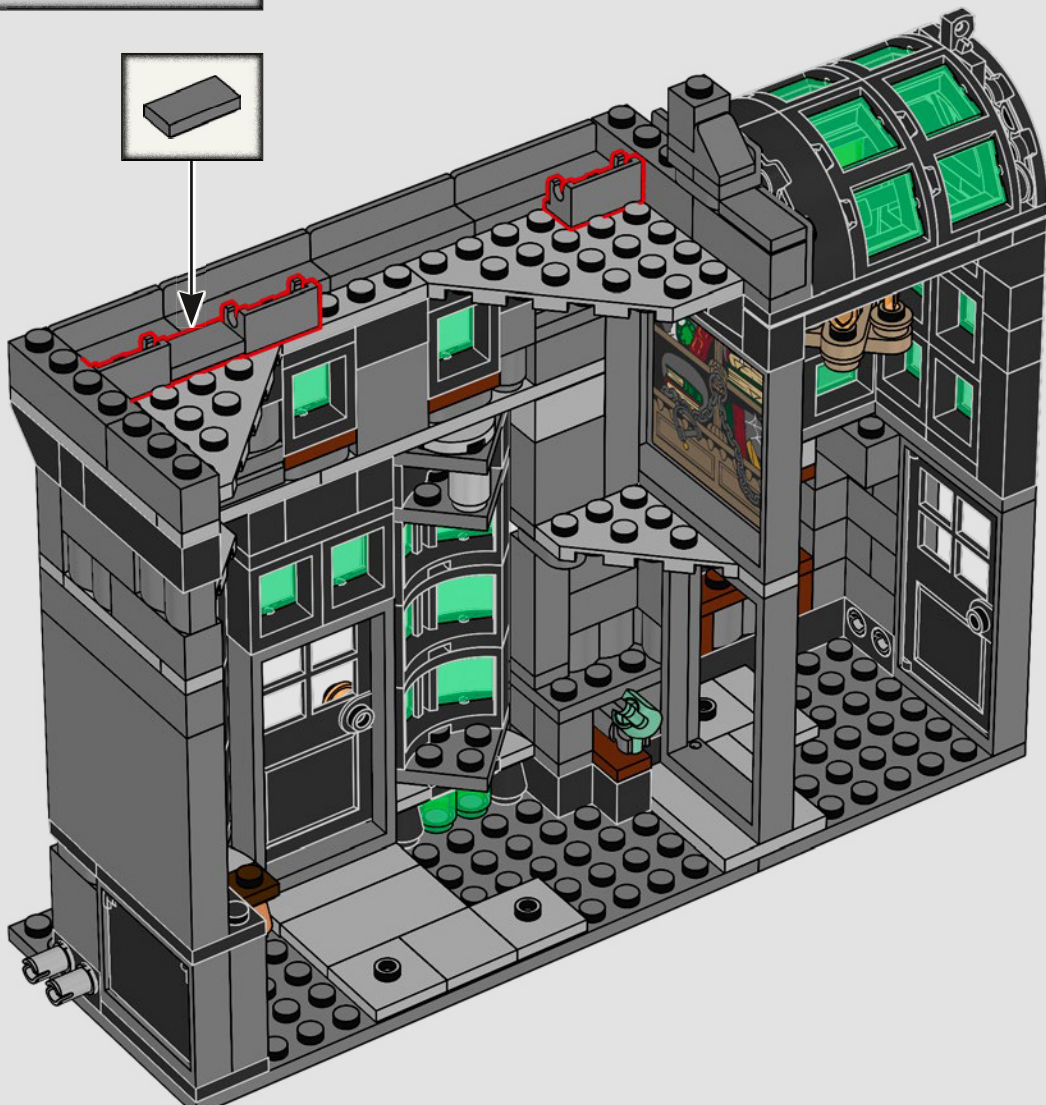
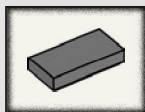

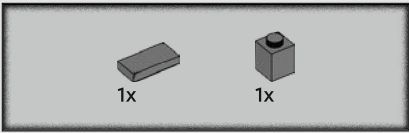

89

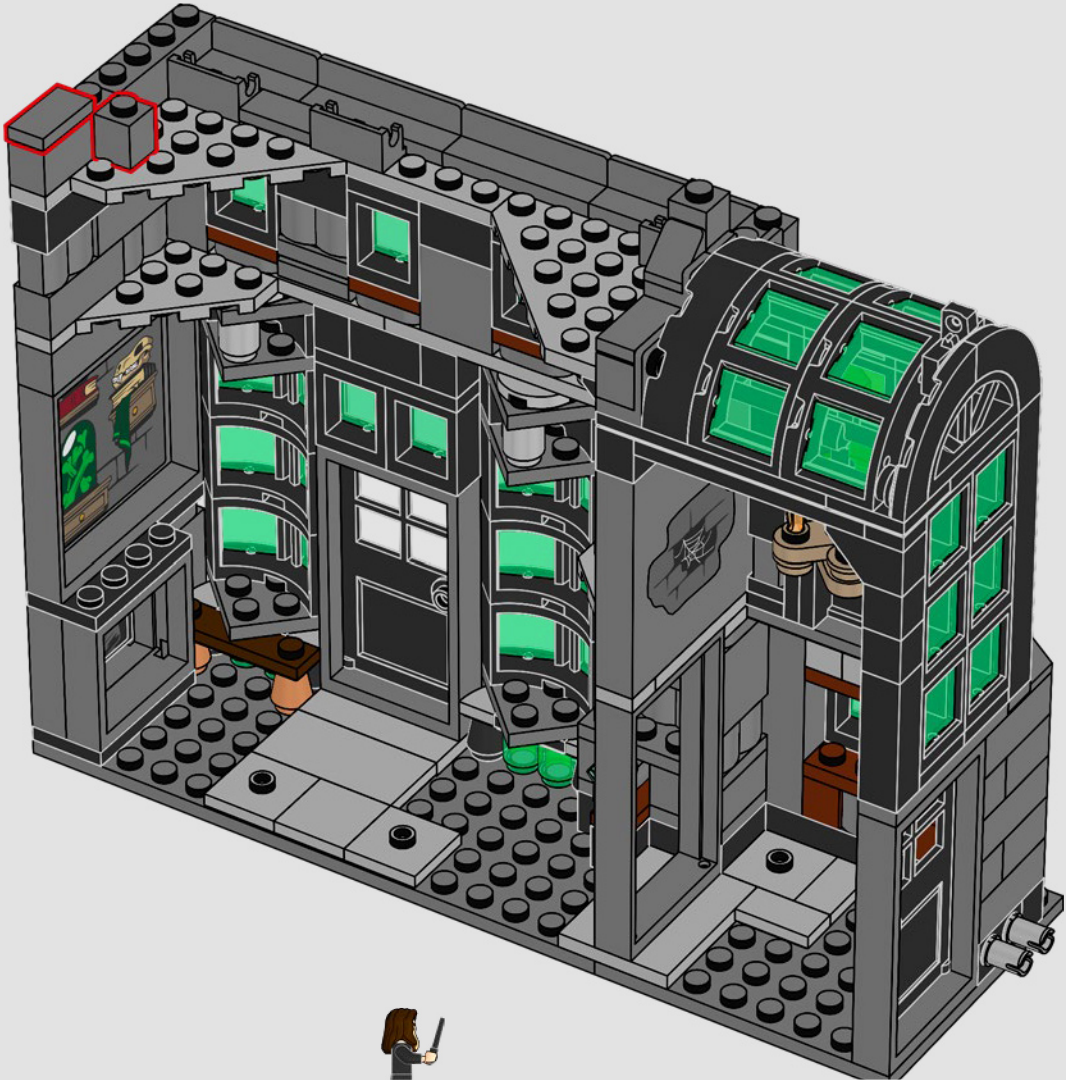

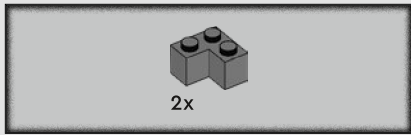

90

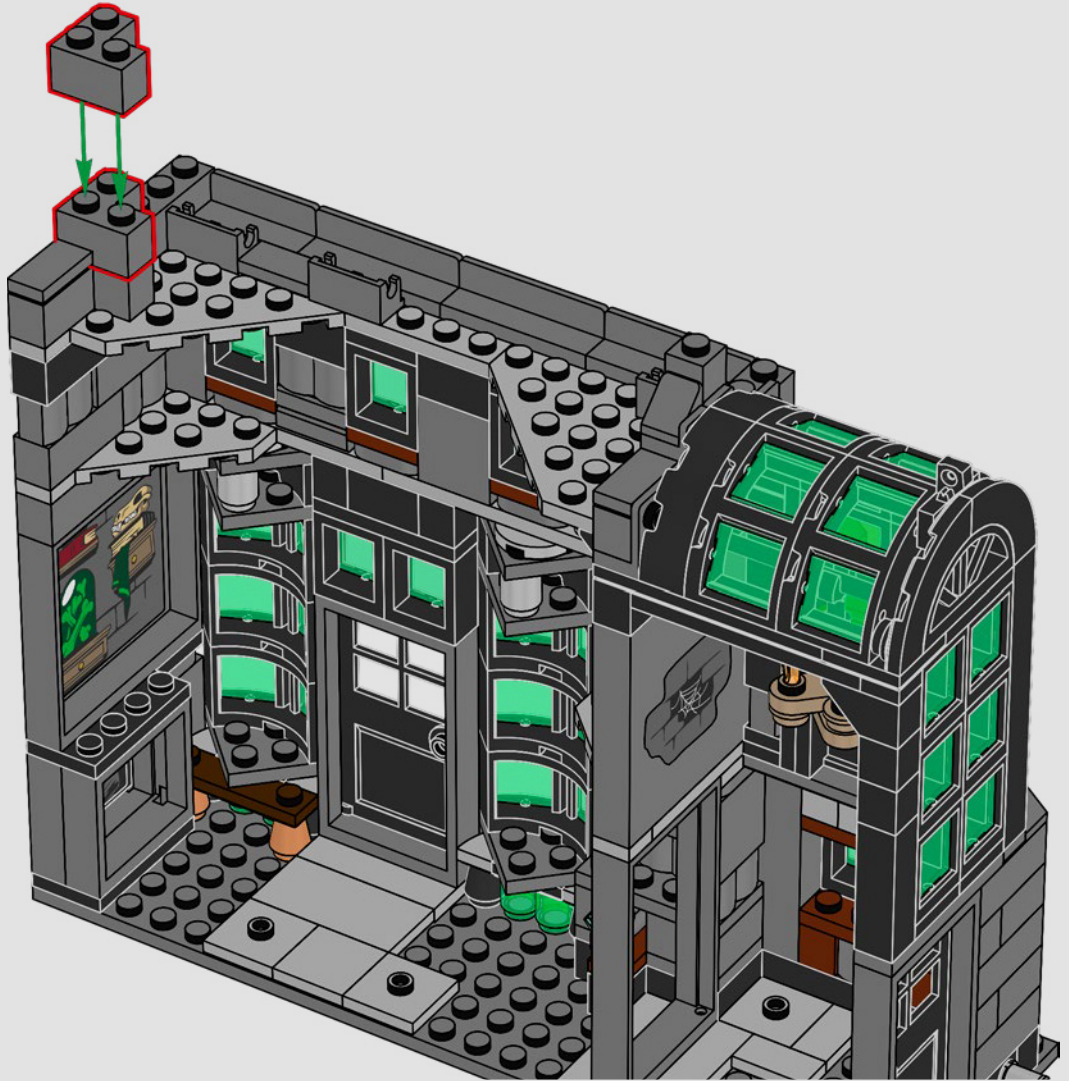



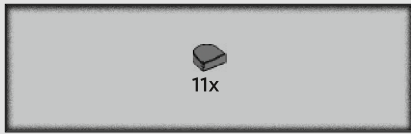

93

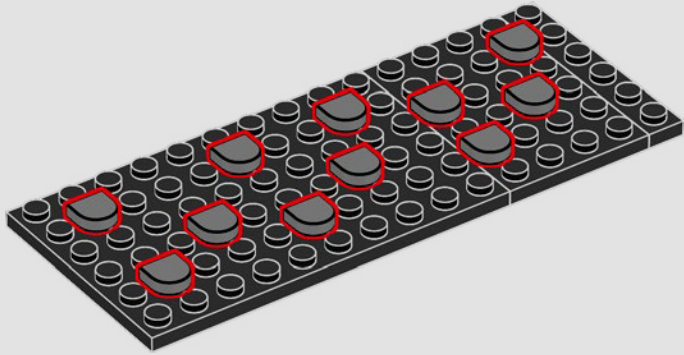

94

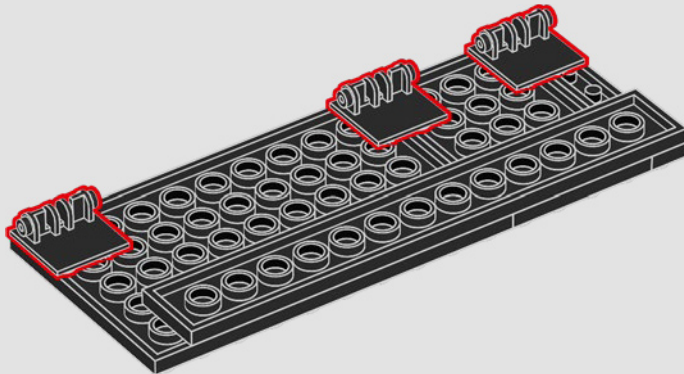

95

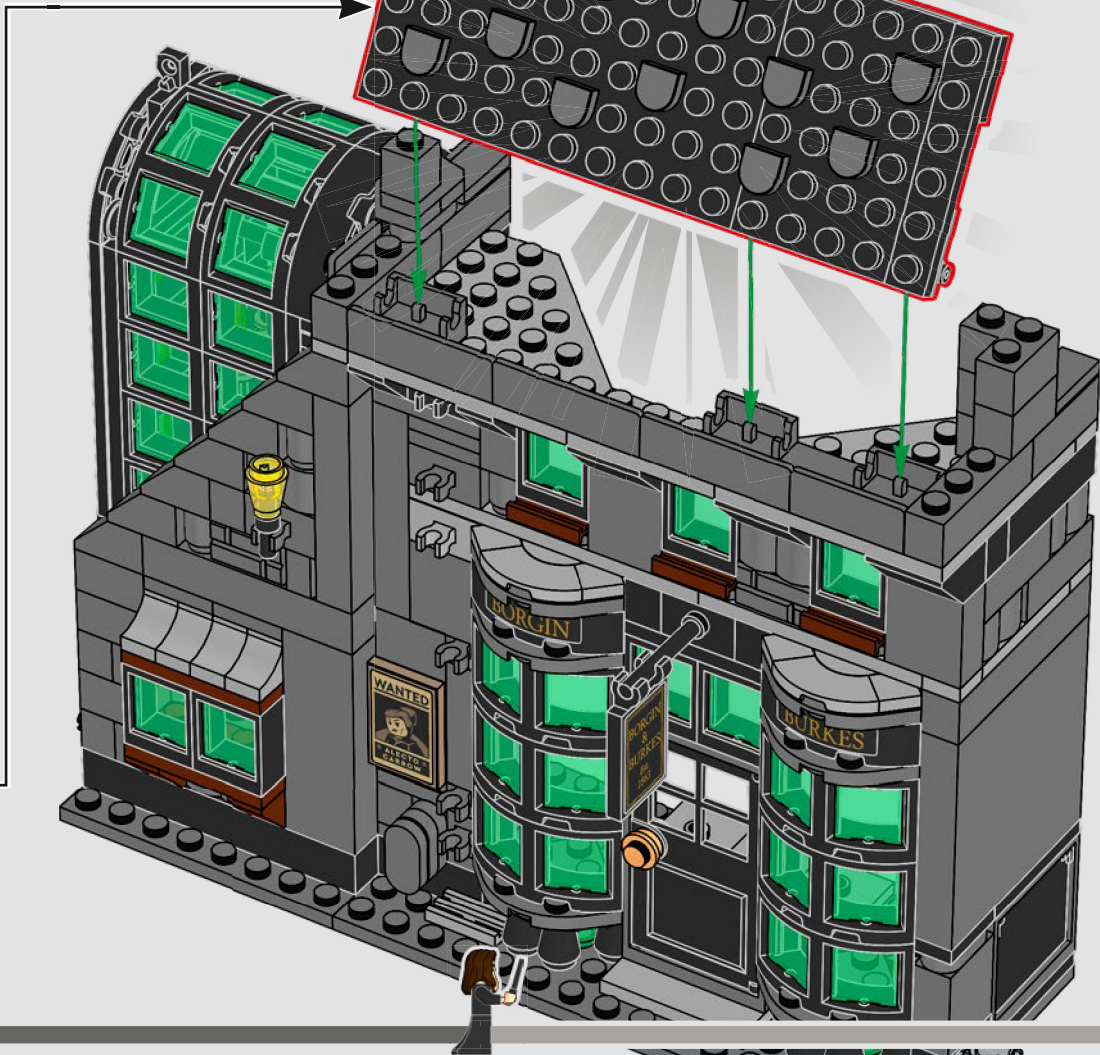

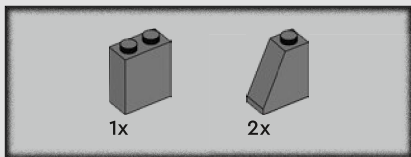

96

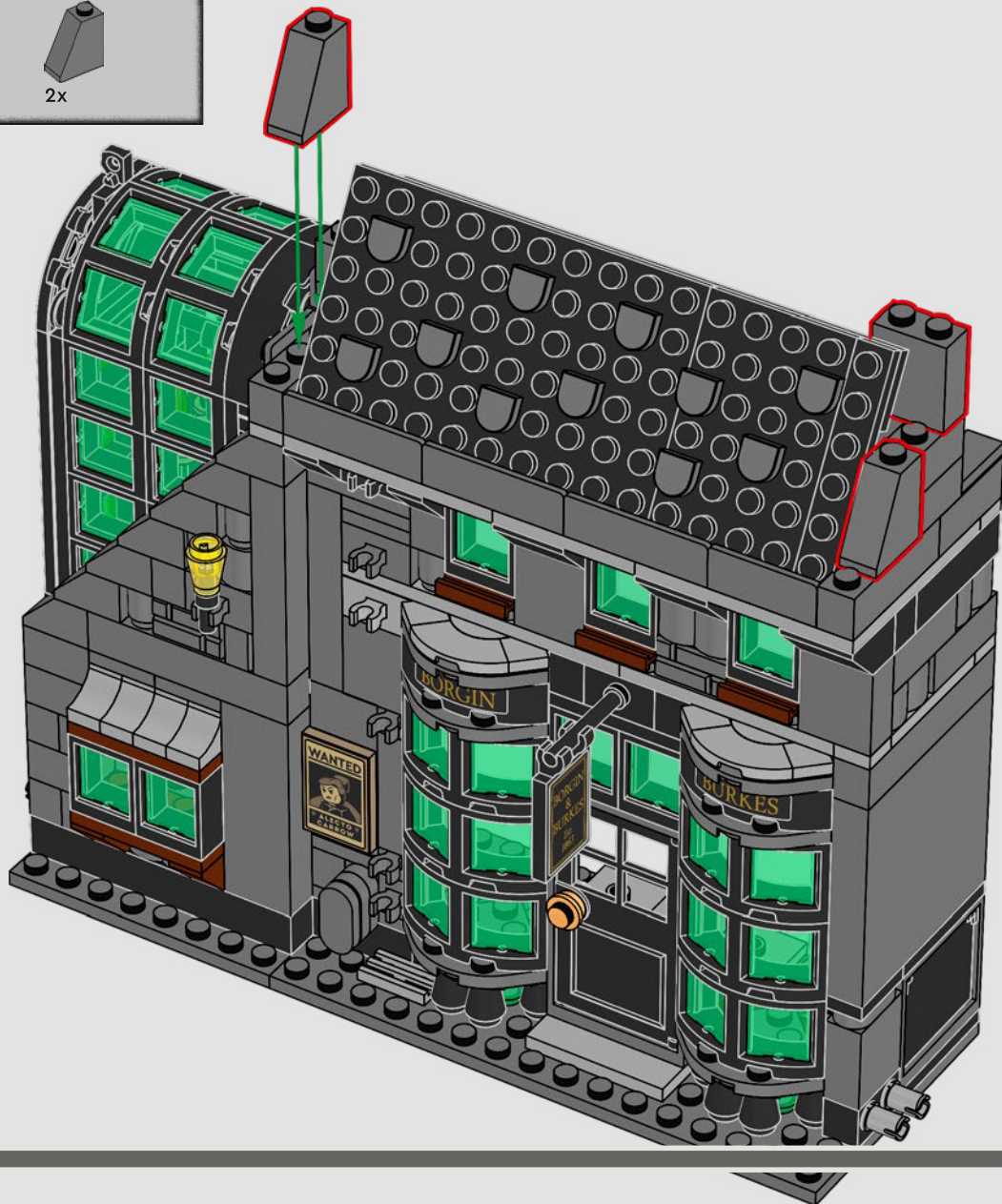

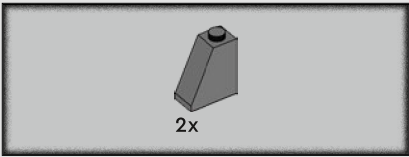

97

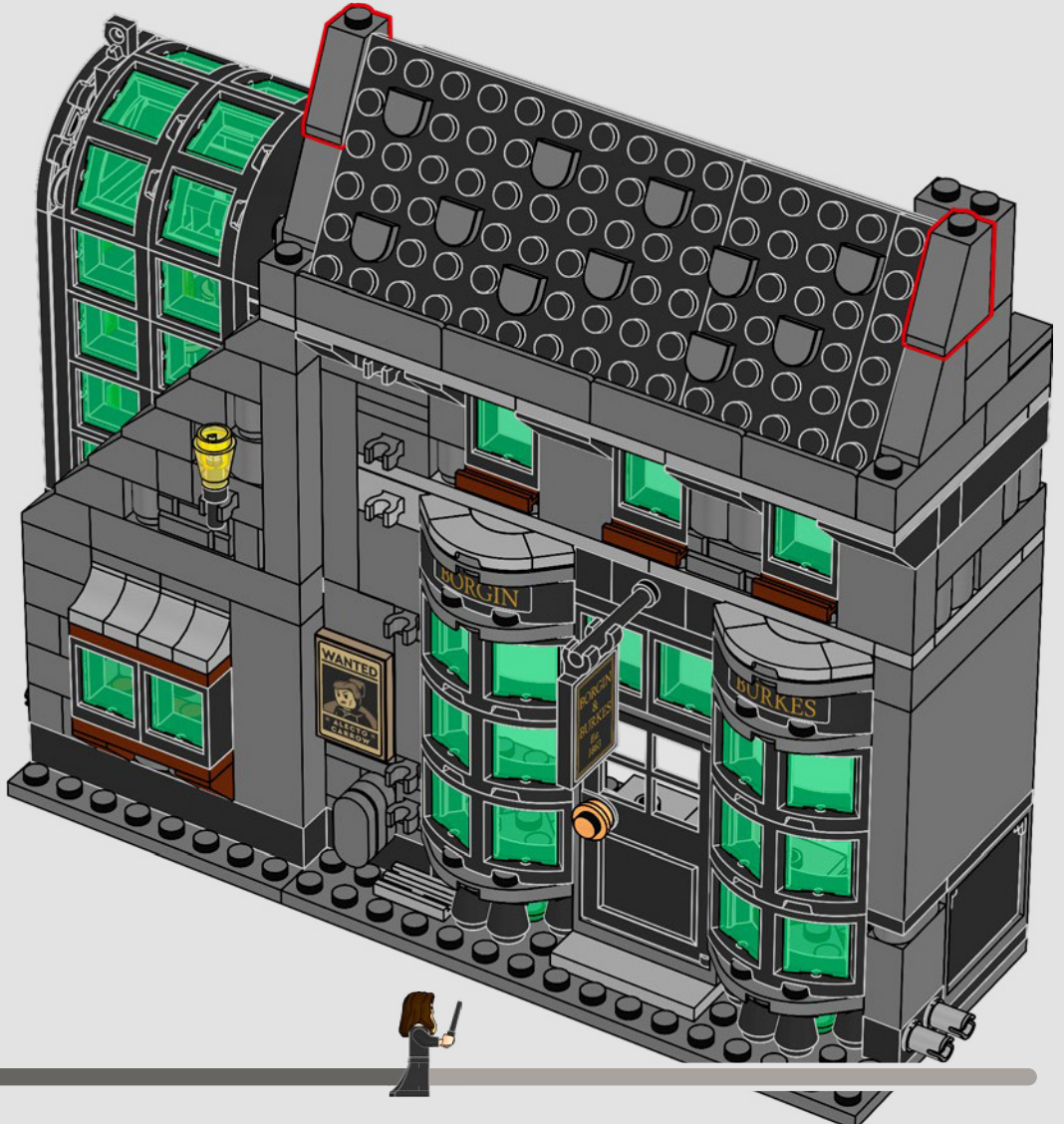



3x

98

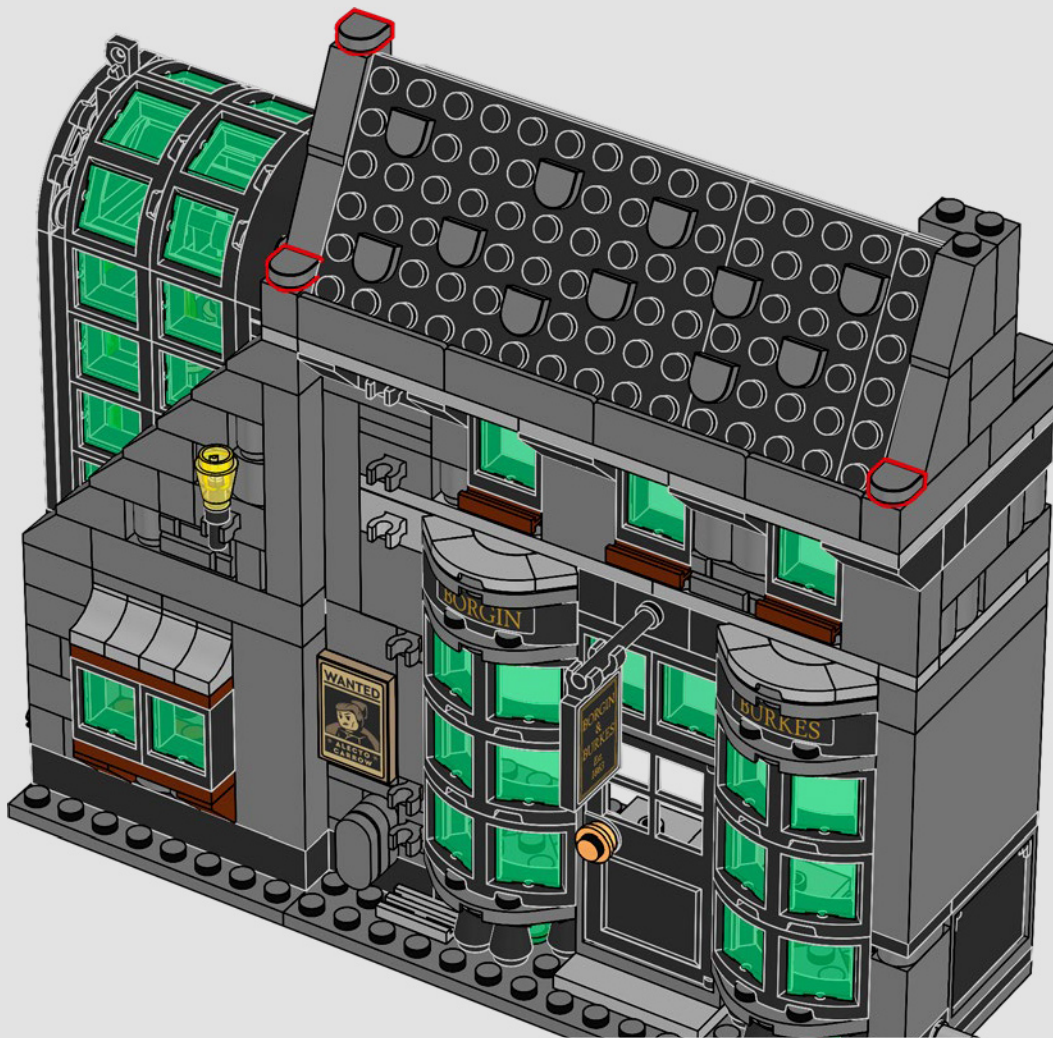

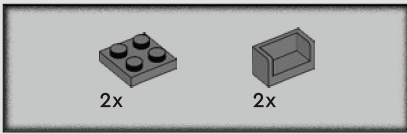

99

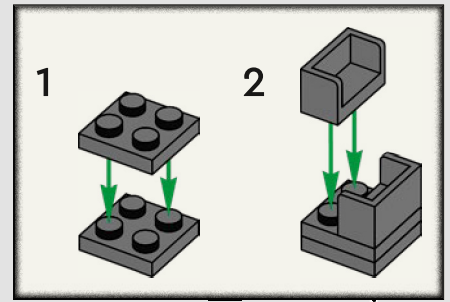

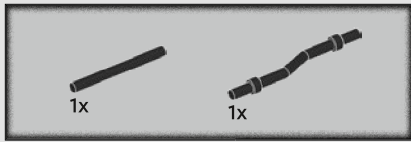

100

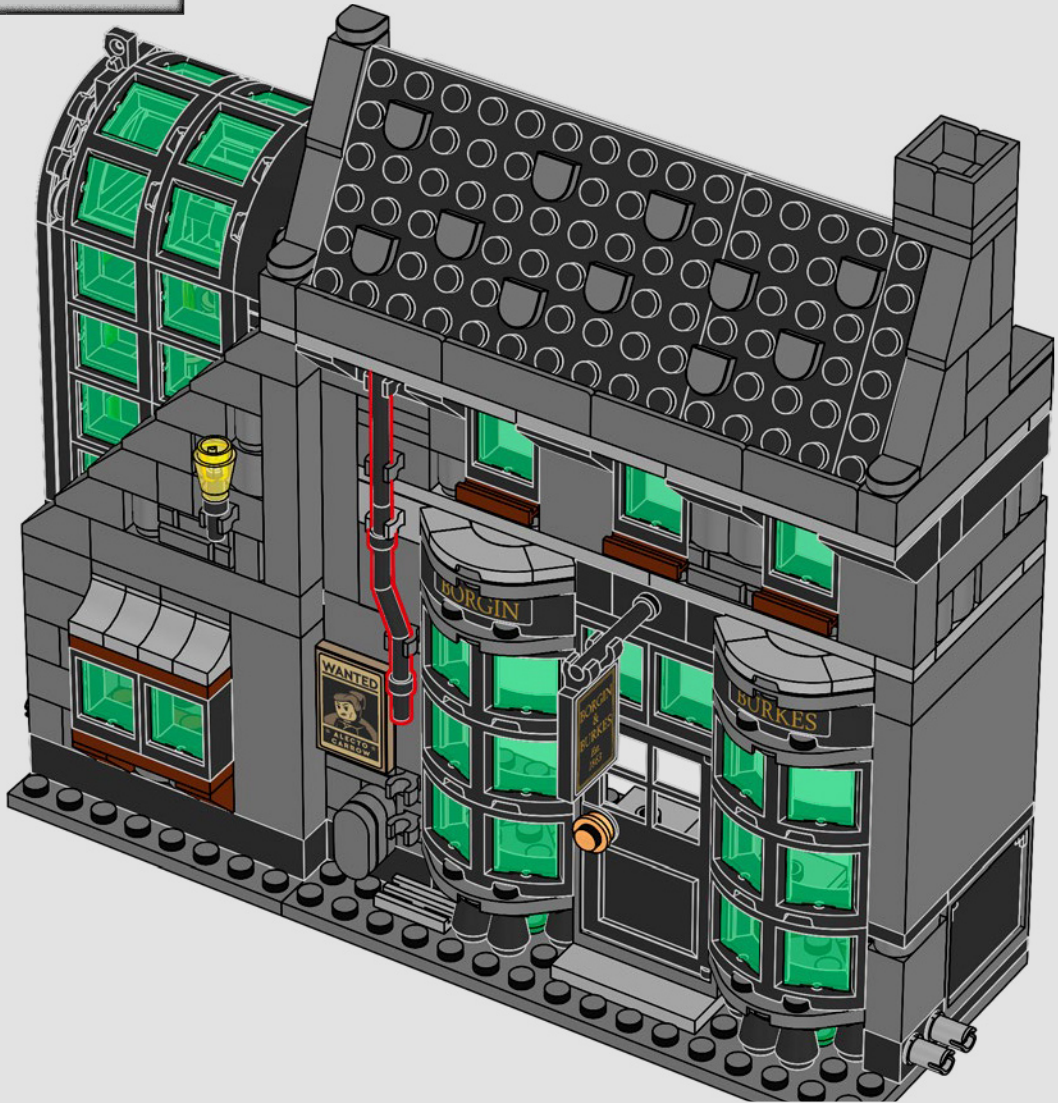



101



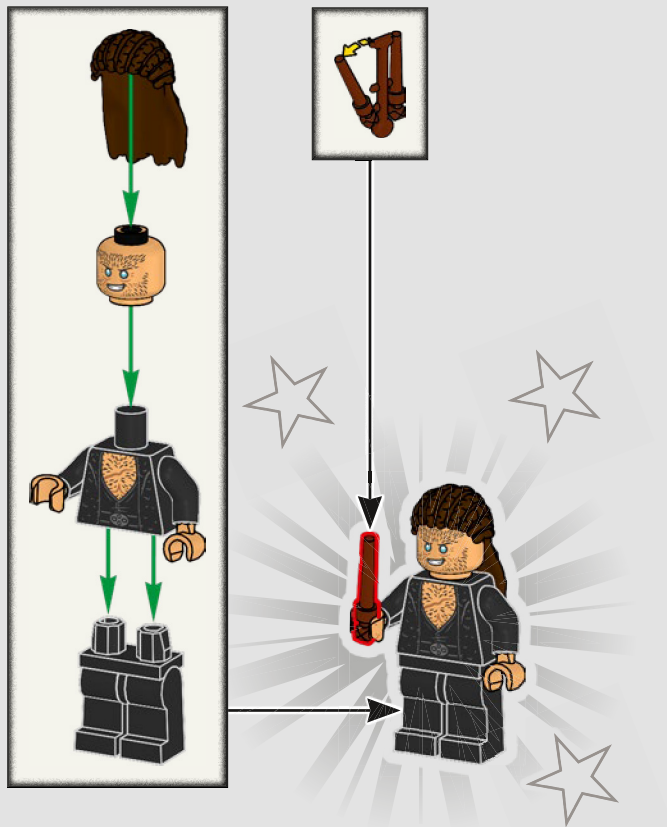

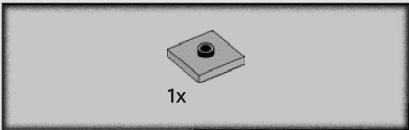

102

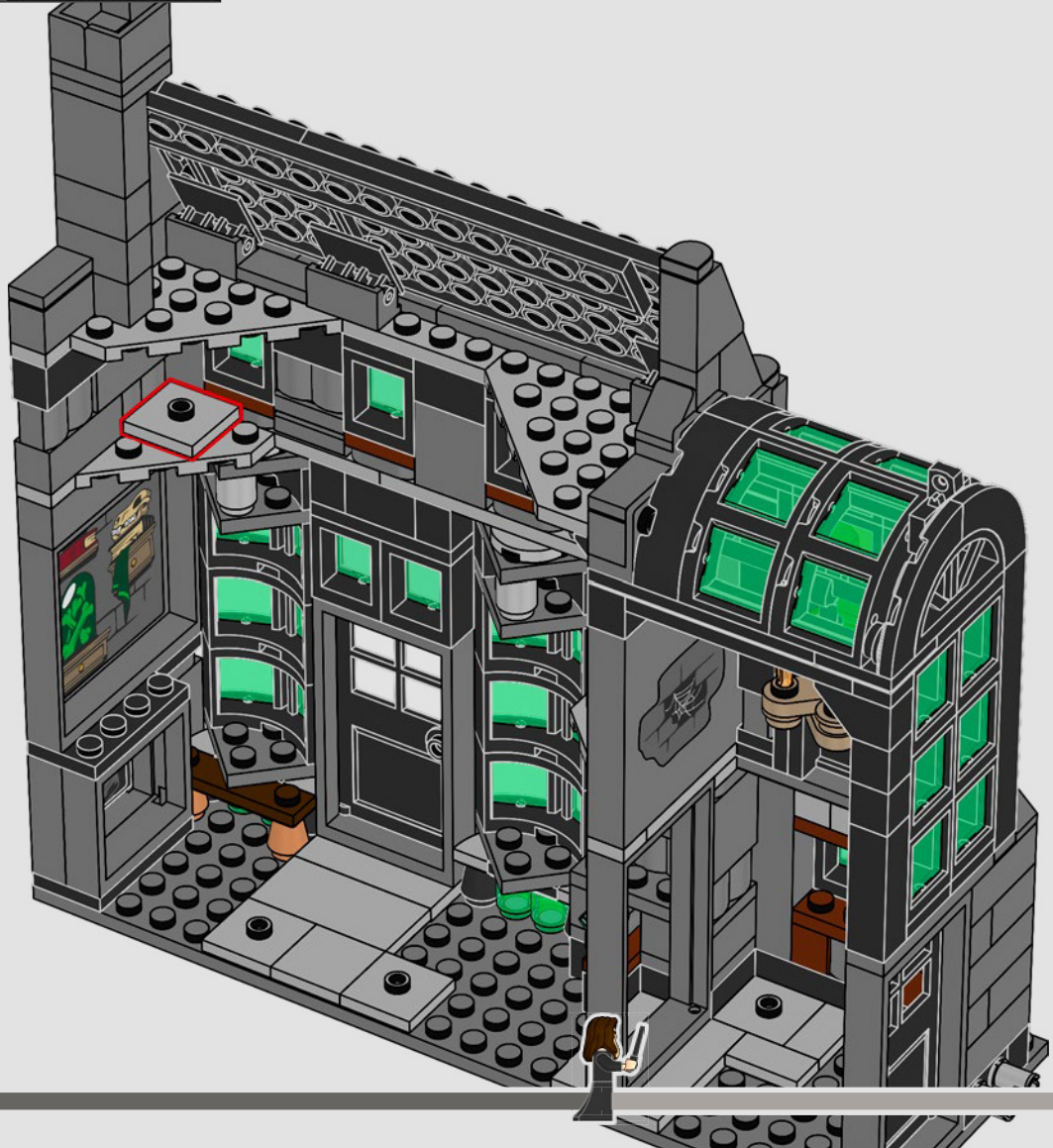

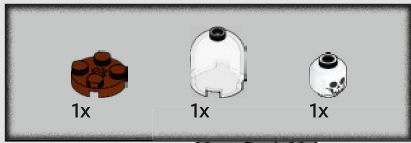

103

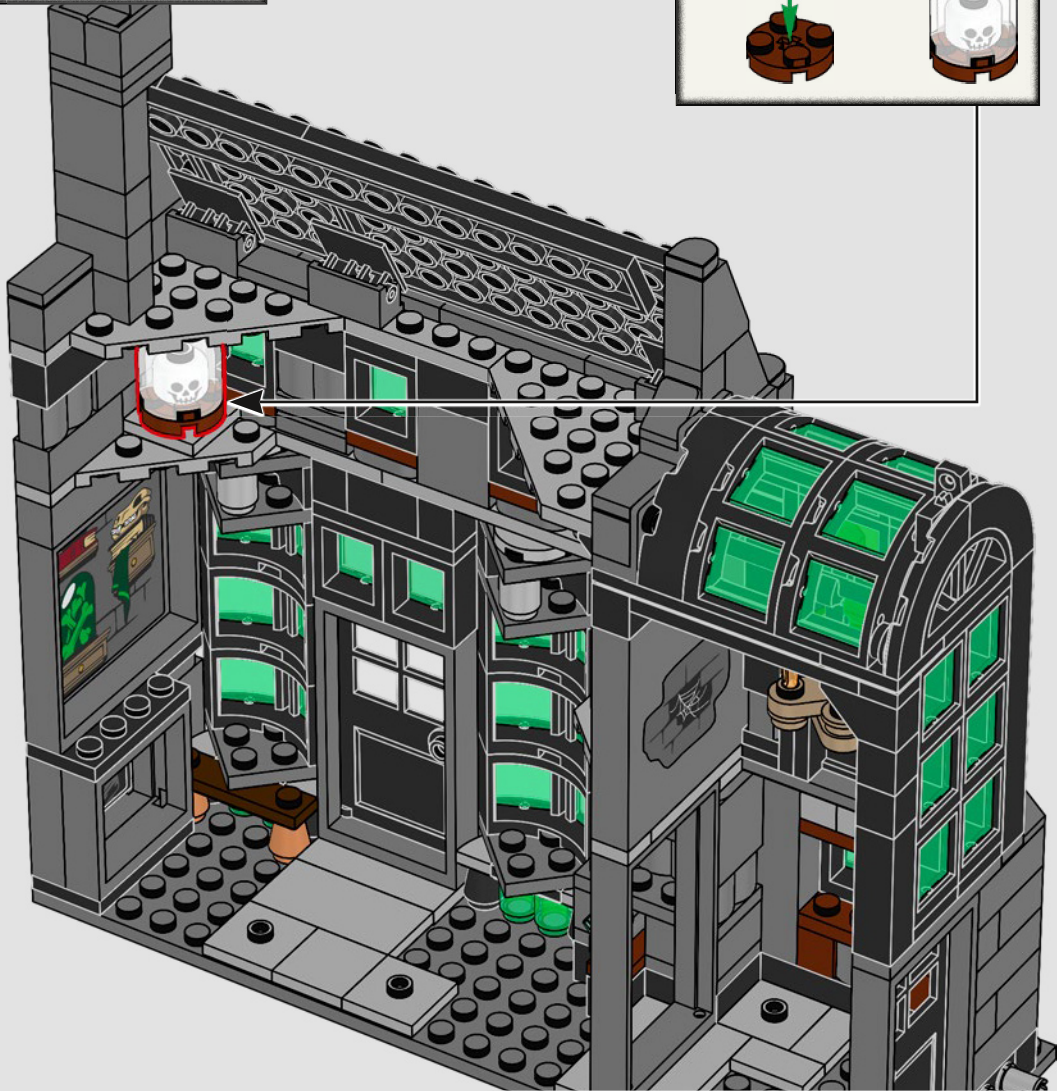
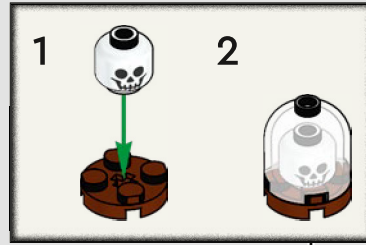



1x



1x

104



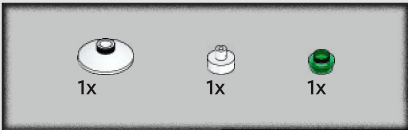

105

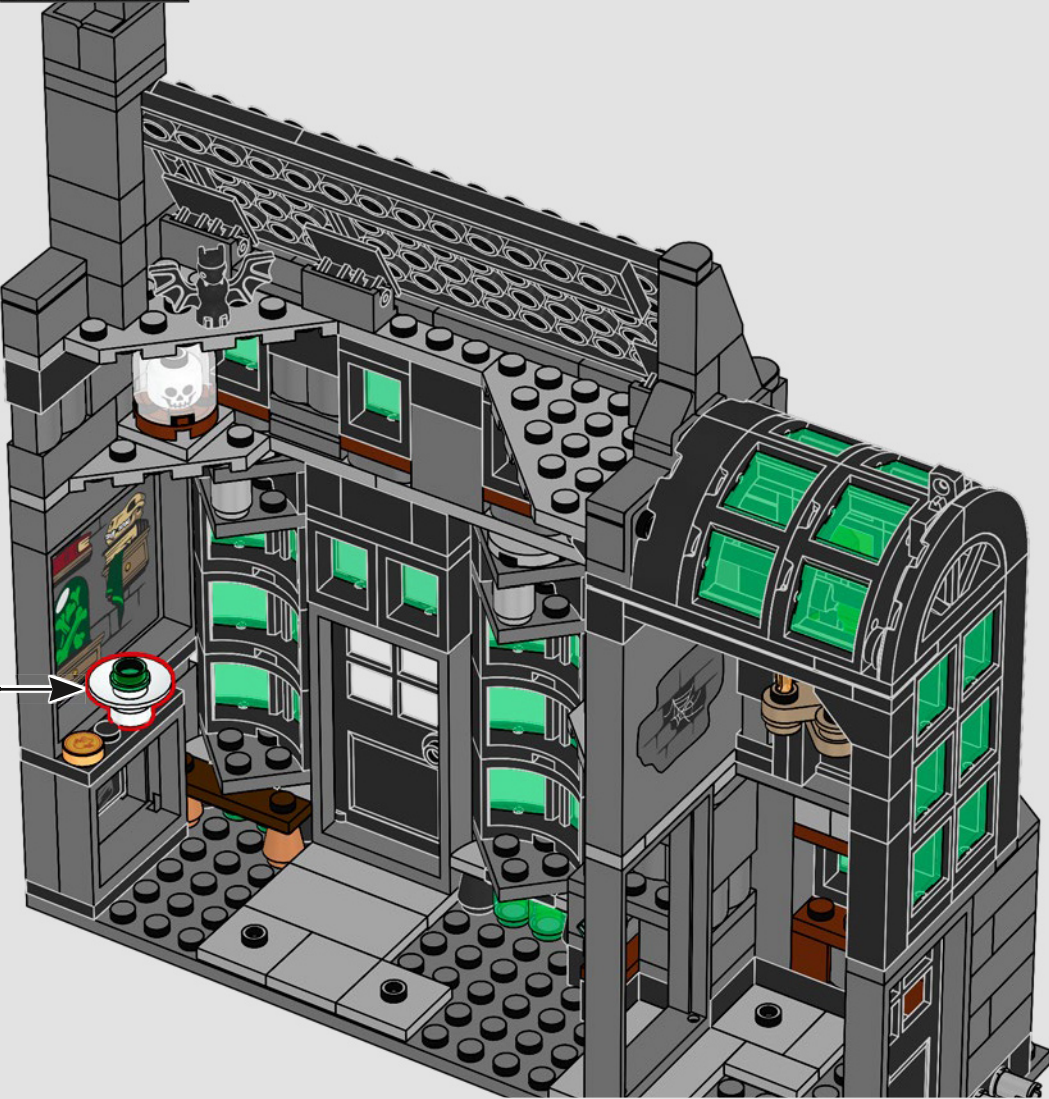
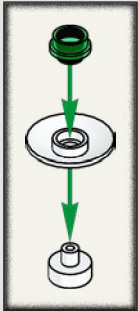

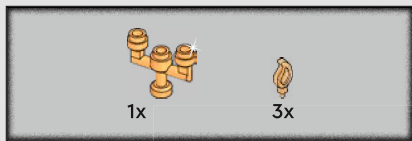

106

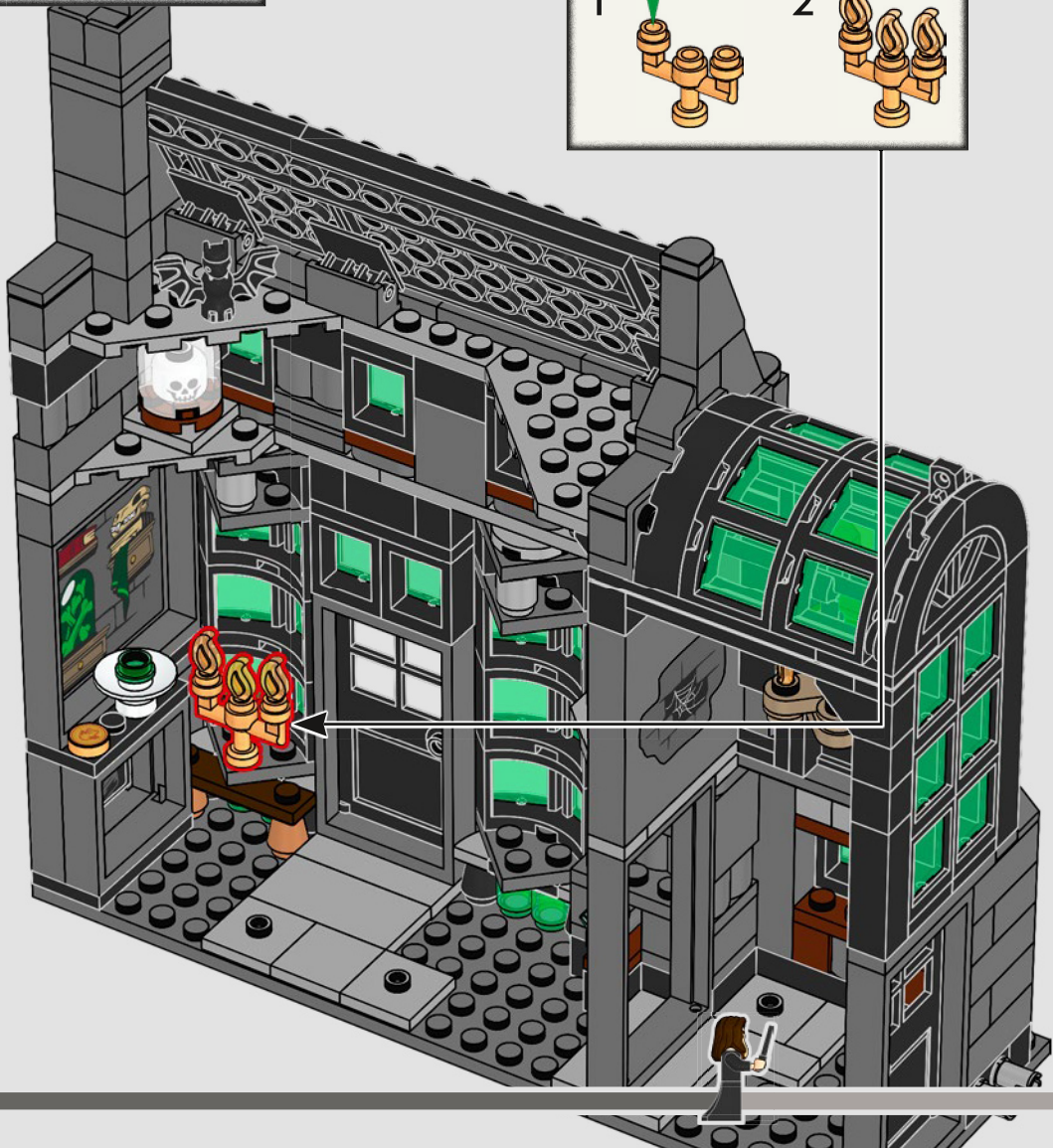
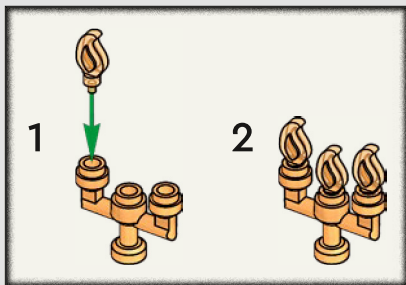

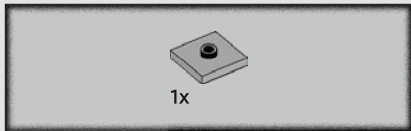

107

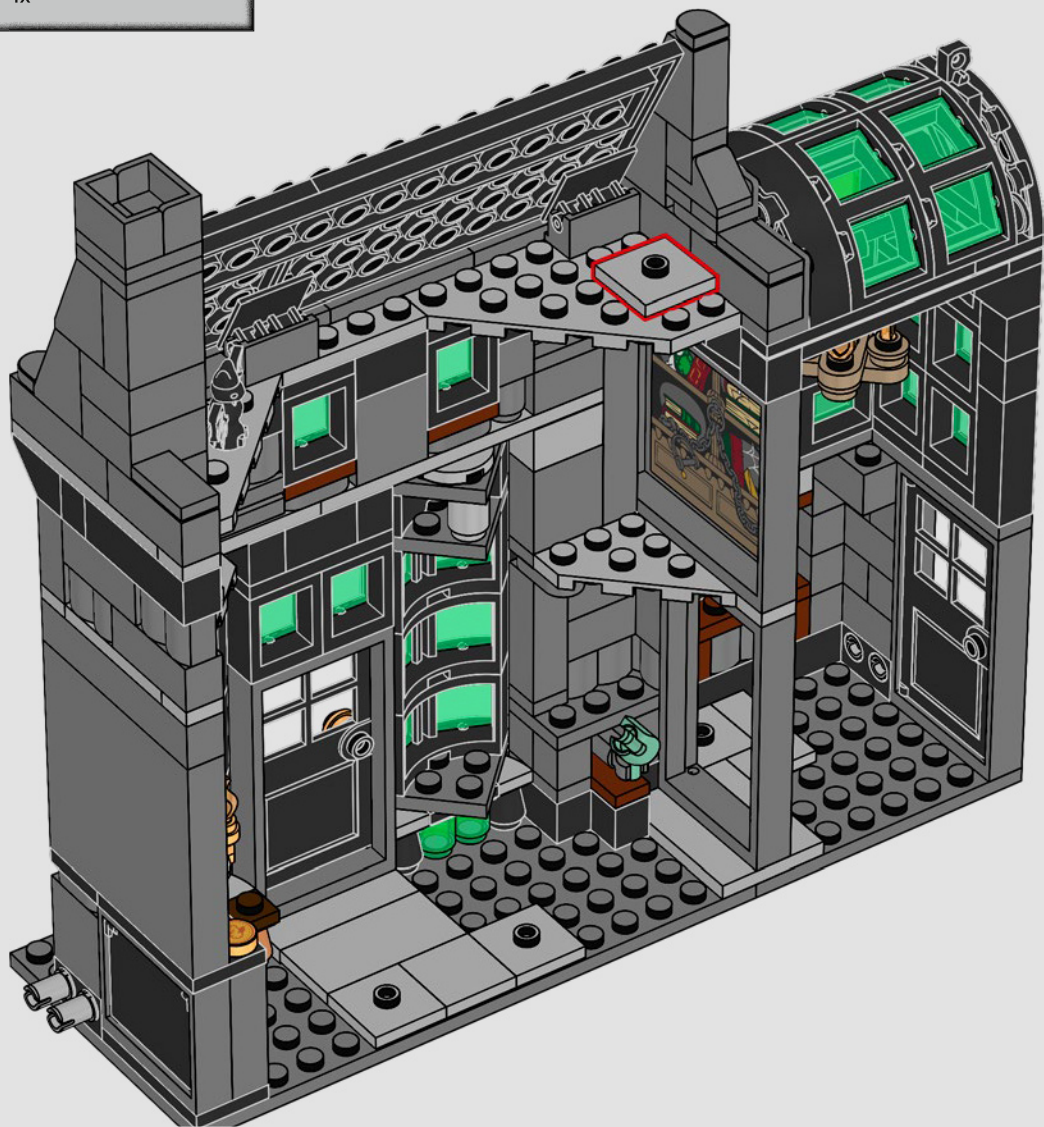

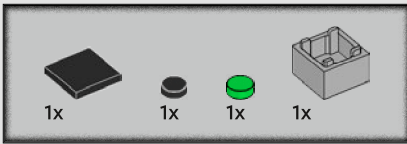

# 108

1

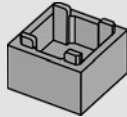

2

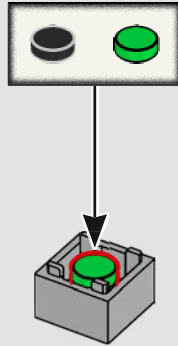

3

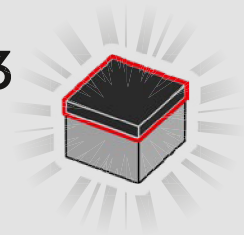

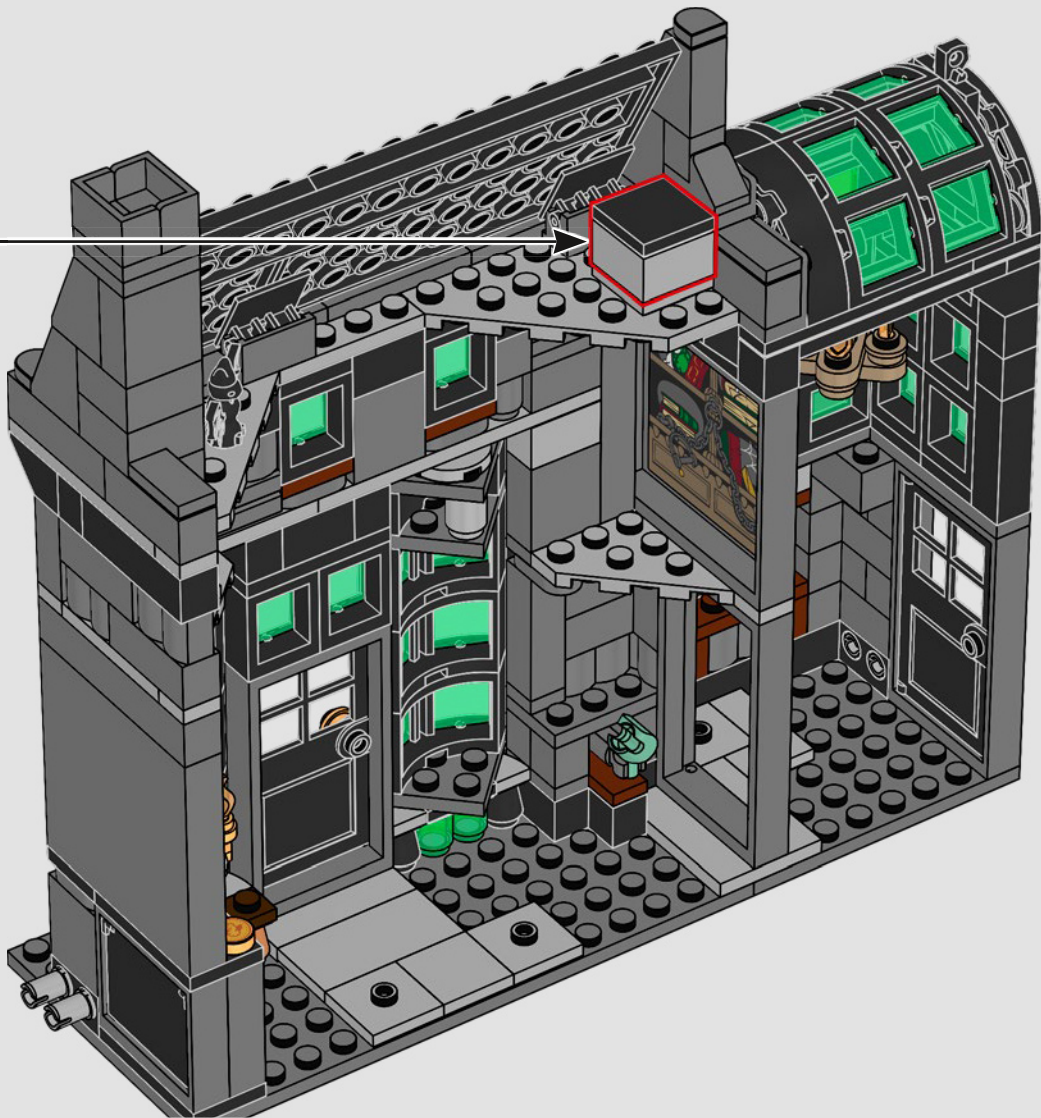

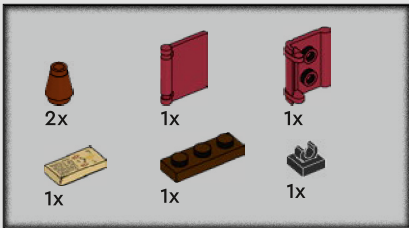

# 109

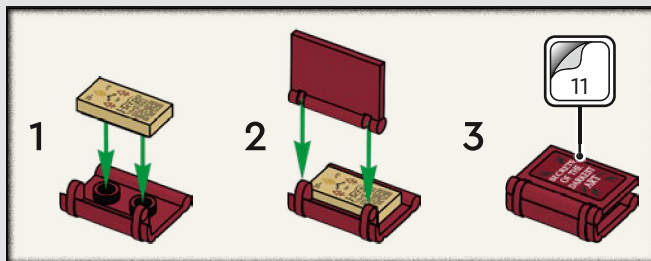

1



2

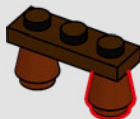

3



4



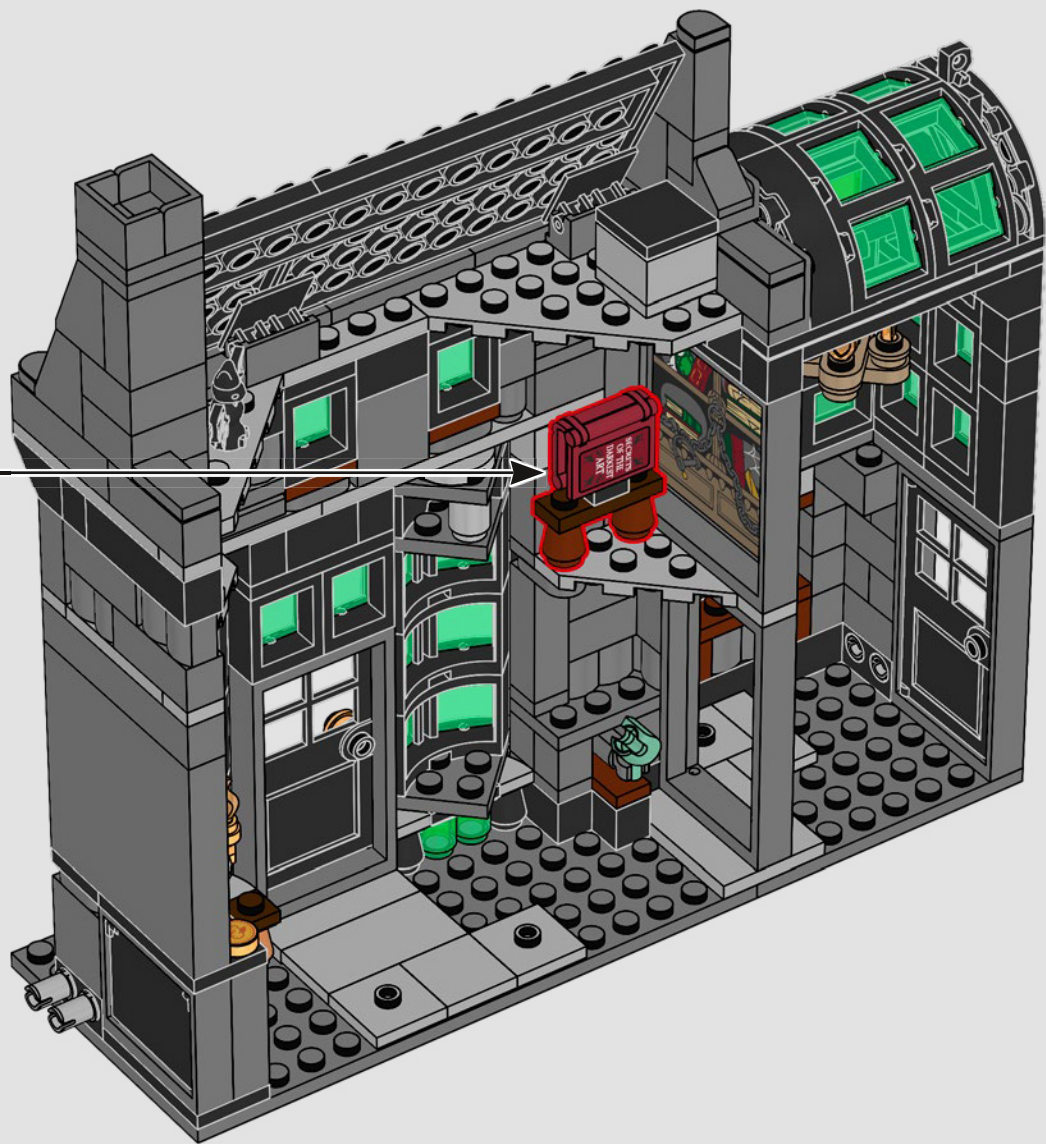



110

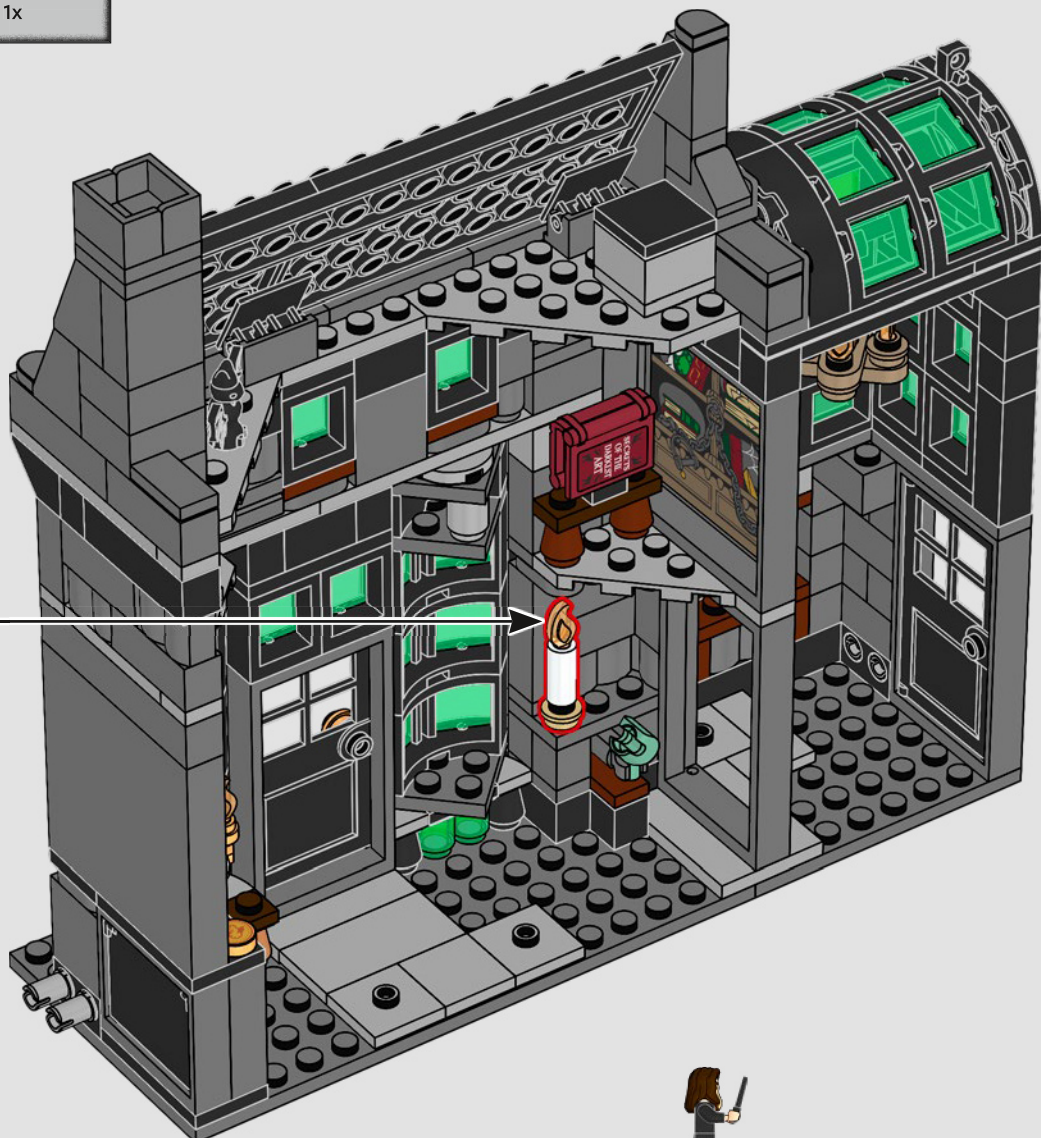



1x

111



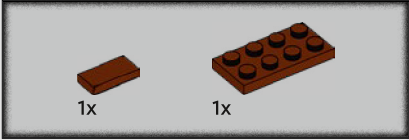
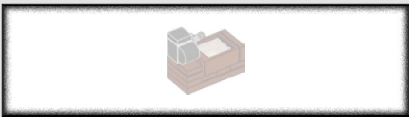

112

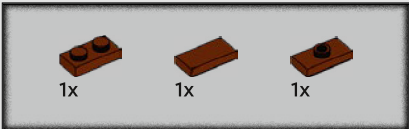
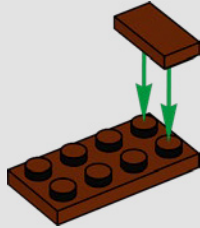

113

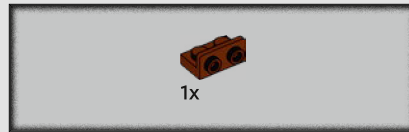
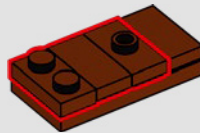

114

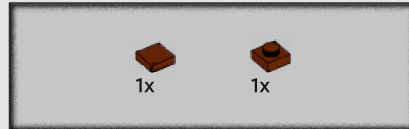
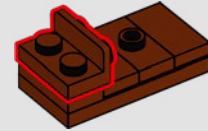

115

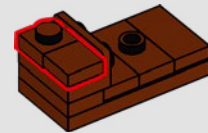

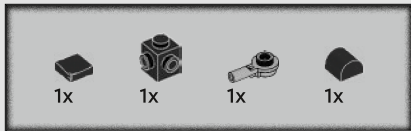

116

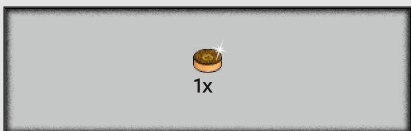
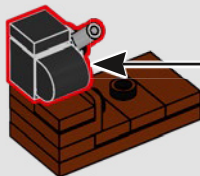
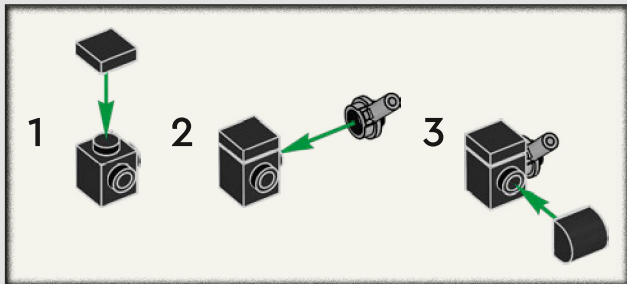

117

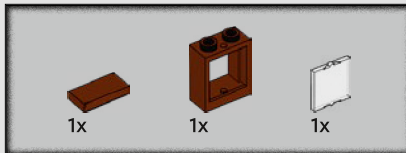
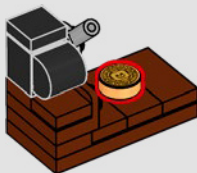

118

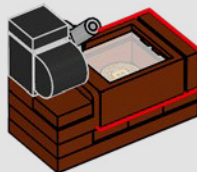
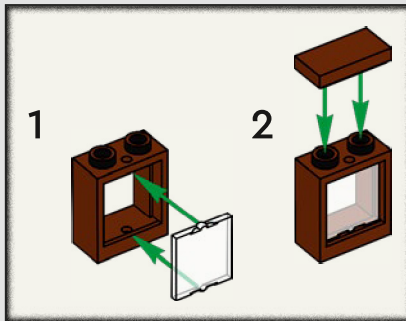

119





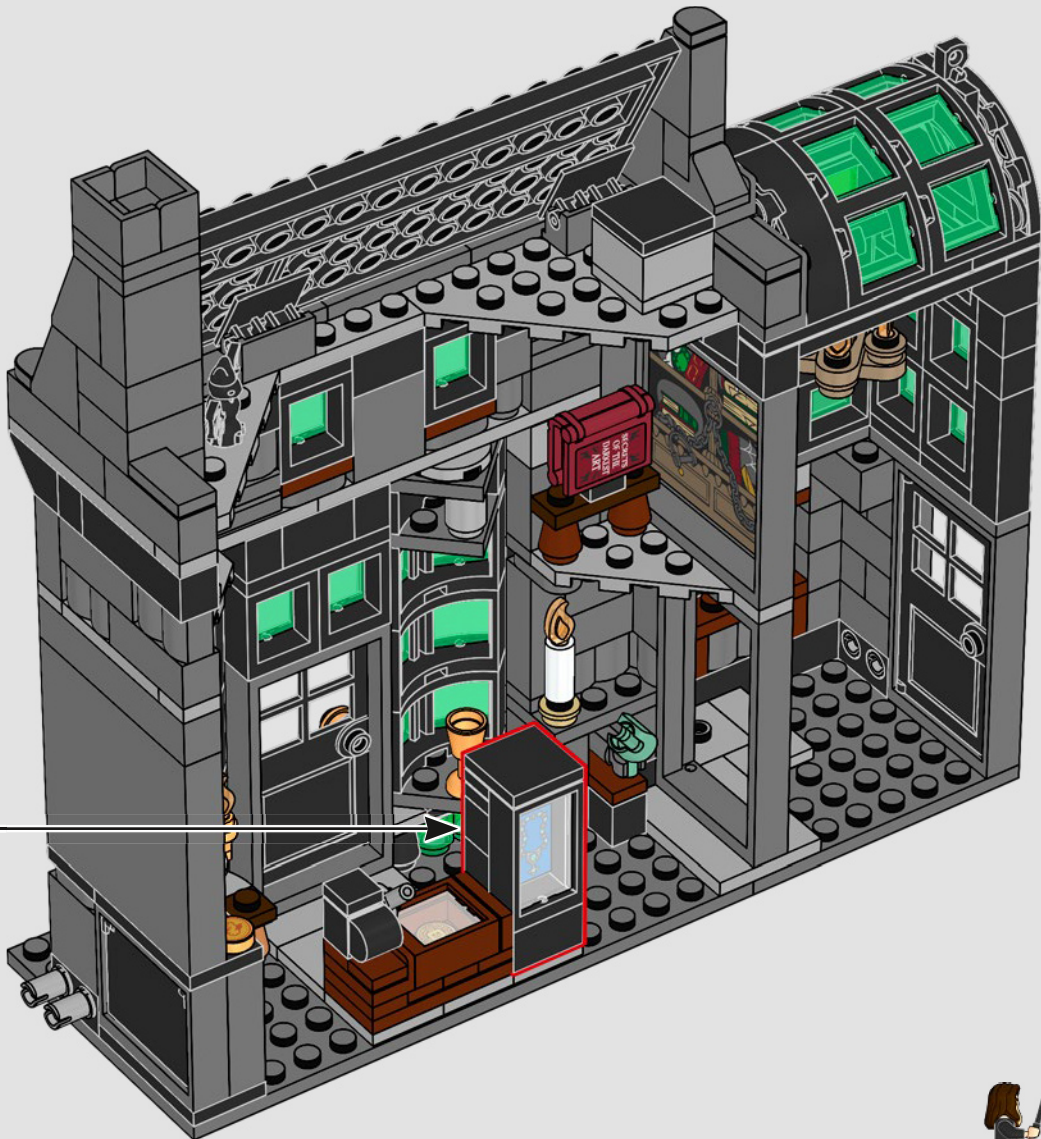

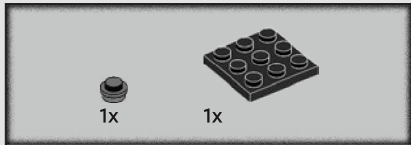

121

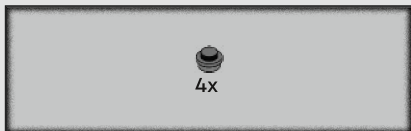
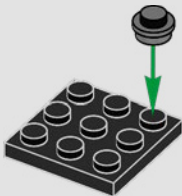

122

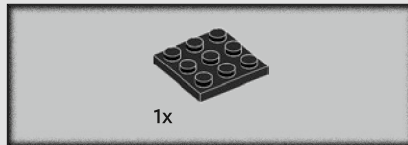
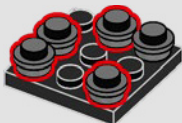

123

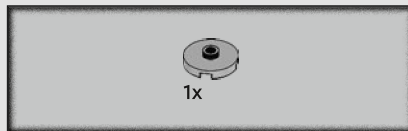

124

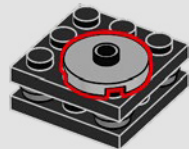

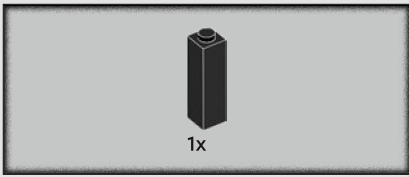

125

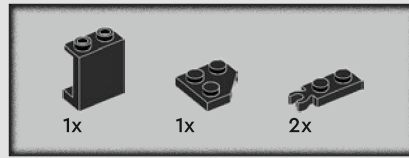
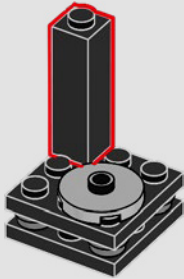

126

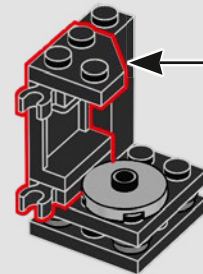
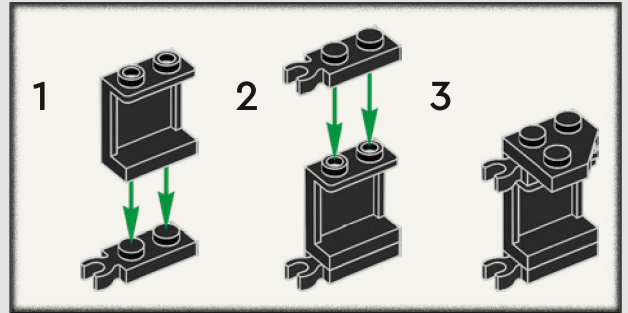

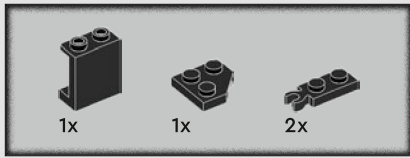

127

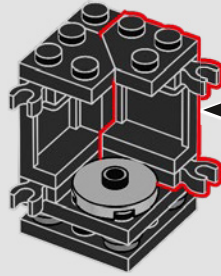
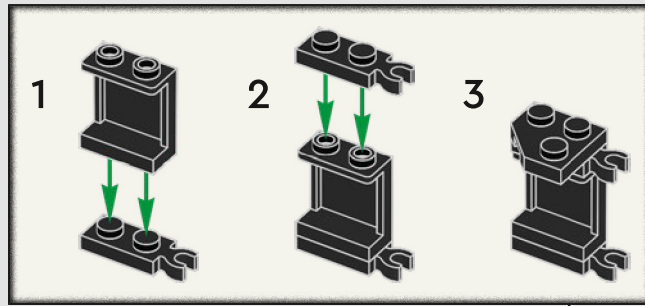

128

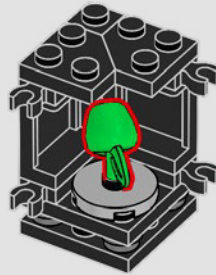

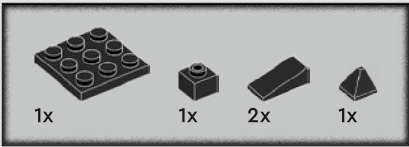

129

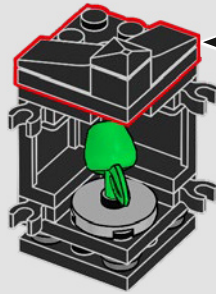
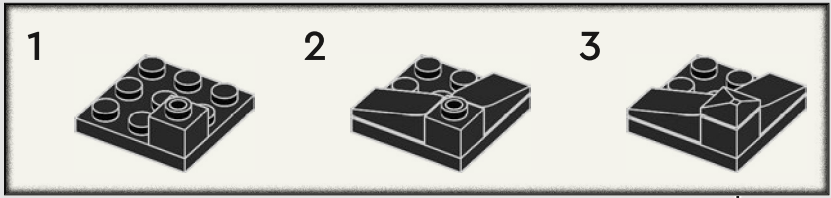

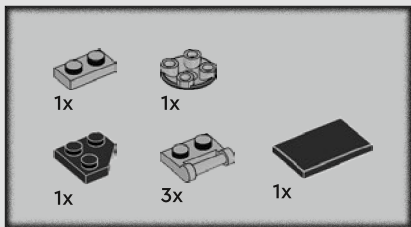

130



1



2

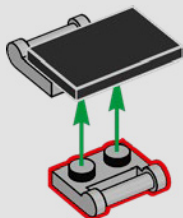

3

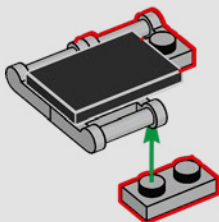

4

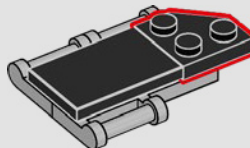

5

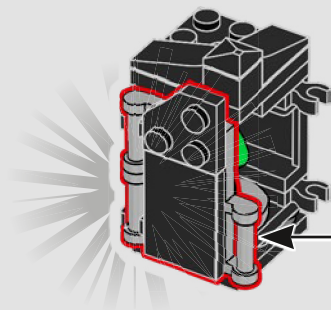
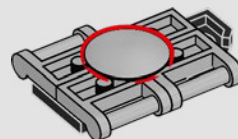

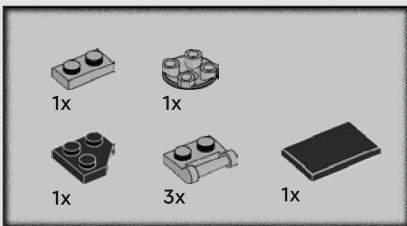

# 131



1



2

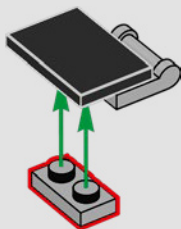

3

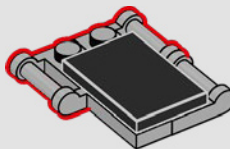

4

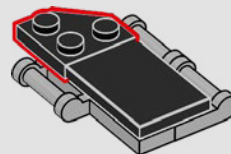

5

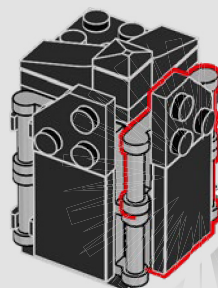
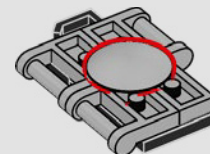

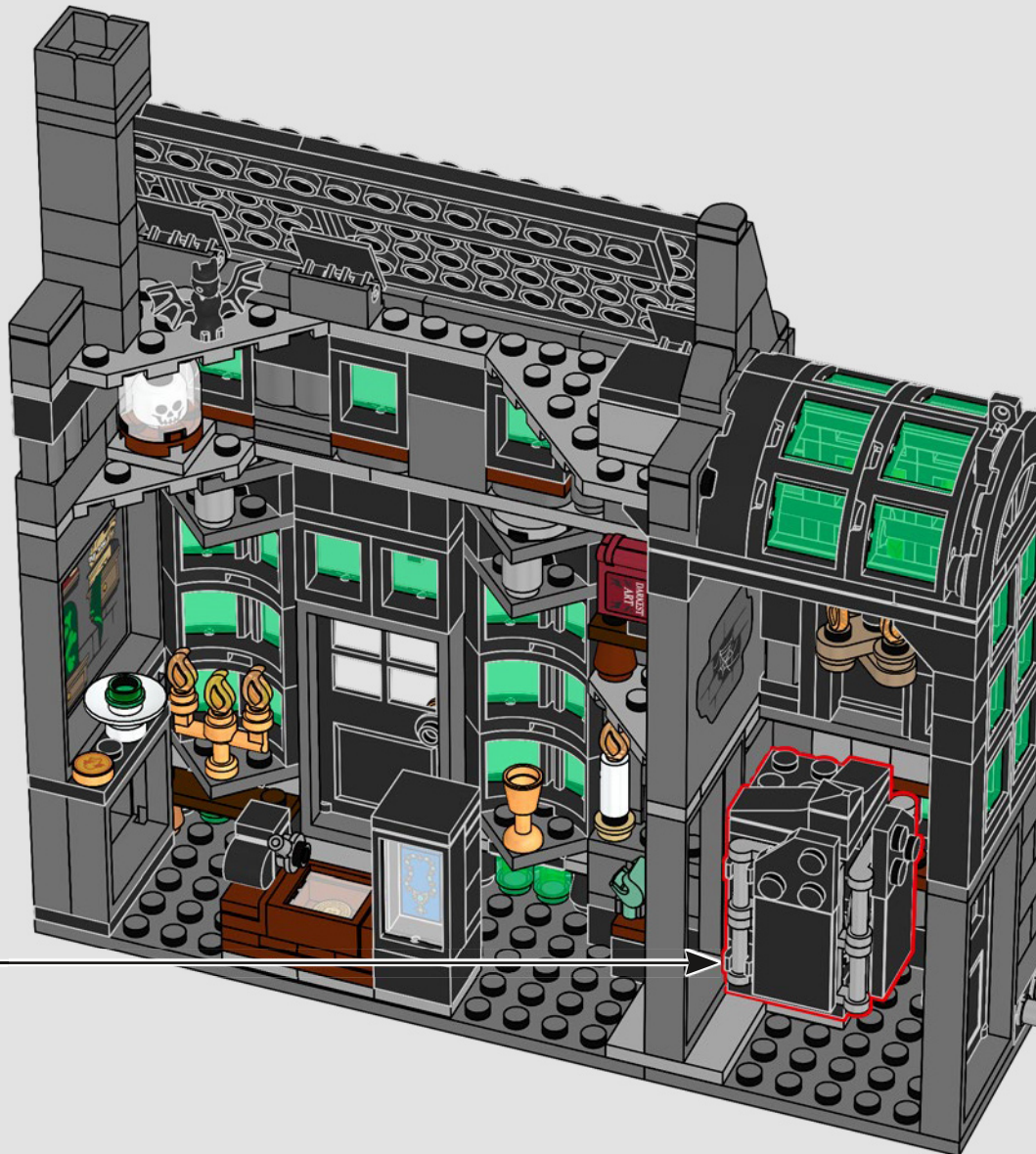





# Harry Potter™

Build the most detailed Hogwarts™ Castle  
 Baue das detailreiche Schloss Hogwarts™  
 Construisez le château de Poudlard le plus détaillé  
 Costruisci il Castello di Hogwarts™ più dettagliato di sempre  
 Construye el Castillo de Hogwarts™ más detallado  
 Construa o mais detalhado Castelo de Hogwarts™

## 拼搭精美的霍格沃茨™城堡

Zbuduj najbardziej szczegółowy zamek Hogwarts™  
 Postavte si ten najdetailnejši Bradavičjki hrad  
 Postavte si najdetailnejši Rokfortský hrad  
 Építsd meg a legrészletgazdagabb Roxfort™ kastélyt!  
 Побудуйте найдетальніший замок Гогвортс  
 Construieste cel mai detaliat Castel Hogwarts™  
 Постройте най-детальнішу версію на замка Хогвортс  
 Uzbūvē visdetalizētāko Cūkkārpas pili  
 Pane kokku kõige üksikasjalikum Sigatüüka™ loss  
 Sukonstruokite nepaprasitai detaļiā Hogvartso piļi  
 En detayli Hogvarts™ Şatosunu inşa et

Each set sold separately and available for different periods of time / Jedes Set ist separat und in unterschiedlichen Zeiträumen erhältlich. / Chaque set est vendu séparément et sera disponible à des périodes différentes. / Ogni set è venduto separatamente ed è disponibile per periodi di tempo diversi. / Cada set se vende por separado y está disponible durante un cierto periodo de tiempo. / Os sets são vendidos separadamente e estão disponíveis por diferentes períodos de tempo. / 每款套装于不同时间段单独出售。 / Zestawy są sprzedawane osobno i są dostępne w różnym czasie / Każdą stavebnice se prodává samostatně a je k dispozici v různých časových obdobích / Každá stavebnice sa predáva samostatne a je k dispozícii v rôznych časových obdobiach / Minden egyes készlet külön-külön és más-más időszakban kapható. / Кожен набір продається окремо і доступний протягом різних періодів часу / Seturile se vând separat și sunt disponibile pentru perioade diferite de timp / Всеки комплект се продава отделно и е наличен за различен период от време. / Katrs komplekts tiek pārdots atsevišķi, un to pieejamības periodi atšķiras. / Kõik komplektid on müügil eraldi ja saadaval erinevates ajavahemikes. / Kiekvienas rinkinys parduodamas atskirai ir tik ribotą laiką / Her set ayrı satılır ve farklı sürelerde mevcuttur



76435



76463



76445



Build the most detailed  
**HOGWARTS™ CASTLE**



76454



76473



76447



# Collectable PATRONUSES



76464



76460



76473



76463



25  
YEARS OF  
MAGIC

76475



76467



76471



76478

25 Years of Magic / 25 Jahre Magie / 25 ans de magie / 25 anni di Magia /  
 25 Años de Magia / 25 Anos de Magia / 25 年魔法 / 25 lat magii /  
 25 let kouzel / 25 rokov kúziel / A varázslat 25 éve / 25 rokov magii /  
 25 de ani de magie / 25 години магия / 25 magijos gadi / 25 aastat maagiat /  
 25 magijos metai / Sihirdi 25 Yil

Each set sold separately and available for different periods of time / Jedes Set ist separat und in unterschiedlichen Zeiträumen erhältlich. / Chaque set est vendu séparément et sera disponible à des périodes différentes. / Ogni set è venduto separatamente ed è disponibile per periodi di tempo diversi. / Cada set se vende por separado y está disponible durante un cierto periodo de tiempo. / Os sets são vendidos separadamente e estão disponíveis por diferentes períodos de tempo. / 每款套装于不同时间段单独出售。 / Zestawy są sprzedawane osobno i są dostępne w różnym czasie. / Každá stavebnice se prodává samostatně a je k dispozici v různých časových obdobích / Každá stavebnica sa predáva samostatne a je k dispozícii v rôznych časových obdobiach / Minden egyes készlet külön-külön és más-más időszakra kapható. / Кожен набір продається окремо і доступний протягом різних періодів часу / Seturile se vând separat și sunt disponibile pentru perioade diferite de timp / Всеки комплект се продава отделно и е наличен за различен период от време. / Kats komplekts tiek pārdots atsevišķi, un to pieejamības periodi atšķiras. / Koik komplektid on müügil eraldi ja saadaval erinevates ajavahemikes. / Kiekvienas rinkinys parduodamas atskirai ir tik ribotą laiką / Her set ayrı satılır ve farklı sürelerde mevcuttur

Collectable Patronuses / Patronusse zum Sammeln /  
 Des Patronus à collectionner / Patronus collezionabili /  
 Patronus coleccionables / Patronus coleccionáveis /  
 Patronus do kolekcionowania / Sběratelští patroni / Zberateľské  
 patronusy / Gyűjthető patronusok / Колекційні  
 патронуси / Figurine Patronus de colecție /  
 Колекционерски фигури на покровители /  
 Kolekcionerjami aizstāvji / Kogutavad Patronused /  
 Kolekciniai Gynėjai / Koleksiyonluk Patronuslar

1x  
6234807

1x  
6186681

1x  
6630910

1x  
6388018

1x  
474001

1x  
6443061

3x  
6463667

2x  
4565452

1x  
6597976

1x  
6443062

1x  
6609757

1x  
6290456

3x  
614126

4x  
6168646

1x  
6284070

1x  
6186675

8x  
4529236

3x  
6439039

1x  
6510193

2x  
6270027

8x  
300526

3x  
307026

2x  
6065496

2x  
6228987

7x  
302426

2x  
4504382

1x  
6335388

2x  
6273589

4x  
6172383

1x  
6388352

1x  
6573684

2x  
6187572

1x  
4526110

1x  
6510125

1x  
4177431

2x  
6510061

1x  
6371584

3x  
6210270

4x  
6542374

1x  
4109810

5x  
6102341

1x  
6269081

7x  
4548180

3x  
6195325

2x  
9339

23x  
6382697

12x  
302326

5x  
3200026

1x  
6330197

4x  
366526

3x  
6475339

1x  
6266244

1x  
300426

1x  
306926

1x  
6468344

4x  
6174243

2x  
4593678

2x  
6513918

1x  
4106513

1x  
6219463

1x  
6428168

2x  
4225201

1x  
6093525

4x  
6350725

3x  
6425507

1x  
4565323

1x  
6133722

3x  
6191630

1x  
300326

2x  
306826

3x  
4124096

4x  
4567436

2x  
362326

8x  
4558170

1x  
6374765

1x  
6532709

1x  
6610803

3x  
4521208

1x  
6514144

3x  
6116604

4x  
6162892

1x  
301026

3x  
371026

1x  
6177083

1x  
6115117

1x  
6254045

1x  
6597975

2x  
6337273

10x  
6473450

4x  
6360129

3x  
6174917

2x  
6434275

1x  
300126

3x  
302026

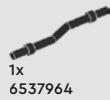

1x  
6537964



1x  
6170421



1x  
6172984

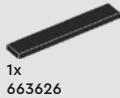

1x  
663626



4x  
366626

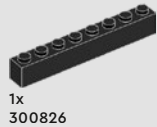

1x  
300826



1x  
416226



2x  
346026

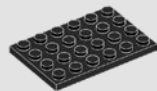

1x  
303226

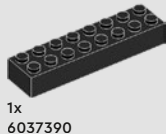

1x  
6037390

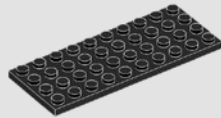

1x  
303026

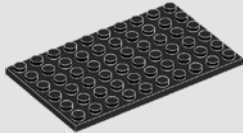

1x  
303326

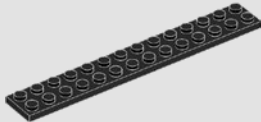

1x  
6001494



1x  
6135287



1x  
6353793



1x  
6413063



1x  
6093518



2x  
6510164



3x  
6510188



5x  
6514136



1x  
6581359



1x  
6514278



1x  
6581671



1x  
6514022



4x  
6514234



1x  
6514057



39x  
6605294

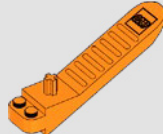

1x  
6240515



1x  
6610699



1x  
4620077



2x  
6138232



1x  
4267425



6x  
6177142



7x  
6198156



2x  
6417947



2x  
6212055



2x  
6062089



3x  
6142245



2x  
6262031



4x  
6529299



2x  
4620992



4x  
6421518



5x  
6300322



1x  
6270031



1x  
4524098



2x  
6449564



2x  
6328307



1x  
6605243



1x  
6433523



2x  
6458394



1x  
6522565



1x  
6522536



8x  
6514274



1x  
6516056



2x  
4529242



4x  
6270028



1x  
4211288



1x  
4221744



1x  
4211159



3x  
4211180



2x  
4211222



4x  
4211151



1x  
6382102



1x  
4211150



1x  
6092590



1x  
6174856



1x  
6266075



3x  
4645103



1x  
6610795



1x  
6116613



4x  
4211186



1x  
6271165



2x  
4211412

1x 6510189	1x 4211350	5x 4211429		2x 6225494	1x 6069164	1x 4211060
4x 4211415	5x 4211614	5x 4211428	2x 4211520	3x 6321350	6x 6013658	3x 4211094
1x 4558953	1x 6015344	1x 6310369	1x 4211425	1x 6531562	5x 4211052	4x 4211109
7x 4211399	1x 4211440	1x 6310369	1x 4211425	1x 6350724	7x 4211135	1x 4211054
1x 6061702	2x 4211398	2x 4160560	1x 6336970	10x 6221607	2x 6275131	2x 4521187
1x 6436419	1x 4657366	1x 4211394	3x 4211090	2x 6296892	1x 6473748	6x 4211104
2x 6227897	6x 4244627	1x 4211395	5x 4210633	17x 4211095	2x 6344754	1x 6149768
6x 4211807	7x 6126082	2x 4560183	14x 4211098	1x 4222693	5x 6605242	2x 4246896
3x 6183782	6x 6163990	2x 6079461	4x 4504378	7x 4210978	2x 4210762	4x 4211133
2x 4211475	1x 4211413	1x 6170418	1x 6396489	1x 6230233	1x 4211075	1x 6611096
2x 4278273	4x 4211353	2x 6170418	2x 6333129	2x 6335306	1x 4211075	10x 4212075
1x 4227657	2x 6212077	1x 4211438	2x 4210719	6x 4211063	2x 6308045	1x 4211105
1x 6320297	1x 6435835	1x 6106189	2x 4210690	2x 6000311	4x 4543086	2x 4211043
2x 4211414	1x 6435835			3x 4211066	1x 4210635	
4x 6396791	1x 4211815					



3x  
6092649



2x  
4211103



2x  
4551044



1x  
4211001



3x  
6262942



1x  
6506037



1x  
4211065



2x  
6413109



2x  
4211100

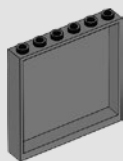

2x  
4505068



2x  
6186825



1x  
4211002

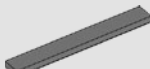

1x  
4211008



1x  
4211115



1x  
4210678



4x  
4211122



1x  
4210802

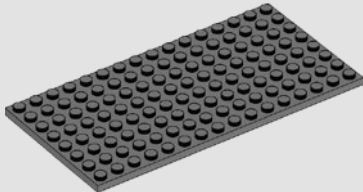

1x  
4654613



1x  
6309172



1x  
6266198



1x  
6597973



1x  
6258524



1x  
6192171



1x  
6163442



1x  
6636768



2x  
6445157



1x  
4523159



1x  
6531909



1x  
4505990



1x  
6317208



1x  
6326425



1x  
6270032



1x  
6610996



1x  
6609909



1x  
6523446



1x  
6174246



1x  
6404033



1x  
6518013



1x  
6570063



1x  
6605241



2x  
6532065



1x  
6510192



1x  
6433634



1x  
6234805



1x  
6363148



1x  
6214235



2x  
6398008



1x  
6610956



1x  
6584794



1x  
6531954



1x  
6597971



1x  
6610947



1x  
6610698



1x  
6610700

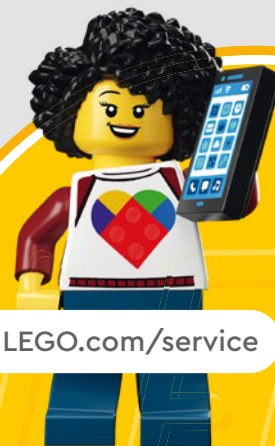

[LEGO.com/service](https://www.lego.com/service)

YOU COULD **WIN**

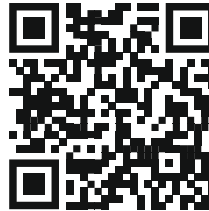

Scan this QR code or go to **LEGO.COM/PRODUCTFEEDBACK** and give us your short feedback about this LEGO® set for a chance to win a cool LEGO prize.

Terms and Conditions apply\*



**EN: YOU COULD WIN.** Terms and Conditions apply\* **DE: Du könntest GEWINNEN.** Es gelten die Teilnahmebedingungen\* **FR: TU POURRAIS GAGNER.** Des conditions s'appliquent\* **IT: Potresti VINCERE tu.** Termini e condizioni sono applicabili\* **ES: PUEDES GANAR.** Aplican términos y condiciones\* **PT: PODERÁ GANHAR.** Aplicam-se Termos e Condições\* **ZH: 轻松获奖. 条款和条件适用\*** **PL: Szansa na WYGRANĄ.** Obowiązuje regulamin\* **CS: Máte šanci VYHRÁT.** Platí všeobecné smluvní podmínky\* **SK: Máte šancu VYHRÁŤ.** Platia všeobecné zmluvné podmienky\* **HU: TE IS NYERHETSZ!** Felhasználási feltételek érvényesek\* **UA: ВИ МОЖЕТЕ ВИГРАТИ.** Застосовуються загальні положення та умови\* **RO: Ai putea CÂȘTIGA.** Se aplică termeni și condiții\* **BG: Можете да СПЕЧЕЛИТЕ.** Има определени правила и условия\* **LV: Tu vari LAIMĒT.** Ir spēkā noteikumi un nosacījumi.\* **ET: Sul on võimalus VÕITA.** Kehtivad tingimused\* **LT: Jūs galite LAIMĖTI.** Taikomos sąlygos\* **TR: KAZANABİLİRSİN.** Şartlar ve Koşullar geçerlidir\*

\*[LEGO.com/productfeedback-terms](https://www.lego.com/productfeedback-terms)