



BRICK HEADZ

40860



LEGO® Builder





Get excited about our new packaging!

We're switching from plastic to paper-based packaging. That's why you might find a mix of paper and plastic in our boxes!

Nos nouveaux emballages vous emballeront !

Nous passons des emballages en plastique aux emballages à base de papier. C'est pourquoi vous pourriez trouver un mélange de papier et de plastique dans nos boîtes !

¡Te presentamos nuestros nuevos empaques!

Estamos sustituyendo las bolsas de plástico por bolsas con base de papel. ¡Por eso, puedes encontrar una mezcla de papel y de plástico en nuestras cajas!

[LEGO.com/sustainable-packaging](https://www.lego.com/sustainable-packaging)



LEGO® Builder

BUILDER



Apple and the Apple logo are trademarks of Apple Inc., registered in the U.S. and other countries and regions. App Store is a service mark of Apple Inc. Google Play and the Google Play logo are trademarks of Google LLC. Tencent and the Tencent logo are trademarks of Tencent Inc.

LEGO.com/devicecheck

EN Ask parents' permission before going online | **DE** Eltern um Erlaubnis bitten, bevor du online gehst | **FR** Demande l'autorisation d'un parent avant d'aller en ligne | **IT** Chiedi il permesso ai tuoi genitori prima di andare online | **ES** Pídeles permiso a tus papás antes de conectarte a Internet | **PT** Pede autorização aos teus pais antes de ficares online | **ZH** 上网前应先征得父母的同意 | **PL** Poproś rodziców o zgodę, zanim wejdiesz do Internetu | **CS** Než půjdeš na internet, požádej rodiče o svolení | **SK** Skôr než pôjdeš na internet, vypýtaj si povolenie od rodičov | **HU** Kérj szülői engedélyt, mielőtt online csatlakoznál! | **UA** Запитуйте дозволу батьків, перш ніж користуватися інтернетом | **RO** Cere permisiunea părinților înainte de a te conecta online | **BG** Поискайте разрешение от родител, преди да влезете онлайн | **LV** Pirms došanās tiešsaistē palūdz atļauju vecākiem | **ET** Enne Interneti kasutamist küsi vanematelt luba | **LT** Prieš prisijungdami prie interneto, atsiklauskite tėvų | **TR** İnternete girmeden önce anne babandan izin iste



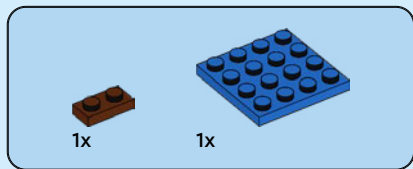

1

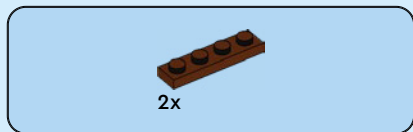
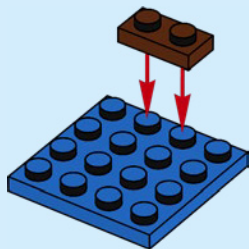

2

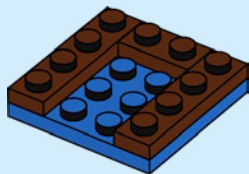



1x

3

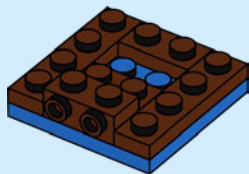

1x

4

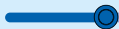
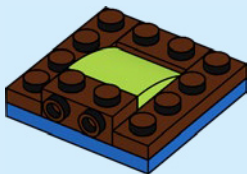



3x



3x

5

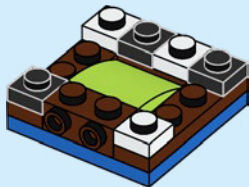

2x



2x

6

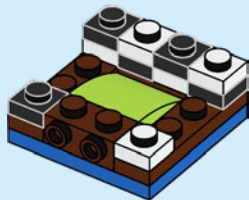



1x

7

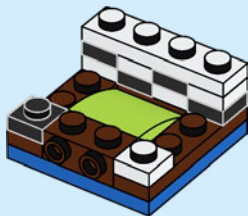

8



1x



1x

8

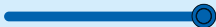
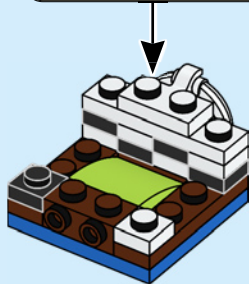
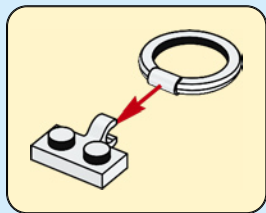



1x



1x

9

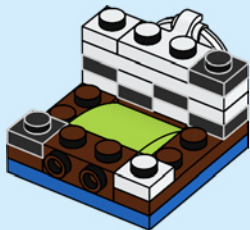

2x



2x

10

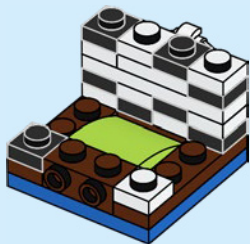



2x

11

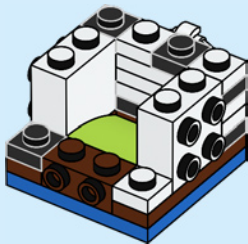

10



1x



1x



1x

12

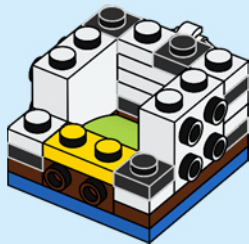



2x



1x

13

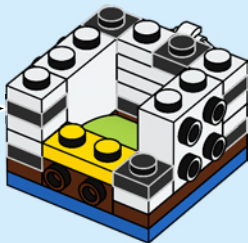
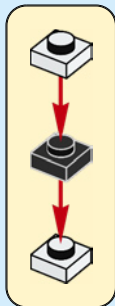



1x



1x

14

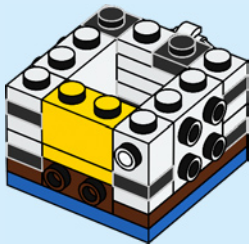

2x

15





1x



1x



1x

16

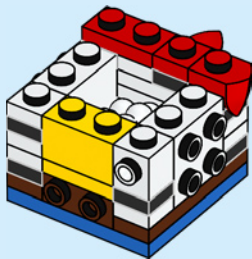

1x



1x

17

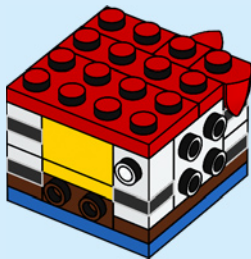



2x



2x



2x

18

1

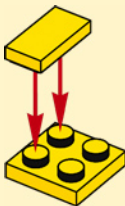

2

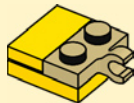

2x

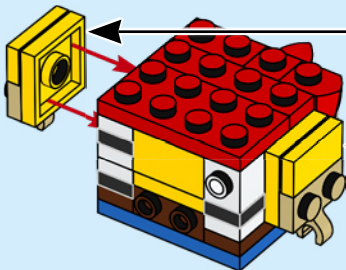



1x



2x

19

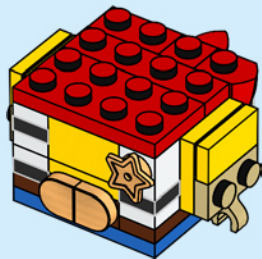

2x



1x

20

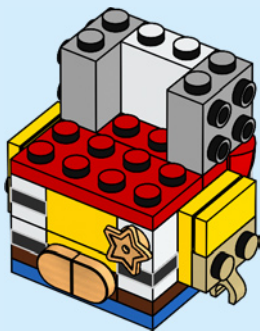



1x



1x



1x

21

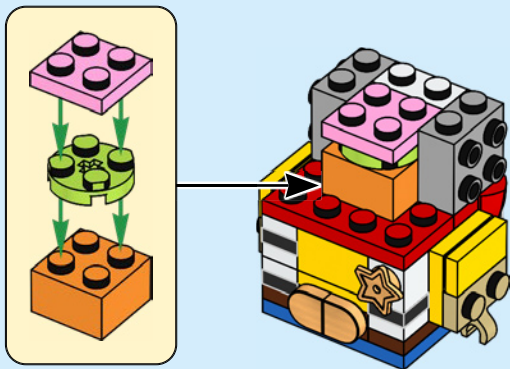



2x



1x

22

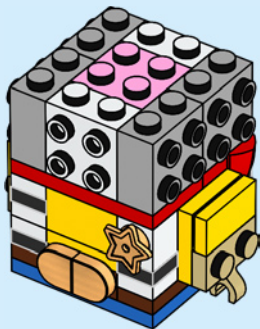

4x

23

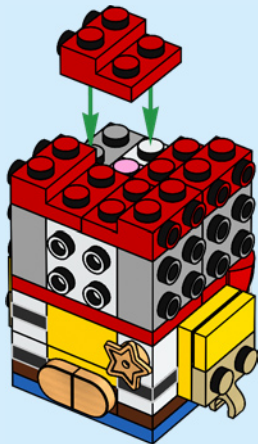



1x

24

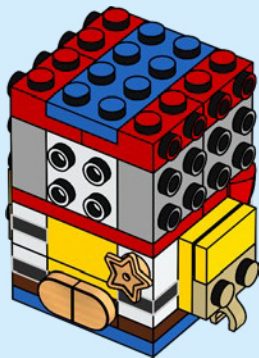



1x



2x



1x

25

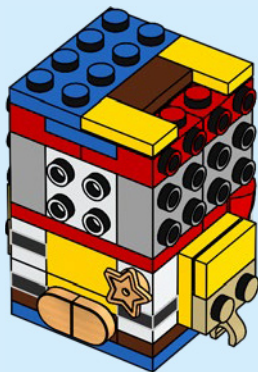

1x

26







1x

27

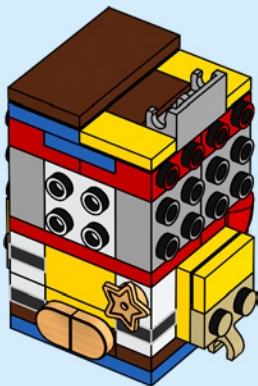

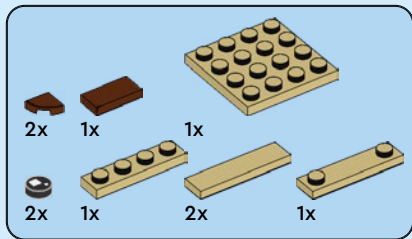

28

1

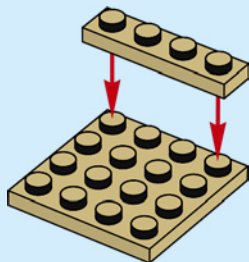

2

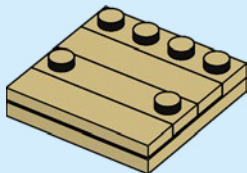

3

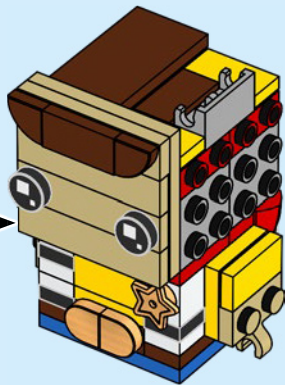
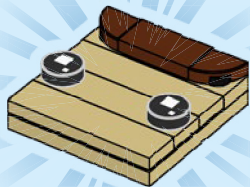



1x



1x



1x



1x

29

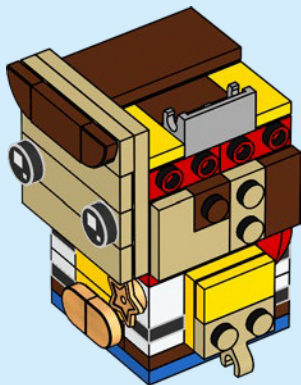



1x



1x

30

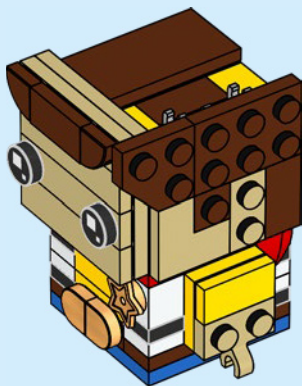

1x



1x



1x

31

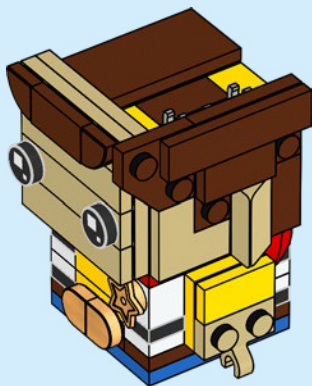



1x

32

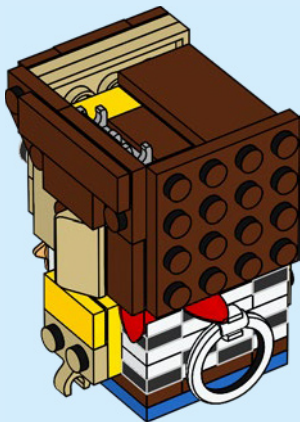
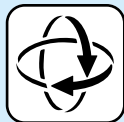



2x

33

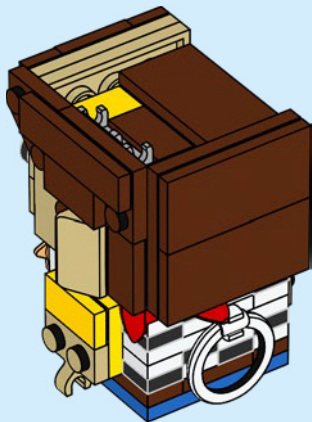

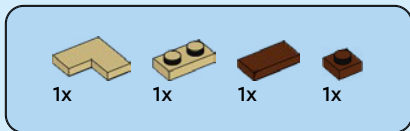

34

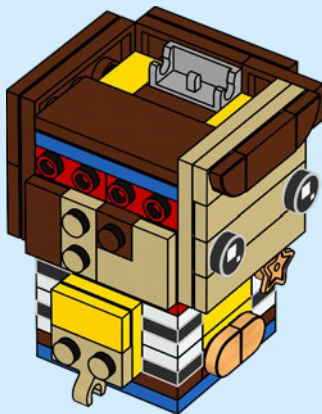



1x



1x

35

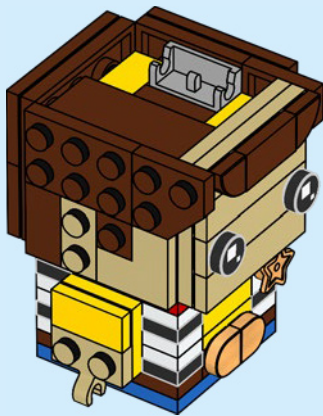

1x



1x



1x

36

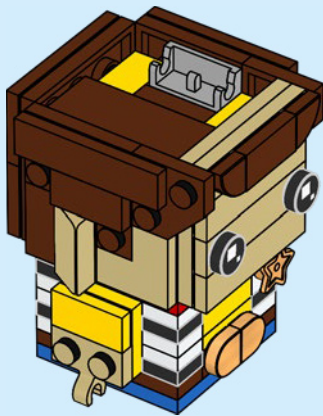



1x

37

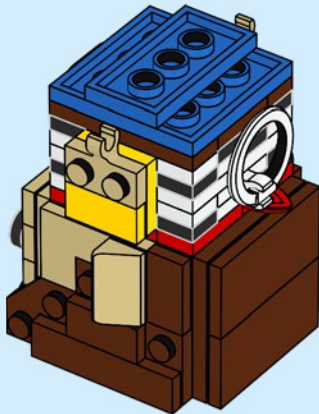



2x



2x



2x



2x

38

1

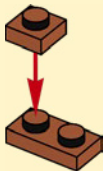

2



3

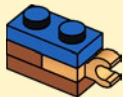

2x

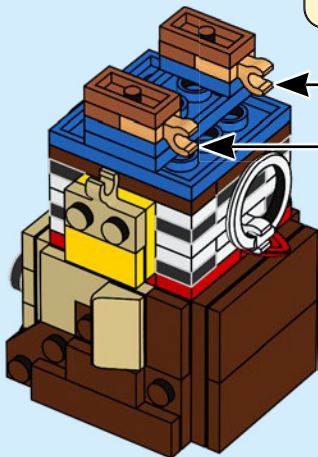

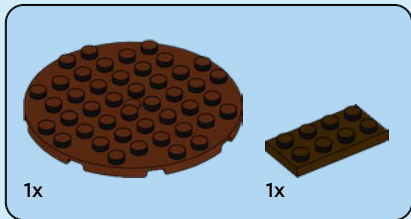

39

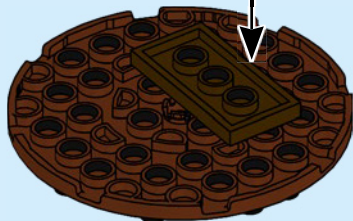
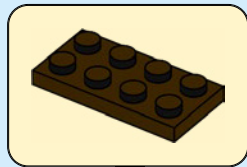

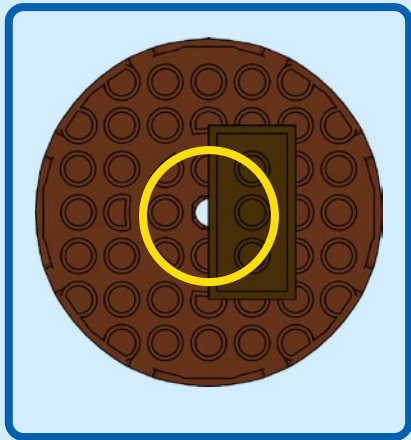

1x

40

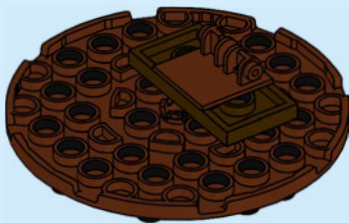



2x

41

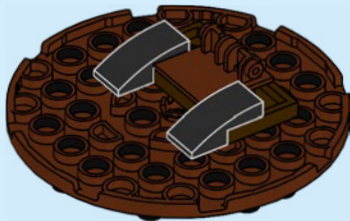

2x

42

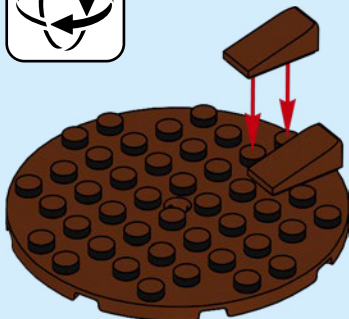
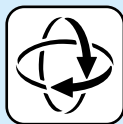



2x



2x

43

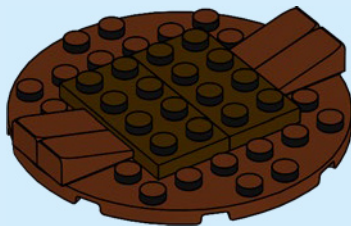

1x



1x

44

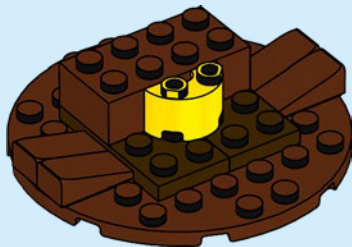



2x

45

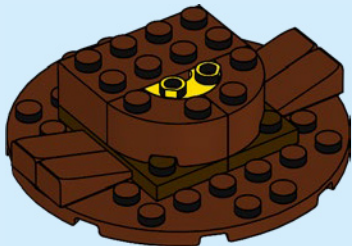



46

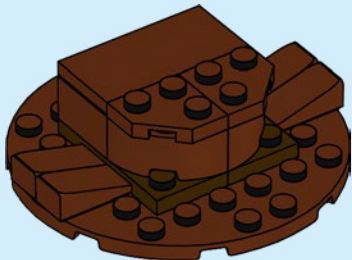

47



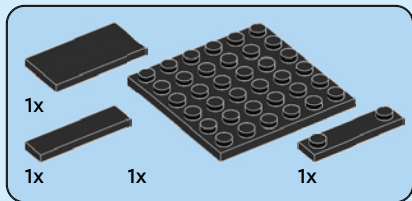

48

1

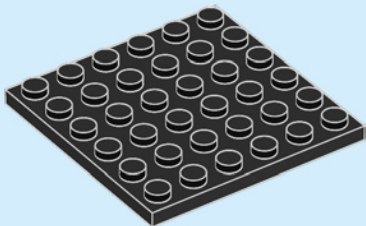

2

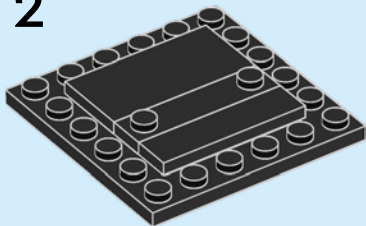





LEGO and the LEGO logo are trademarks of the/son des marques de commerce du/
son marcas registradas de LEGO Group. ©2026 The LEGO Group.

© Disney/Pixar



6650425

Rebuild
the
World™

