

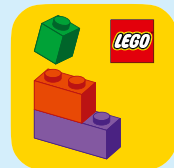

40902







LEGO® Builder



LEGO.com/sustainable-packaging



 ^{FR} **DONNEZ**
OU
RECYCLEZ

 OU  OU 

ASSOCIATION MAGASIN DÉCHÈTERIE

Adresses sur quefairedemesdechets.fr

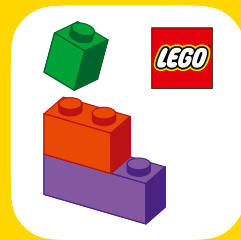

LEGO® Builder



BUILDER



Apple and the Apple logo are trademarks of Apple Inc., registered in the U.S. and other countries and regions. App Store is a service mark of Apple Inc. Google Play and the Google Play logo are trademarks of Google LLC. Tencent and the Tencent logo are trademarks of Tencent Inc.

[LEGO.com/devicecheck](https://www.lego.com/devicecheck)

EN Ask parents' permission before going online | DE Eltern um Erlaubnis bitten, bevor du online gehst | FR Demande l'autorisation d'un parent avant d'aller en ligne | IT Chiedi il permesso ai tuoi genitori prima di andare online | ES Pídeles permiso a tus papás antes de conectarte a Internet | PT Pede autorização aos teus pais antes de ficares online | ZH 上网前应先征得父母的同意 | PL Poproś rodziców o zgodę, zanim wejdiesz do Internetu | CS Než půjdeš na internet, požádej rodiče o svolení | SK Skôr než pôjdeš na internet, vypýtaj si povolenie od rodičov | HU Kérj szülői engedélyt, mielőtt online csatlakoznál! | UA Запитуйте дозволу батьків, перш ніж користуватися інтернетом | RO cere permisiunea părinților înainte de a te conecta online | BG Поискайте разрешение от родител, преди да влезете онлайн | LV Pirms došanās tiešsaistē palūdz atļauju vecākiem | ET Enne Interneti kasutamist küsi vanematelt luba | LT Prieš prisijungdami prie interneto, atsiklauskite tėvų | TR İnternete girmeden önce anne babandan izin iste



1

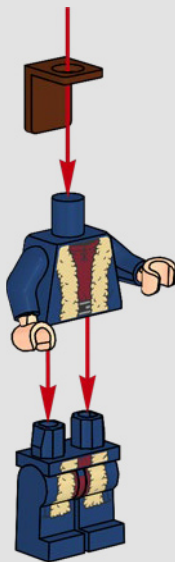

2

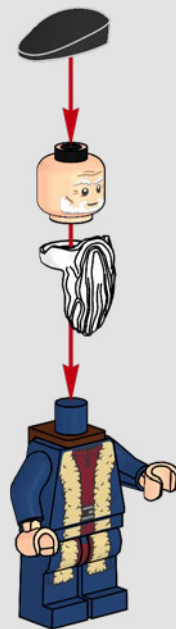

3



4

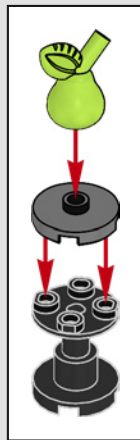

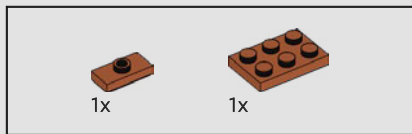

1

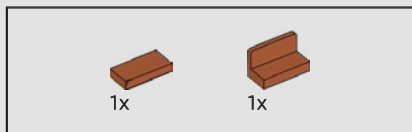
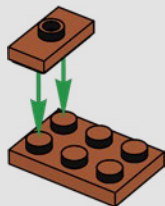

2

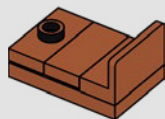

3

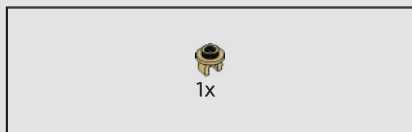
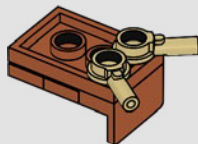

4

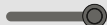
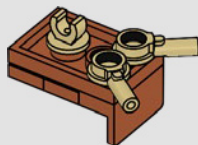

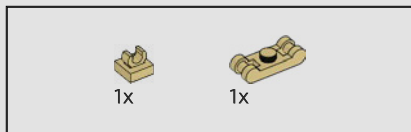

5

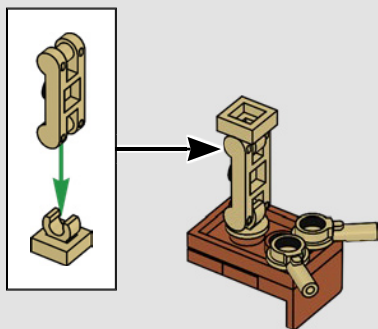

6

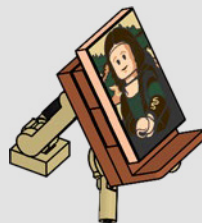

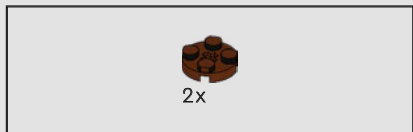
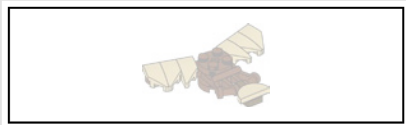

7

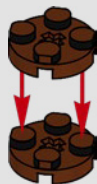

8

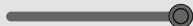



9

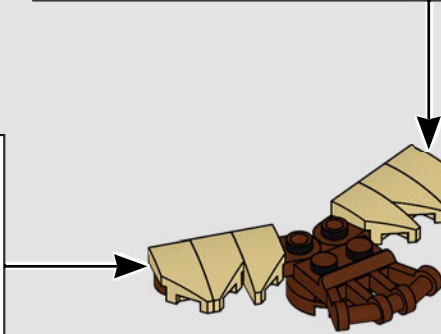
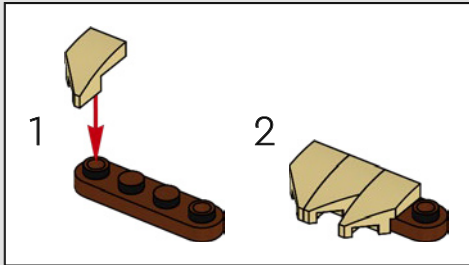
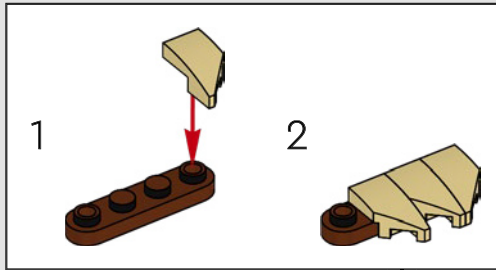



10

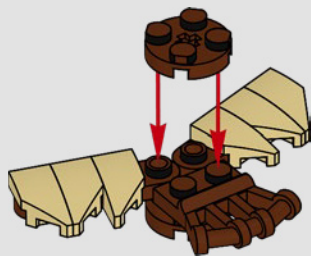

11

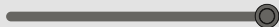
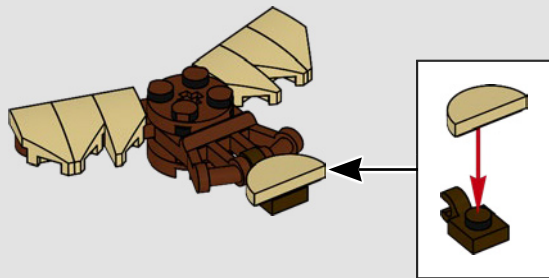

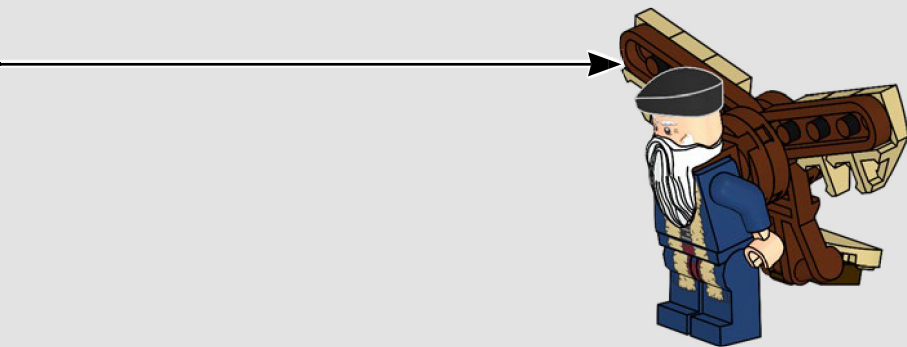

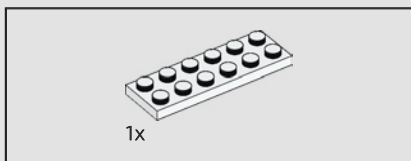
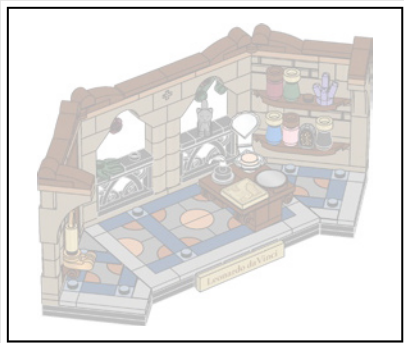

1

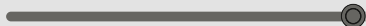
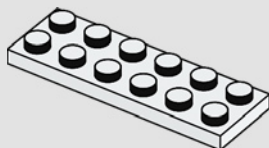

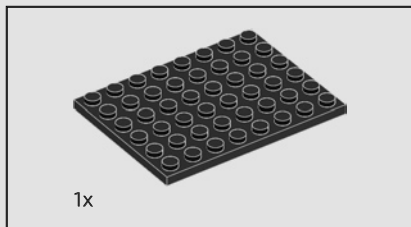

2

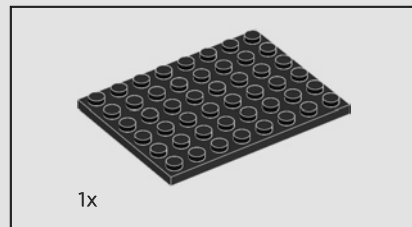
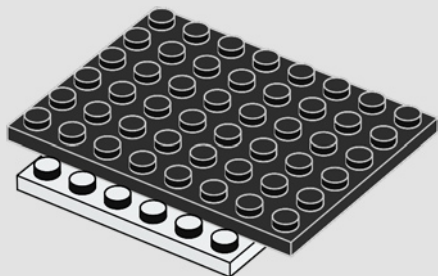

3

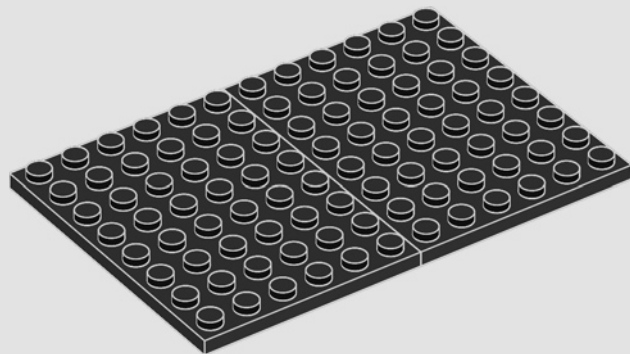

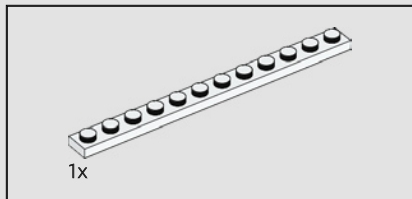

4

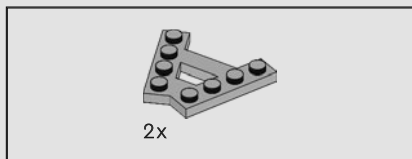
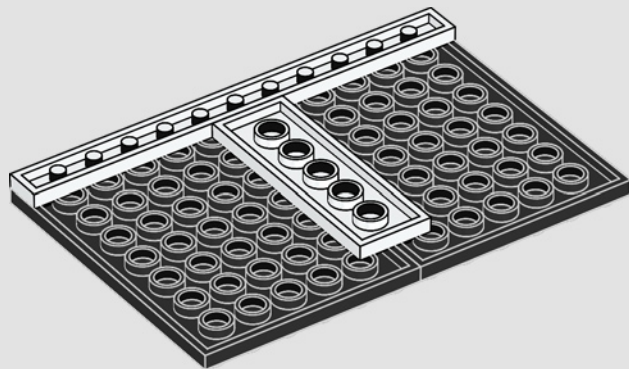

5

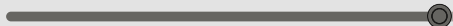
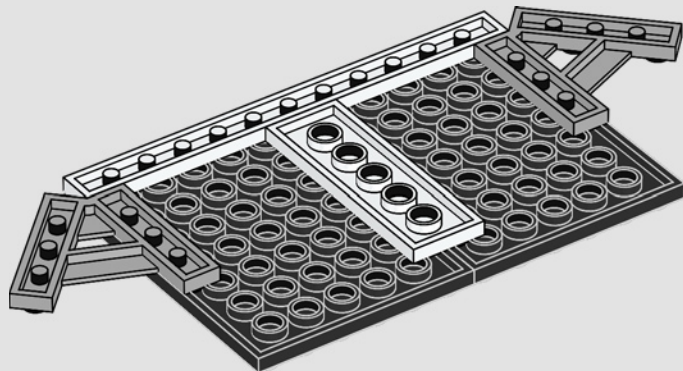

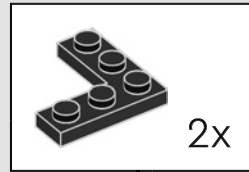
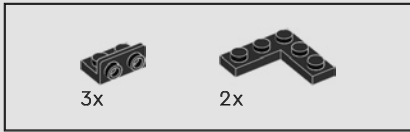

6

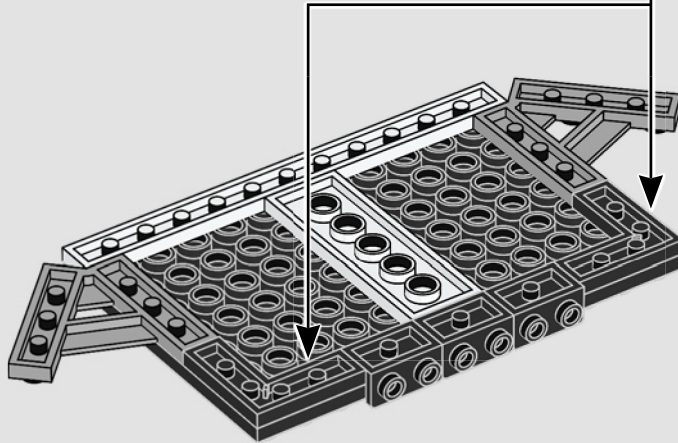

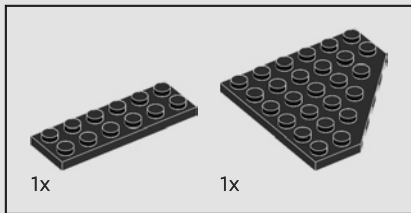

7

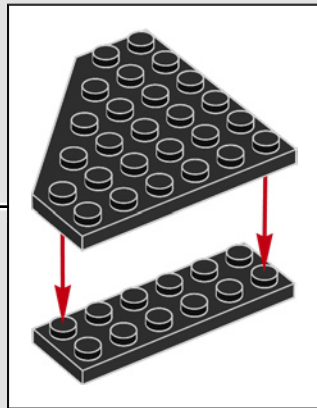
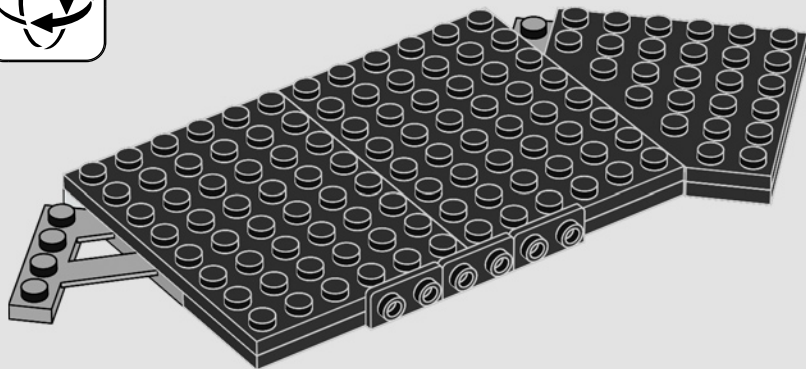

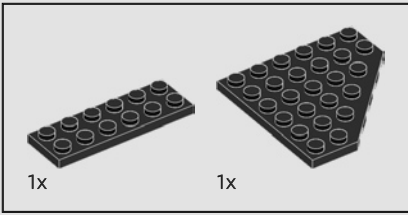

8

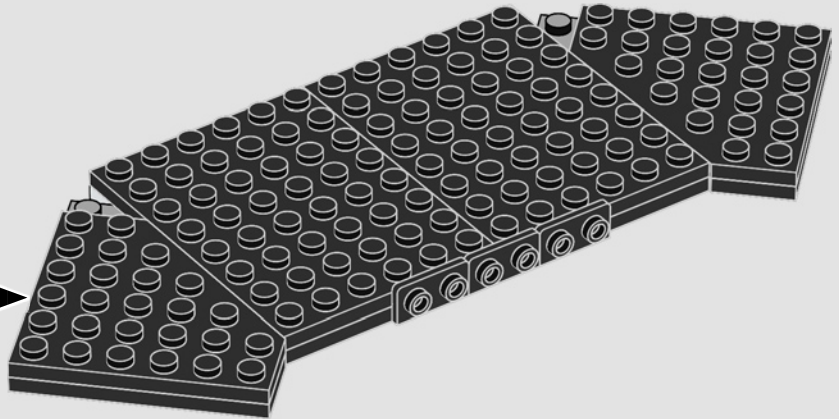
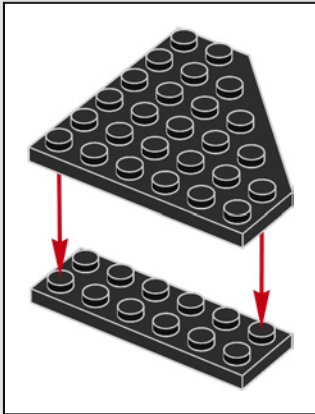



2x

9

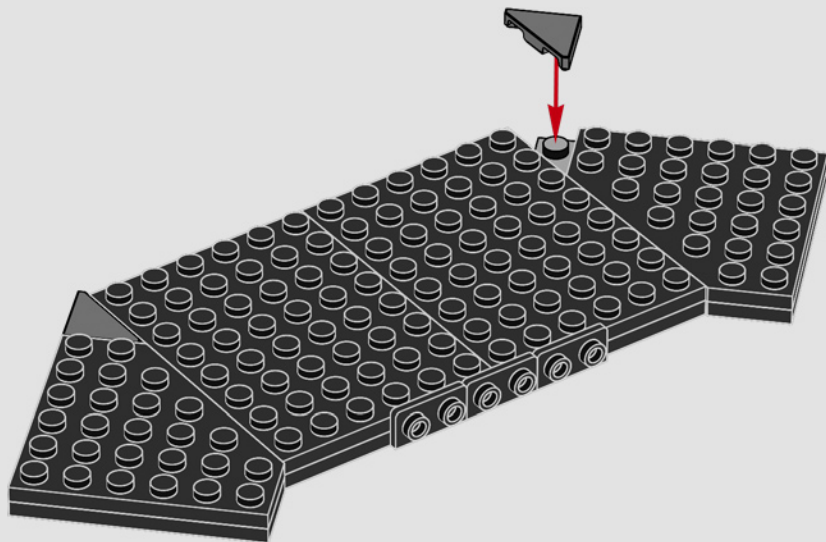

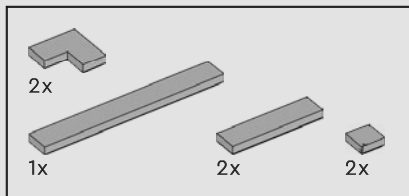

10

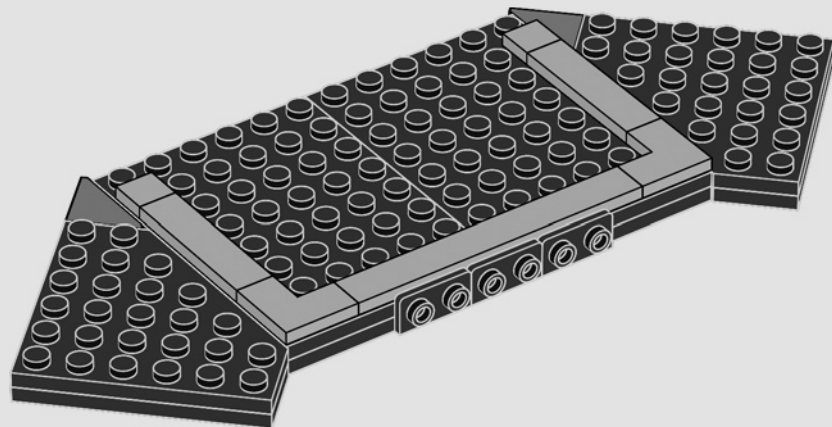

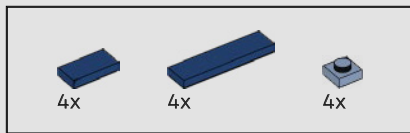

11

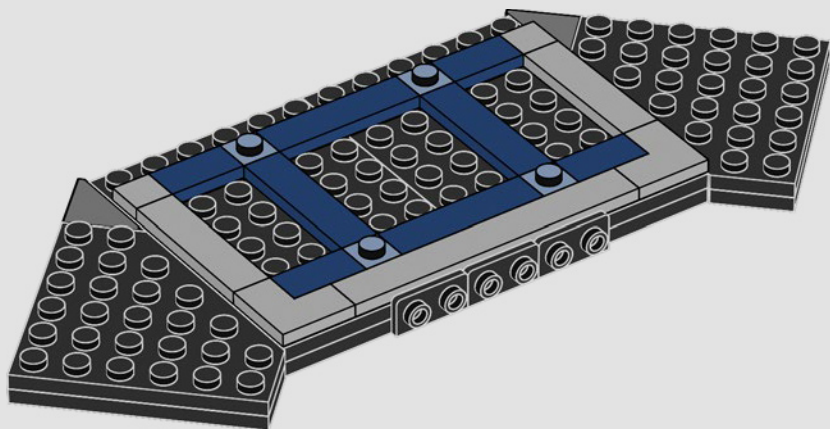



12

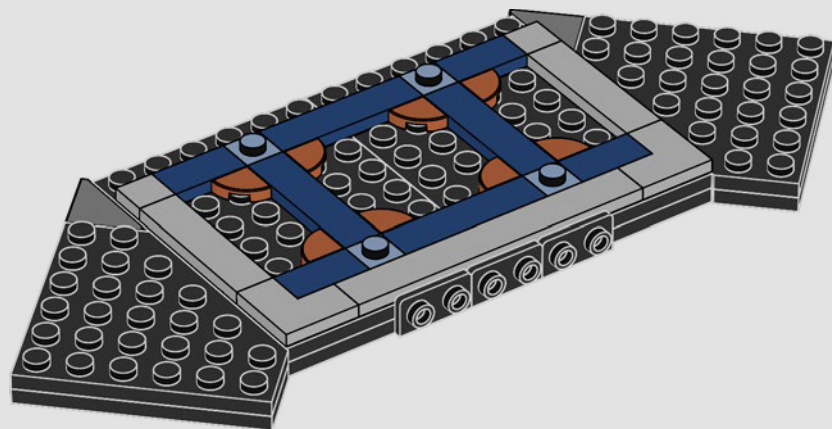



4x



8x

13

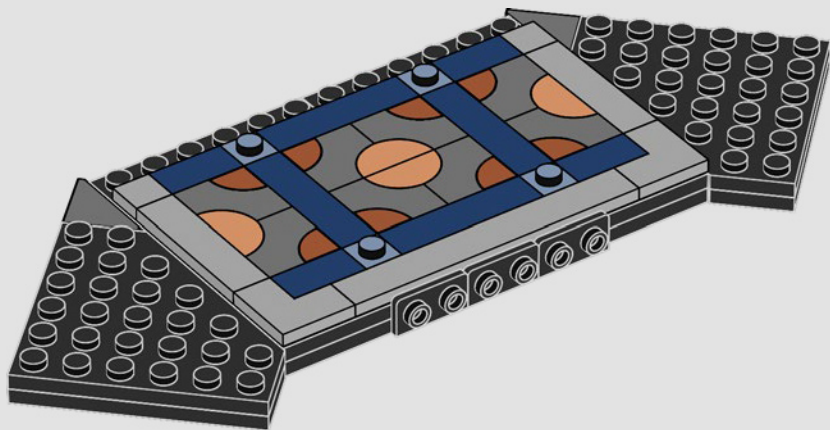

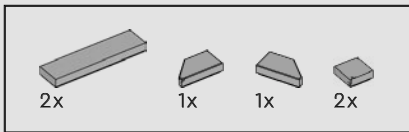

14

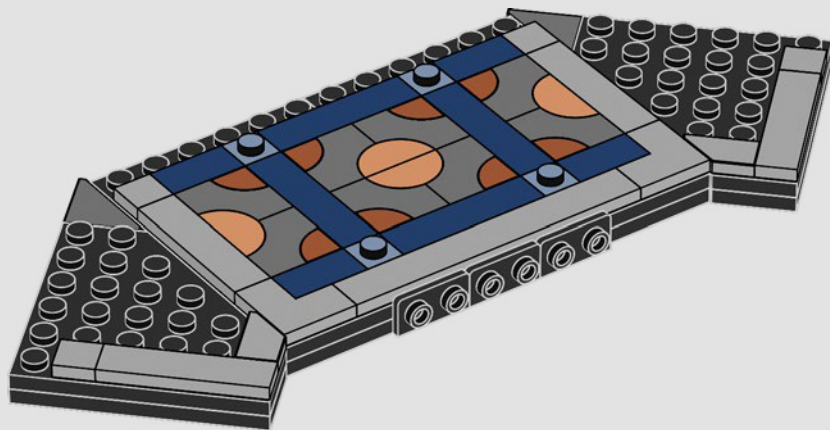

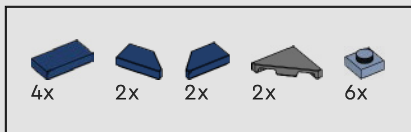

15

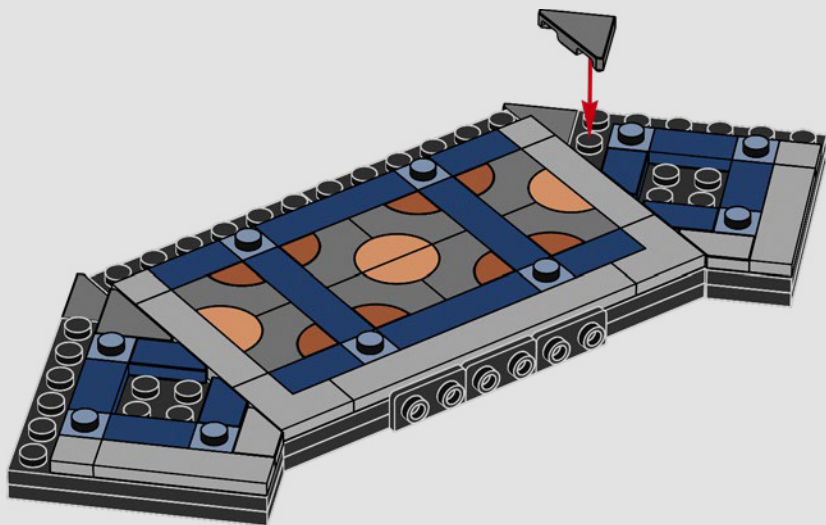

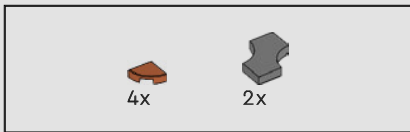

16

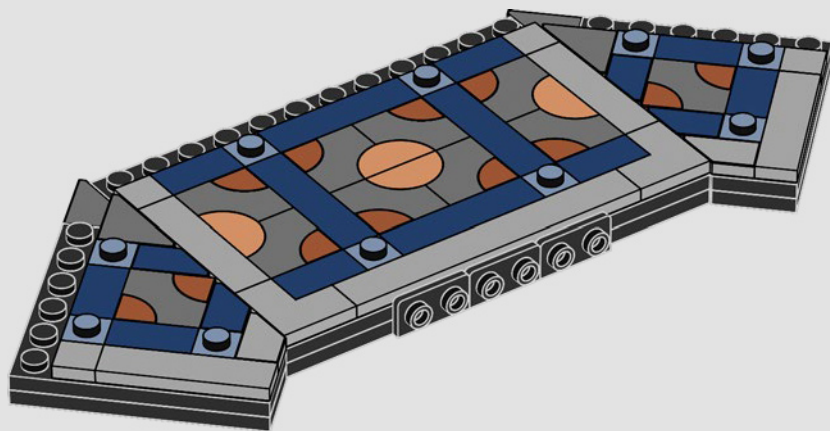

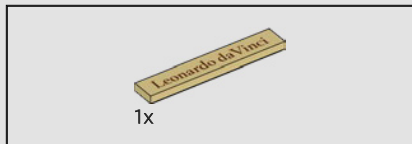

17

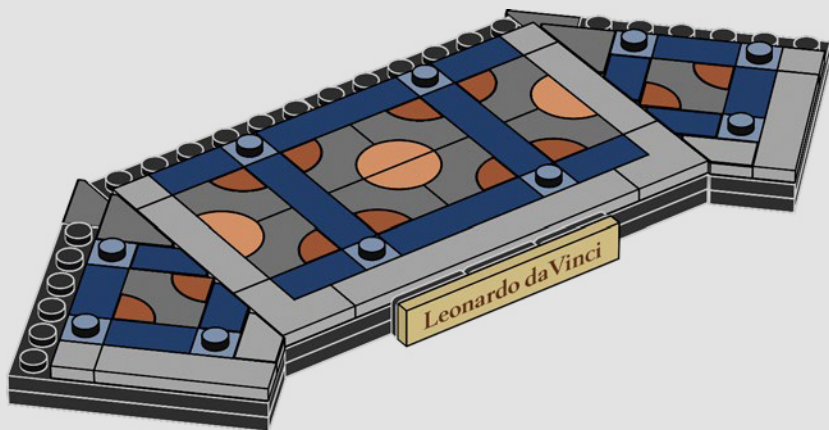



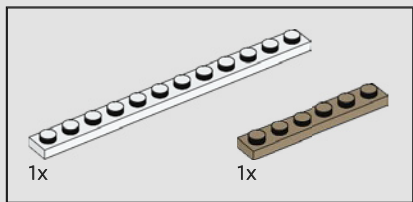
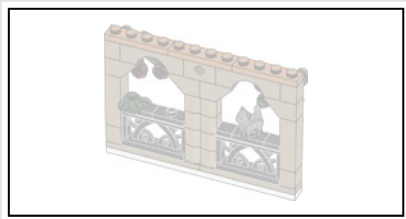

18

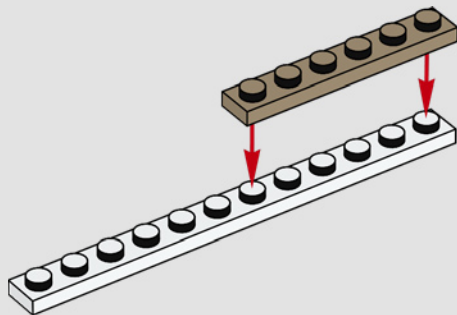

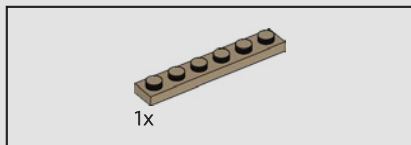

19

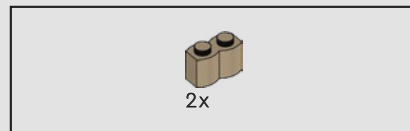
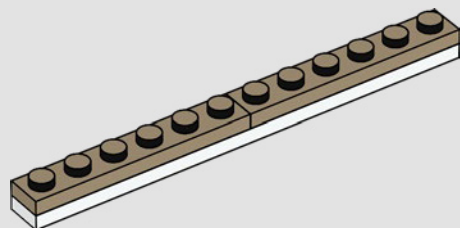

20

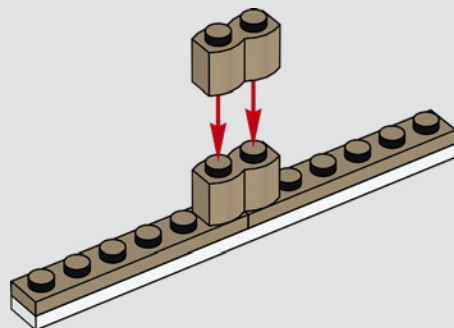



21

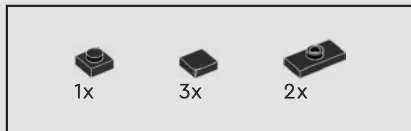
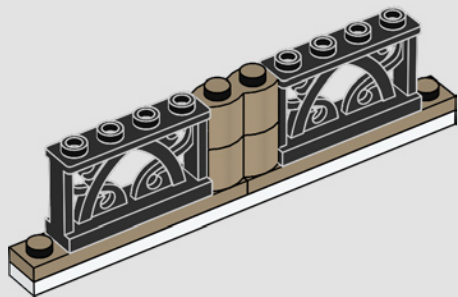

22

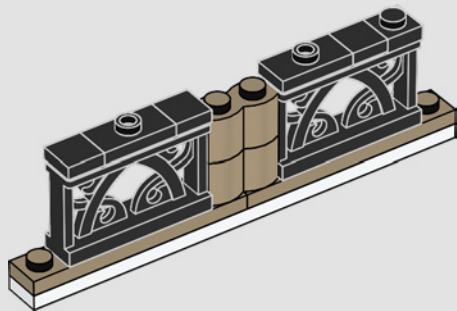

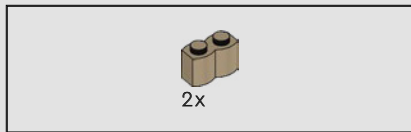

23

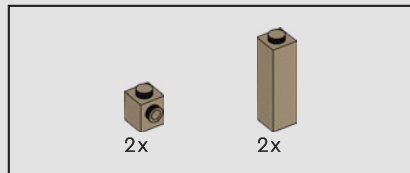
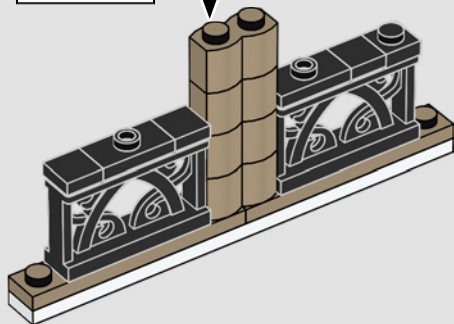
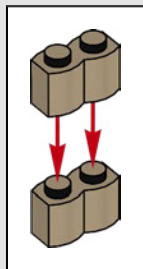

24

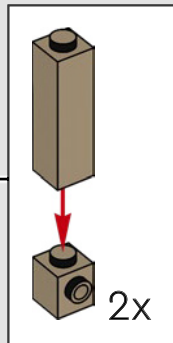
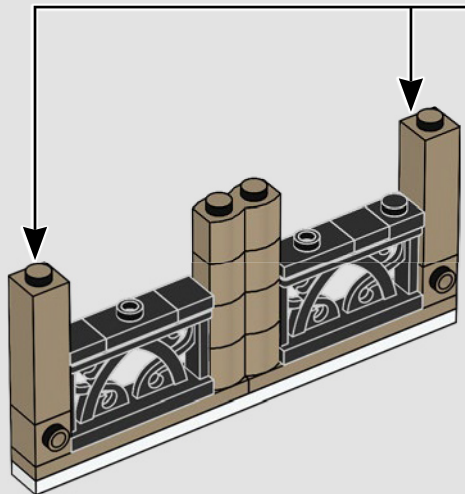

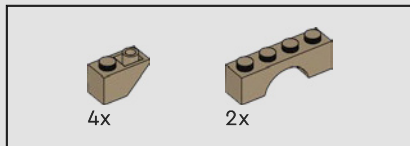

25

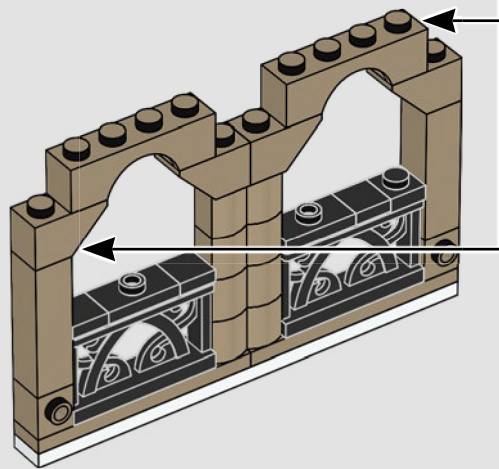
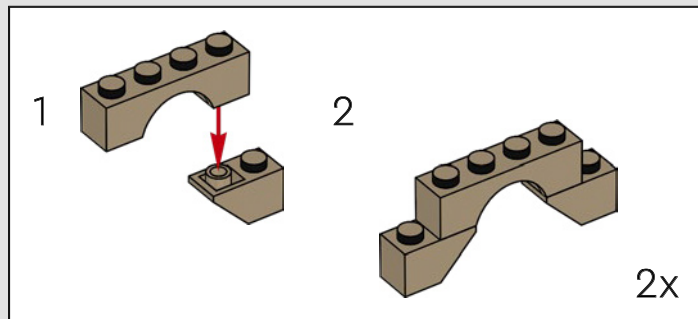

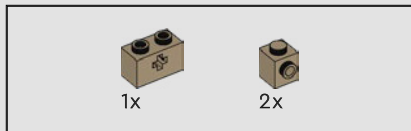

26

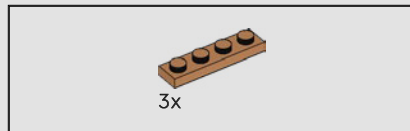
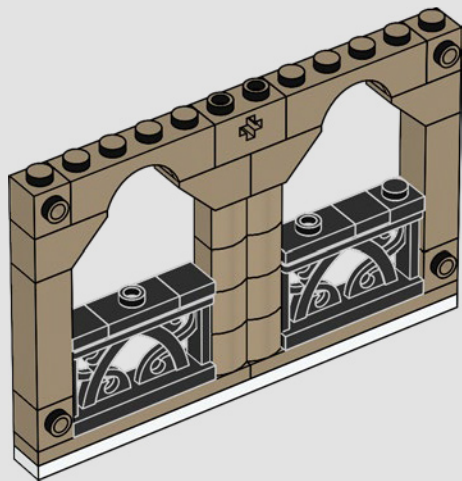

27

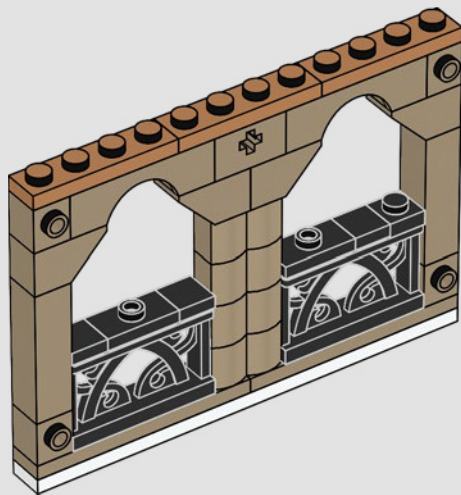



28

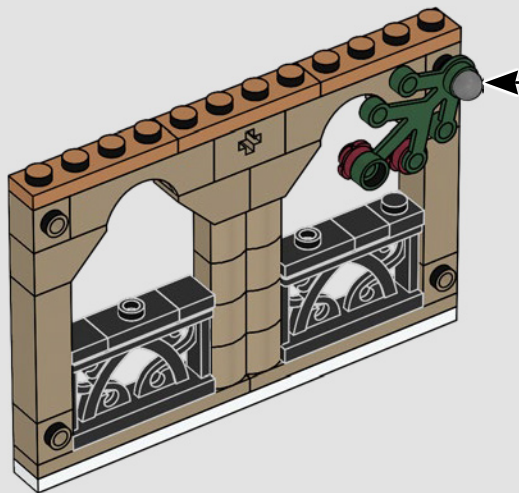
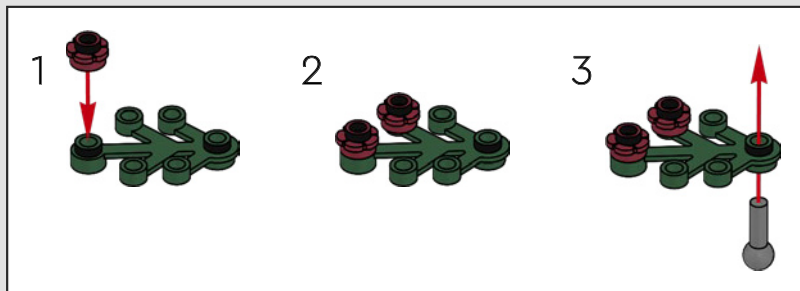



29

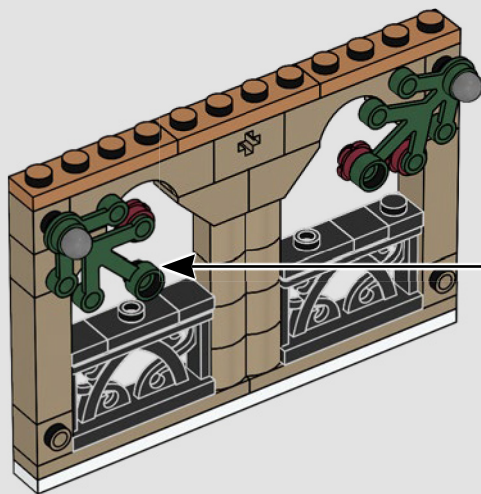
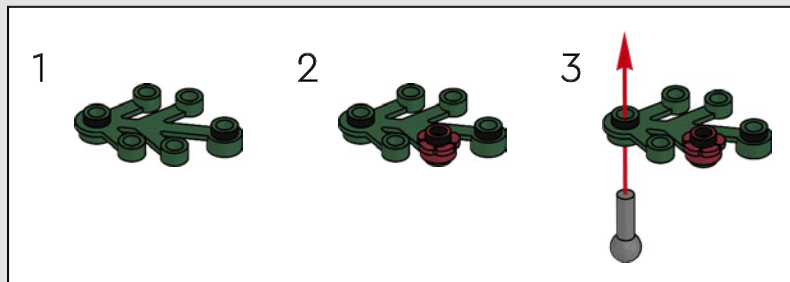



1x



1x

30

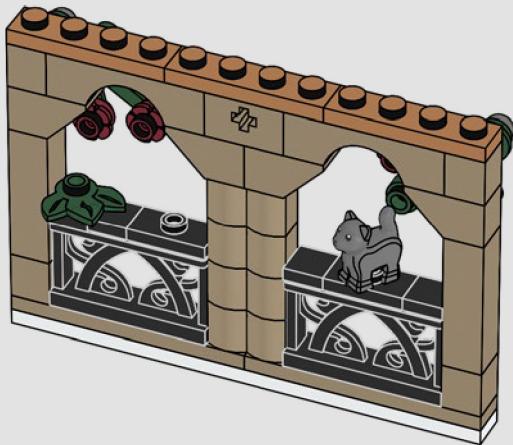
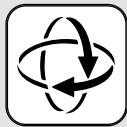

31

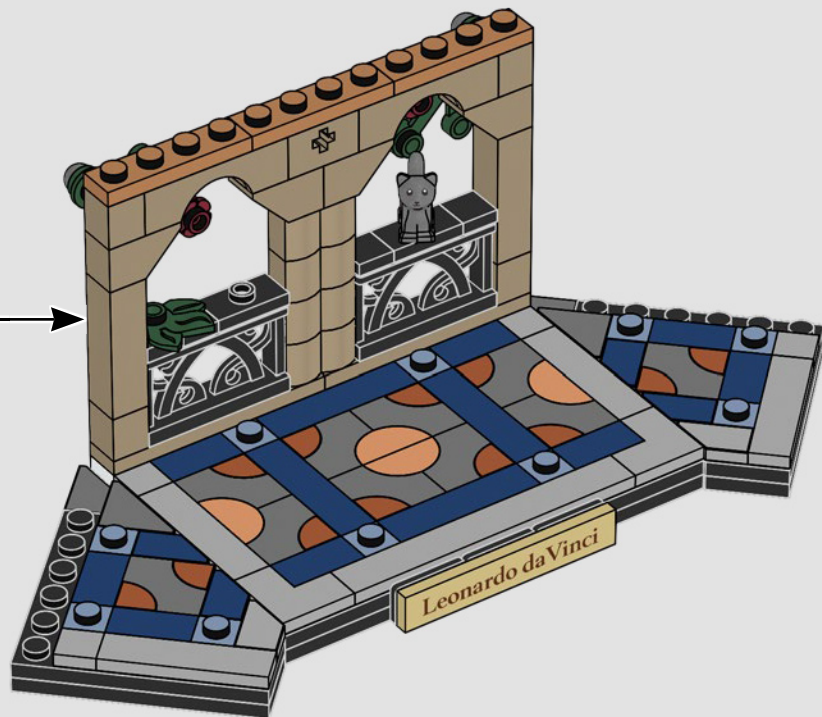

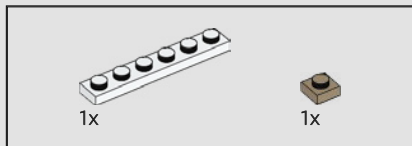
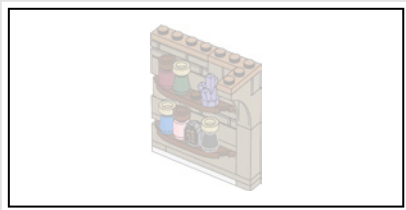

32

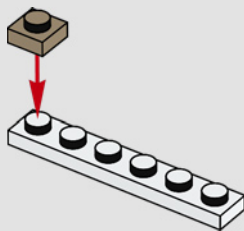

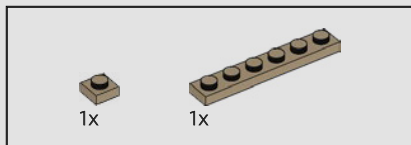

33

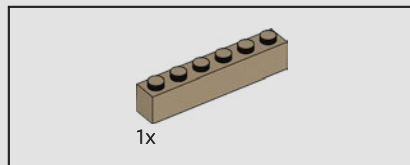
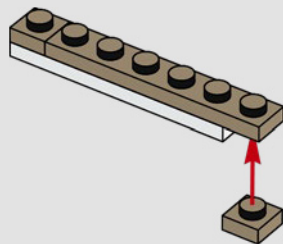

34

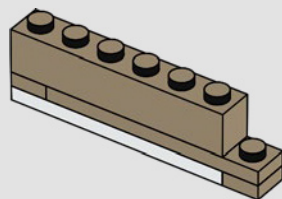

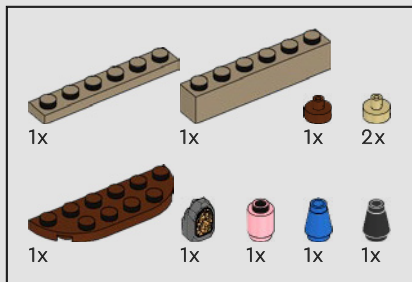

35

1

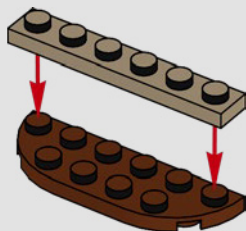

2

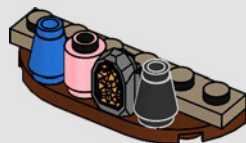

3



4

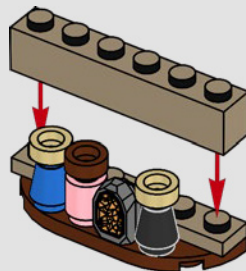

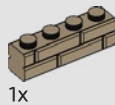
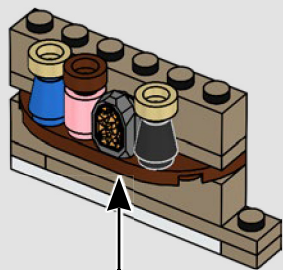

36

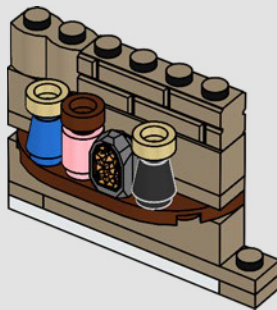

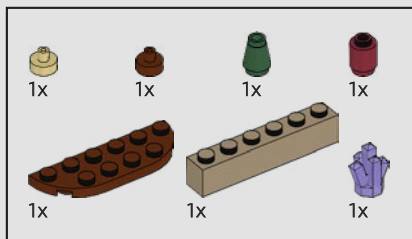

37

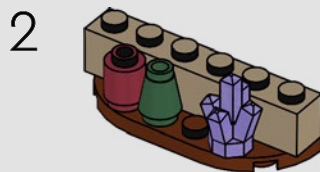
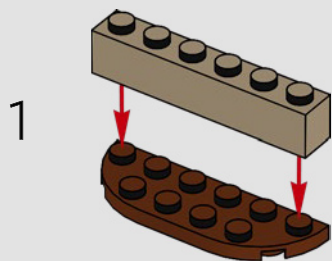

3

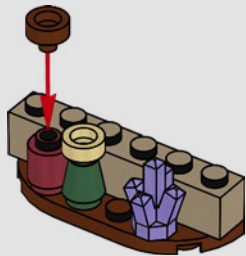

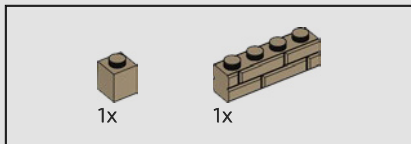

38

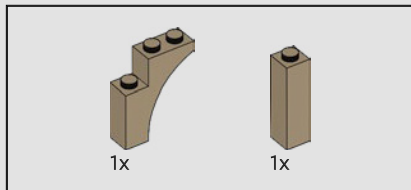

39

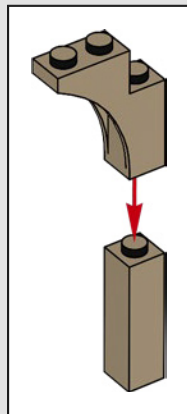

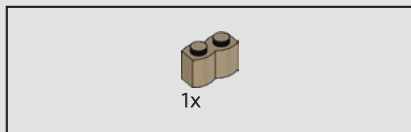

40

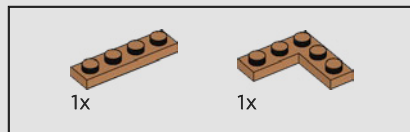
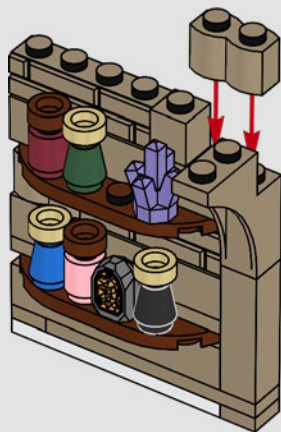

41





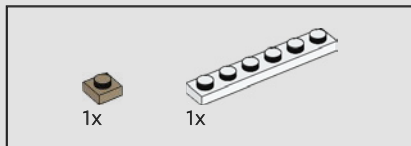
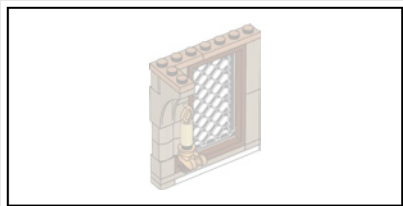

43

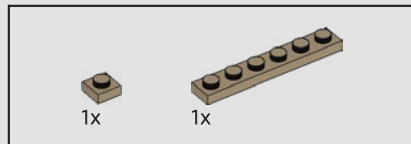
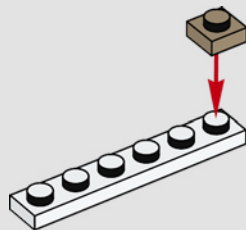

44

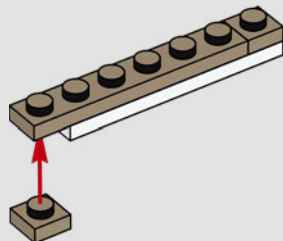



45

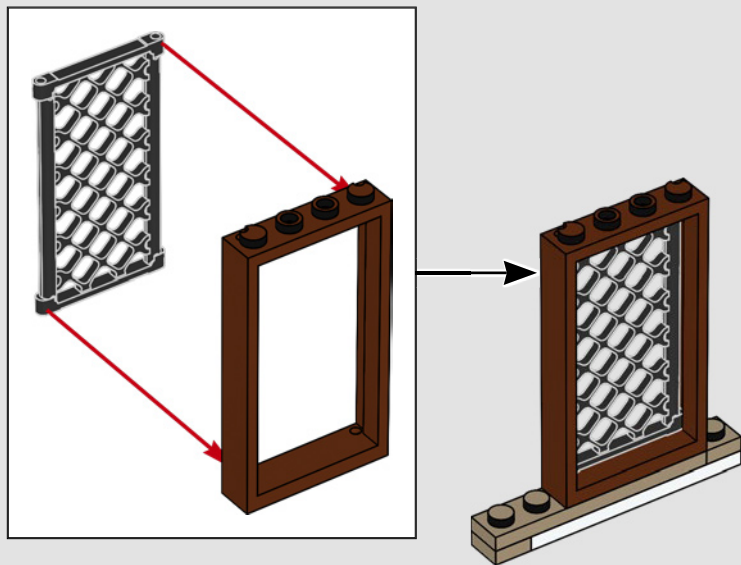

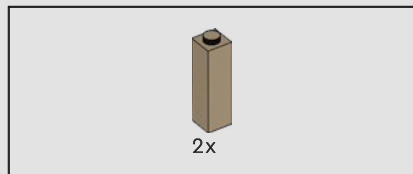

46

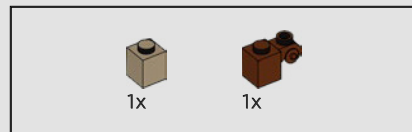
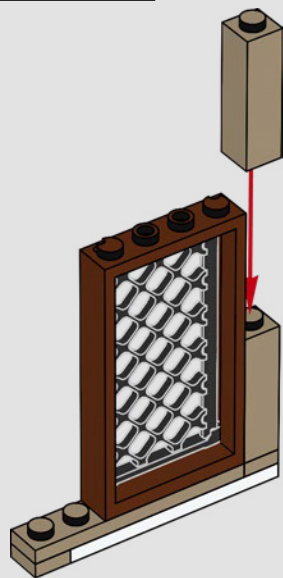

47

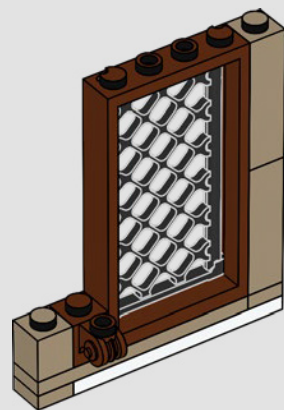

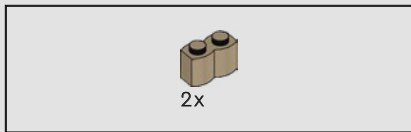

48

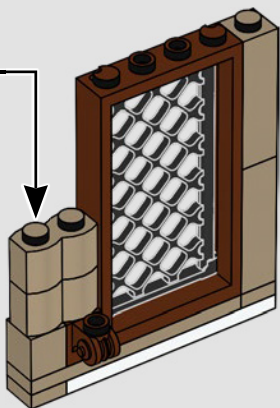
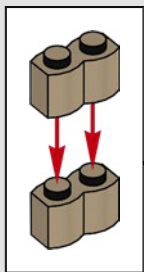

49

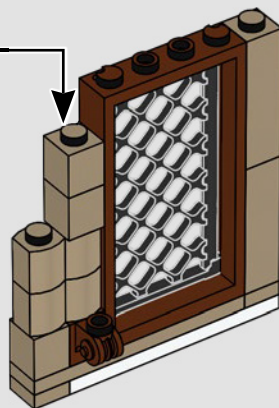
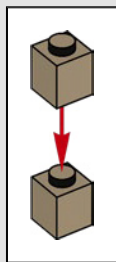

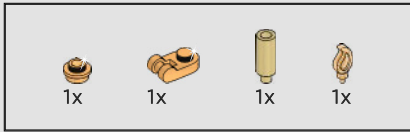

50

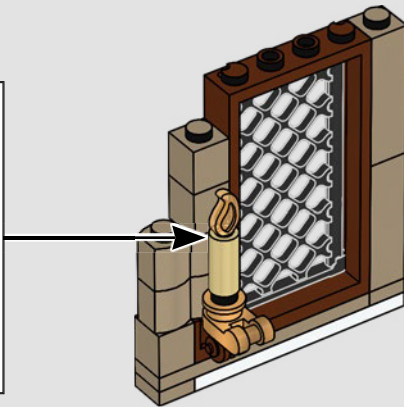
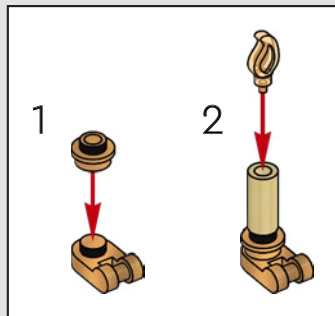

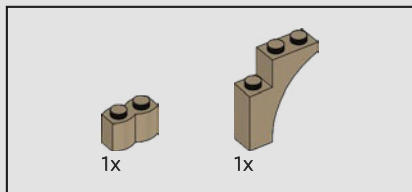

51

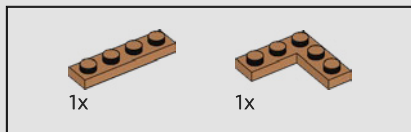
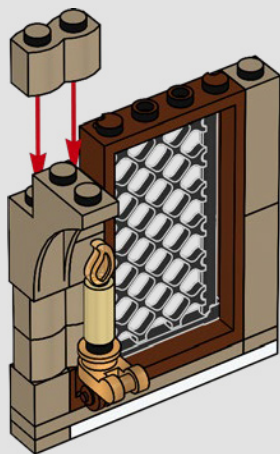

52



53





2x

54





4x

55



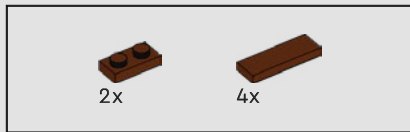

56





2x



6x

57



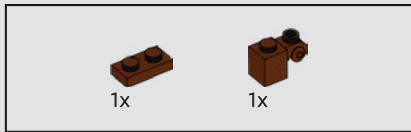

58

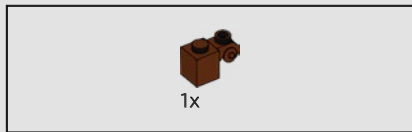
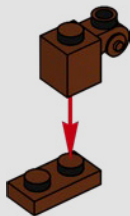

59

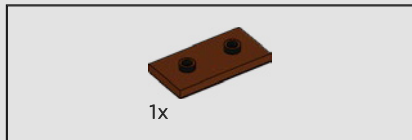
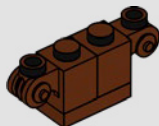

60

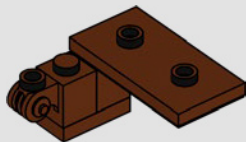



61

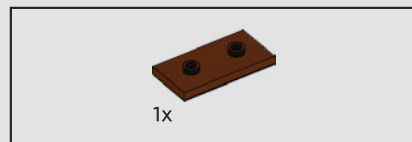
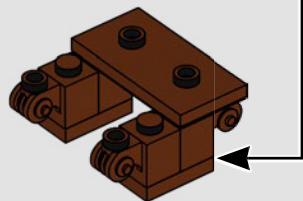
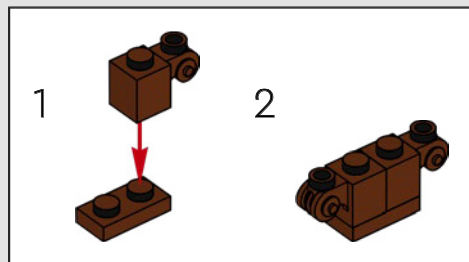

62

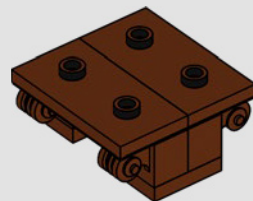



63

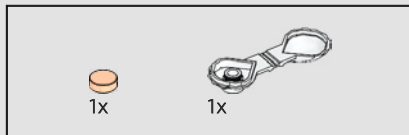
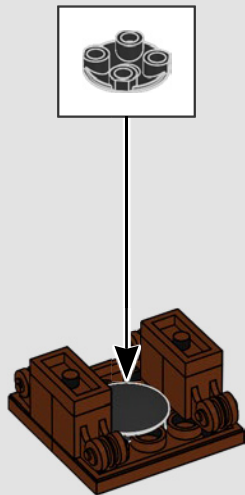

64

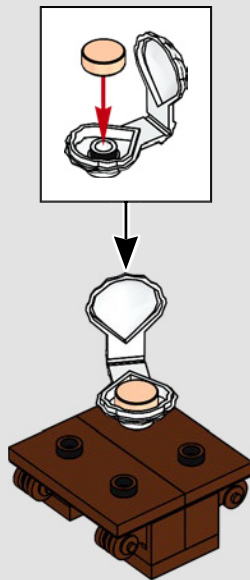

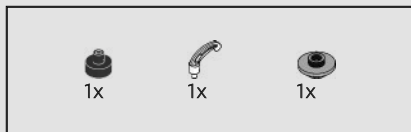

65

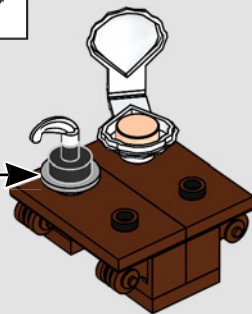
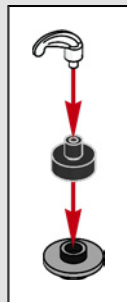

66

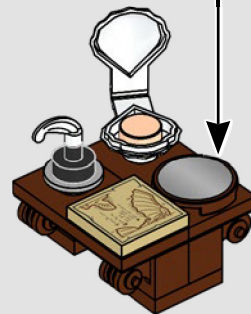
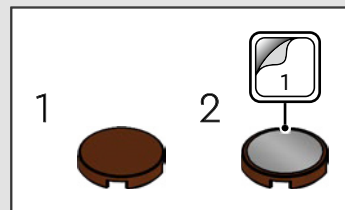

67







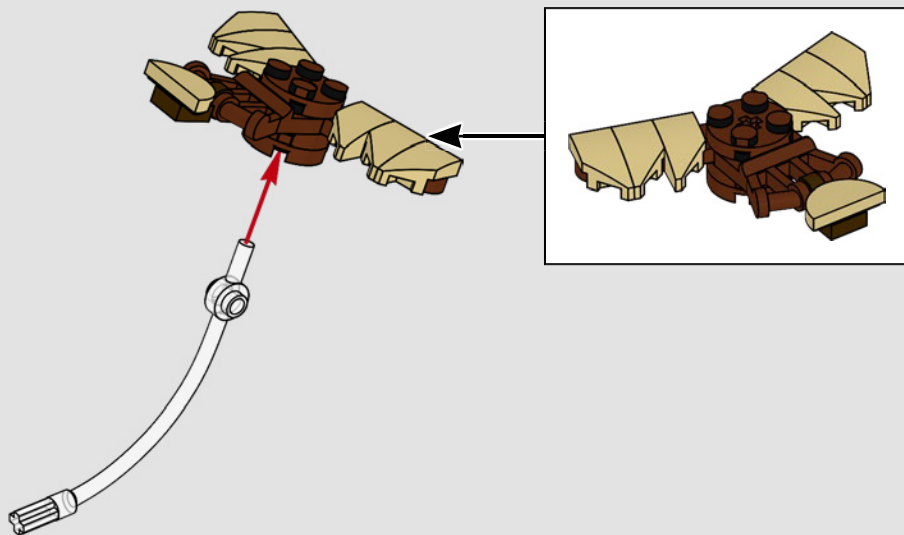

































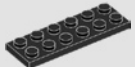







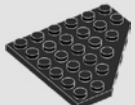







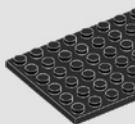







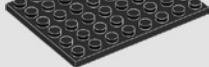





68



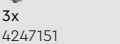



Leonardo da Vinci

 1x 6406415	 3x 6463667	 1x 6186675	 1x 6106280	 1x 4529235	 10x 6257079	 9x 4520257	 2x 6510146
 1x 6315564	 1x 6360078	 1x 4529236	 1x 6545265	 4x 6510076	 4x 4549436	 2x 6283824	 2x 6510132
 1x 6092203	 1x 6510069	 3x 307026	 2x 6439175	 1x 6396678	 4x 6536855	 8x 4528488	 8x 4528488
 2x 366601	 2x 6286492	 1x 302426	 2x 379526	 12x 6228968	 4x 6001824	 2x 6502374	 1x 6523326
 1x 379501	 3x 6299936	 1x 6408118	 2x 4106977	 1x 6092602	 4x 601824	 2x 6310832	 1x 6530674
 2x 4514842	 3x 6299935	 2x 6092585	 2x 303626	 1x 4614158	 5x 6310988	 5x 6015424	 4x 6103985
 1x 6454936	 1x 6533760	 3x 6020193	 2x 303626	 1x 6589313	 1x 6310833	 3x 4247151	 1x 6411591
 1x 6559240	 1x 6523327	 1x 4278359		 1x 6359717	 4x 6121959	 3x 4247151	 1x 6400754
	 1x 6610621	 2x 6138726		 1x 6510119			 2x 6586465

3x
6458394

1x
4539099

1x
6533761

1x
6514274

6x
6371437

2x
6186673

1x
6170809

1x
6075213

6x
6069984

4x
4211150

5x
6172757

3x
4211159

4x
6100769

2x
6463591

1x
6361174

2x
6416695

2x
6307618

1x
6262952

2x
6357946

1x
6531935

4x
4211415

1x
6558800

1x
6558799

2x
6065824

4x
4211356

2x
6442144

1x
4211481

1x
6541584

1x
6375490

2x
6364352

1x
6115080

10x
6526068

4x
6262025

1x
6190252

1x
6212377

1x
6460688

1x
6345494

2x
6431822

5x
6167700

1x
6507866

1x
6584823

1x
6315196

1x
6523324

1x
6614866

 LEGO.com/service

YOU COULD **WIN**

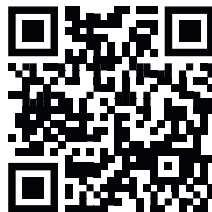

Scan this QR code or go to **LEGO.COM/PRODUCTFEEDBACK** and give us your short feedback about this LEGO® set for a chance to win a cool LEGO prize.

Terms and Conditions apply*



EN: YOU COULD WIN. Terms and Conditions apply* **DE: Du könntest GEWINNEN.** Es gelten die Teilnahmebedingungen* **FR: TU POURRAIS GAGNER.** Des conditions s'appliquent* **IT: Potresti VINCERE tu.** Termini e condizioni sono applicabili* **ES: PUEDES GANAR.** Aplican términos y condiciones* **PT: PODERÁ GANHAR.** Aplicam-se Termos e Condições* **ZH: 轻松获奖.** 条款和条件适用* **PL: Szansa na WYGRANĄ.** Obowiązuje regulamin* **CS: Máte šanci VYHRÁT.** Platí všeobecné smluvní podmínky* **SK: Máte šancu VYHRAŤ.** Platia všeobecné zmluvné podmienky* **HU: TE IS NYERHETSZ!** Felhasználási feltételek érvényesek* **UA: ВИ МОЖЕТЕ ВИГРАТИ.** Застосовуються загальні положення та умови* **RO: Ai putea CÂȘTIGA.** Se aplică termenii și condiții* **BG: Можете да СПЕЧЕЛИТЕ.** Има определени правила и условия* **LV: Tu vari LAIMĒT.** Ir spēkā noteikumi un nosacījumi.* **ET: Sul on võimalus VÕITA.** Kehtivad tingimused* **LT: Jūs galite LAIMĖTI.** Taikomos sąlygos* **TR: KAZANABİLİRSİN.** Şartlar ve Koşullar geçerlidir*

*[LEGO.com/productfeedback-terms](https://www.lego.com/productfeedback-terms)

