

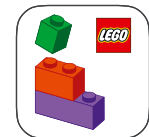

11380



Available in English
Disponible en français
Disponible en español



LEGO® Builder

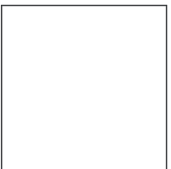



WE'RE MAKING OUR PACKAGING MORE SUSTAINABLE

We're transitioning from single-use plastic to paper-based packaging. As we progress, you may find a mix of paper and plastic in our boxes.

NOUS RENDONS NOS EMBALLAGES PLUS DURABLES

Nous passons des emballages en plastique à usage unique aux emballages à base de papier. Durant la transition, vous pourriez trouver un mélange de papier et de plastique dans nos boîtes.

QUEREMOS HACER MÁS SUSTENTABLES NUESTROS MATERIALES DE EMBALAJE

Estamos cambiando las bolsas de plástico desechables por bolsas con base de papel. Conforme avanzamos en este propósito, puedes encontrar una mezcla de papel y de plástico en nuestras cajas.

LEGO.com/sustainable-packaging



BUILDER



Apple and the Apple logo are trademarks of Apple Inc., registered in the U.S. and other countries and regions. App Store is a service mark of Apple Inc. Google Play and the Google Play logo are trademarks of Google LLC. Tencent and the Tencent logo are trademarks of Tencent Inc.

LEGO.com/devicecheck

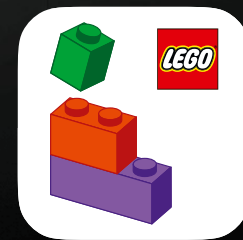

LEGO® Builder





*INGENIOUS IN ITS SIMPLICITY
INGÉNIEUX DANS SA SIMPLICITÉ
EL INGENIO ESTÁ EN SU SIMPLICIDAD*

▶ The bicycle is one of the most ingenious technological inventions to emerge from the Industrial Revolution. Since the first simple, affordable versions became readily available in the late 19th century, it has paved roads to personal freedom and independence. Today's road and racing bikes carry that legacy forward: sleek, minimalistic and fine-tuned for speed and endurance. For those who seek healthier, more sustainable ways of living, the bicycle stands as a cultural and ecological icon, embodying aesthetics, performance and ingenuity.

▶ La bicyclette est l'une des inventions technologiques les plus ingénieuses issues de la Révolution industrielle. Depuis que les premières versions simples et abordables sont devenues accessibles à la fin du 19^e siècle, elle a ouvert la voie à la liberté et à l'autonomie personnelles. Les vélos de route et de course d'aujourd'hui perpétuent cet héritage : profil épuré, conception minimaliste et réglages précis pour la vitesse et l'endurance. Pour celles et ceux en quête d'un mode de vie plus sain et plus durable, la bicyclette est un symbole culturel et écologique, incarnant à la fois l'esthétique, la performance et l'ingéniosité.

▶ La bicicleta es una de las invenciones tecnológicas más ingeniosas que surgieron de la Revolución Industrial. Sencillas y económicas, las primeras versiones empezaron a estar disponibles a finales del siglo XIX y, desde entonces, han allanado el camino hacia la libertad y la independencia personal. Elegantes, minimalistas y optimizadas para ofrecer velocidad y resistencia, las bicicletas de carretera y de carreras actuales continúan con ese legado. Para quienes buscan formas más saludables y sostenibles de vivir, la bicicleta constituye un símbolo cultural y ecológico que representa estética, desempeño e inventiva.





*FROM THE LEGO® ICONS DESIGN TEAM
DE L'ÉQUIPE DE CONCEPTION LEGO® ICONS
IMPRESIONES DEL EQUIPO DE DISEÑO DE LEGO® ICONS*

▶ Biking is a passion for many people around the world, including Denmark, home of the LEGO Group! But could we build one out of (mostly square) LEGO® bricks? It was a challenging engineering task to build a stable design. Especially around the head tube, where the top and bottom tubes meet to create the socket for the front fork. Choosing a large scale was key to getting the proportions right, and the display stand adds extra stability in both presentation and handling.

▶ Le vélo est une passion partagée partout dans le monde, y compris au Danemark, le pays d'origine du groupe LEGO! Mais pouvait-on en construire un avec des briques LEGO®, majoritairement carrées? Ce fut un véritable défi d'ingénierie de concevoir une structure stable, notamment au niveau du tube de direction, là où le tube supérieur et le tube diagonal se rejoignent pour créer la douille de direction de la fourche avant. Le choix d'une grande échelle s'est avéré essentiel pour respecter les bonnes proportions, et le socle d'exposition ajoute une stabilité précieuse, tant pour la présentation que pour la manipulation.

▶ El ciclismo es una pasión para muchas personas en todo el mundo, ¡lo que incluye a Dinamarca, la sede de The LEGO Group! ¿Pero podríamos construir una usando bricks LEGO® (cuya forma es principalmente cuadrada)? Hacer un diseño estable fue todo un desafío de ingeniería. Especialmente en la zona de la dirección, donde los tubos superior e inferior del cuadro se unen con el tubo de dirección, donde se inserta la horquilla. Elegir una escala grande fue fundamental para lograr las proporciones adecuadas, y la base de exhibición aporta estabilidad adicional tanto para fines de presentación como de manipulación.





9 ▶

1 ▼

8 ▼

2 ▼

6 ▼

5 ▼

4 ▼

3 ▼

7 ▶

FUNCTION IN MOTION
FONCTION EN MOUVEMENT
FUNCIONALIDAD EN MOVIMIENTO

1 ▶

New tire element – the first to sit on a brick-built wheel

Nouvel élément de pneu – le premier à s'adapter à une roue construite en briques

Nueva llanta, la primera en montarse en una rueda construida con bricks

2 ▶

New segmented rim element

Nouvel élément de jante segmenté

Nuevo elemento de rin segmentado

3 ▶

New spoke element

Nouvel élément de rayon

Nuevo elemento de rayo

4 ▶

New large 64-tooth gear, essential for chain-drive system

Nouvel engrenage de 64 dents, essentiel au système d'entraînement par chaîne

Nuevo engrane grande de 64 dientes, esencial para un sistema de transmisión por cadena

5 ▶

Crank and chain mechanism drives rear wheel

Mécanisme de pédalier et de chaîne qui propulse la roue arrière

Mecanismo de biela y cadena para impulsar la rueda trasera

6 ▶

New one-way gear for authentic coasting

Nouveau système d'engrenage unidirectionnel pour une roue libre réaliste

Nuevo engranaje unidireccional que permite un pedaleo libre real

7 ▶

Removable training stand

Support d'entraînement amovible

Soporte de entrenamiento removible

8 ▶

Removable water bottle

Bouteille d'eau amovible

Botella de agua removible

9 ▶

Removable rear light

Feu arrière amovible

Luz trasera removible

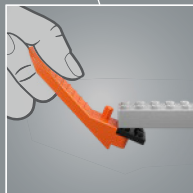
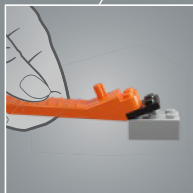
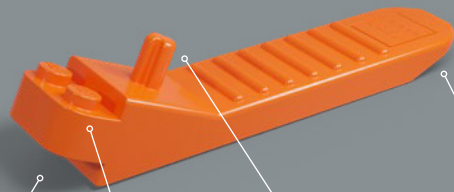

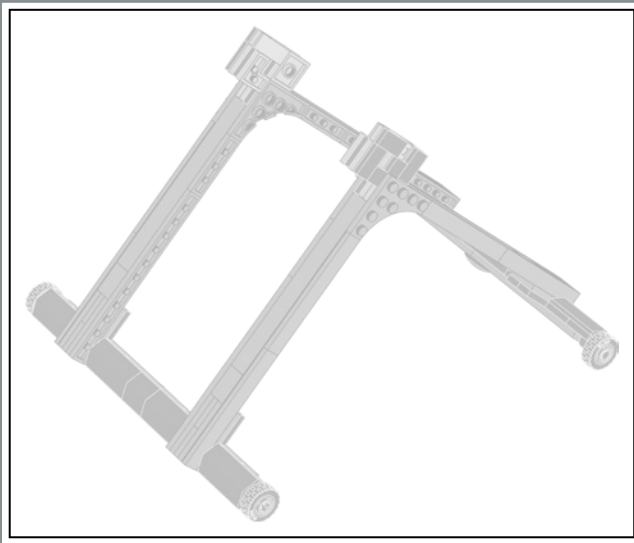

1

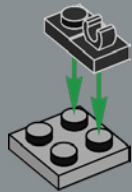

Who says you can't use your bike indoors?

Qui a dit qu'on ne pouvait pas faire du vélo à l'intérieur?

¿Quién dice que no puedes usar tu bicicleta en interiores?

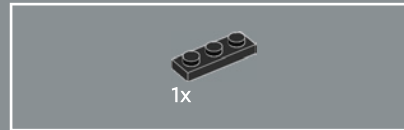

2

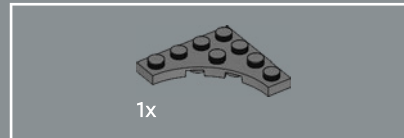
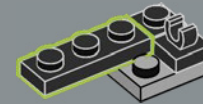

3

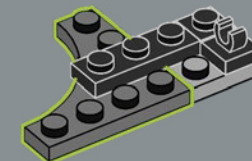



1x

4

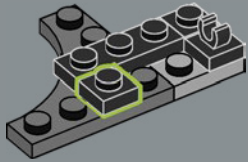

1x

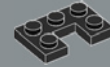

1x

5

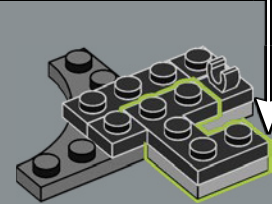
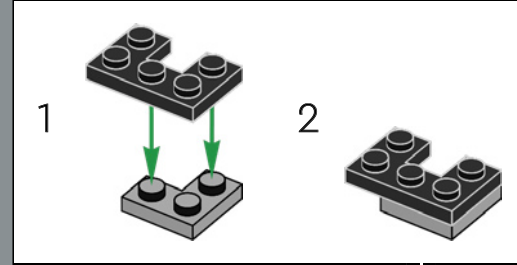

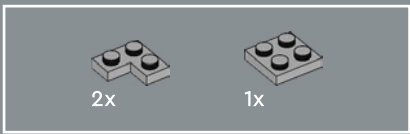

6

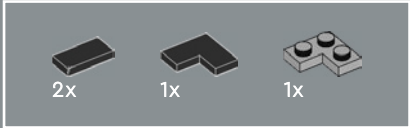
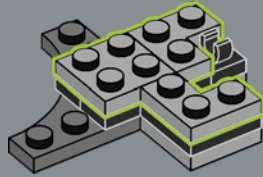

7

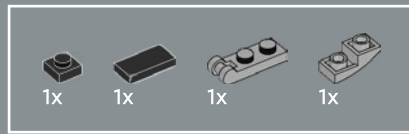
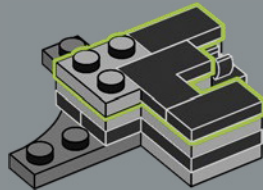

8

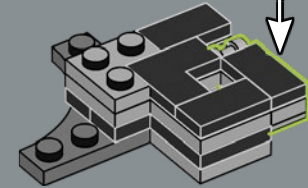
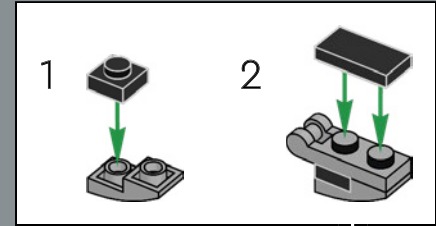

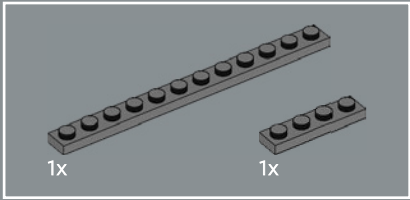
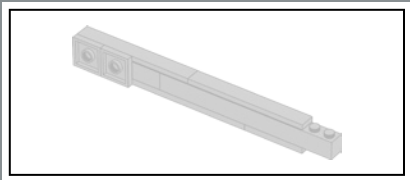

9

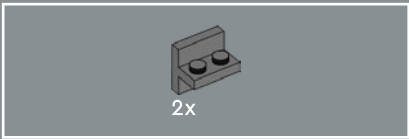
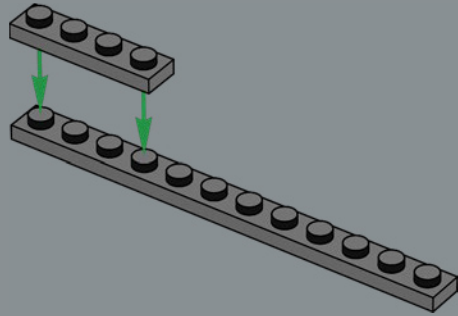

10

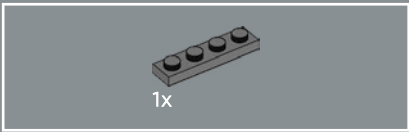
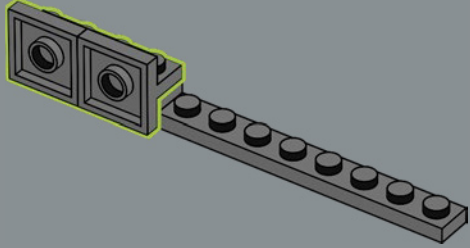

11

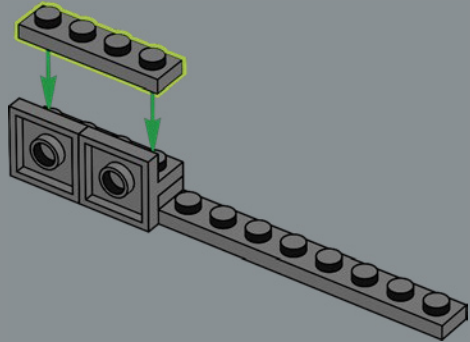

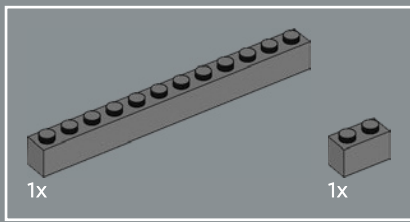

12

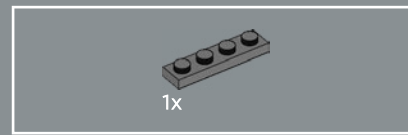
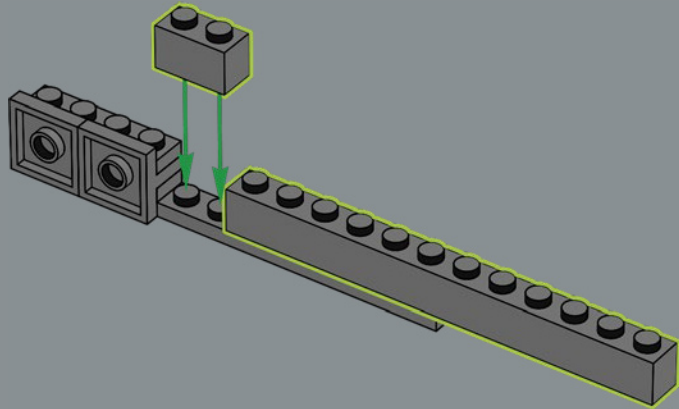

13

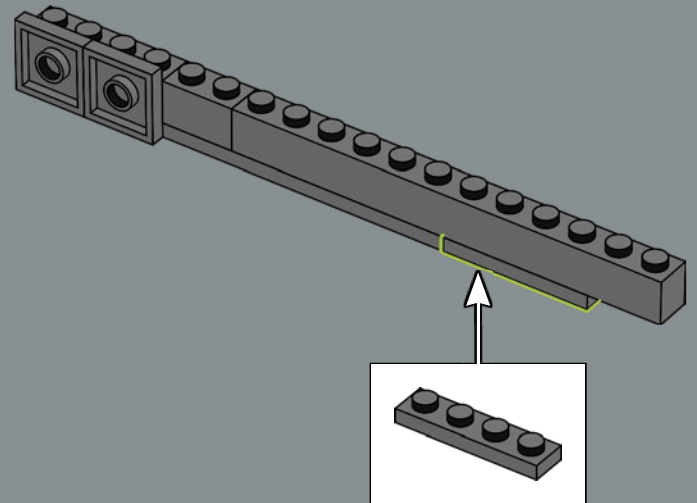

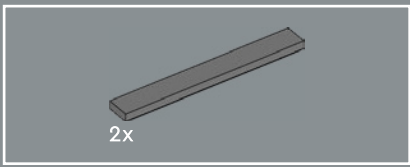

14

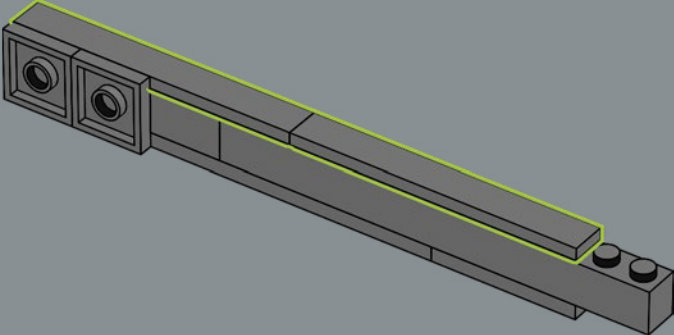

15

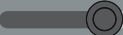
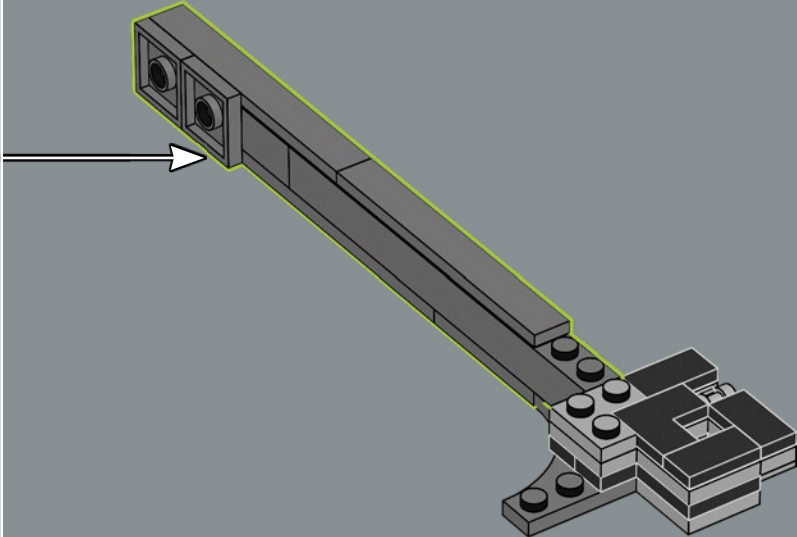

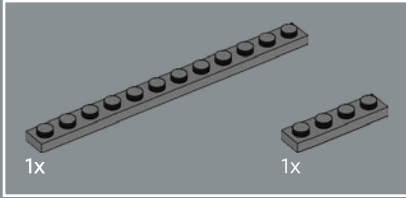
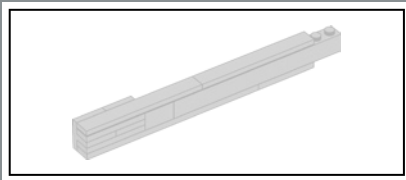

16

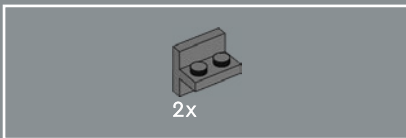
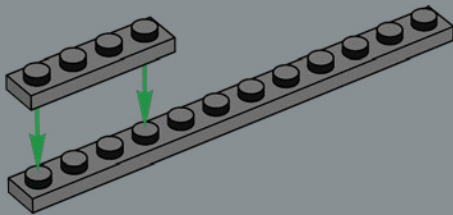

17

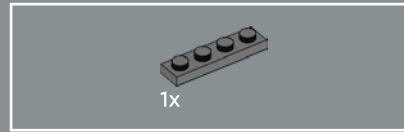
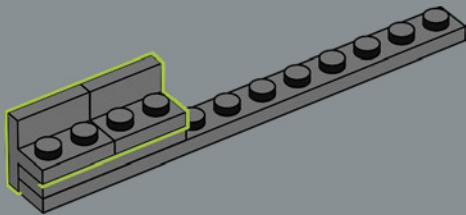

18

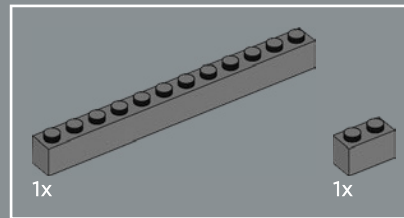
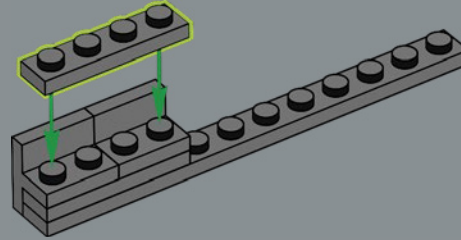

19

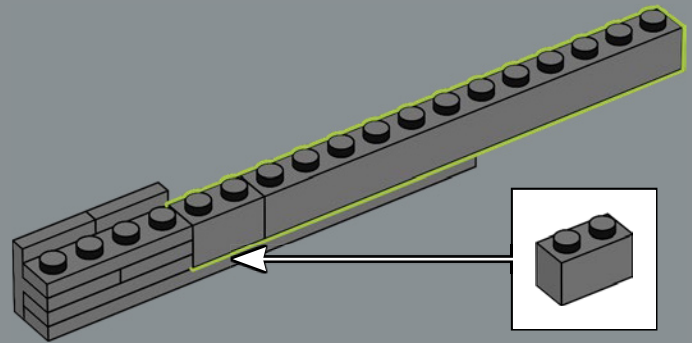

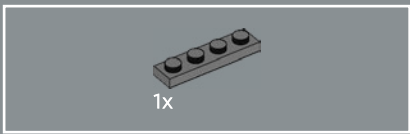

20

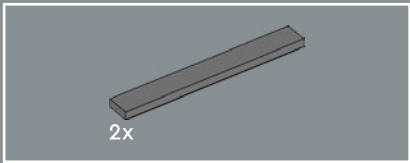
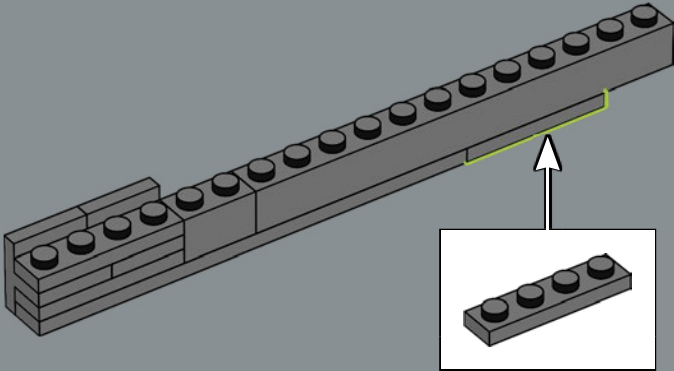

21

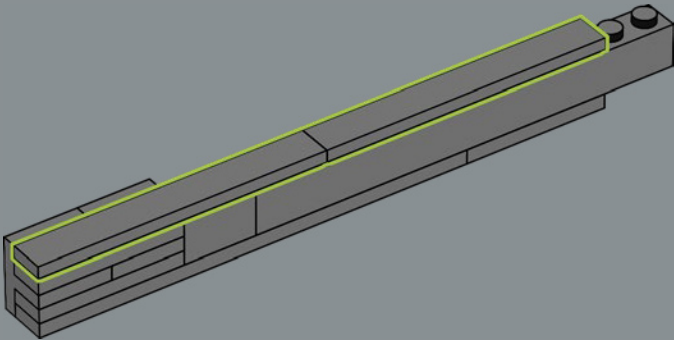

22

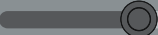
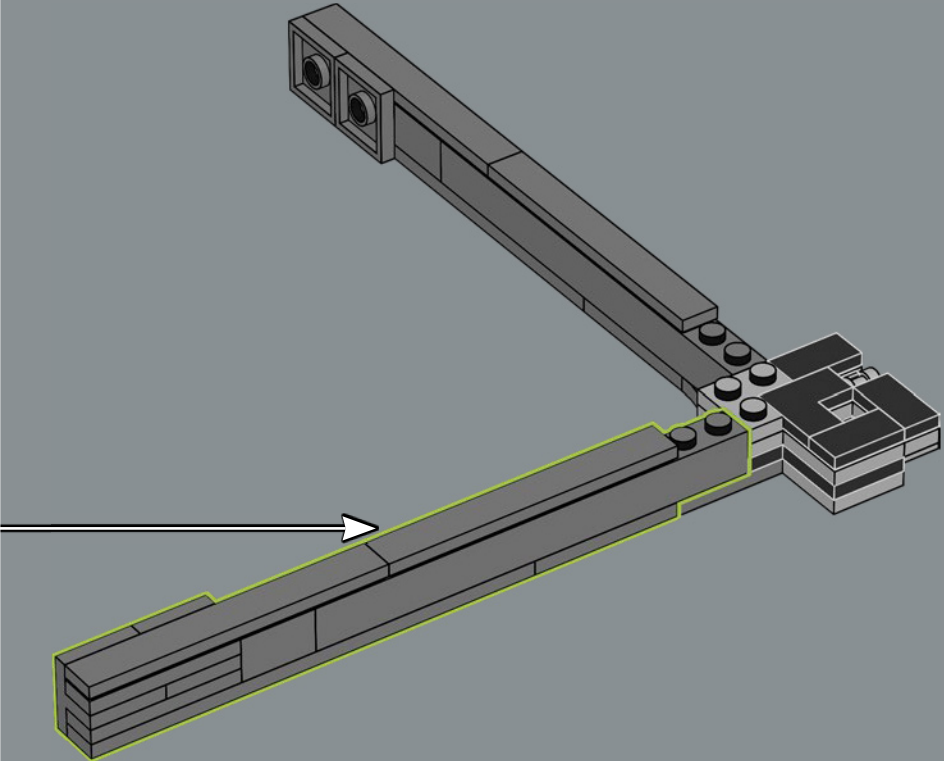

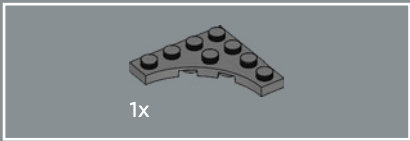

23

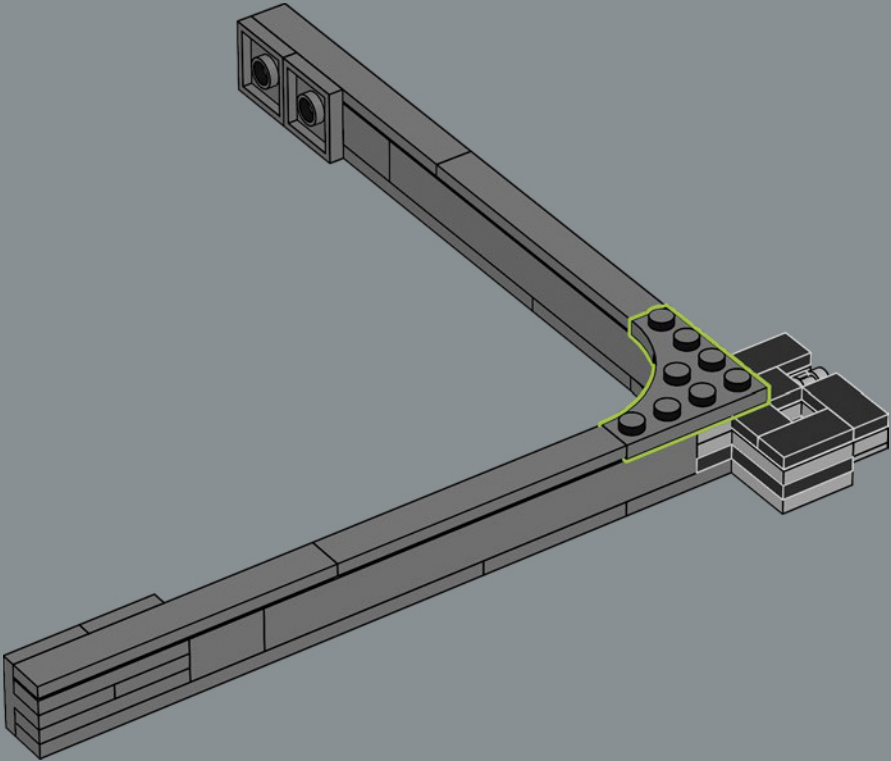

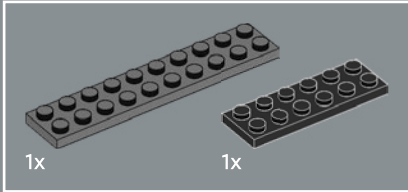
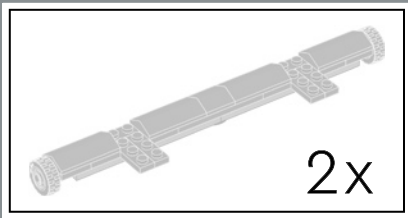

24

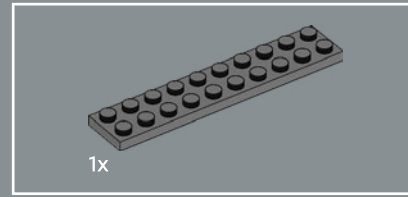
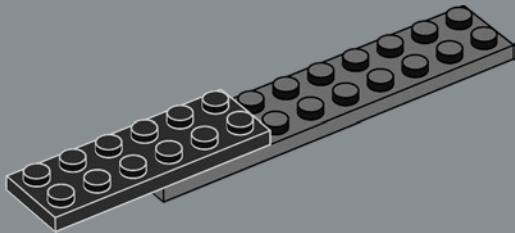

25

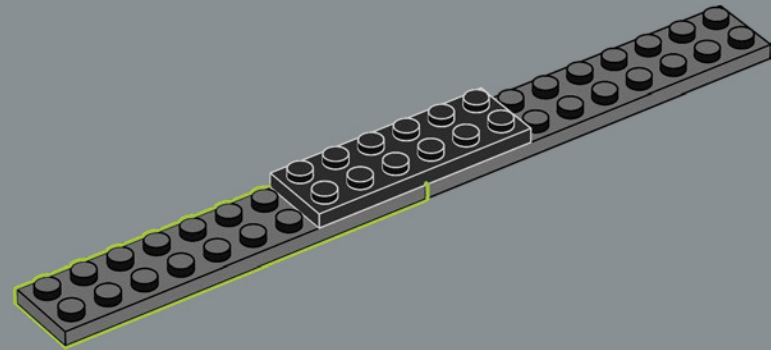

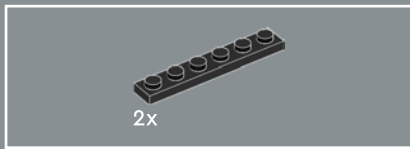

26

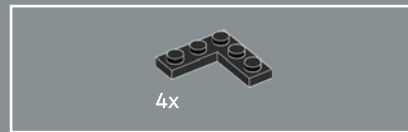
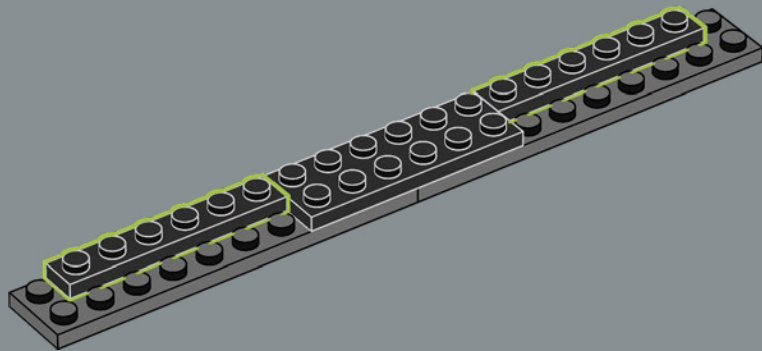

27

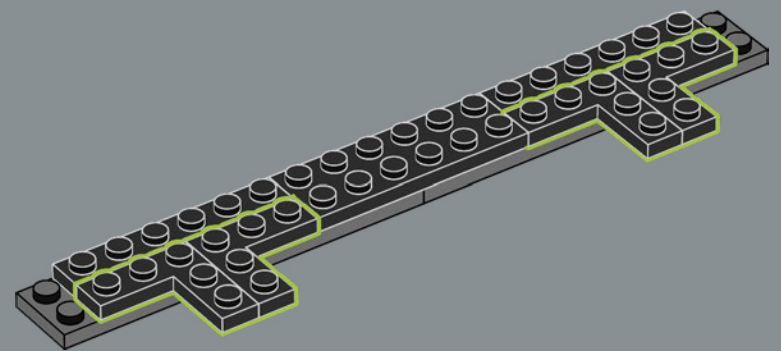



28

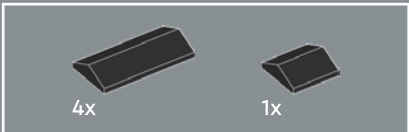
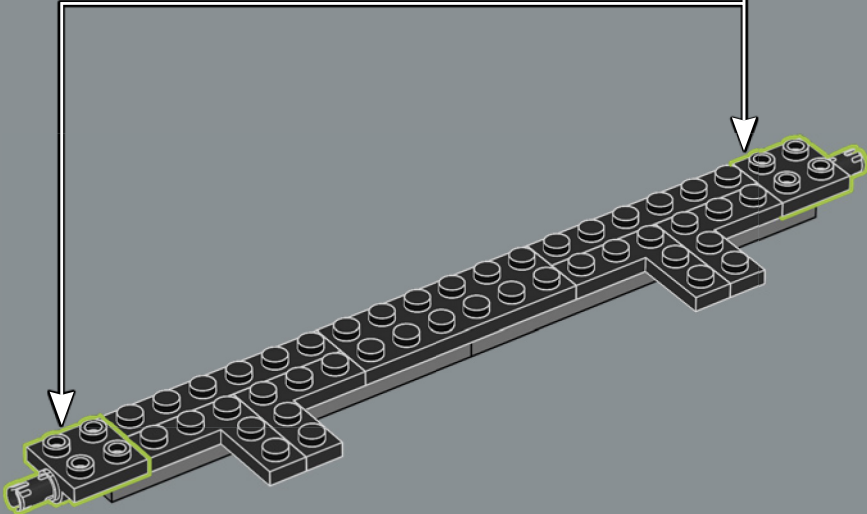
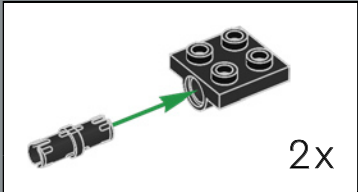

29

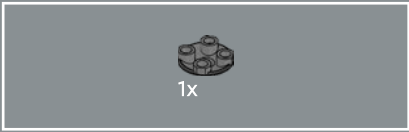
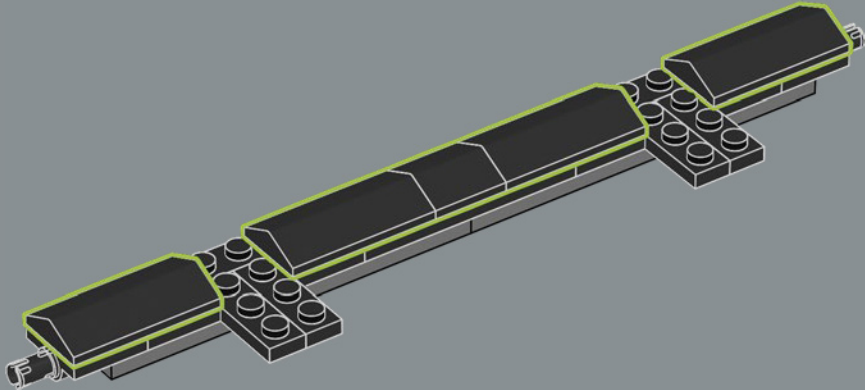

30

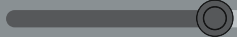
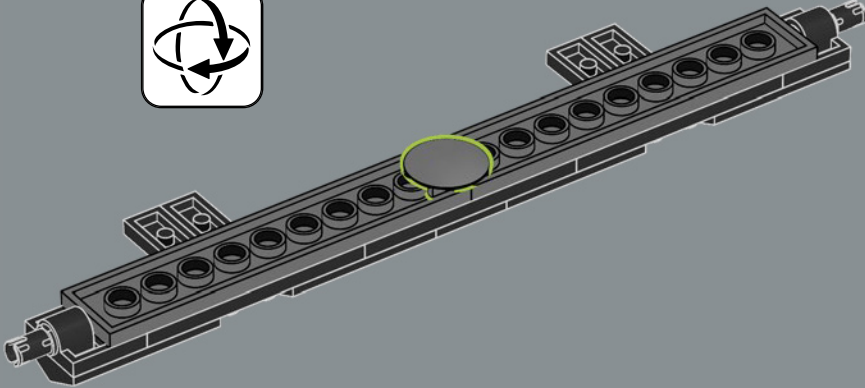



31

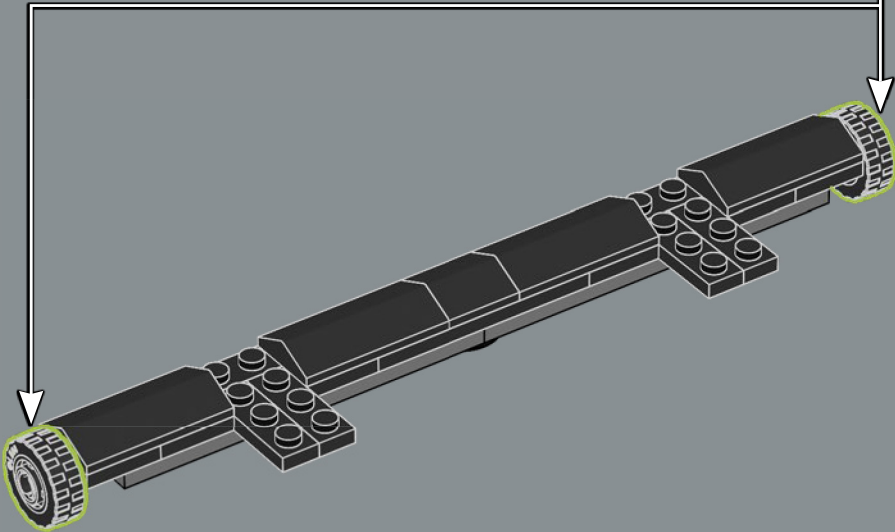
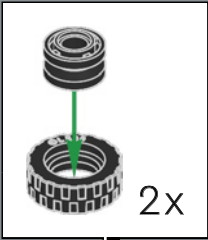

2x

32

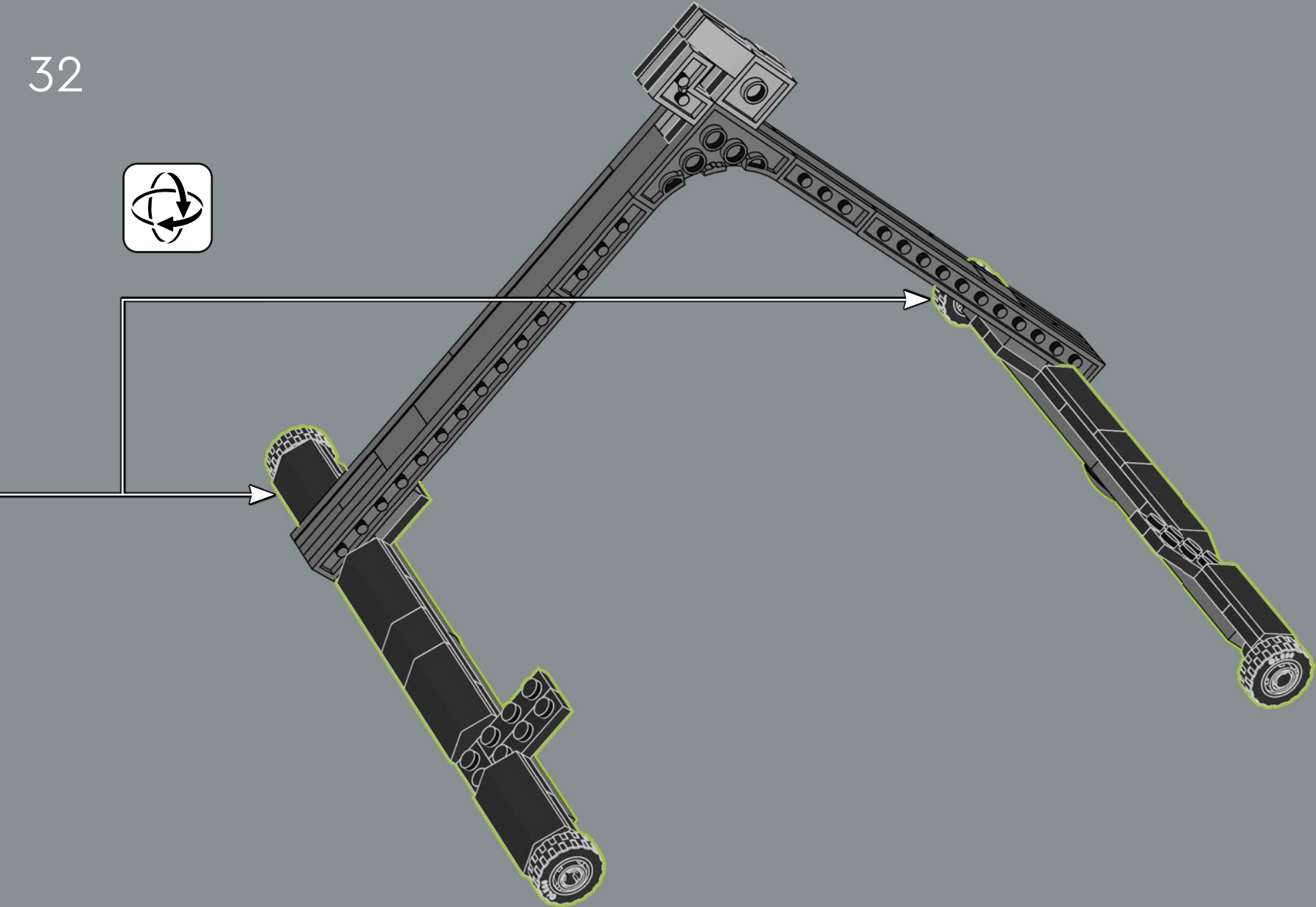

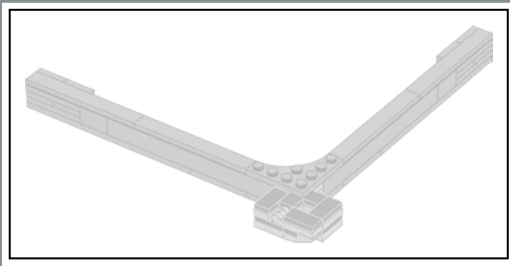

33

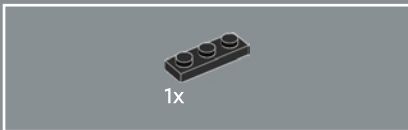
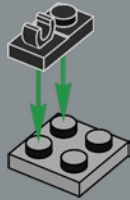

34

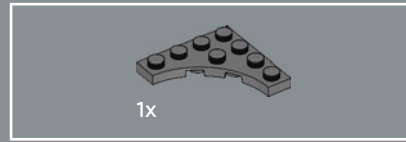
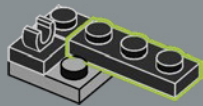

35

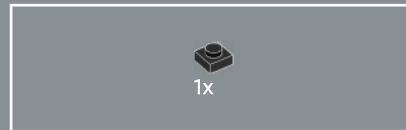
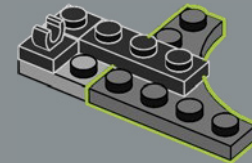

36

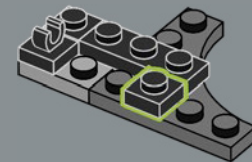

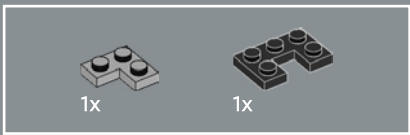

37

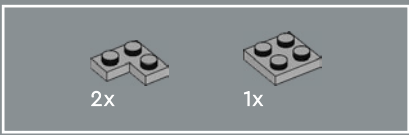
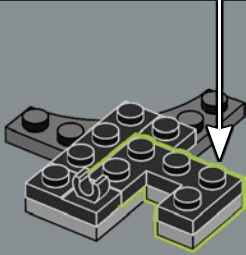
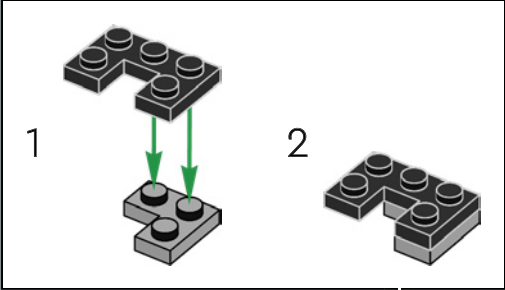

38

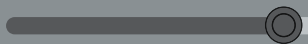
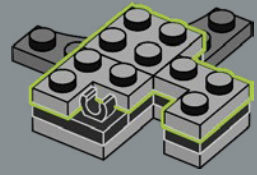

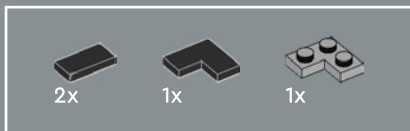

39

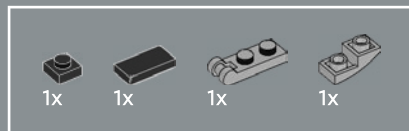
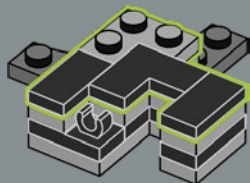

40

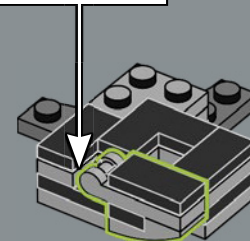
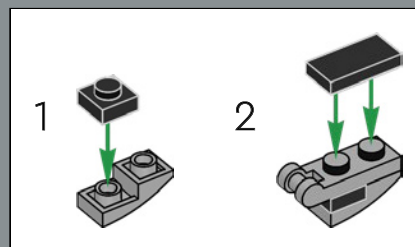

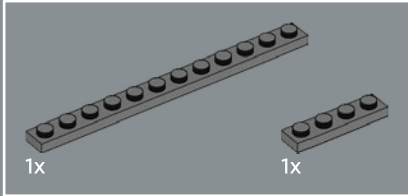
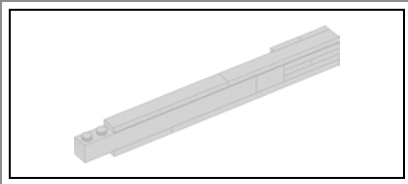

41

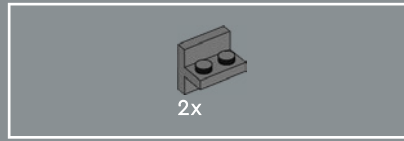
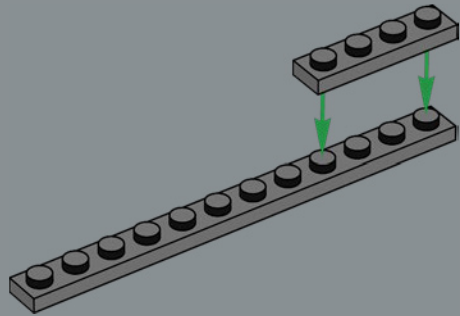

42

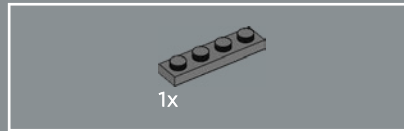
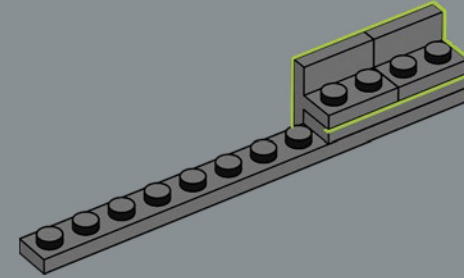

43

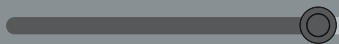
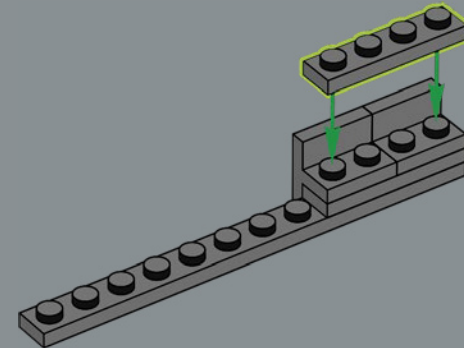

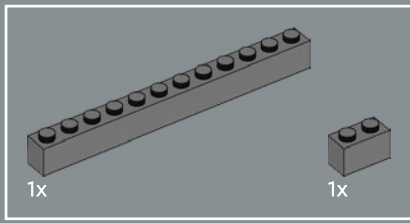

44

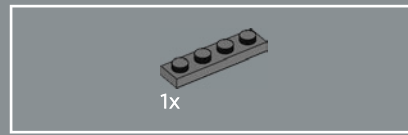
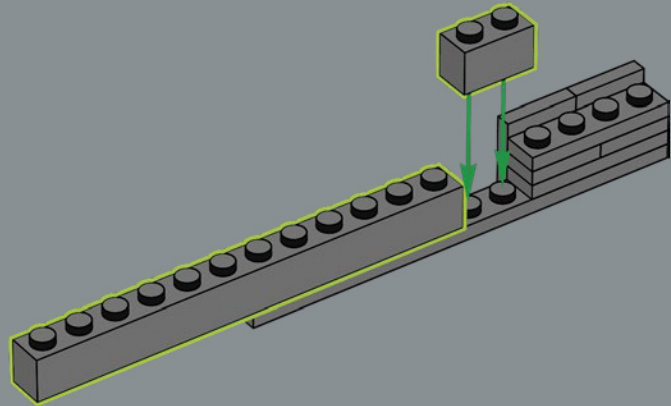

45

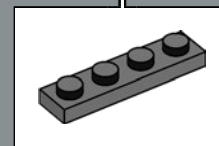
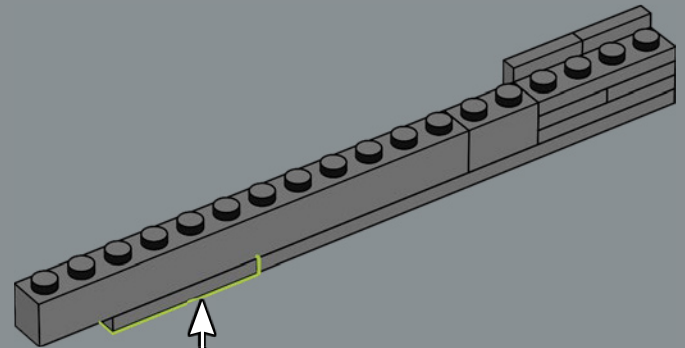

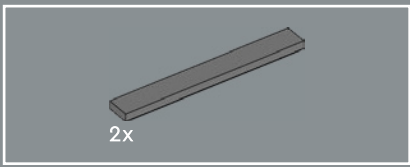

46

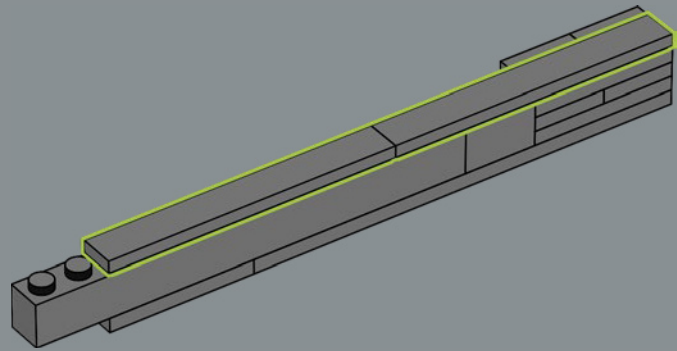

47

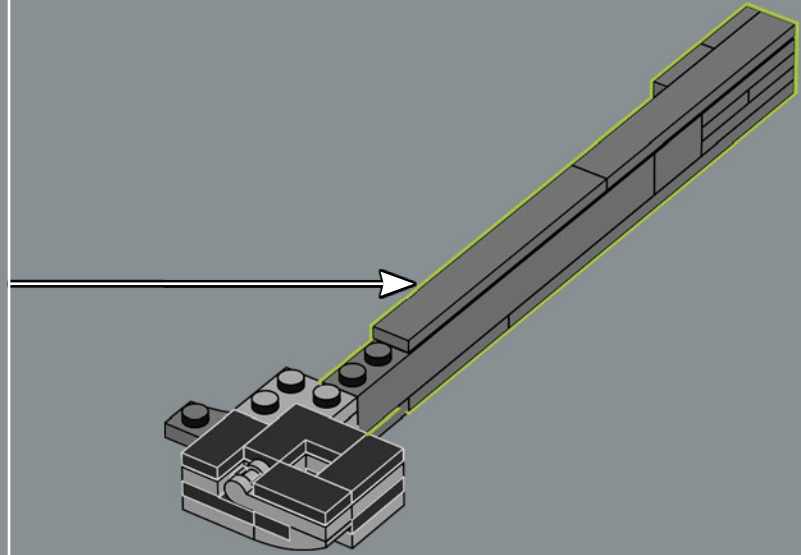

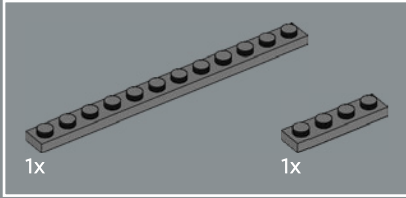
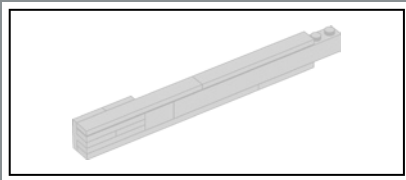

48

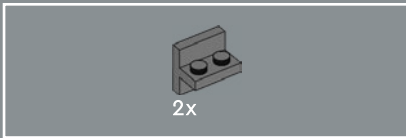
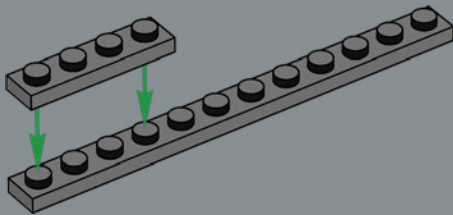

49

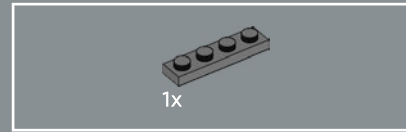
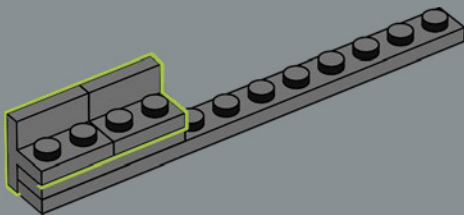

50

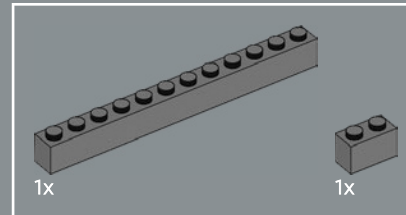
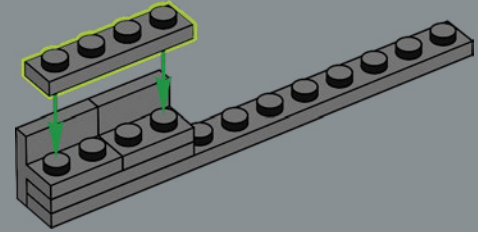

51

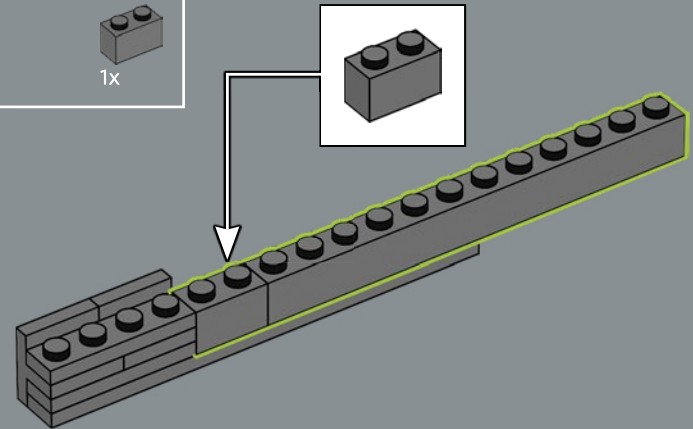

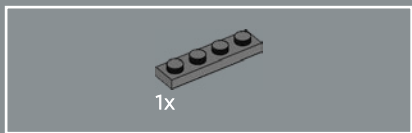

52

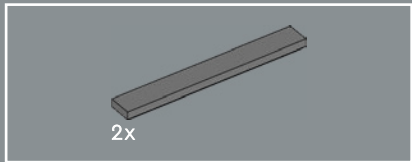
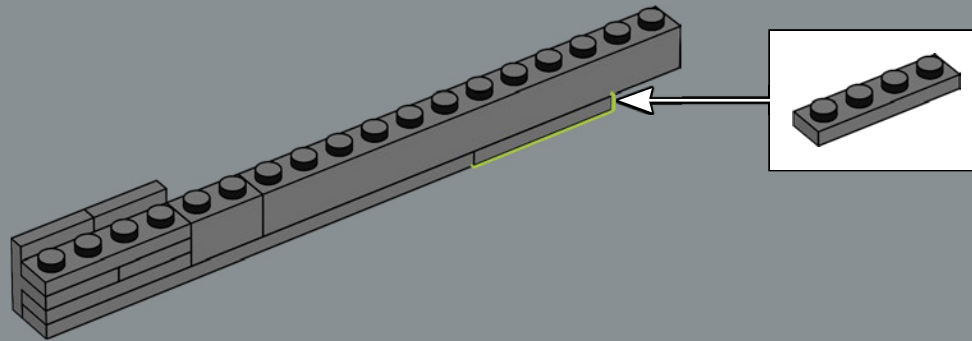

53

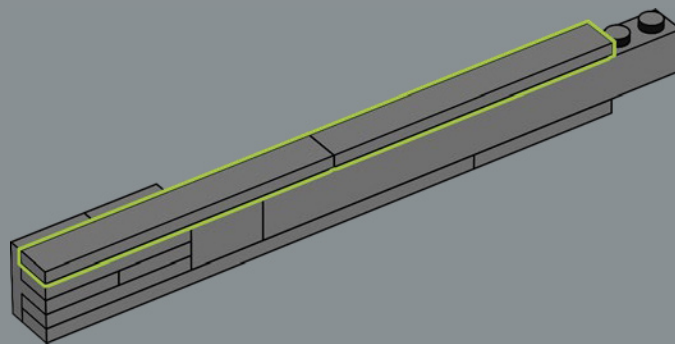

54

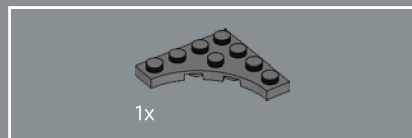
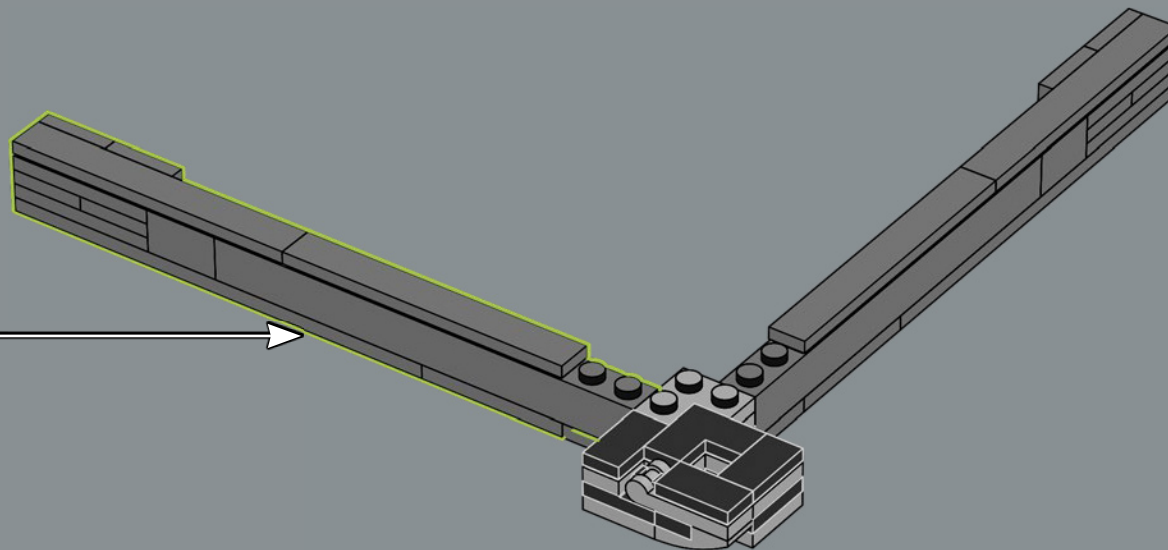

55

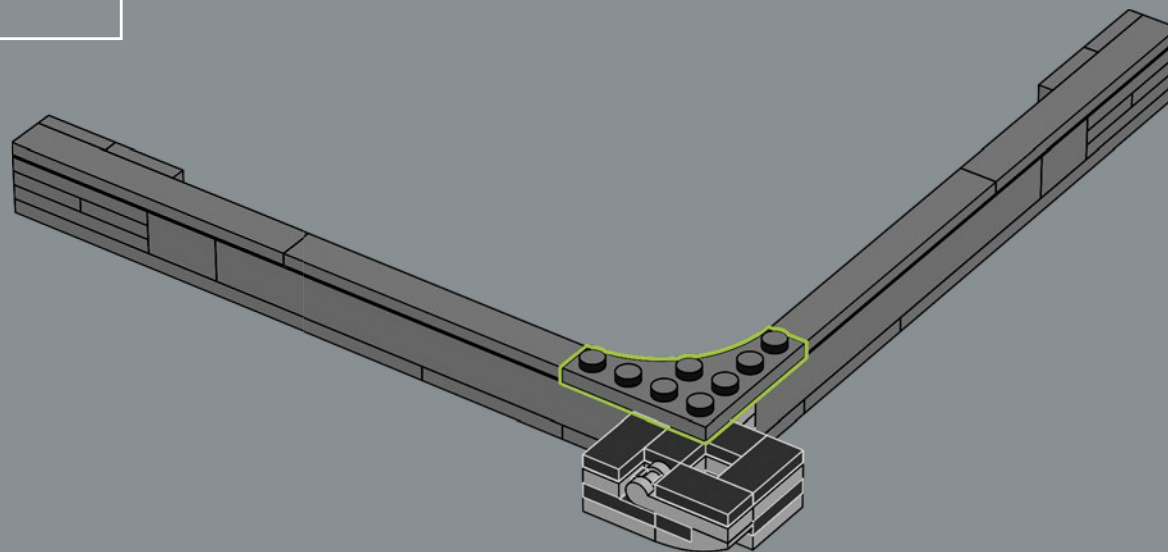

56

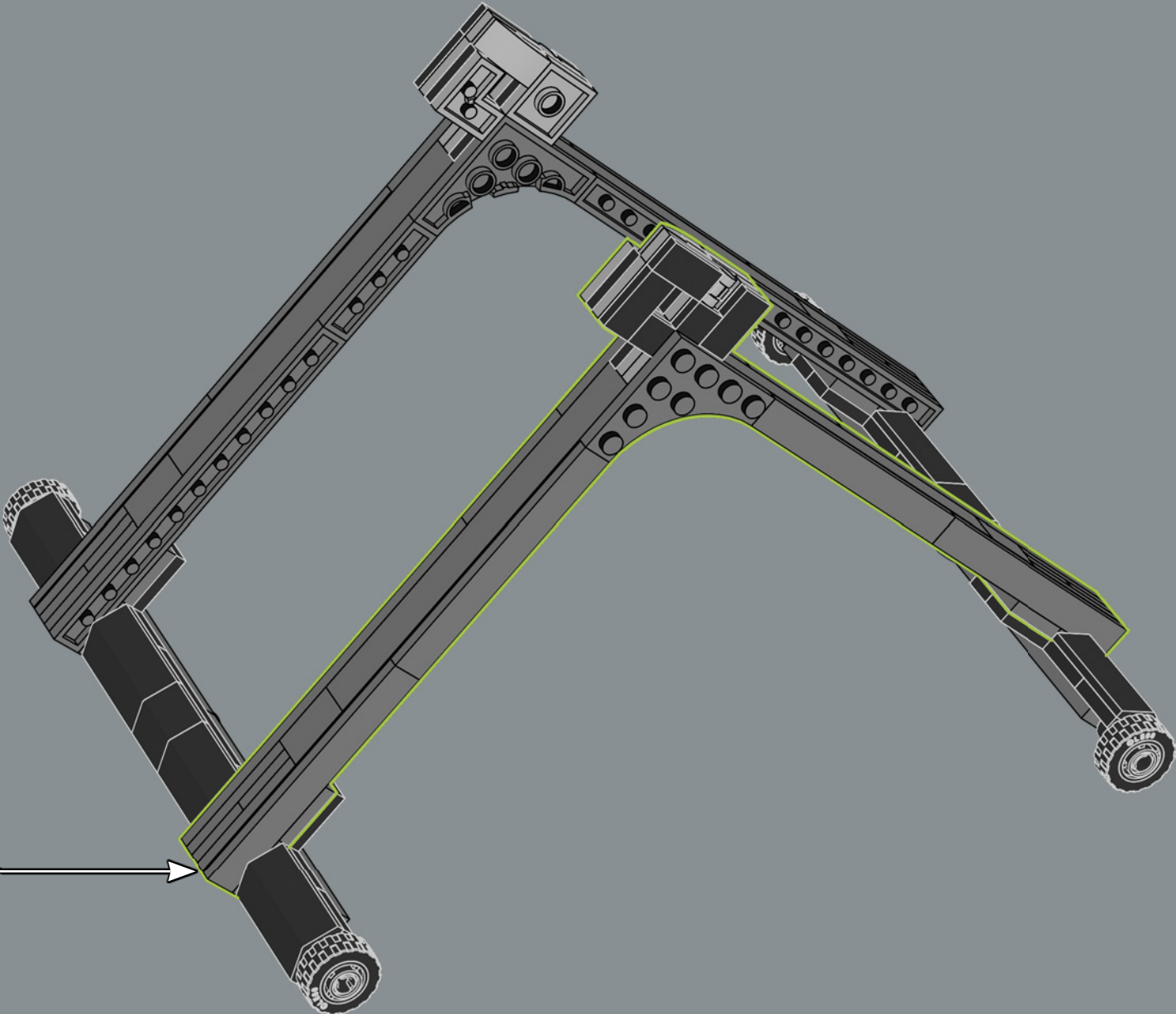

57

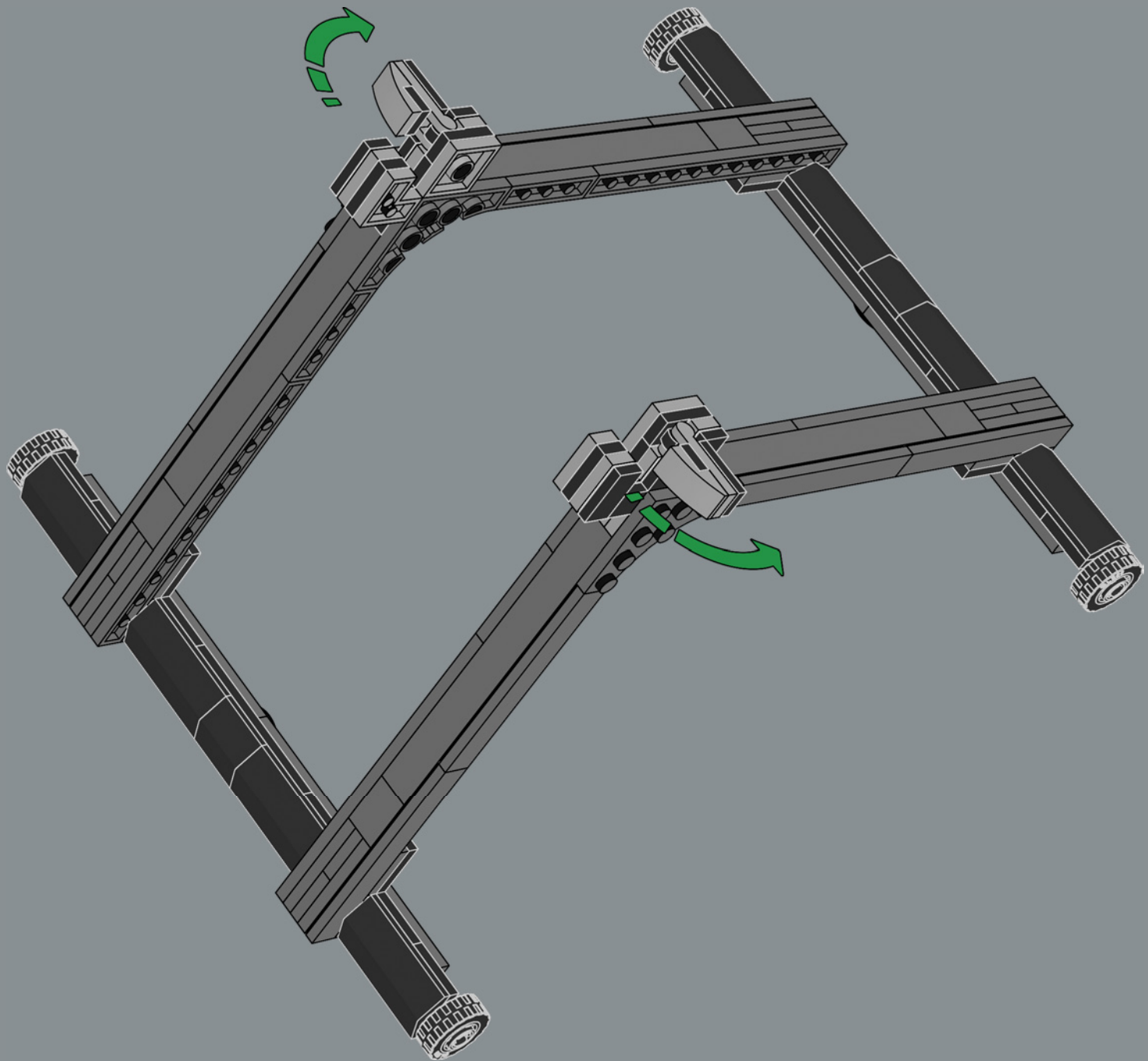

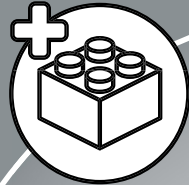

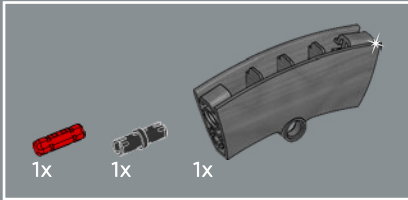
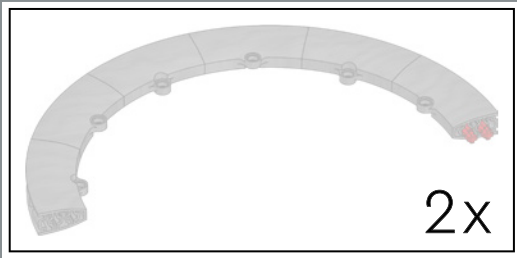
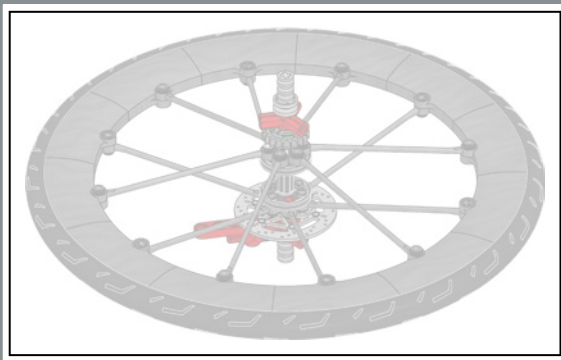

58

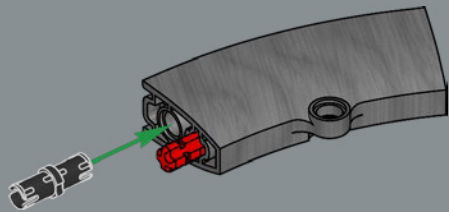

LEGO® tires usually sit on a single wheel element. This is the first buildable LEGO wheel designed as part of a model.

Les pneus LEGO® sont habituellement fixés sur un seul élément de roue. Il s'agit de la première roue LEGO à construire conçue comme partie intégrante d'un modèle.

Las llantas LEGO® suelen montarse en un elemento de rueda de una sola pieza. Esta es la primera rueda LEGO construible diseñada para formar parte de un modelo.

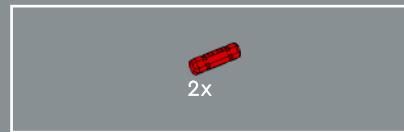

59

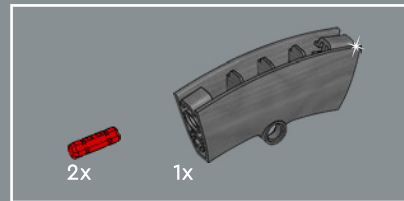
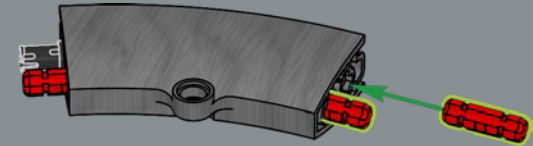

60

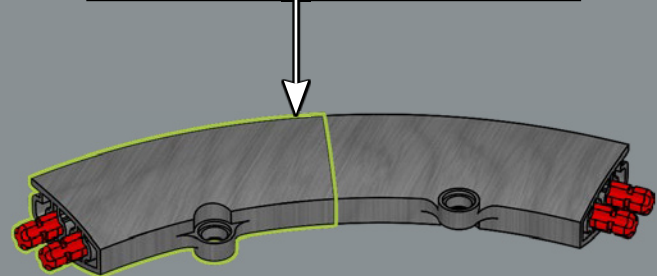
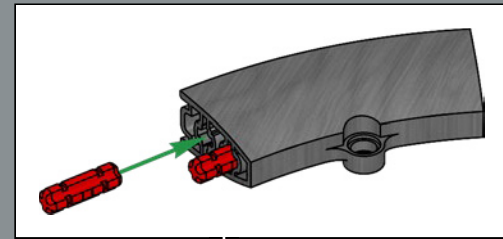

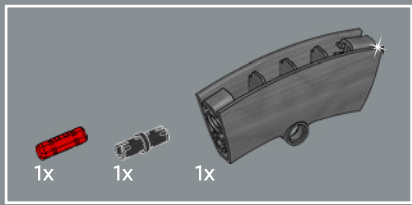

61

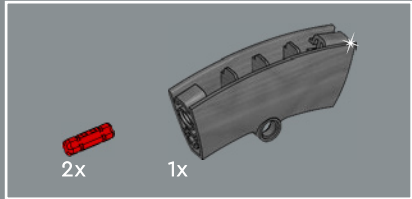
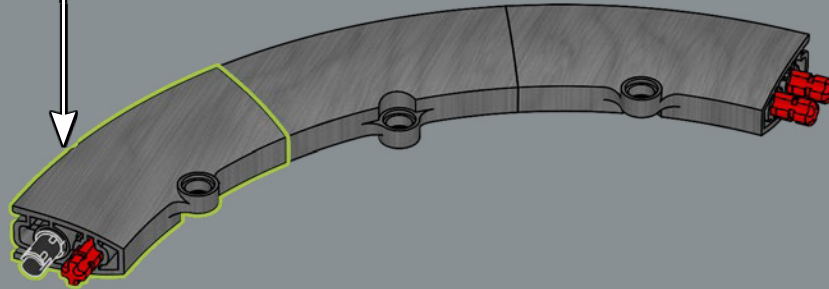
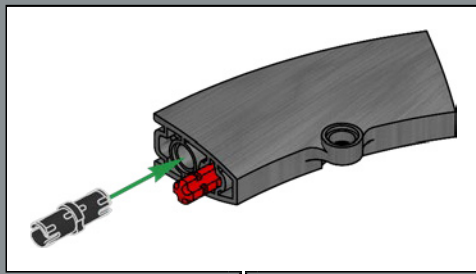

62

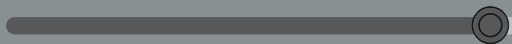
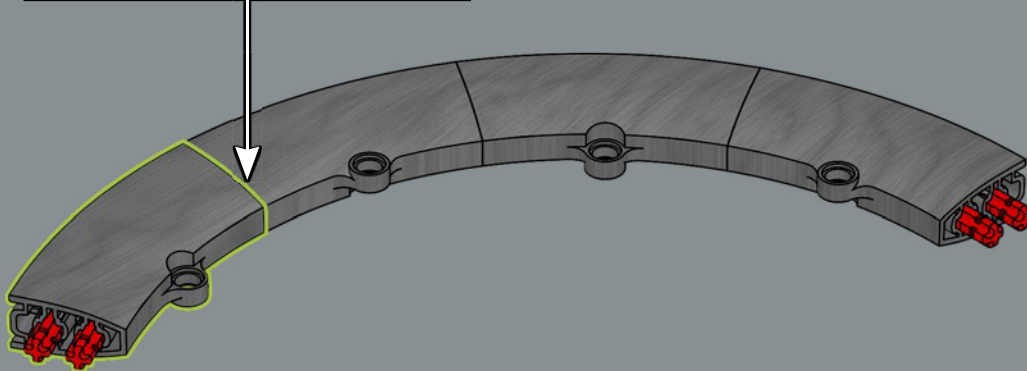
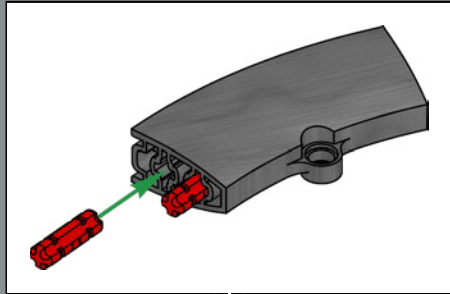

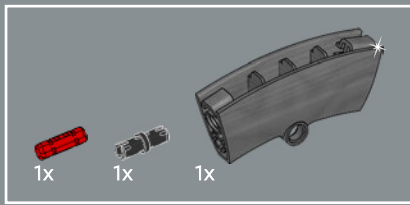

63

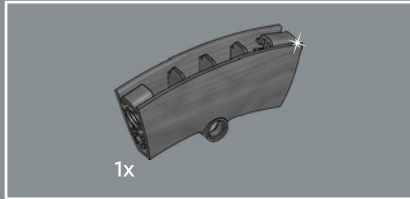
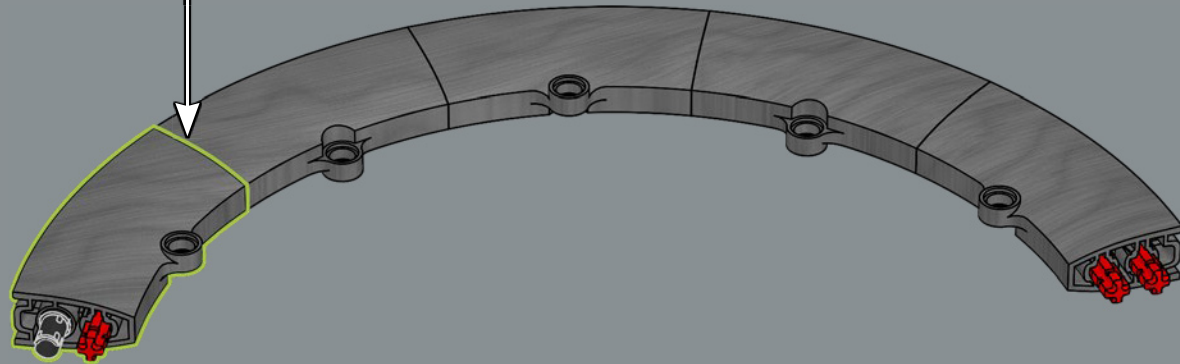
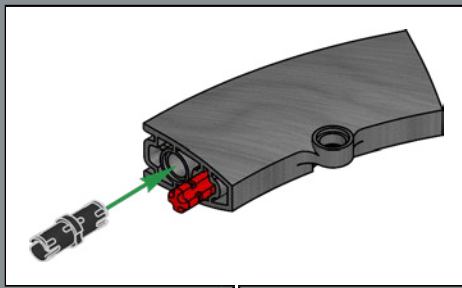

64

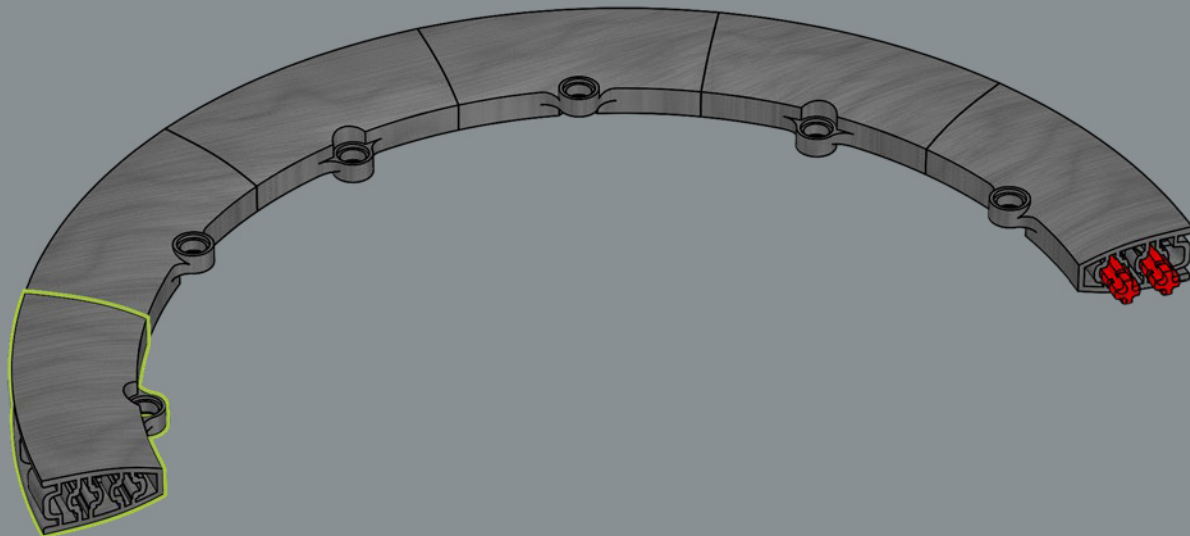

2x

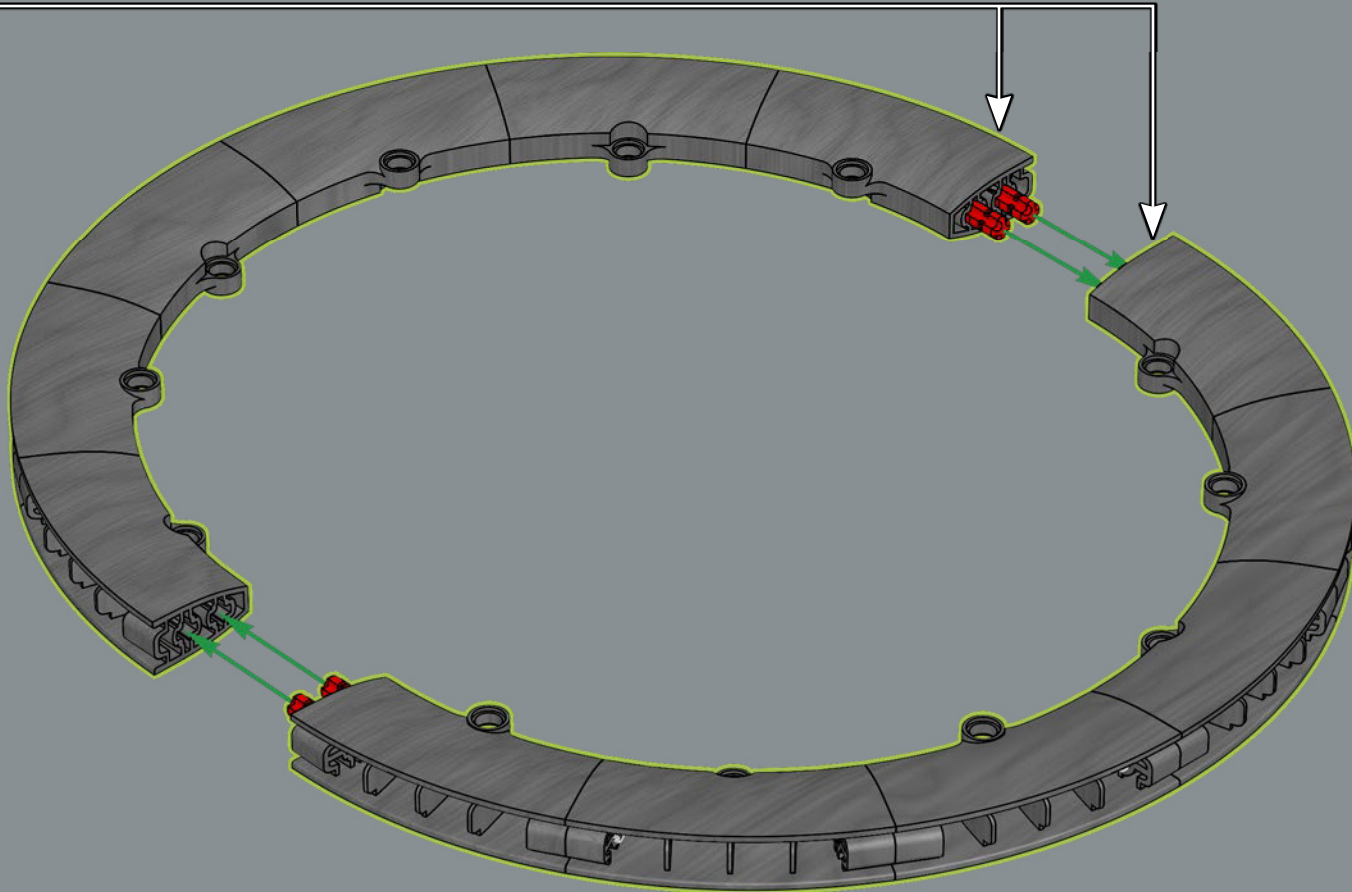



66

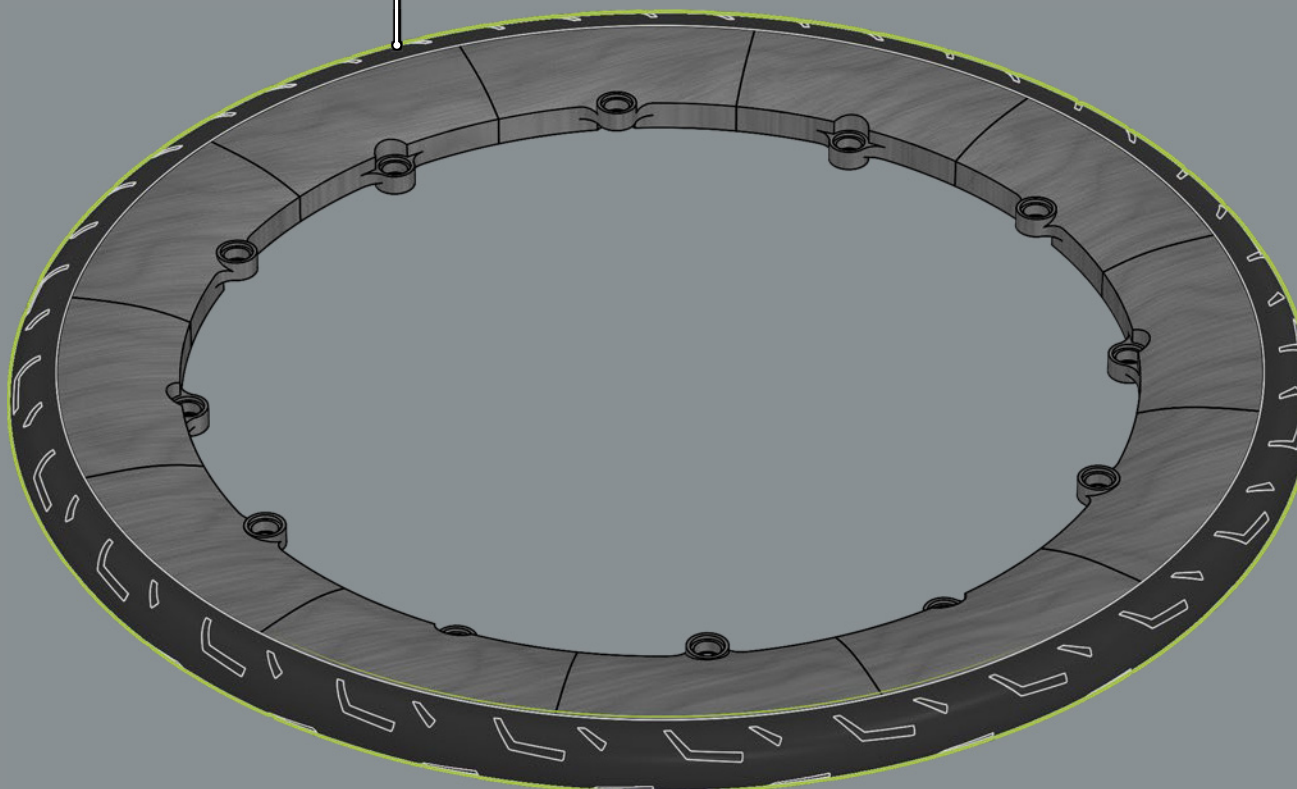
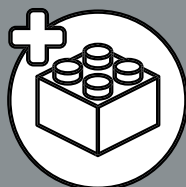

This is the biggest LEGO® tire produced to date.
Il s'agit du plus grand pneu LEGO® jamais produit à ce jour.
Esta es la llanta LEGO® más grande fabricada hasta la fecha.

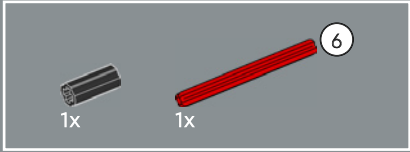
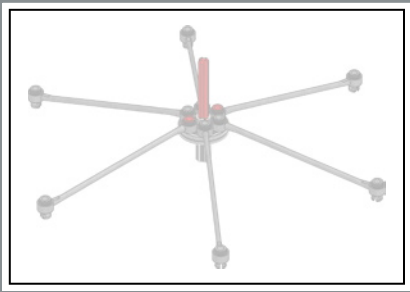

67

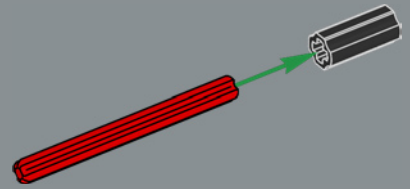

68

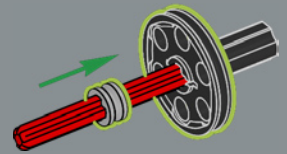

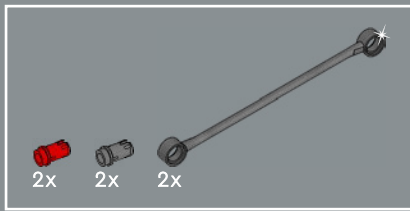

69

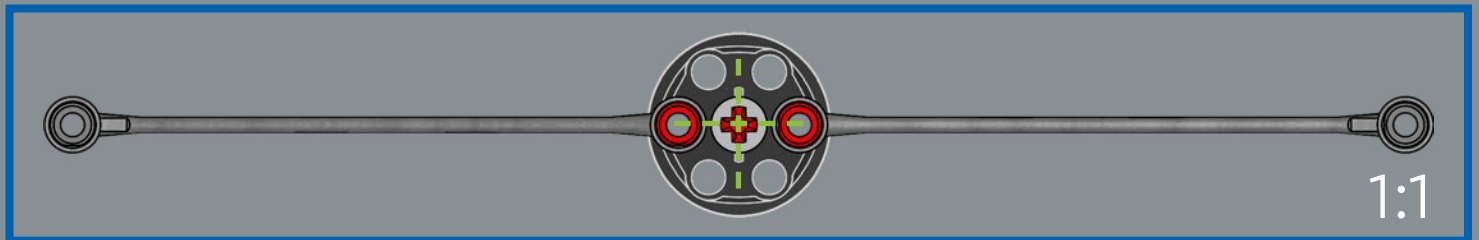
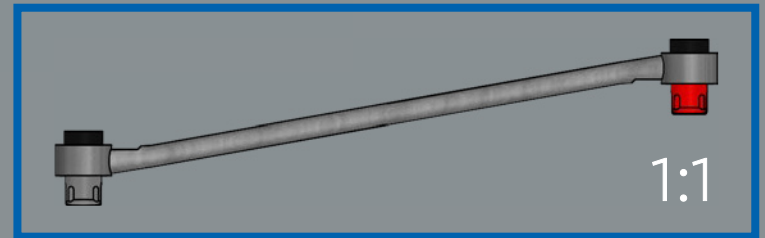
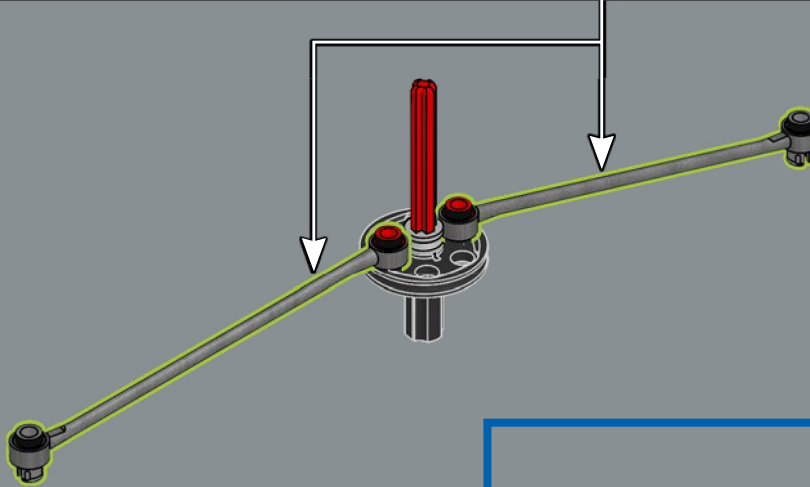
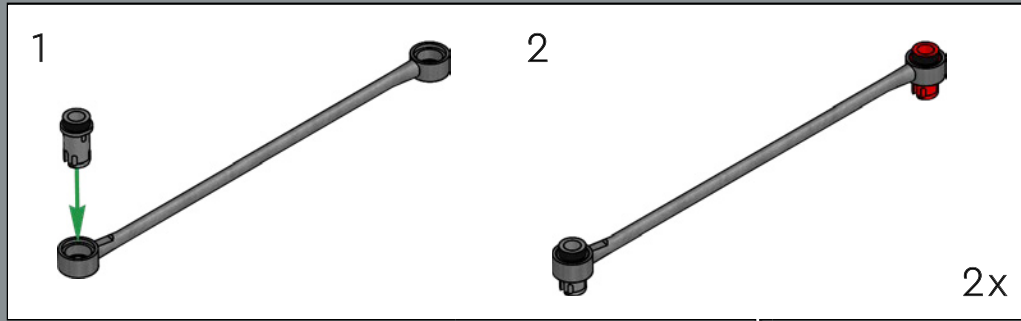

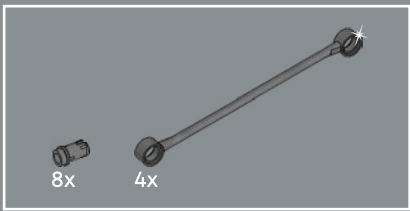

70

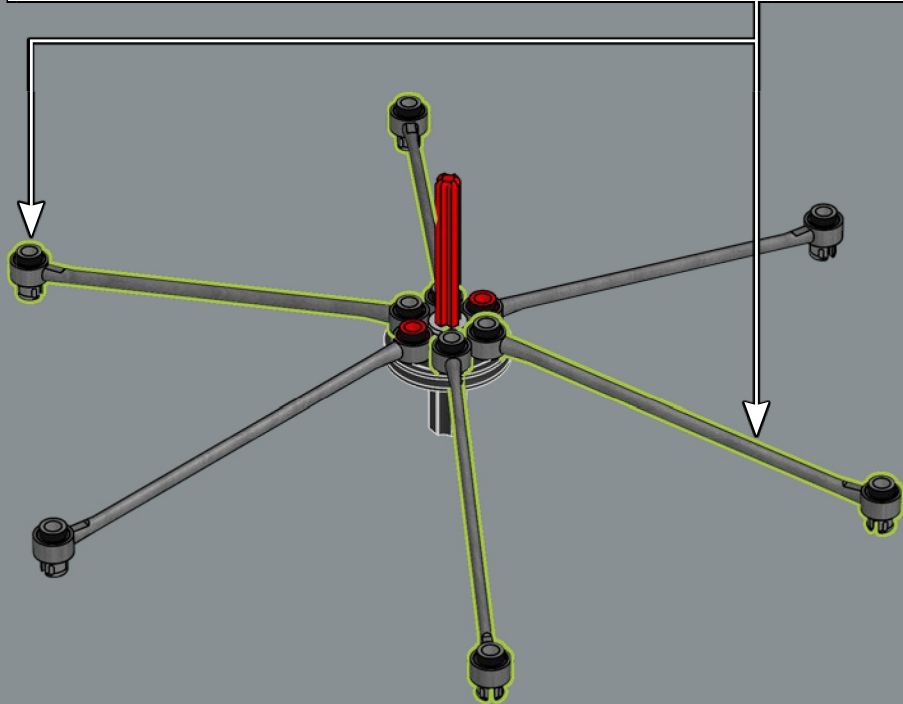
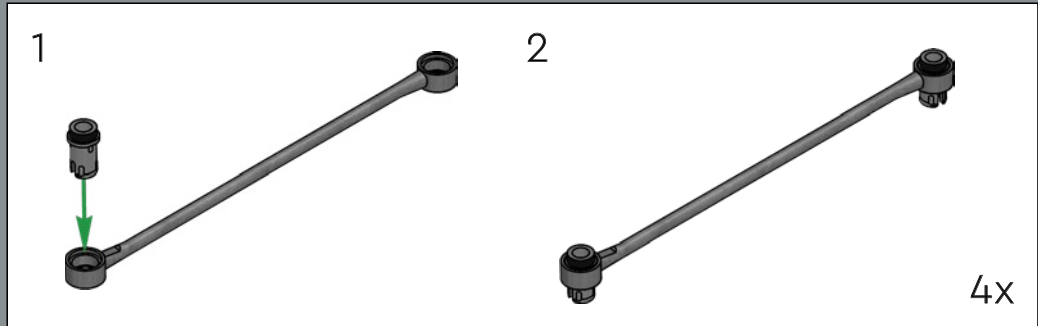

71

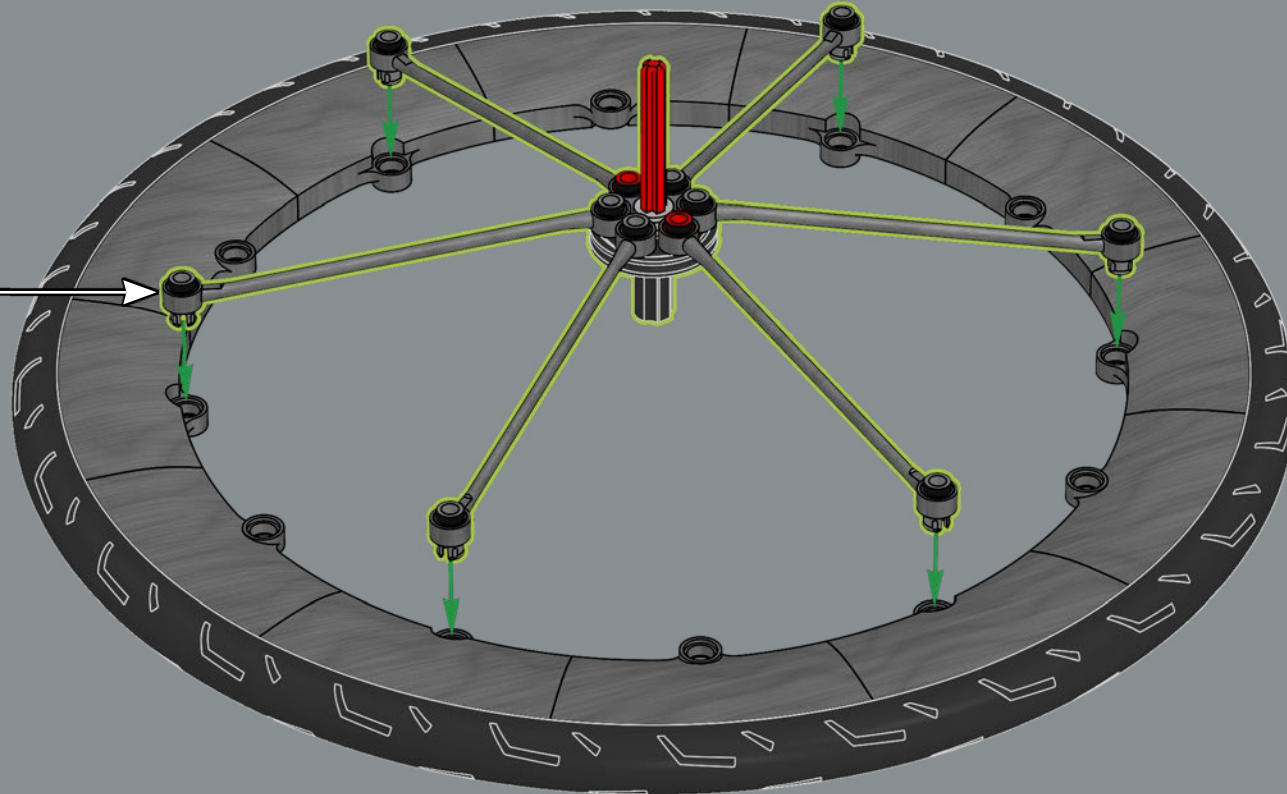
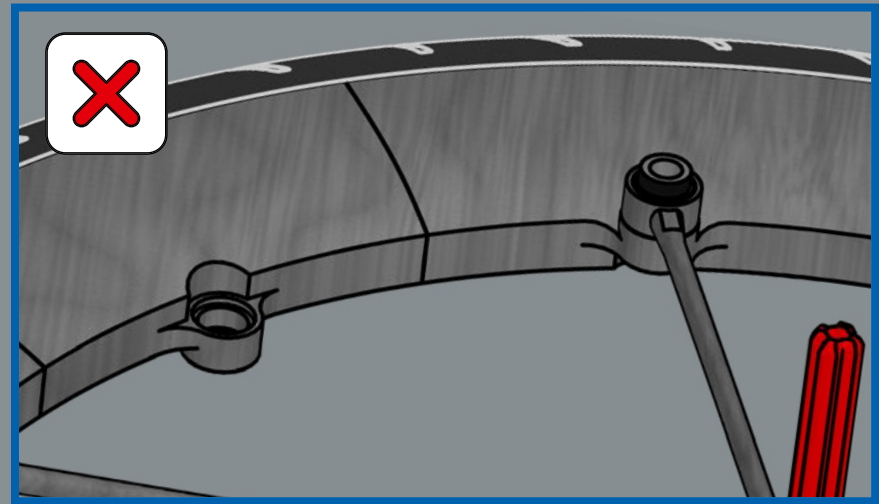
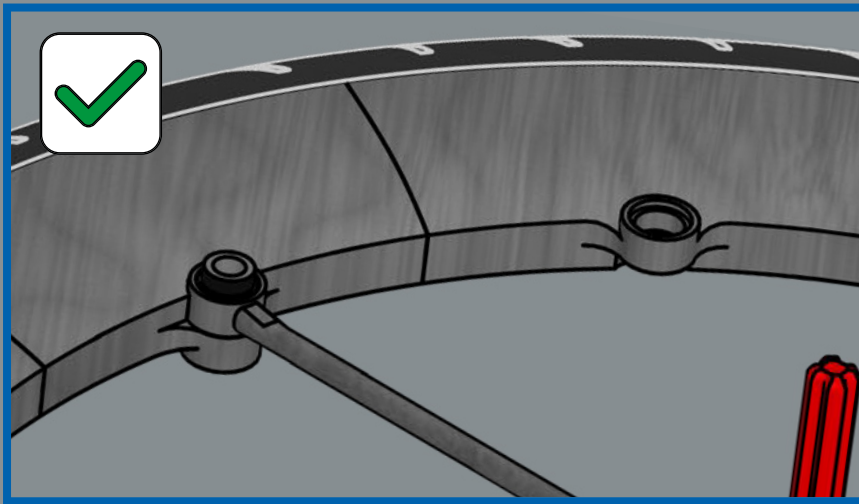

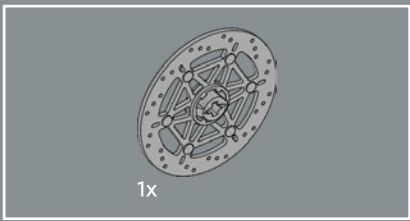

72

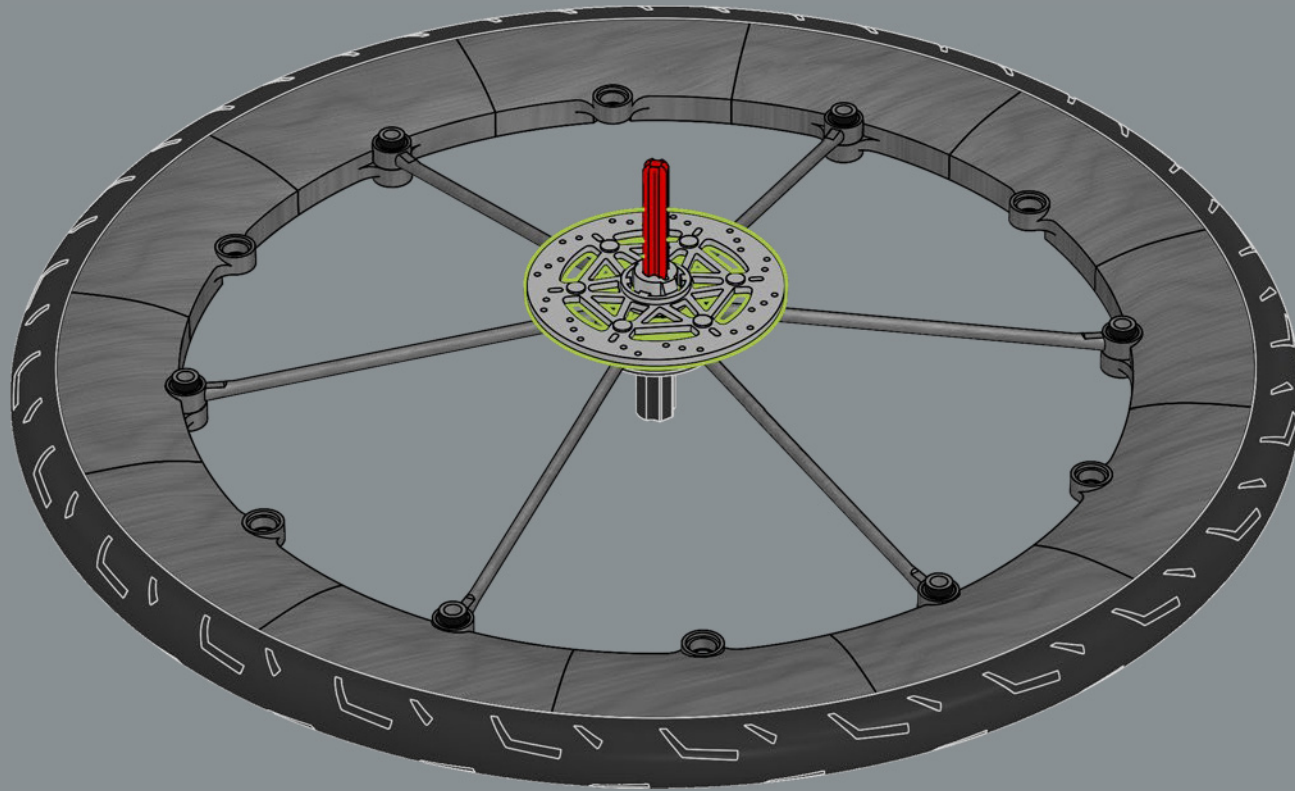

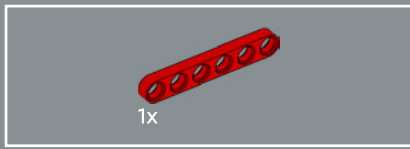

73

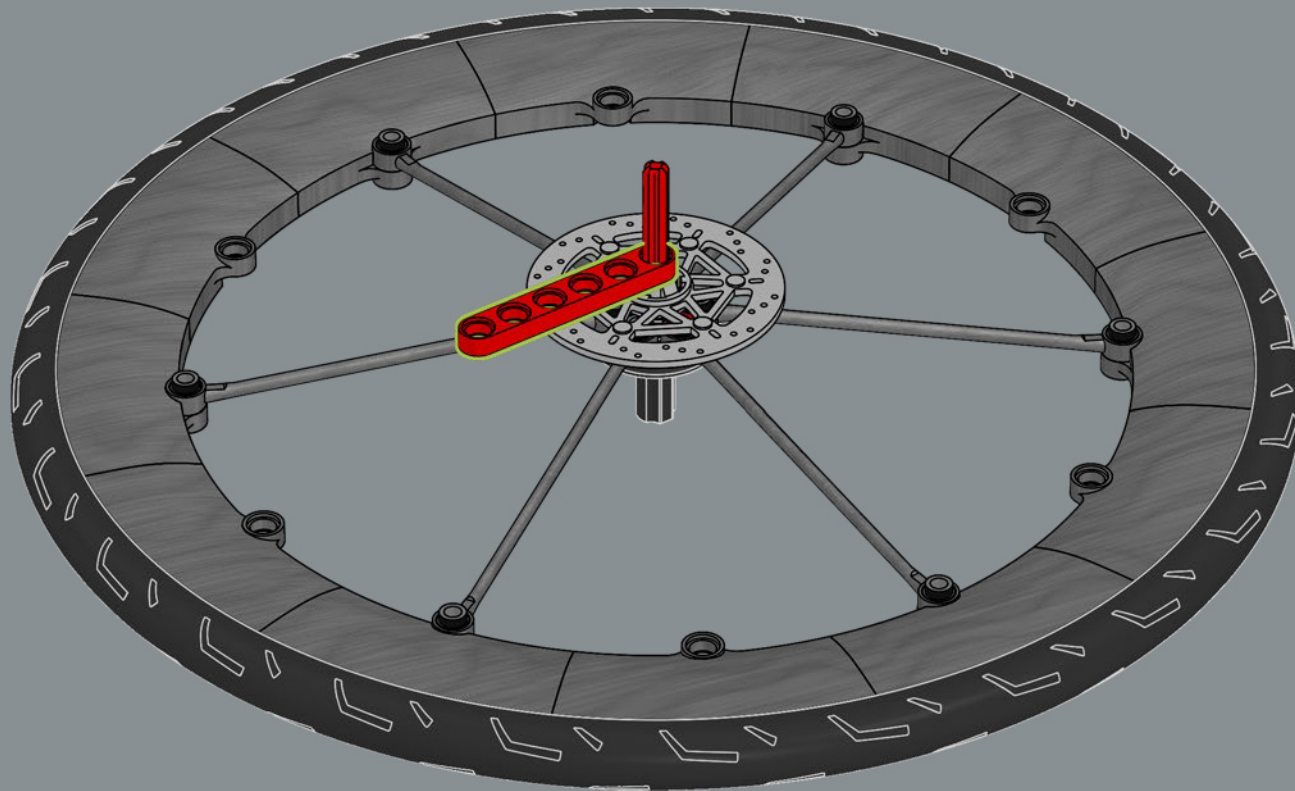

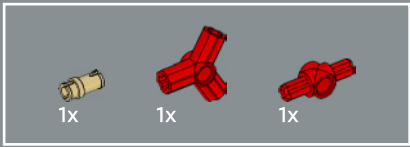

74

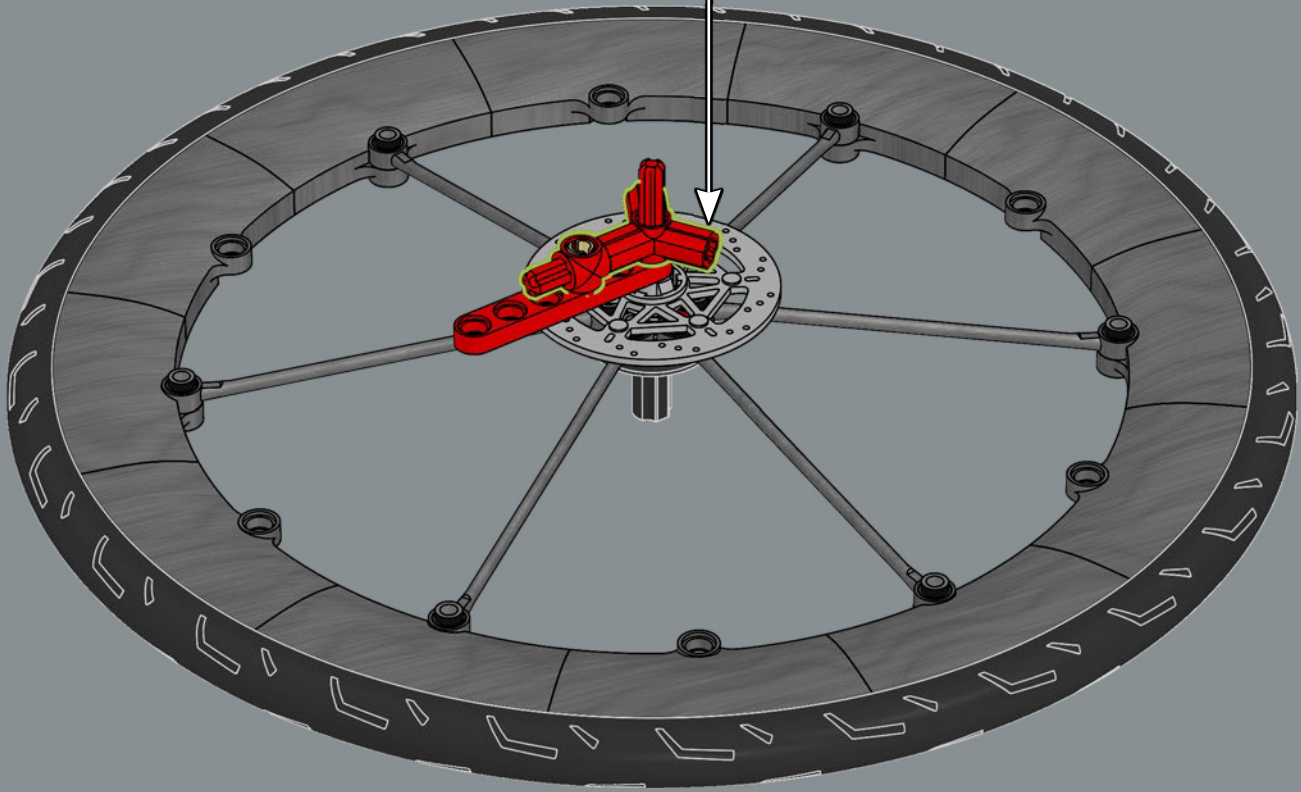
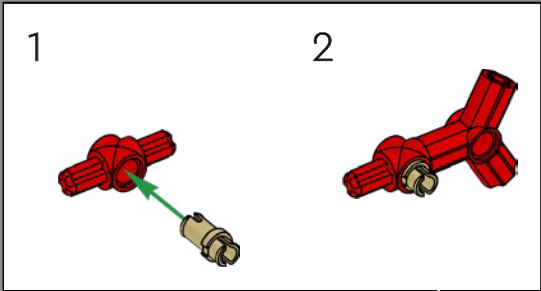



75

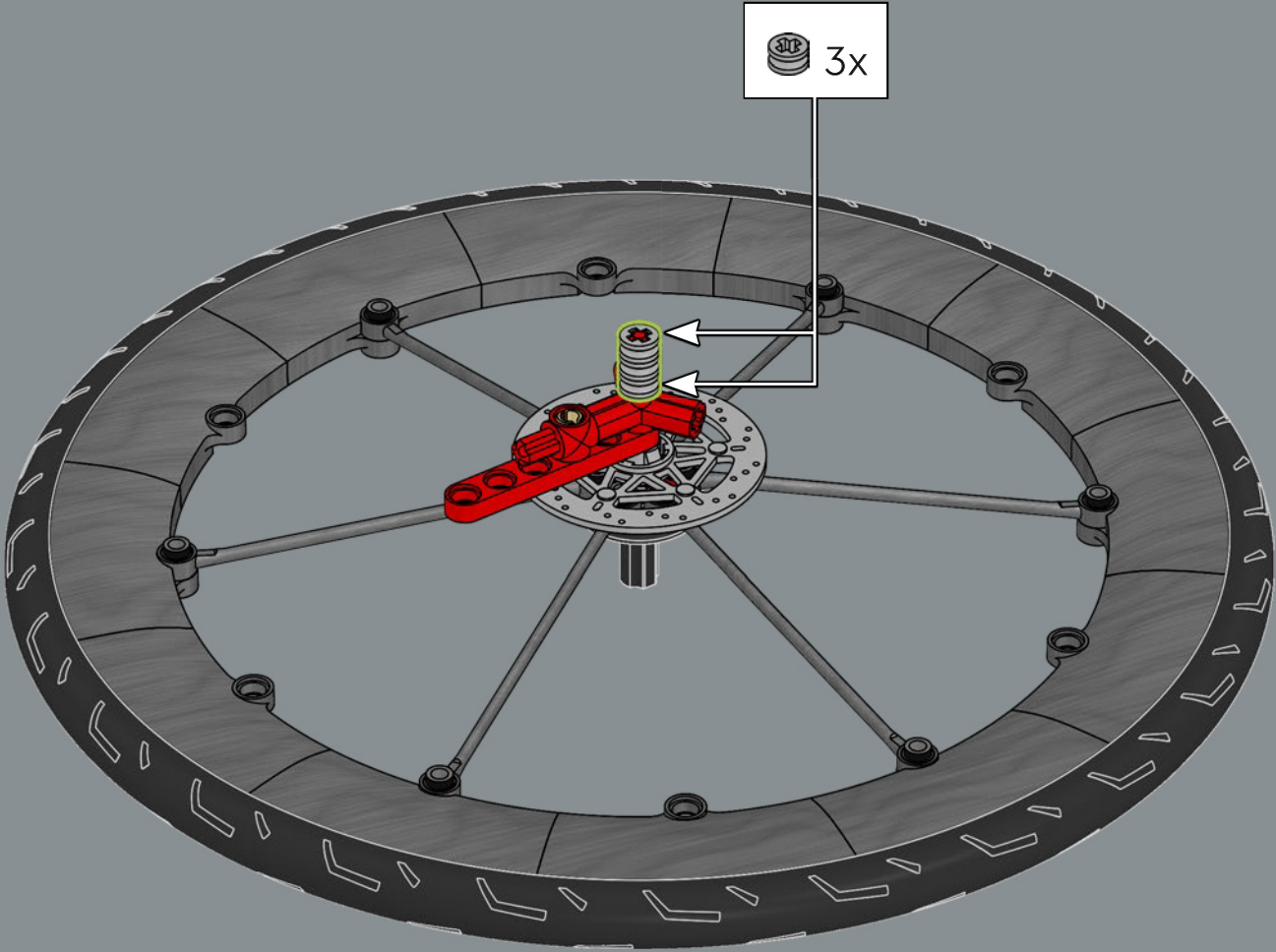

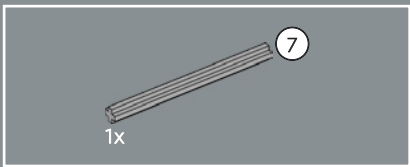

76

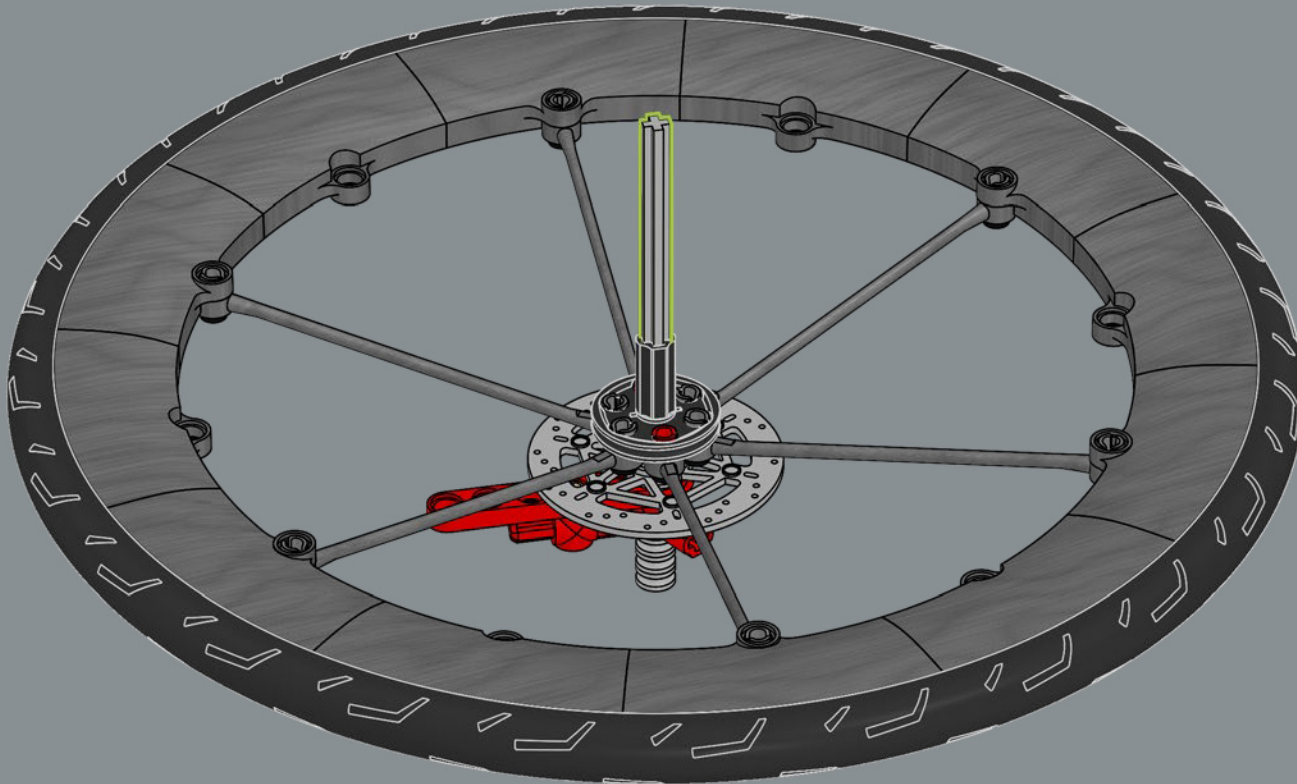



77

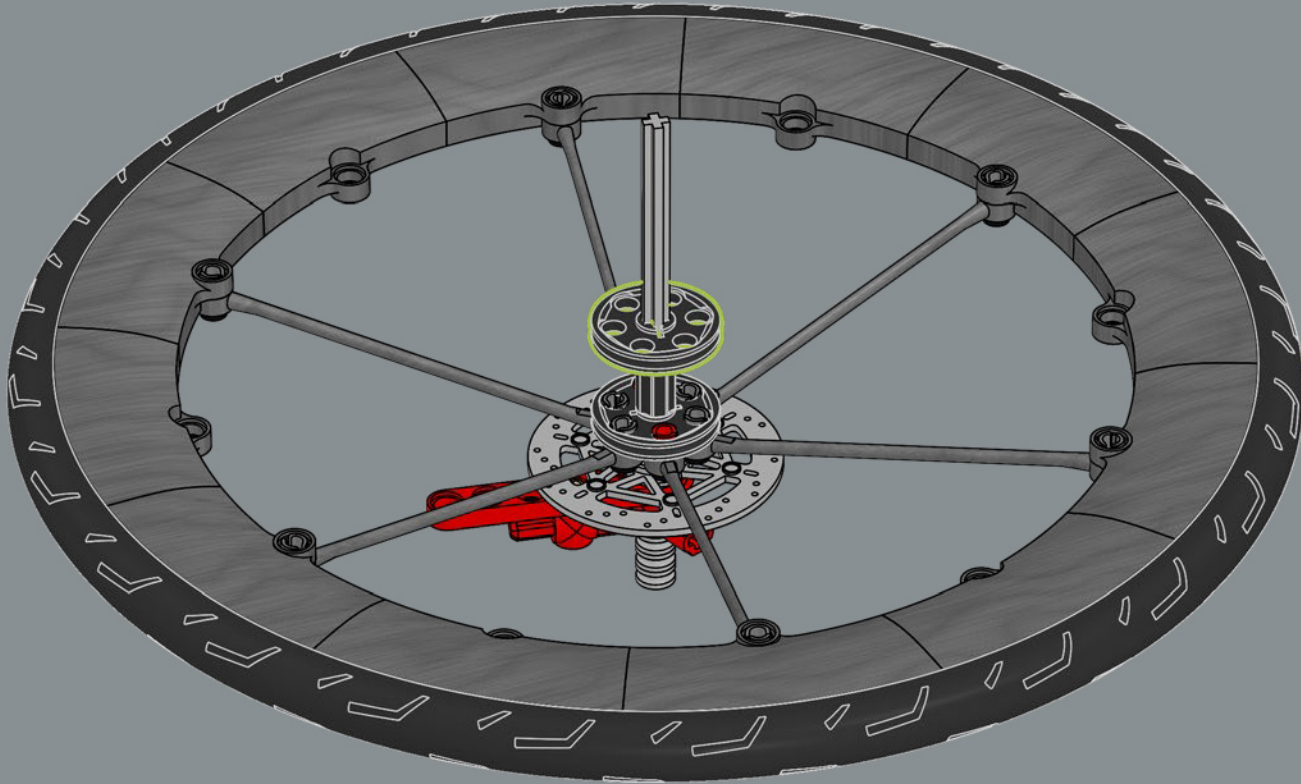
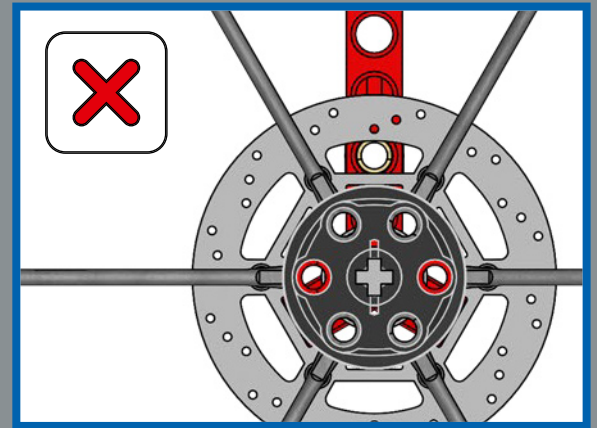
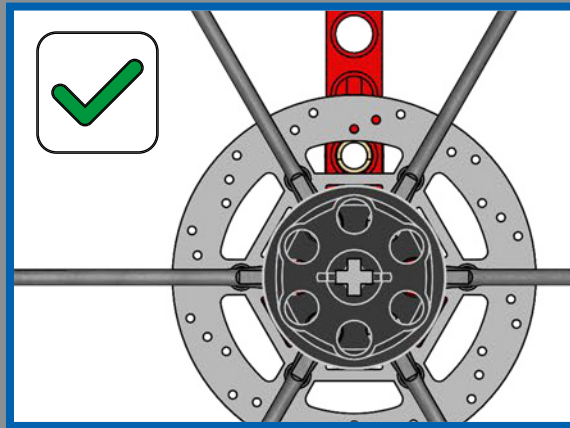

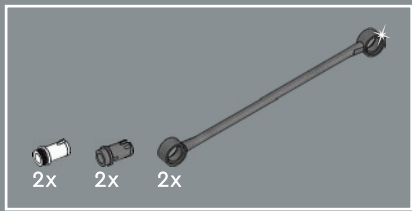

78

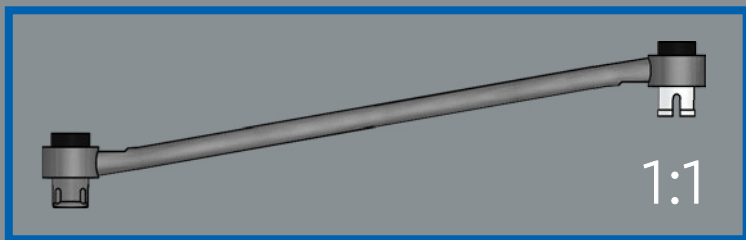
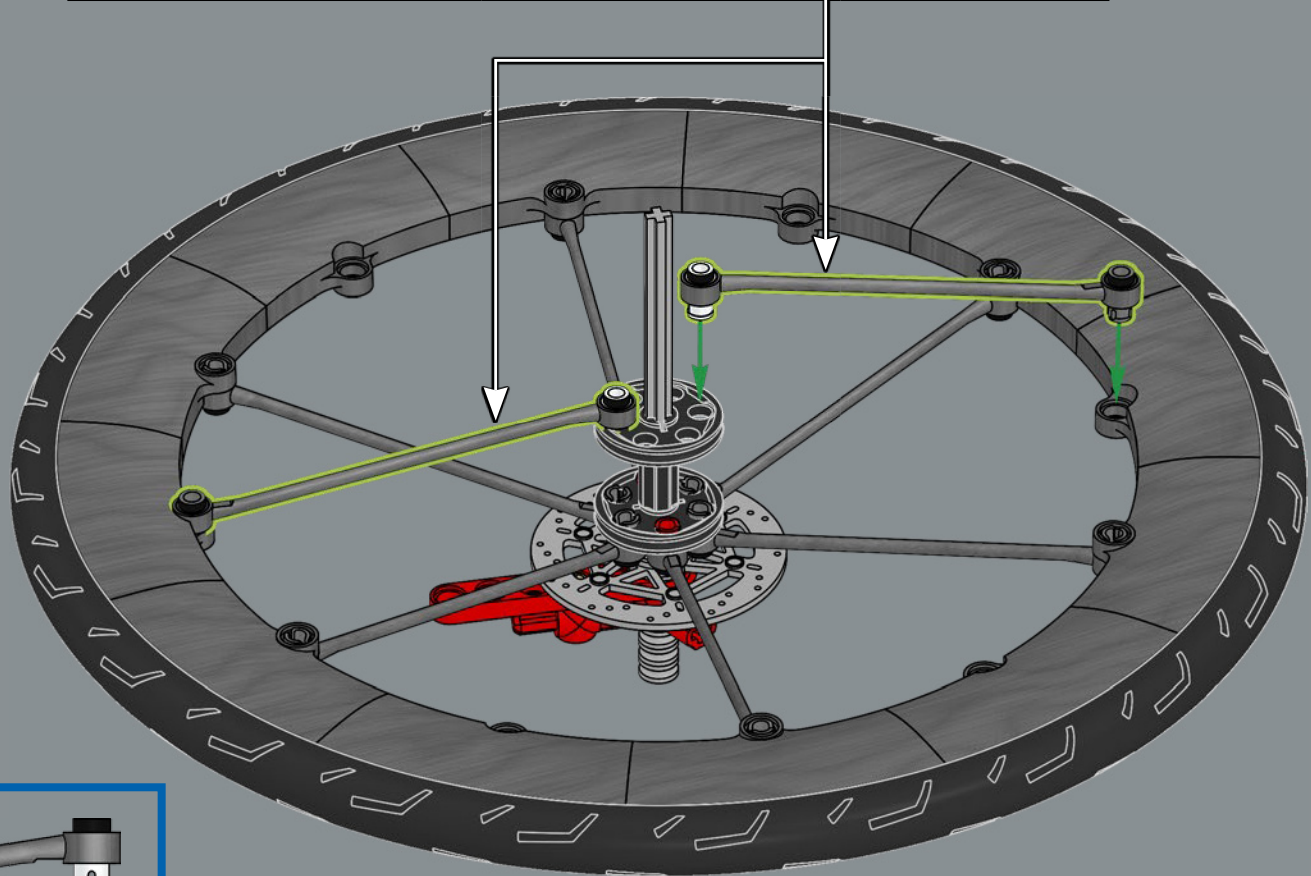
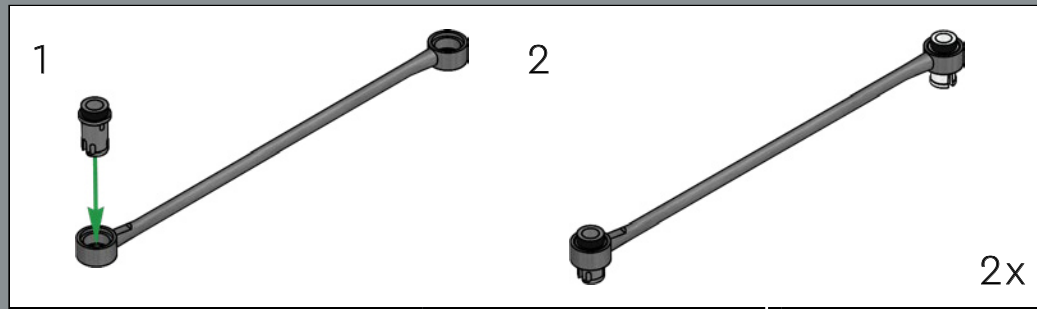

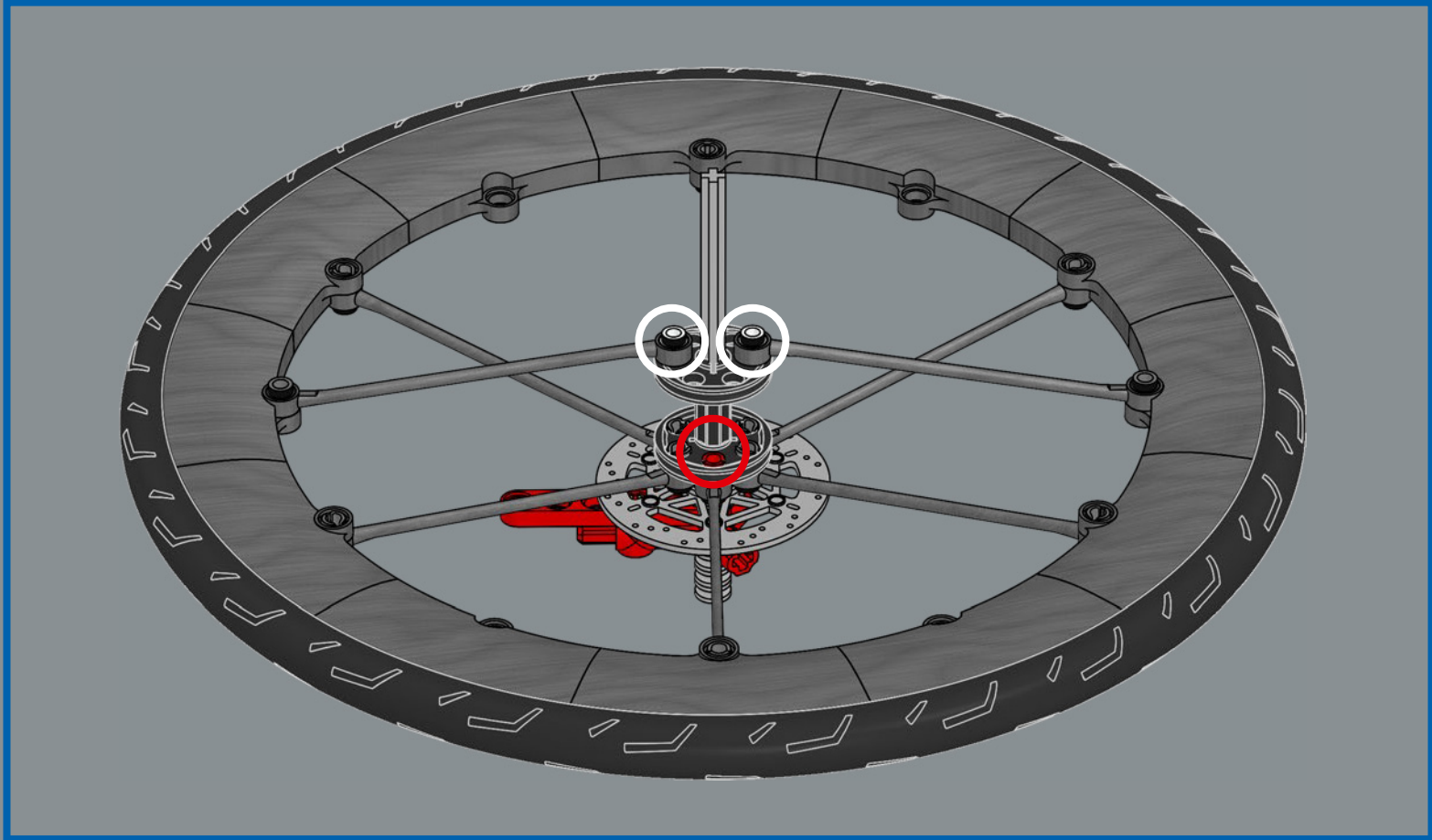

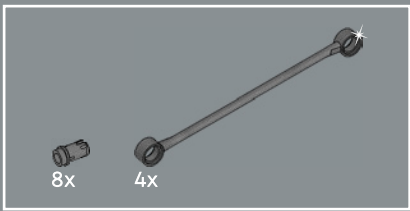

79

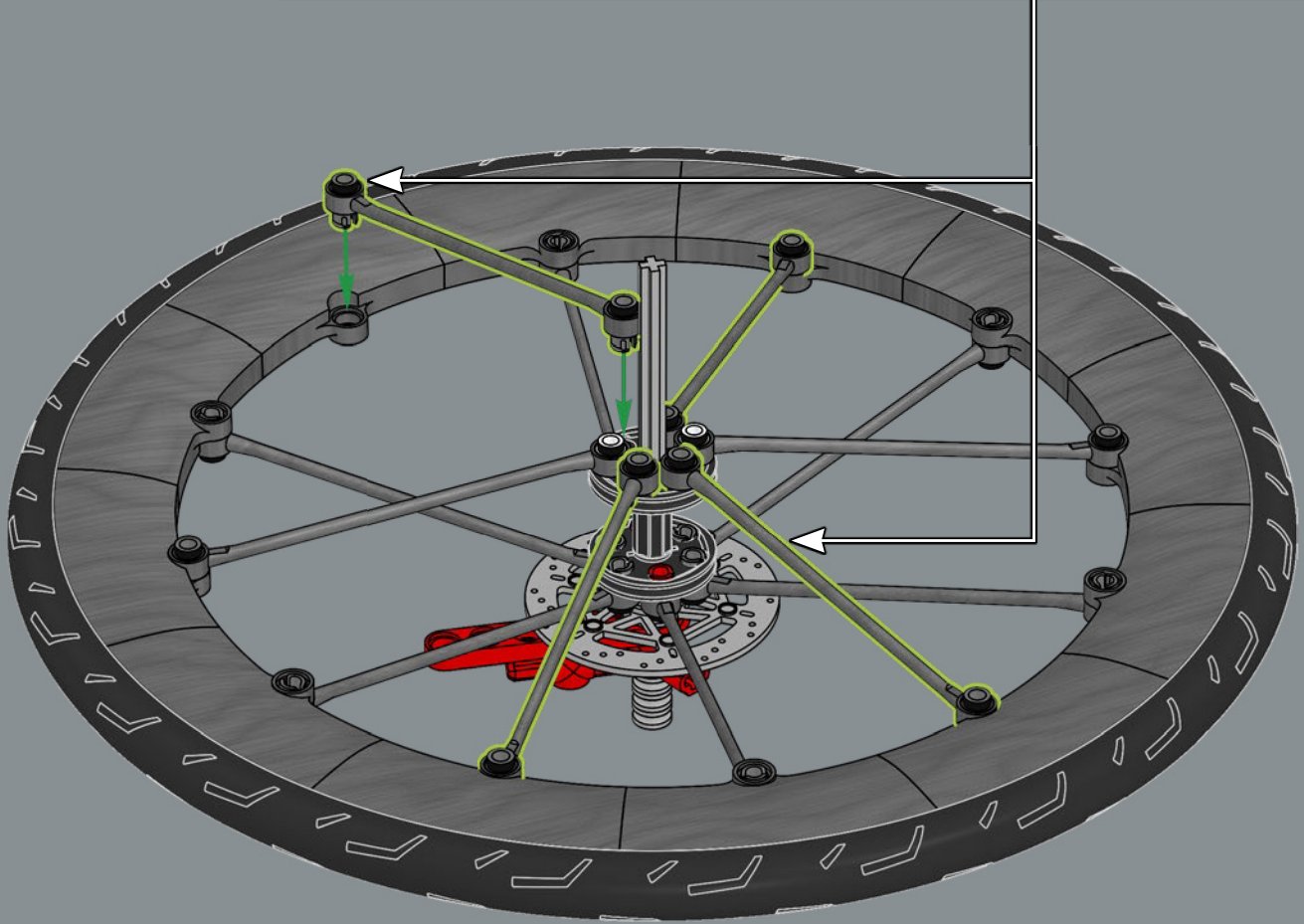
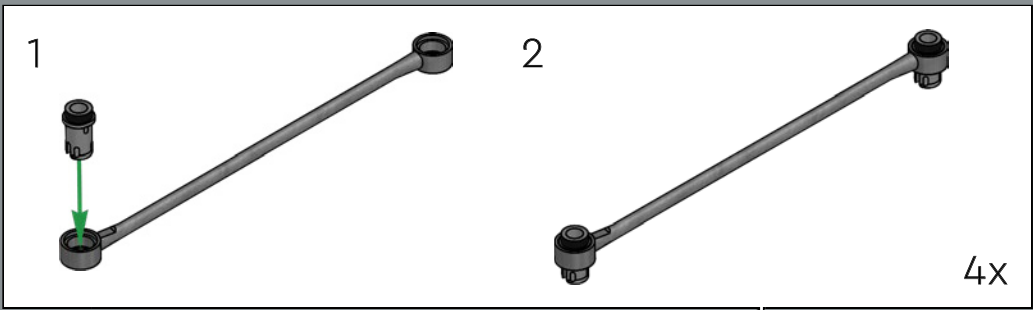



80

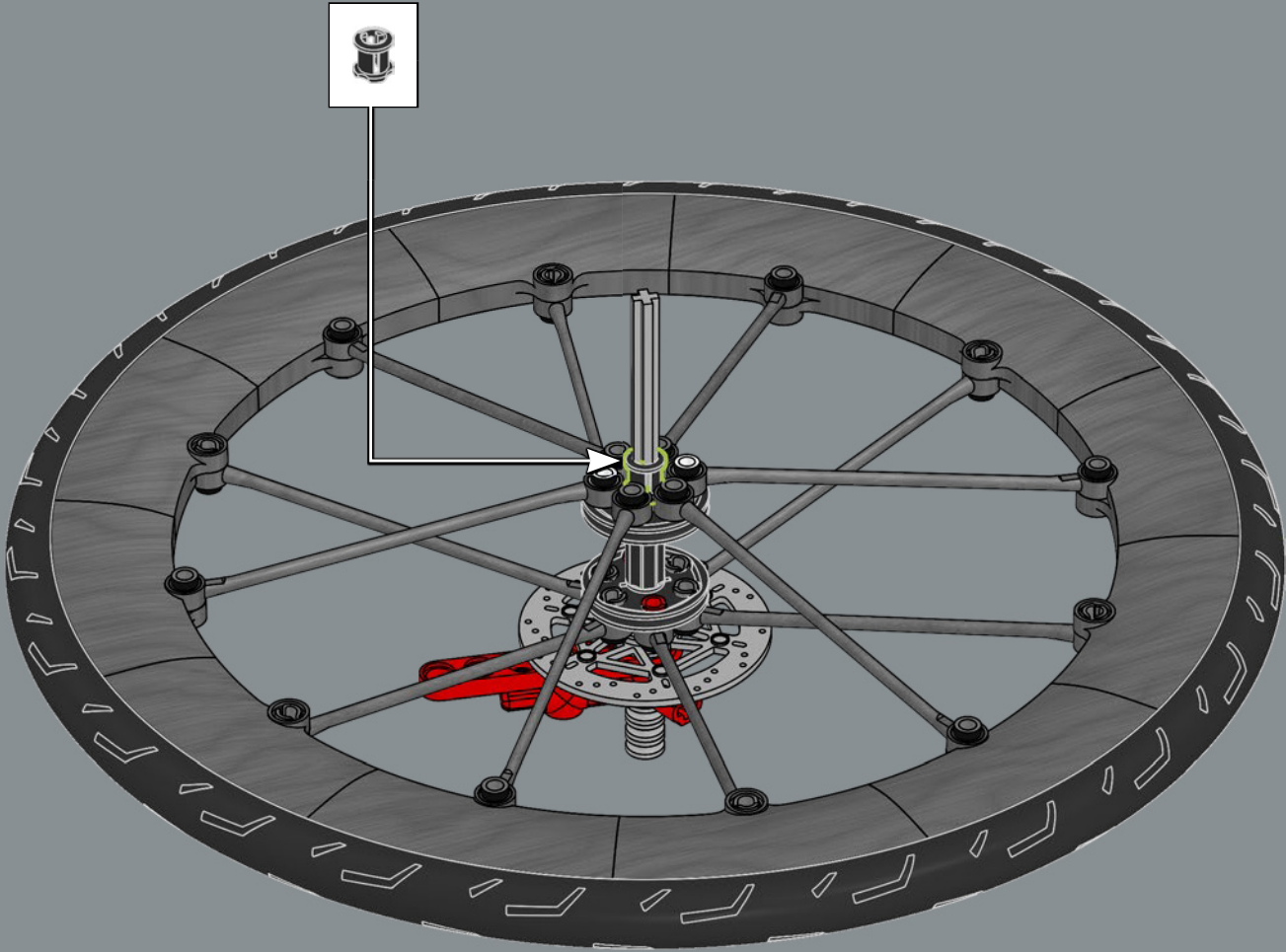



1x

81

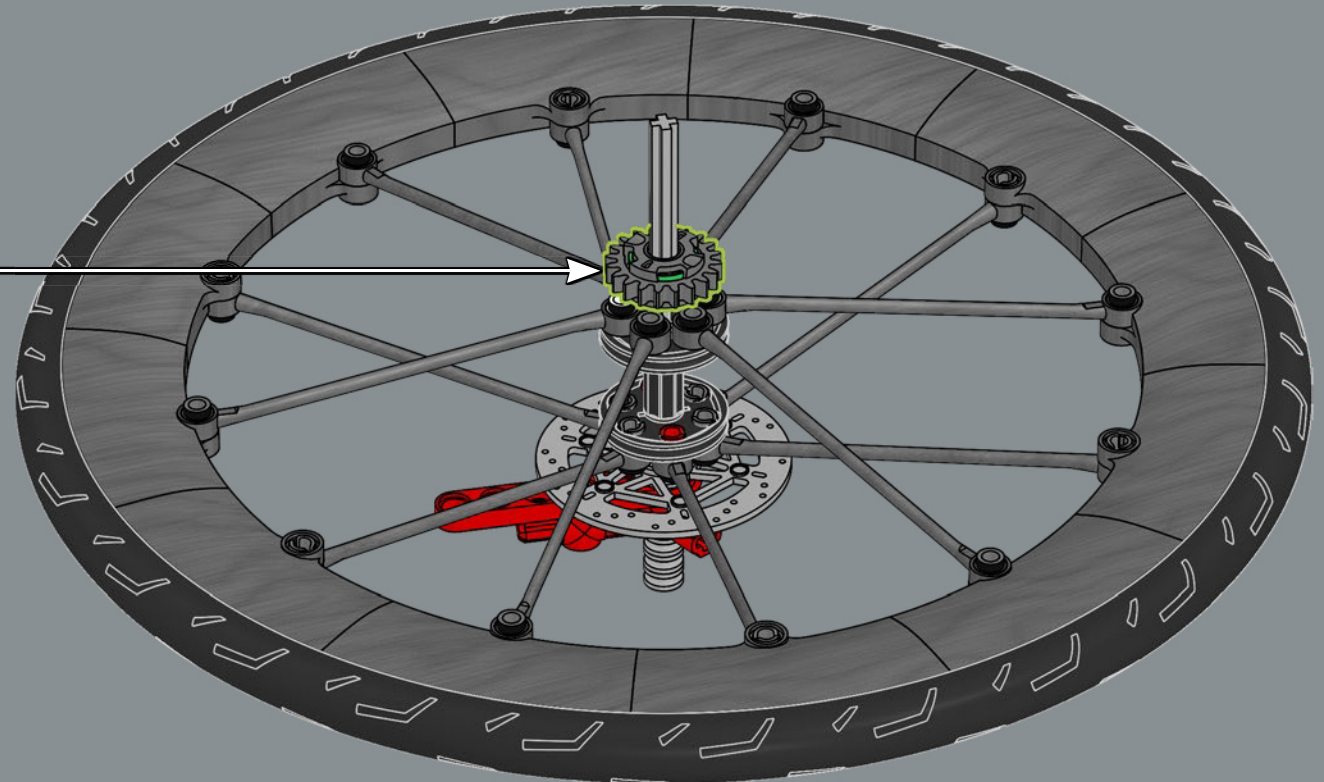
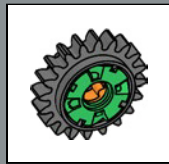
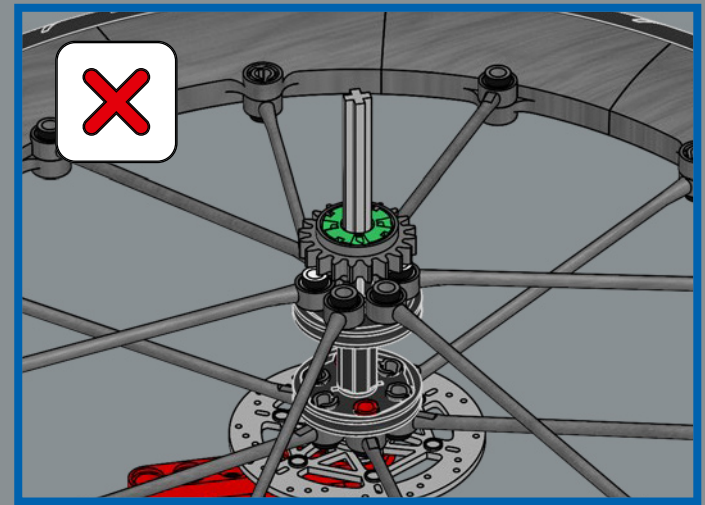
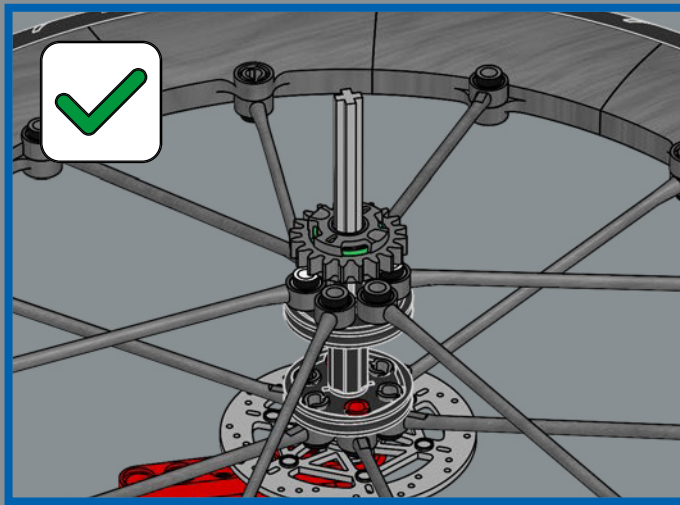

This brand-new, single-way spur gear allows this bike to freewheel, just like on a real bike.

Ce tout nouvel engrenage unidirectionnel permet au vélo de tourner en roue libre, comme le ferait un vrai vélo!

Este nuevo engranaje unidireccional permite que la bicicleta tenga la misma función de pedaleo libre de una de verdad.



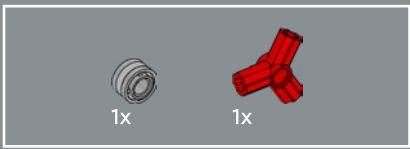

82

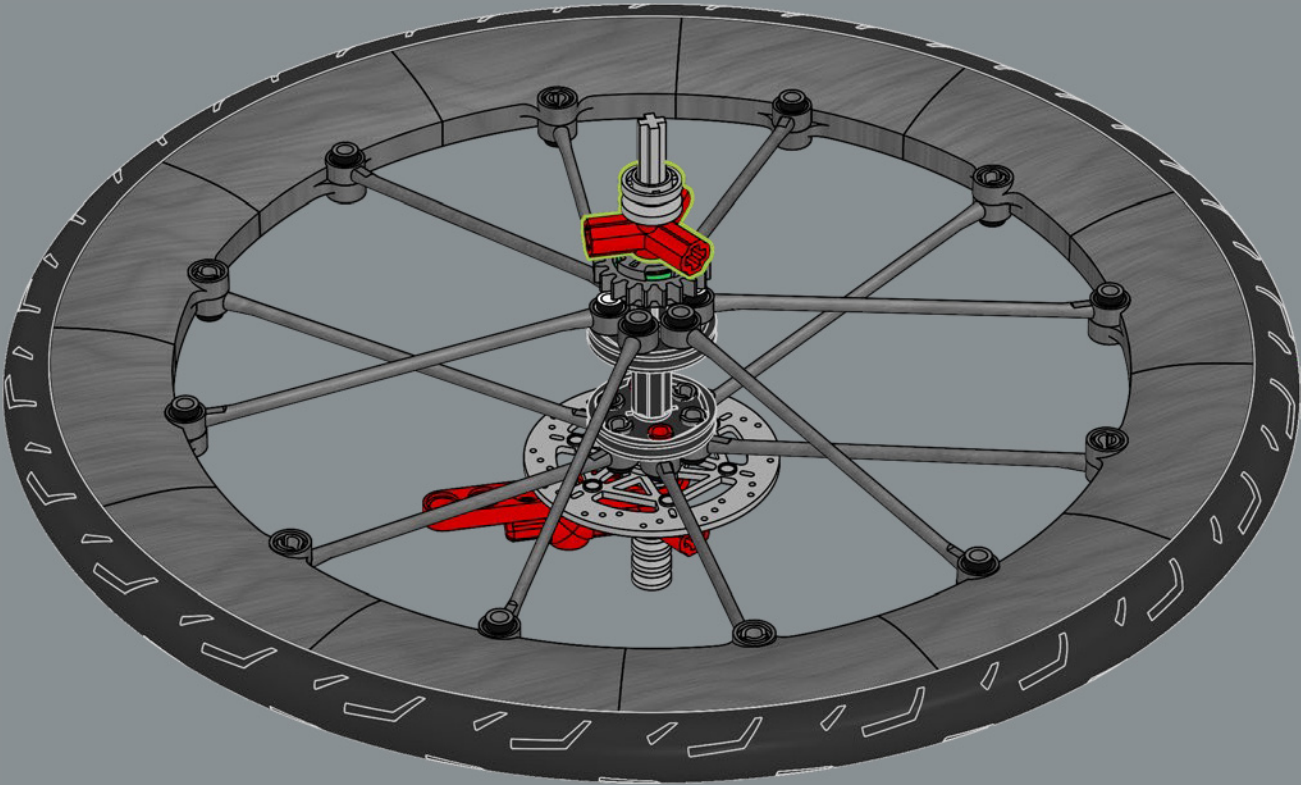



3x

83

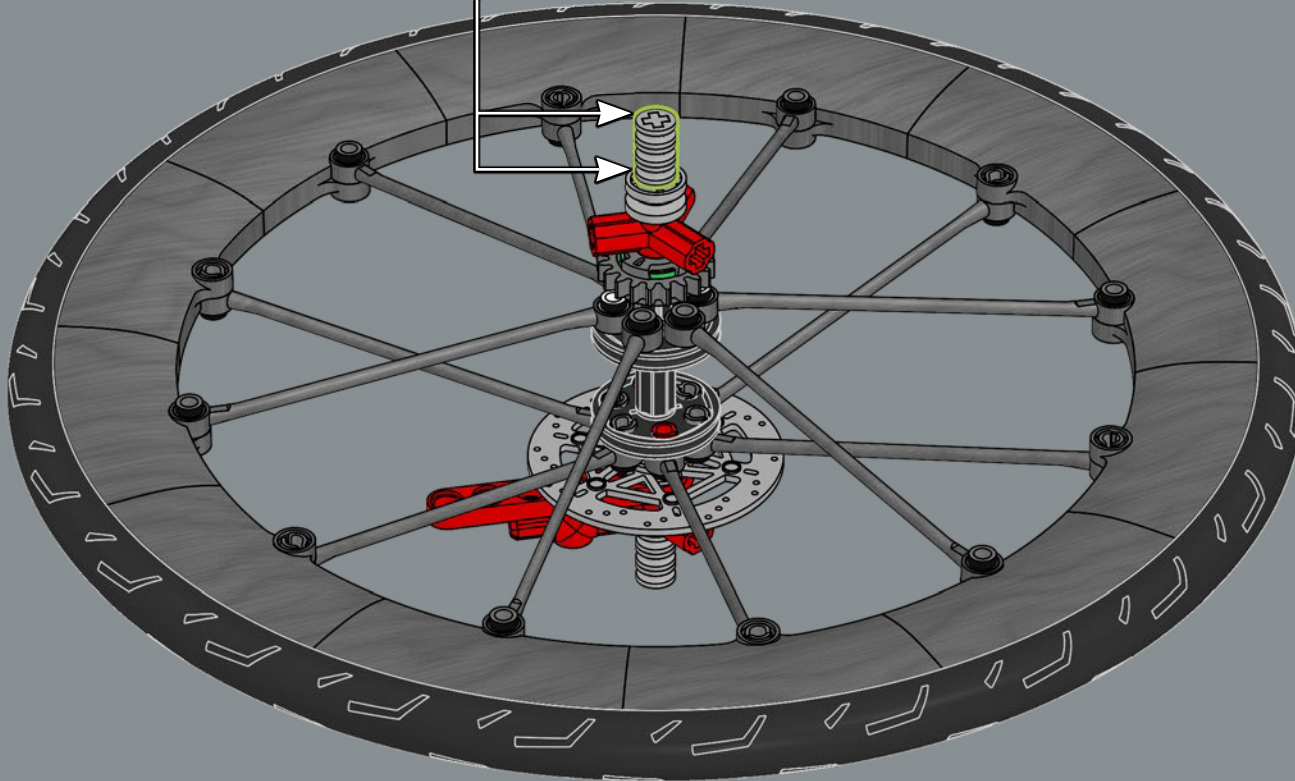
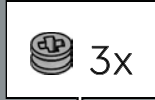

84

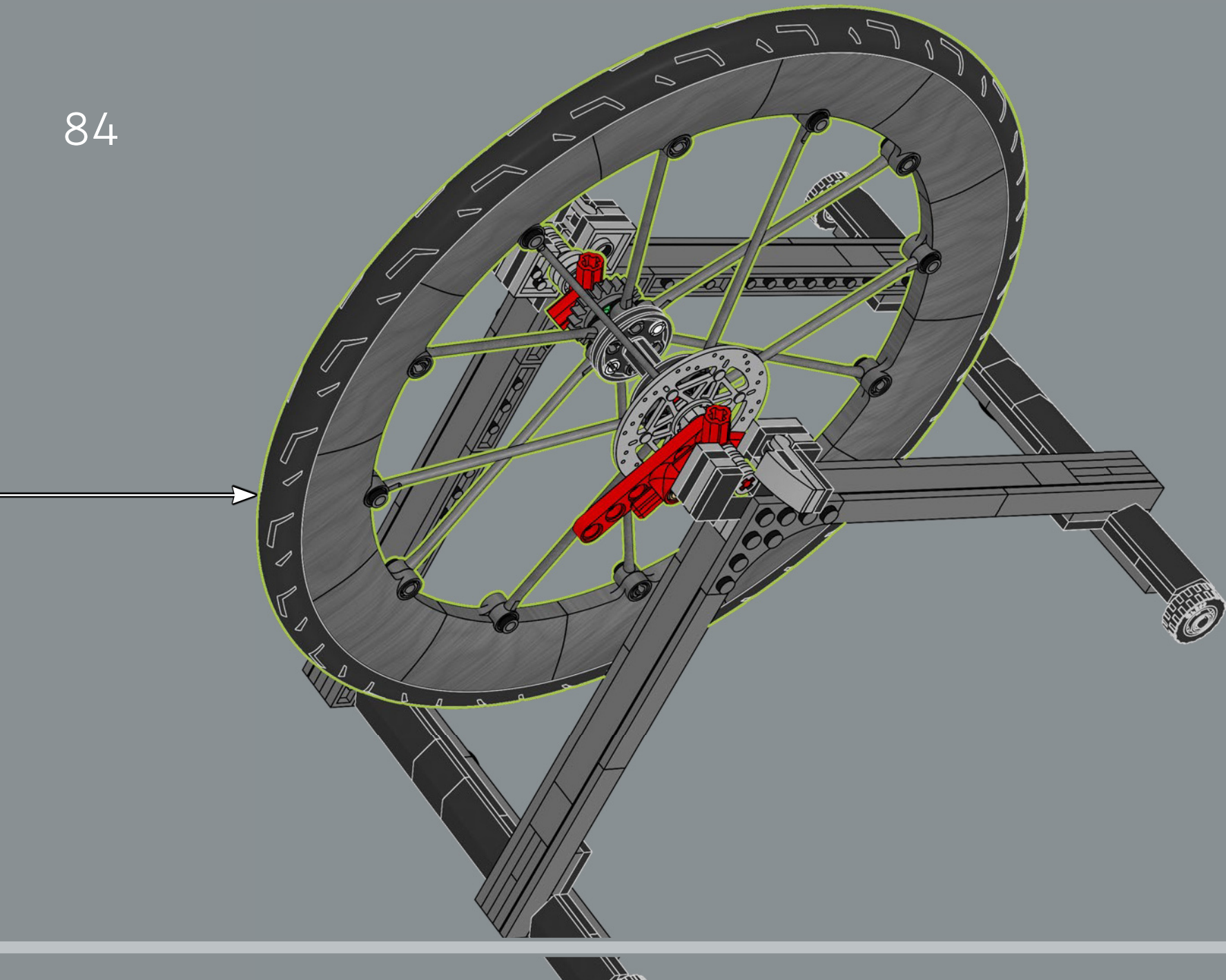

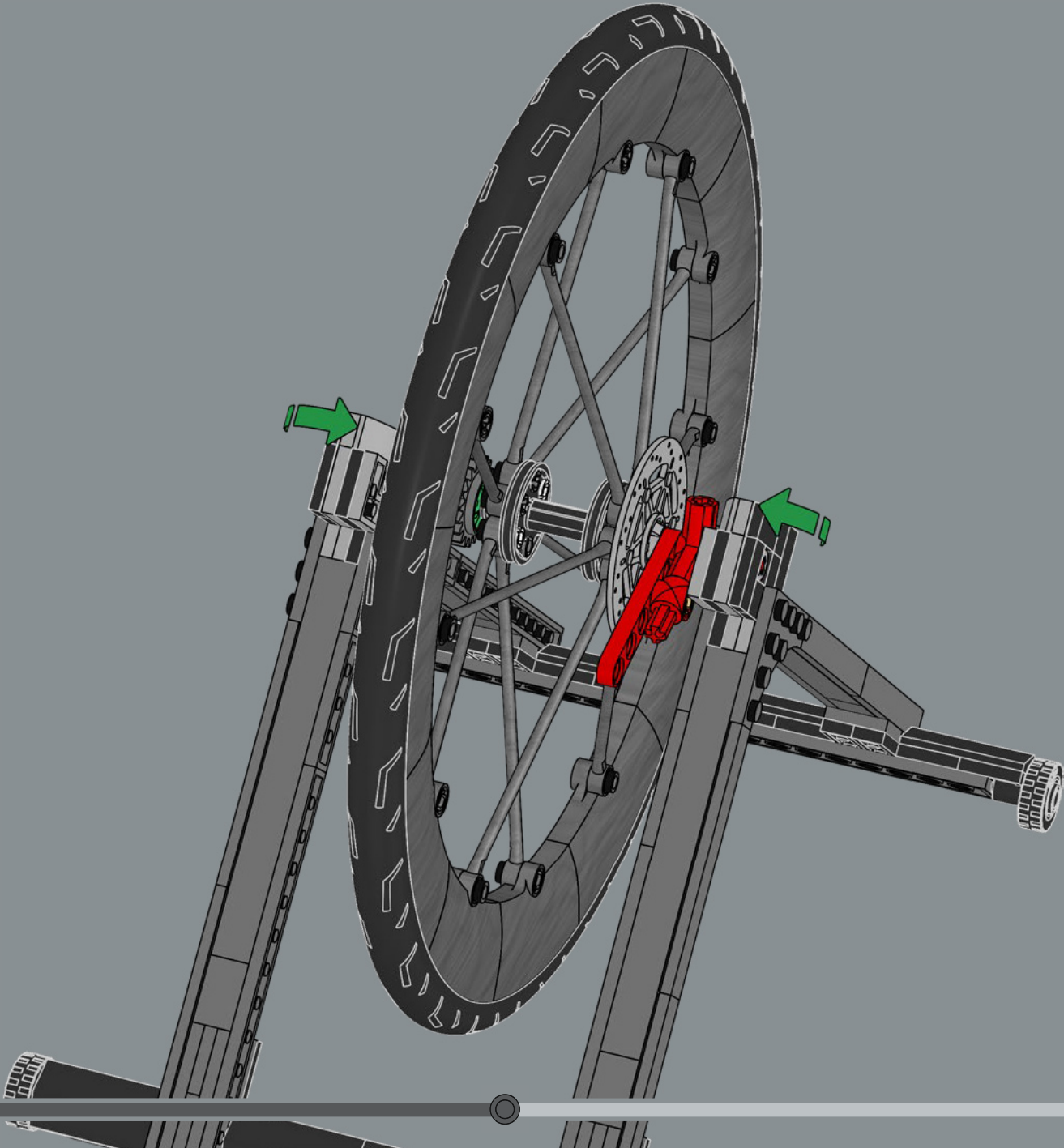

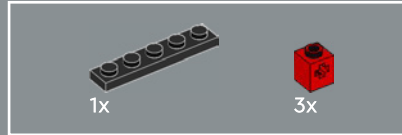
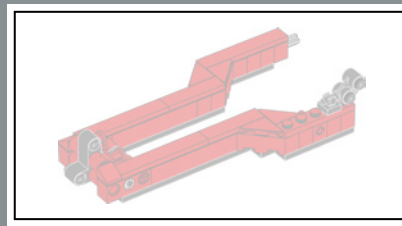

86

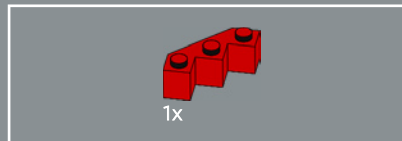
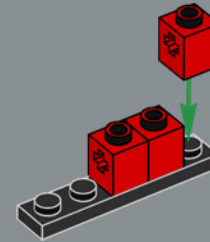

87

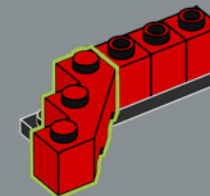

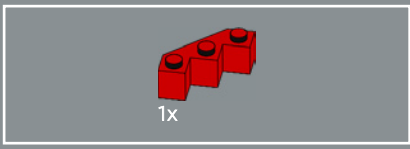

88

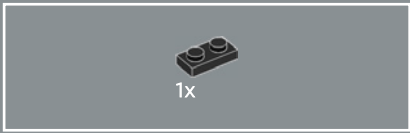
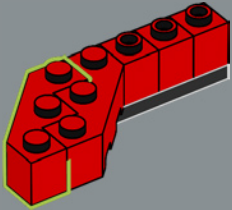

89

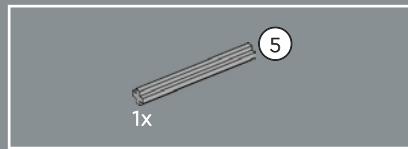
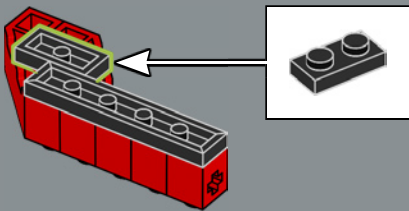

90

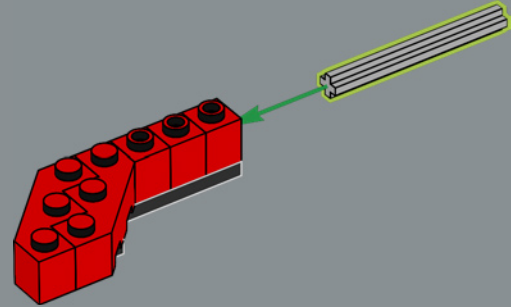

91

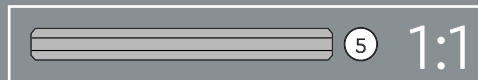
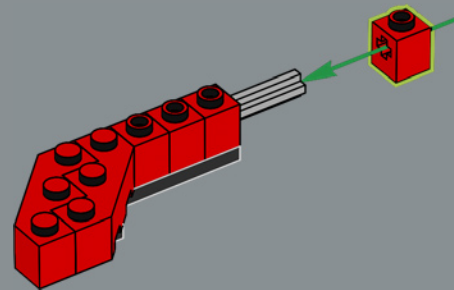

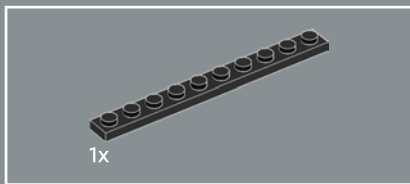

92

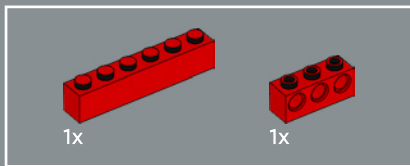
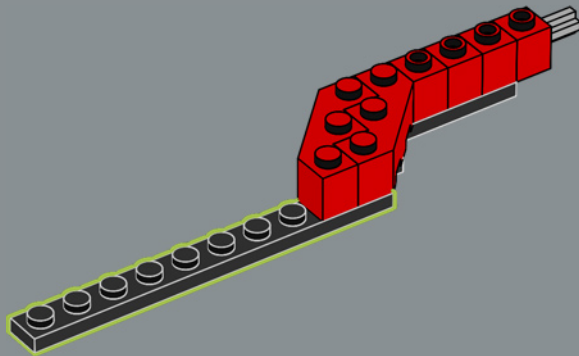

93

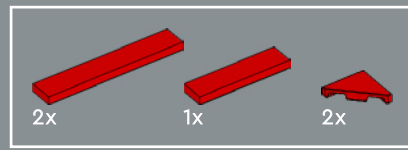
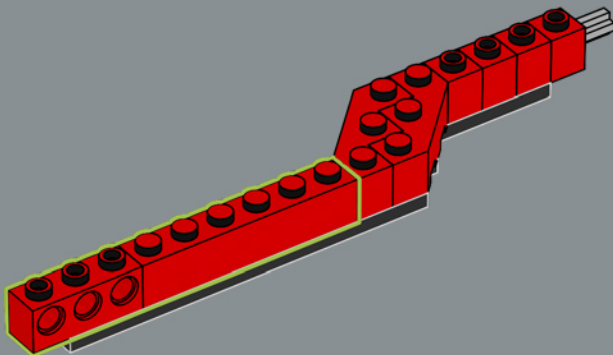

94

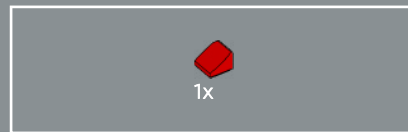
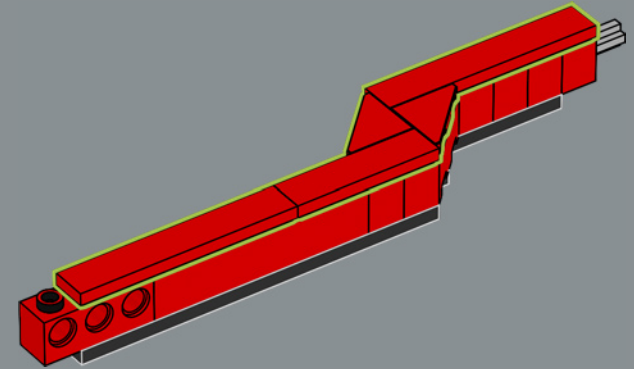

95

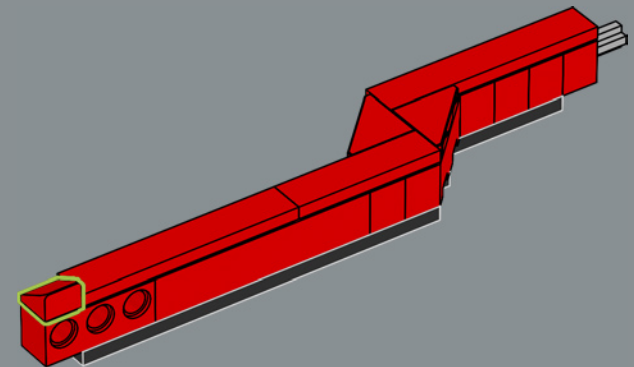

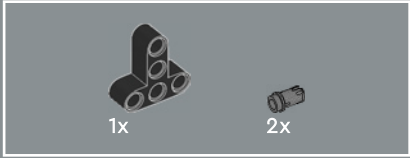
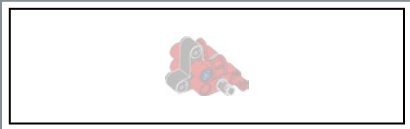

96

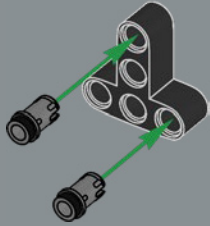

97

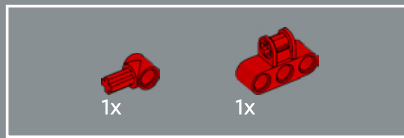

98

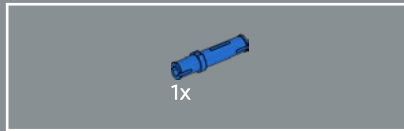
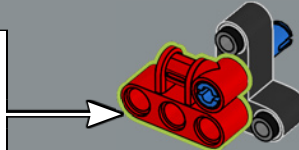
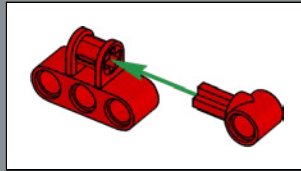

99

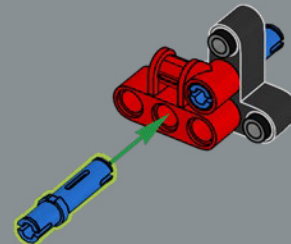



100

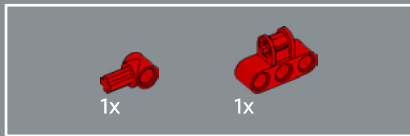
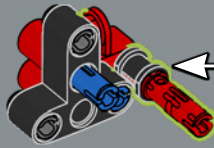
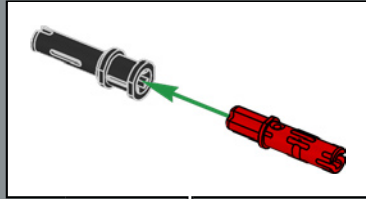

101

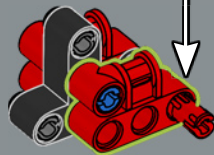
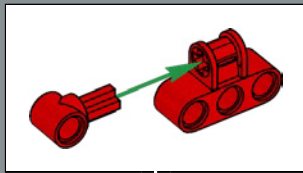

102

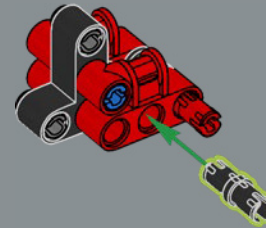

103

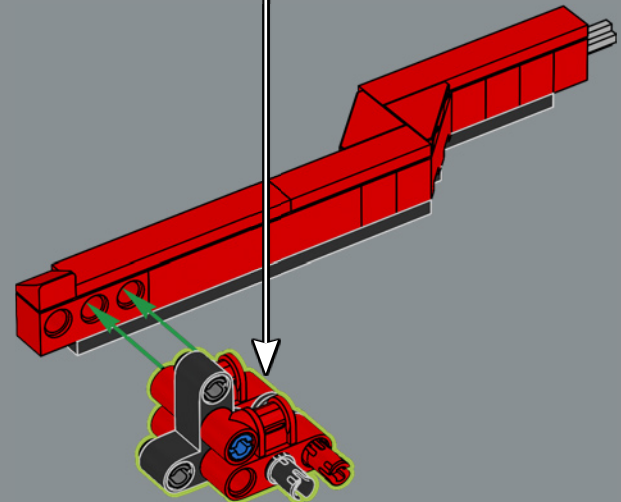

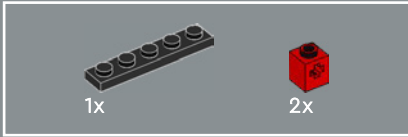
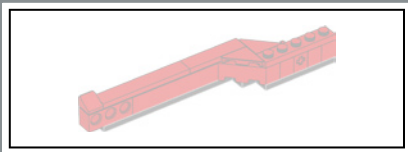

104

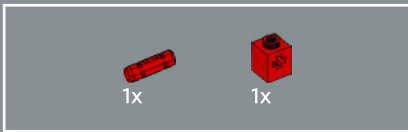
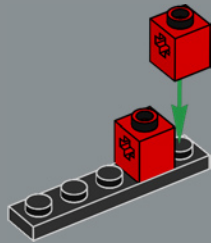

105

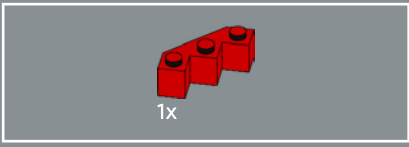
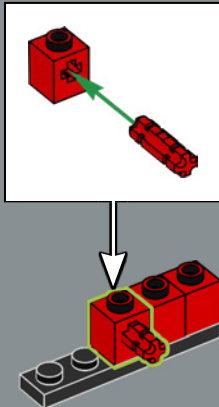

106

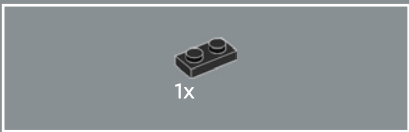
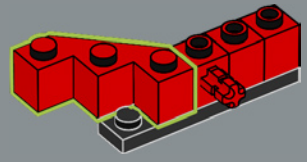

107

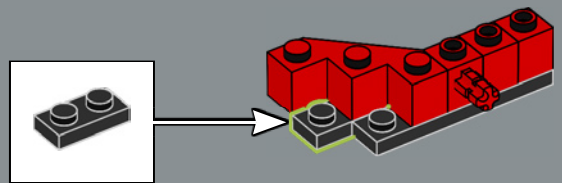



108

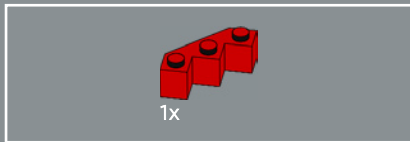
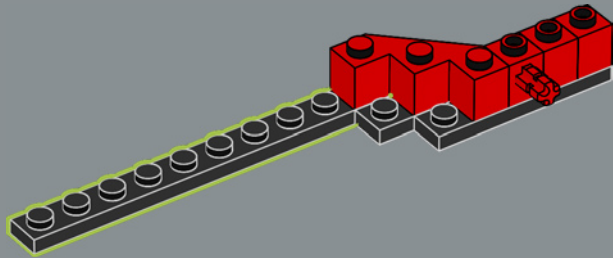

109

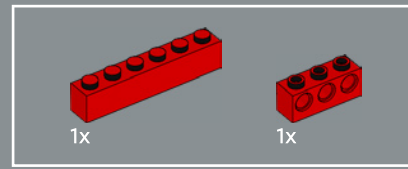
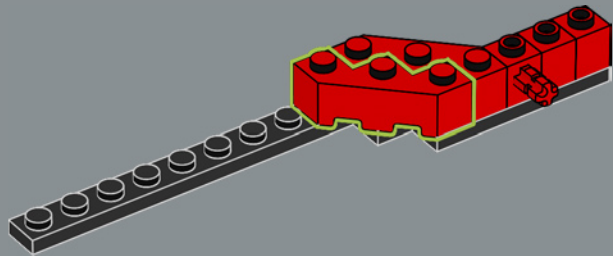

110

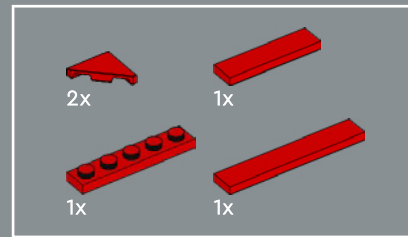
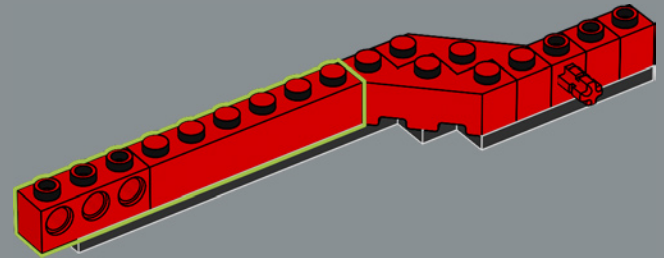

111

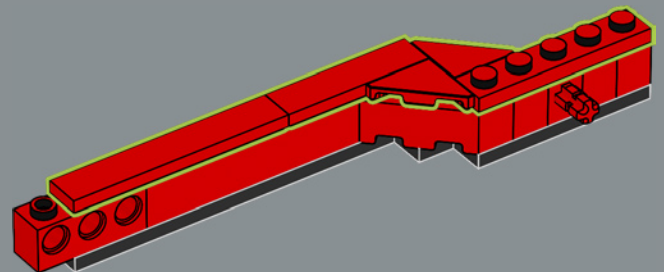



1x

112

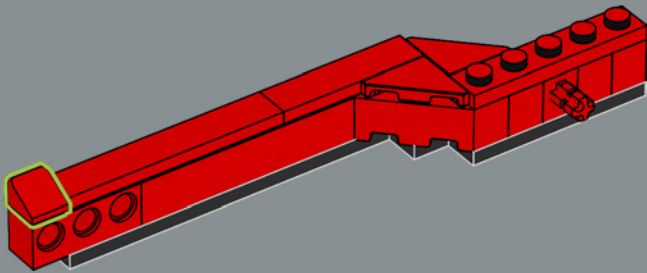

113

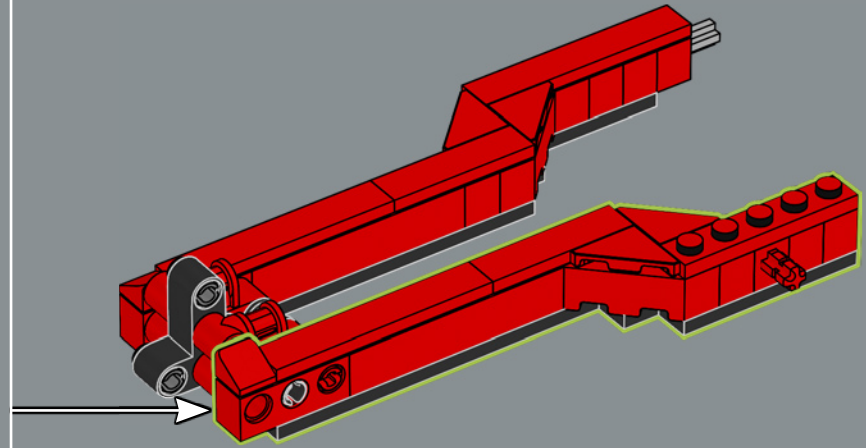



1x

114

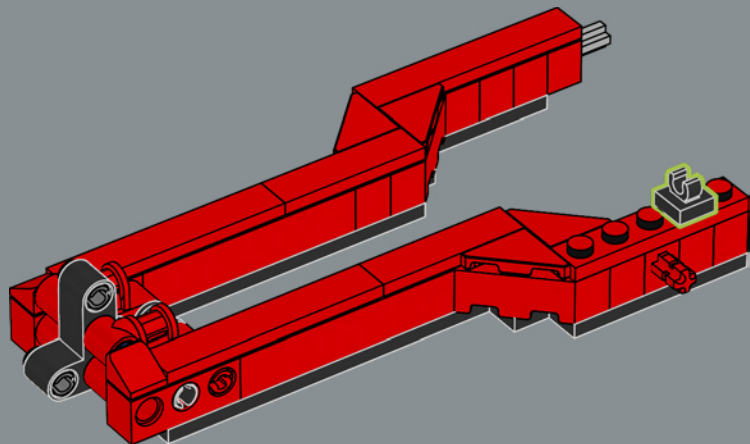

1x



2x

115



This element was originally made as a launcher for the flick fire missiles for LEGO® Space Police in 2009. Here, it works great for representing a disc-brake caliper.

Cet élément avait été créé à l'origine comme lanceur pour les projectiles à ressort de la gamme LEGO® Space Police en 2009. Ici, il sert parfaitement à représenter un étrier de frein à disque.

Este elemento se fabricó originalmente como lanzador de misiles para el tema LEGO® Space Police en 2009. Aquí funciona muy bien como pinza del freno de disco.

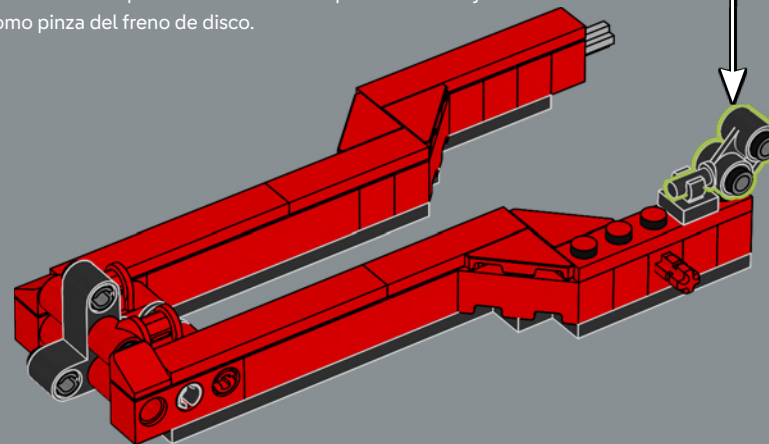
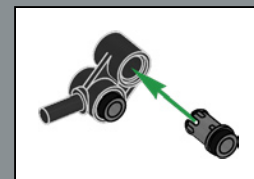

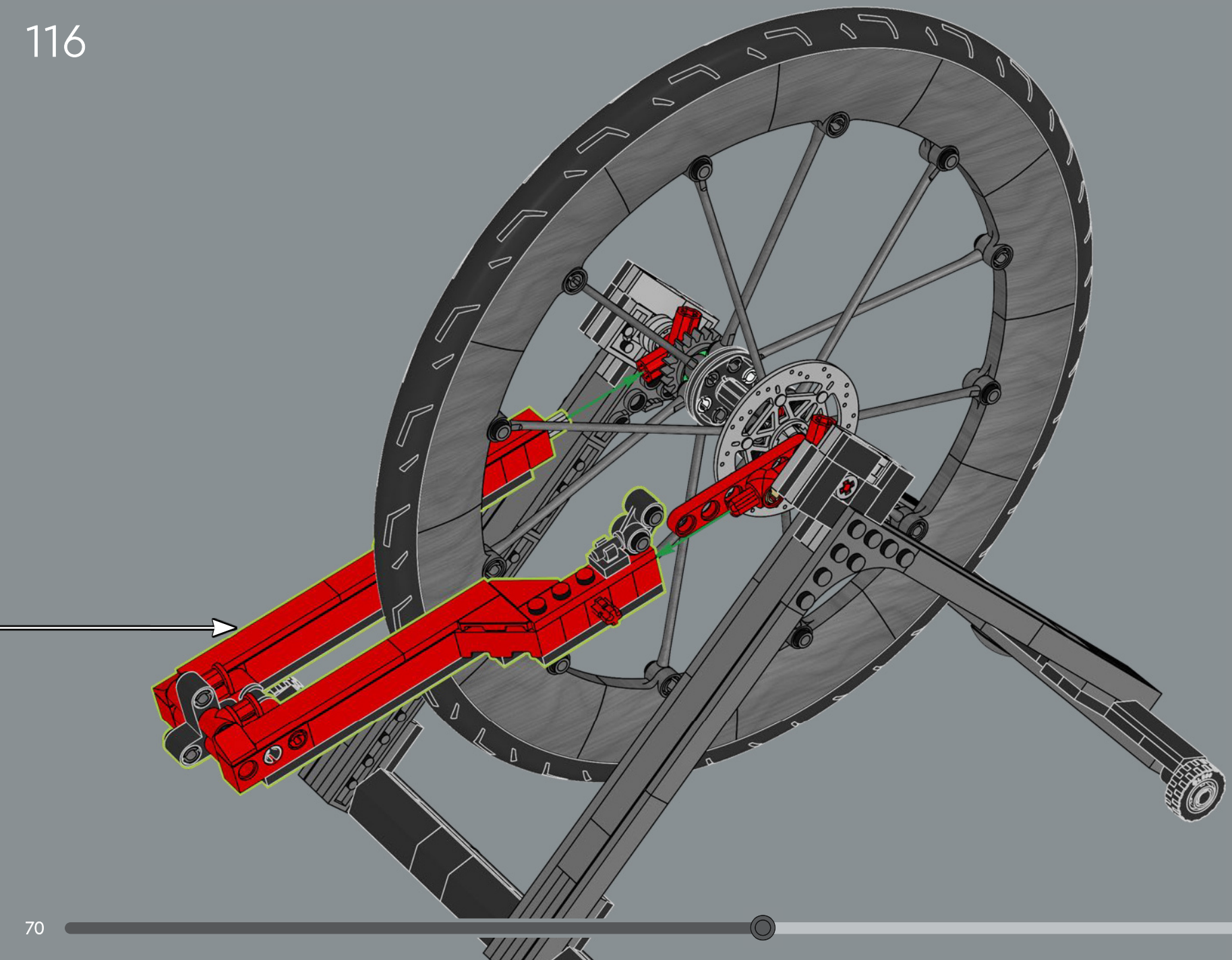

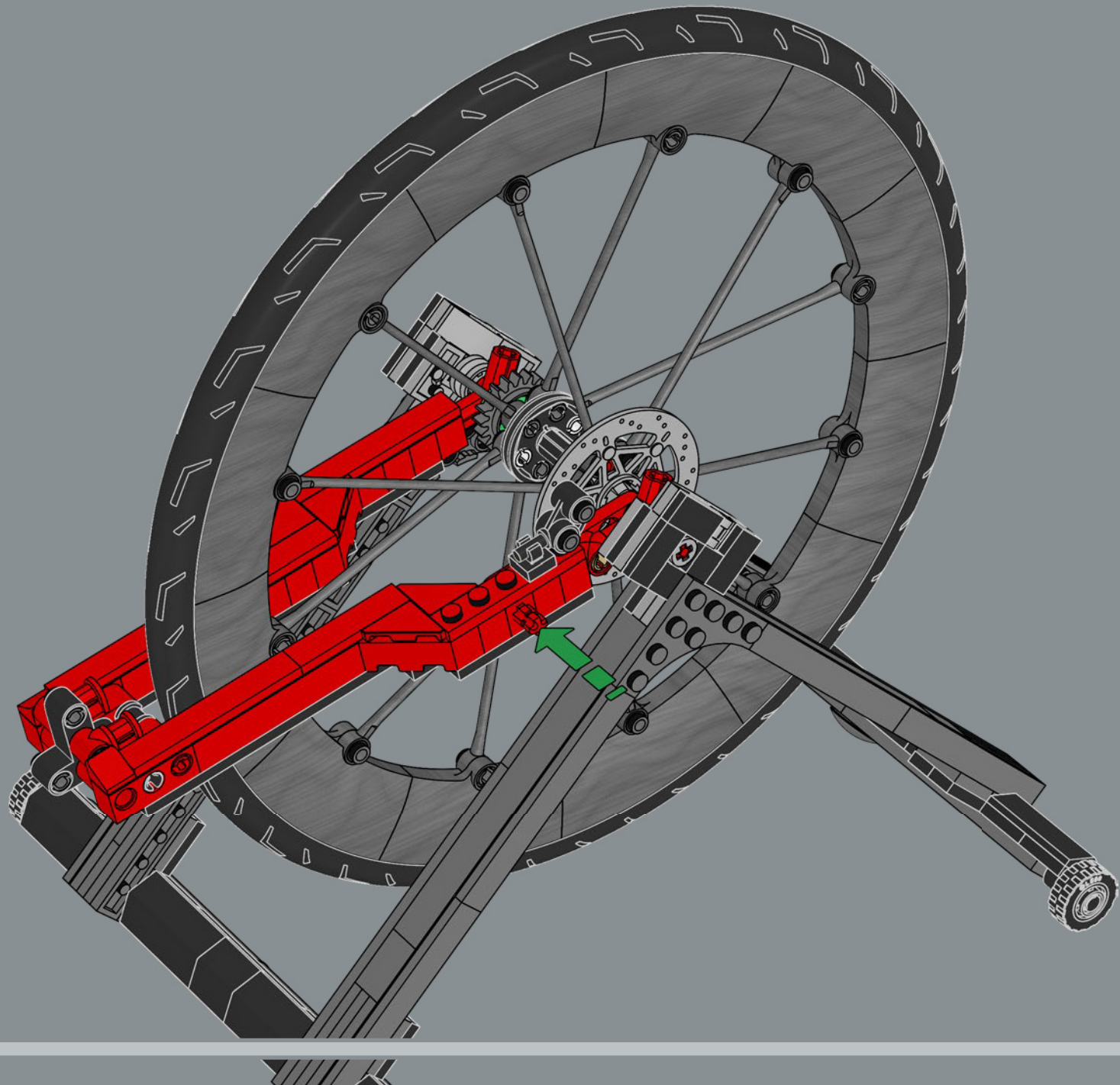

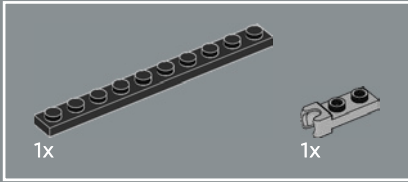
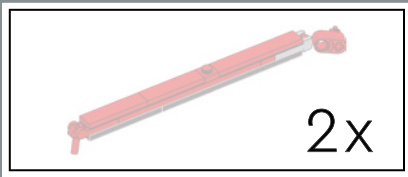

118

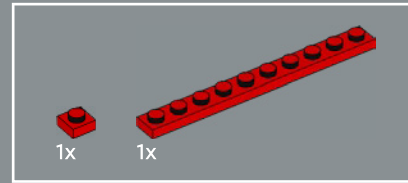
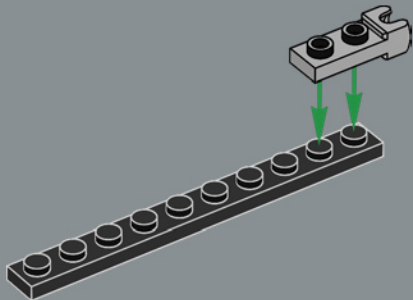

119

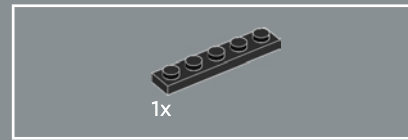
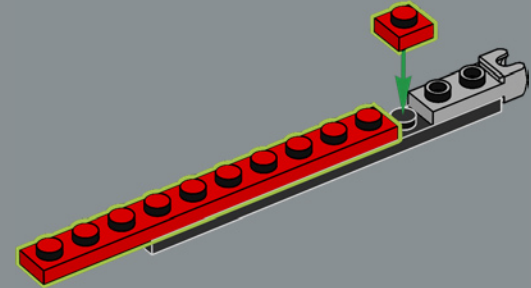

120

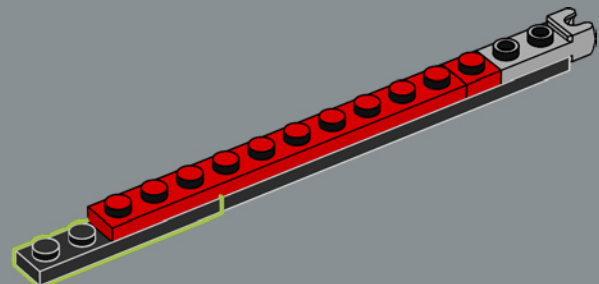

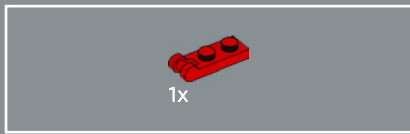

121

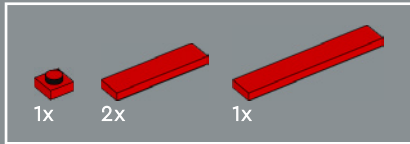
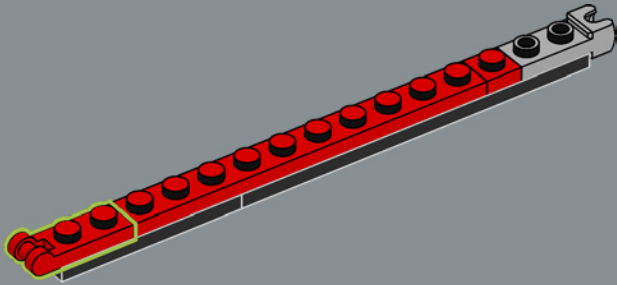

122

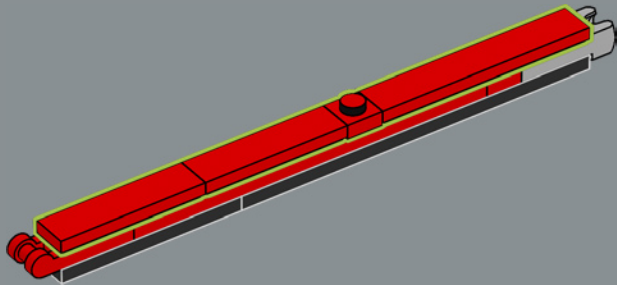

123

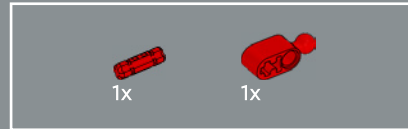
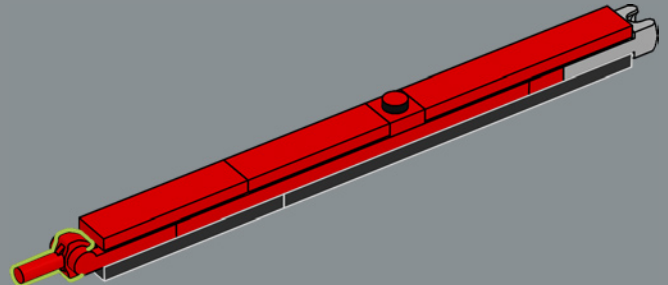

124

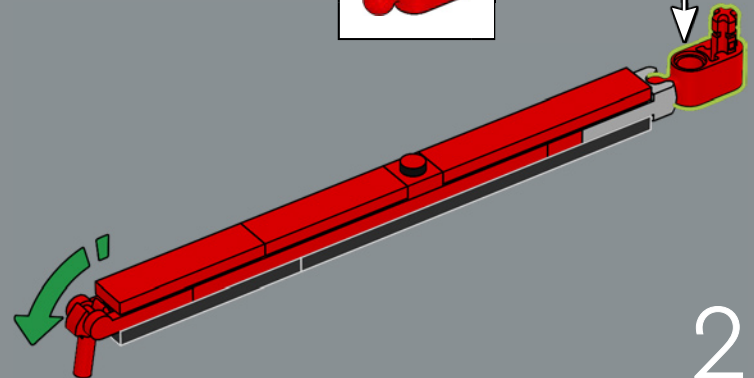
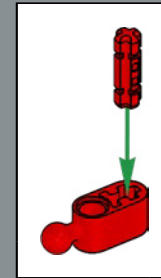

2x

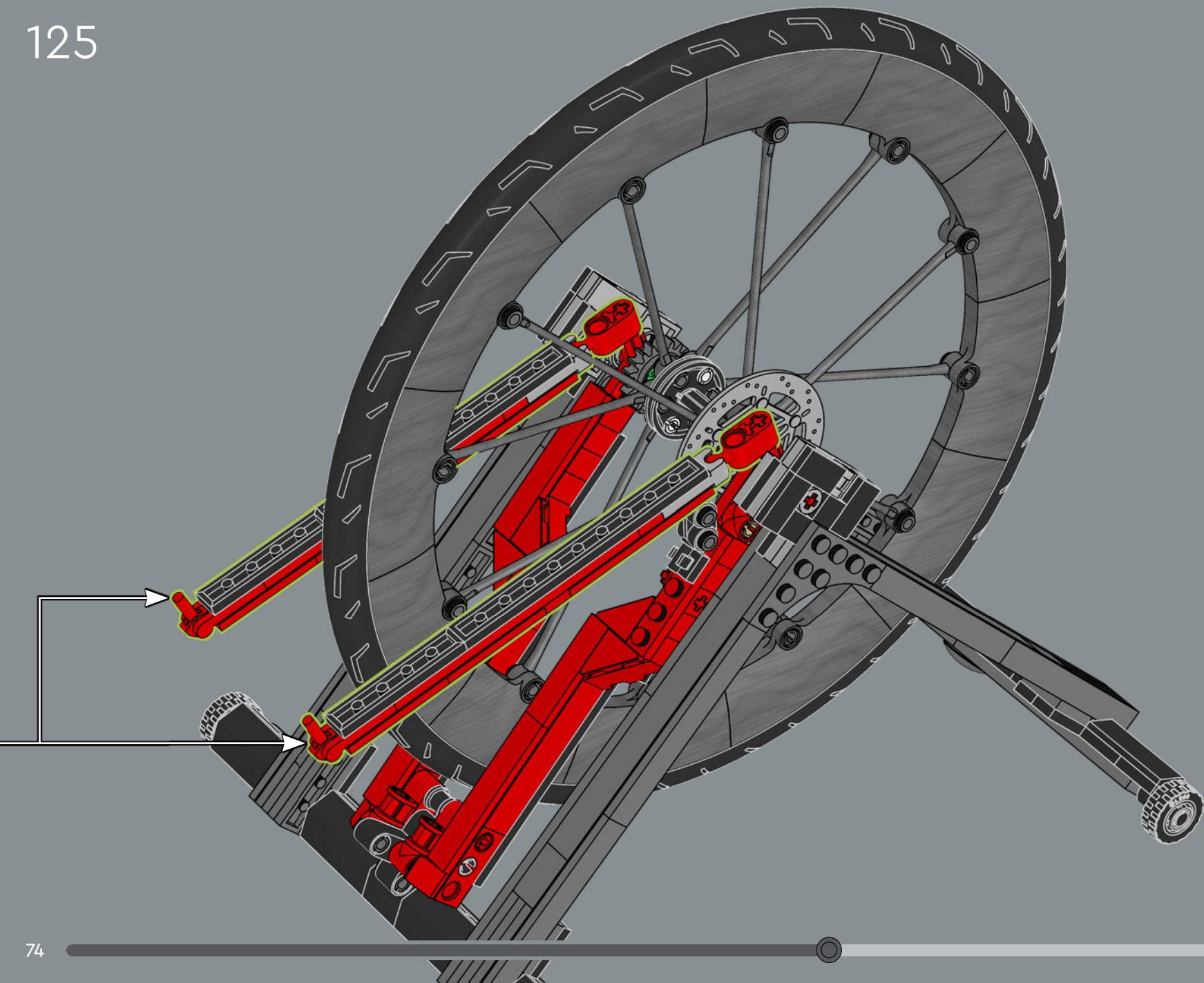

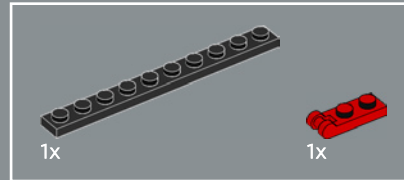
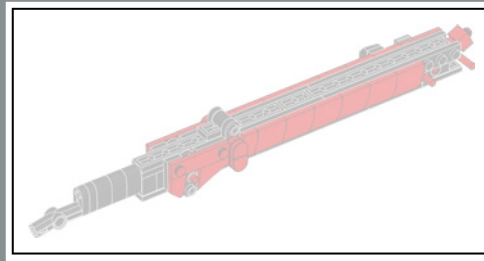

126

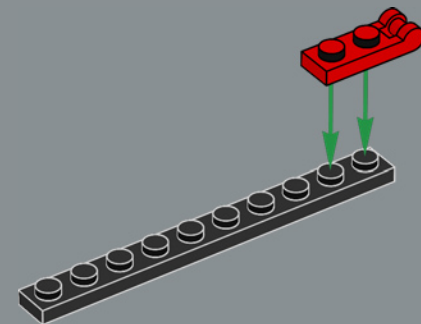

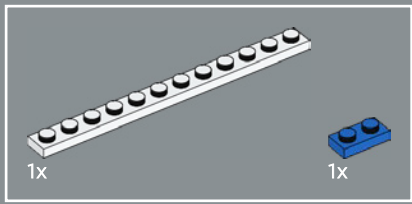

127

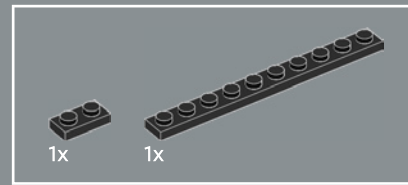
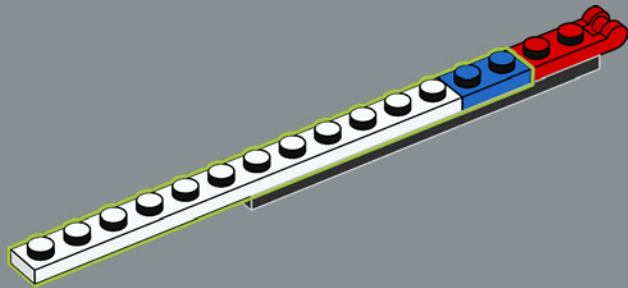

128

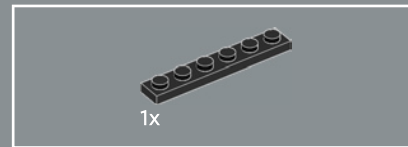
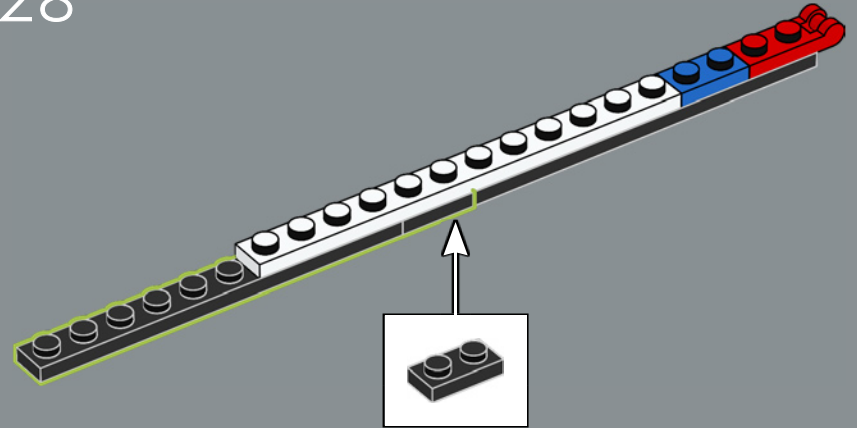

129

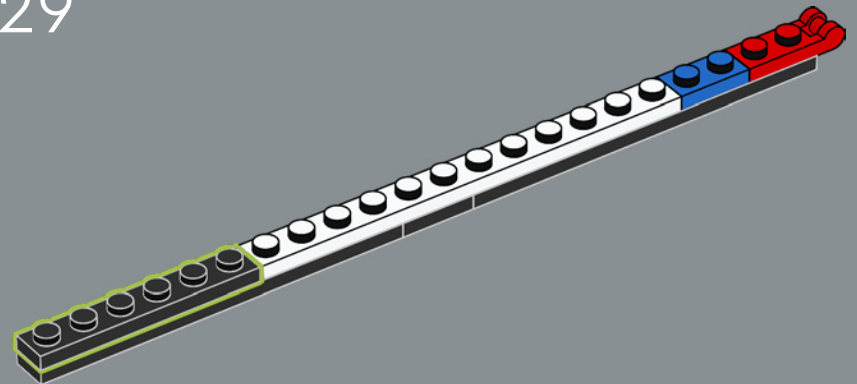

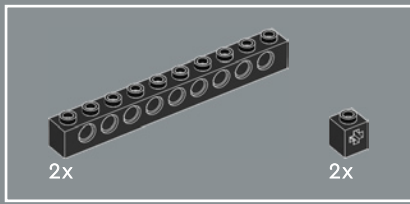

130

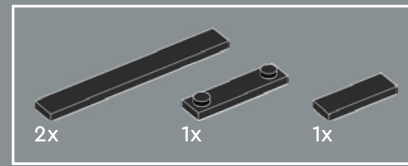
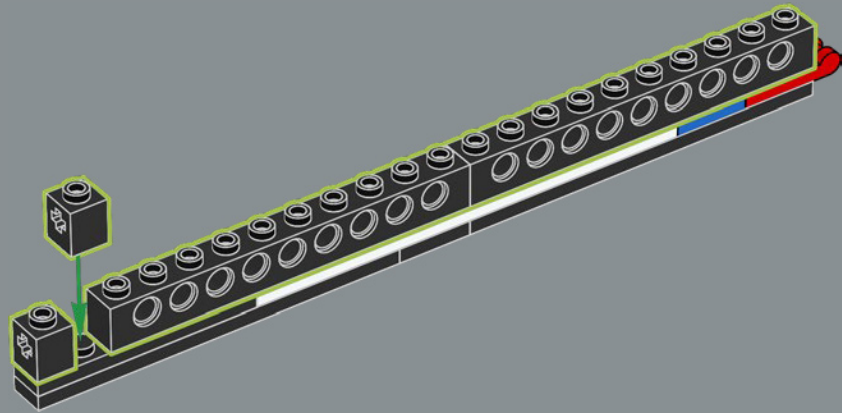

131

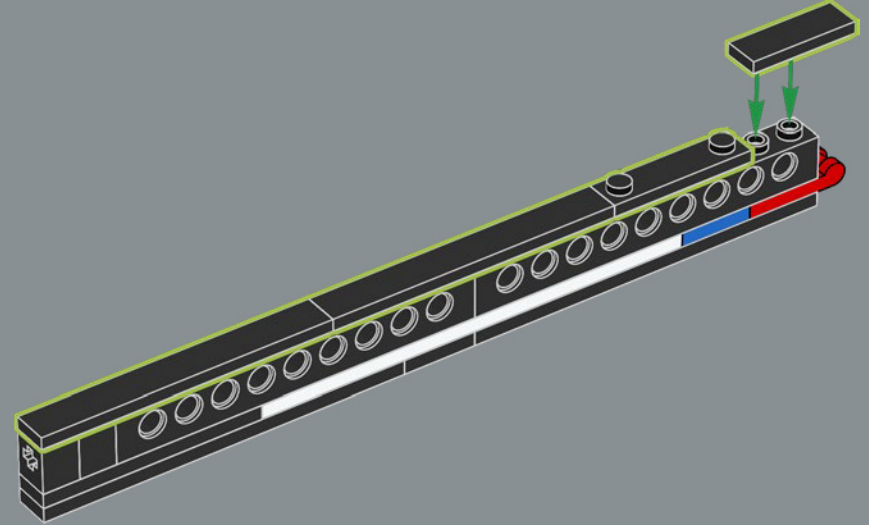

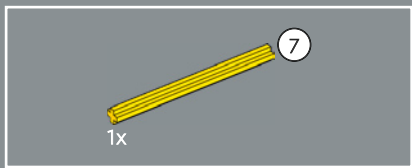

132

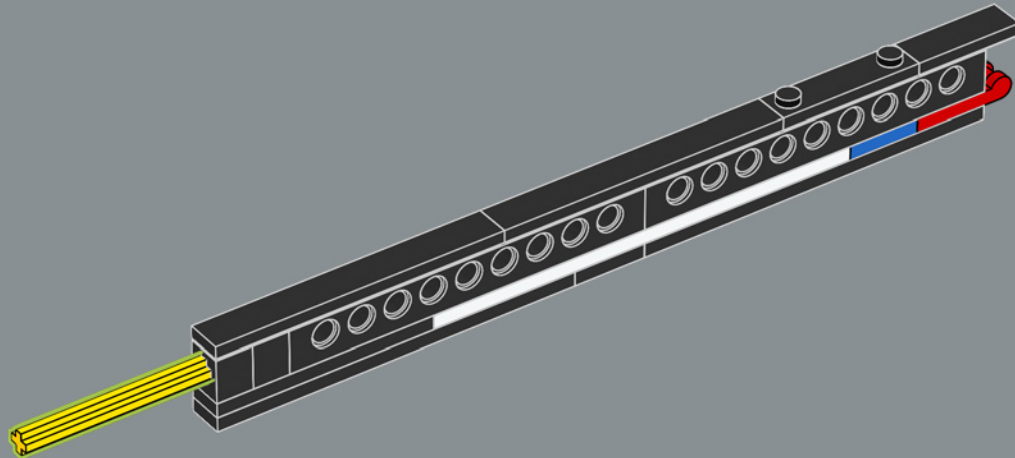

133

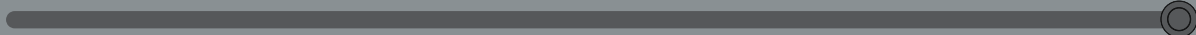
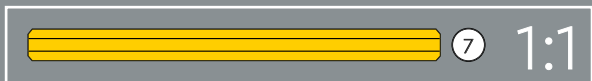
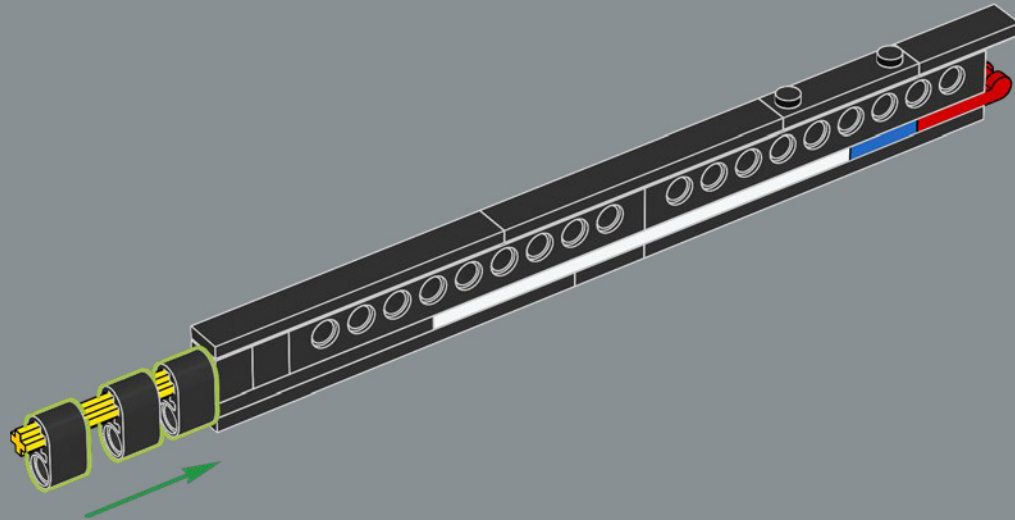



134

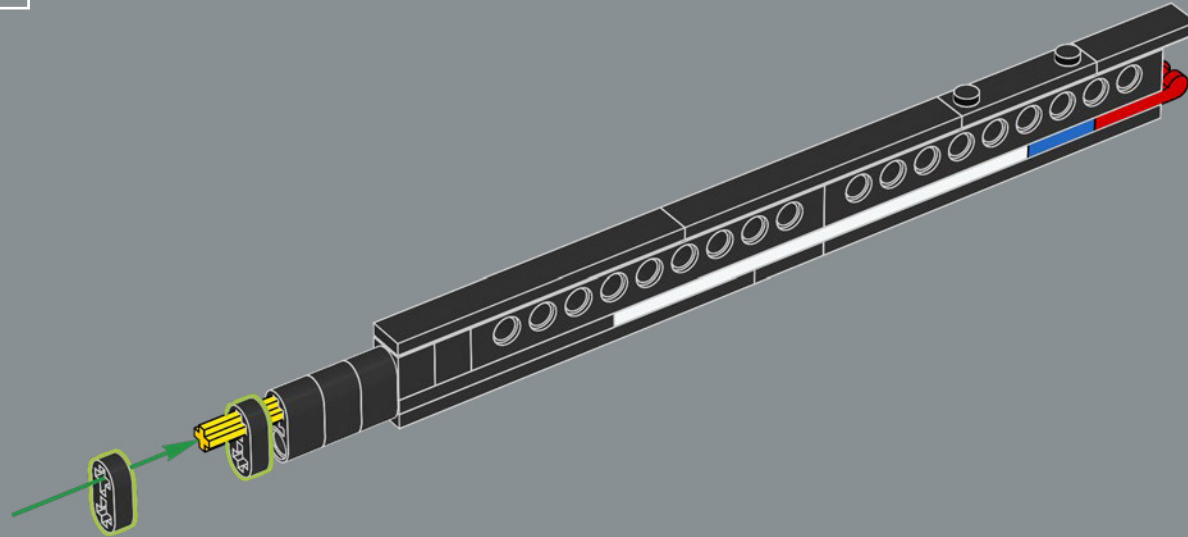

135

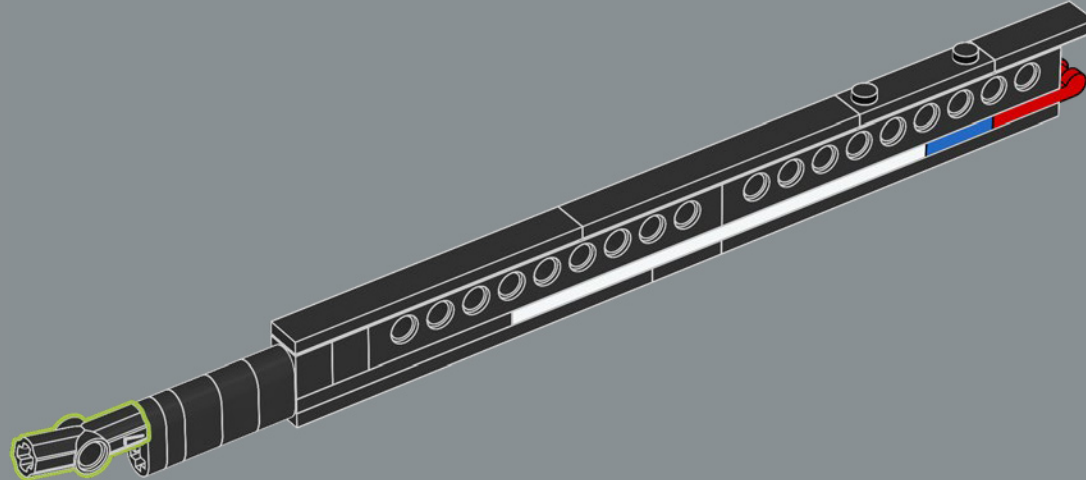

10x

136

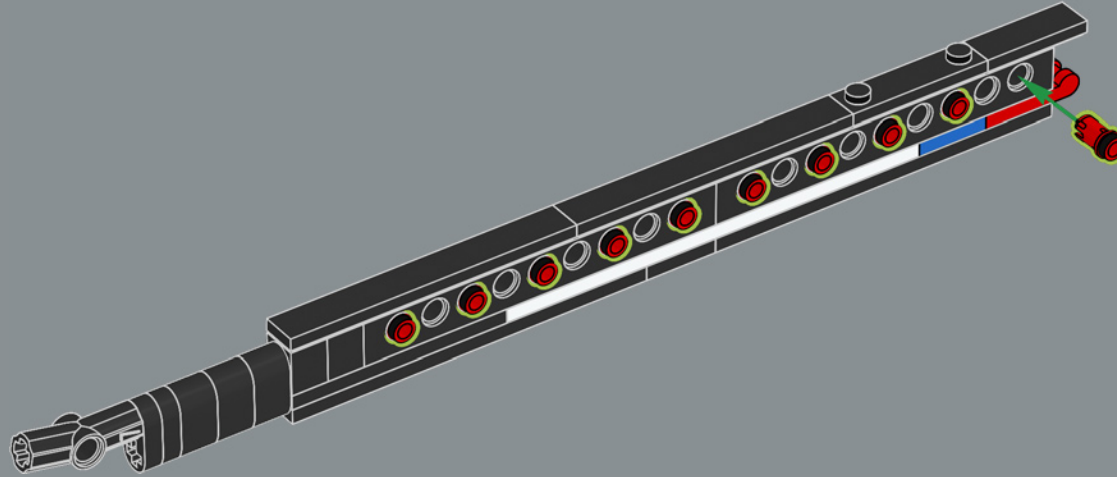

1x

137

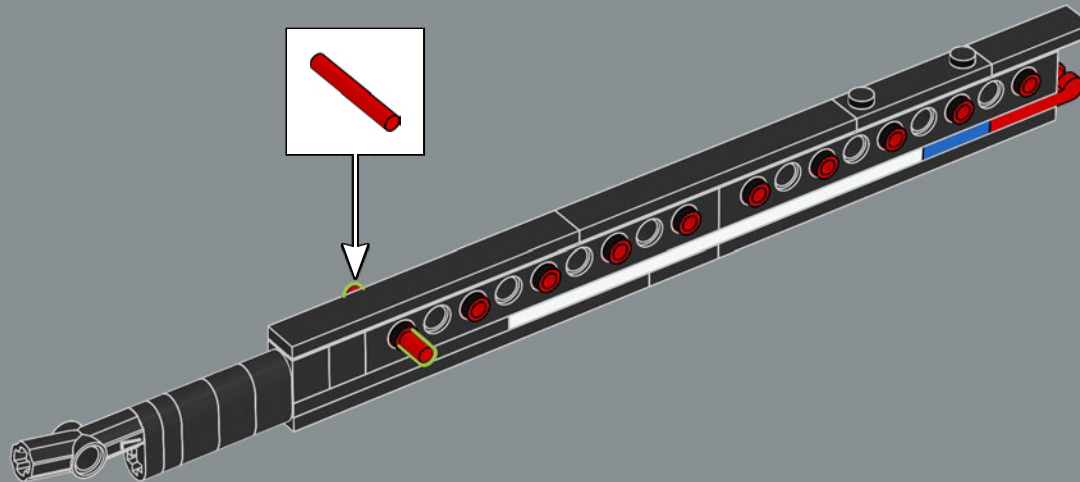



138

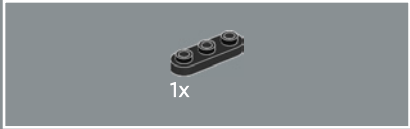
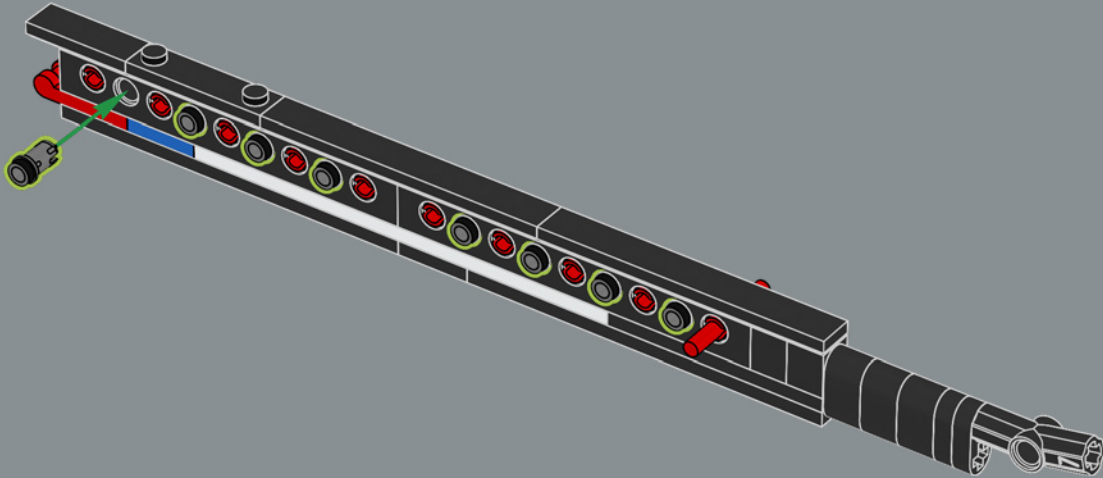

139

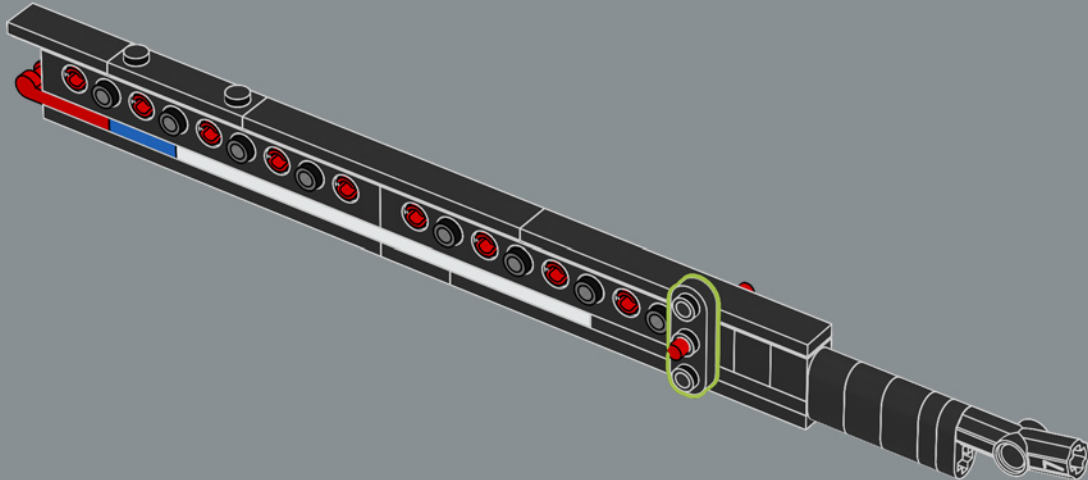

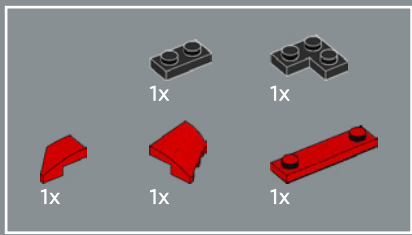

140

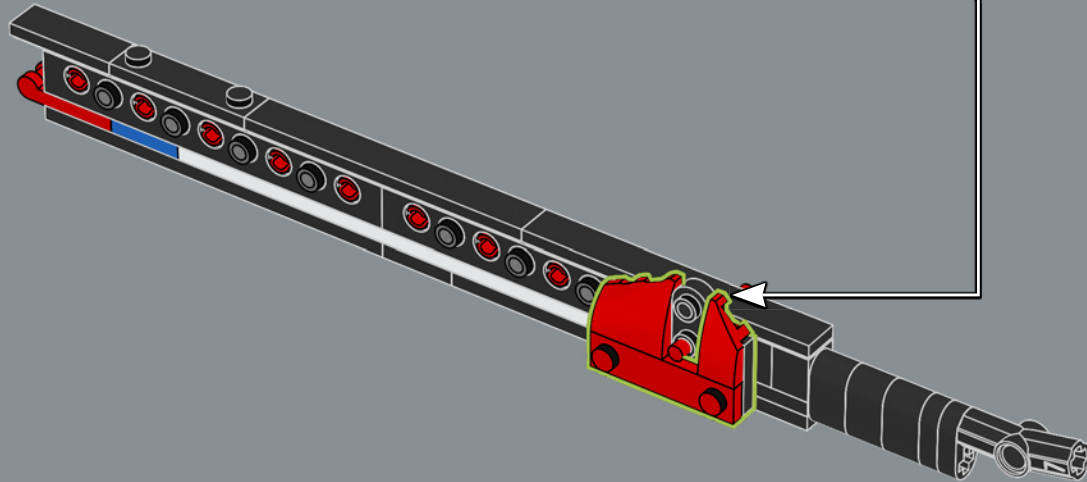
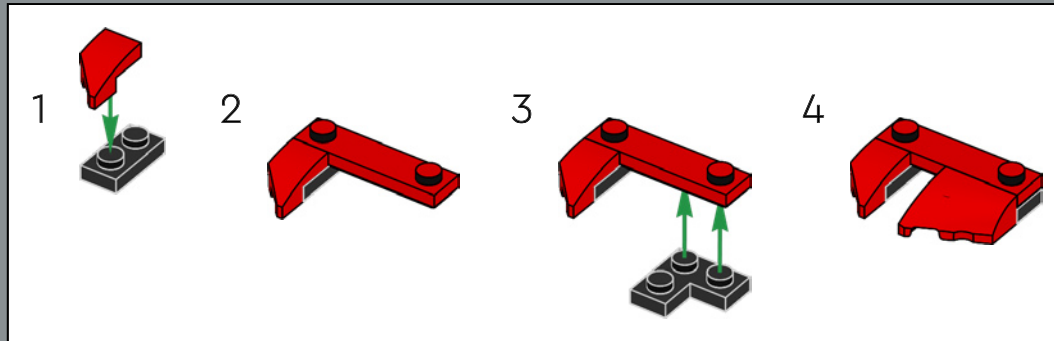



141

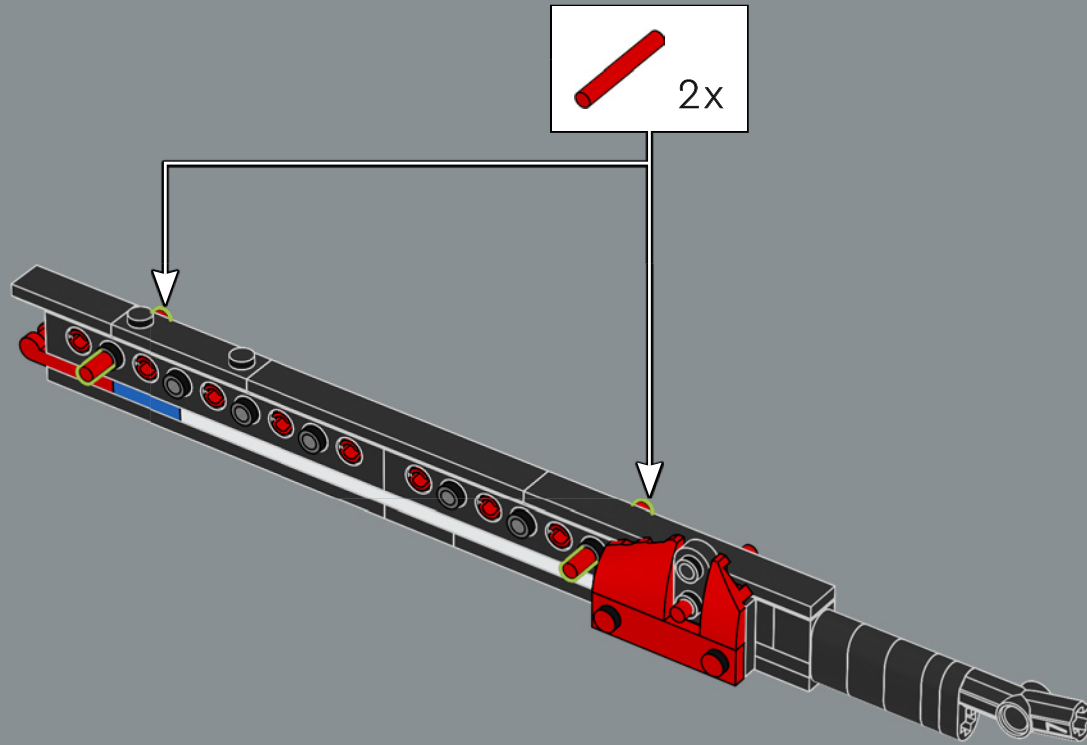

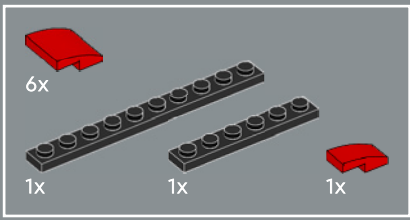

142

1

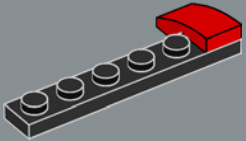

2

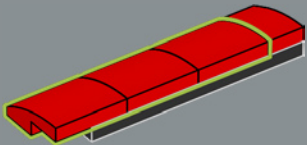

3

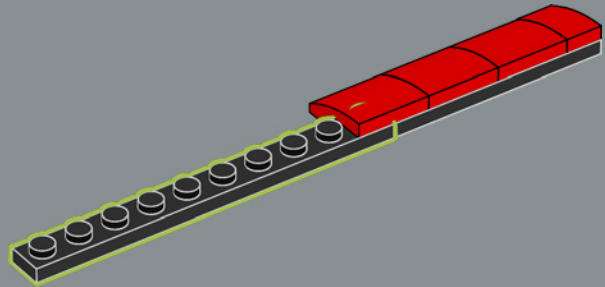

4

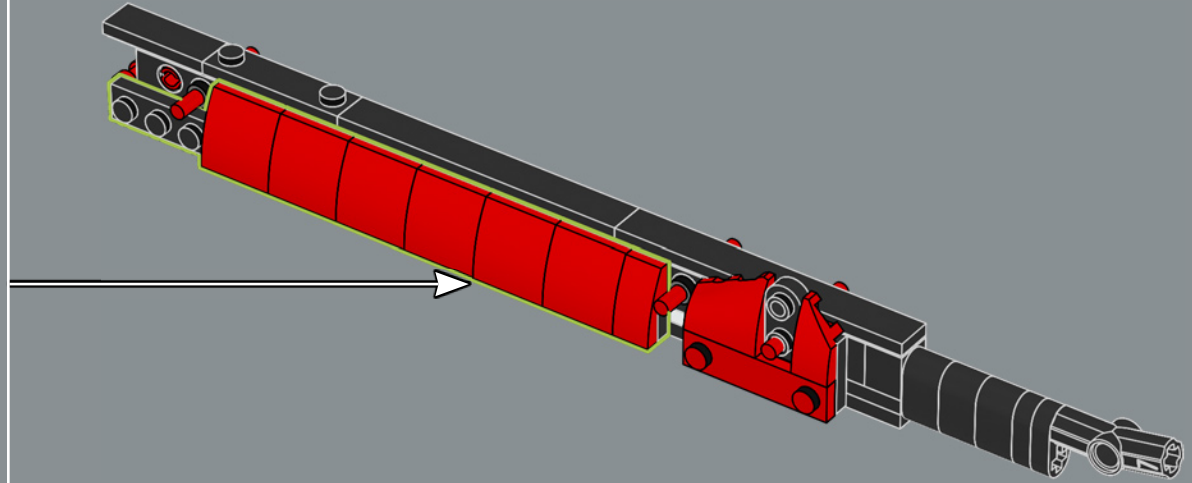
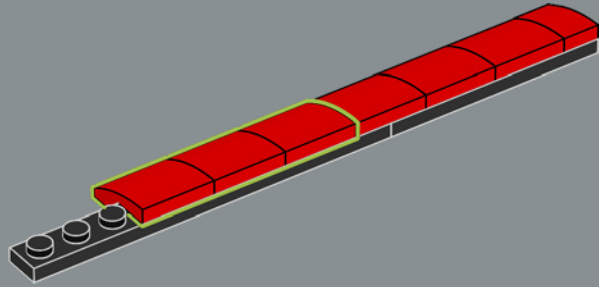

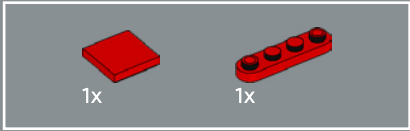
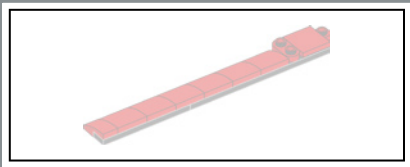

143

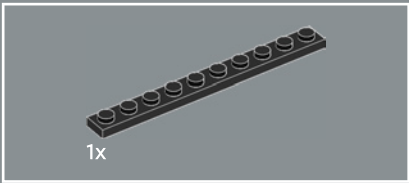
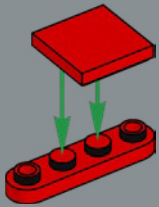

144

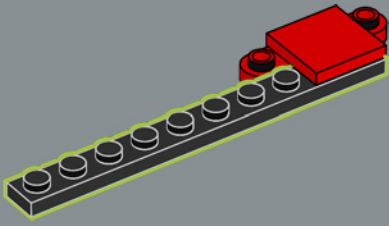

145

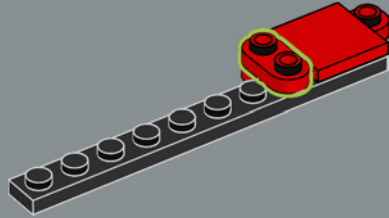

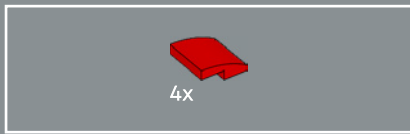

146

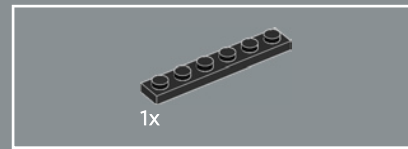
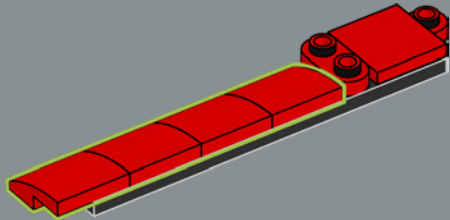

147

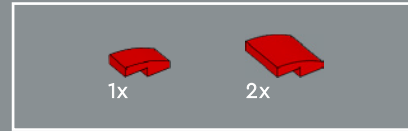
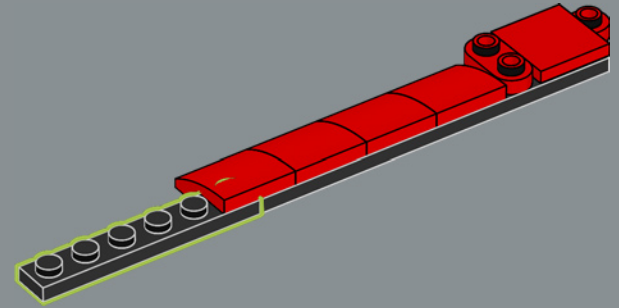

148

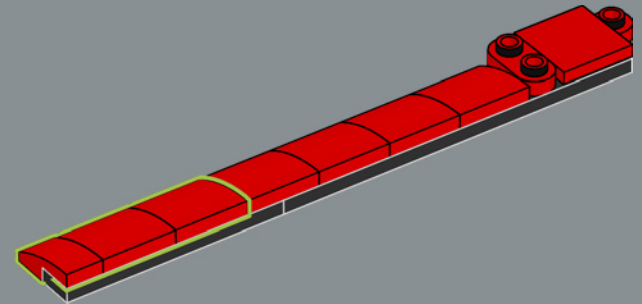

149

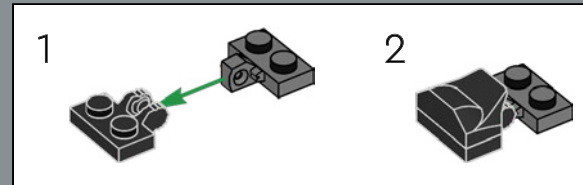
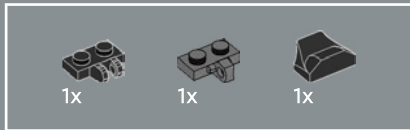
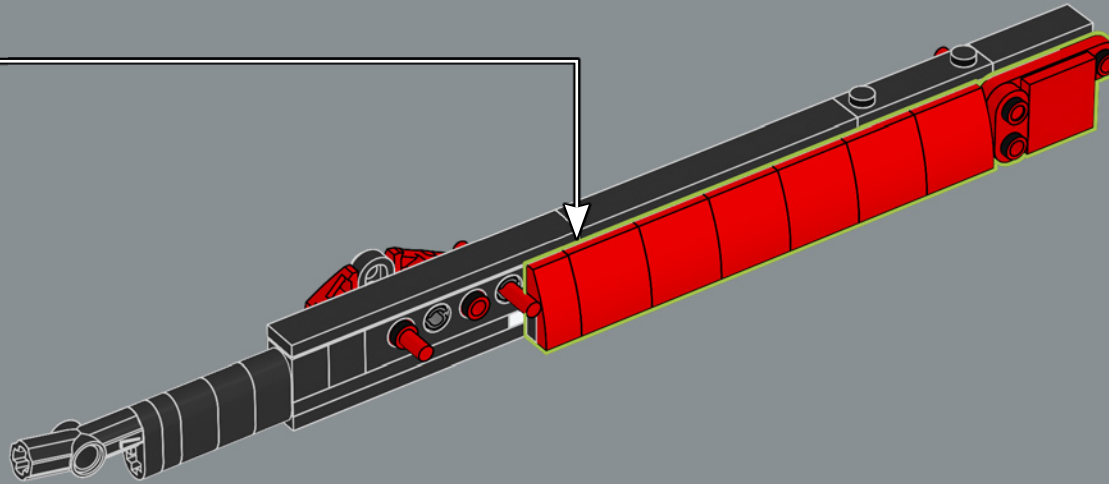

150

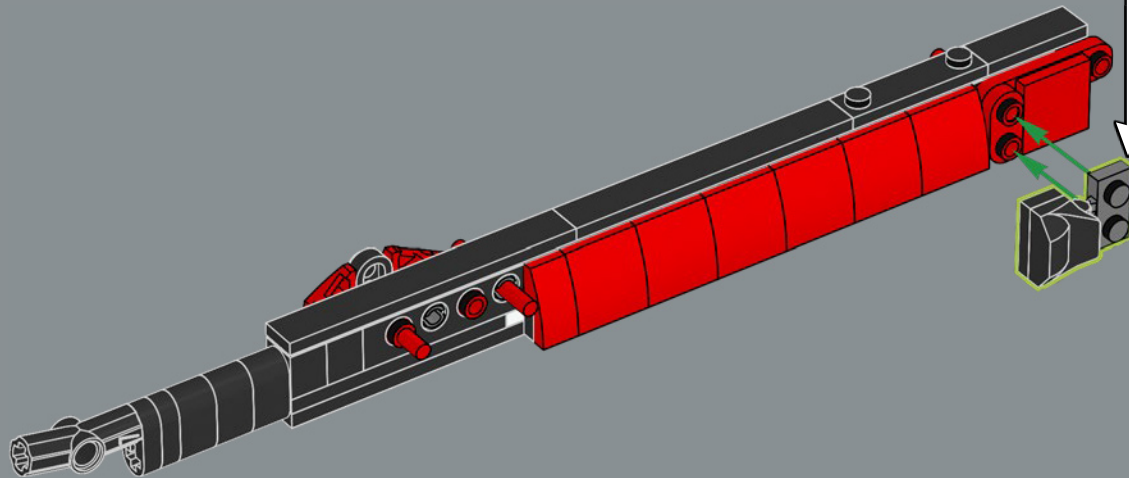



151

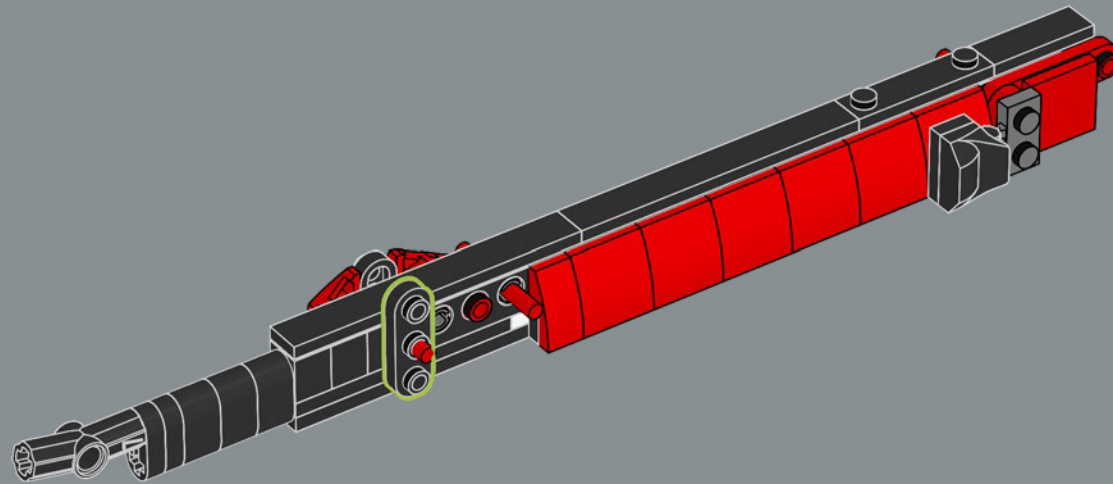

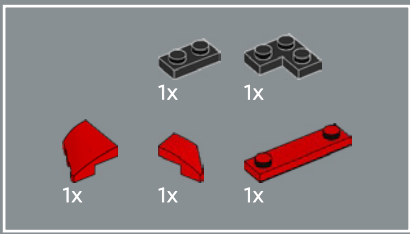

152

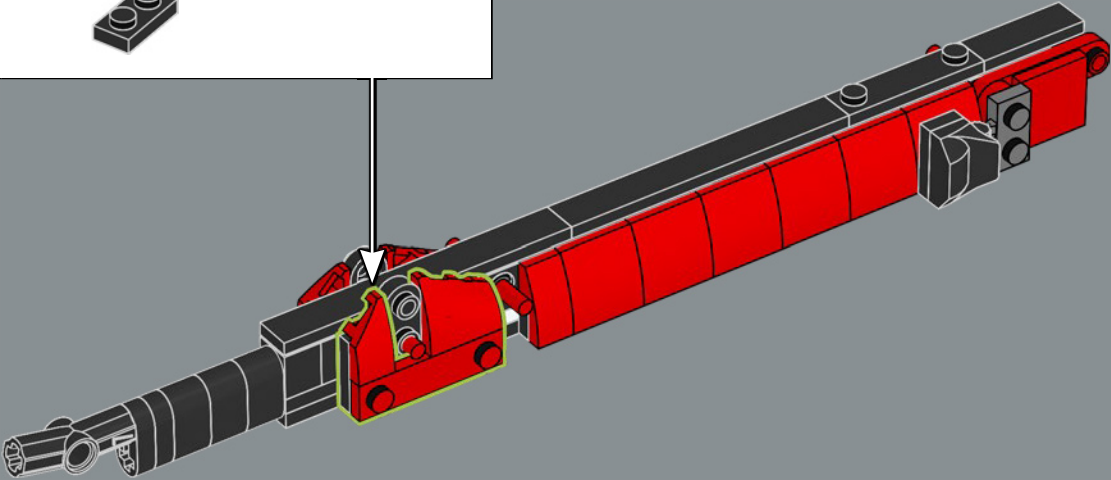
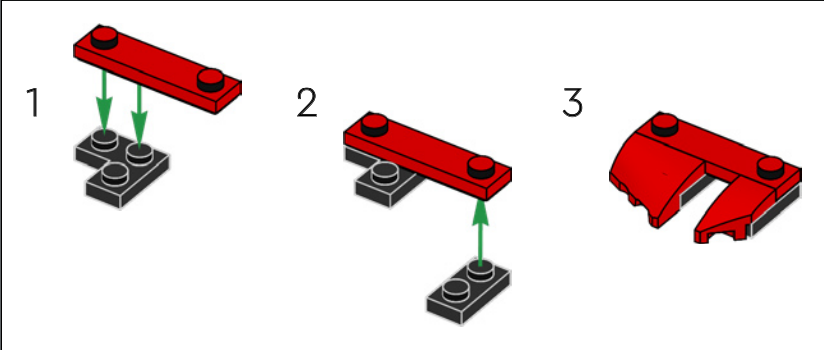

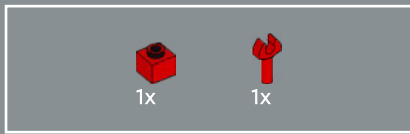

153

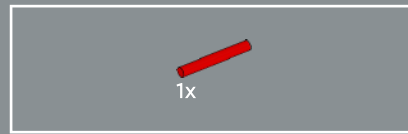
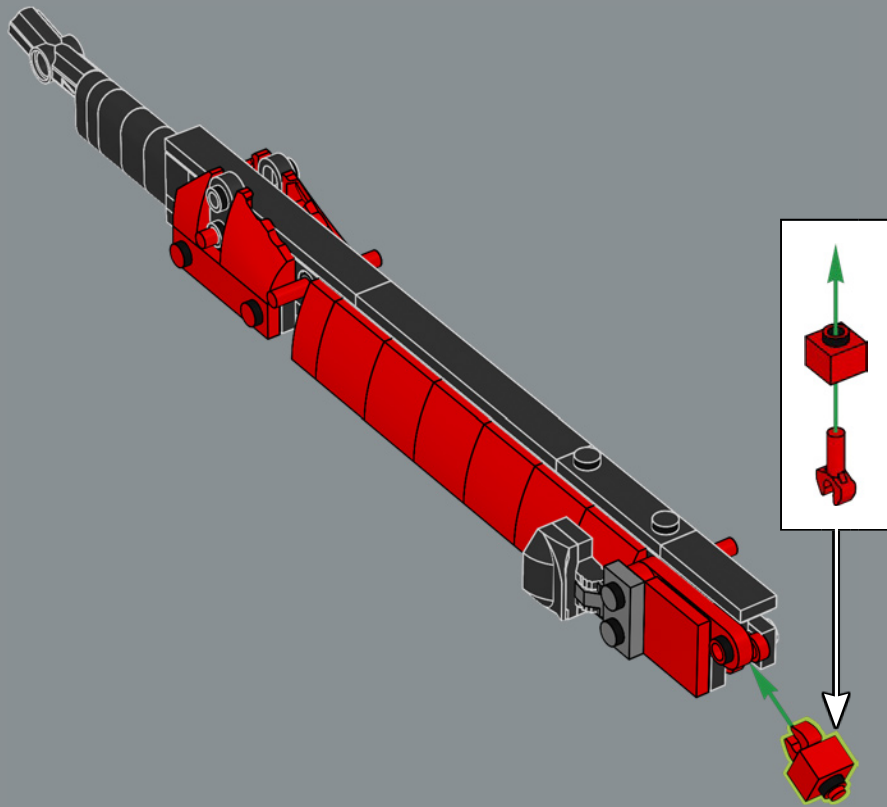

154

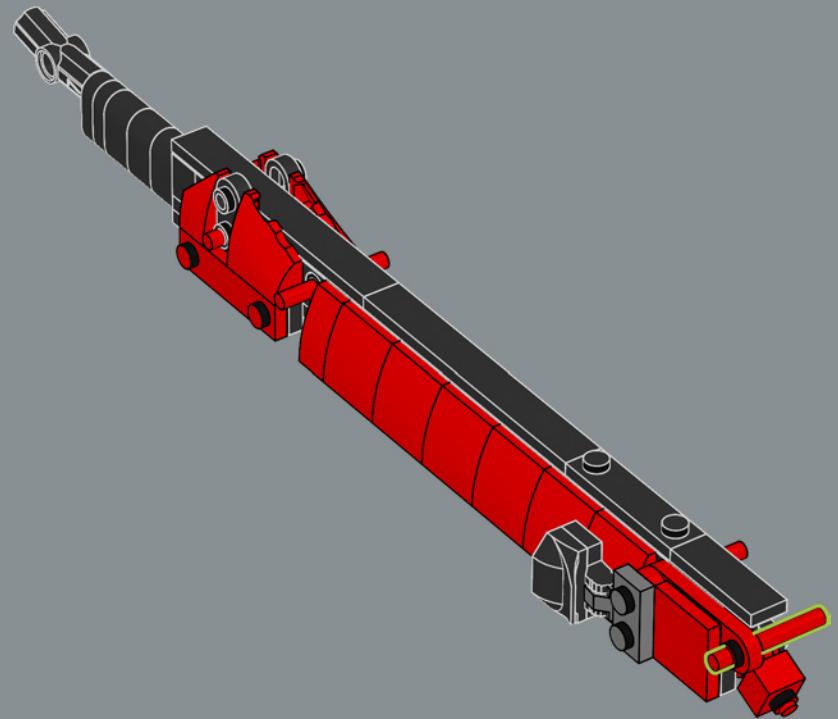



155

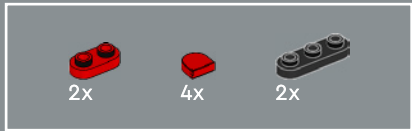
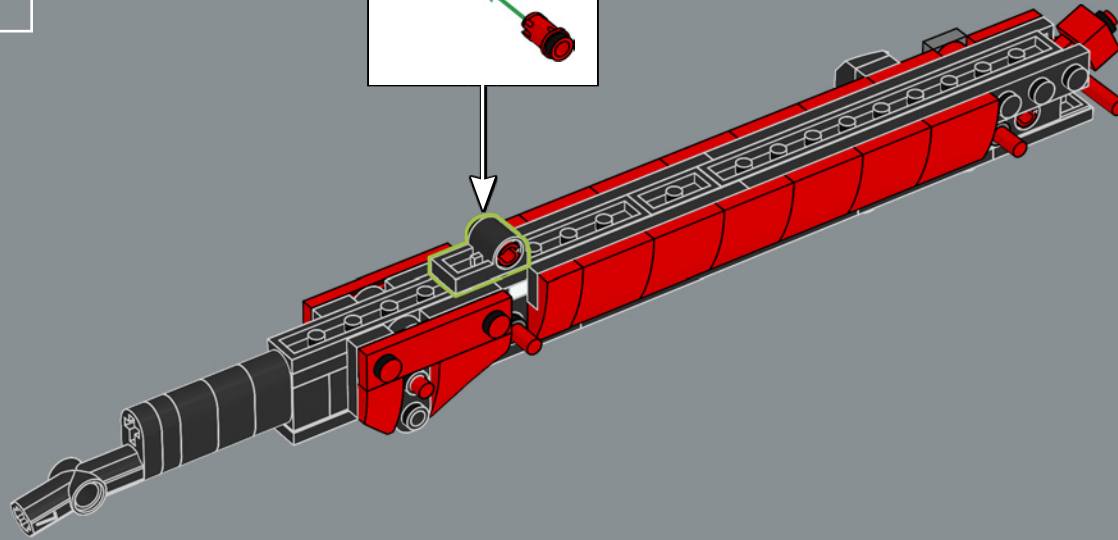
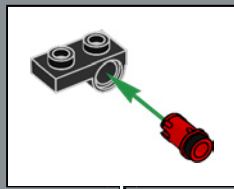

156

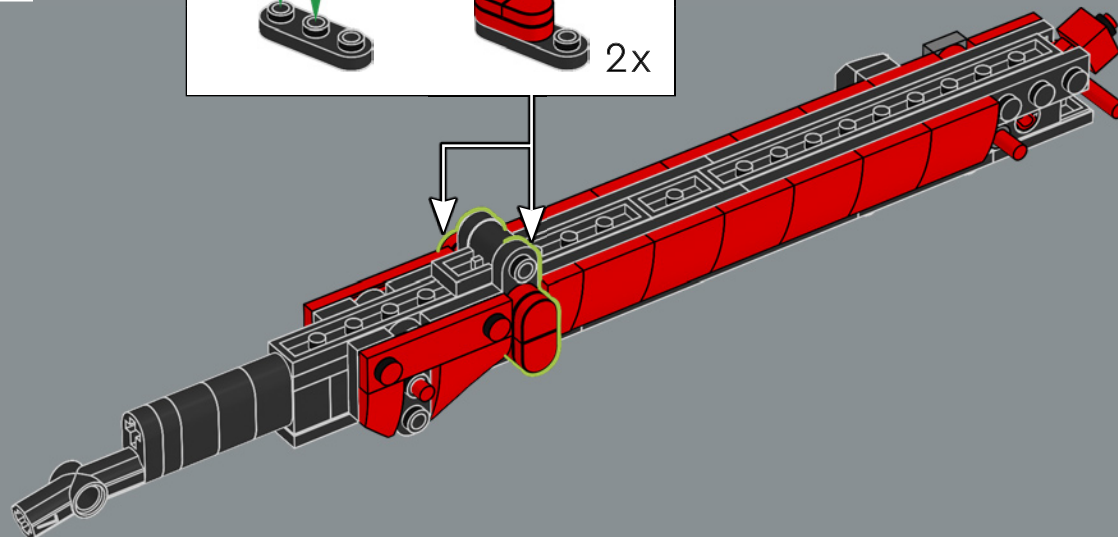
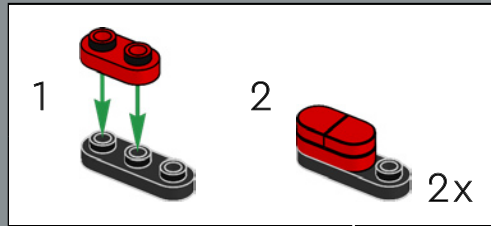

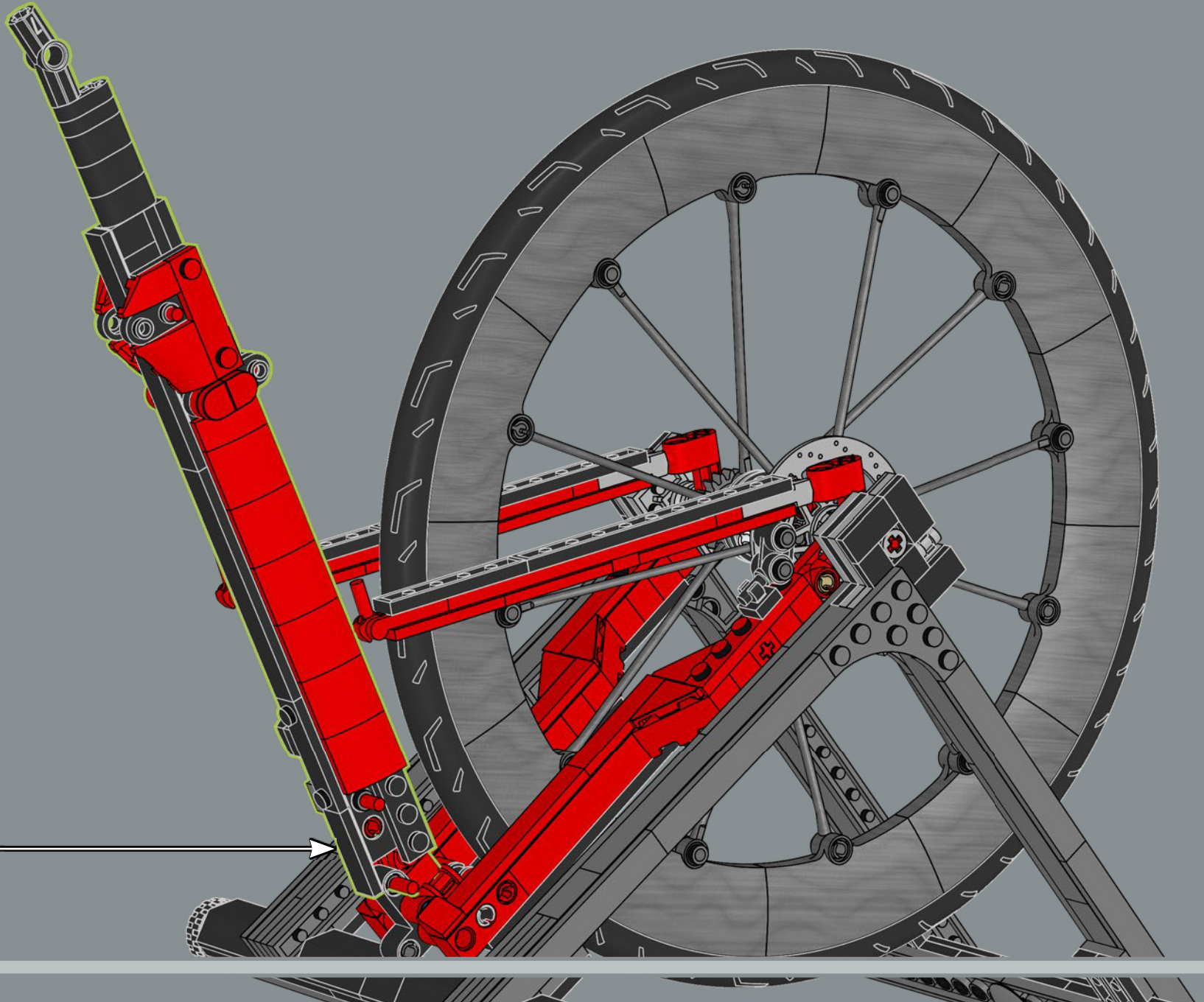



158

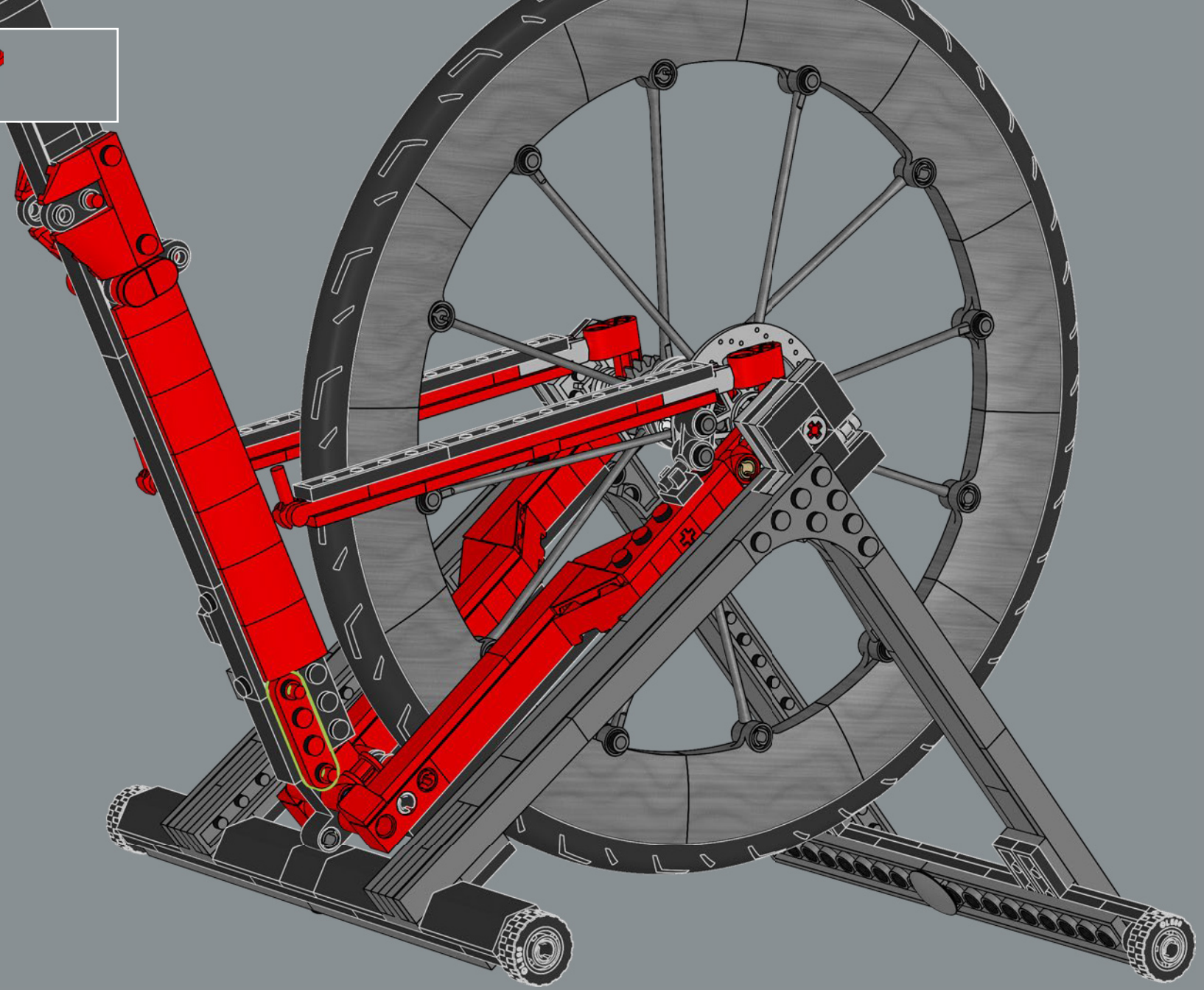



159

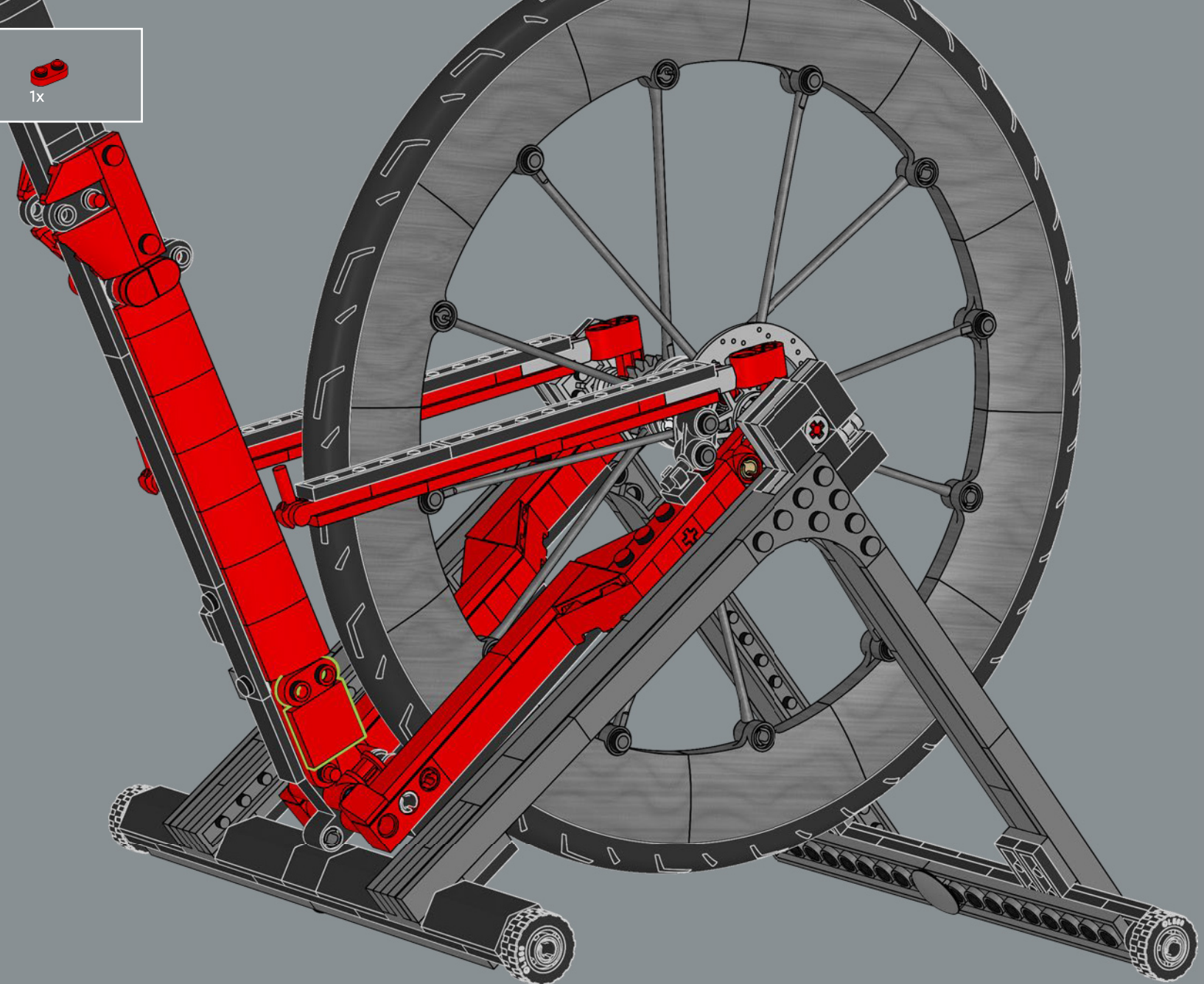

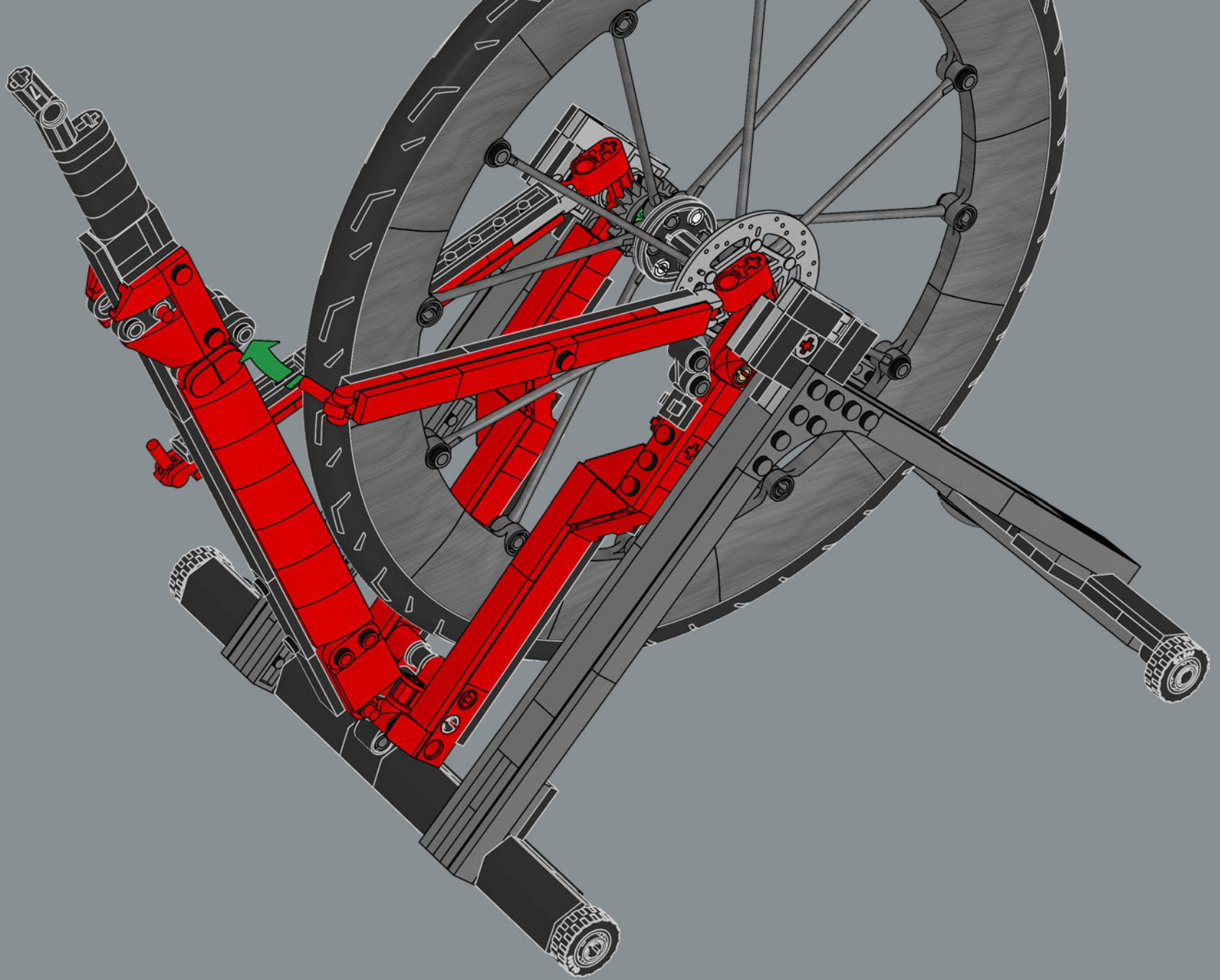

161

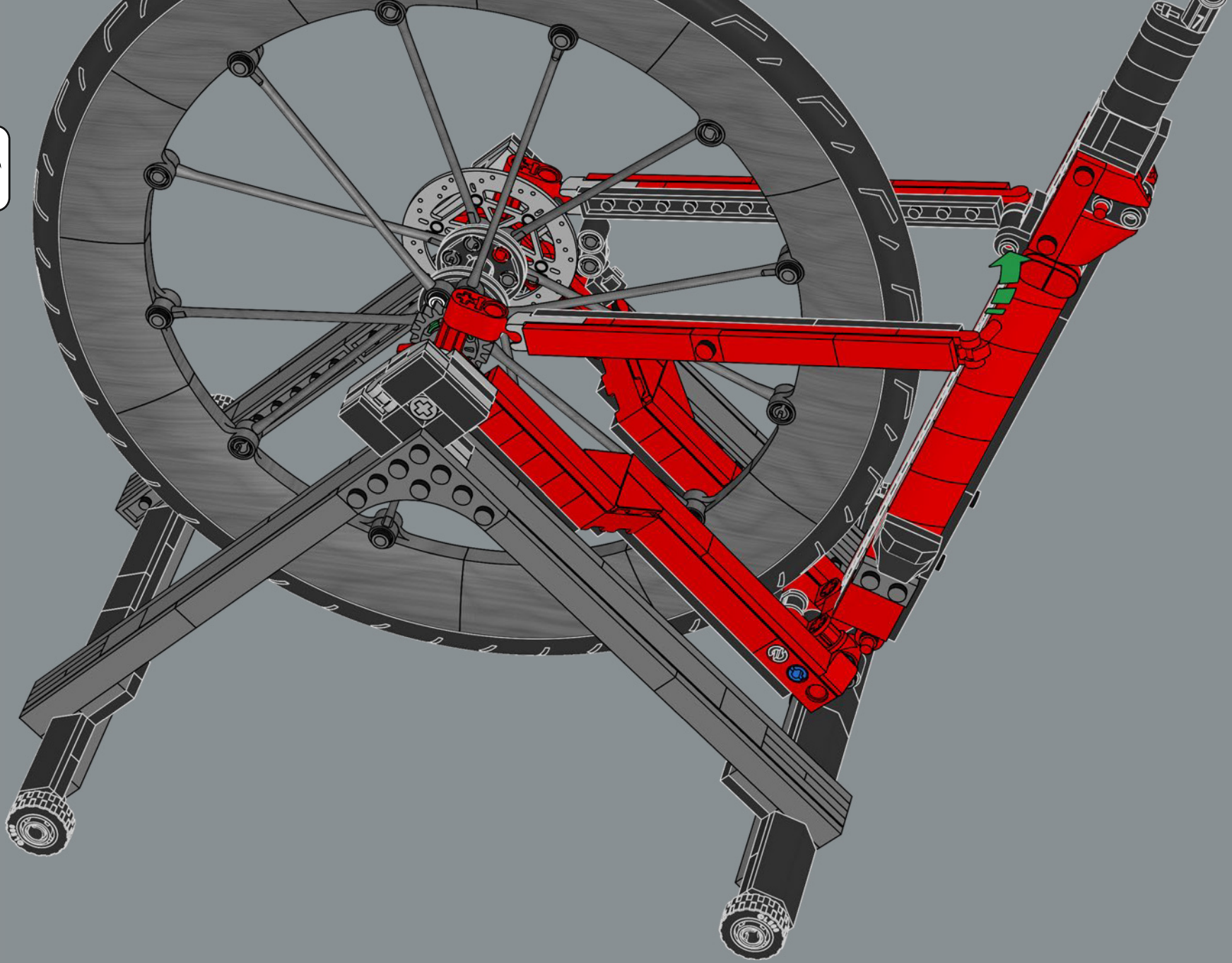

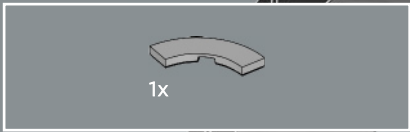

162

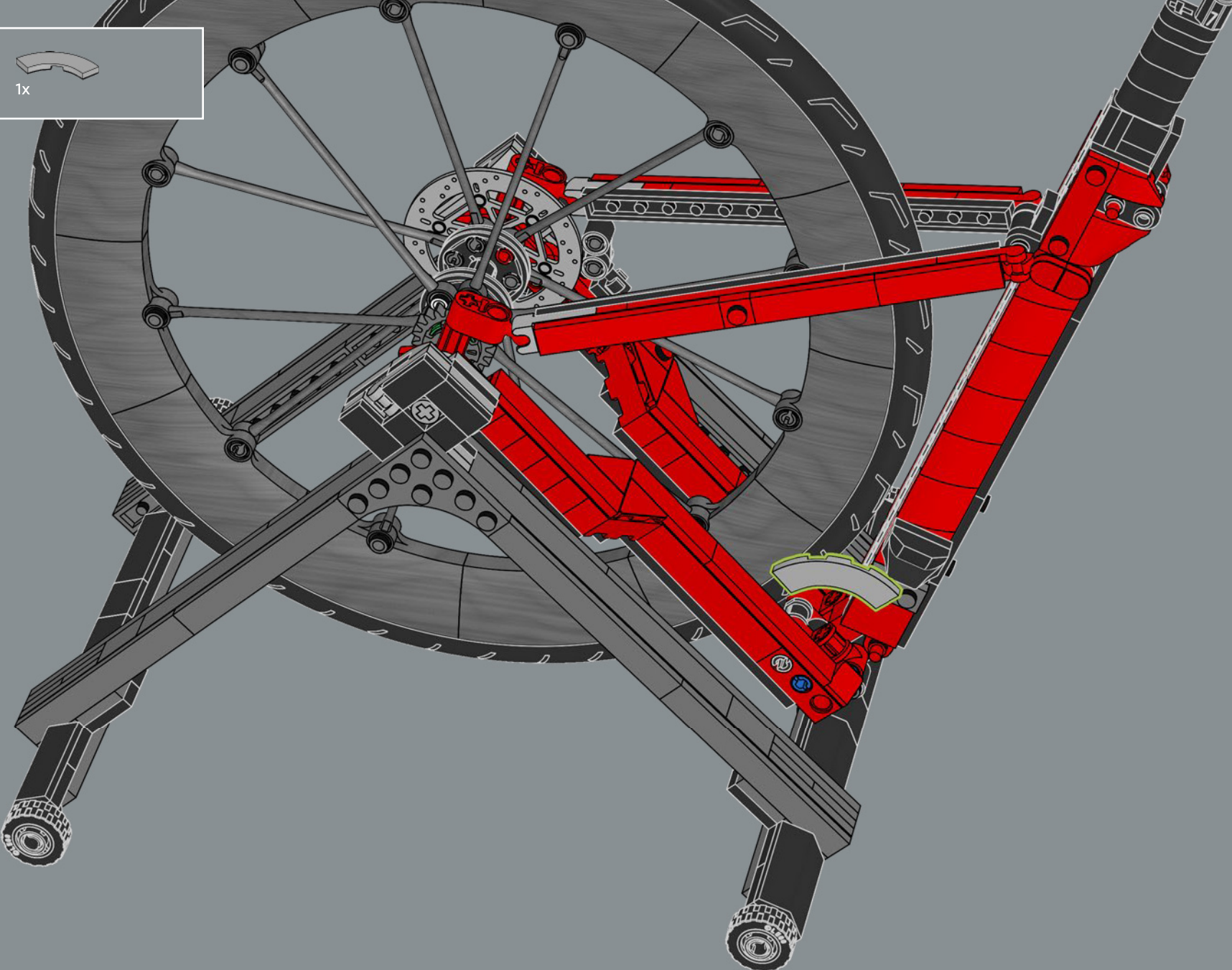

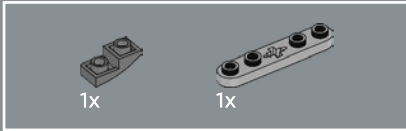
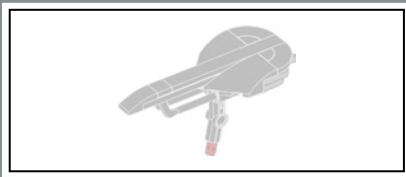

163

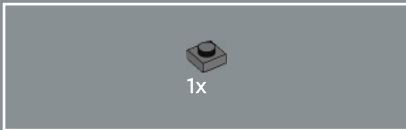
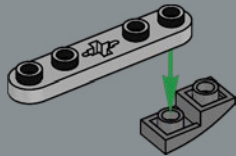

164

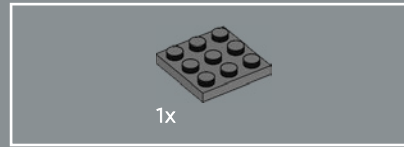
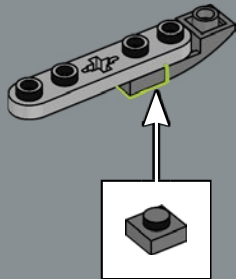

165

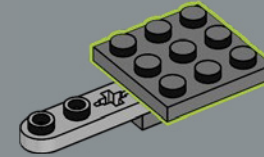

166

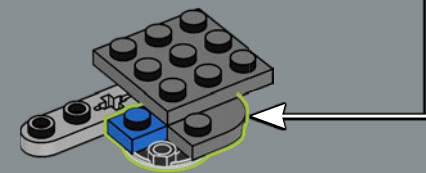
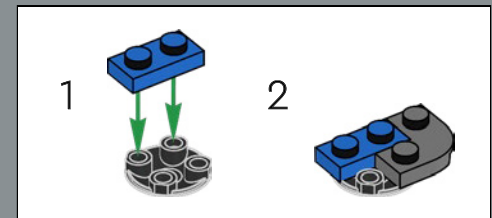

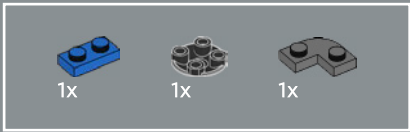

167

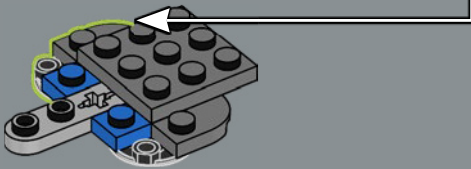
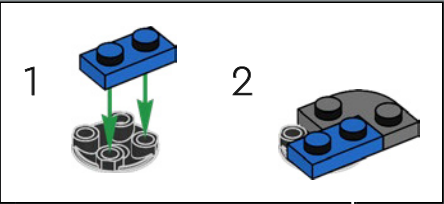

168

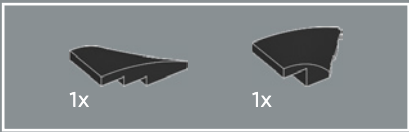
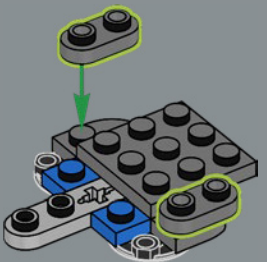

169

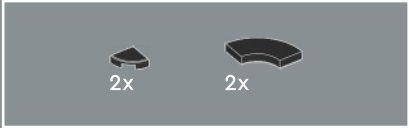
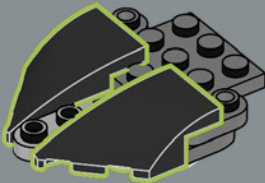

170

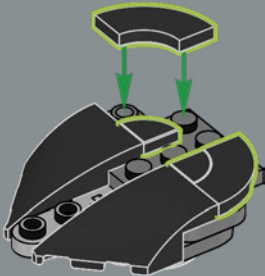

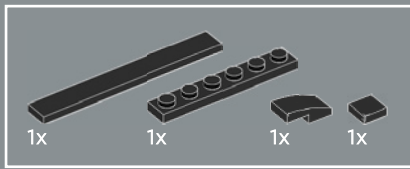

171

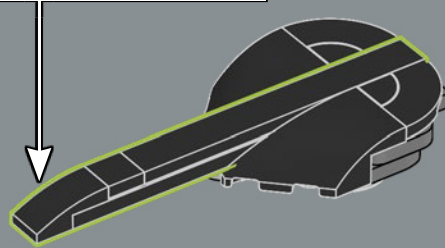
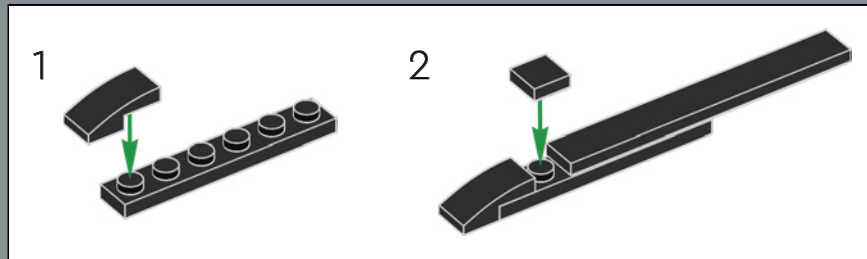

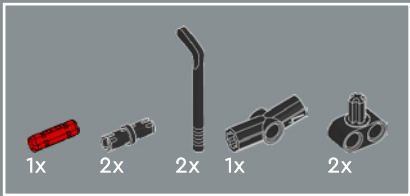

172

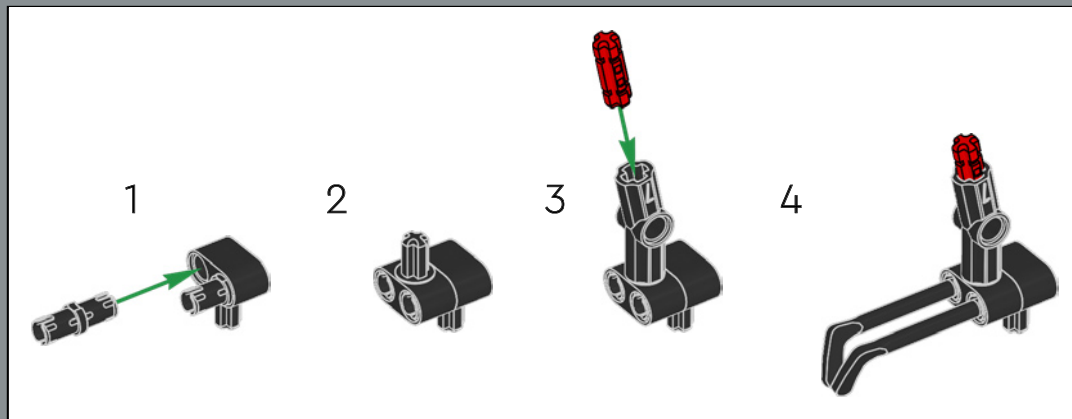

LEGO® minifigure hockey sticks are used to form the rails on the saddle.

Les bâtons de hockey de figurine LEGO® sont utilisés pour former les rails de la selle.

Se usan palos de hockey de minifiguras LEGO® para recrear los soportes del asiento.

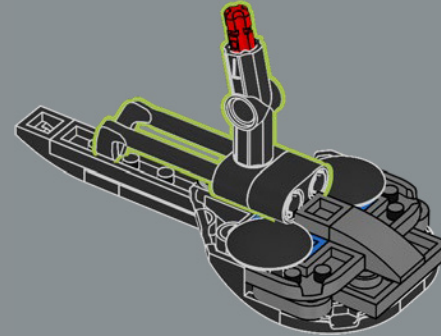

173

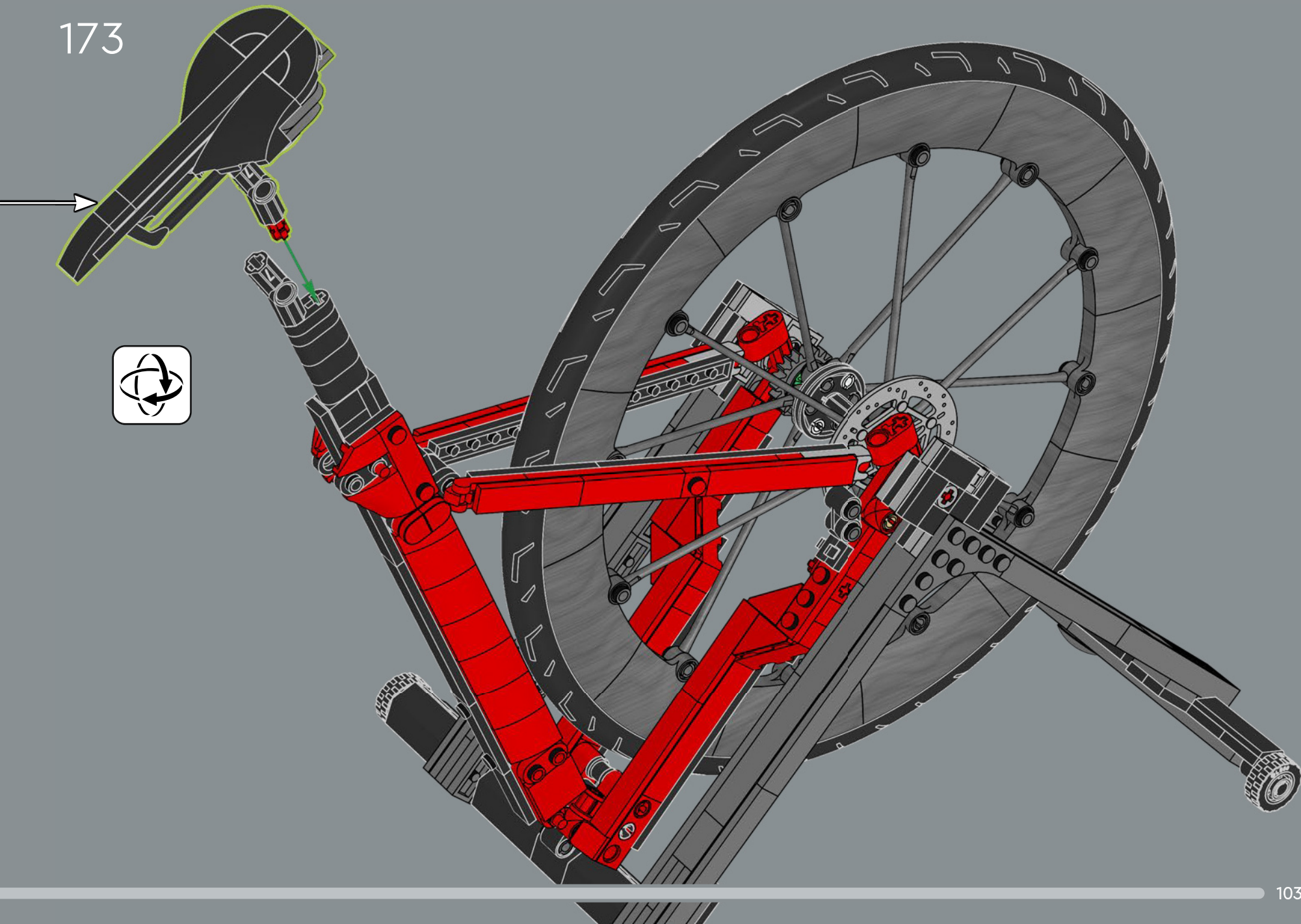

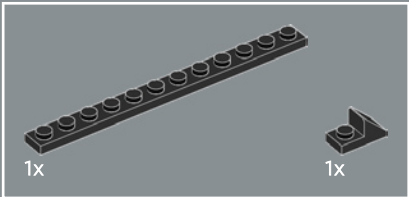
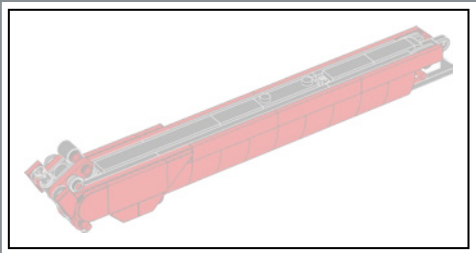

174

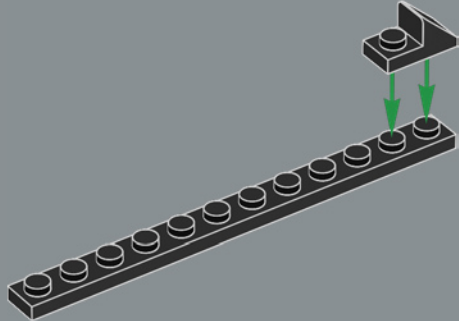

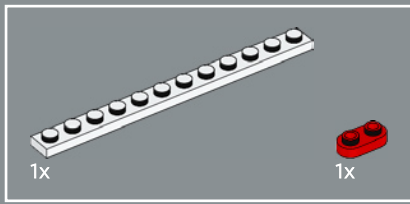

175

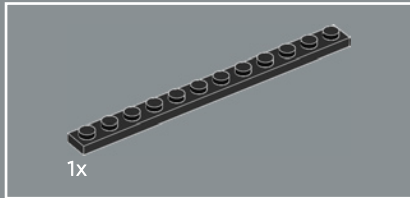
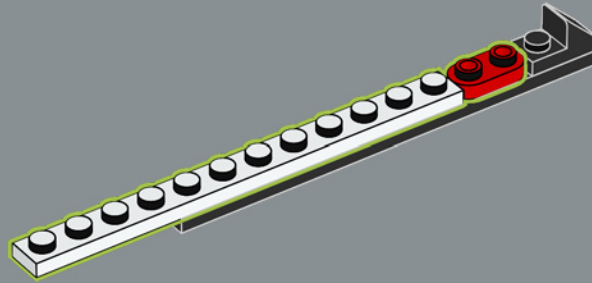

176

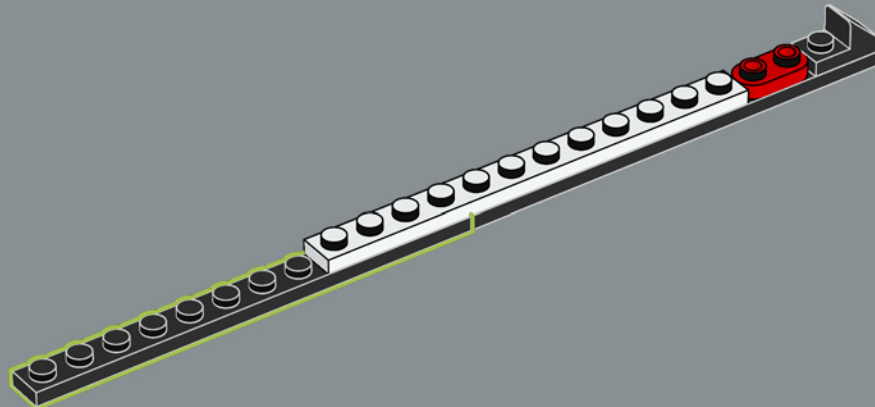

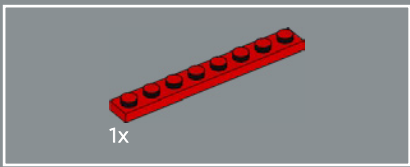

177

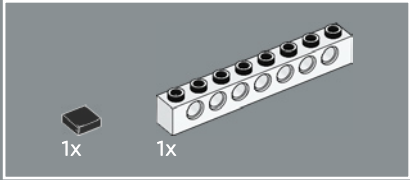
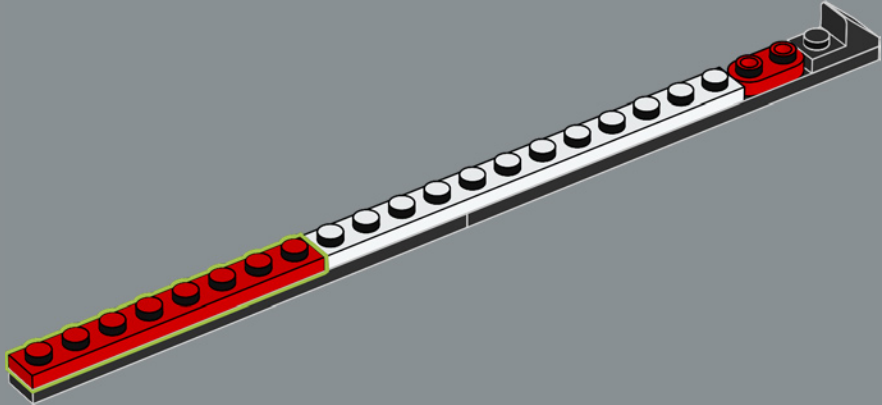

178

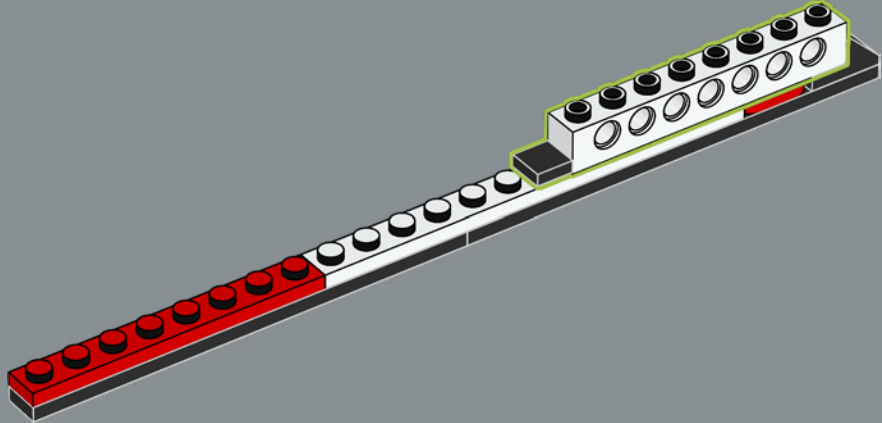

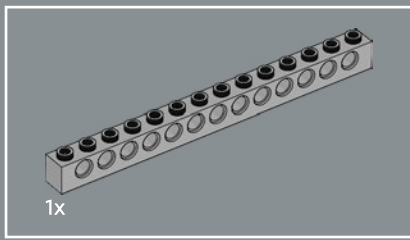

179

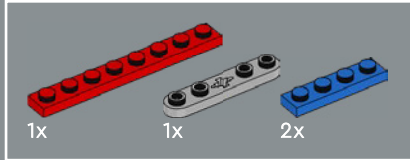
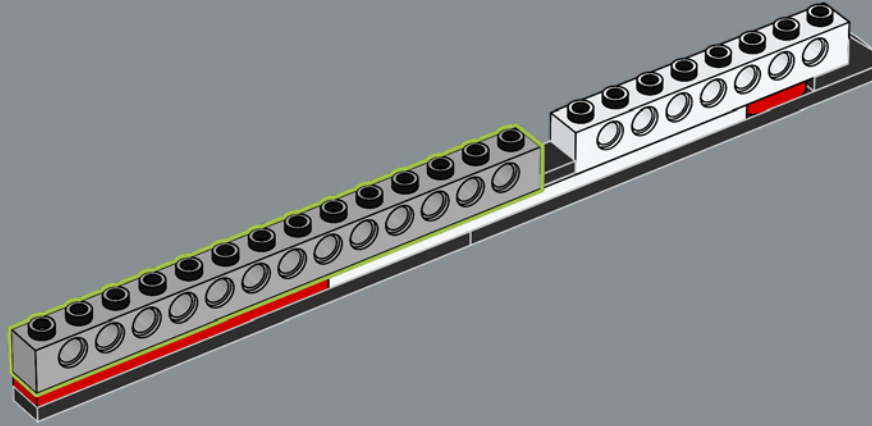

180

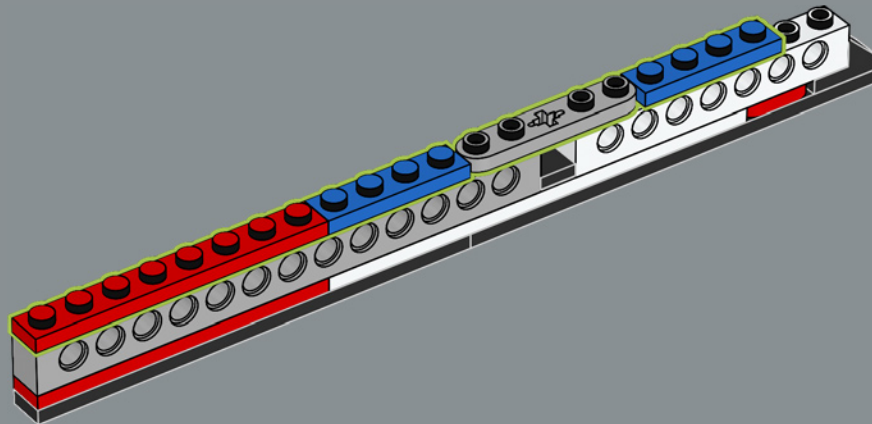

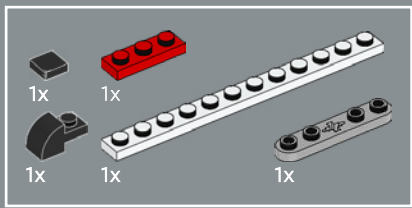

181

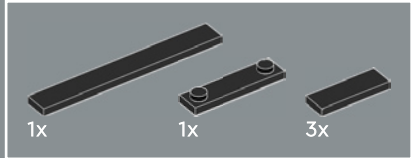
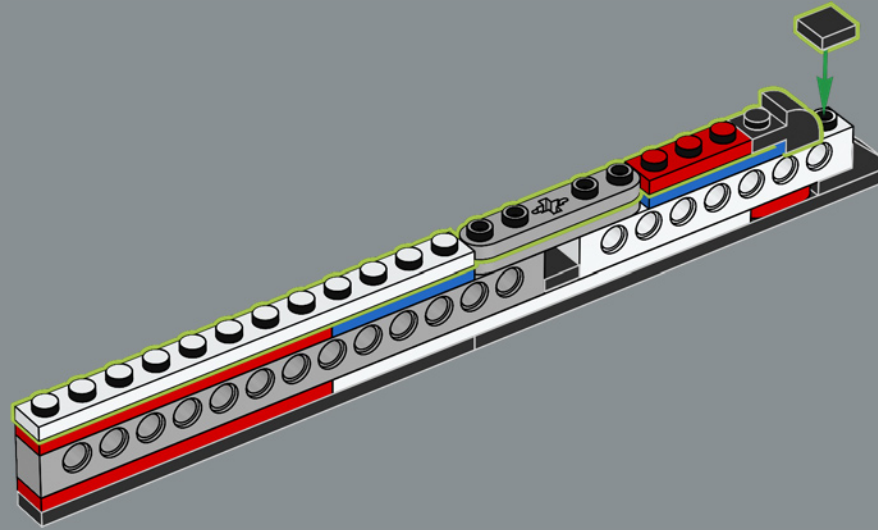

182

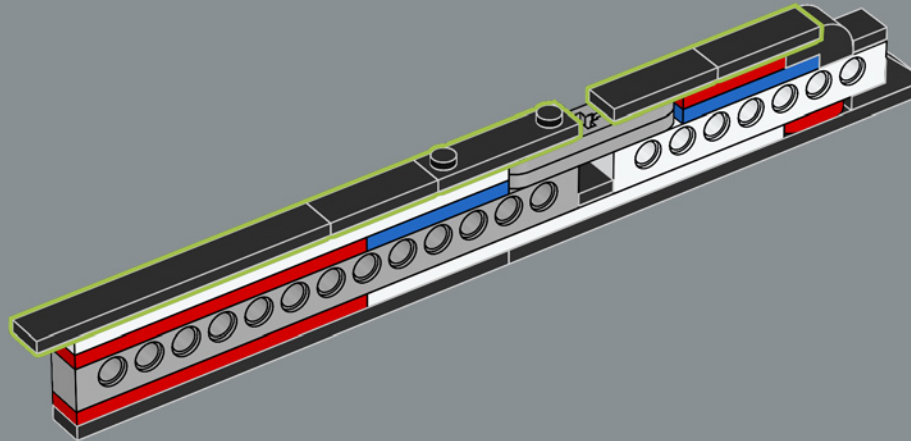



183

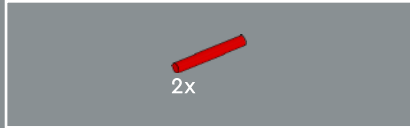
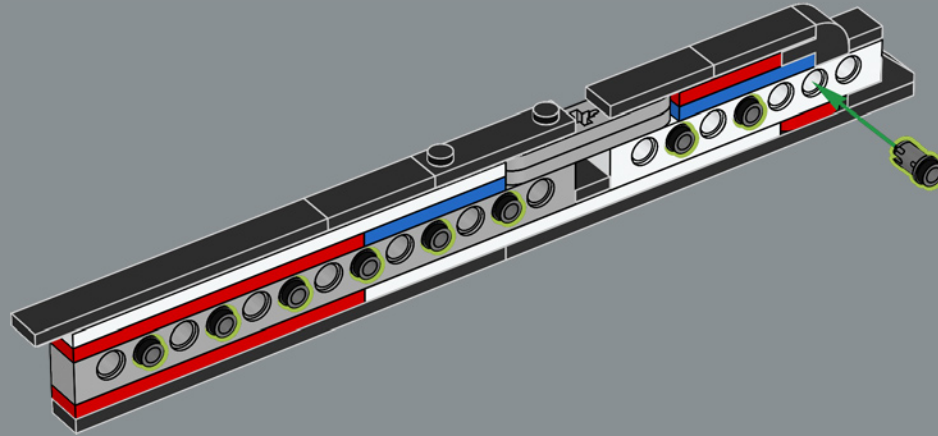

184

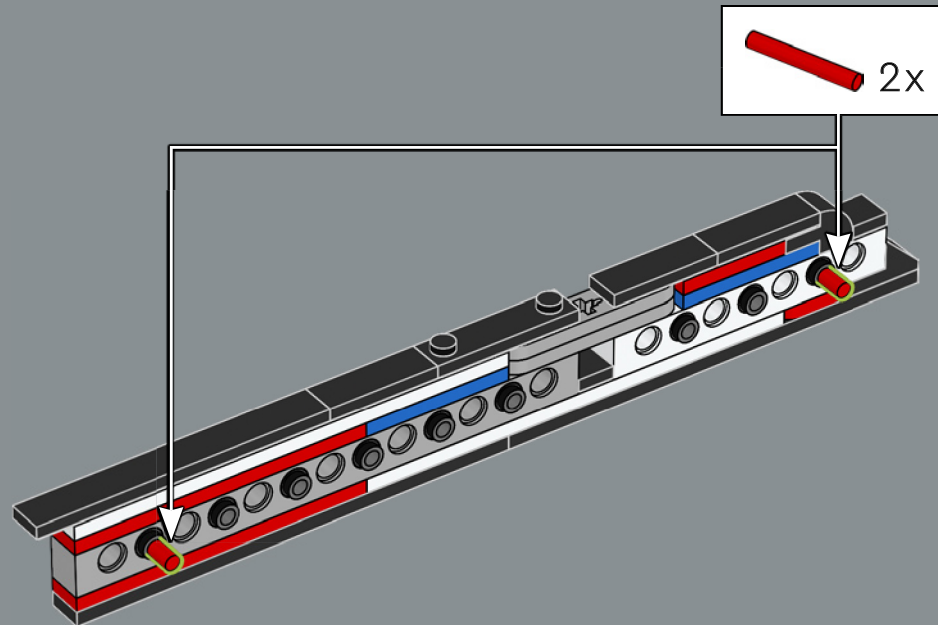

11x

185

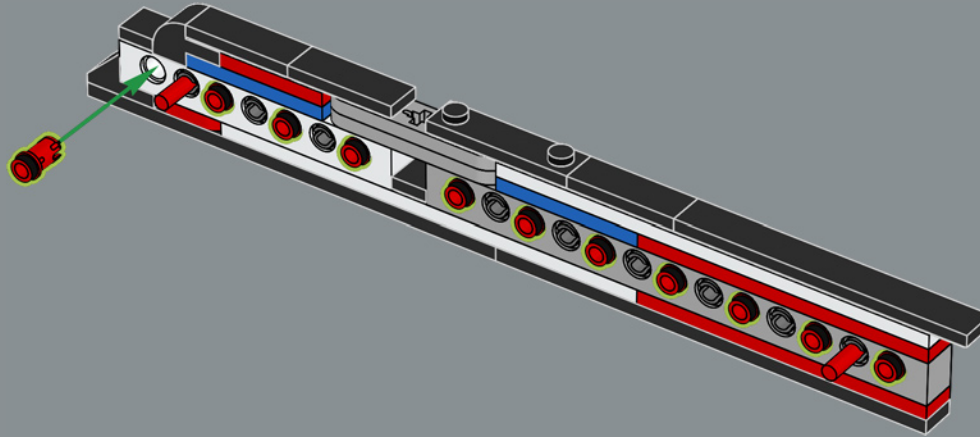

1x

186

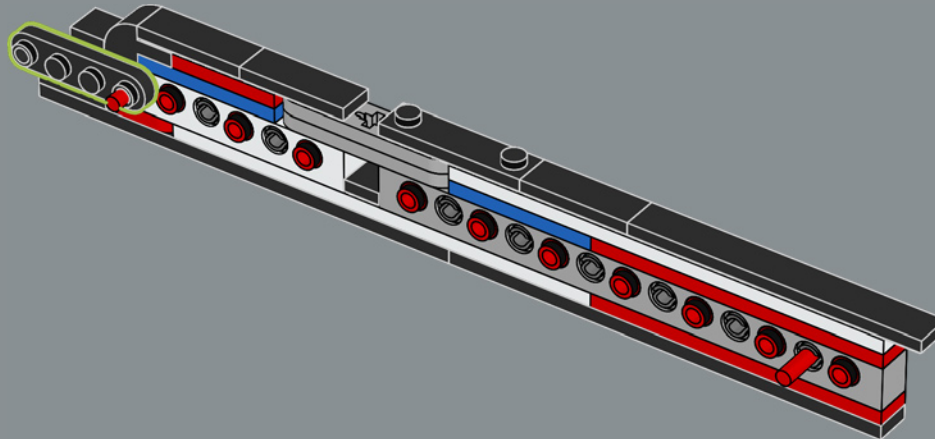

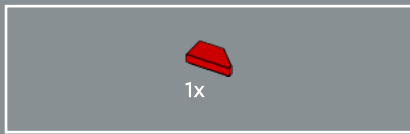

187

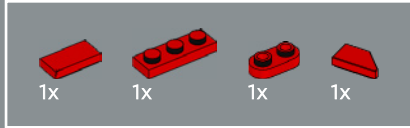
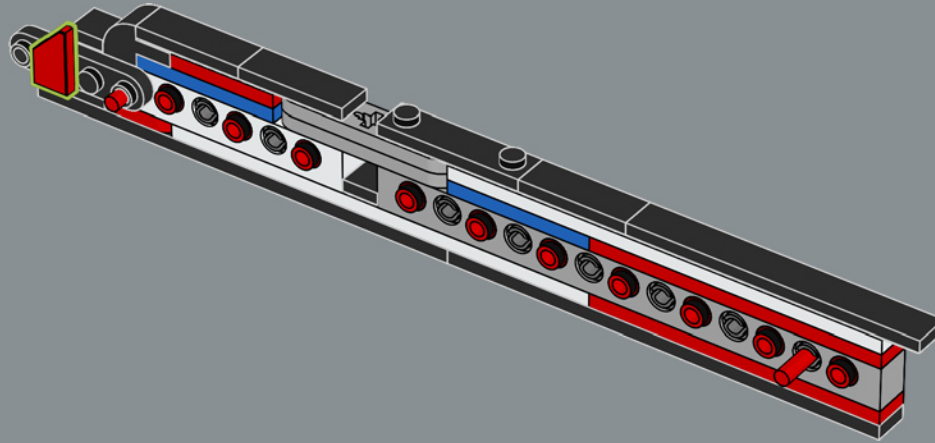

188

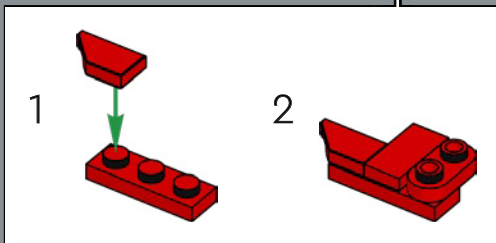
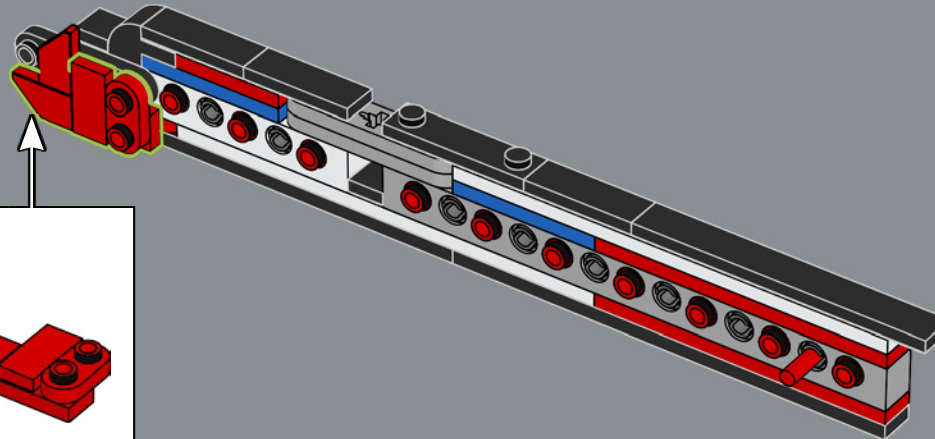

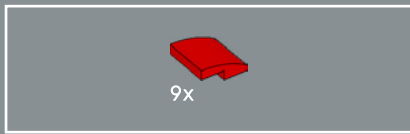

191

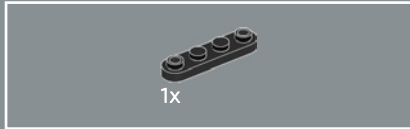
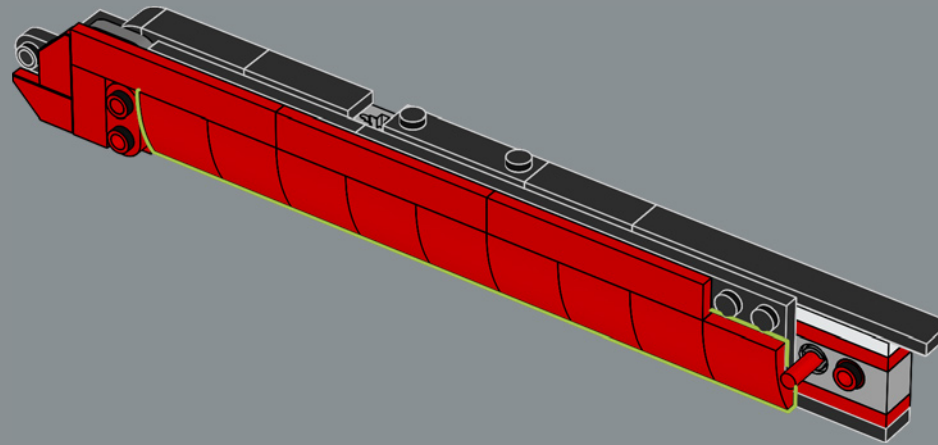

192

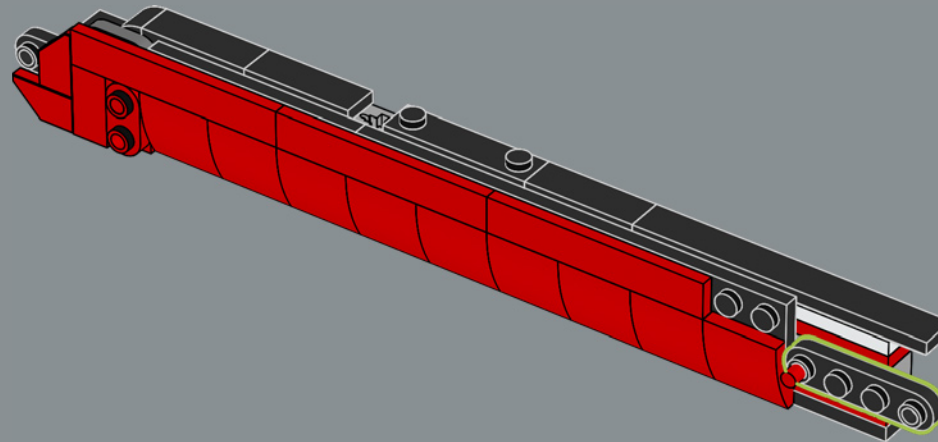

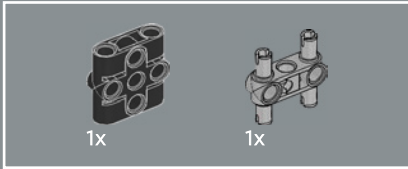
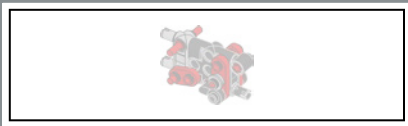

193

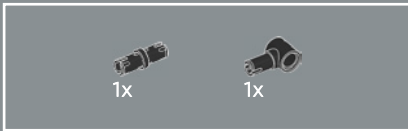
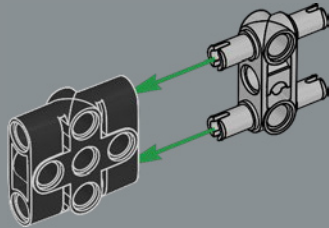

194

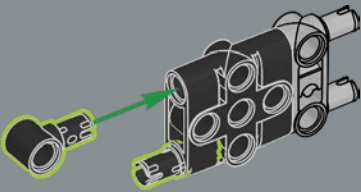

195

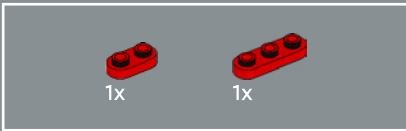
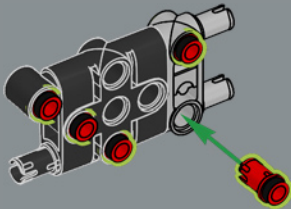

196

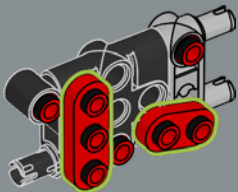



197

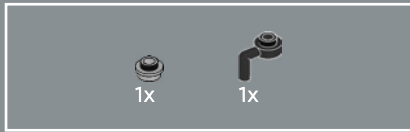
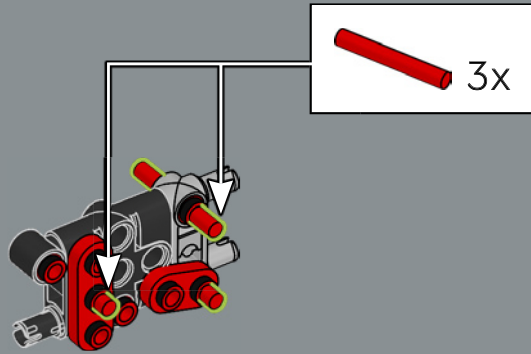

198

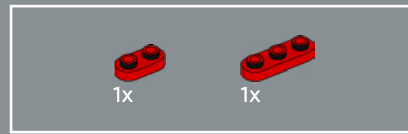
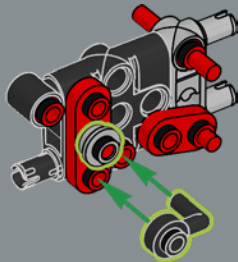

199

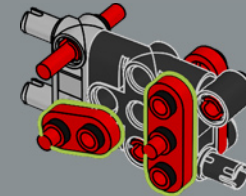

200

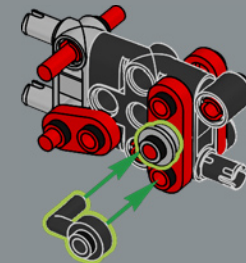

201

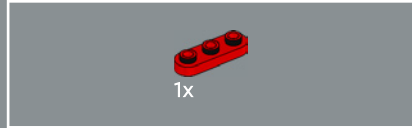
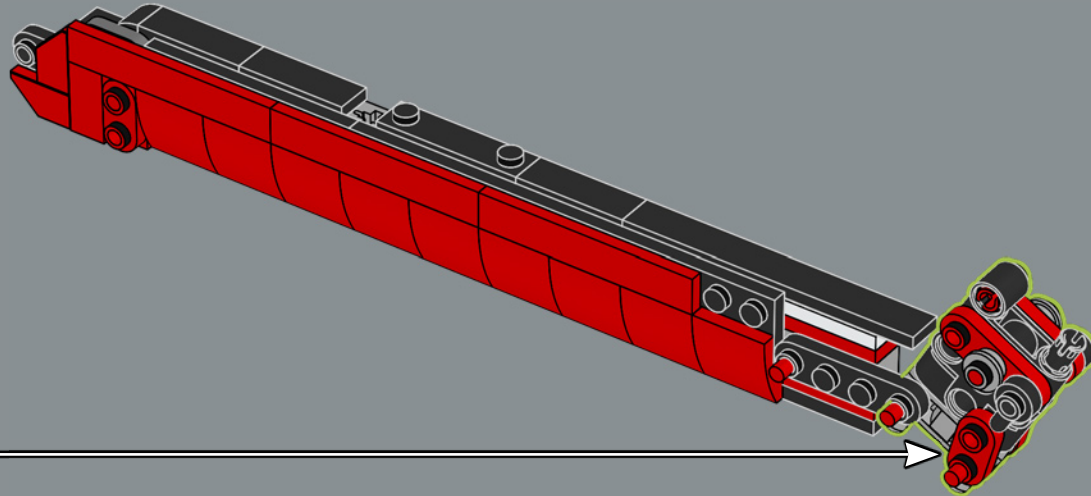

202



The 1x3 and 1x4 rounded plates turned out to be crucial for the complex construction of the bike frame.

Les plaques arrondies 1x3 et 1x4 se sont révélées essentielles à la construction complexe du cadre du vélo.

Las placas redondeadas 1x3 y 1x4 resultaron cruciales para la compleja construcción del cuadro de la bicicleta.

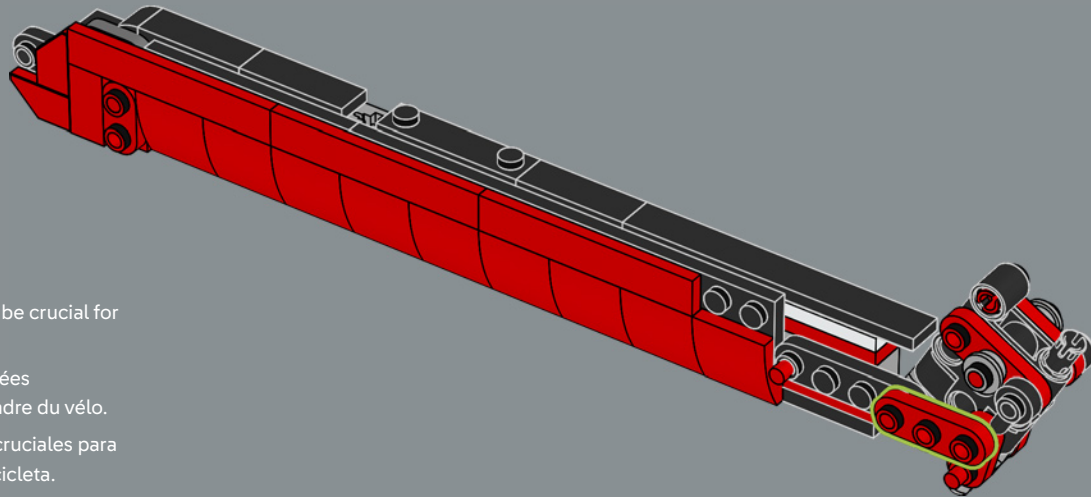

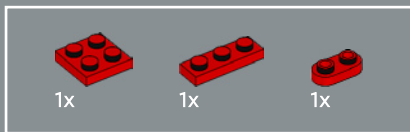

203

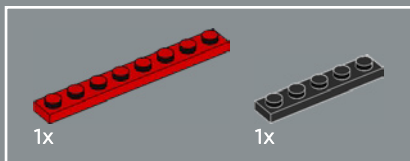
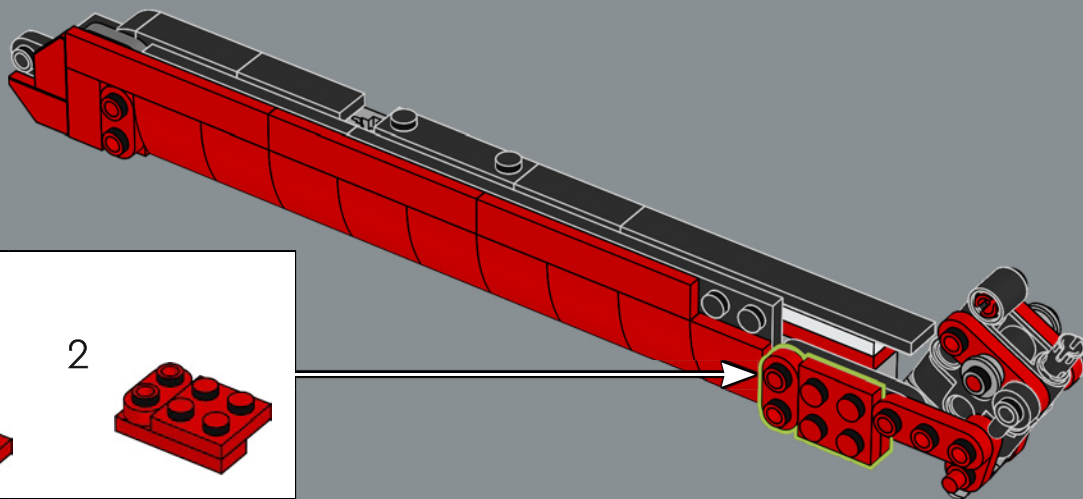
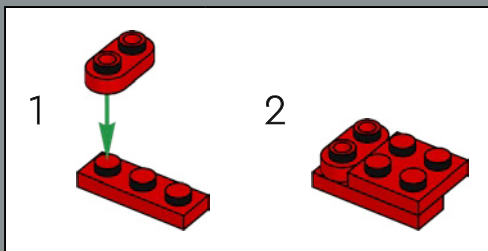

204

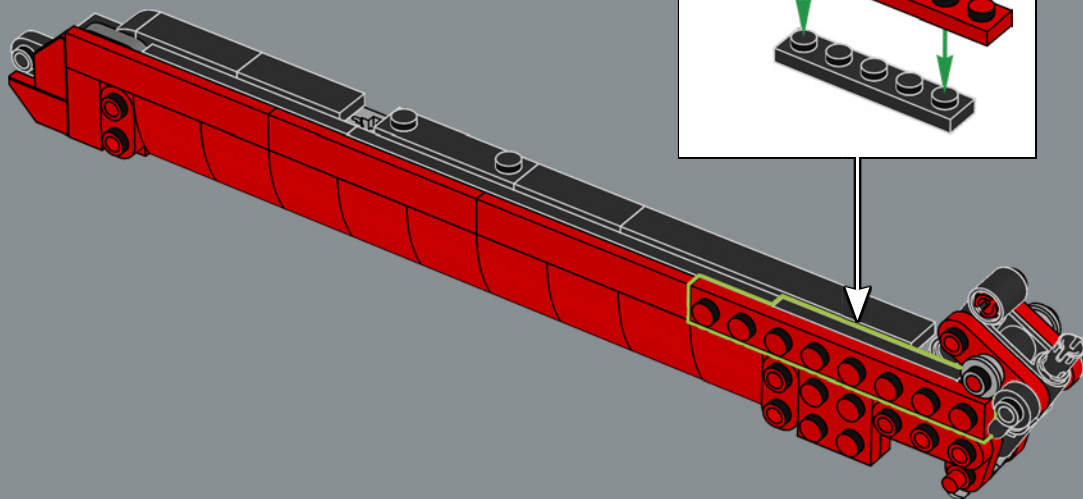
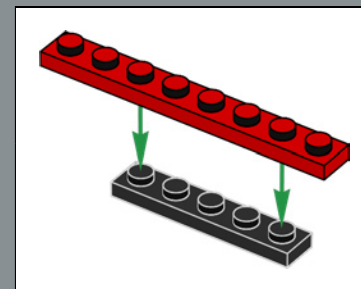

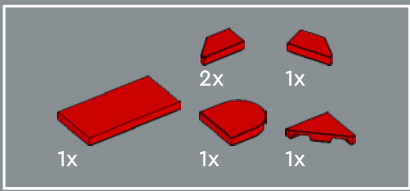

205

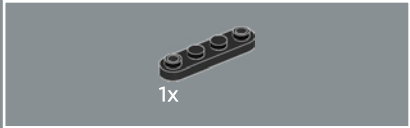
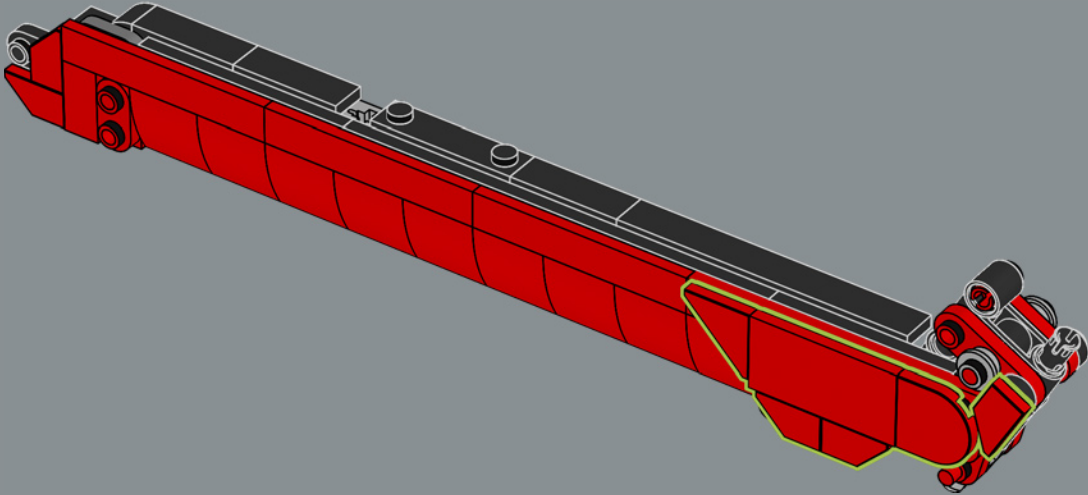

206

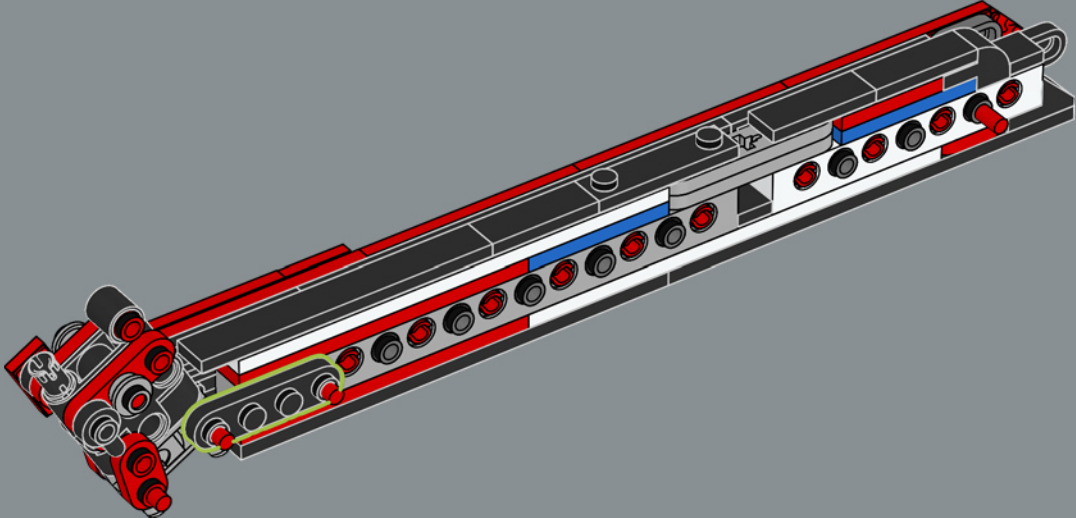

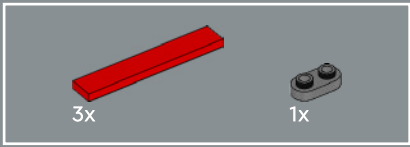

209

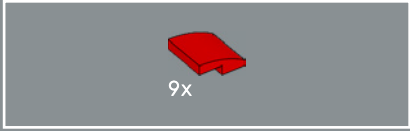
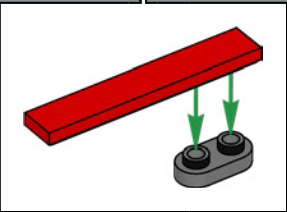
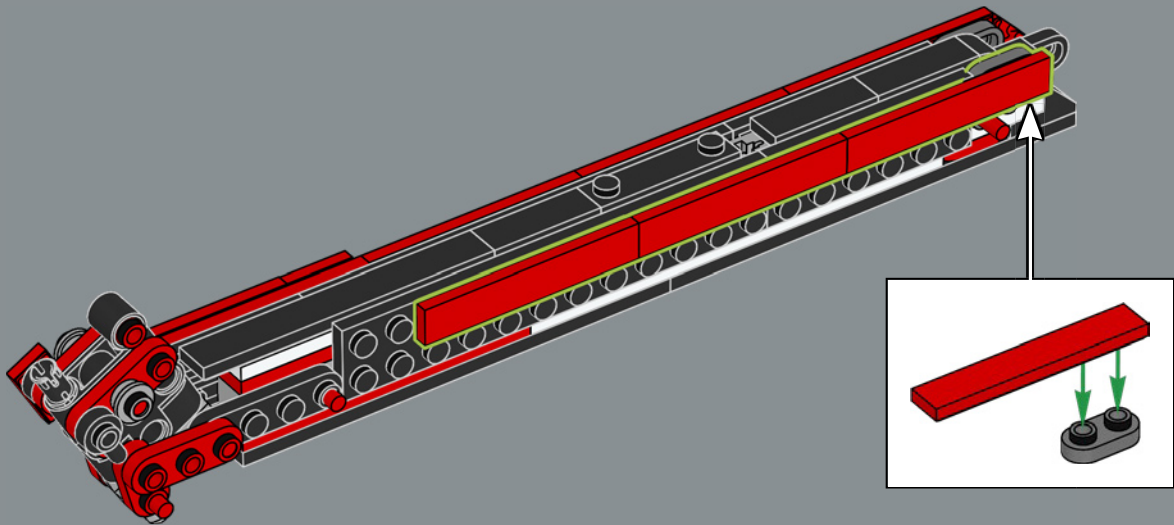

210

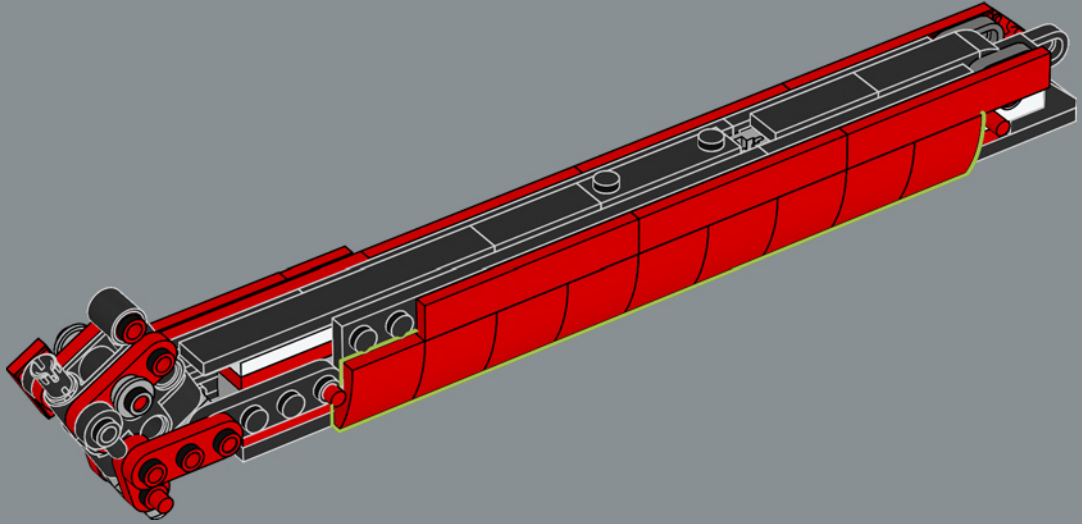

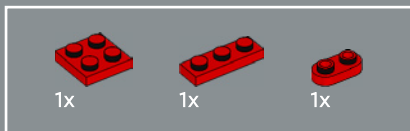

211

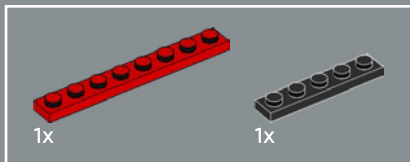
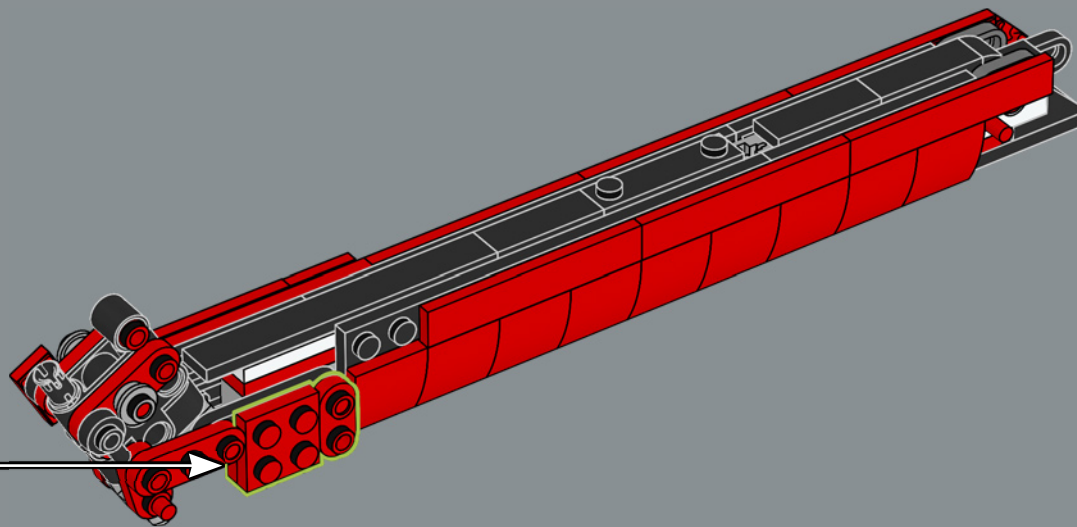
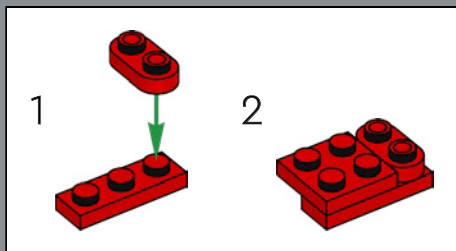

212

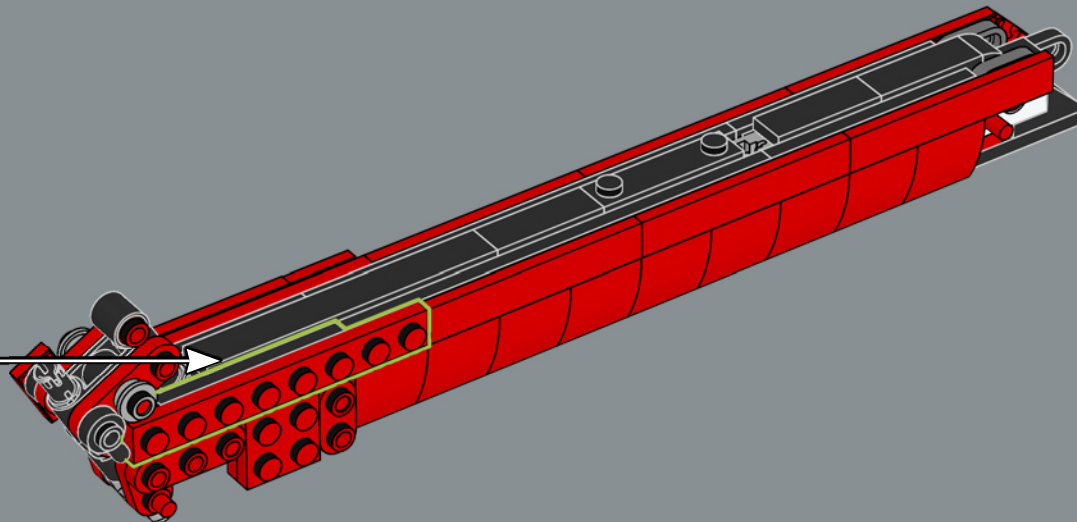
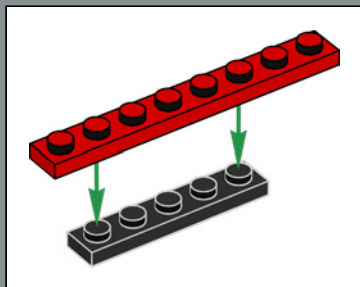

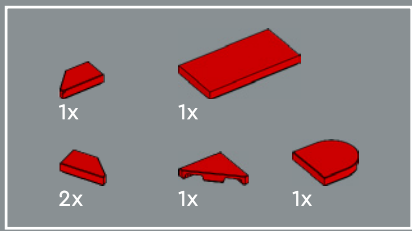

213

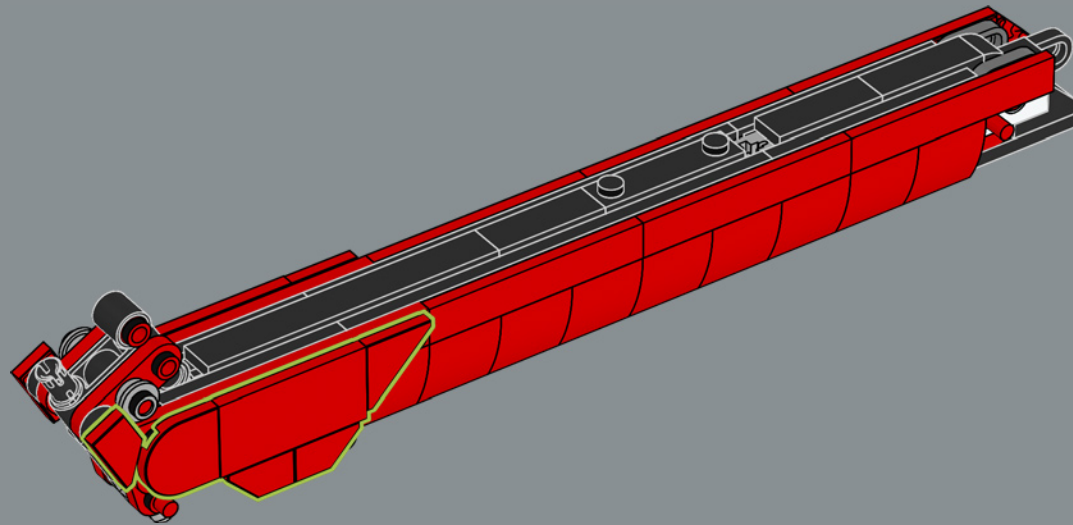

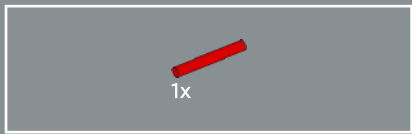

214

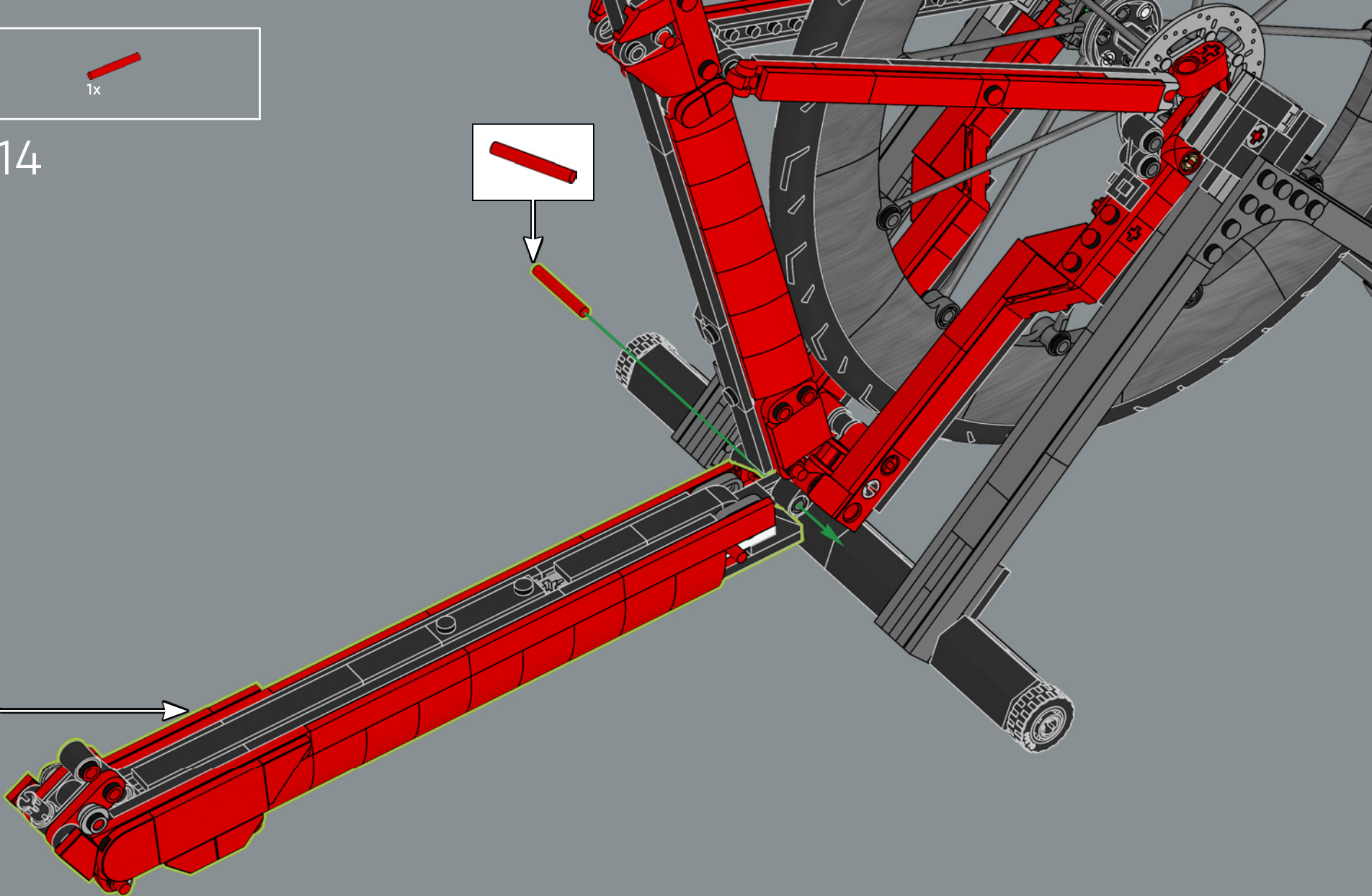
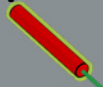
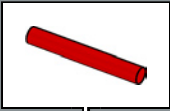



215

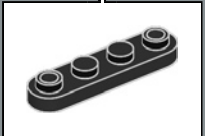
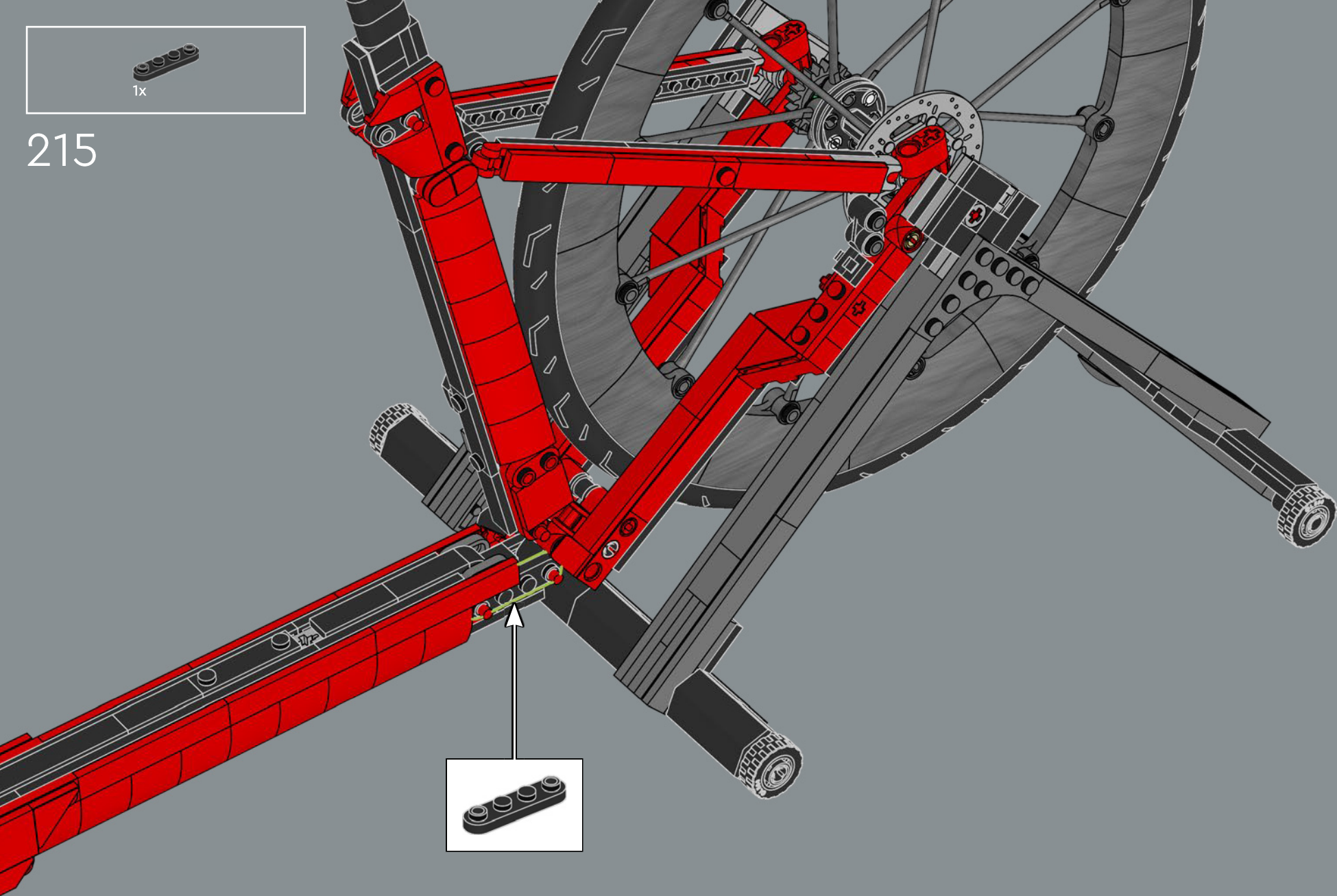

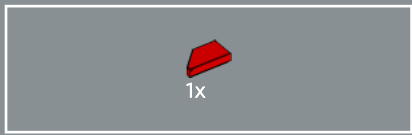

216

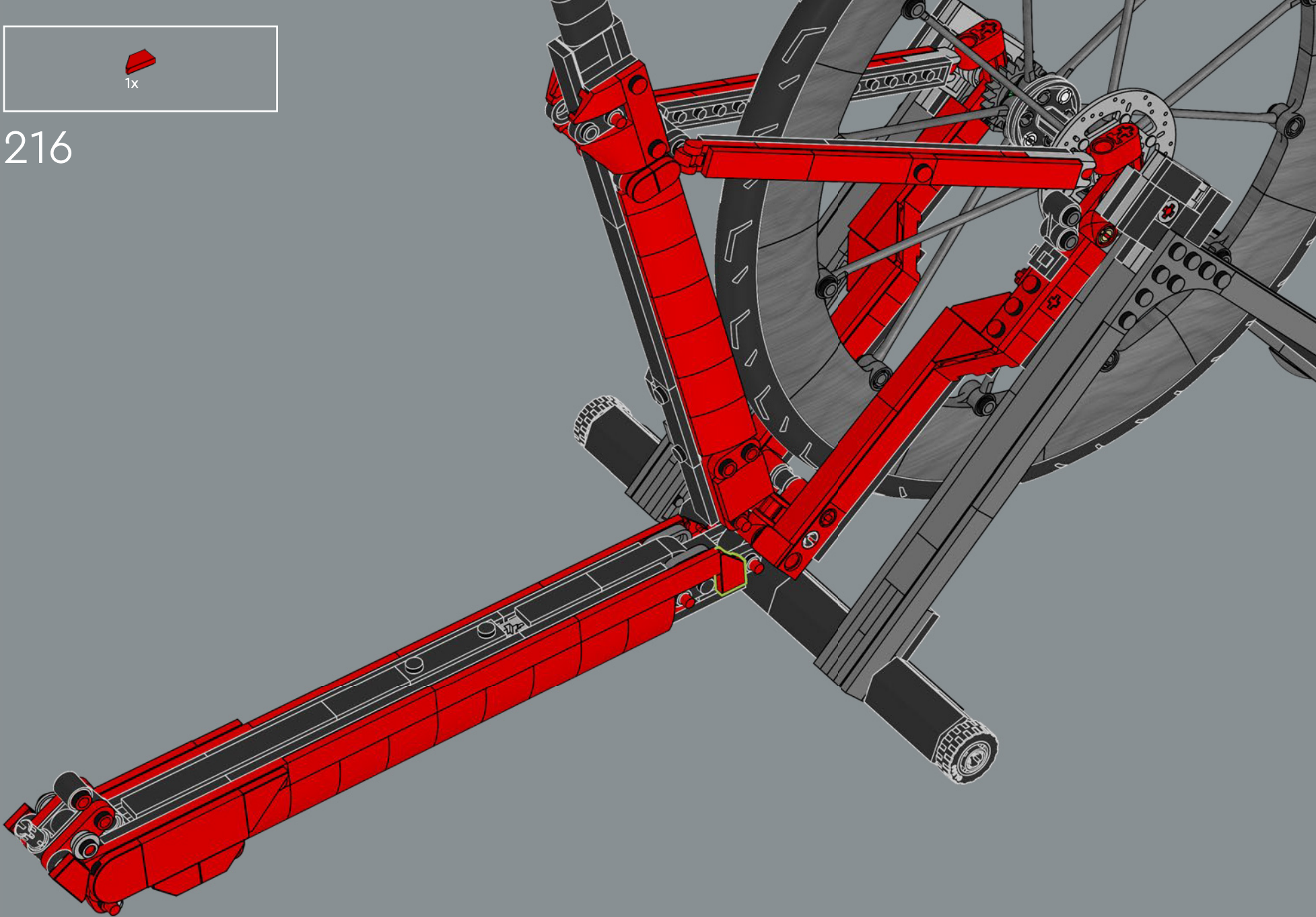

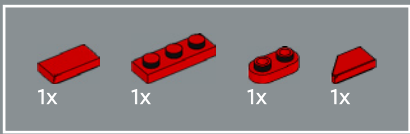

217

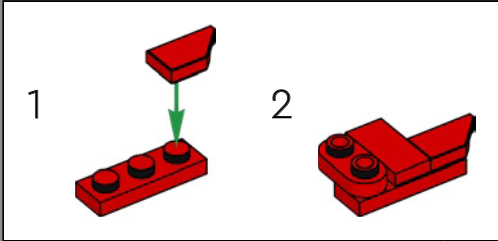



218

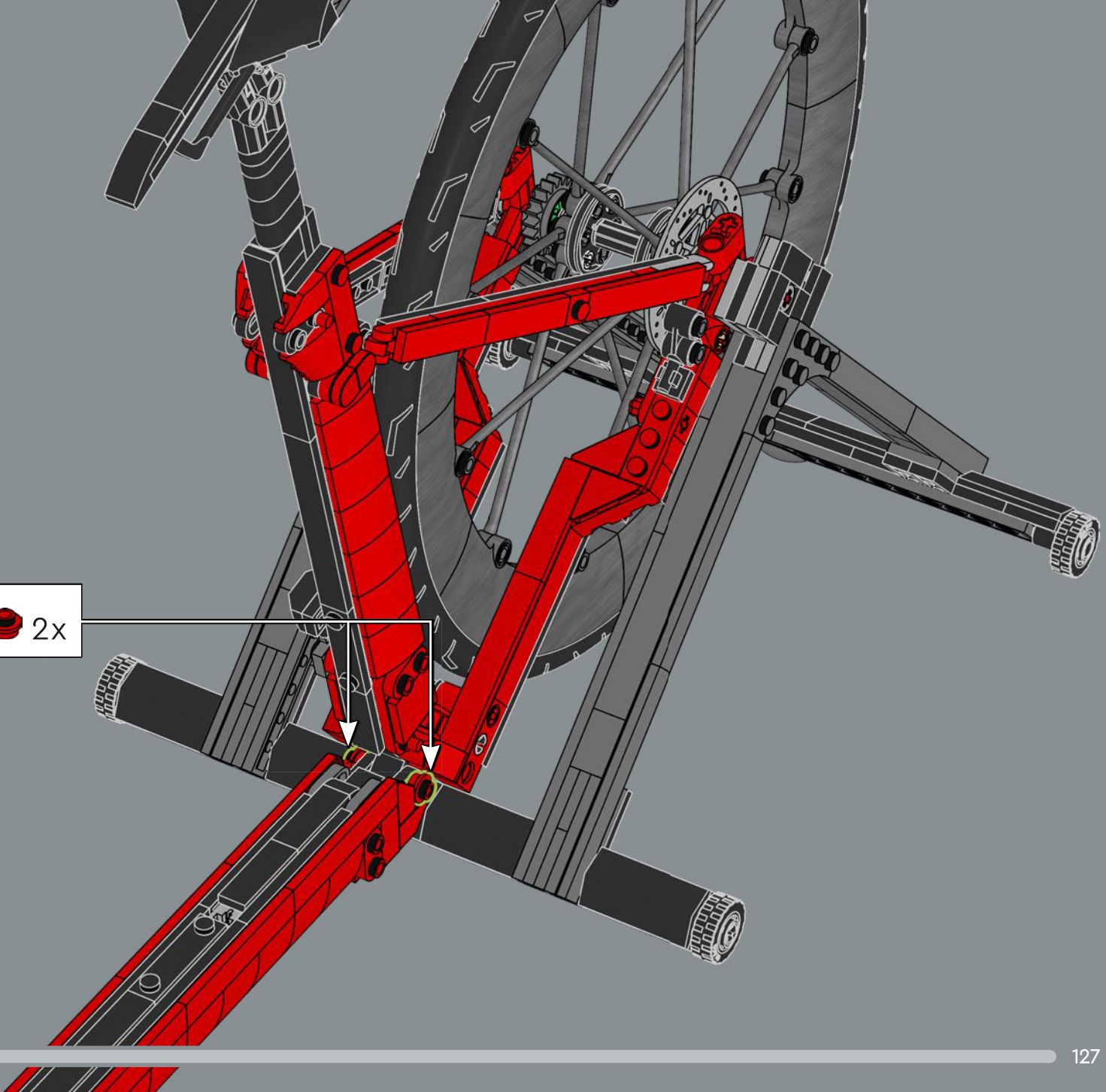

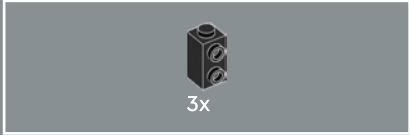
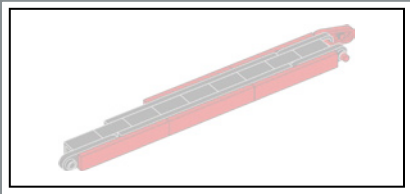

219

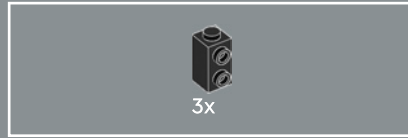

220





221

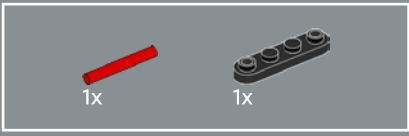

222

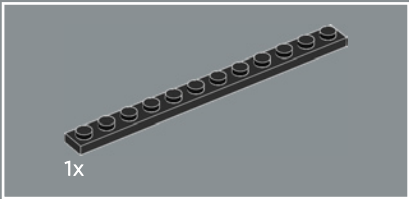
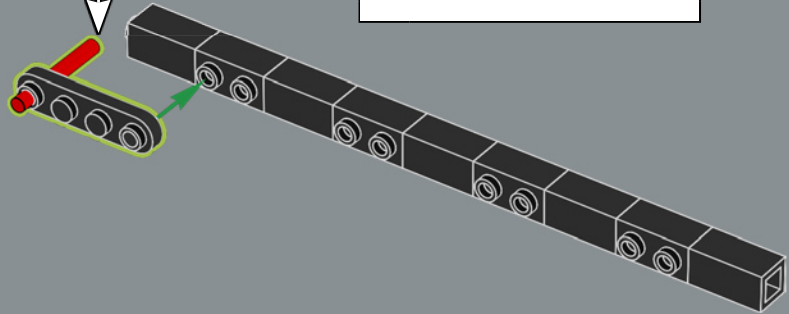
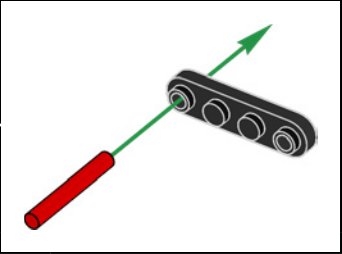

223

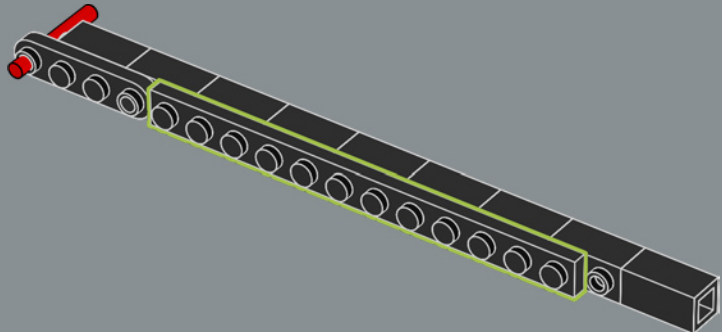

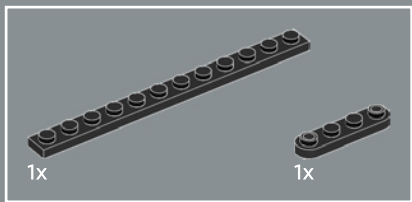

224

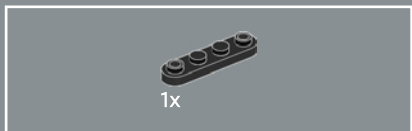
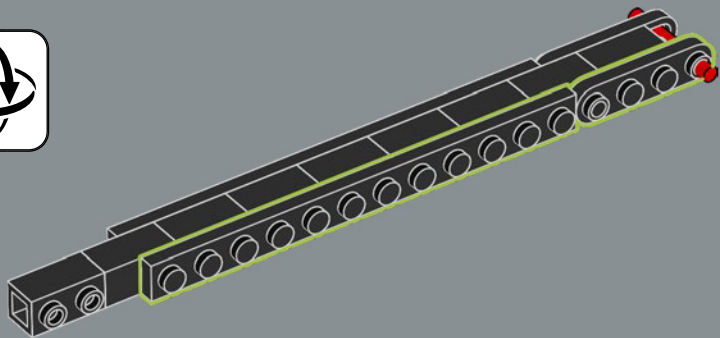

225

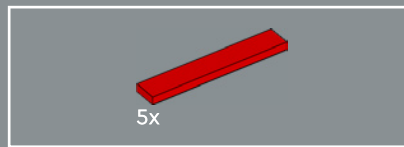
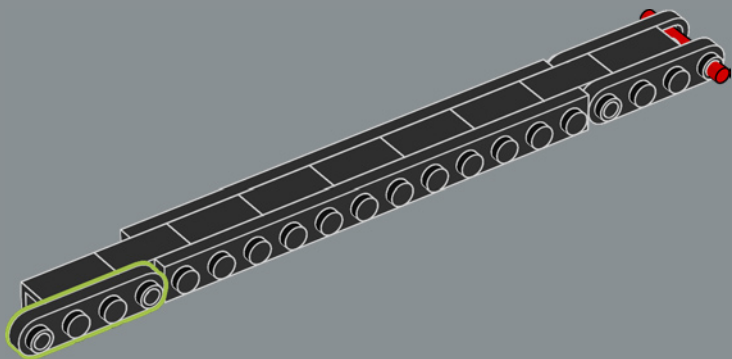

226

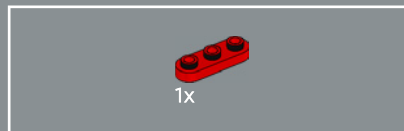
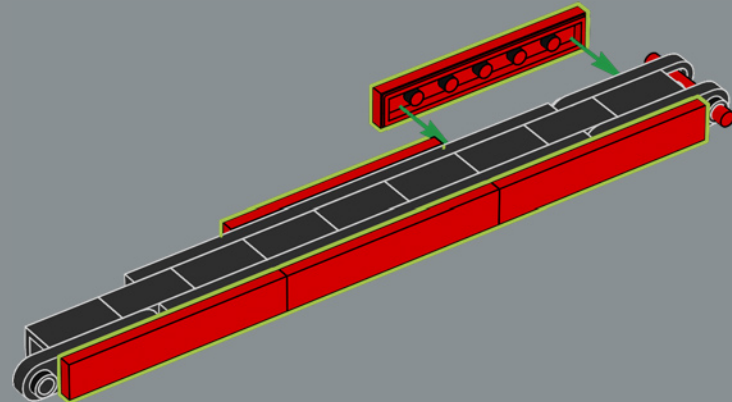

227

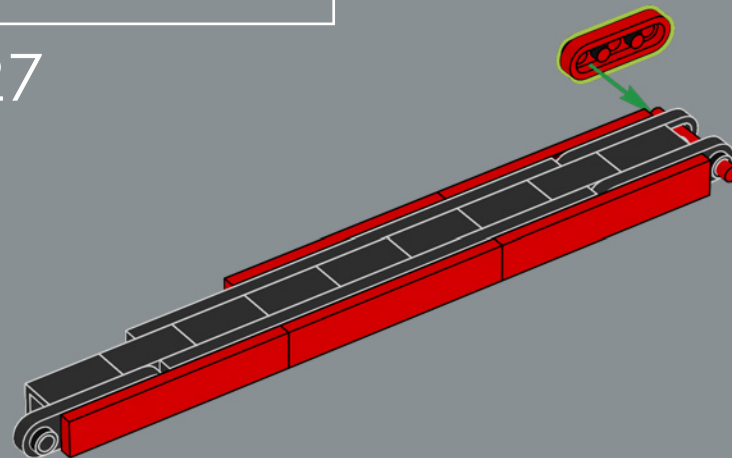

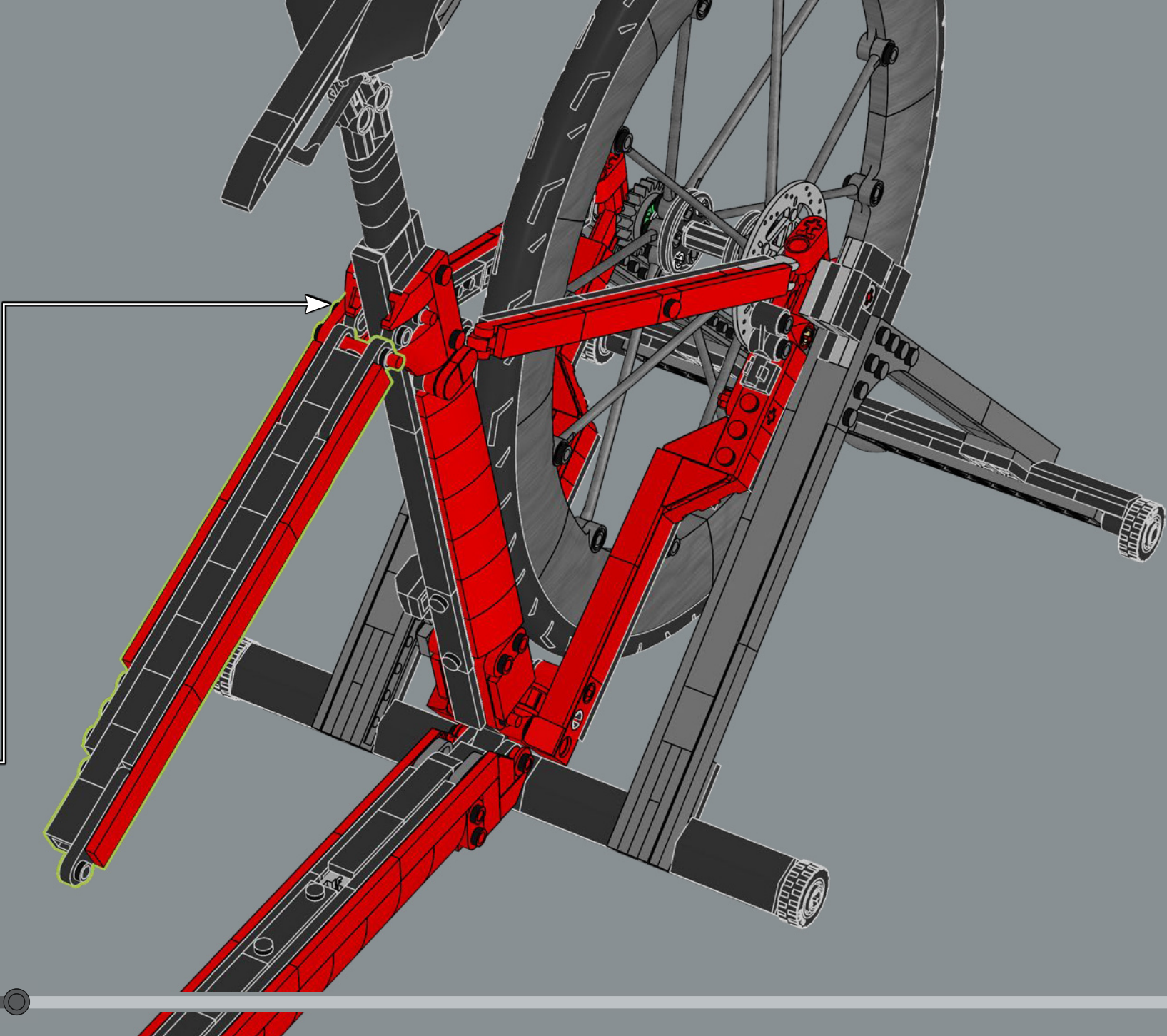

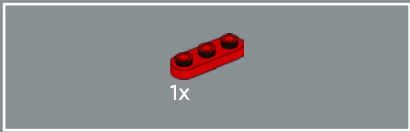

229

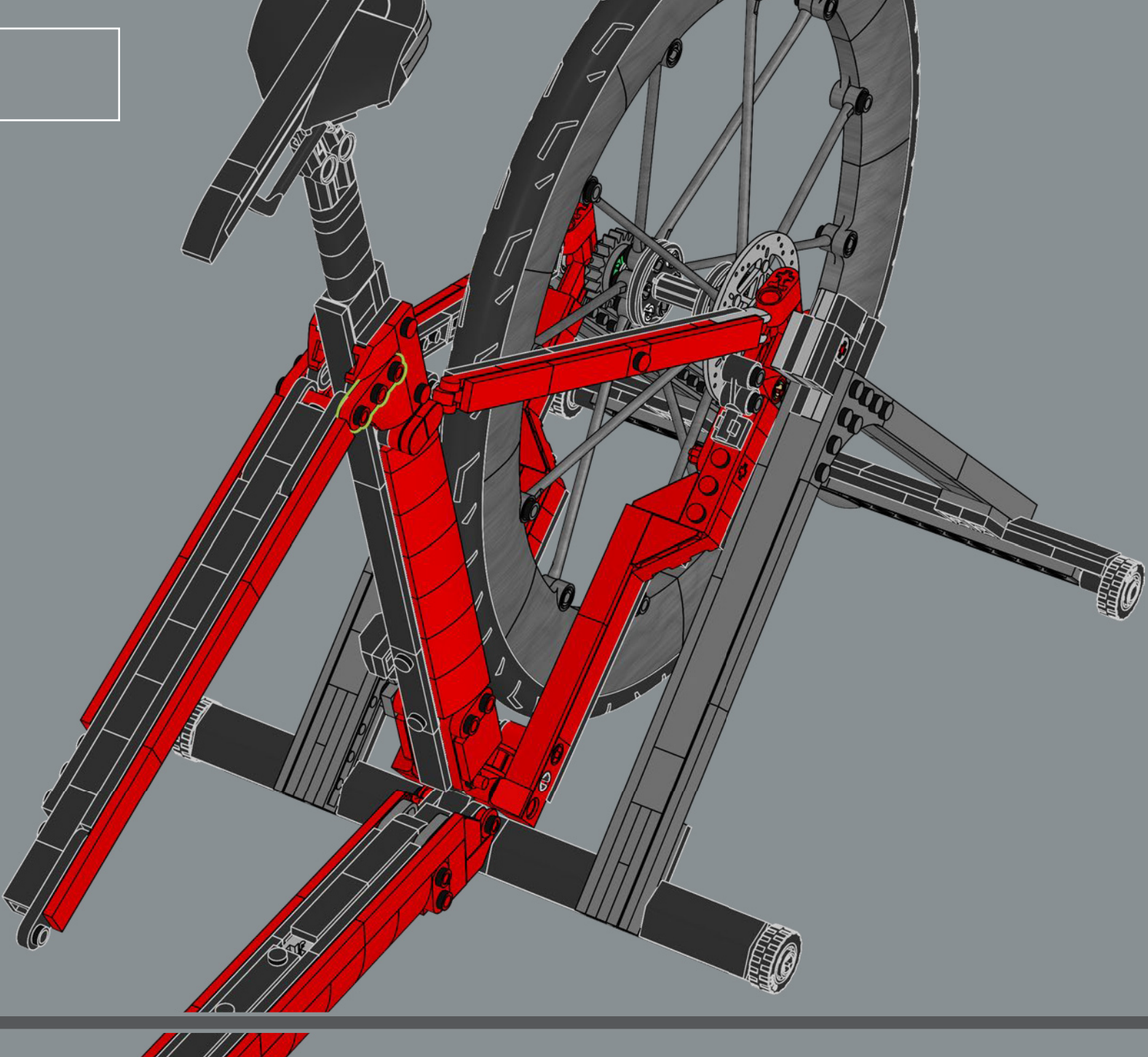

230

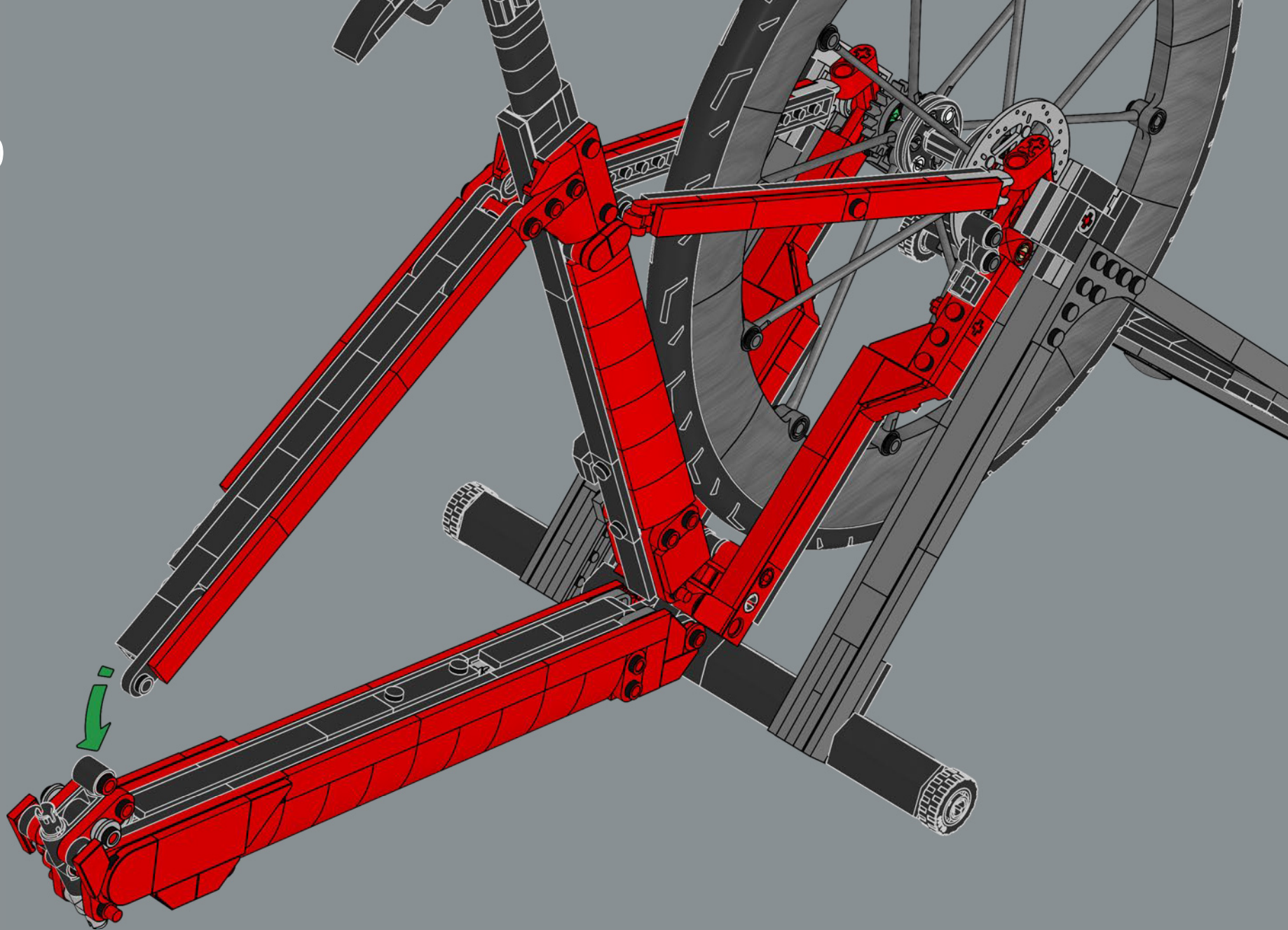

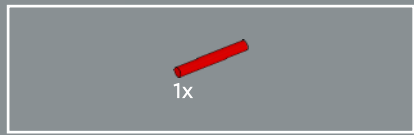

231

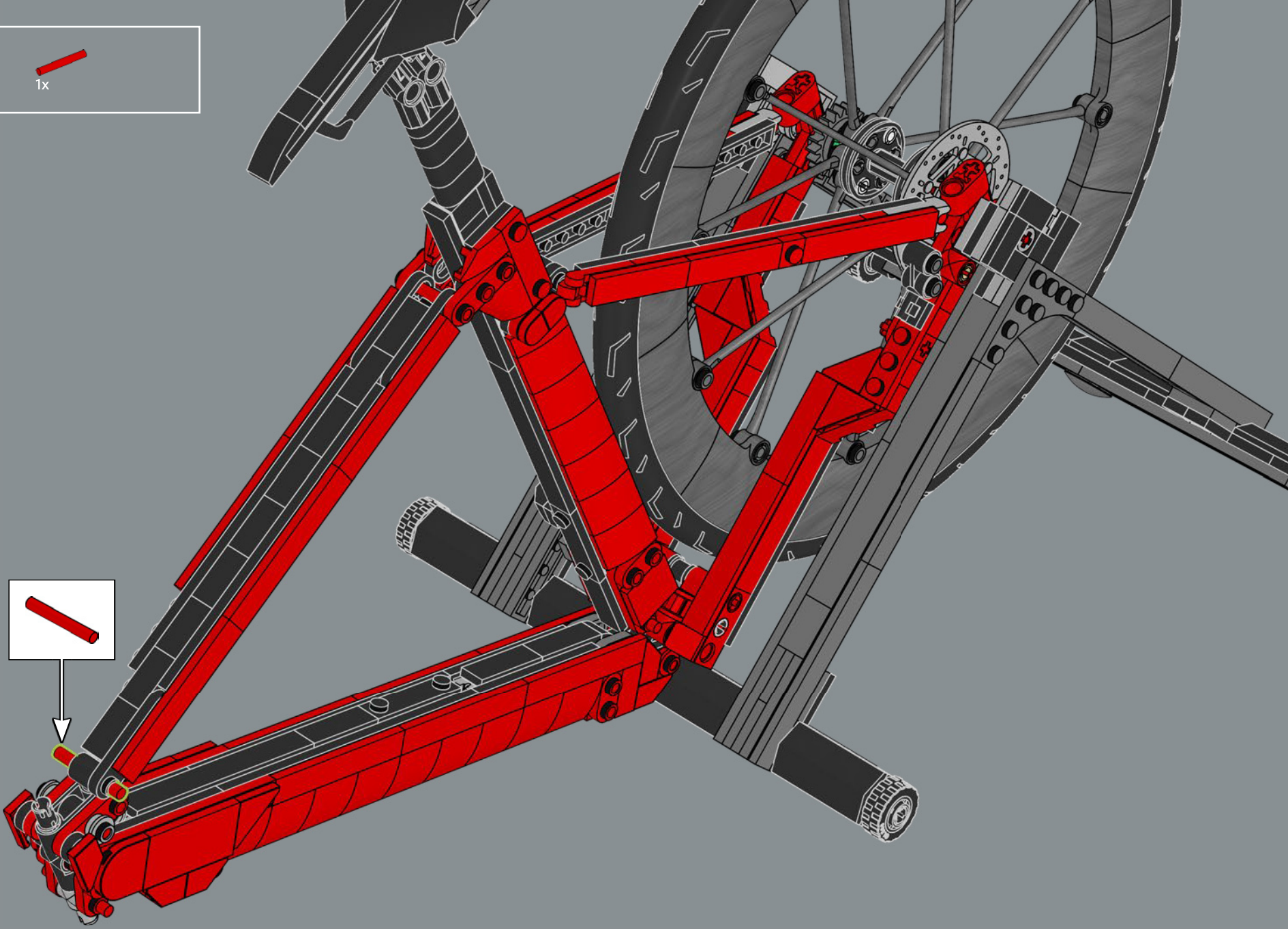

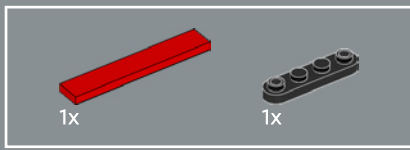

232

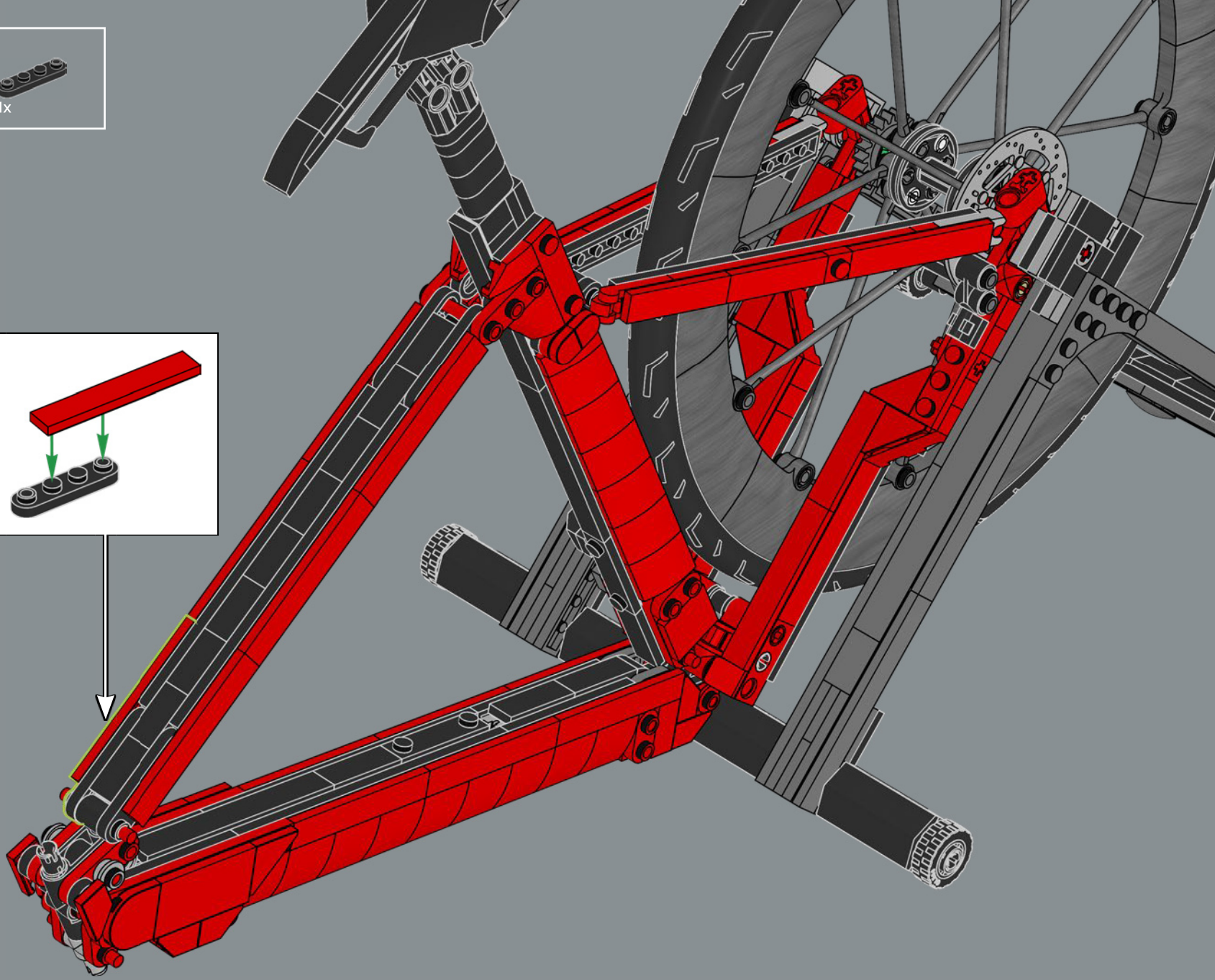
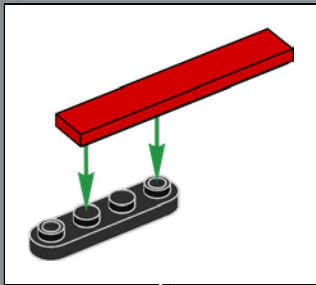

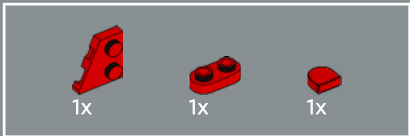

233

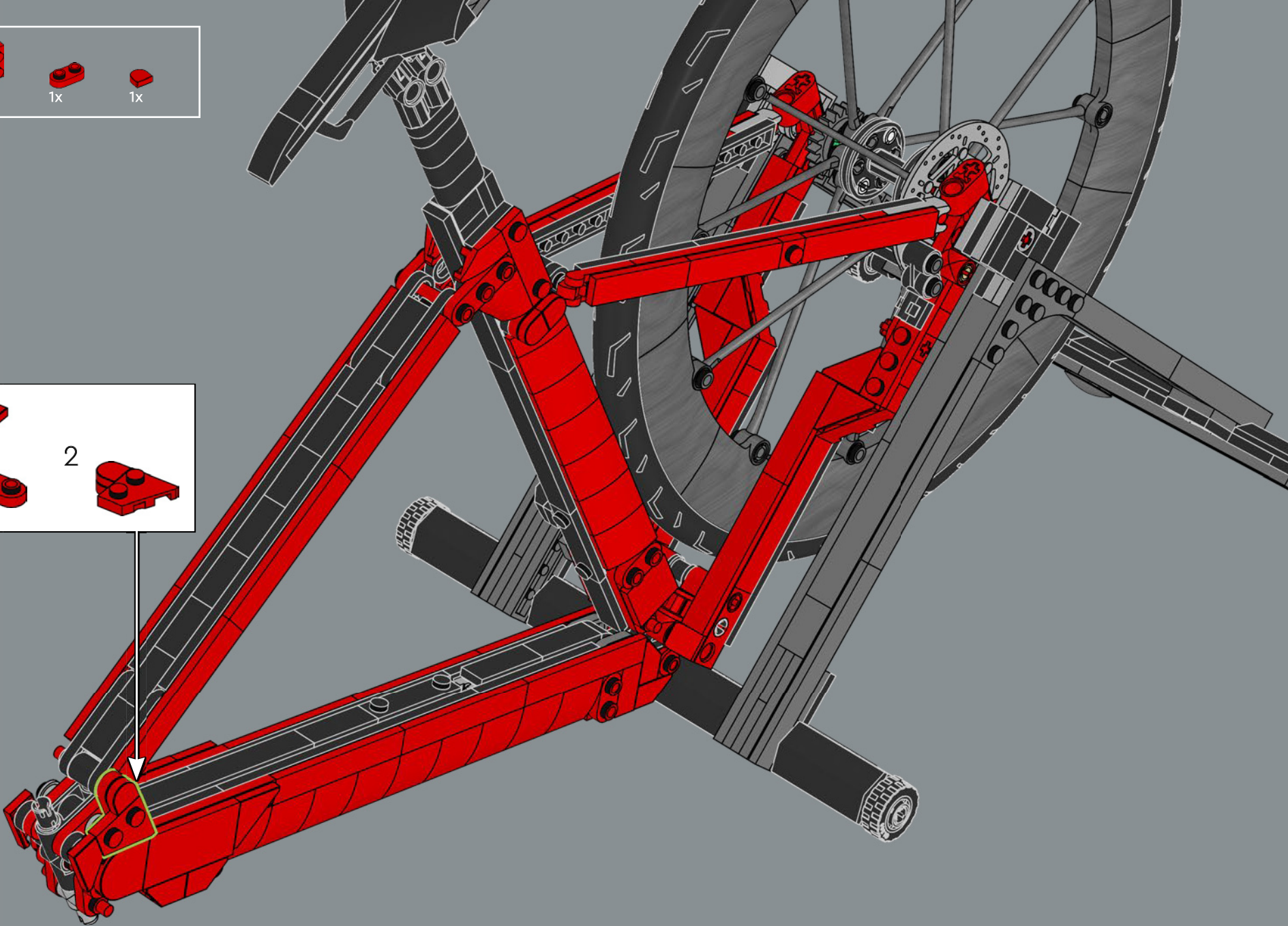
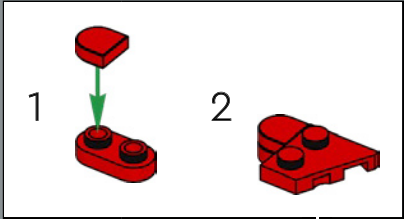



234

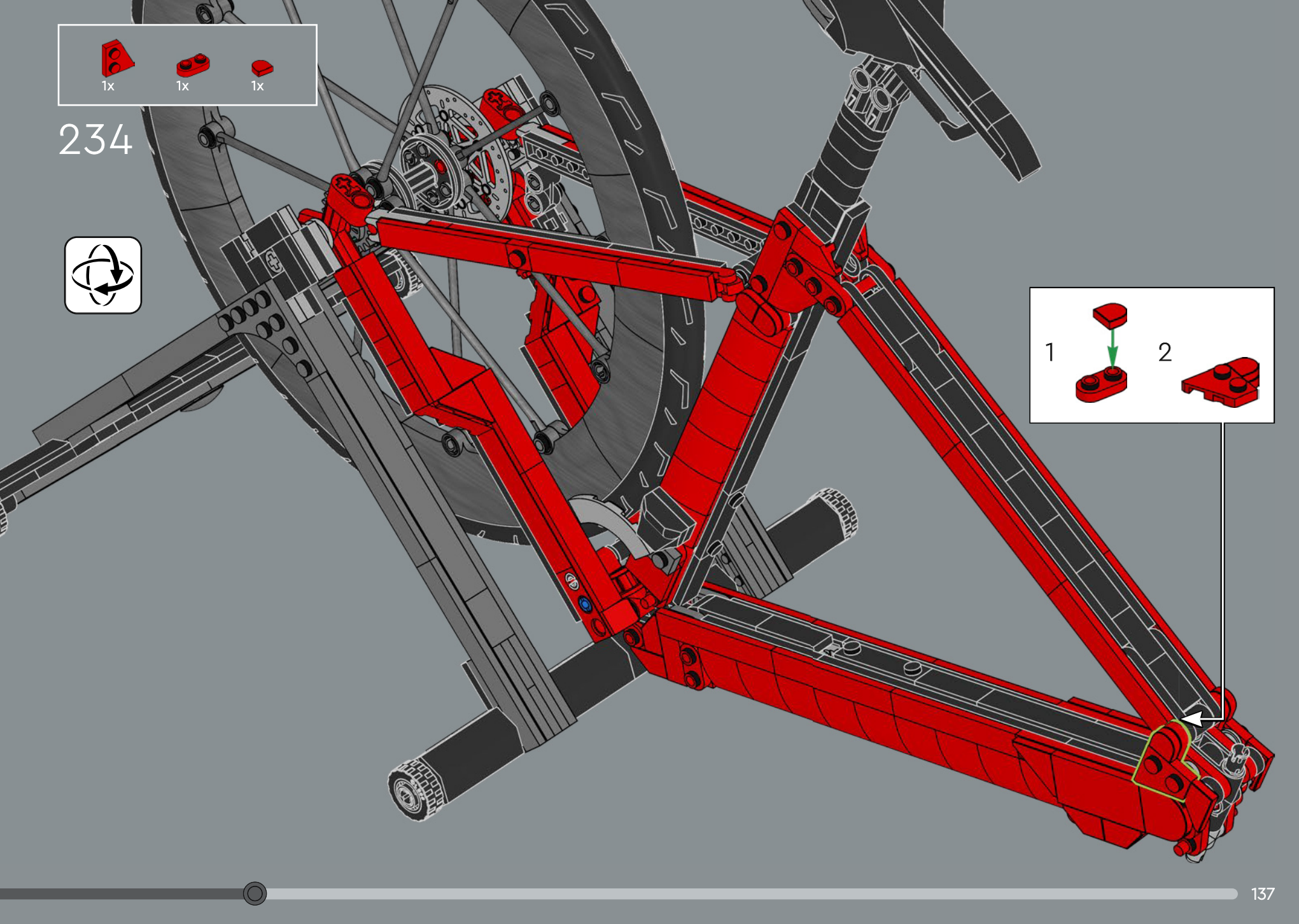
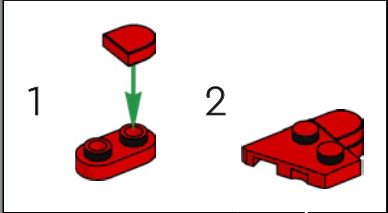

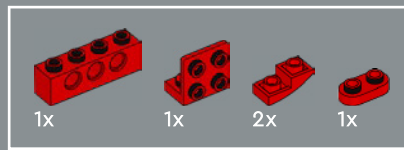

235



1

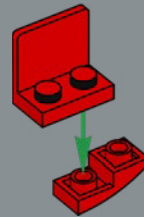

2

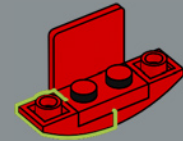

3

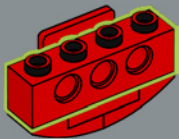

4

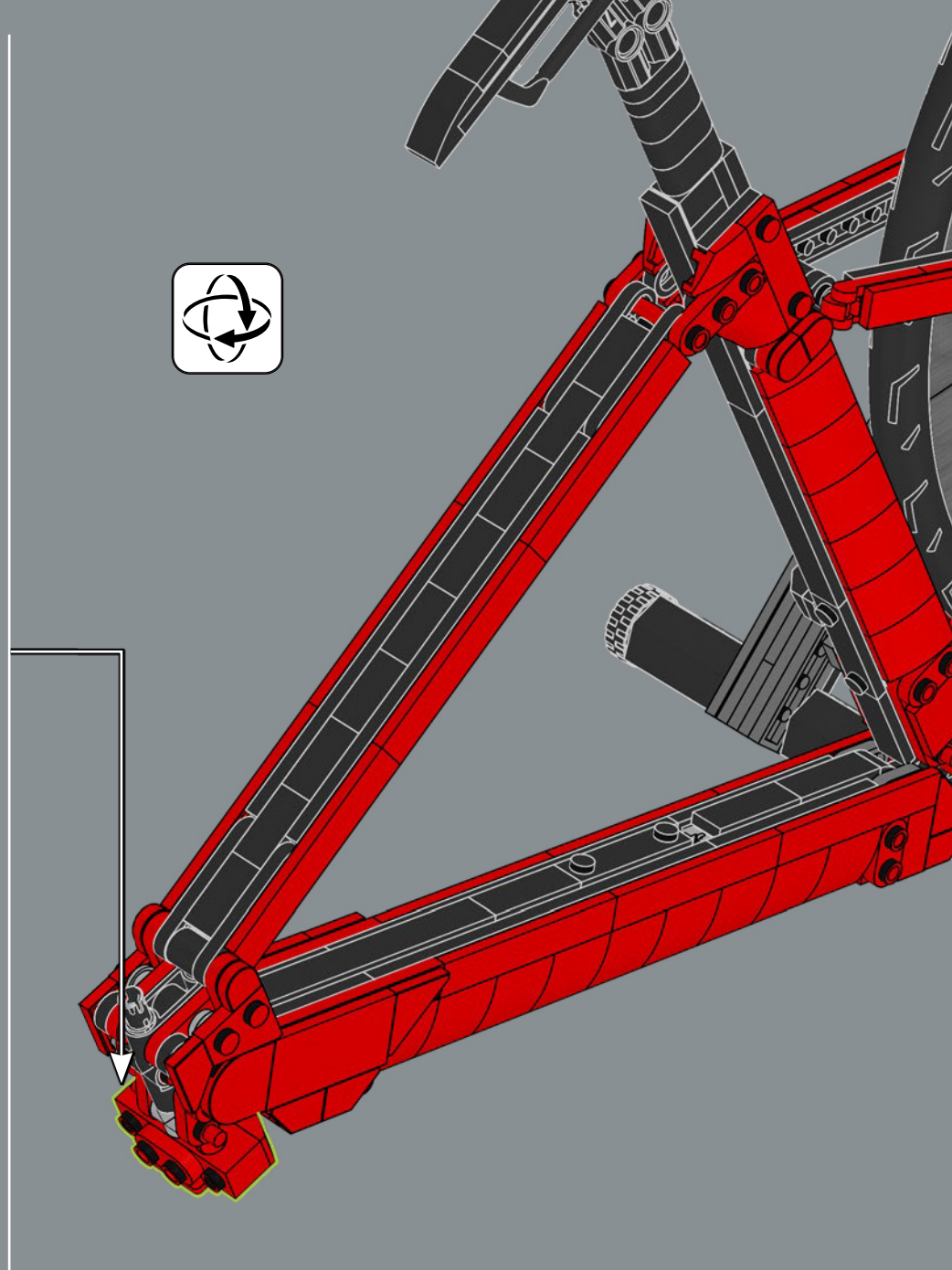
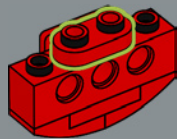

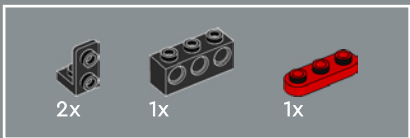

236

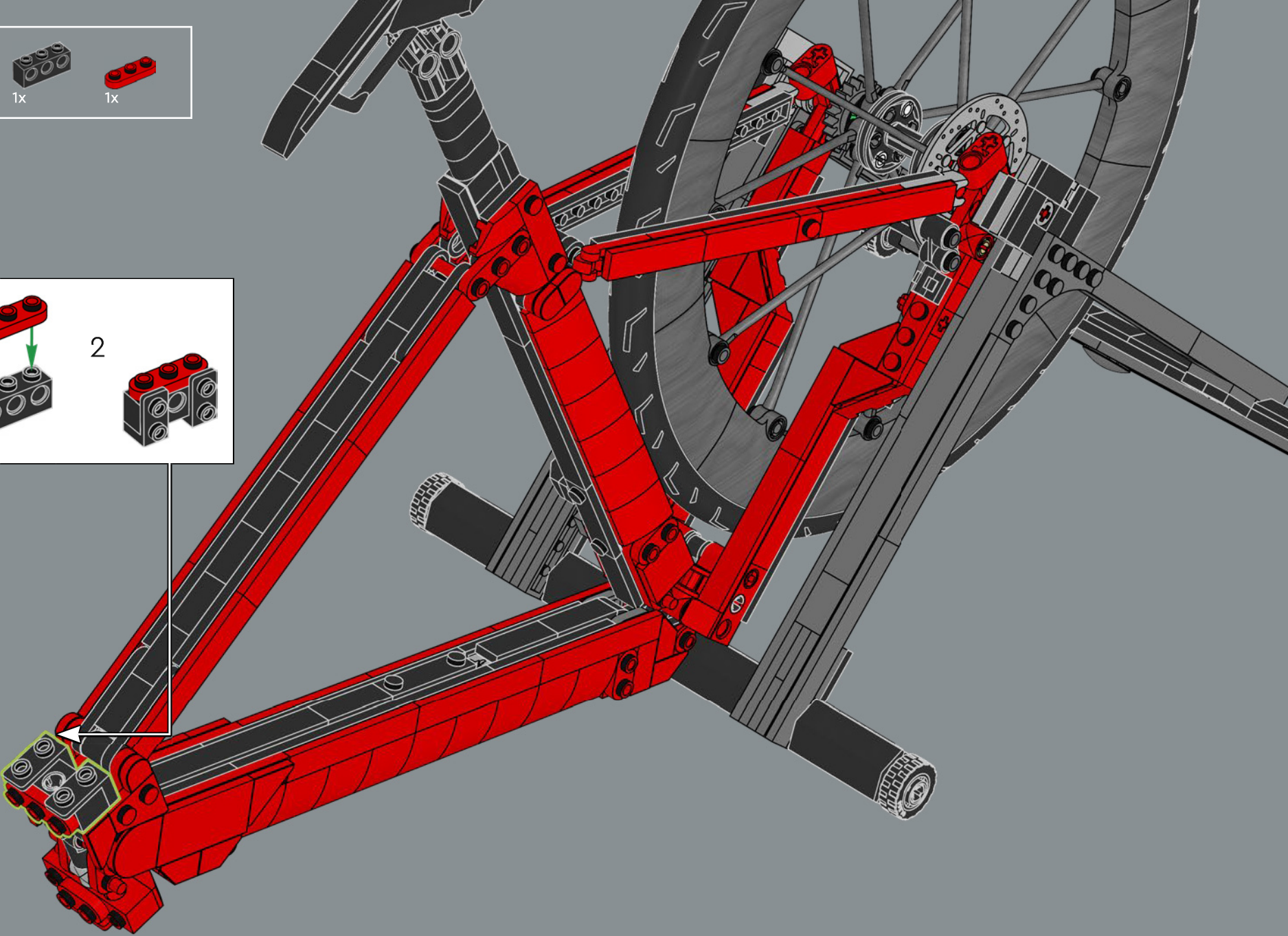
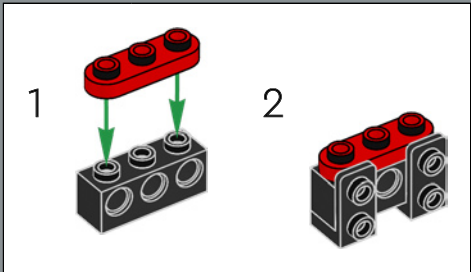

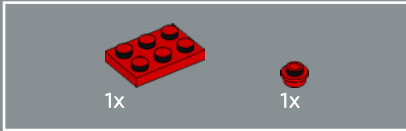
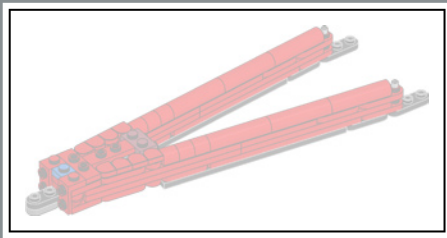

237

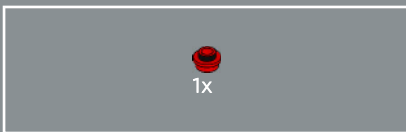
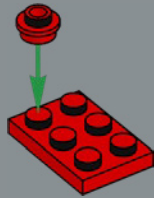

238

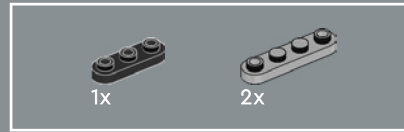
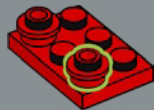

239

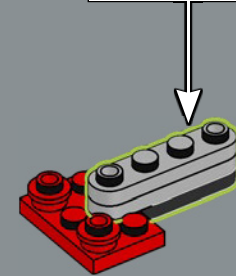
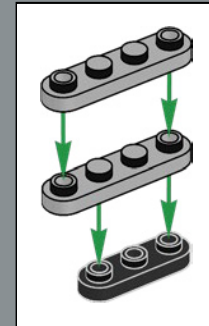

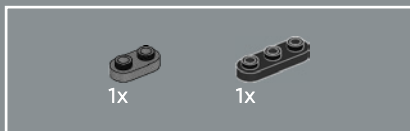

240

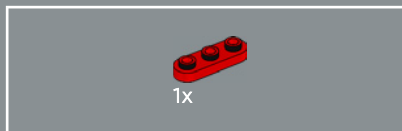
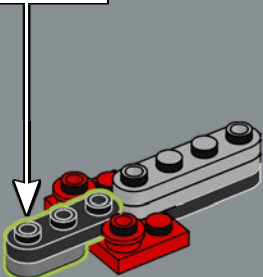
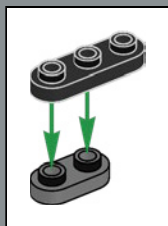

241

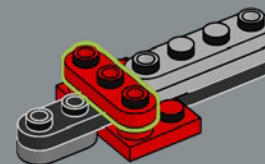

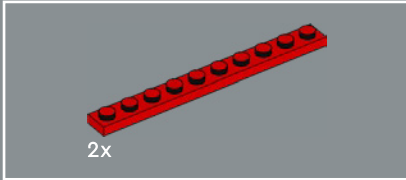
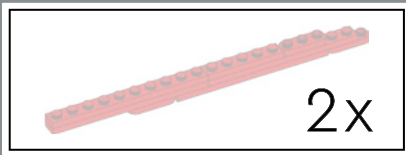

242

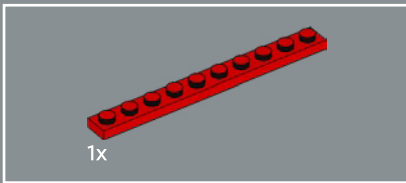
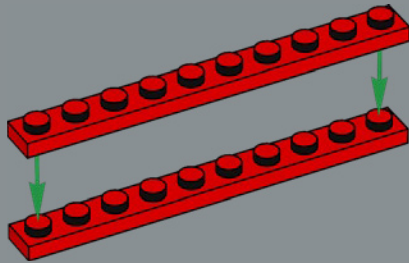

243

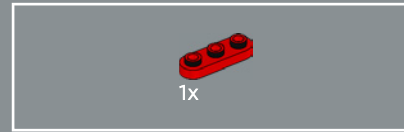
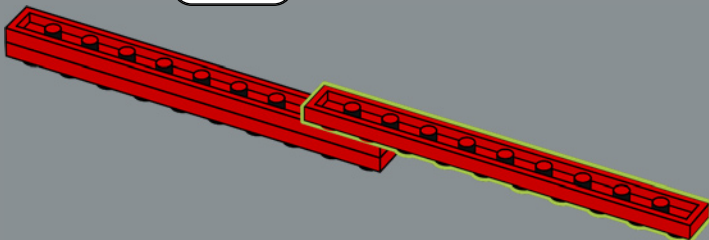

244

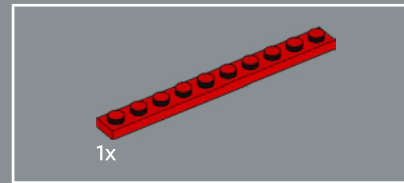
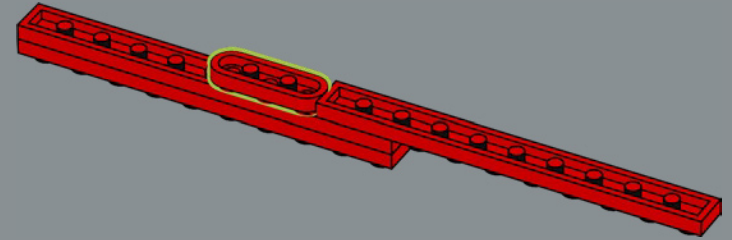

245

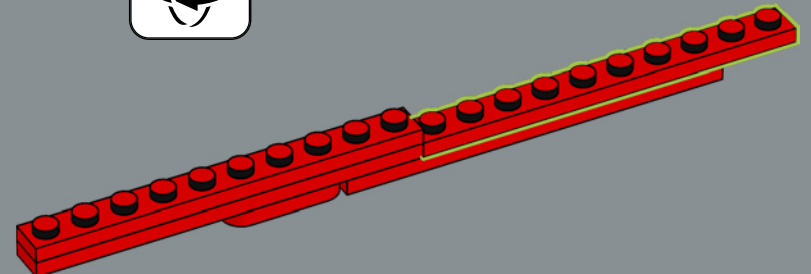

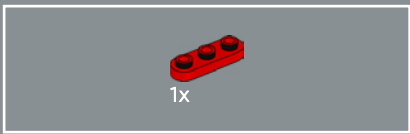

246

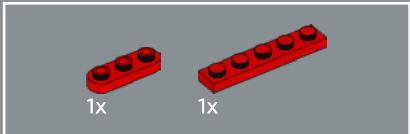
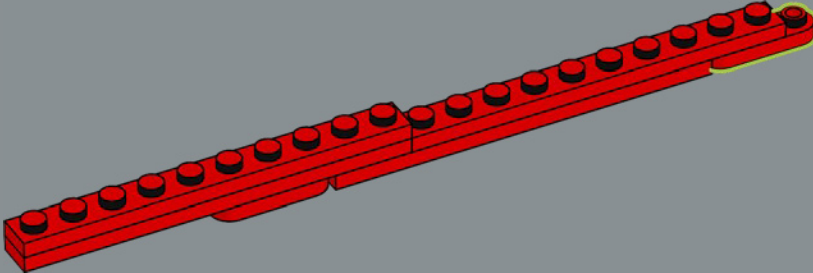

247

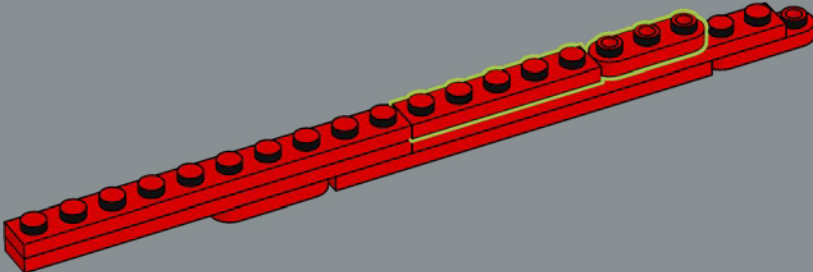

2x

248

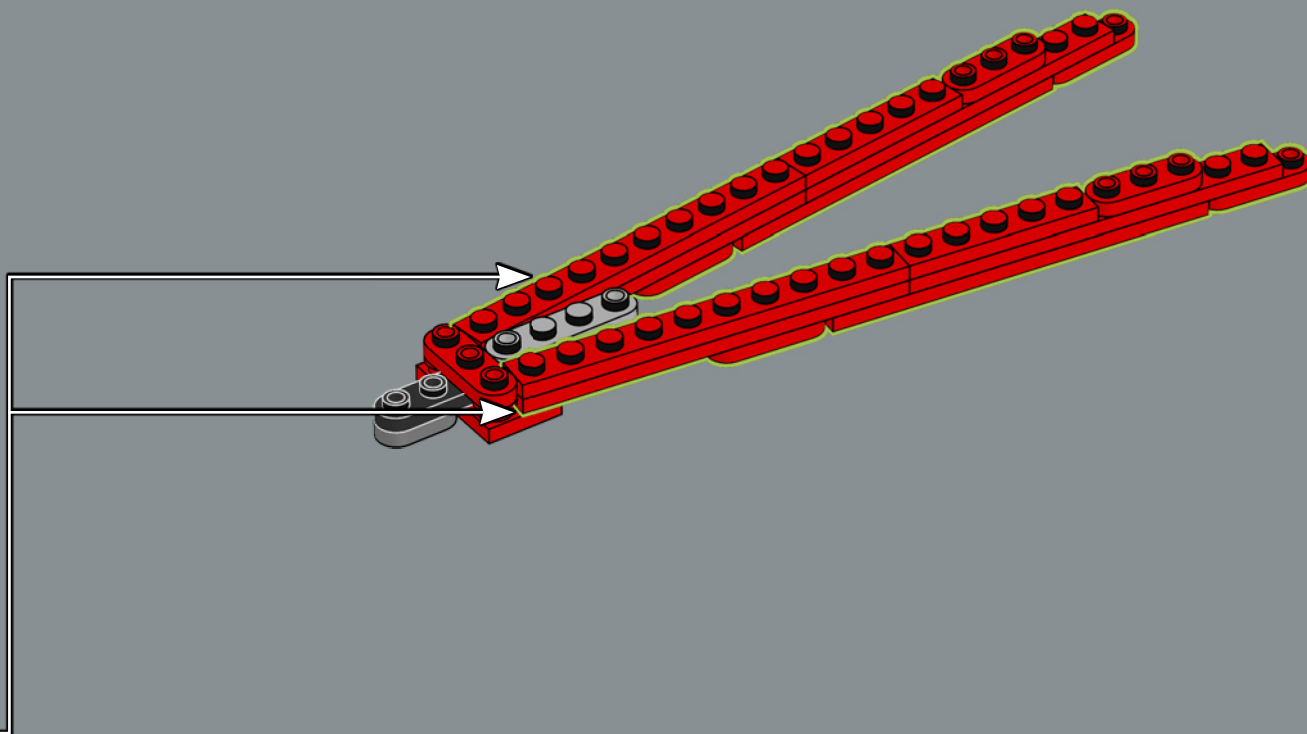

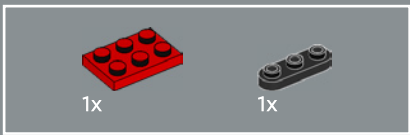

249

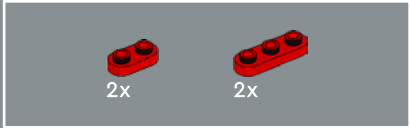
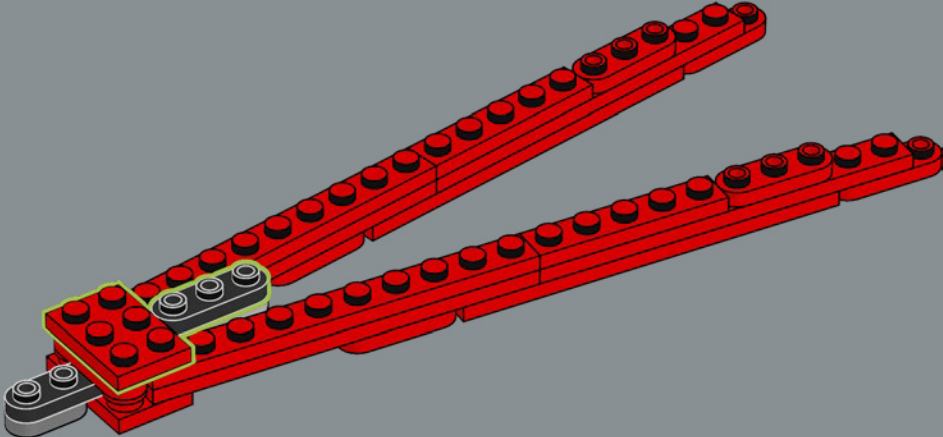

250

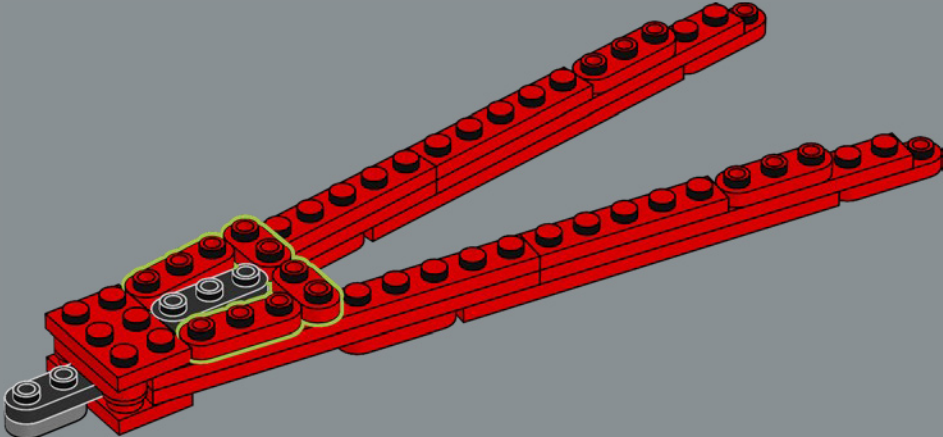

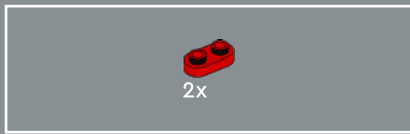

251

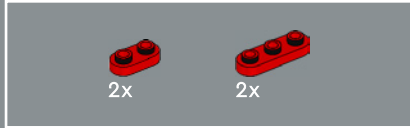
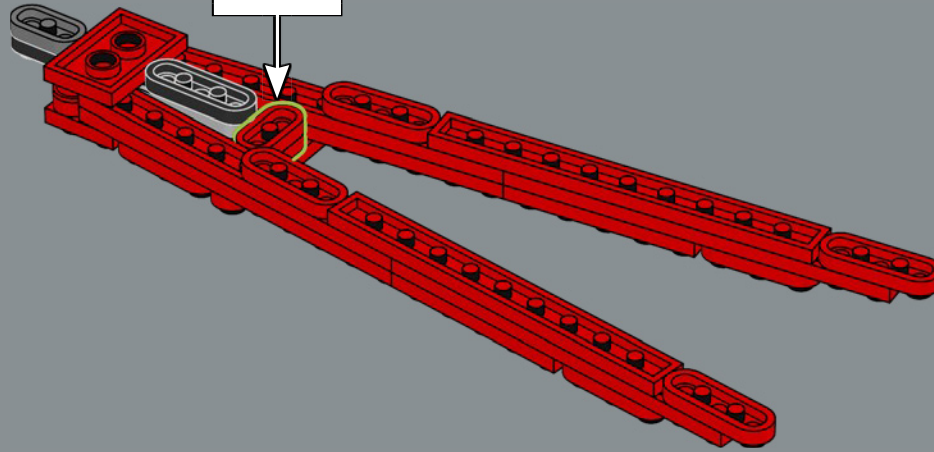
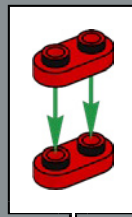

252

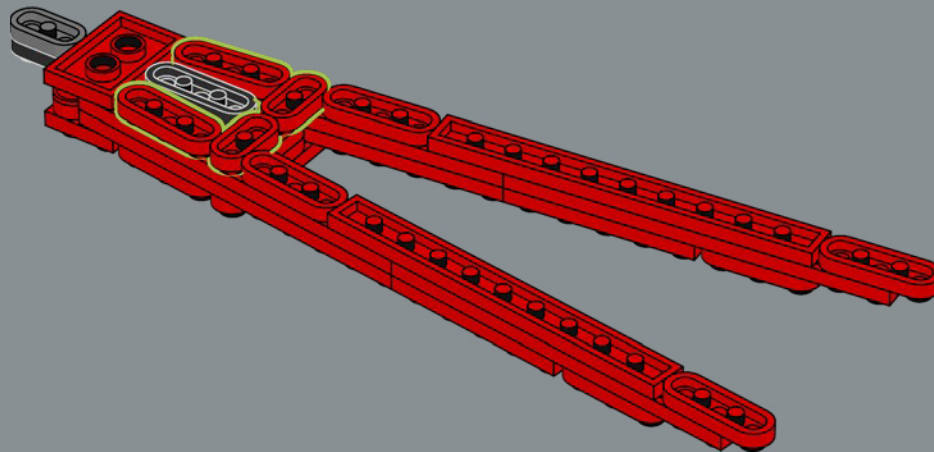

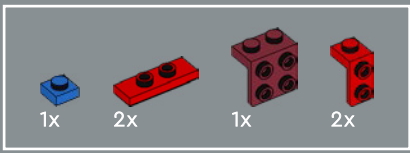

253

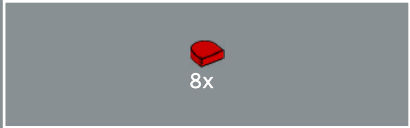
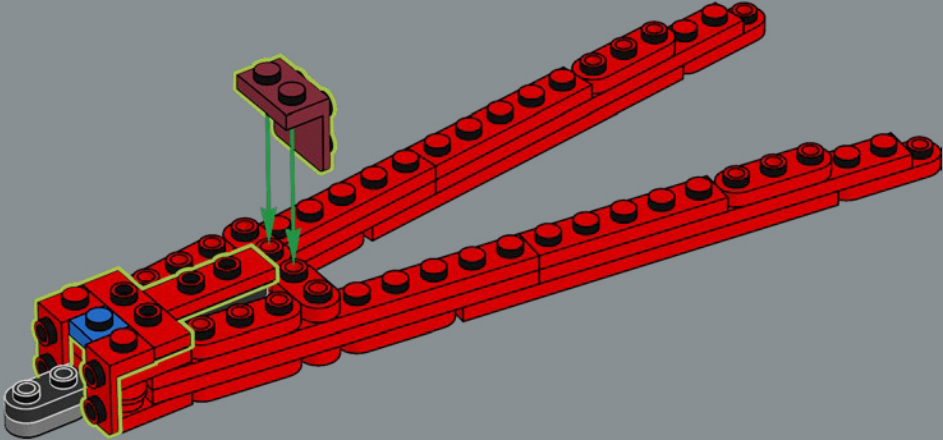

254

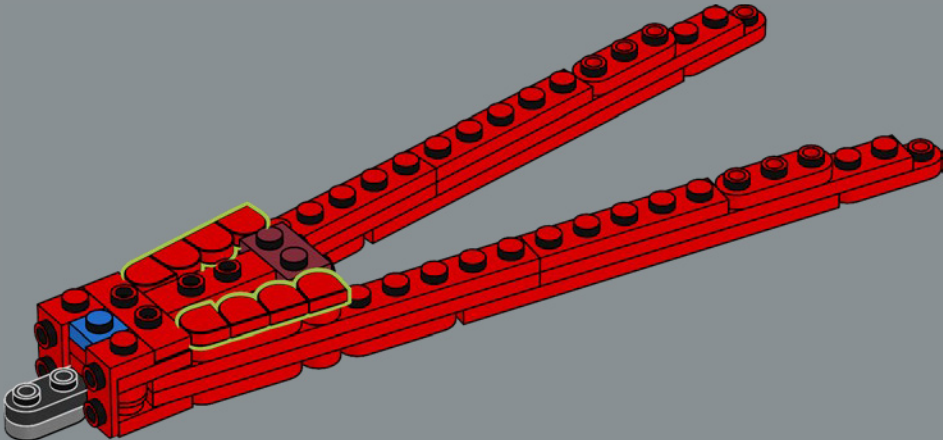

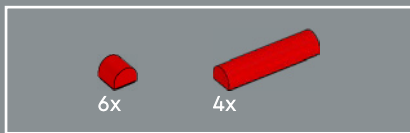

255

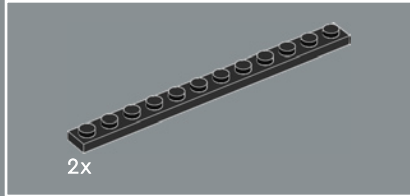
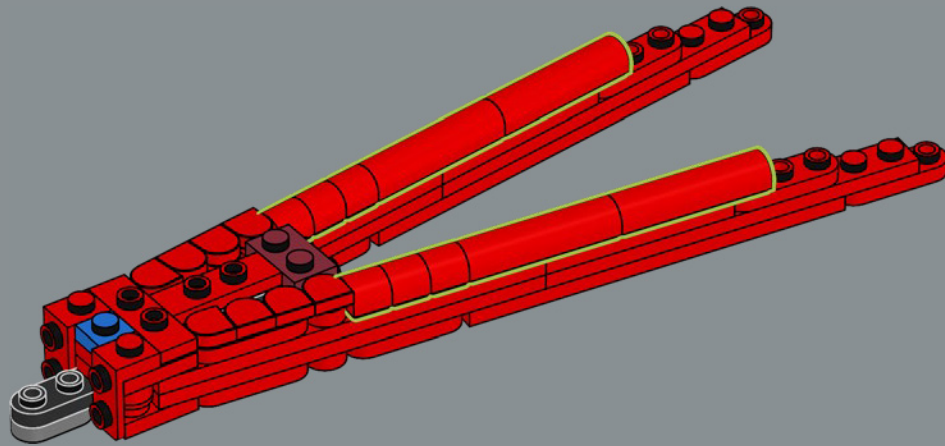

256

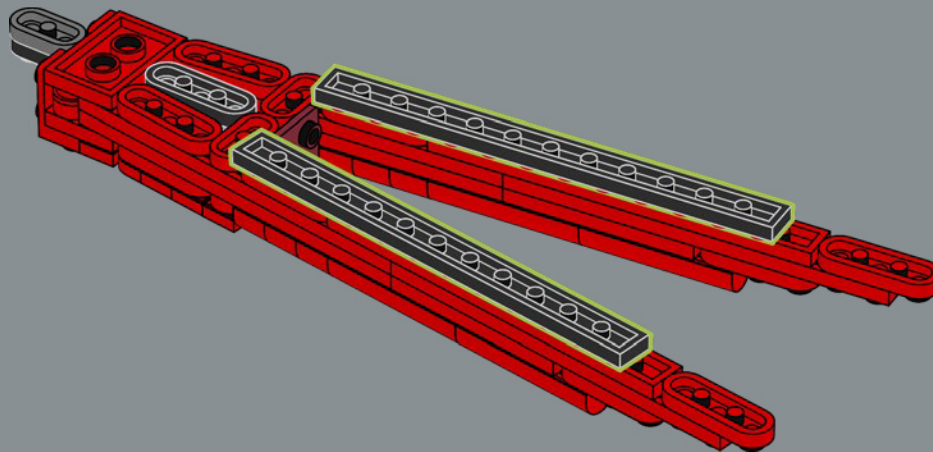



257

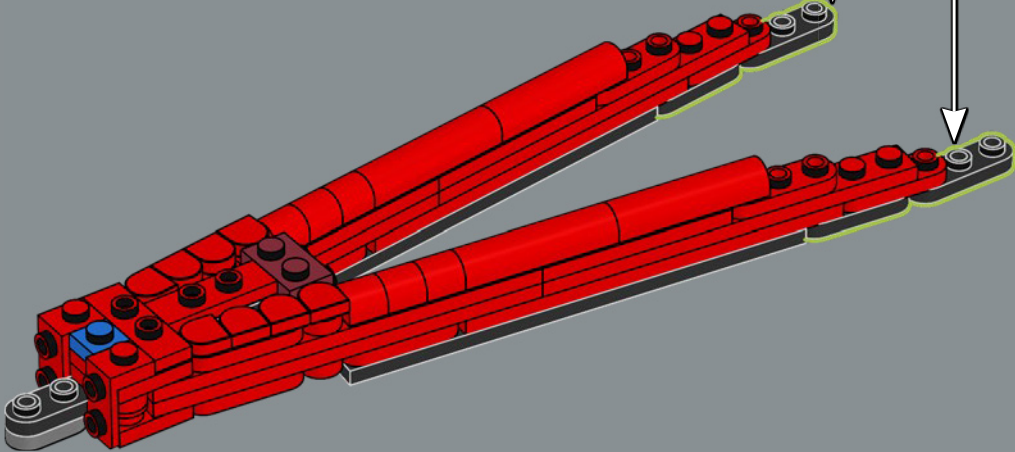
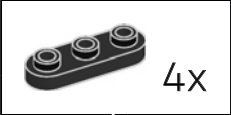

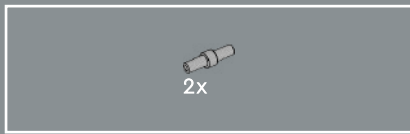

258

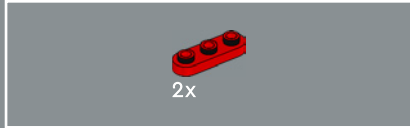
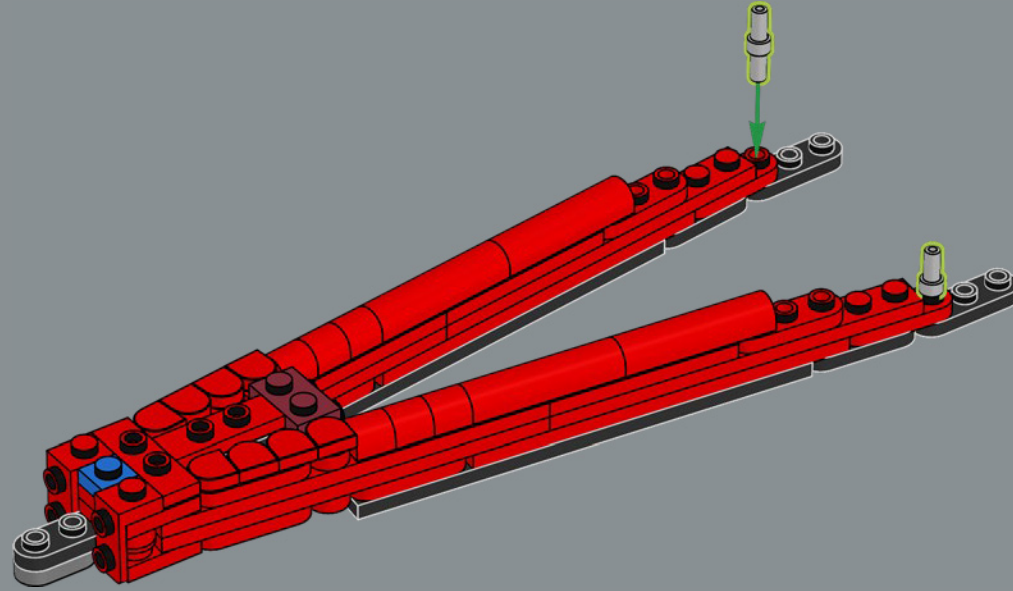

259

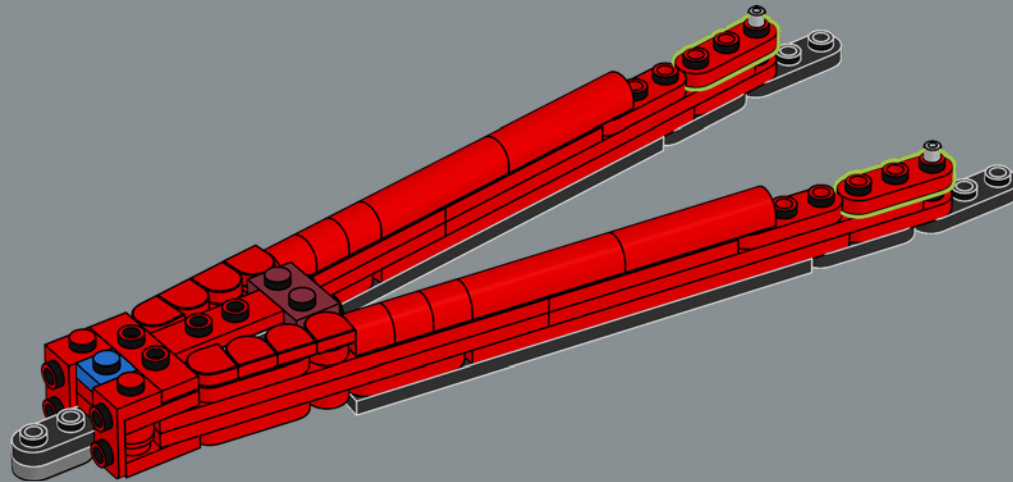



260

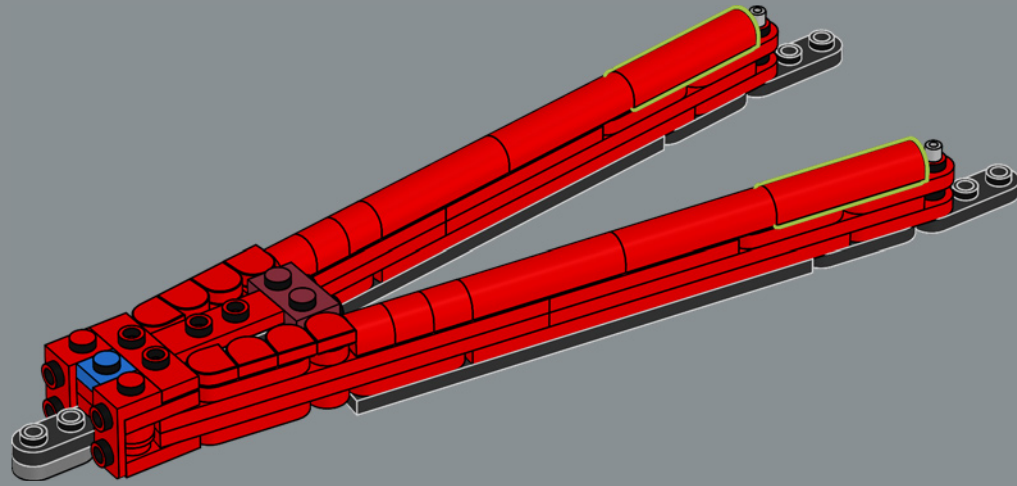

261

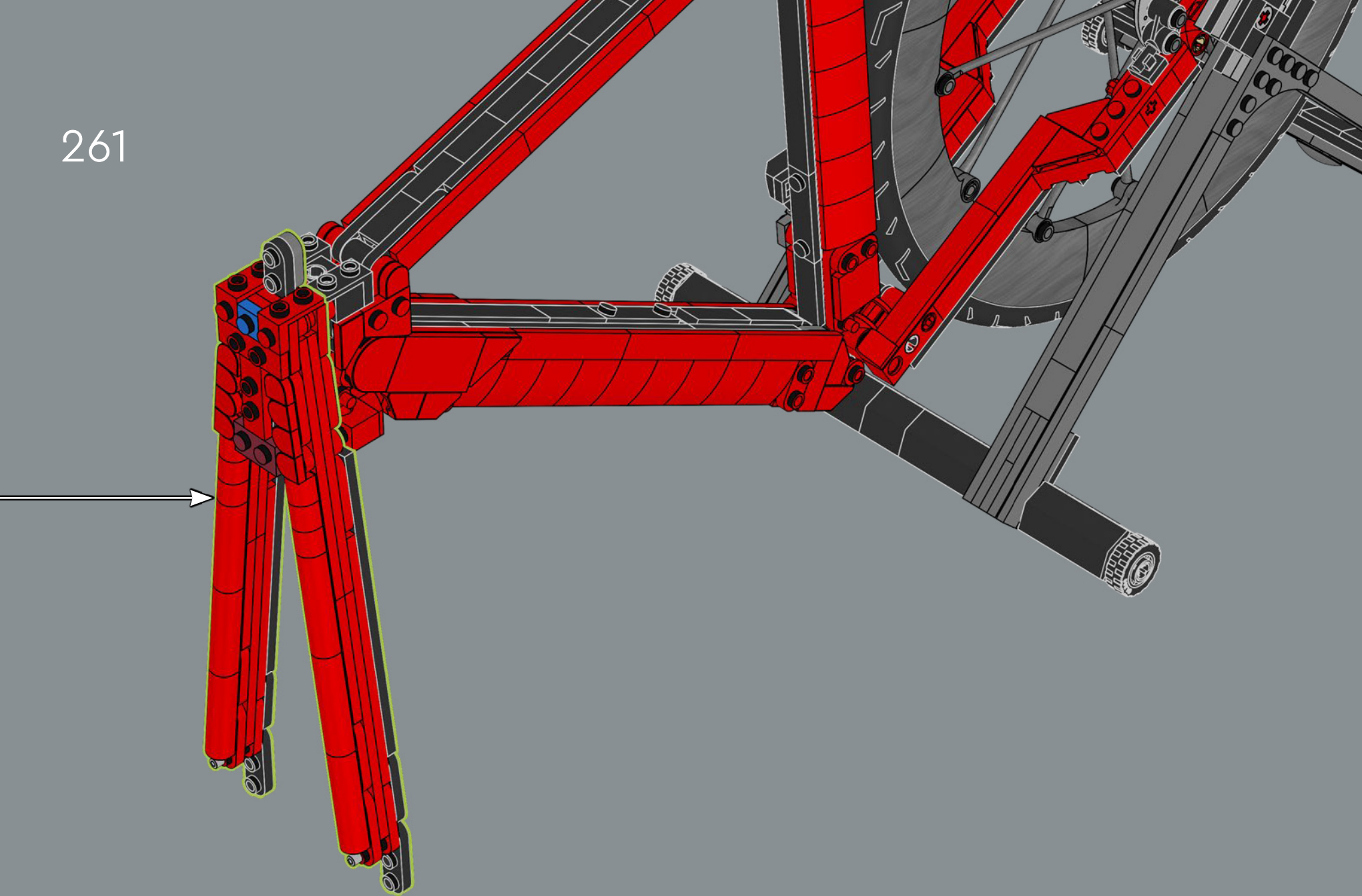

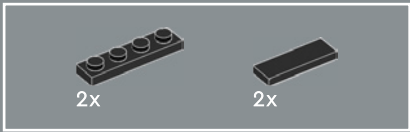

262

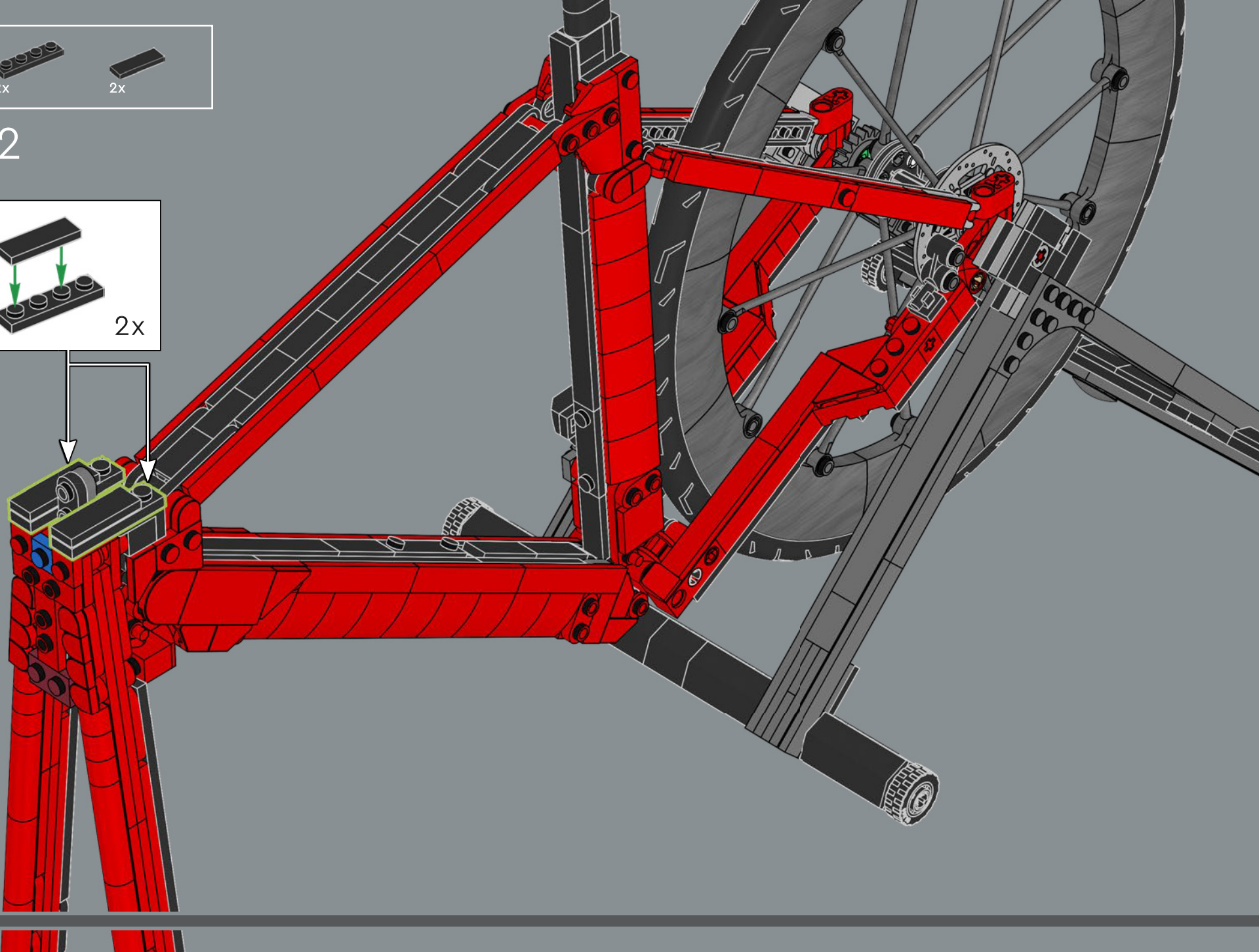
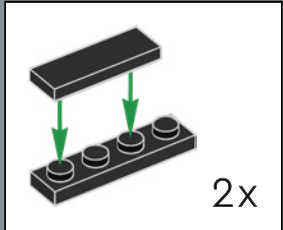

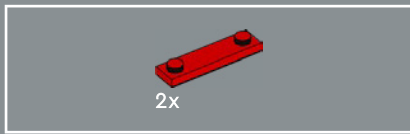

263

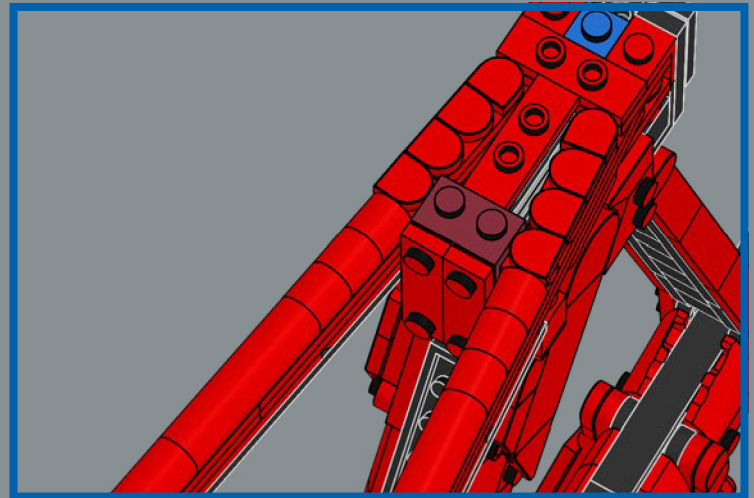
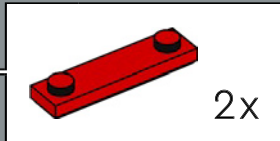
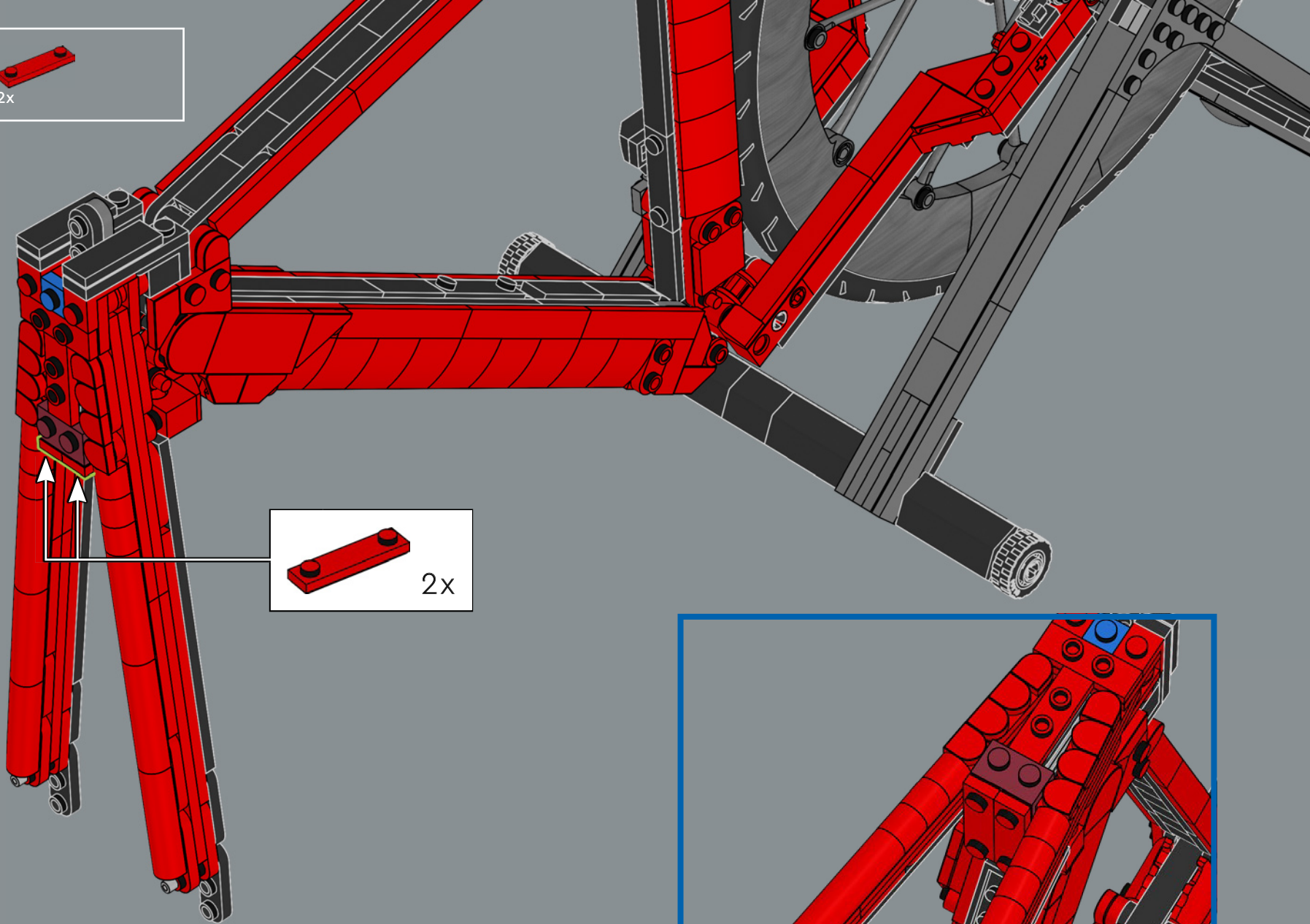

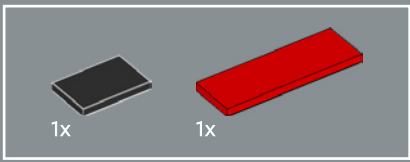

264

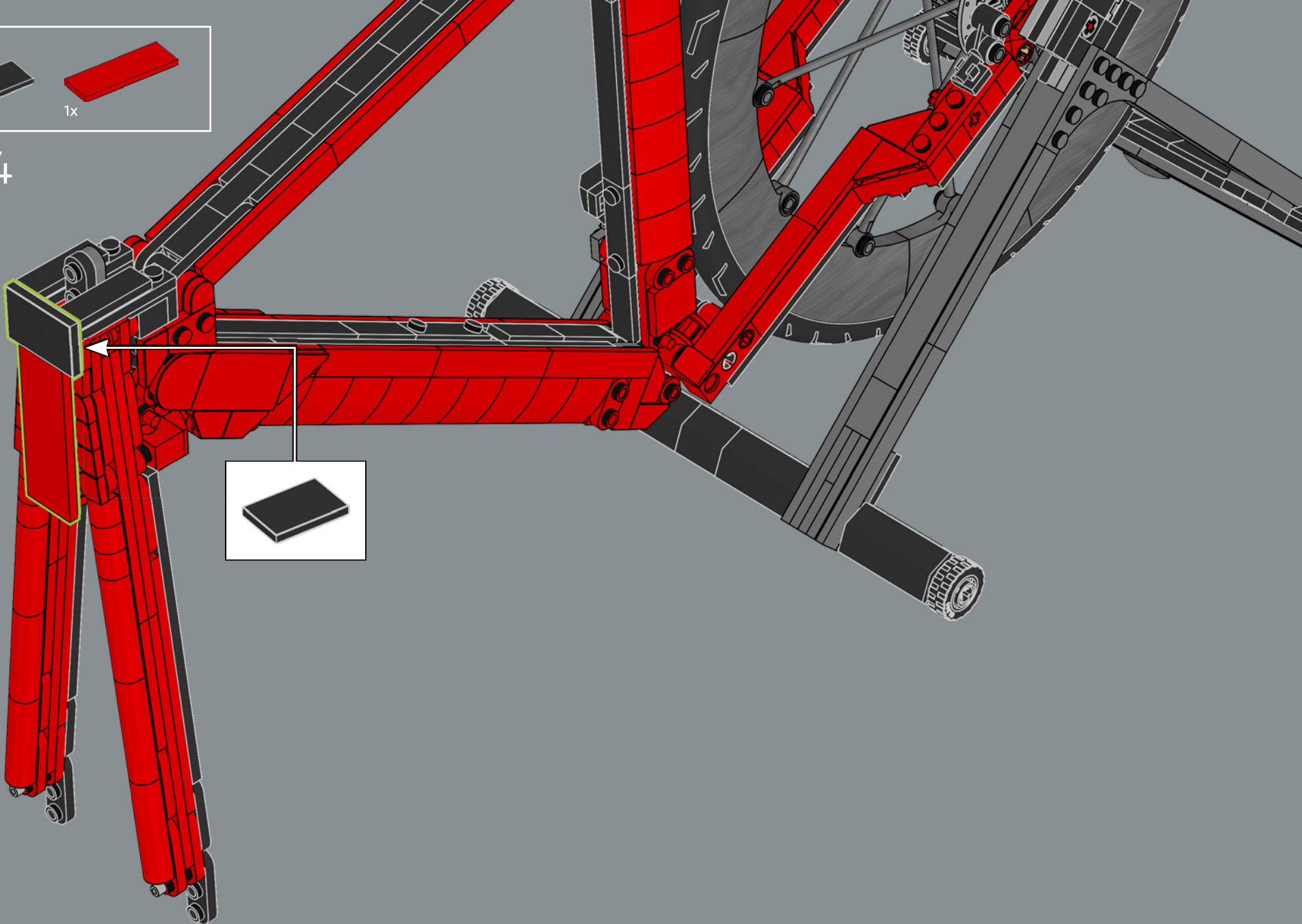



265

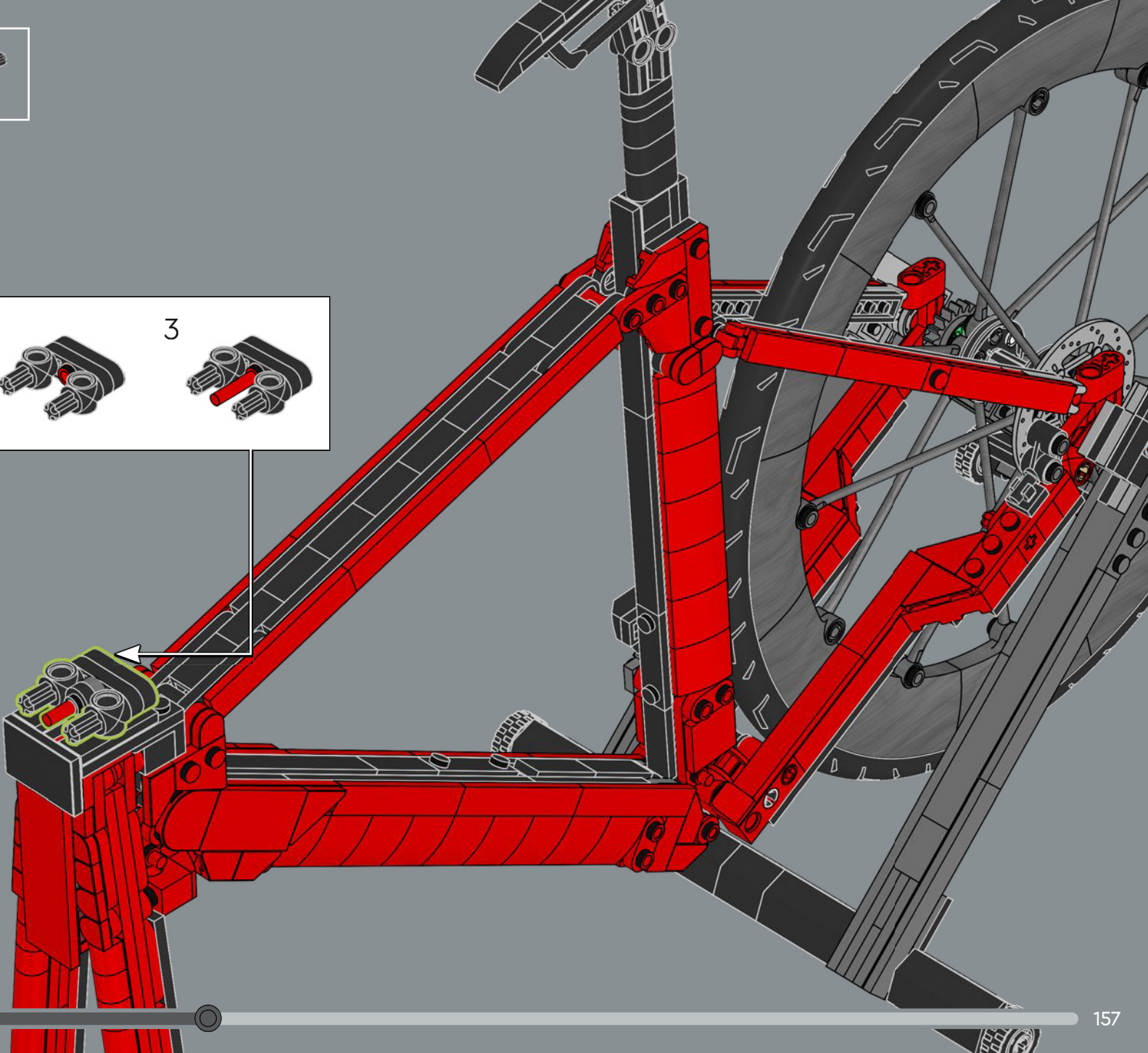
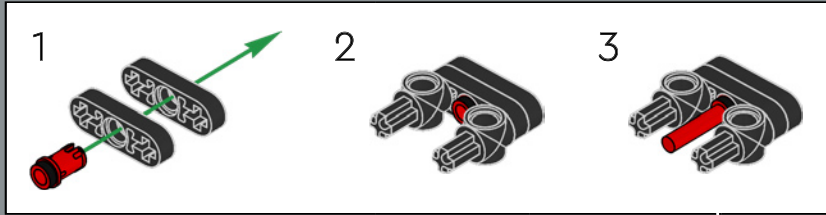



2x

266

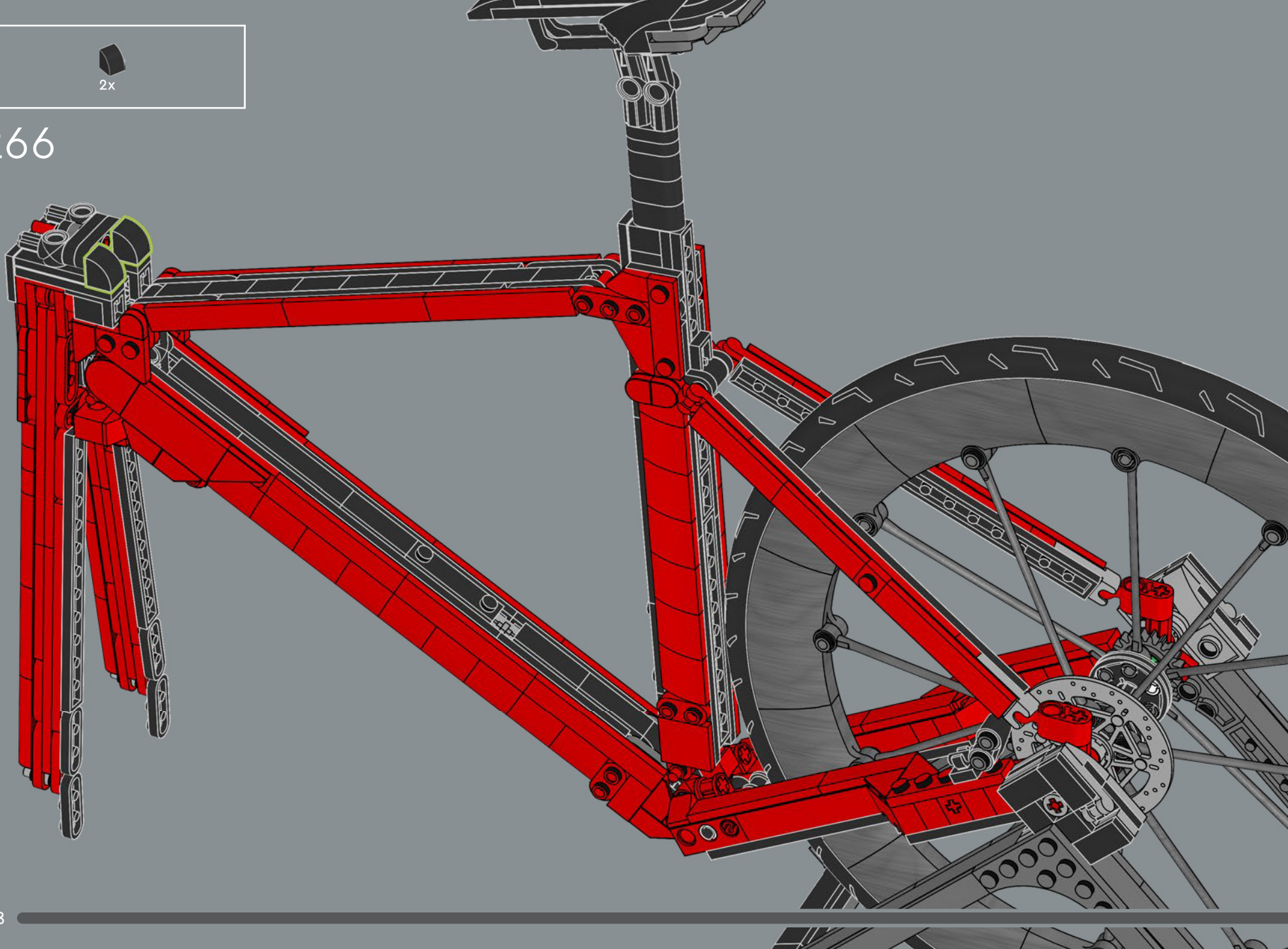



267

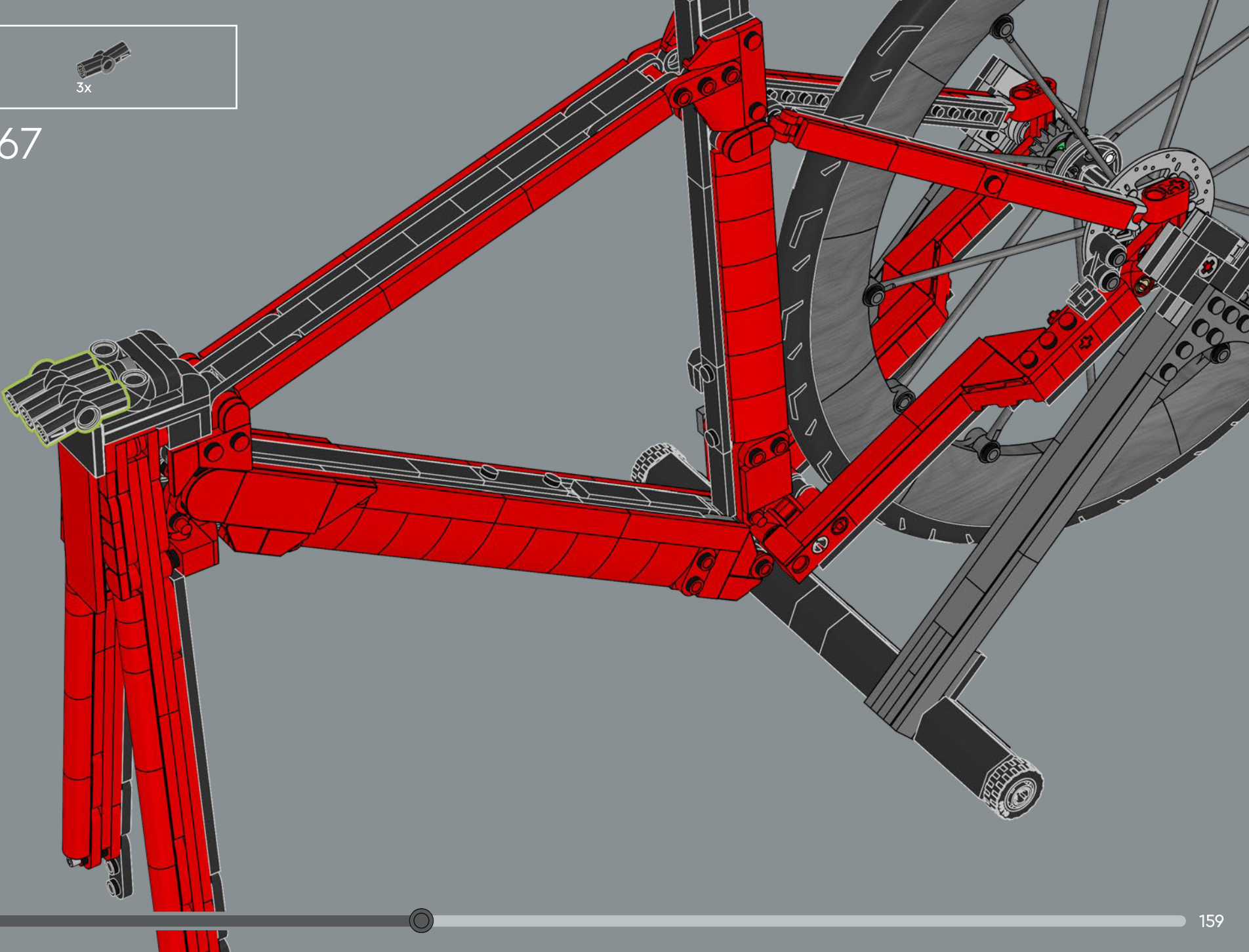

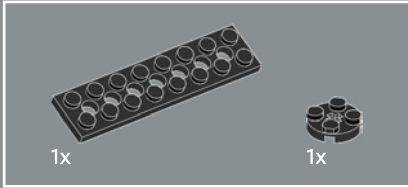
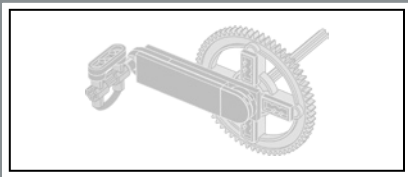

268

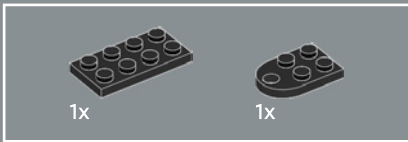
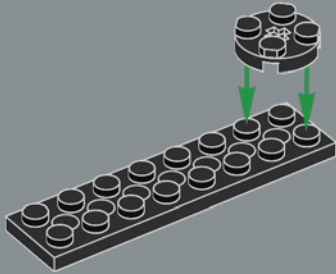

269

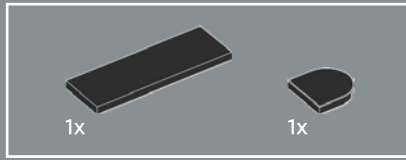
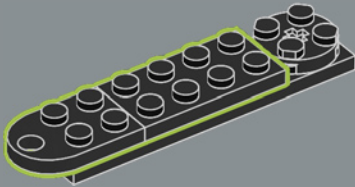

270

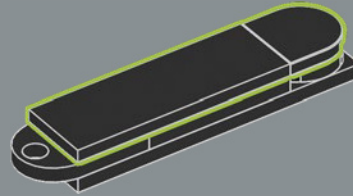

271

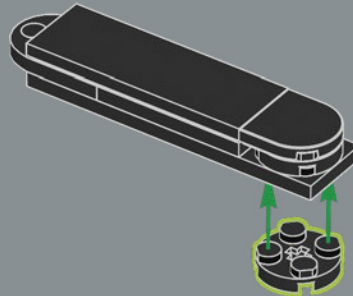

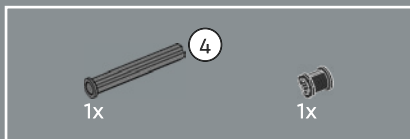

272

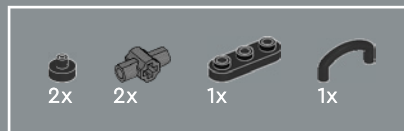
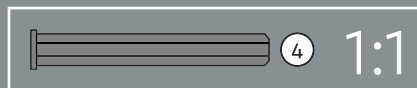
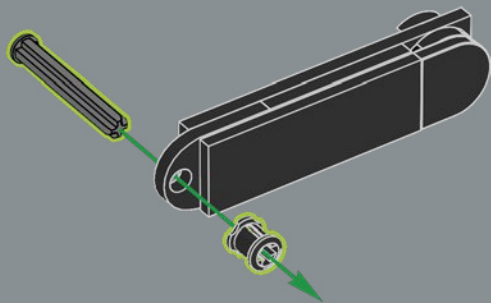

273

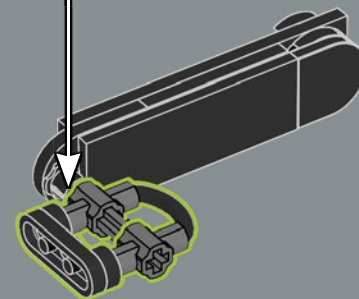
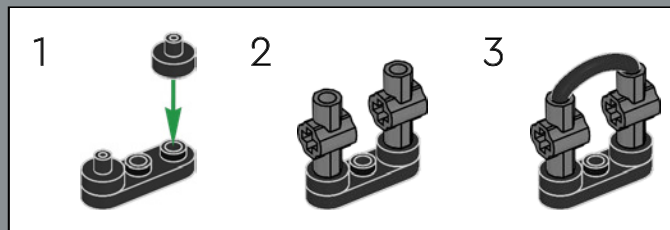

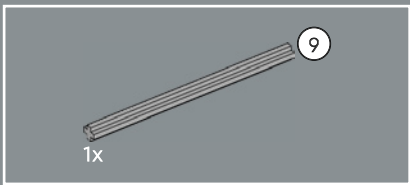

274

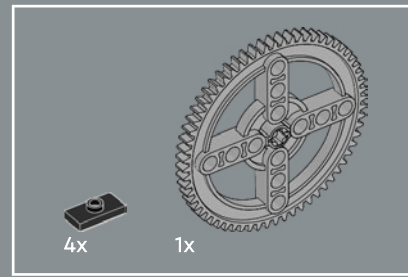
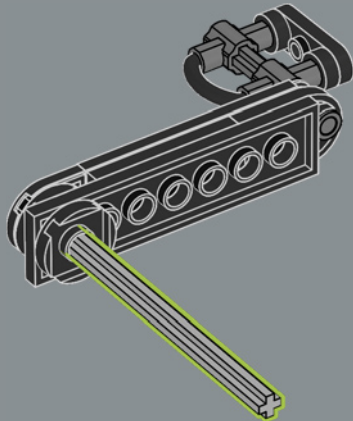

275

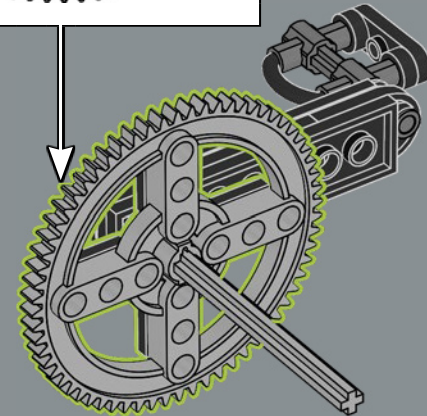
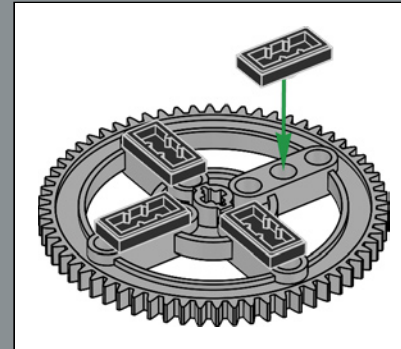

This is currently the biggest LEGO® spur gear, made specifically for this model.

Il s'agit actuellement du plus grand engrenage LEGO® à dents droites, conçu spécialement pour ce modèle.

Actualmente, este es el engrane LEGO® más grande, y se hizo específicamente para este modelo.

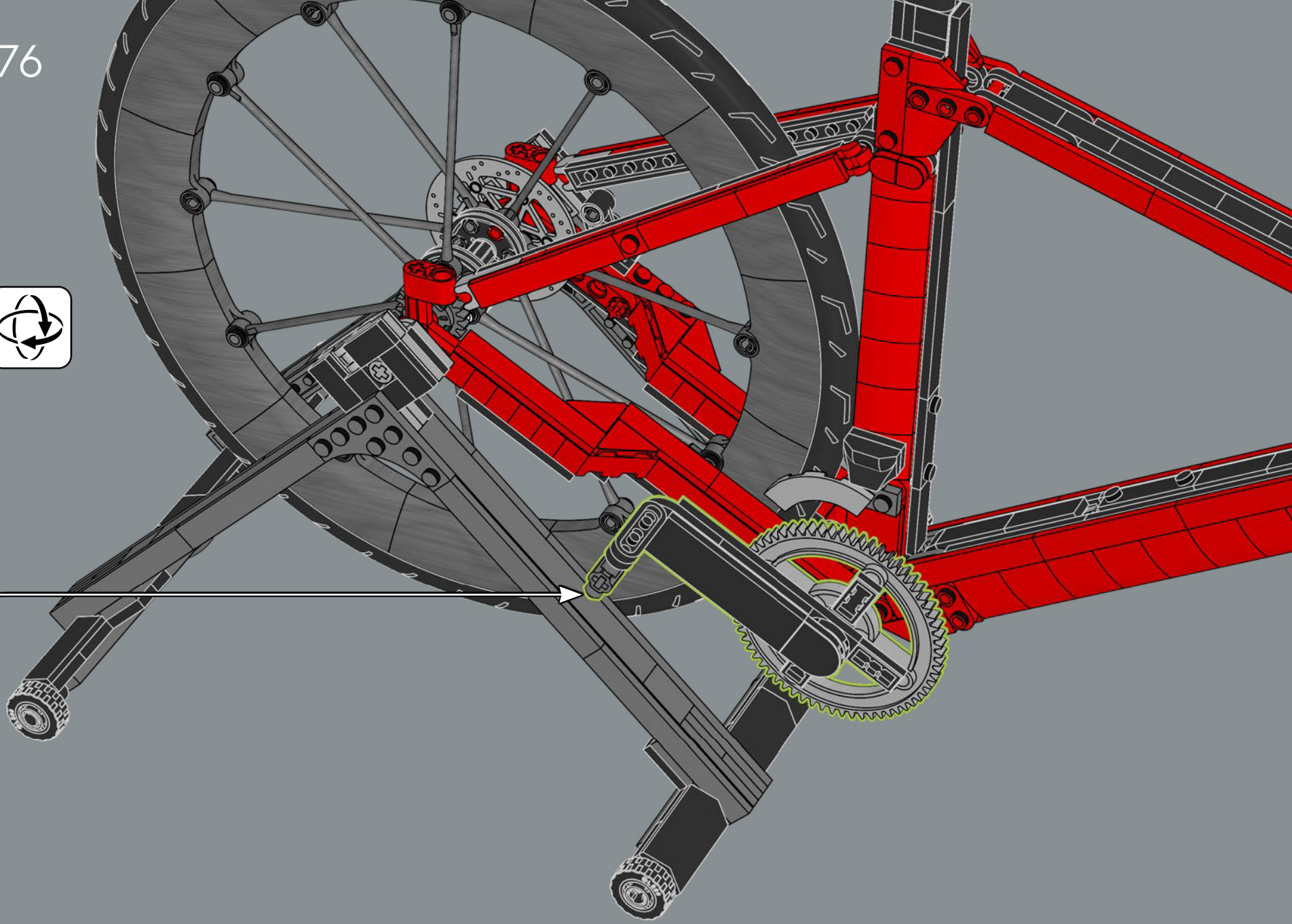

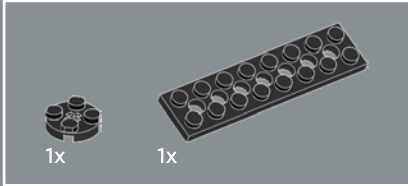
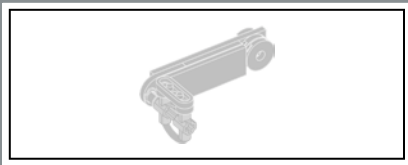

277

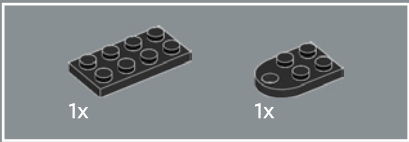
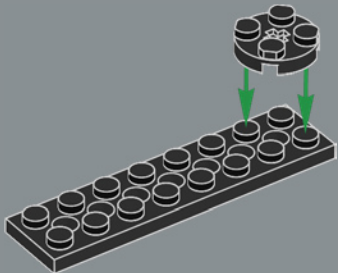

278

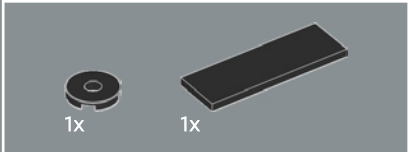
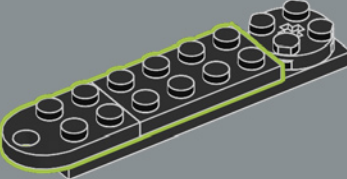

279

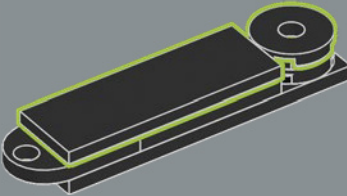



280

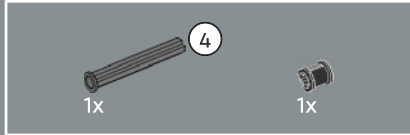
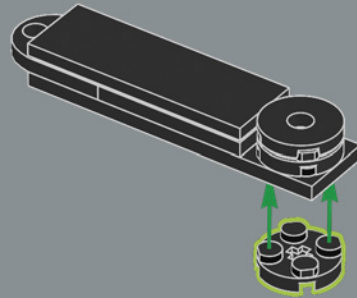

281

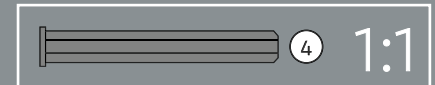
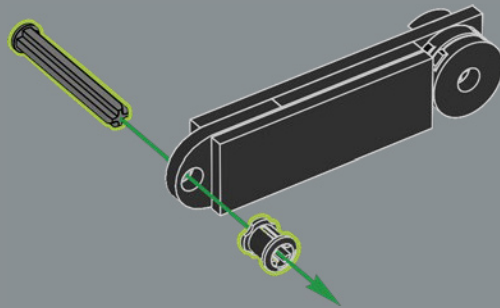

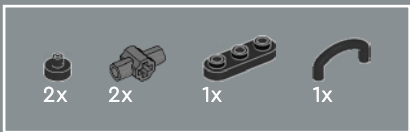

282

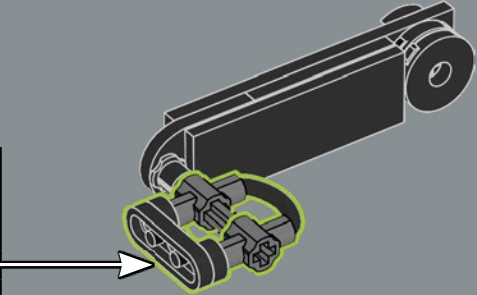
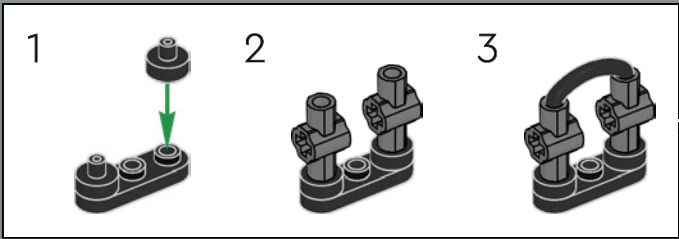

283

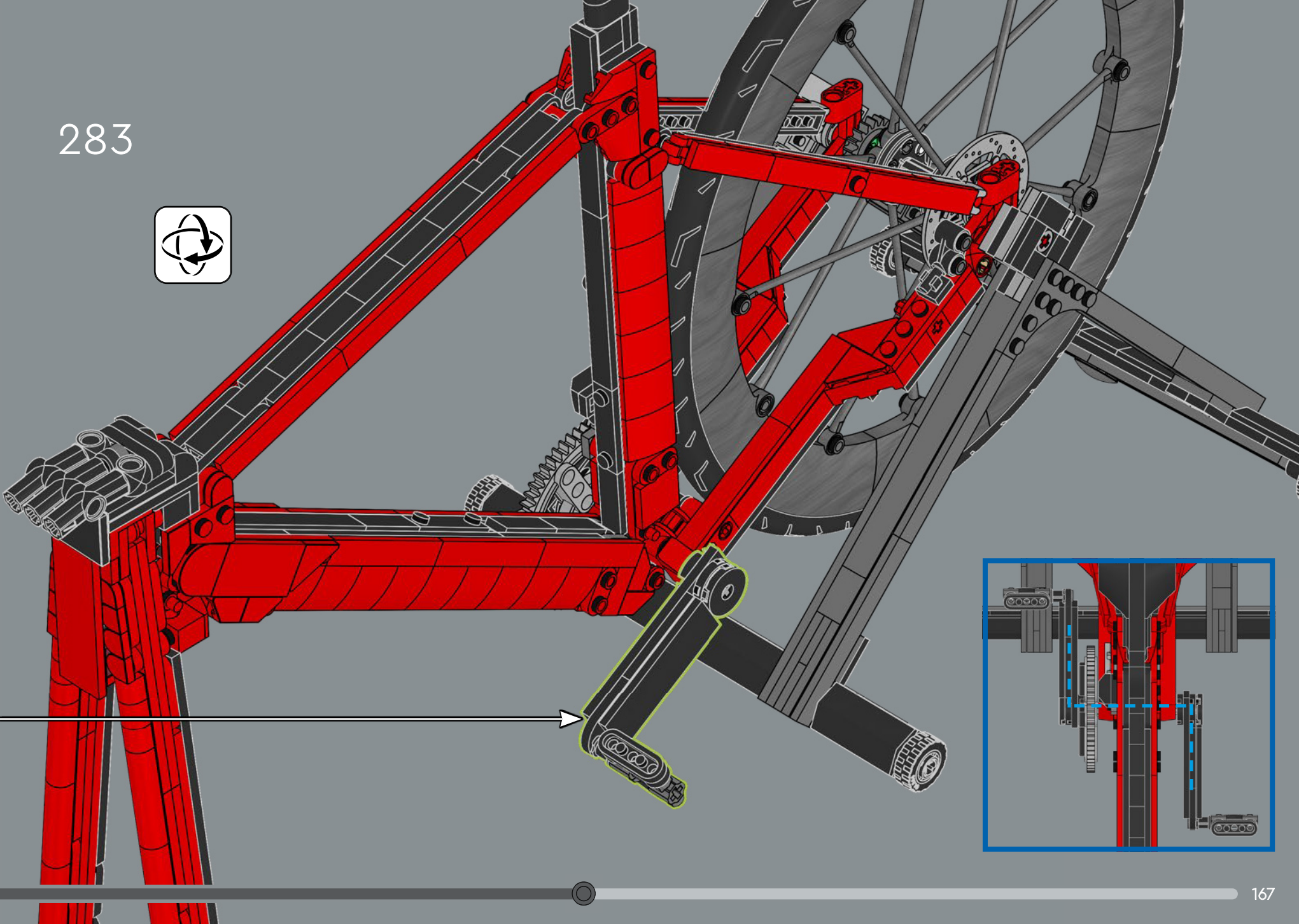

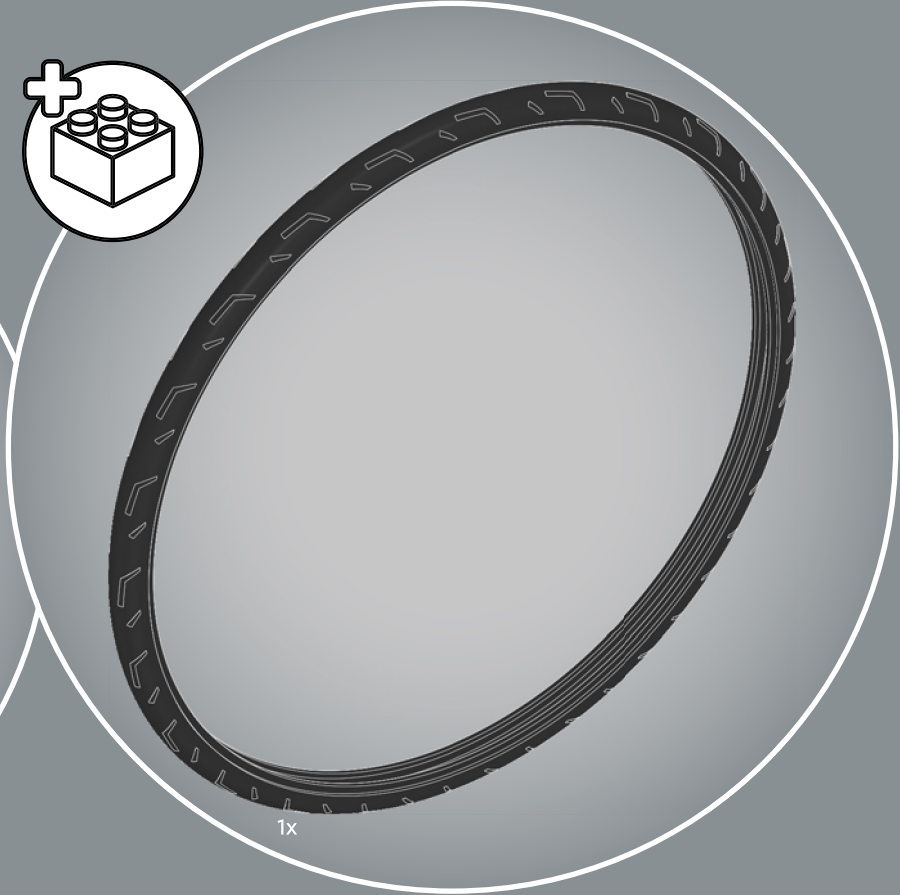
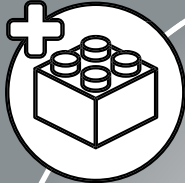

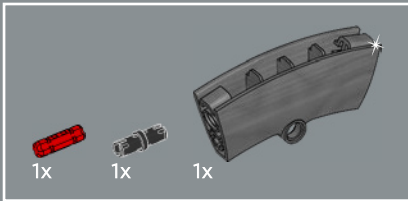
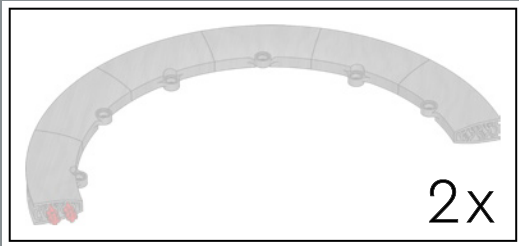
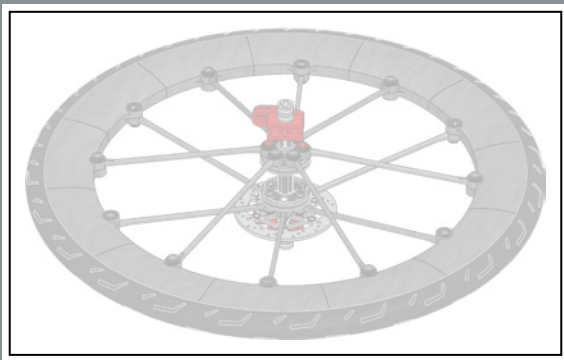

284

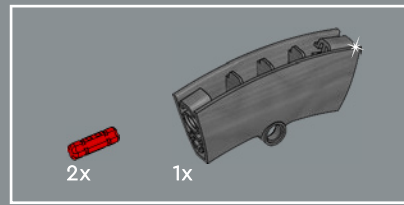
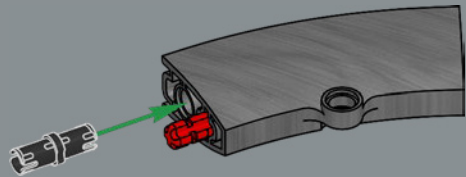

285

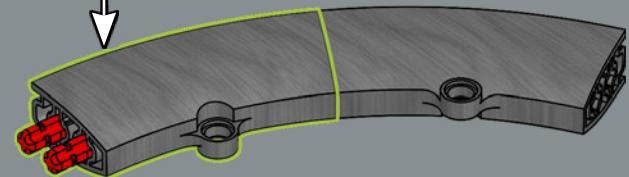
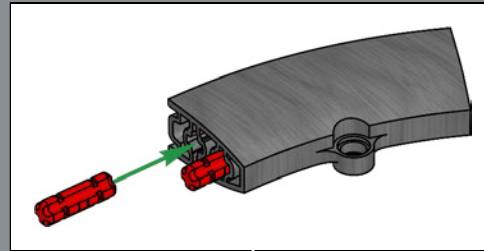

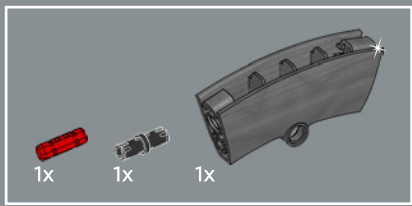

286

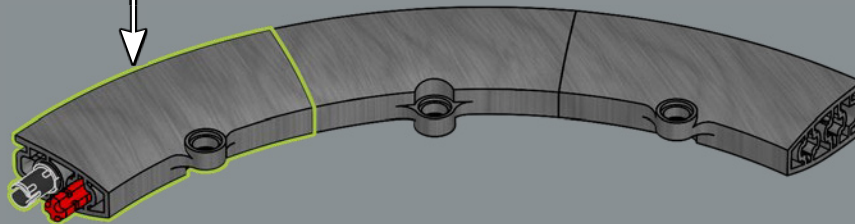
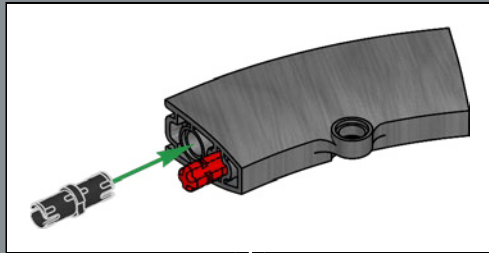

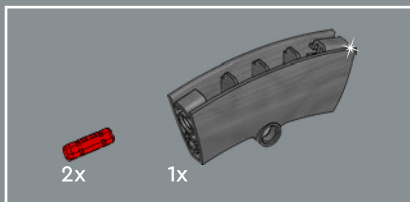

287

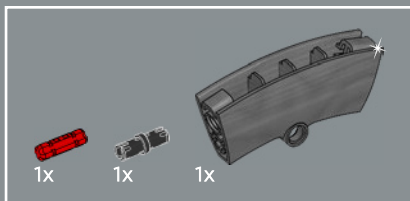
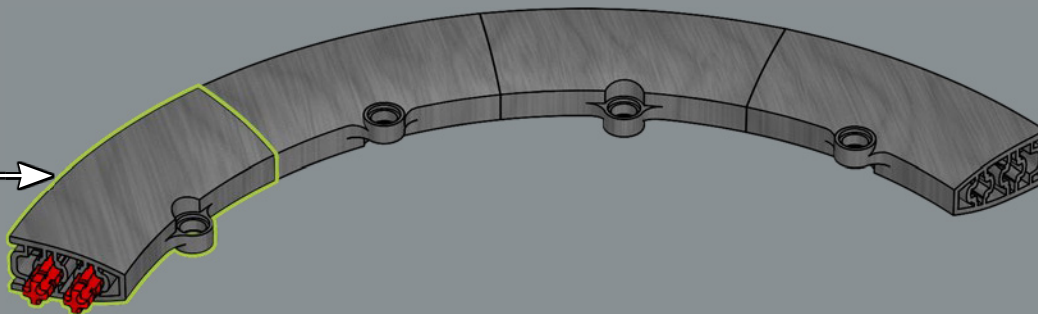
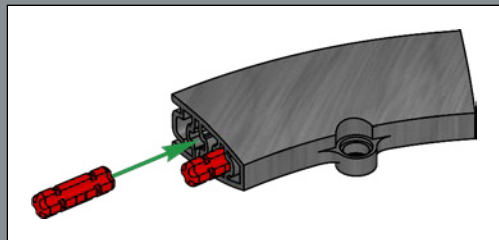

288

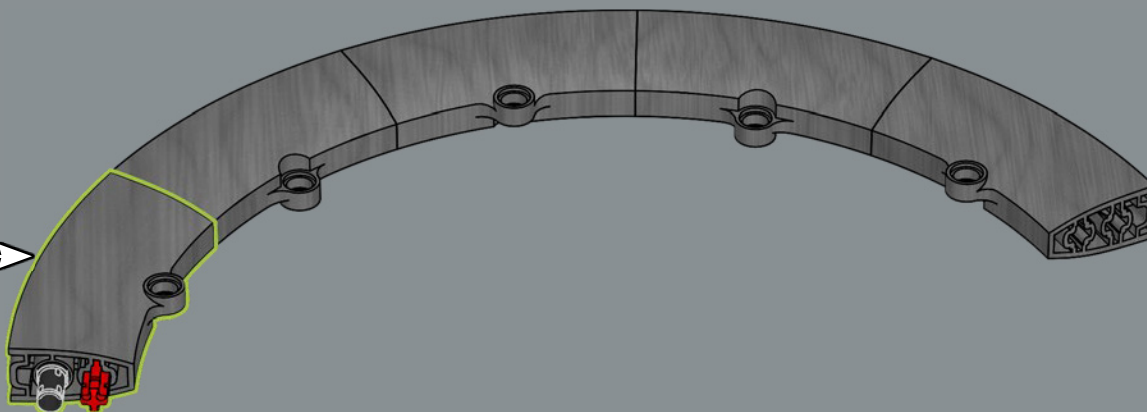
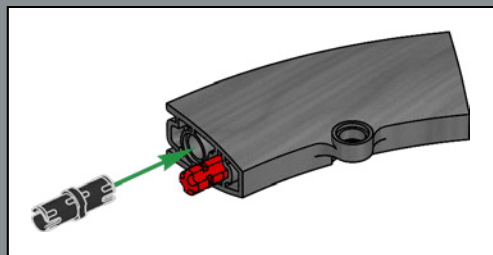

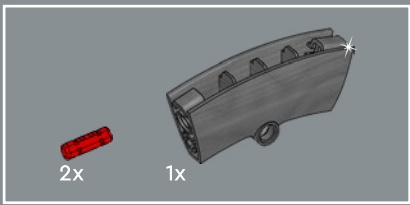

289

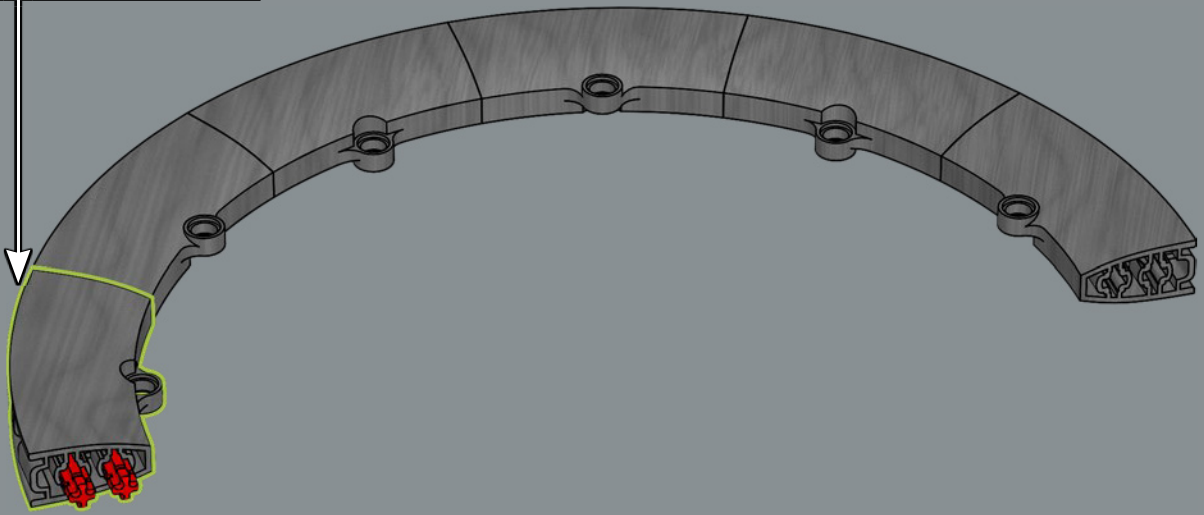
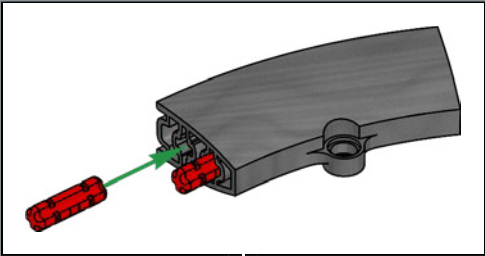

2x

290

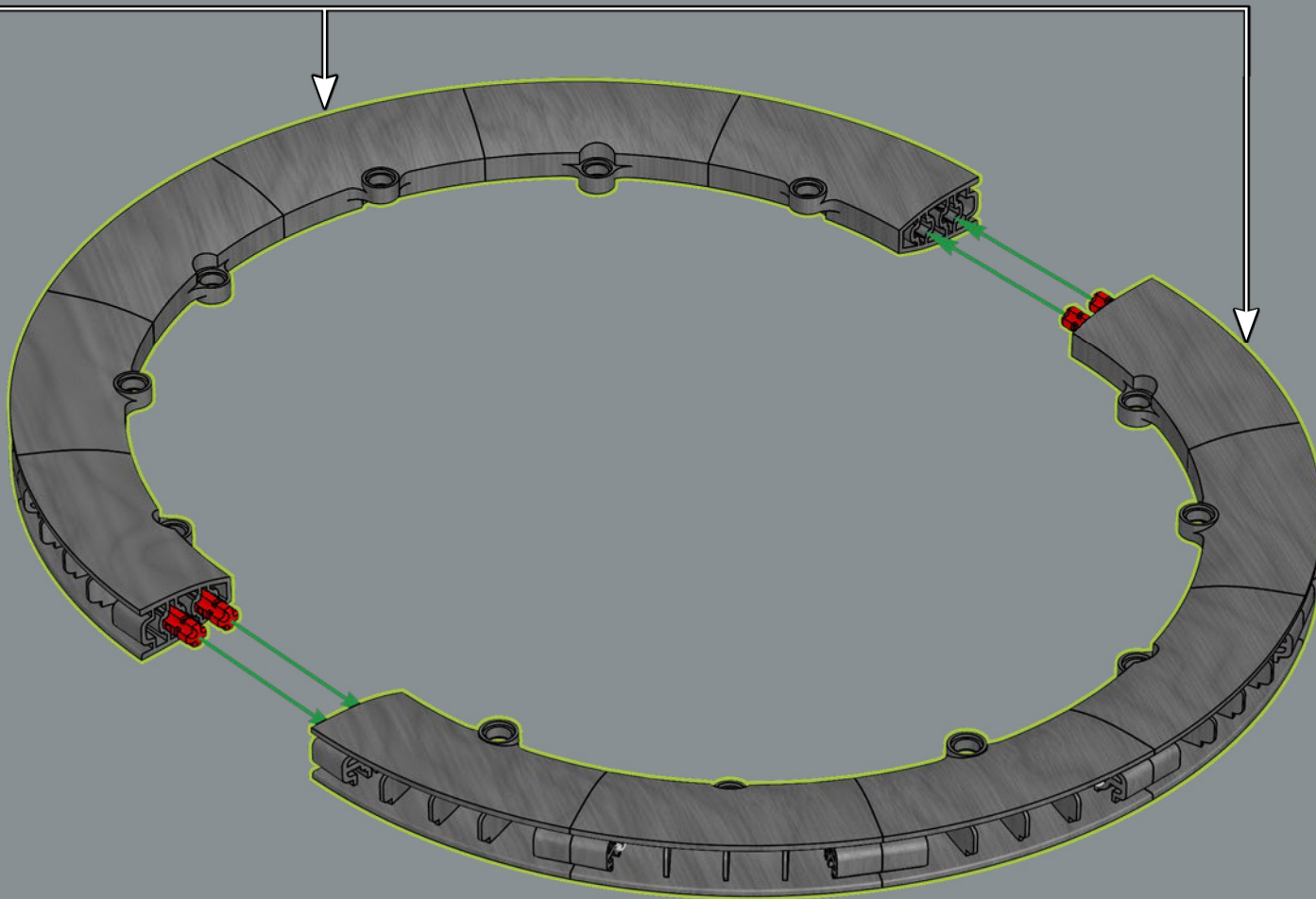

291

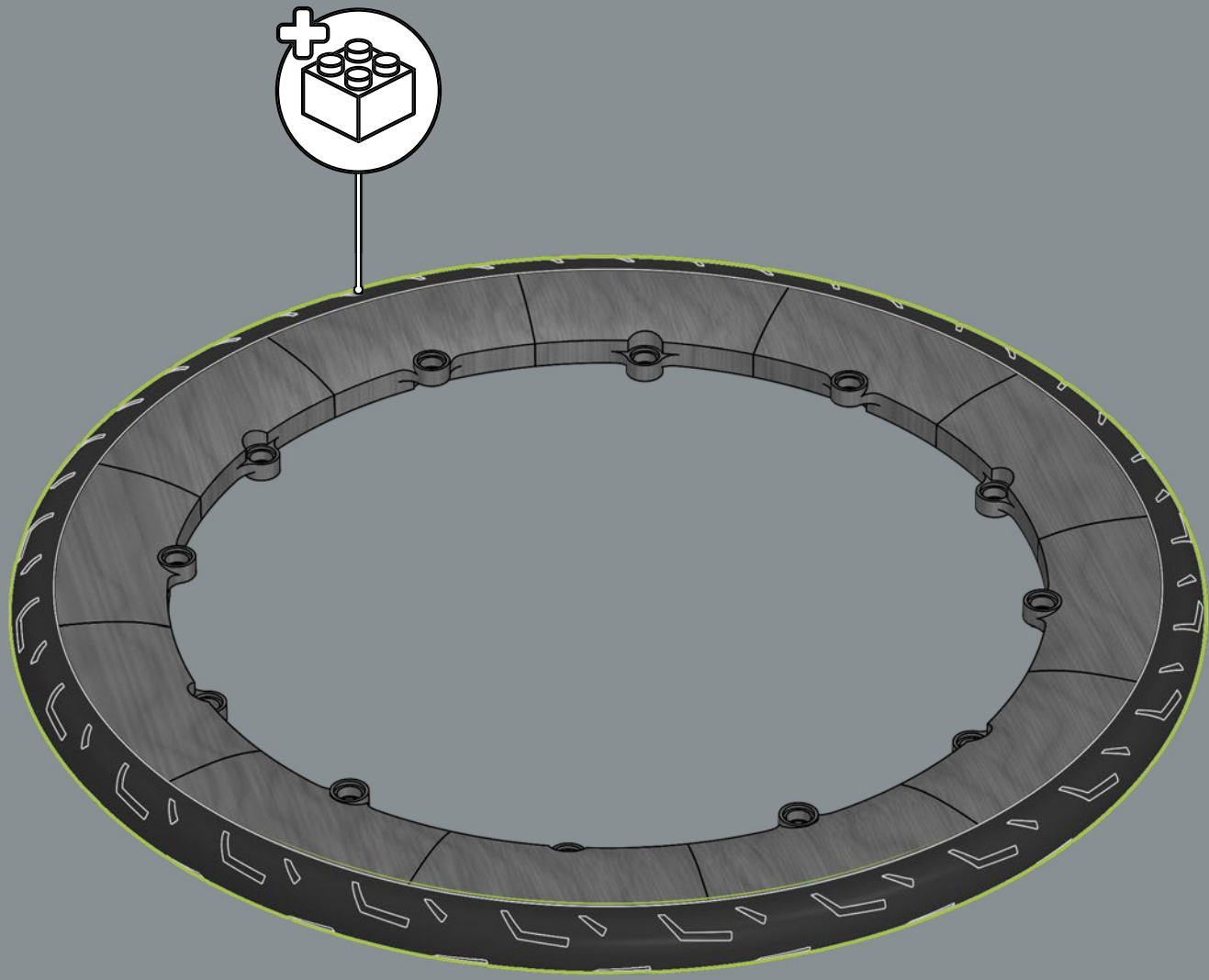

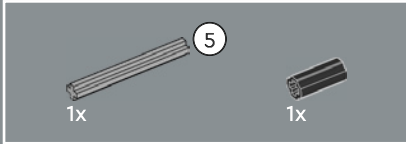
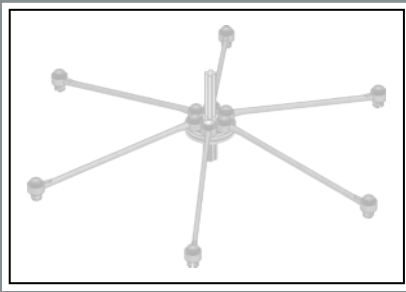

292

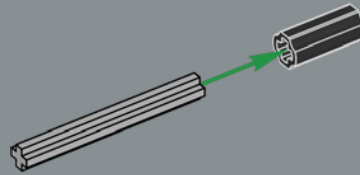

293

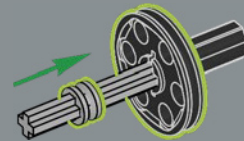

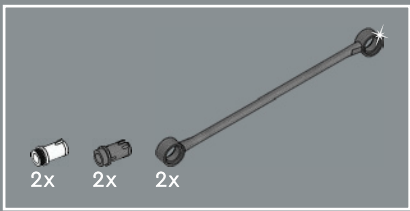

294

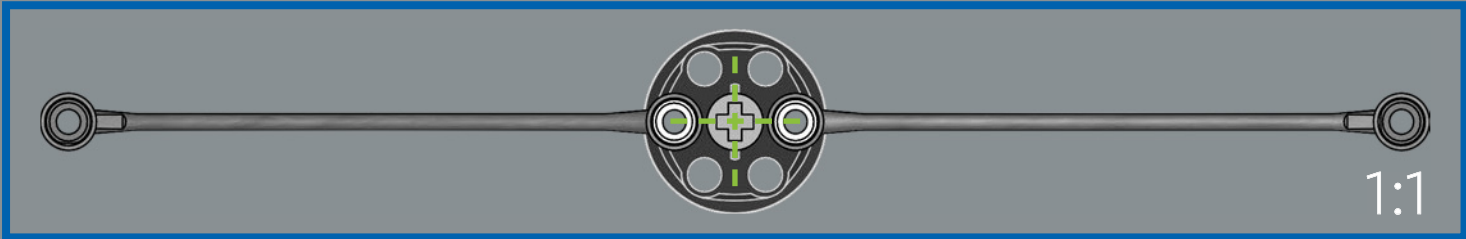
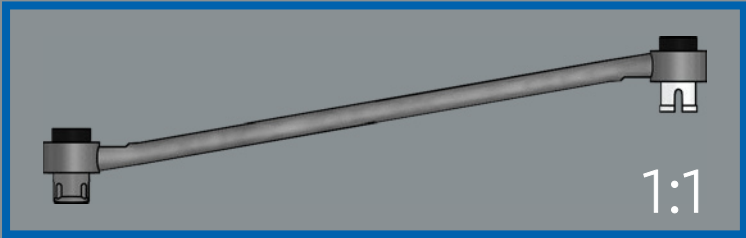
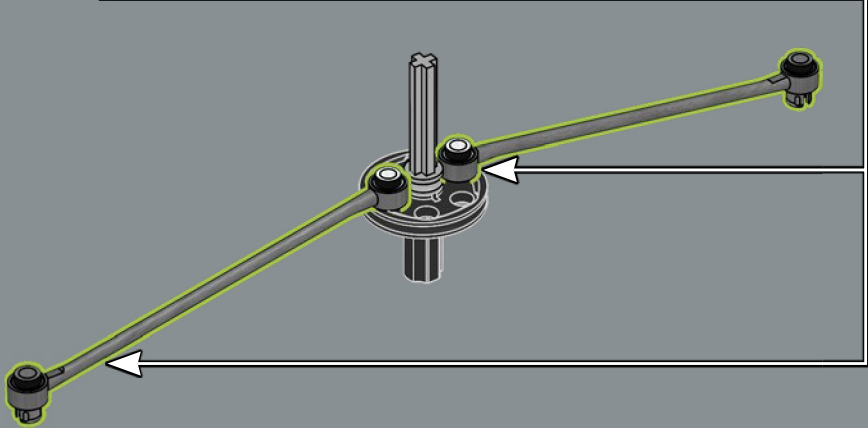
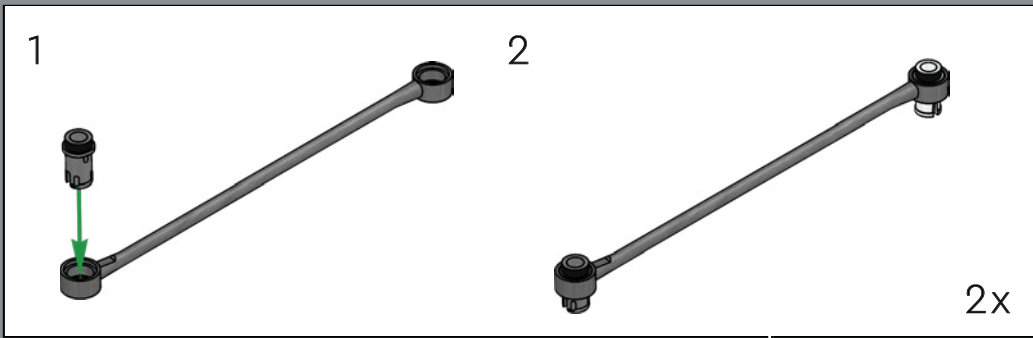

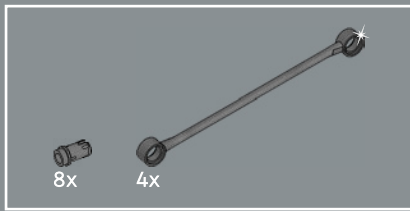

295

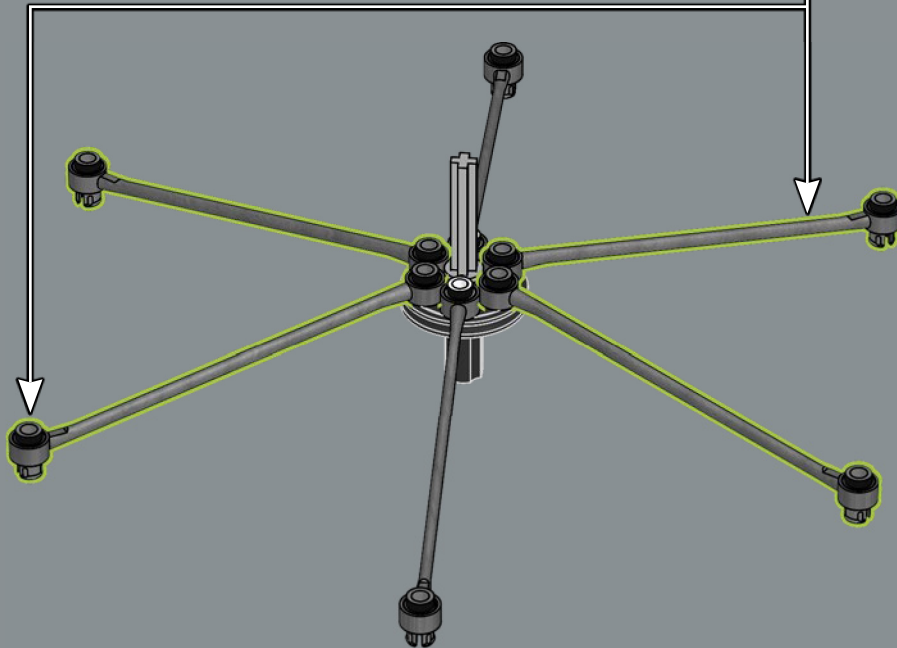
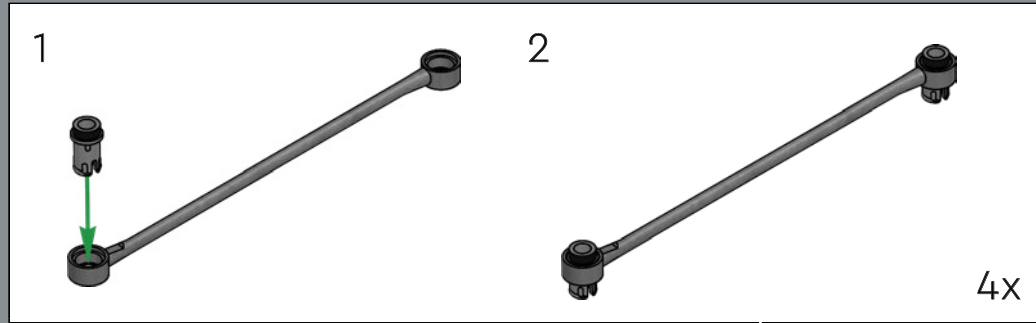

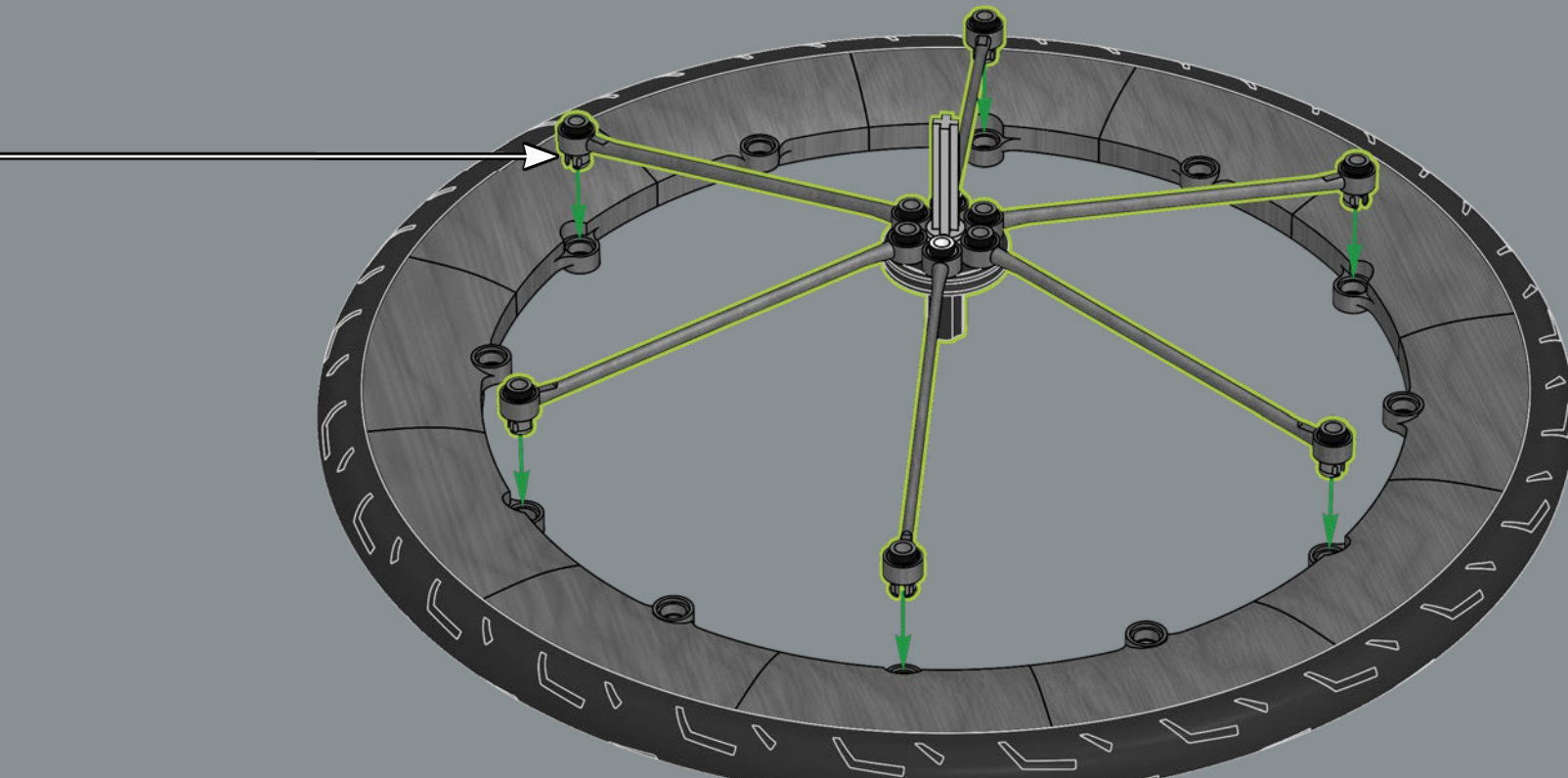
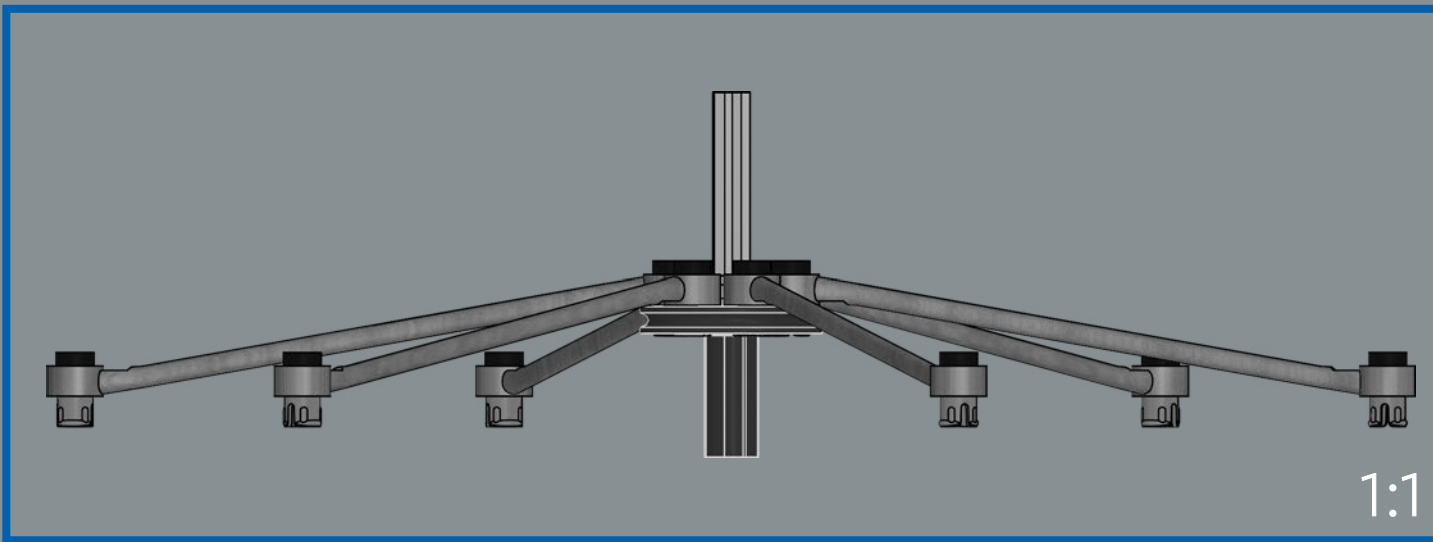

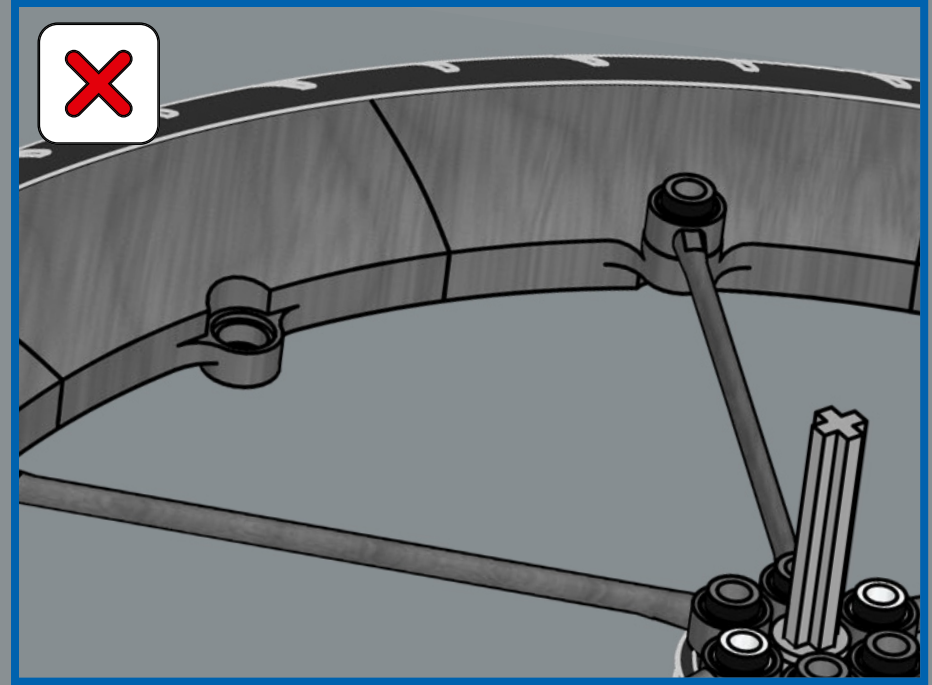
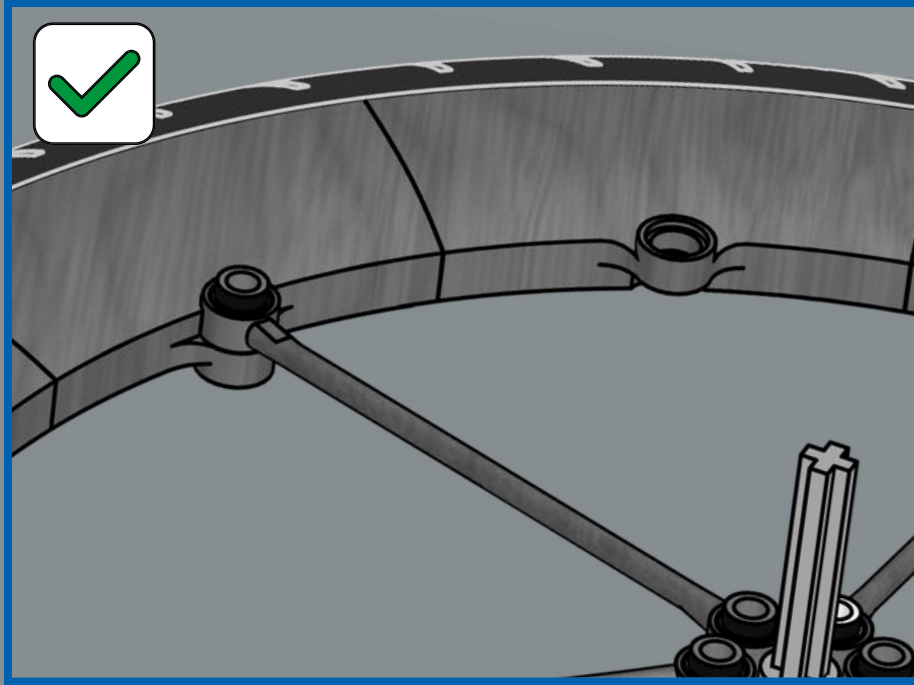

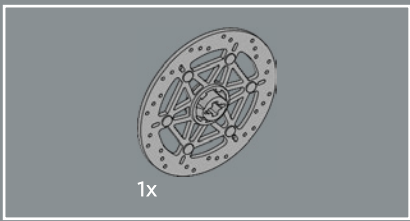

297

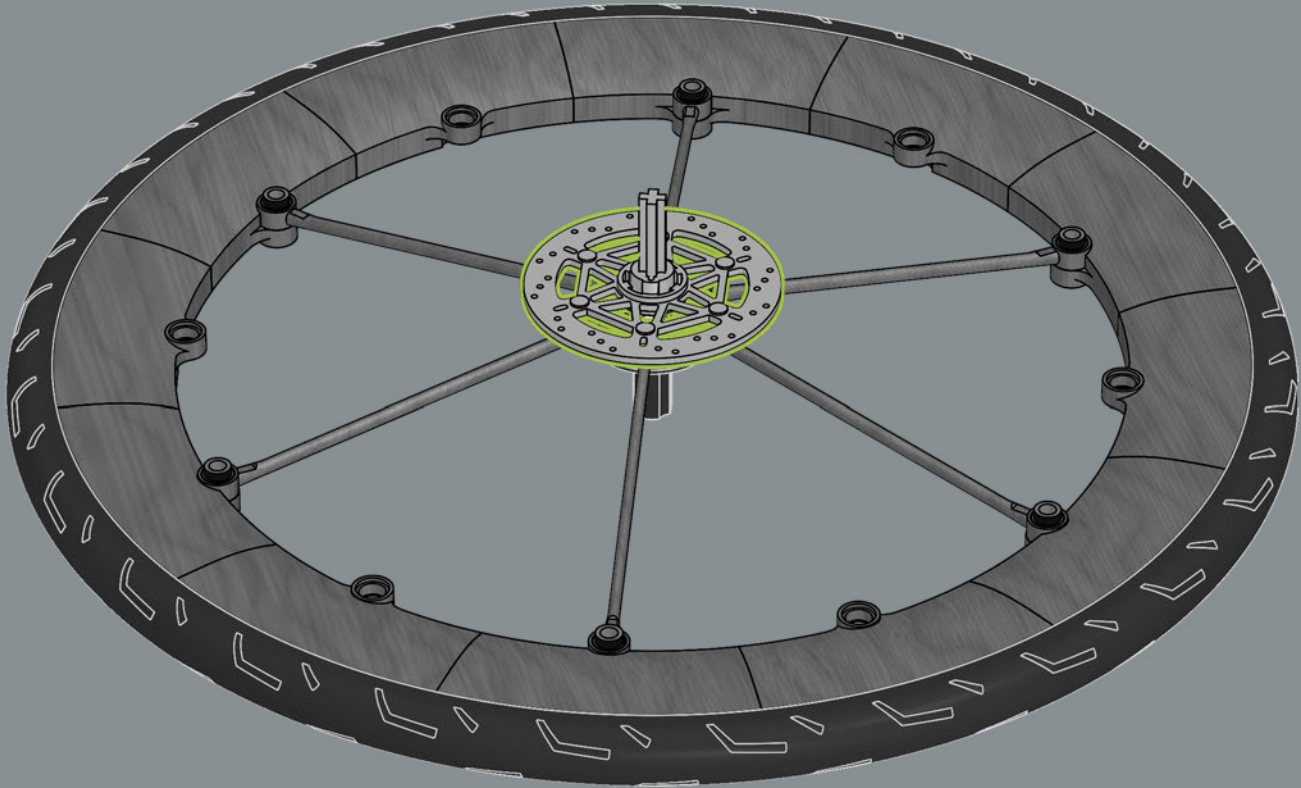

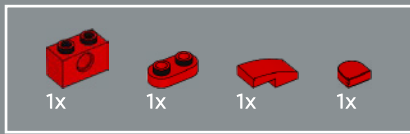

298

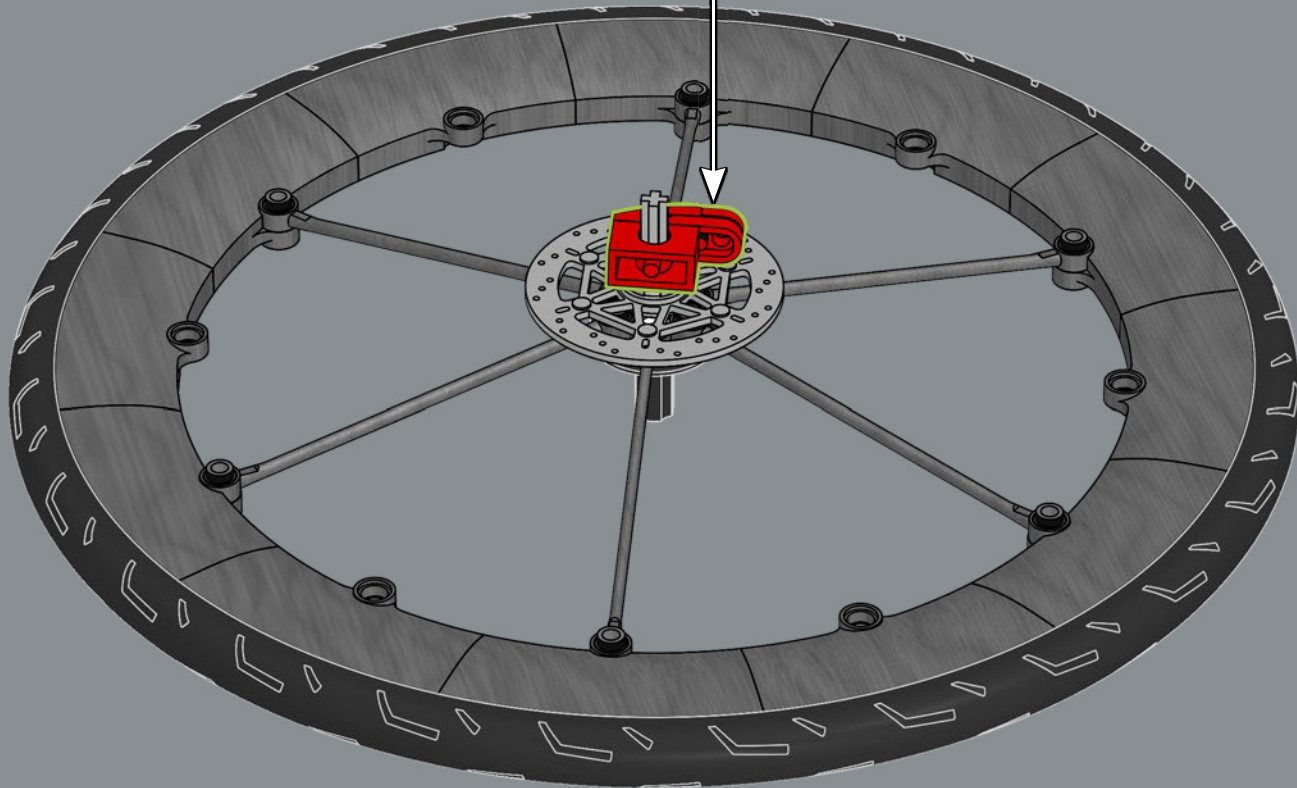
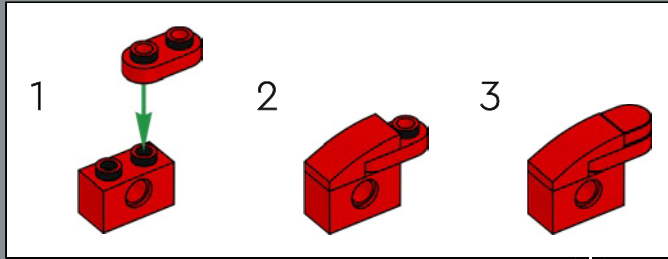



2x

299

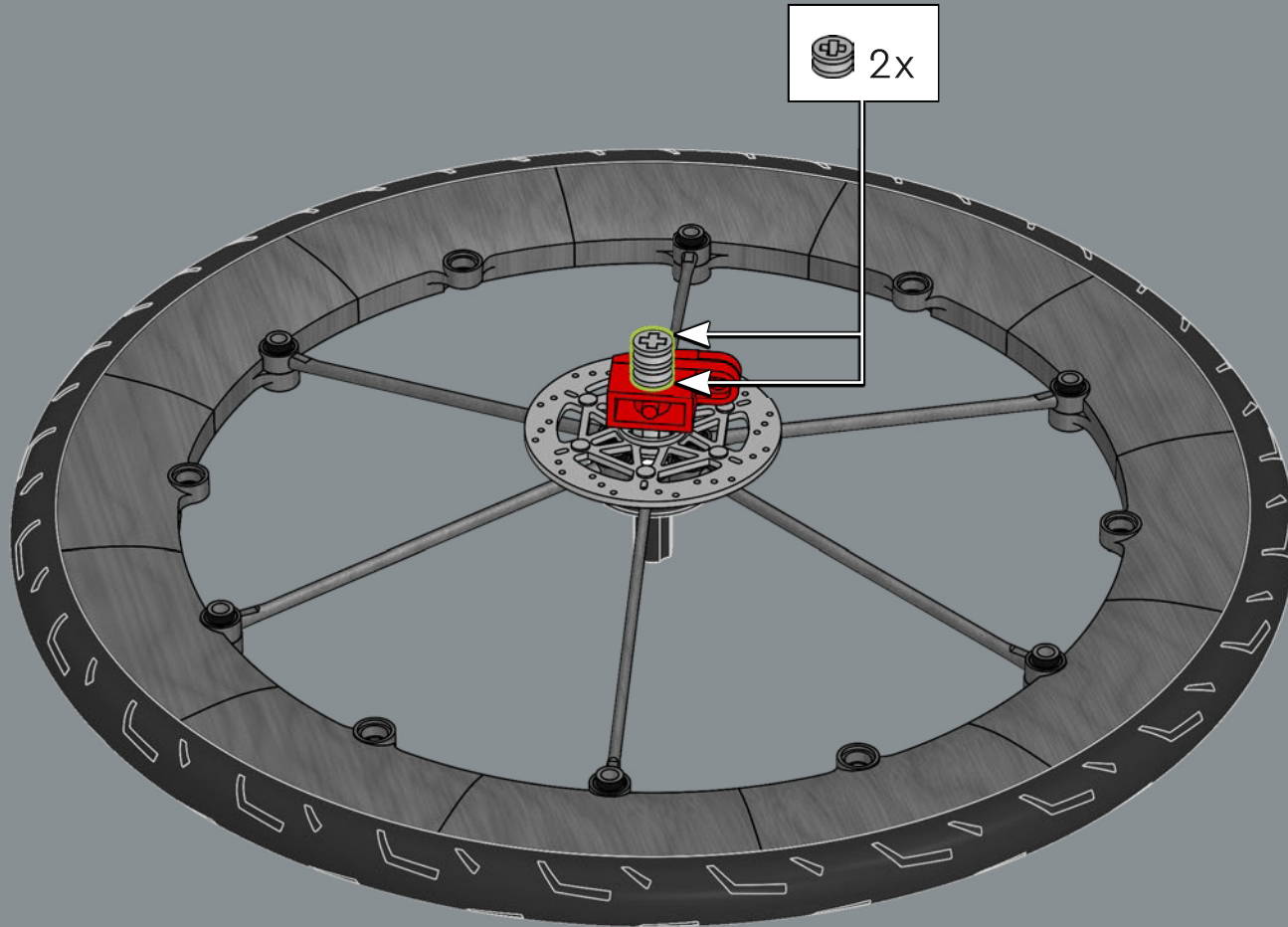

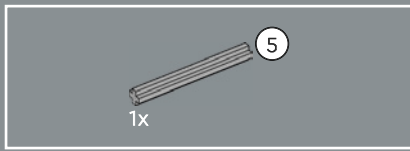

300

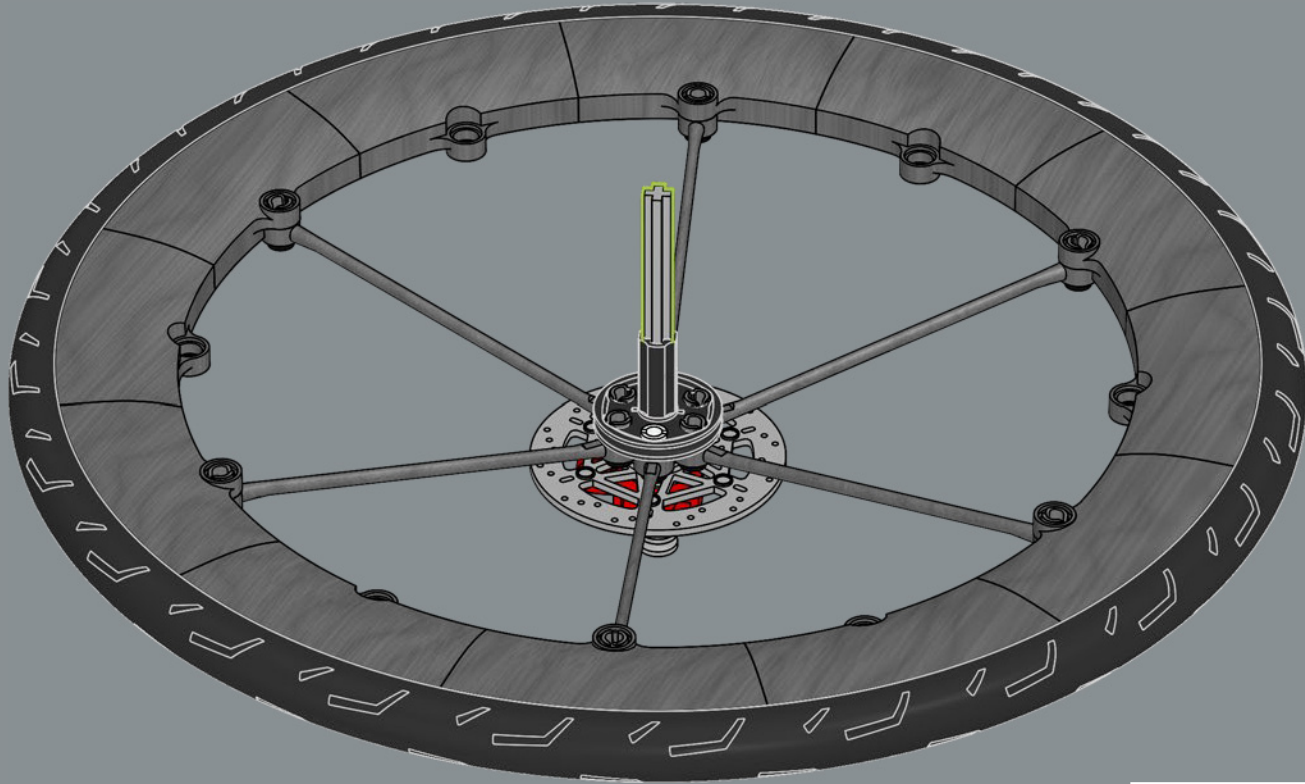



301

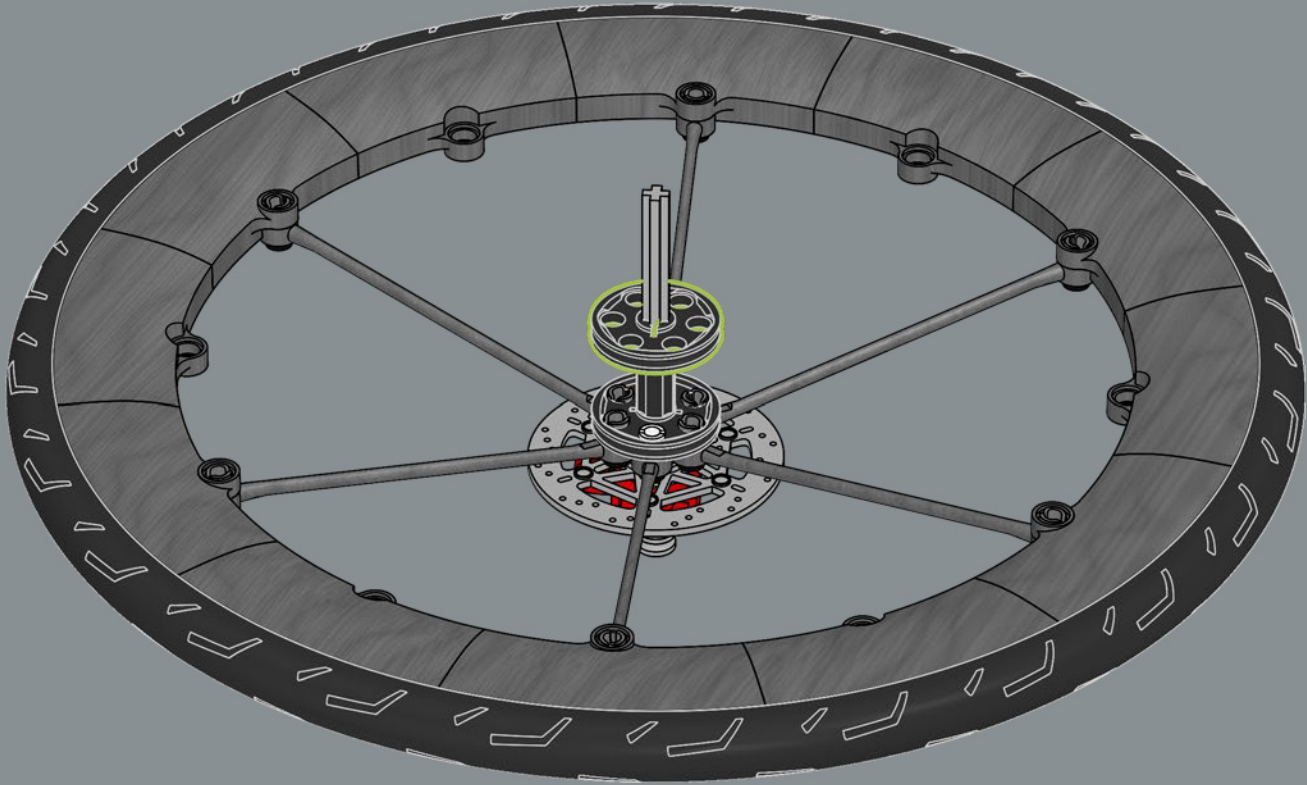

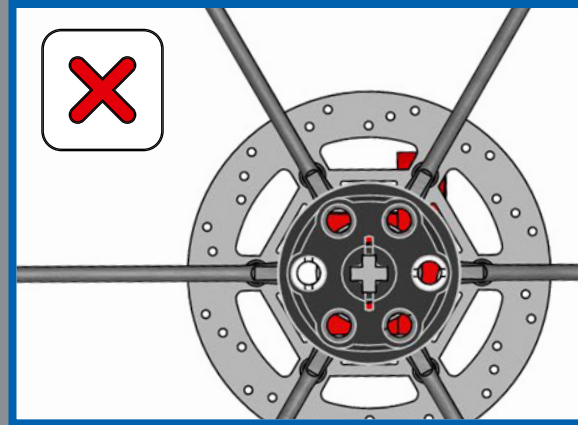
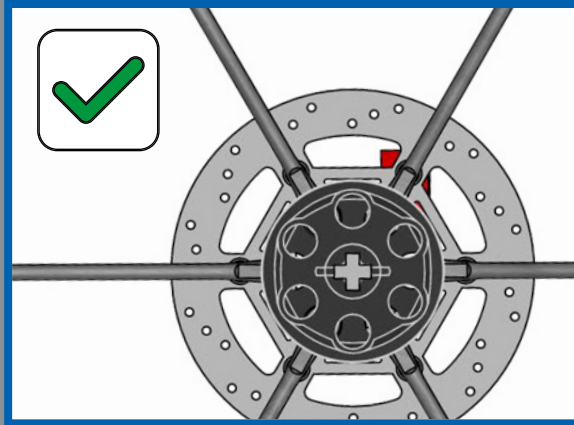



1x

302

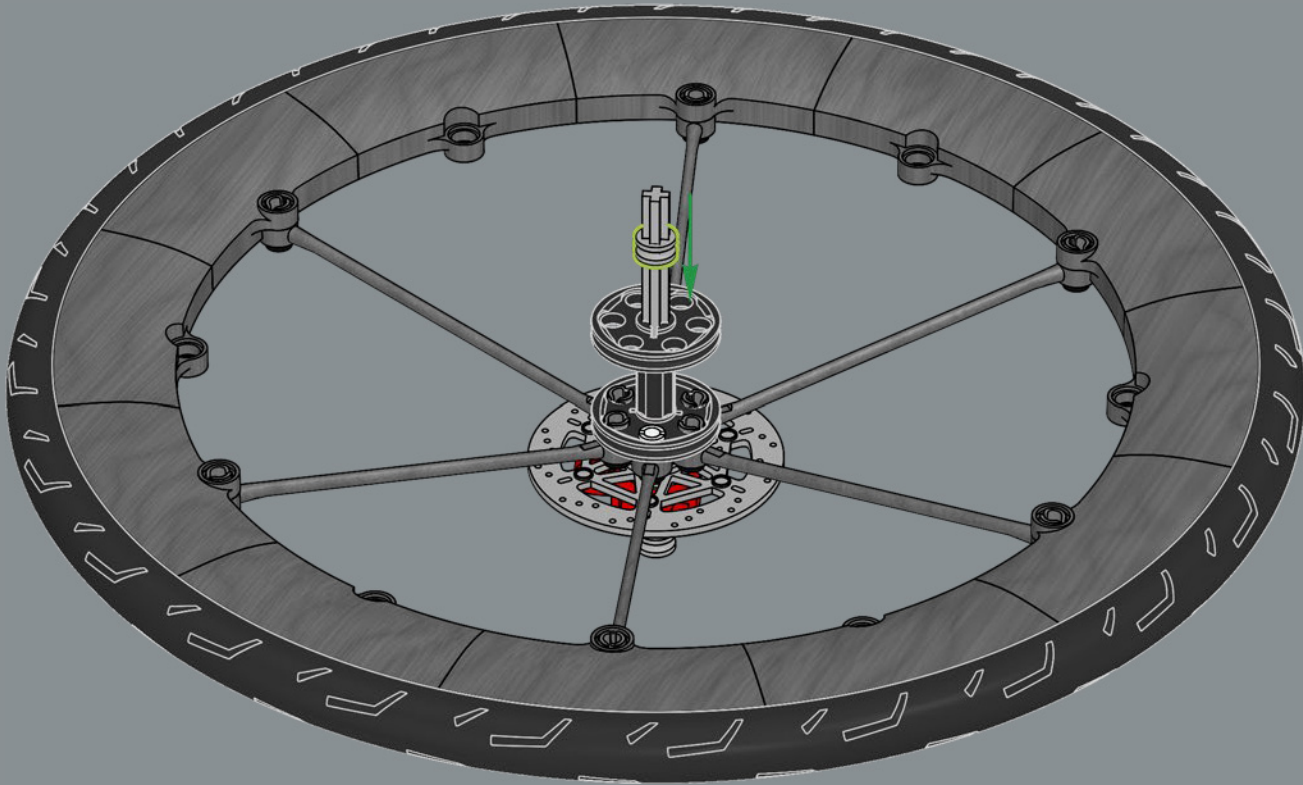



303

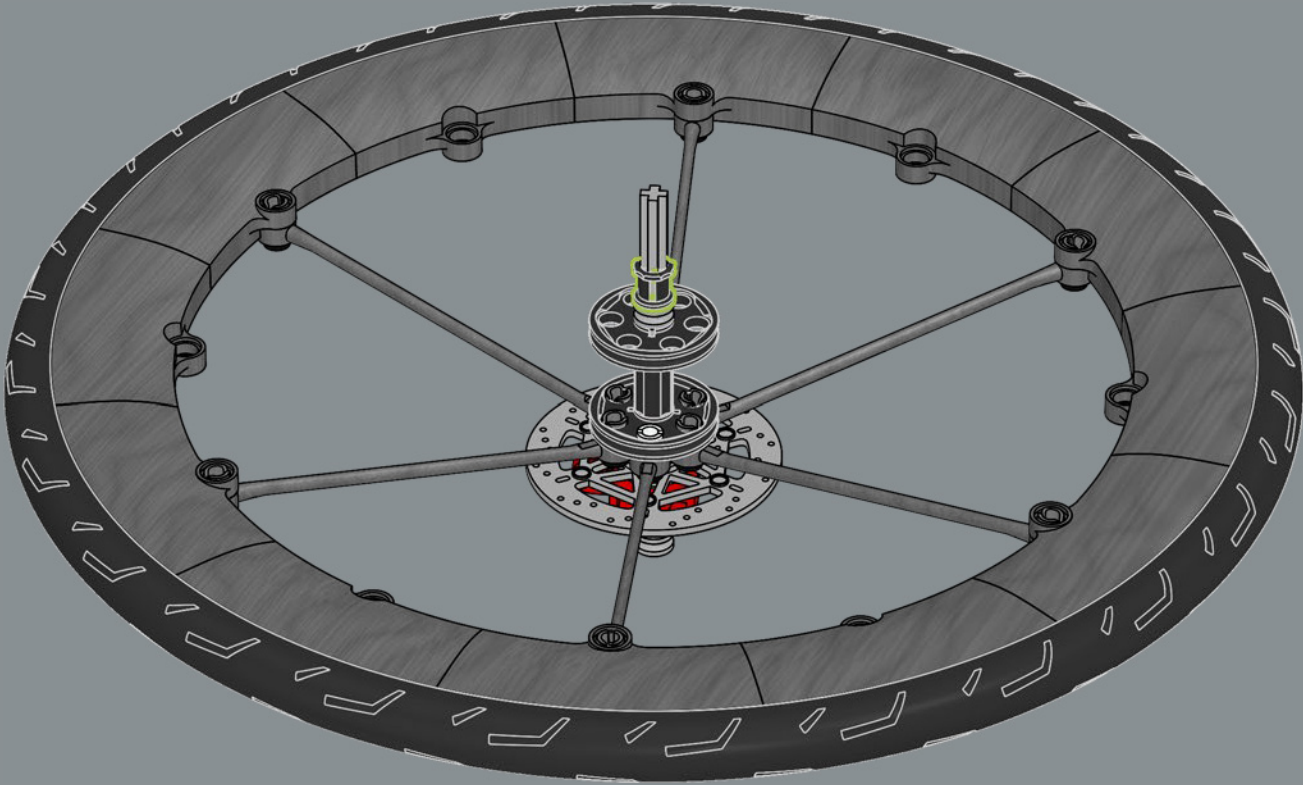

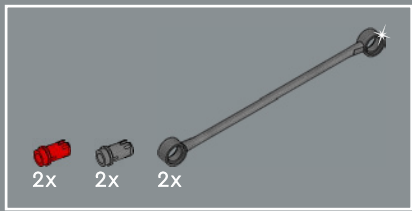

304

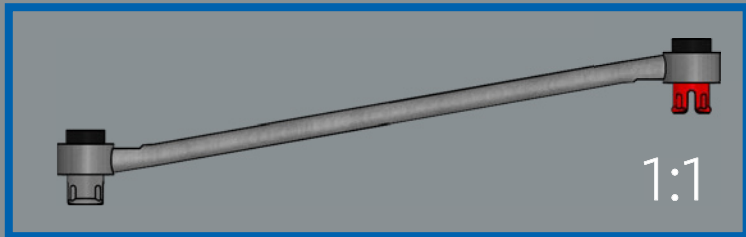
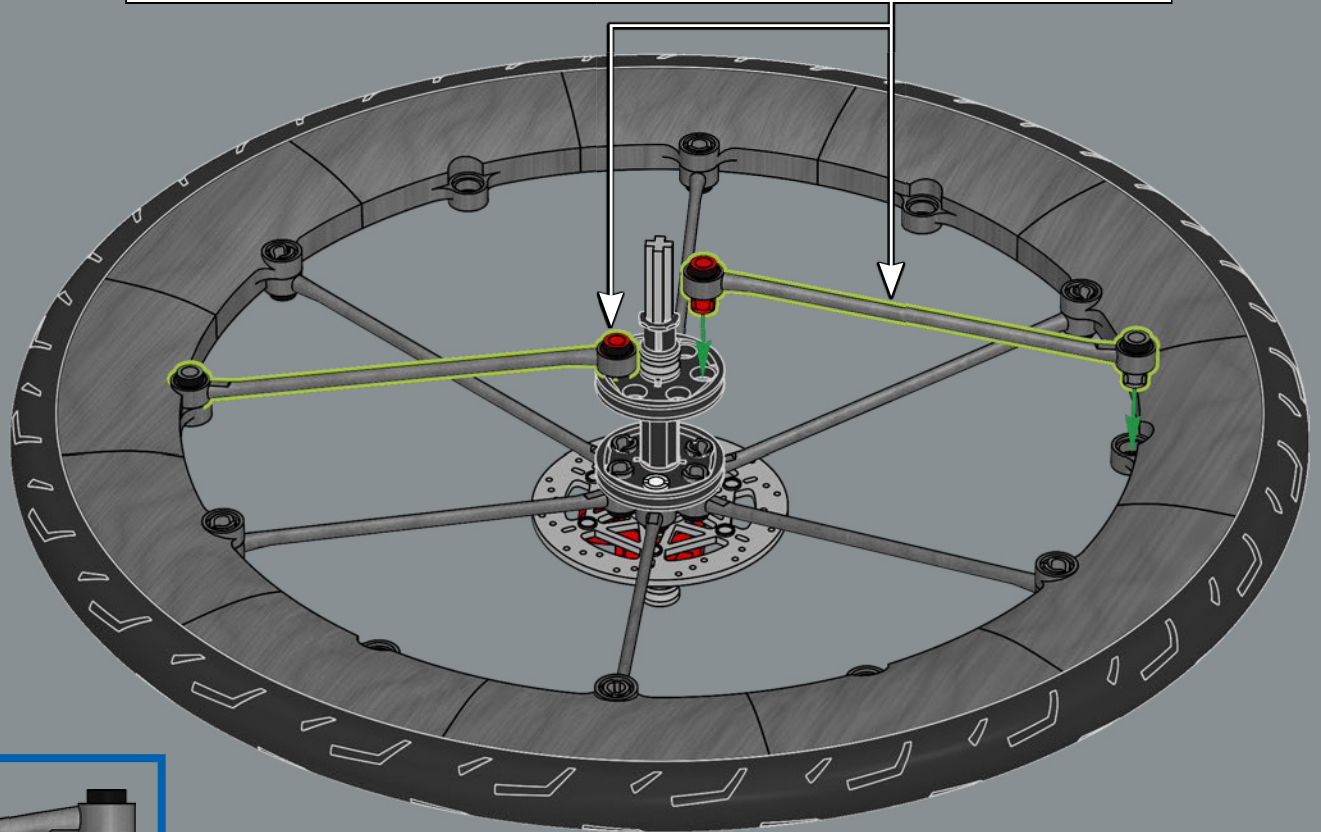
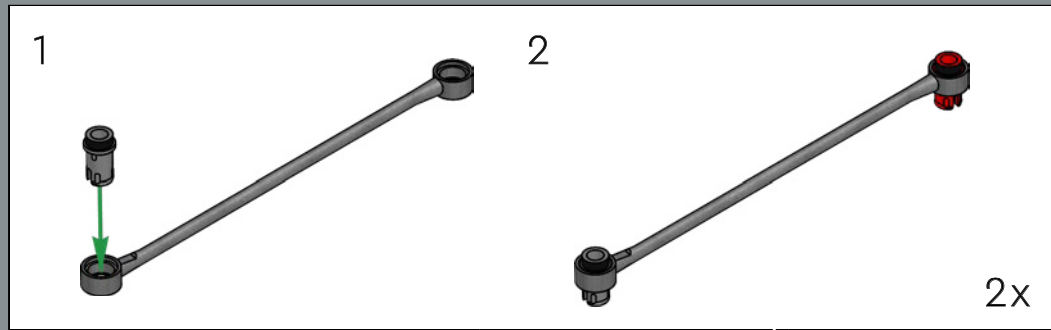

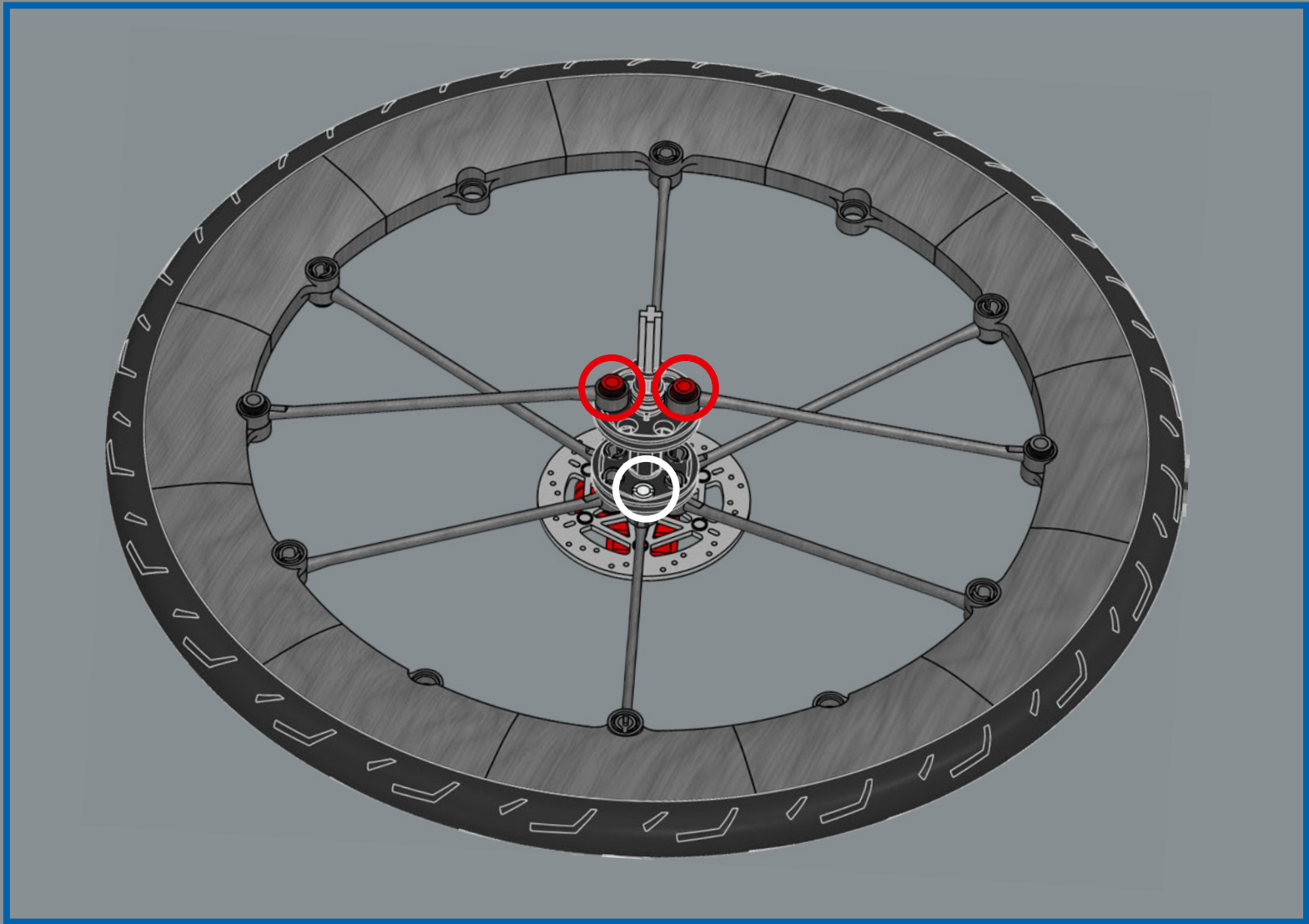

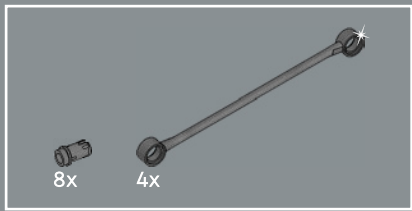

305

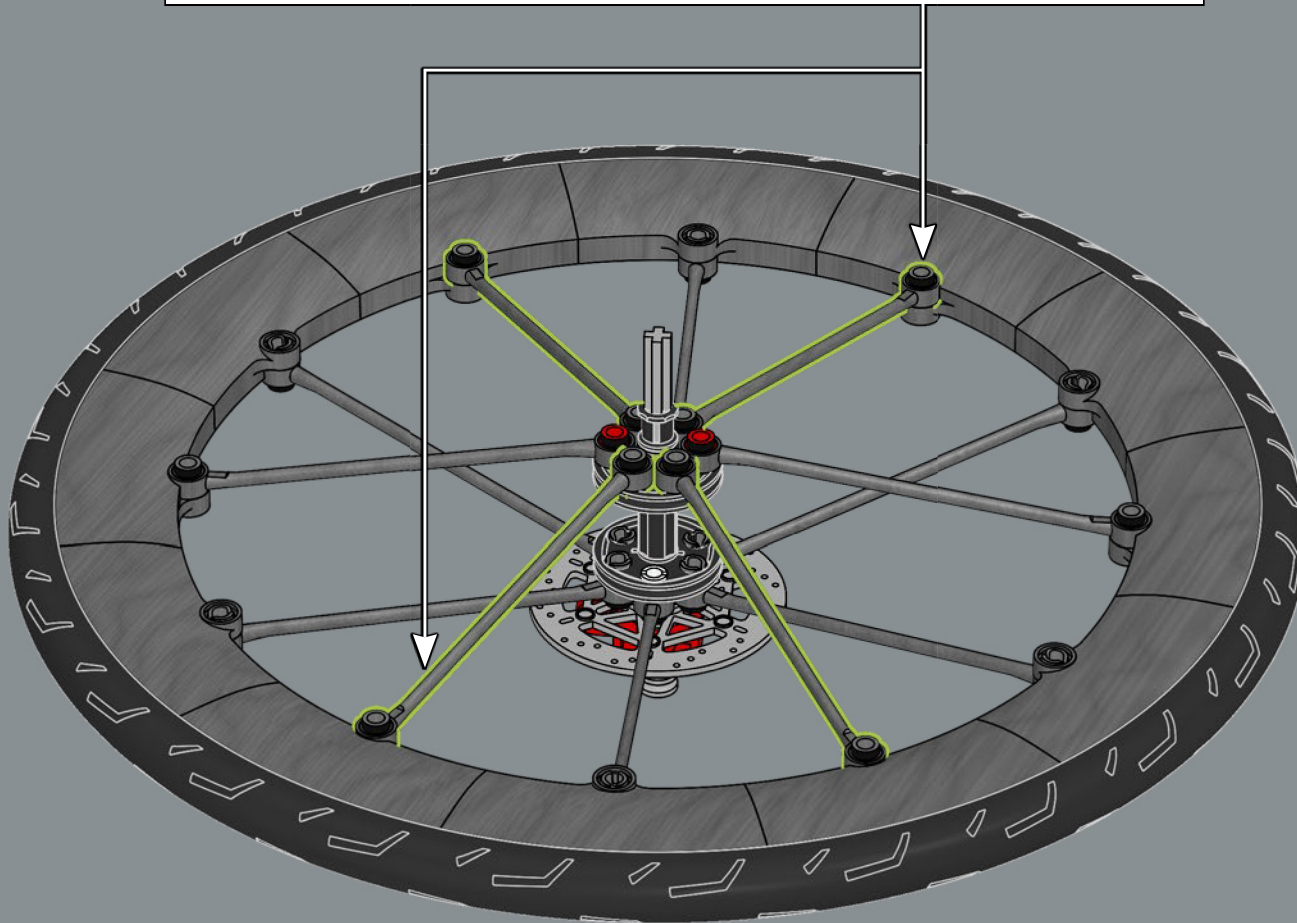
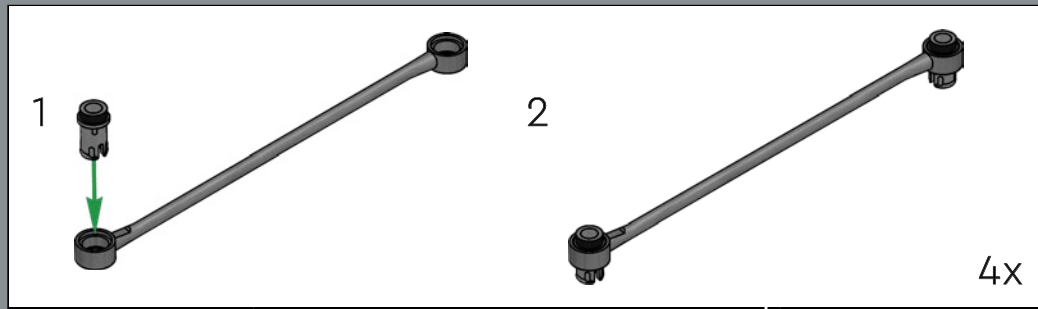

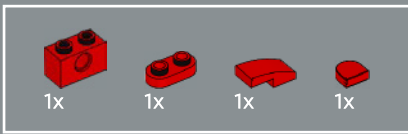

306

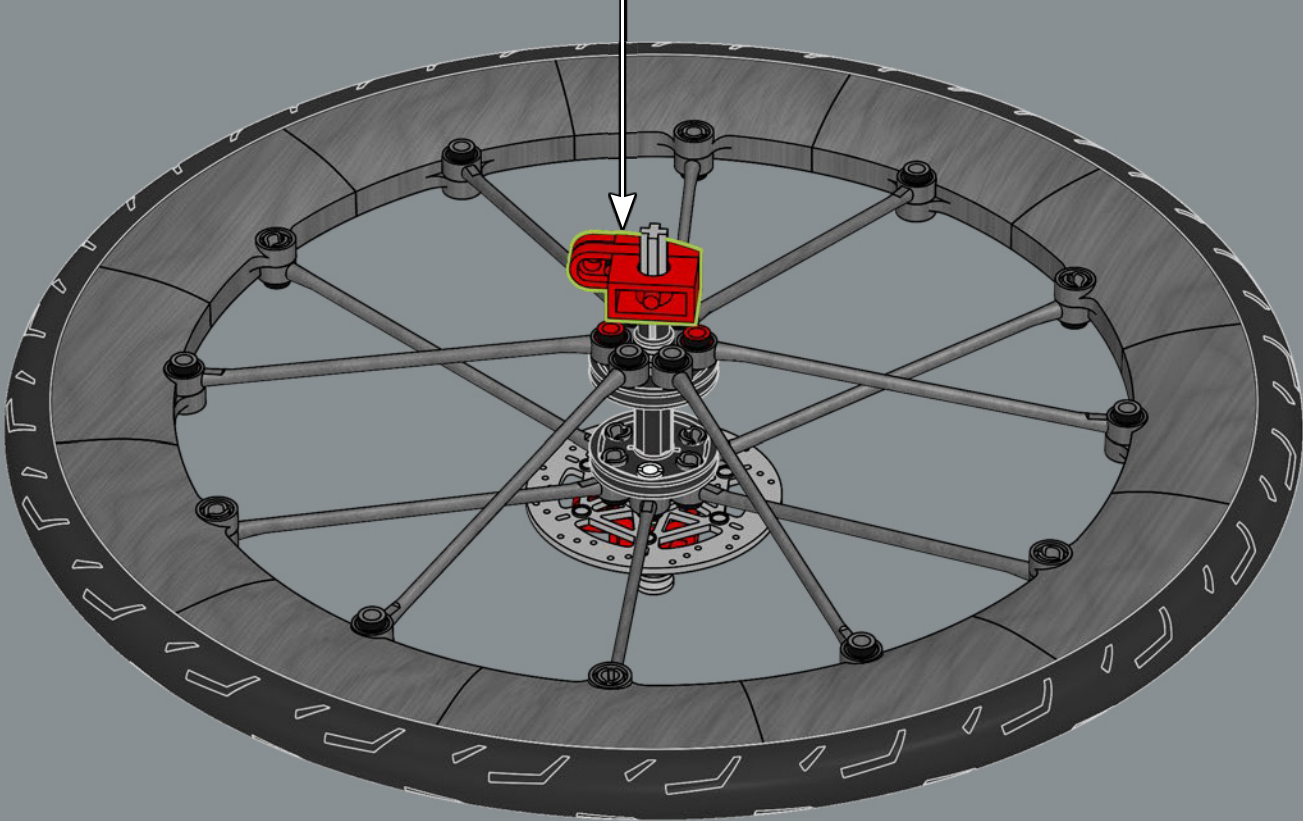
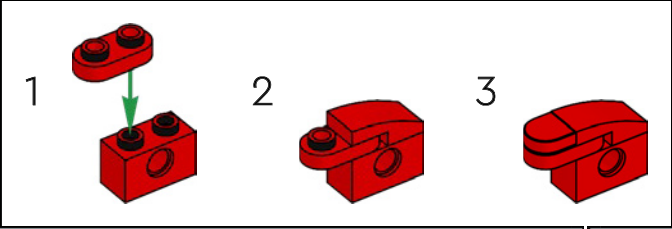



2x

307



2x

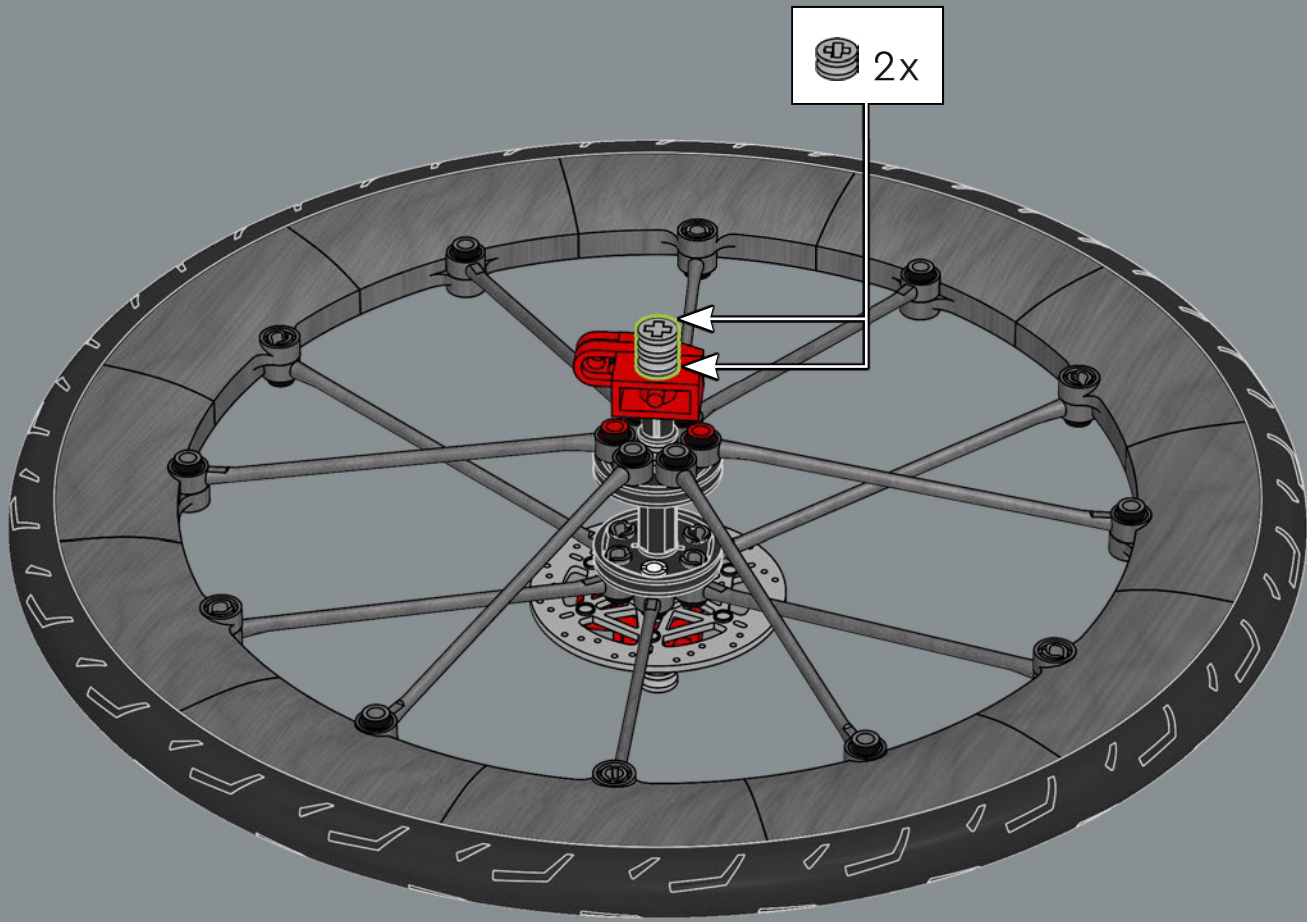

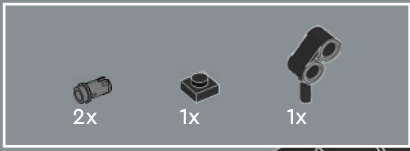

309

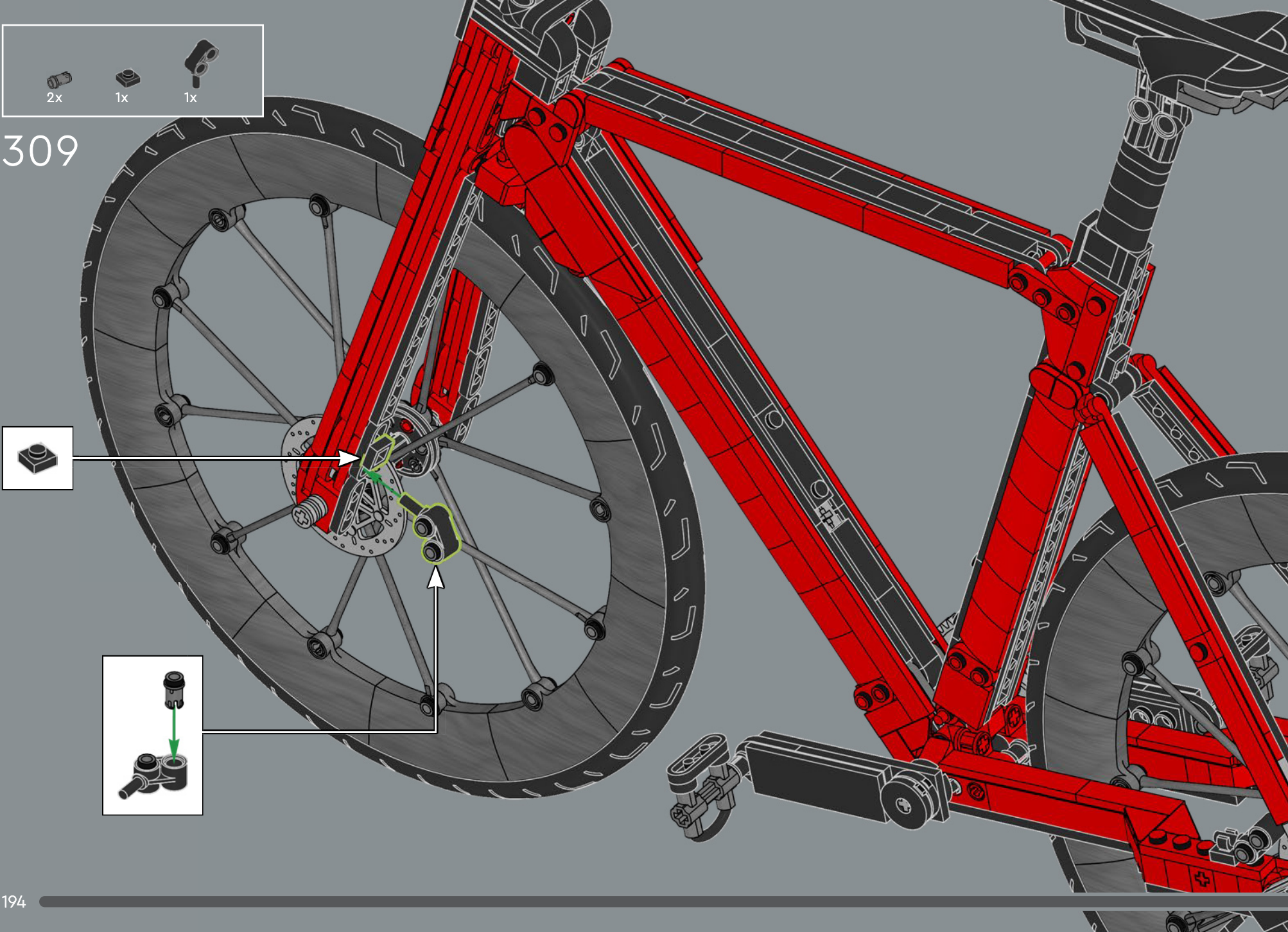
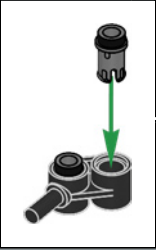

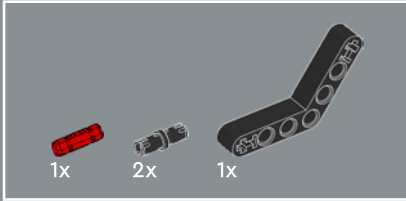
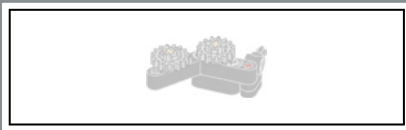

310

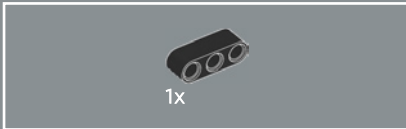
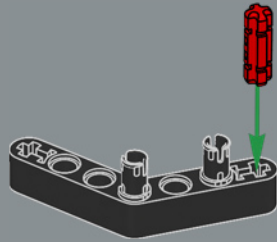

311

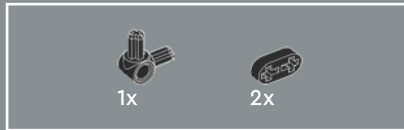
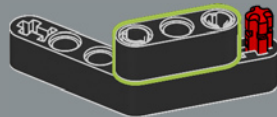

312

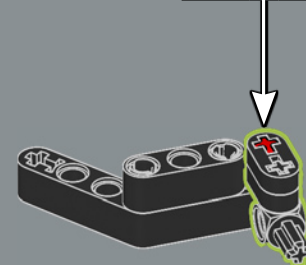
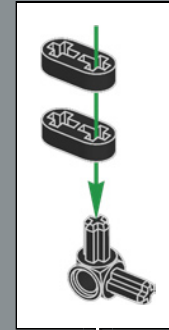



2x

313

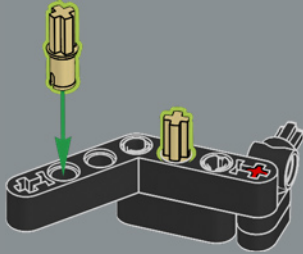

2x

314

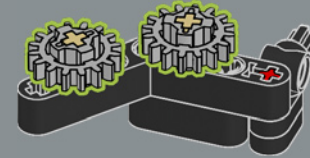

315

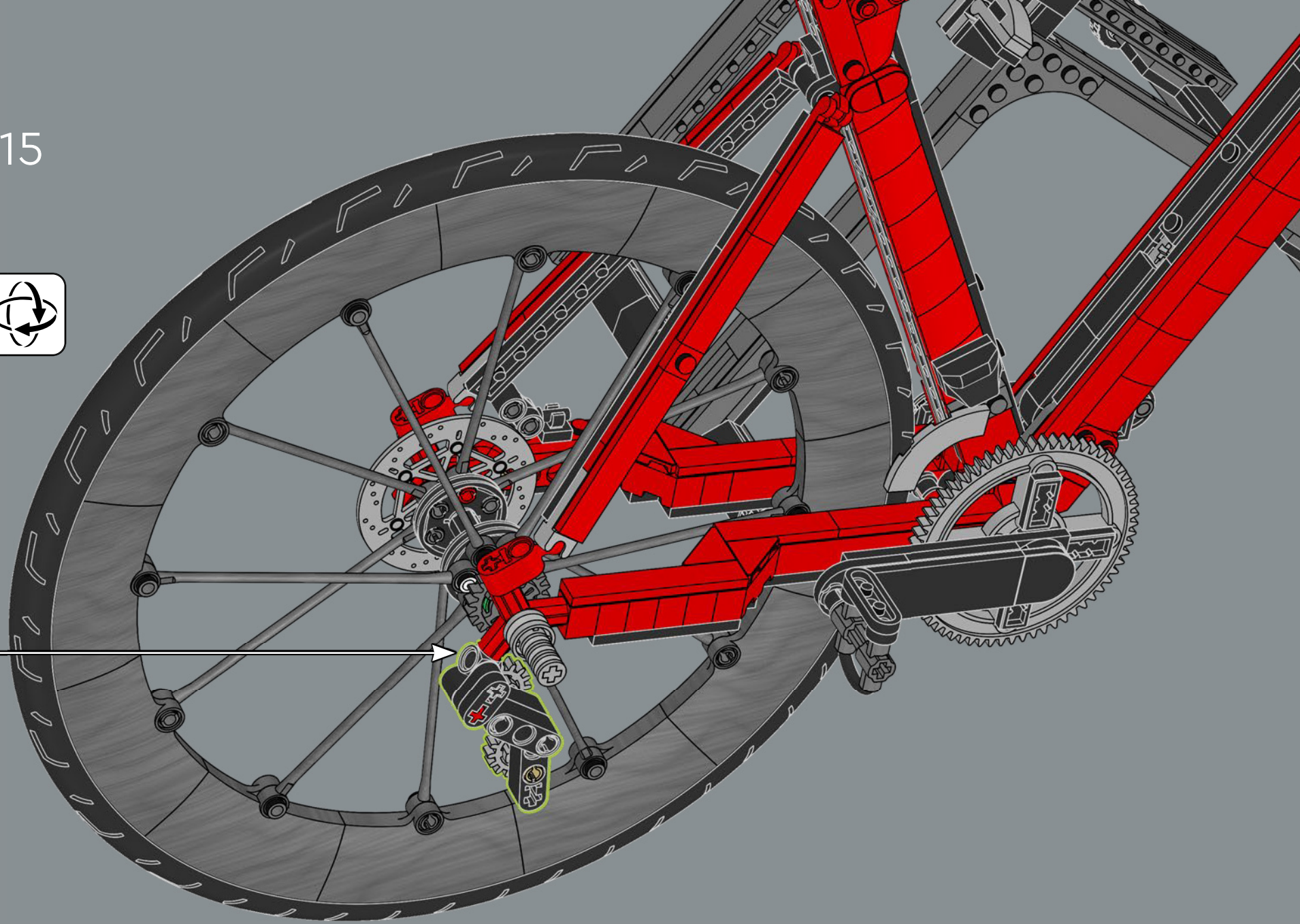



72x

316



For the first time, this chain element comes in silver metallic.

Pour la première fois, cet élément de chaîne est disponible en argent métallisé.

Por primera vez, este elemento de cadena viene en color plata metalizado.

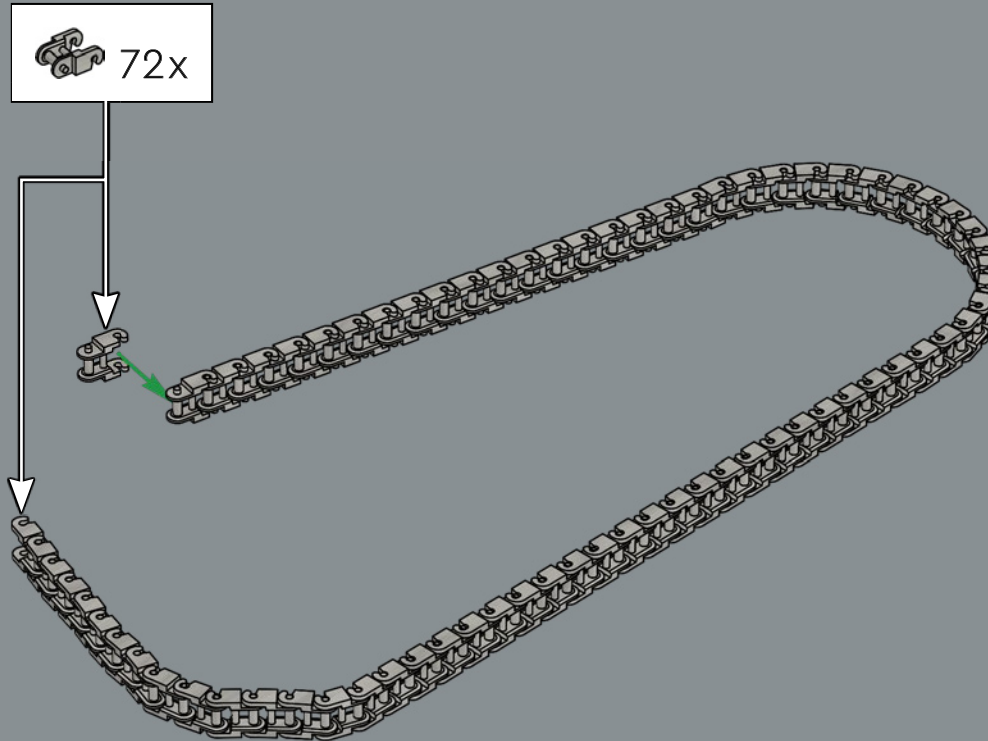

317

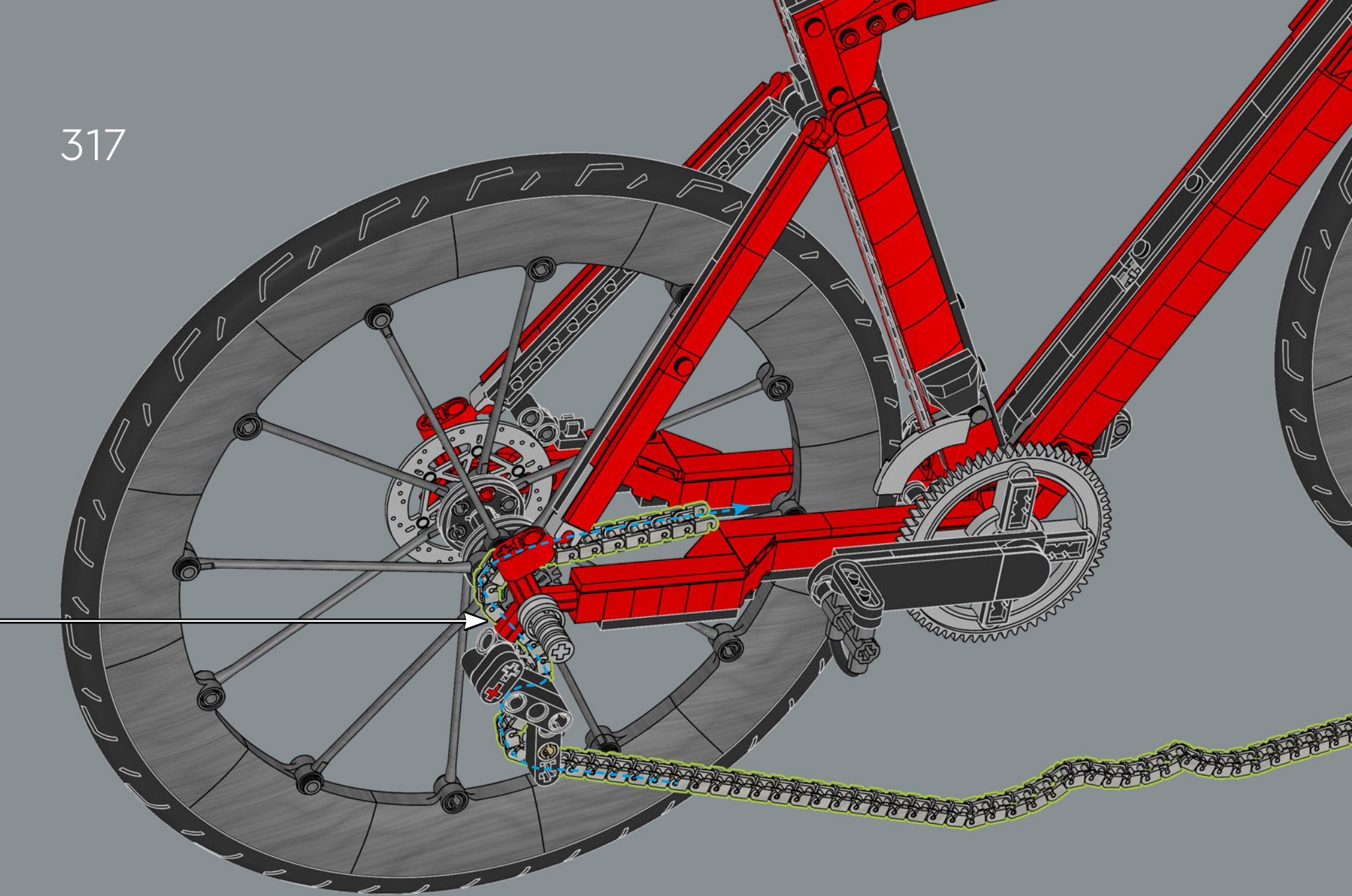

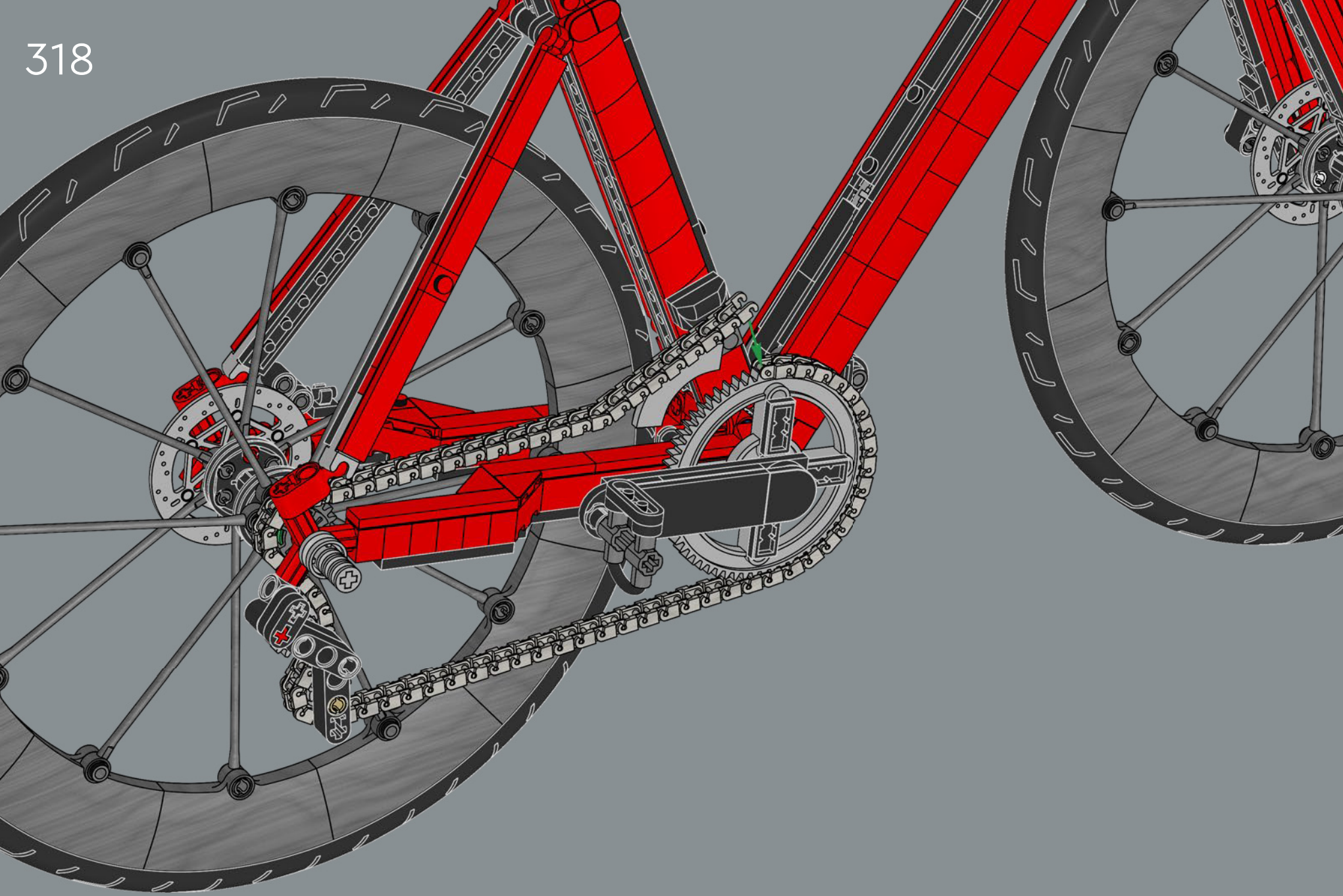

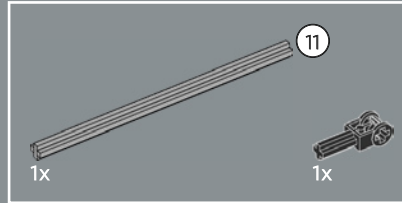
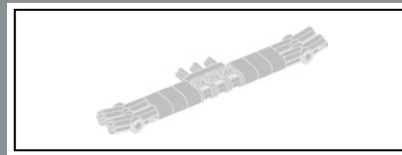

319

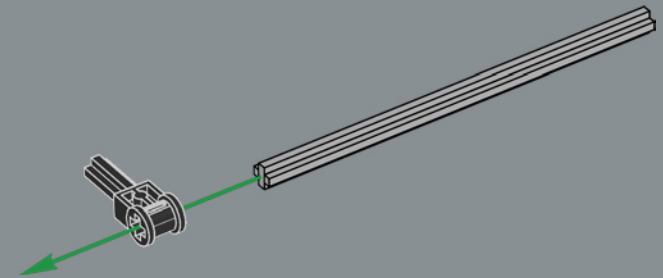

320

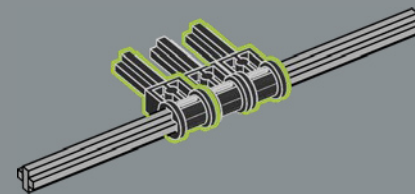



321

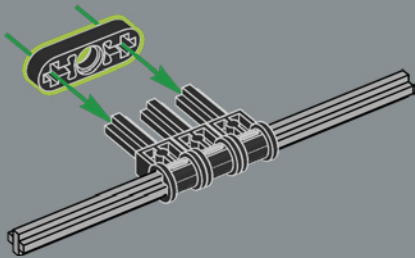

322

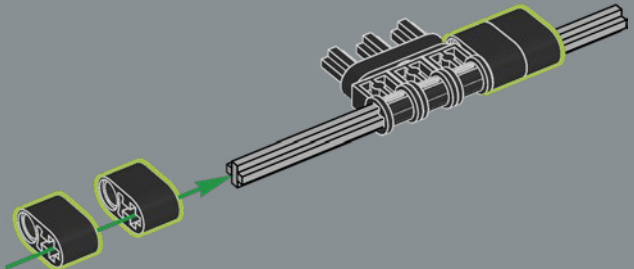

323

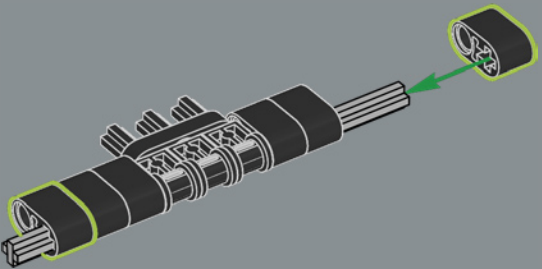



324

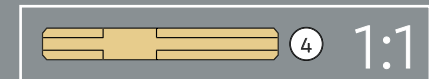
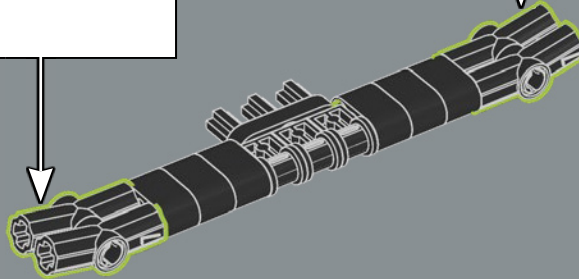
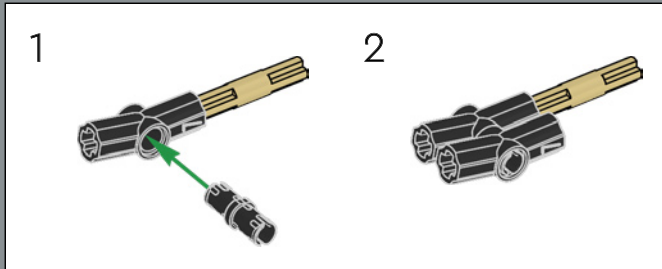
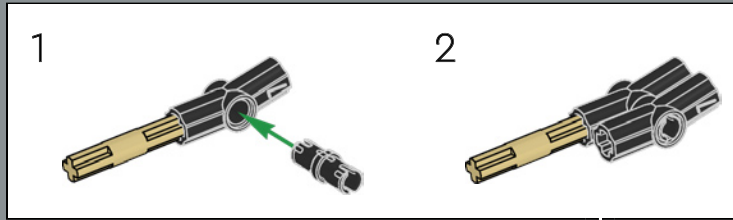

325

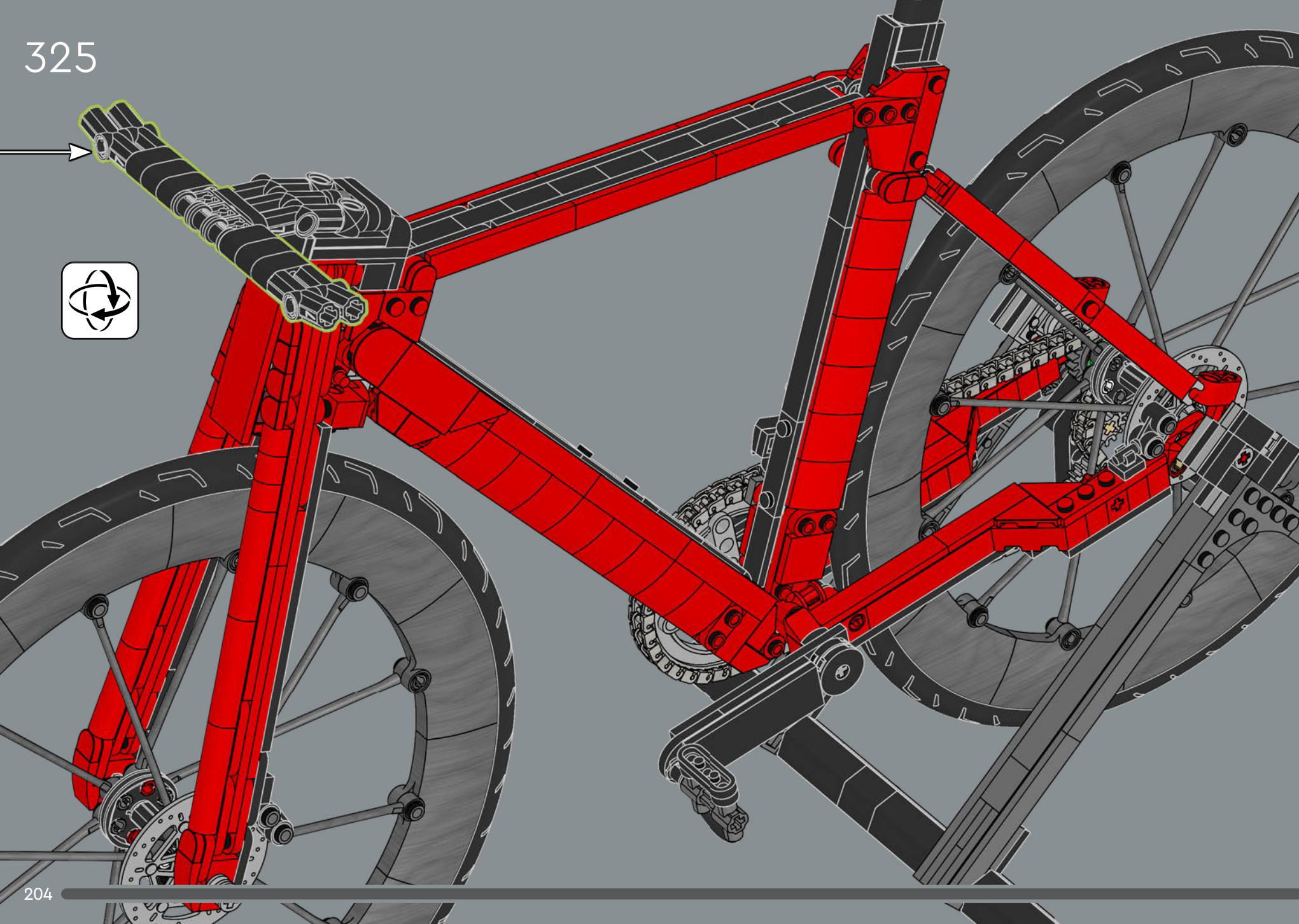

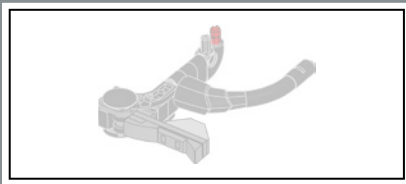

326

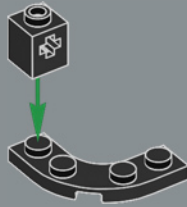

327

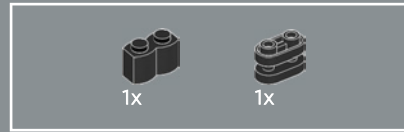

328

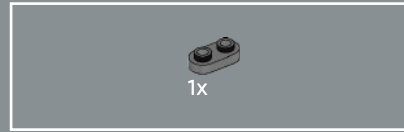
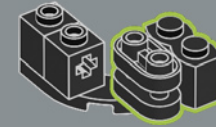

329

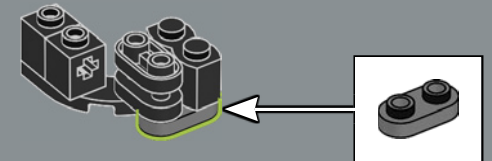



330

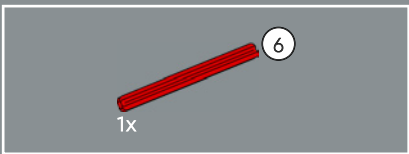
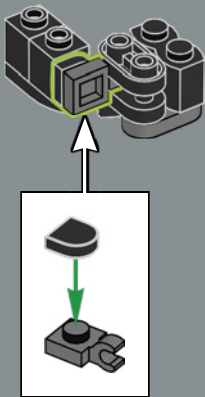

331

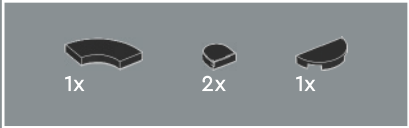
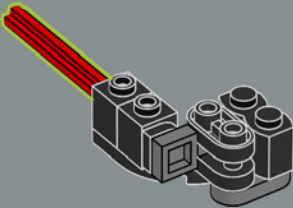

332

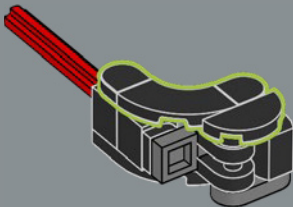



333

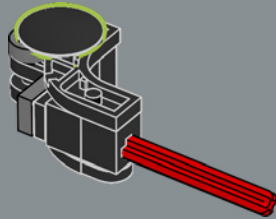

334

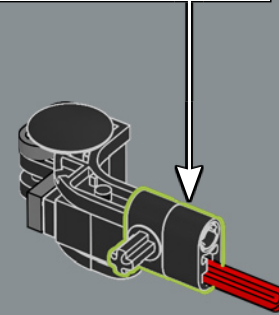
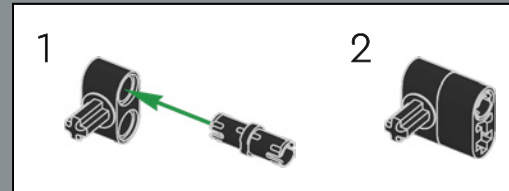

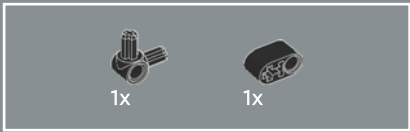

335

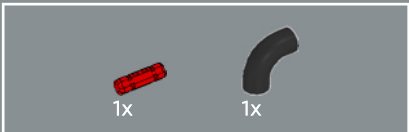
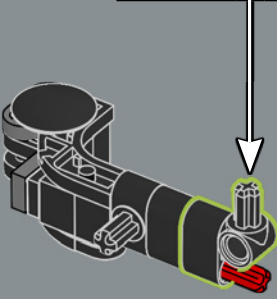
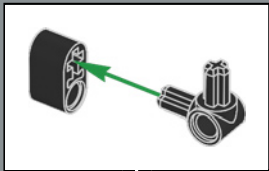

336

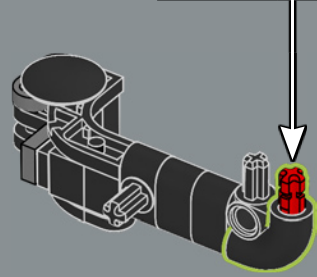
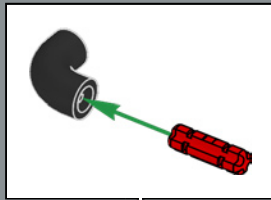

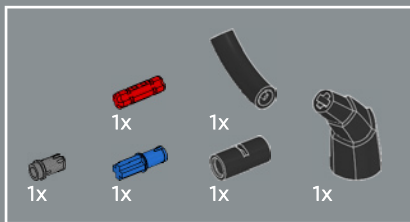

This element was made to represent dragon horns for LEGO® NINJAGO® sets – turns out, it also works great for road-bike handlebars!

Cet élément, conçu à l'origine pour représenter des cornes de dragon dans les ensembles LEGO® NINJAGO®, s'avère aussi parfait pour former le guidon d'un vélo de route!

Este elemento se creó para representar cuernos de dragón en los sets LEGO® NINJAGO®, ¡pero también funciona muy bien como parte de un manubrio de carreras!

337

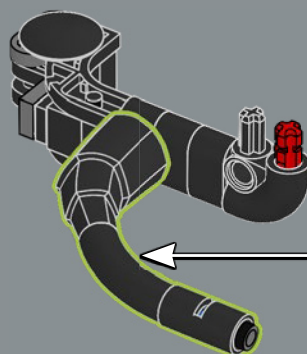
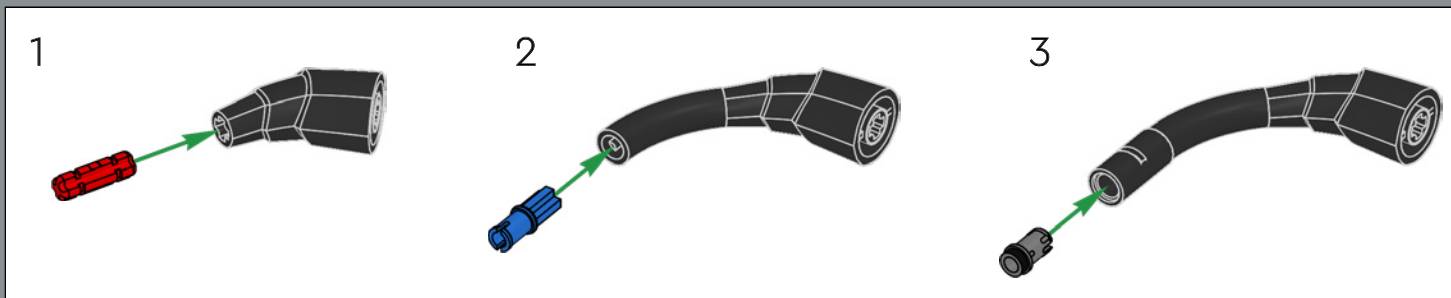

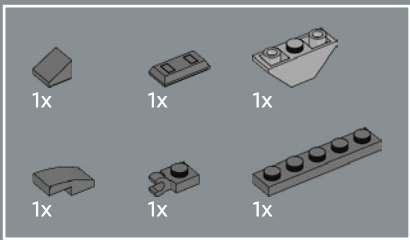

338

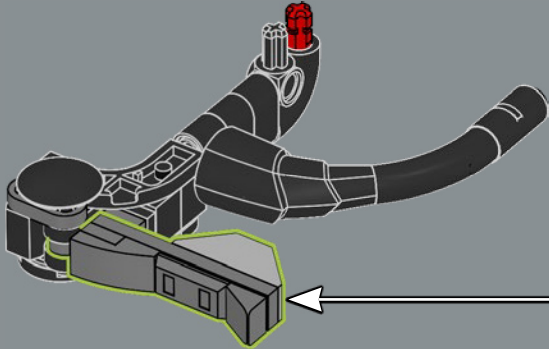
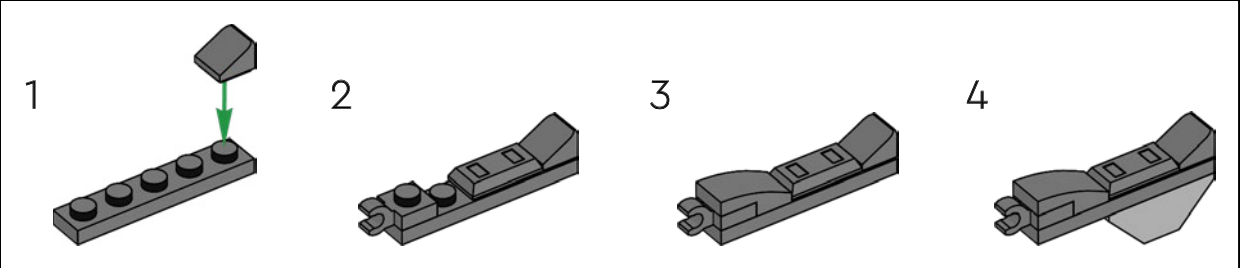

339

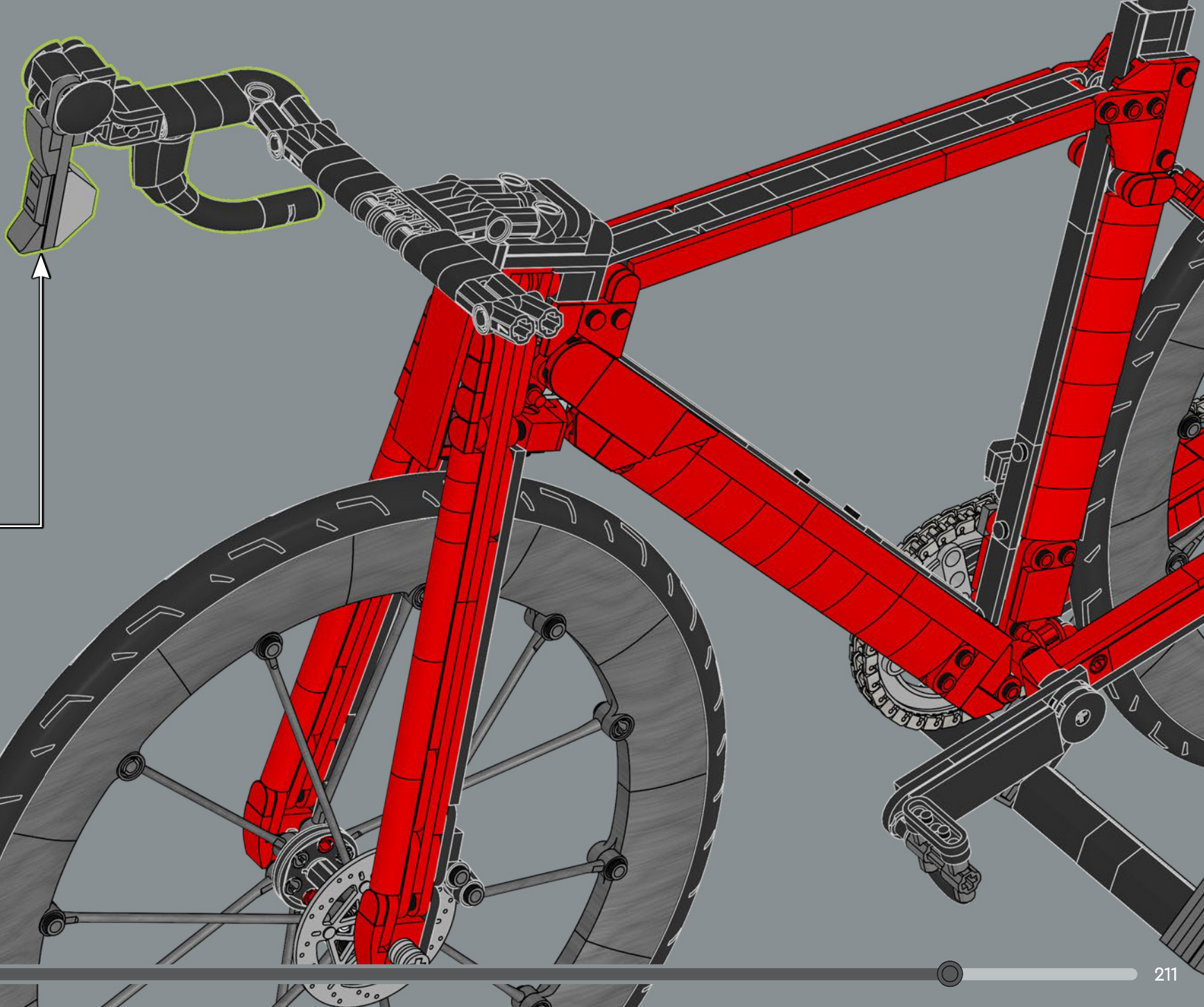

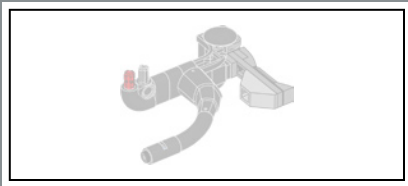

340

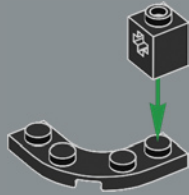

341

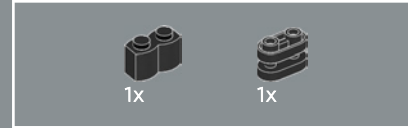

342





343

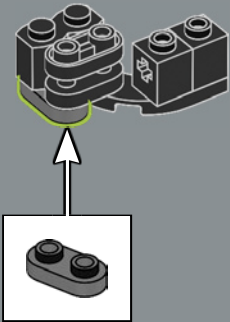

344

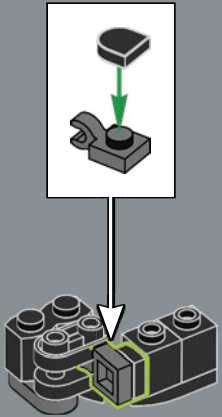

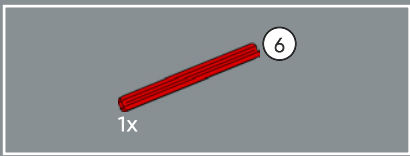

345

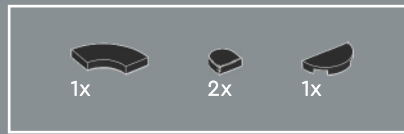
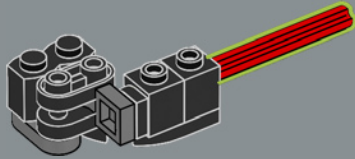

346

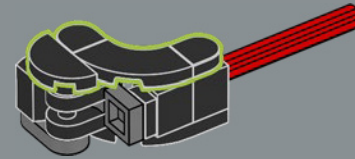



347

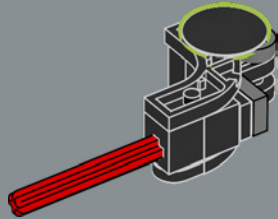

348

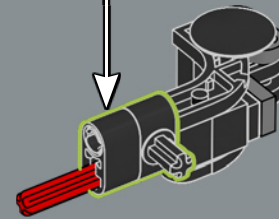
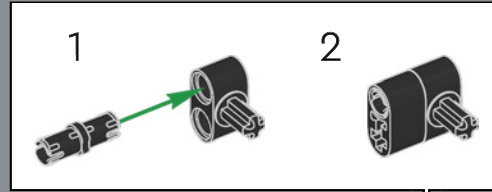

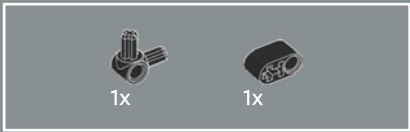

349

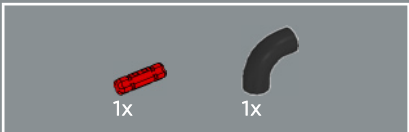
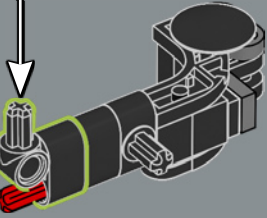
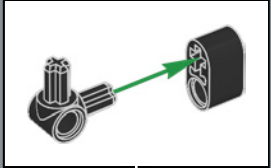

350

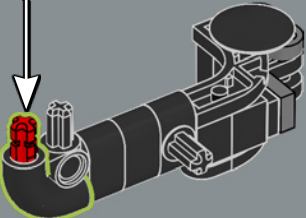
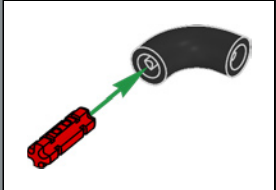

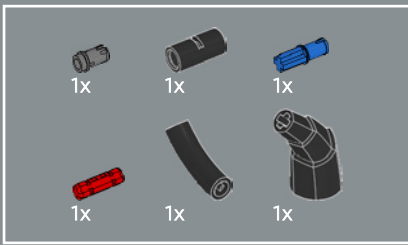

351

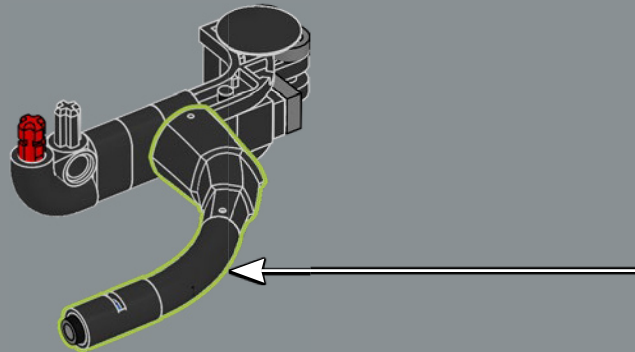
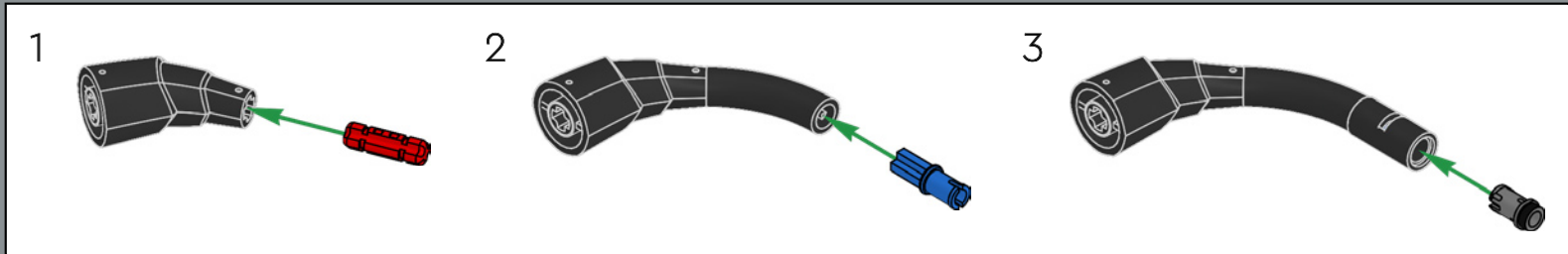

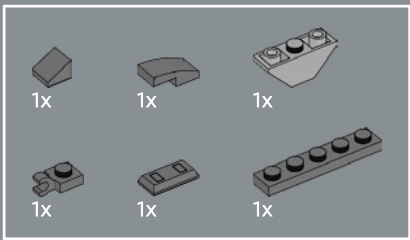

352

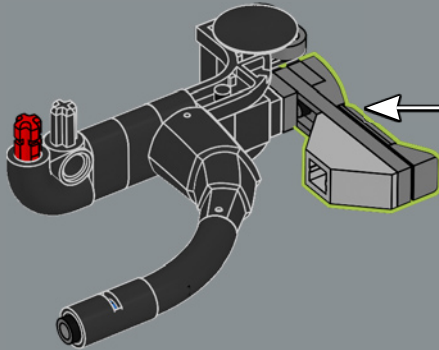
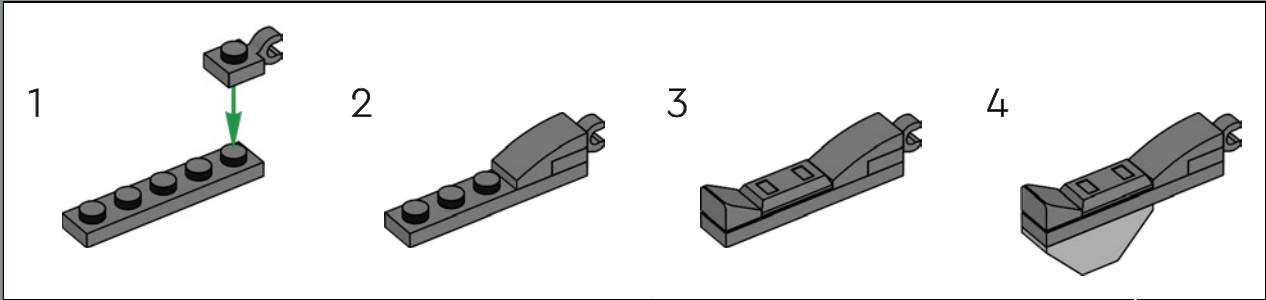

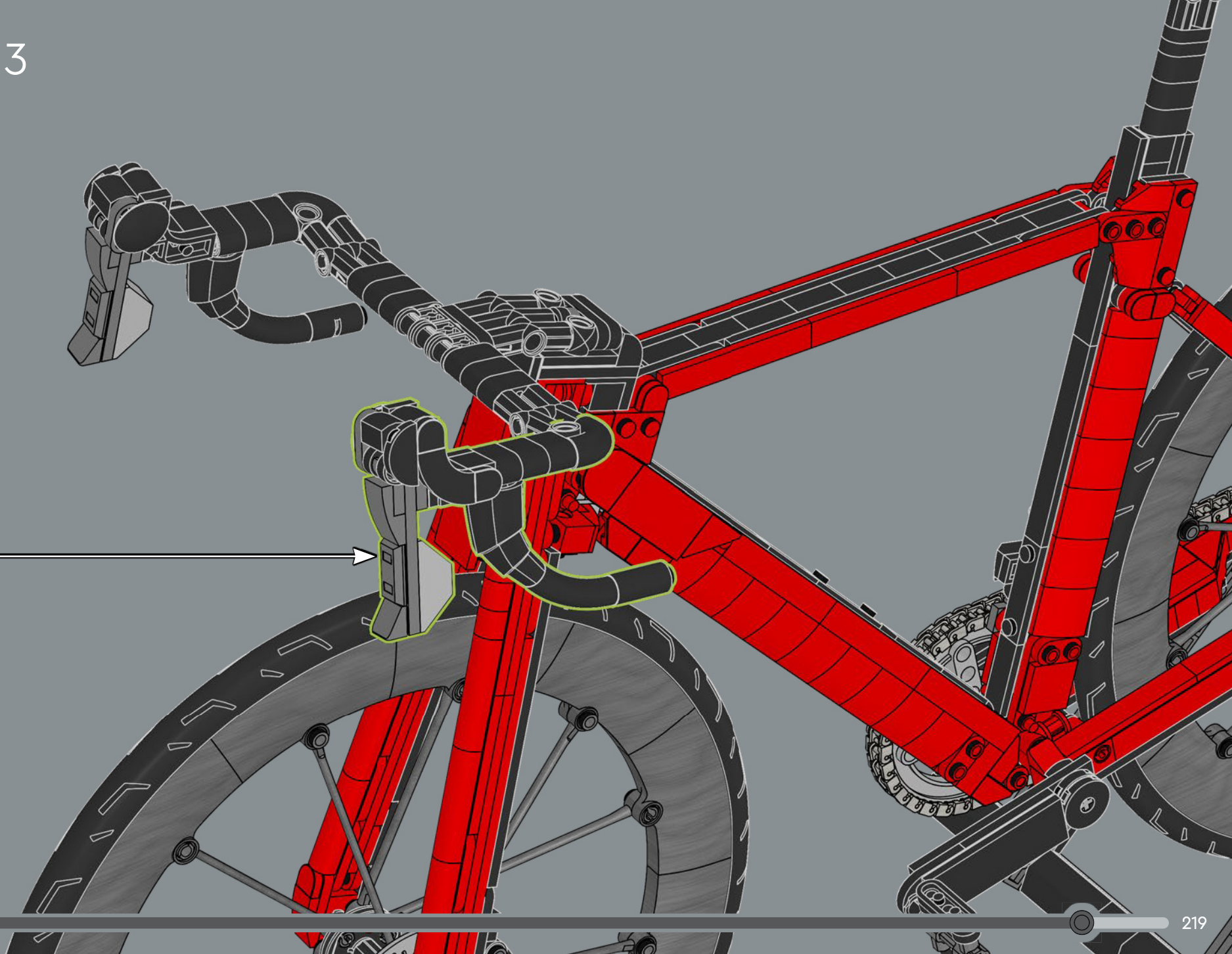

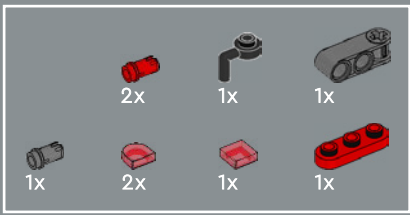

354

1

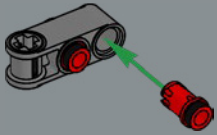

2

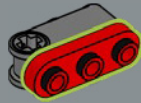

3

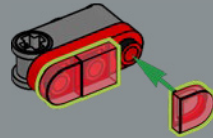

4

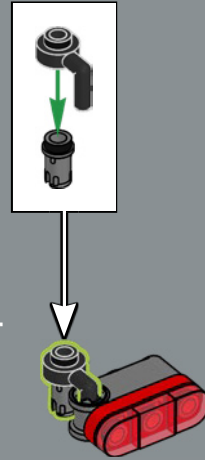

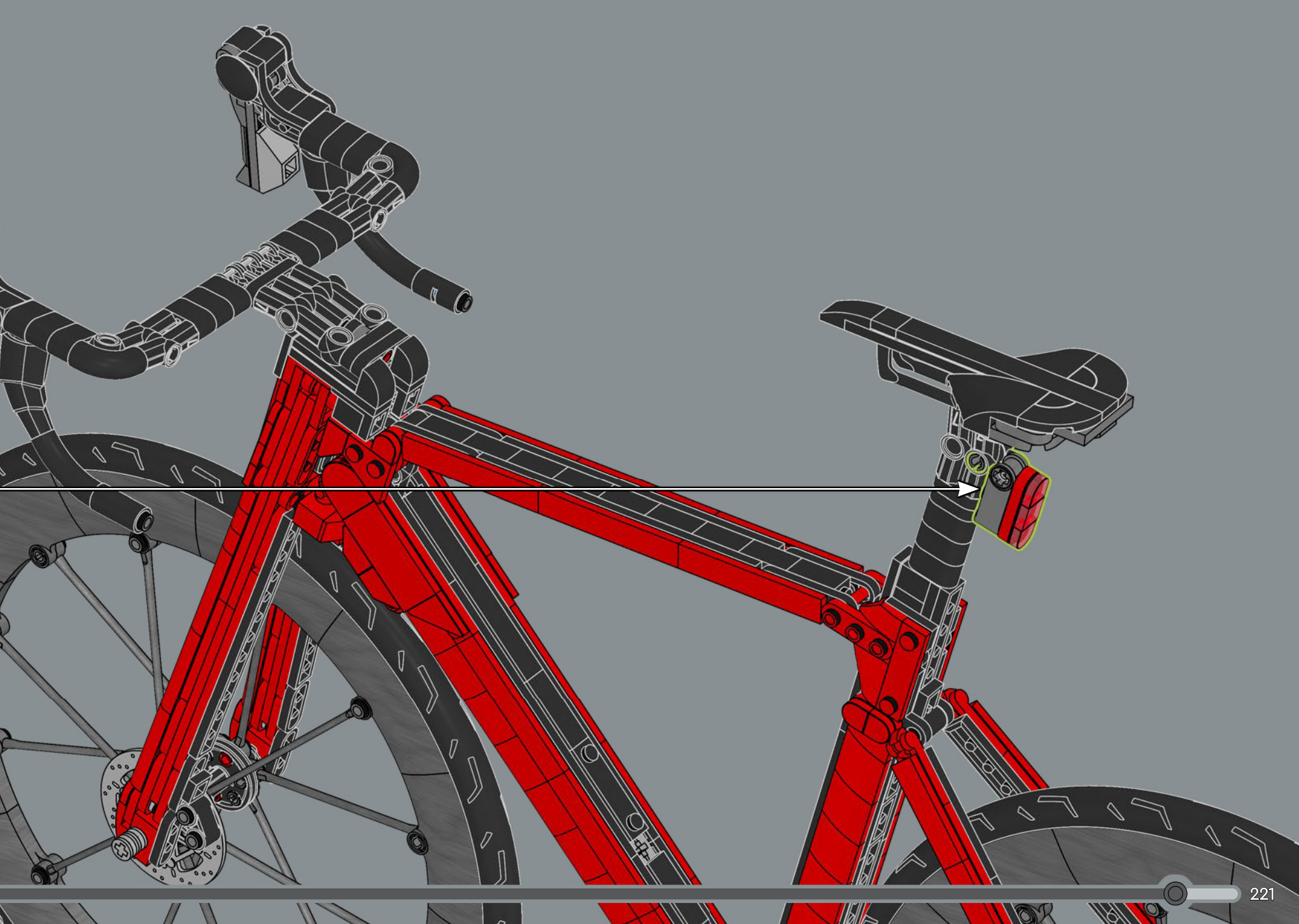

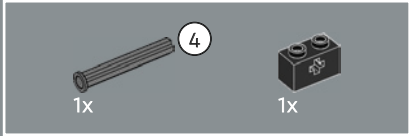
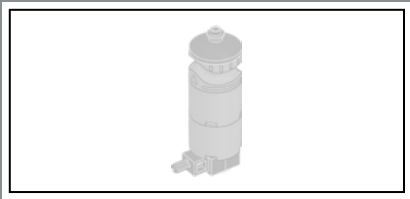

355

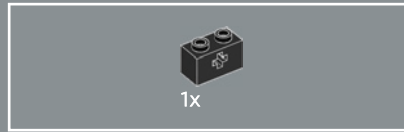
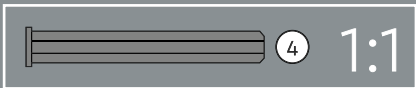
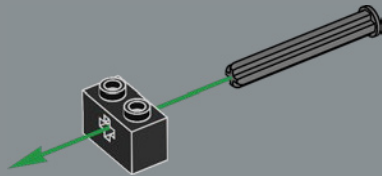

356

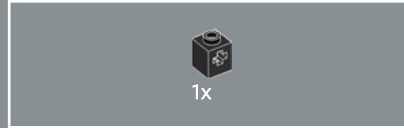
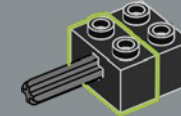

357

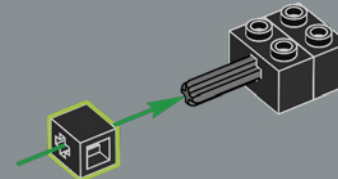

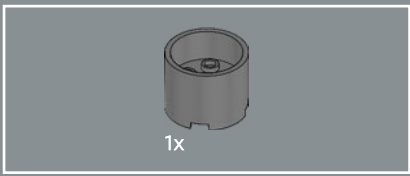

358

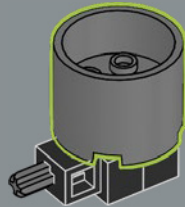

359

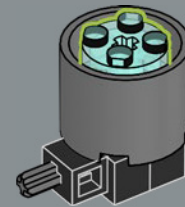

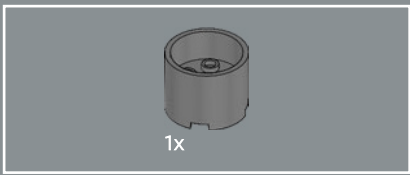

360



361

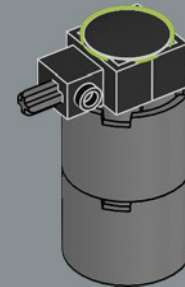

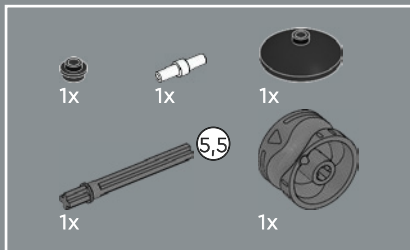

362

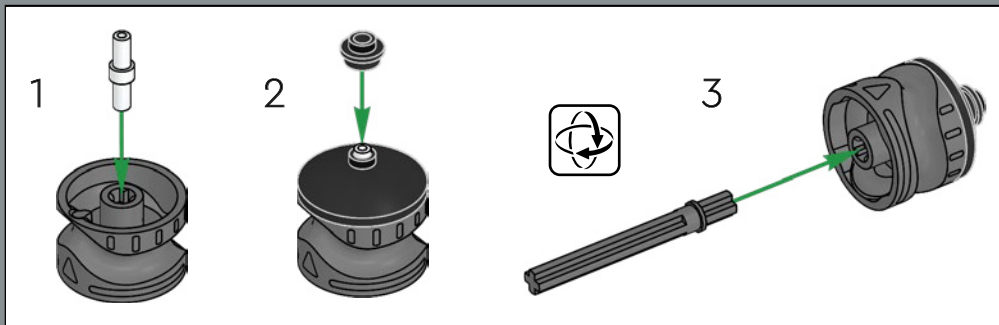

This element on the bottle is a gear shifter usually used in LEGO® Technic™ gear boxes.

L'élément fixé à la bouteille est un sélecteur de vitesses, habituellement utilisé dans les boîtes de vitesses LEGO® Technic™.

Este elemento de botella suele encontrarse como cambiador de velocidades en los mecanismos LEGO® Technic™.

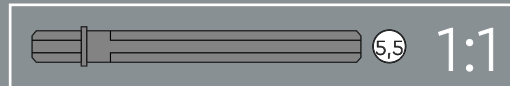
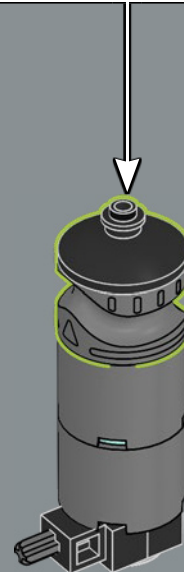

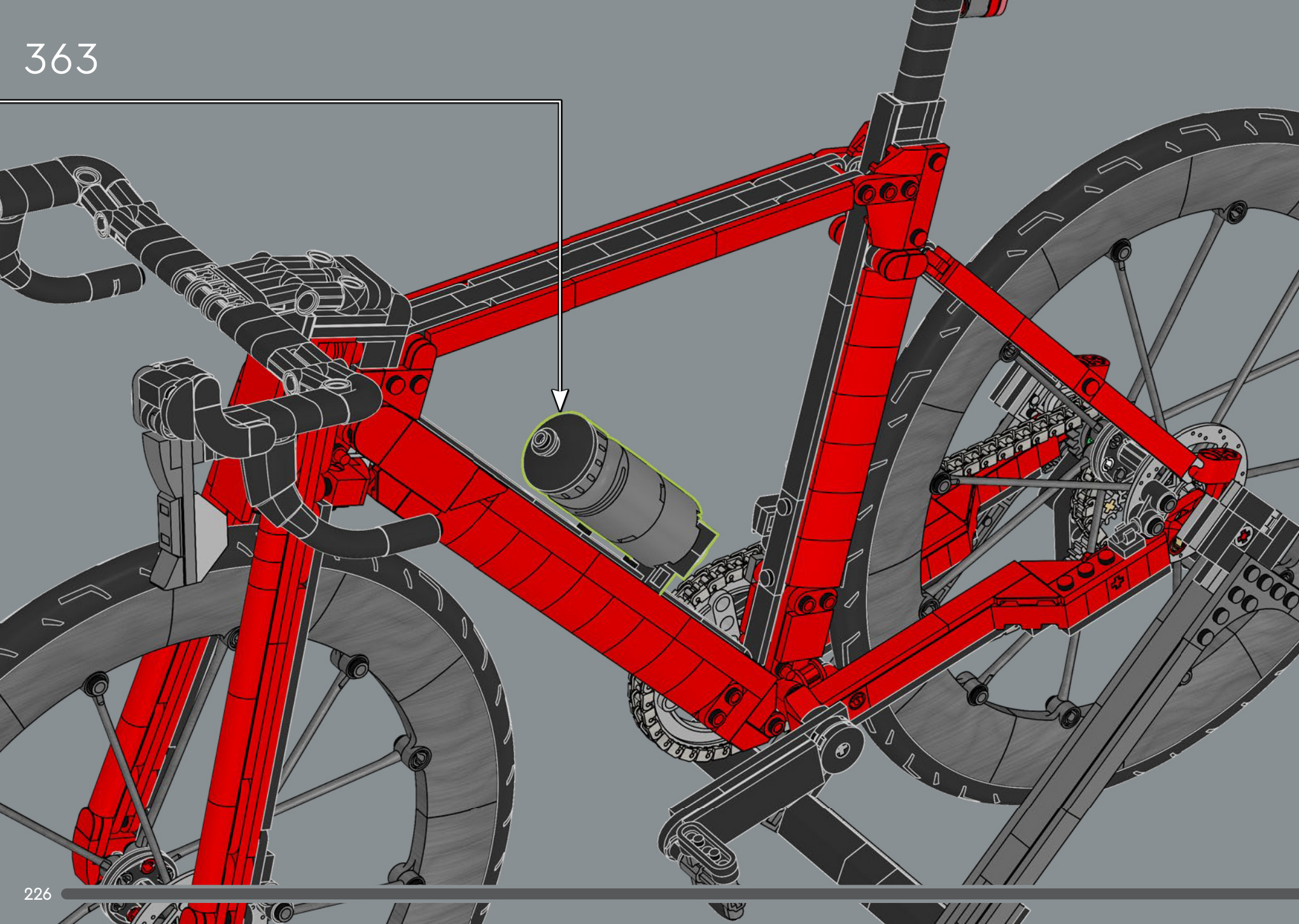

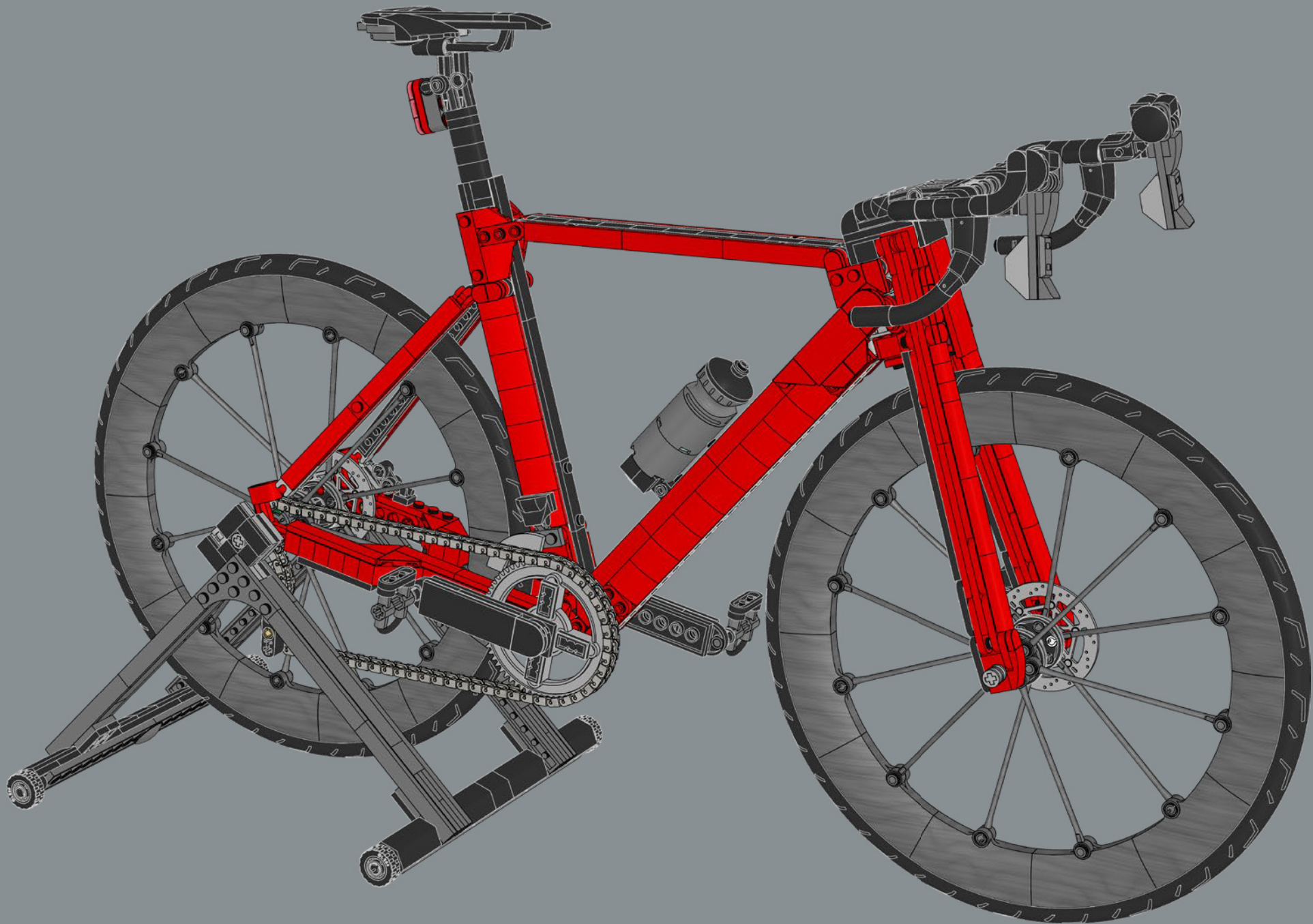

4x
6388018
1x
6357680



1x
4582543

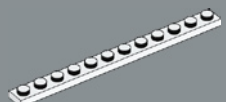

3x
4514842



1x
6013938



2x
4666579



2x
4666999



4x
6223427



3x
6439048



16x
6258973



34x
6378120



6x
6278441



7x
6473604



2x
4504379



4x
302421



1x
6397571

228

2x
6435047

5x
6510141

1x
6177505

1x
6177507

5x
6510127

1x
6141552

1x
6141553

22x
6210269

45x
4142865

1x
6513907

1x
6507845

2x
6167939

2x
6186398

2x
370021

4x
6029946

2x
306921

1x
6001806

2x
6545843

2x
6532099

6x
6351892

21x
6598629

2x
6540722

13x
6275080

1x
6209519

1x
6555339

30x
6105976

2x
302221

2x
306821

3x
4515365

2x
6362998

2x
6251410

5x
362321

2x
6494104

2x
6480856

4x
6598628

2x
302121

6x
6534946

4x
6256923

1x
370121

6x
243121

2x
4560179

3x
6371582

3x
6130002

1x
6398773

17x
4113858

2x
300921

1x
6335578

4x
346021

10x
447721

1x
302423

2x
4206482

3x
302323

2x
6299413

2x
371023

1x
6130009

1x
6168646

4x
6186675

2x
6473449

6x
6256435

4x
6332148

5x
302426

2x
6539387

7x
6344819

3x
307026

2x
6172383

9x
6228987

1x
6335388

2x
6335317

3x
6508269

4x
6291068

2x
6510214

2x
6510071

4x
6338428

2x
6173124

26x
6279875

5x
4278359

4x
403226

1x
6143850

3x
6099801

2x
6179182

2x
4644456

1x
6282140

2x
6535446

4x
6542617

13x
6265091

2x
4512363

4x
4617848

2x
6173119

6x
306926

2x
6347310

2x
6178922

1x
6069000

1x
6192309

5x
302326

1x
6542614

1x
6047276

1x
6375706

1x
6266207

4x
6092585

1x
6517779

2x
6586225

2x
6422988

13x
6428168

3x
6331723

4x
6323668

2x
6396457

2x
6470264

4x
6061032

2x
6133722

4x
6191630

2x
242026

1x
6321745

3x
4107765

1x
4552347

9x
6523971

1x
4142822

1x
6265644

1x
4180087

2x
362326

6x
4558170

1x
6572774

2x
317626

1x
6522834

8x
6428167

2x
6493691

1x
6162892

2x
371026

2x
6254045

8x
6439175

2x
6325190

1x
6522832

8x
4529155

2x
302026

6x
6350415

1x
6278125

8x
366626

4x
379526

2x
6318582

4x
416226

2x
373826

8x
447726

2x
273026

6x
4514845

2x
244526

2x
6507960

1x
6581817

1x
6514282

1x
6240515

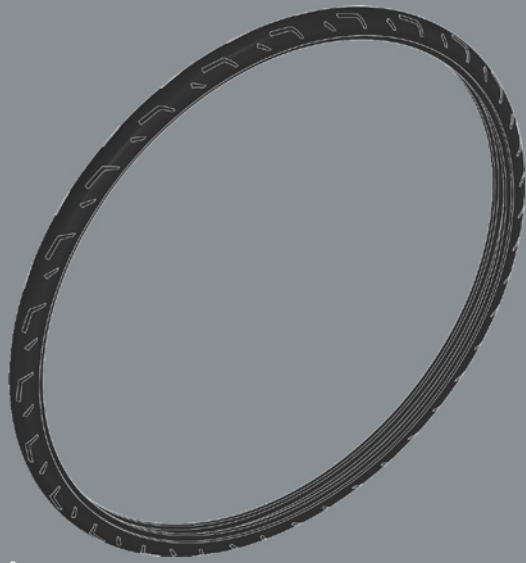

2x
6584779

1x
6267486

13x
6271165

2x
6168647

1x
4211758



 [LEGO.com/service](https://www.LEGO.com/service)

2x
6436419

8x
4211353

4x
4211397

2x
6043639

2x
4515369

1x
6282158

2x
6088708

2x
6456718

1x
6385740

3x
6549304

2x
6285654

1x
6576953

2x
4640536

2x
6144138

3x
4211639

1x
4211805

1x
4535768

1x
6178172

1x
4211705

66x
6395635

2x
4504378

1x
4210719

4x
6360111

7x
6221607

2x
4278274

4x
4211088

2x
6331866

2x
6029948

1x
6266248

1x
6215212

8x
6250018

1x
6576527

1x
6273715

2x
6411395

2x
6473422

1x
6598627

12x
4211001

1x
6039176

2x
6413109

4x
6310174

3x
6083620

1x
4508553

4x
6389443

8x
4211008

4x
4210678

4x
4210798

4x
6133611

72x
6576937

24x
6585275

24x
6584089

5

7

9

11

4

5,5



YOU COULD
WIN



**YOU COULD
WIN**

Your feedback will help shape the future development of this product series.

Visit:

**DU KÖNNTEST
GEWINNEN**

Dein Feedback trägt zur Weiterentwicklung dieser Produktreihe bei.

Geh auf:

**VOUS POURRIEZ
GAGNER**

Vos commentaires nous aideront à concevoir les futurs produits de cette gamme.

Visitez :

**POTRESTI
VINCERE TU**

La tua opinione ci aiuterà a migliorare la creazione futura di questa linea di prodotti.

Visita:

**PUEDES
GANAR**

Tu opinión contribuirá al futuro de esta serie de productos.

Visita:

轻松获奖

您的反馈将有助于我们在今后改进本产品系列。

请访问:

LEGO.com/productfeedback

You also have the chance to win a LEGO® set.

Terms and conditions apply.*

Außerdem hast du die Chance, ein LEGO® Set zu gewinnen.

Es gelten die Teilnahmebedingungen.*

Vous pourriez également gagner un ensemble LEGO®.

Des conditions s'appliquent.*

Hai anche la possibilità di vincere un set LEGO®.

Termini e condizioni sono applicabili.*

También tienes la oportunidad de ganar un set LEGO®.

Aplican términos y condiciones.*

您还有机会赢取乐高®套装。

条款和条件适用。*

*LEGO.com/productfeedback-terms



LEGO and the LEGO logo are trademarks of the/son des marques de commerce du/
son marcas registradas de LEGO Group. ©2026 The LEGO Group.

 6650288