



MINECRAFT

21595



LEGO® Builder



LEGO.com/sustainable-packaging



FR
DONNEZ
OU
RECYCLEZ



OU



OU



ASSOCIATION

MAGASIN

DÉCHÈTERIE

Adresses sur quefairedemesdechets.fr

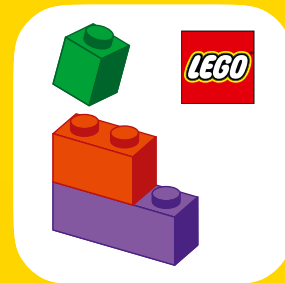

LEGO® Builder



BUILDER



Apple and the Apple logo are trademarks of Apple Inc., registered in the U.S. and other countries and regions. App Store is a service mark of Apple Inc. Google Play and the Google Play logo are trademarks of Google LLC. Tencent and the Tencent logo are trademarks of Tencent Inc.

LEGO.com/devicecheck

EN Ask parents' permission before going online | **DE** Eltern um Erlaubnis bitten, bevor du online gehst | **FR** Demande l'autorisation d'un parent avant d'aller en ligne | **IT** Chiedi il permesso ai tuoi genitori prima di andare online | **ES** Pídeles permiso a tus papás antes de conectarte a Internet | **PT** Pede autorização aos teus pais antes de ficares online | **ZH** 上网前应先征得父母的同意 | **PL** Poproś rodziców o zgodę, zanim wejdiesz do Internetu | **CS** Než půjdeš na internet, požádej rodiče o svolení | **SK** Skôr než pôjdeš na internet, vypýtaj si povolenie od rodičov | **HU** Kérj szülői engedélyt, mielőtt online csatlakoznál! | **UA** Запитуйте дозволу батьків, перш ніж користуватися інтернетом | **RO** Cere permisiunea părinților înainte de a te conecta online | **BG** Поискайте разрешение от родител, преди да влезете онлайн | **LV** Pirms došanās tiešsaistē palūdz atļauju vecākiem | **ET** Enne Interneti kasutamist küsi vanematelt luba | **LT** Prieš prisijungdami prie interneto, atsiklauskite tėvų | **TR** İnternete girmeden önce anne babandan izin iste

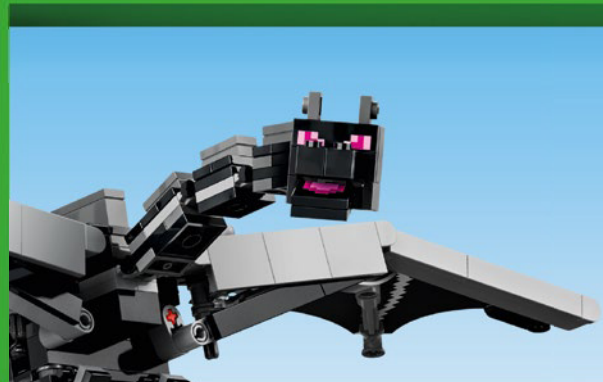
LEGO**MINECRAFT****UNLOCK IN-GAME ITEM**

1 SCAN THE QR CODE AND FOLLOW THE STEPS



Unlock in-game item
 Gegenstand im Spiel freischalten
 Débloquez un objet dans le jeu
 Sblocca oggetto in-game
 Desbloquee un objeto dentro del juego
 Desbloquee um item no jogo
 解锁游戏中的道具
 Odblokuj przedmiot w grze
 Odemkněte předmět ve hře
 Odomknite herný predmet
 Szerez kiegészítőt a videójátékhoz!
 Розблокуйте ігровий предмет
 Deblochează un element din joc
 Отключване на елемент в играта
 Atslēdz spēles elementu
 Ava māngusisene ese
 Atrakinkite žaidimo elementą
 Oyun içi eşyanın kilidini açın

1 Scan the QR code and follow the steps
 1 Scanne den QR-Code und folge der Anleitung
 1 Scannez le QR code et suivez ces étapes
 1 Scansiona il codice QR e segui i passaggi
 1 Escanea el código QR y sigue los pasos
 1 Faça scan do código QR e siga os passos
 1 扫描二维码并按步骤操作
 1 Zeskanuj kod QR i wykonaj opisane kroki
 1 Naskenujte QR kód a postupujte podle návodu
 1 Naskenujte QR kód a postupujte podľa pokynov
 1 Olvasd be a QR-kódot és kövesd a lépéseket!
 1 Проскануйте QR-код та виконайте дії
 1 Scanează codul QR și urmează pașii
 1 Сканирайте QR кода и следвайте стъпките
 1 Skenē QR kodu un veic šīs darbības
 1 Skaneeri QR-kood ja järgi edasisi samme
 1 Nuskaitykite QR kodą ir atlikite reikiamus veiksmus
 1 Karekodu tarayin ve adımları izleyin

**ASK PARENTS' PERMISSION
BEFORE GOING ONLINE**

TERMS AND CONDITIONS APPLY

**OFFER NOT
AVAILABLE IN CHINA**

2

**SIGN IN/UP AND CLAIM
YOUR CODE TO REDEEM**

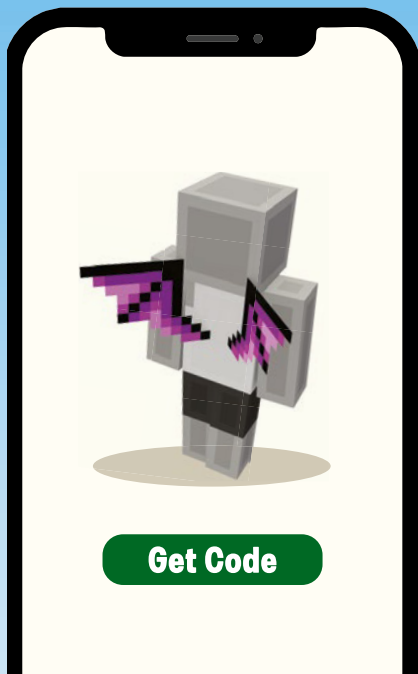

Get Code

Ask parents' permission before going online
Eltern um Erlaubnis bitten, bevor du online gehst
Demande l'autorisation d'un parent avant d'aller en ligne
Chiedi il permesso ai tuoi genitori prima di andare online
Pídeles permiso a tus papás antes de conectarte a Internet
Pede autorização aos teus pais antes de ficares online
上网前应先征得父母的同意

Poprosz rodziców o zgodę, zanim wejdiesz do Internetu
Než pójdeš na internet, požádej rodiče o svolení
Skôr než pôjdeš na internet, vypýtaj si povolenie od rodičov
Kérj szülői engedélyt, mielőtt online csatlakoznál!
Запитуйте дозволу батьків, перш ніж користуватися інтернетом
Cere permisiunea părinților înainte de a te conecta online
Поискайте разрешение от родител, преди да влезете онлайн
Pirms došanās tiešsaistē palūdz atļauju vecākiem
Enne Interneti kasutamist küsi vanematelt luba
Prieš prisijungdami prie interneto, atsi klauskite tėvų
internete girmeden önce anne babandan izin iste

Terms and Conditions apply
Es gelten die Teilnahmebedingungen.
Offre soumise à conditions
Termini e condizioni sono applicabili
Sujeto a Términos y Condiciones
Aplicam-se Termos e Condições
《条款和条件》适用
Obowiązują Regulamin
Plati všeobecné smluvní podmínky
Platia všeobecné zmluvné podmienky
A Felhasználási feltételek érvényesek.
Застосовуються Умови та положення
Se aplică termenii și condiții
Прилагат се правила и условията
Ir spēkā noteikumi un nosacījumi
Kehtivad tingimused
Taikomos sąlygos
Şartlar ve Koşullar geçerlidir

Offer not available in China
Das Angebot ist in China nicht verfügbar
Offre non disponible en Chine
Offerta non disponibile in Cina
Oferta no disponible en China
Oferta não disponível na China
中国是对象外です
优惠不适用于中国
중국에서는 본 제안이 적용되지 않습니다
Oferta nie jest dostępna w Chinach
Nabídka neplatí v Číně
Ponuka nie je k dispozícii v Číne
Az ajánlat Kínában nem érhető el
Пропозиция недоступна в Китаї
Oferta nu este disponibilă în China
Предложението не е налично в Китай
Piedāvājums nav pieejams Ķīnā
Pakkumine pole Hiinas saadaval
Pasiūlymas nepasiekiamas Kinijoje
Kampanya, Çin'de geçerli değildir

- 2 Sign in/up and claim your code to redeem
- 2 Melde dich an/logge dich ein und hol dir deinen Code
- 2 Inscris-toi/connecte-toi et demande ton code bonus
- 2 Accedi/registrati e richiedi il tuo codice per riscattarlo
- 2 Inicia sesión/regístrate para recibir tu código y canjearlo
- 2 Registe-se ou inicie sessão e peça o seu código para resgatar
- 2 登录/注册并申请代码进行兑换
- 2 Zarejestruj się lub zaloguj i odbierz swój kod
- 2 Zaregistrujte se/prihlaste se a uplatnite svůj kód
- 2 Prihláste sa alebo si vytvorte účet a uplatnite svoj kód
- 2 Jelentkezz be/Regisztrálj, és igényeld a kódod a beváltáshoz!
- 2 Увійдіть/зарєєструйтесь та отримайте свій код активації
- 2 Conectează-te/inregistrează-te și revendică-ți codul pentru a-l folosi
- 2 Влезте в профила си/регистрайте се и потърсете вашия код, за да вземете
- 2 Piesakies/reģistrējies un saņem kodu, lai izmantotu
- 2 Liitu / logi sisse ja hangi lunastamiseks kood
- 2 Prisijunkite / užsiregistruokite ir gaukite kodą
- 2 Oturum açın/kaydolun ve kodunuzu alın

Get Code	获取编号	Obtine codul
Code erhalten	Zdobądź kod	Вземете код
Obtenir le code	Získat kód	Saņemt kodu
Ottieni il codice	Získat kód	Hangi kood
Obtener código	Kérem a kódot	Gaukite kodą
Obter código	Отримати код	Kodu Al

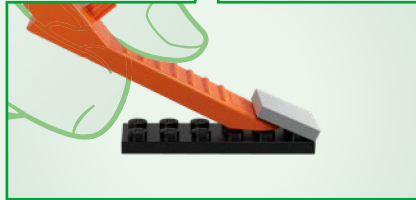
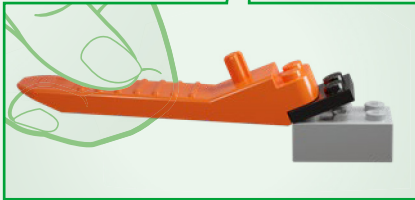
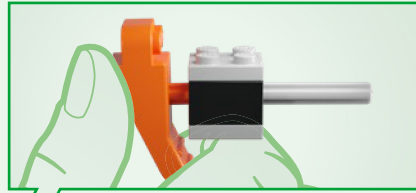
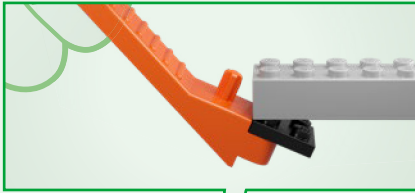

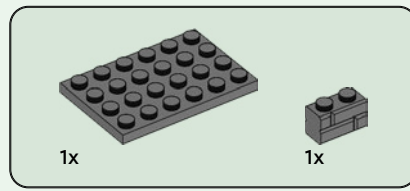

1

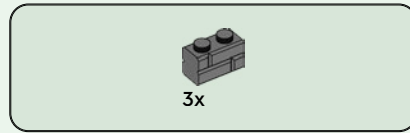
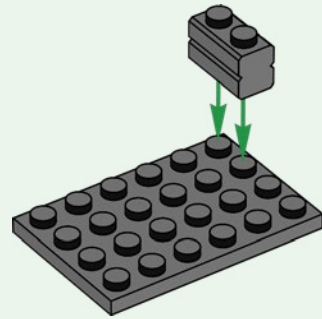

2

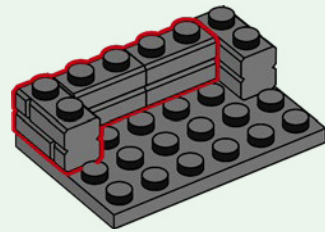

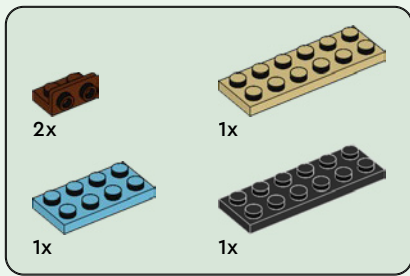

3

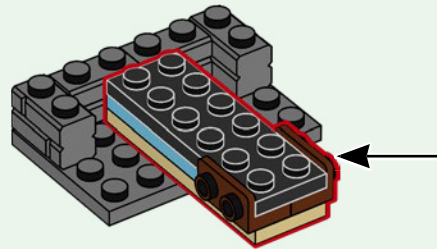
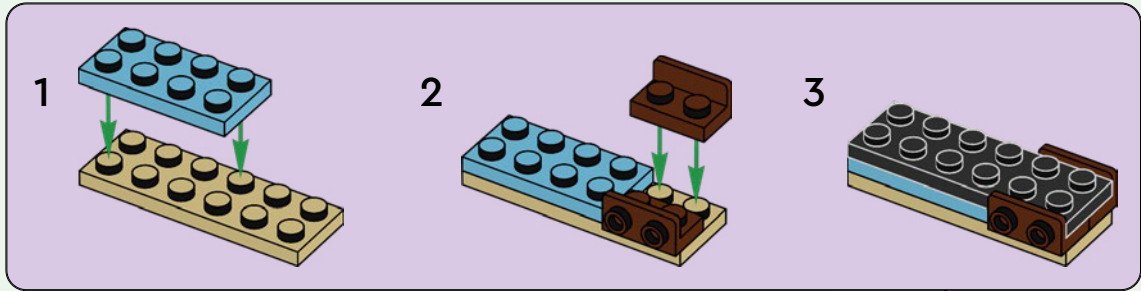

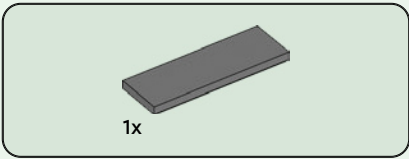

4

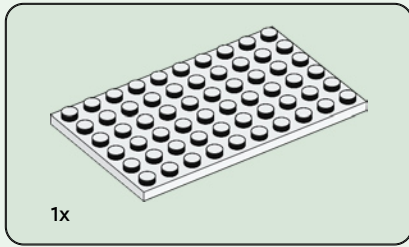
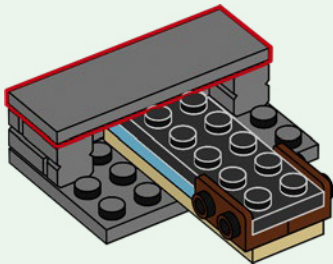

5

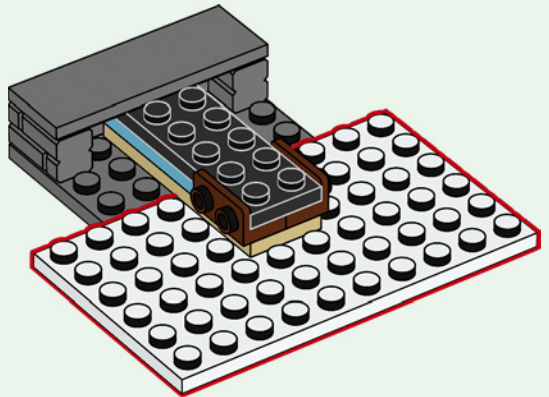

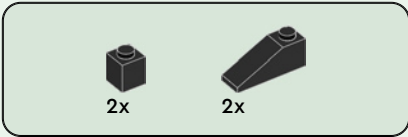

6

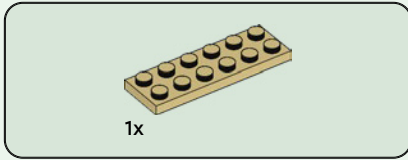
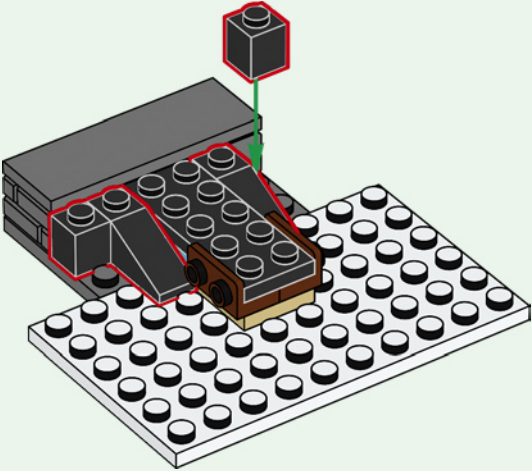

7

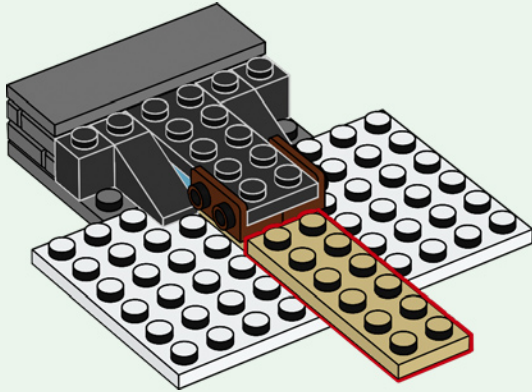

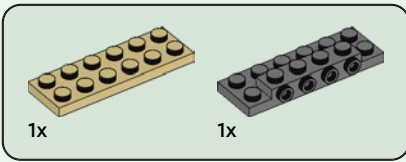

8

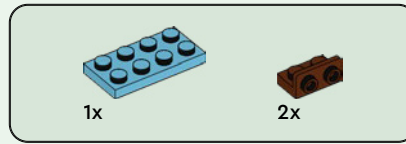
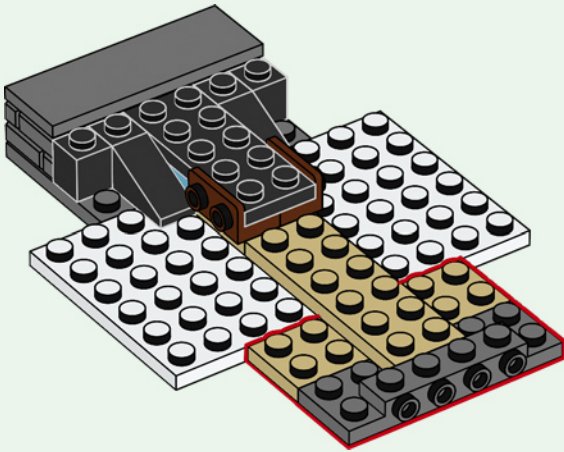

9

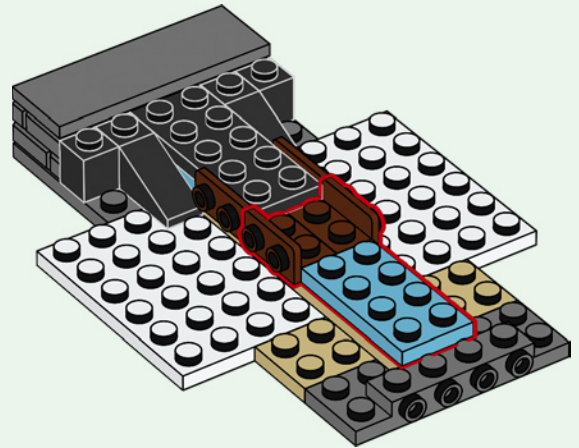

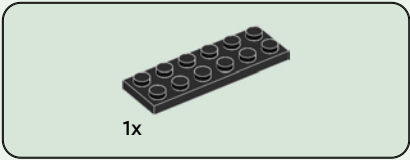

10

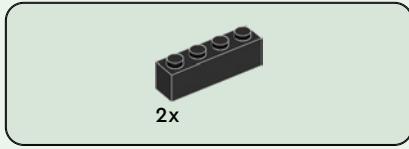
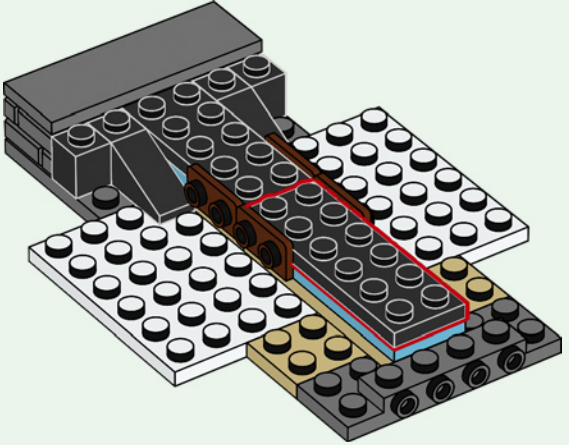

11

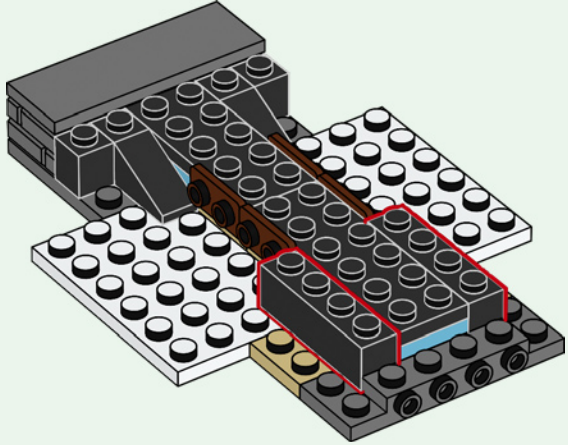



2x



2x

12

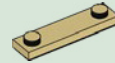
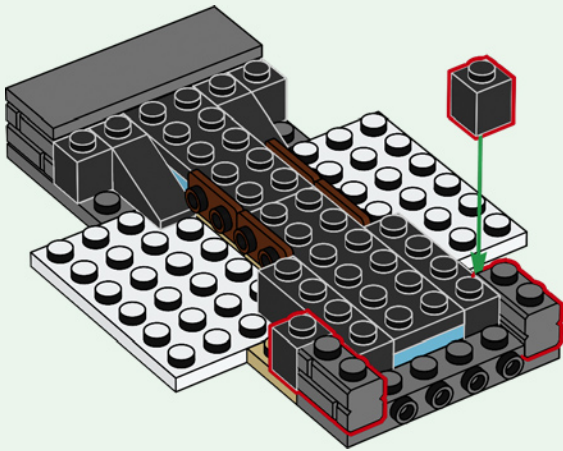

2x

13

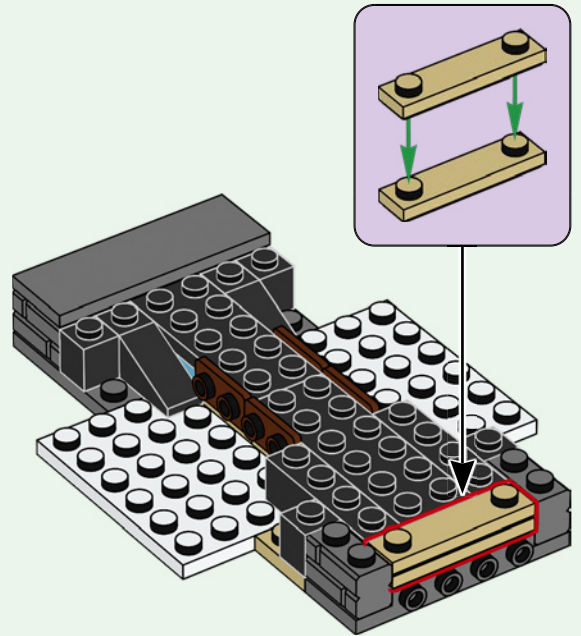

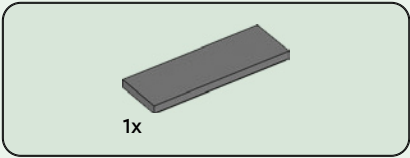

14

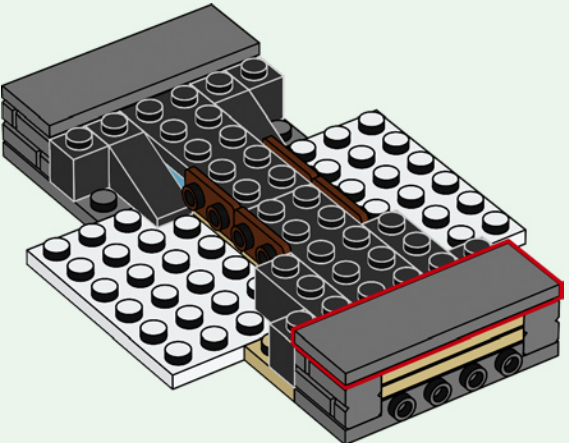

15

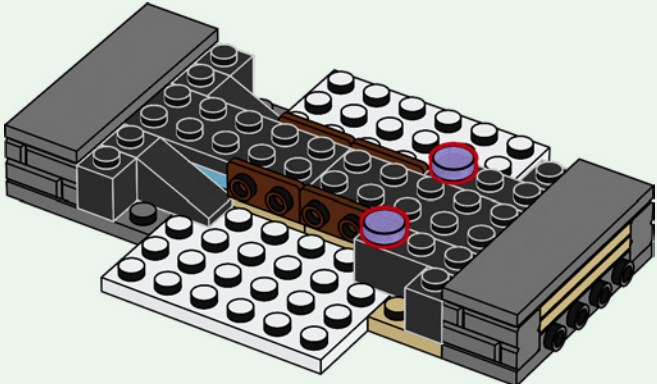

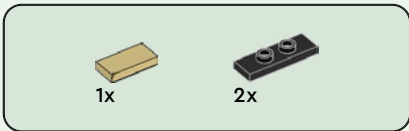

16

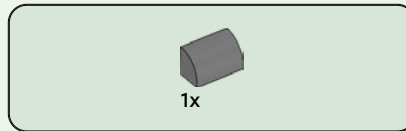
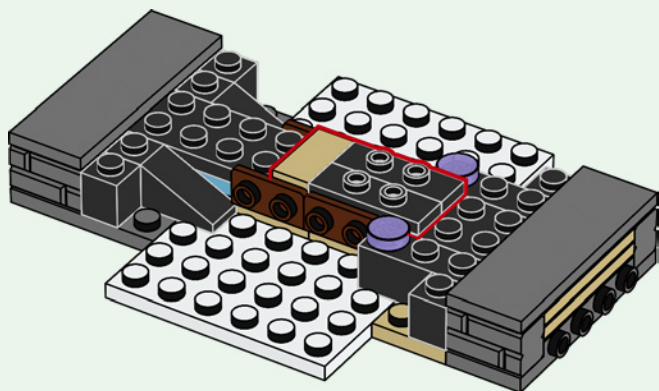

17

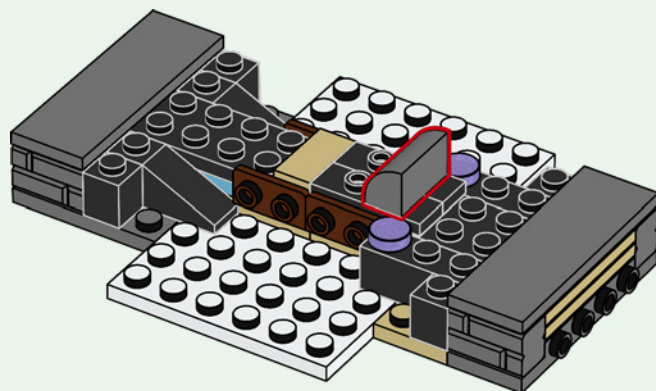



2x

18

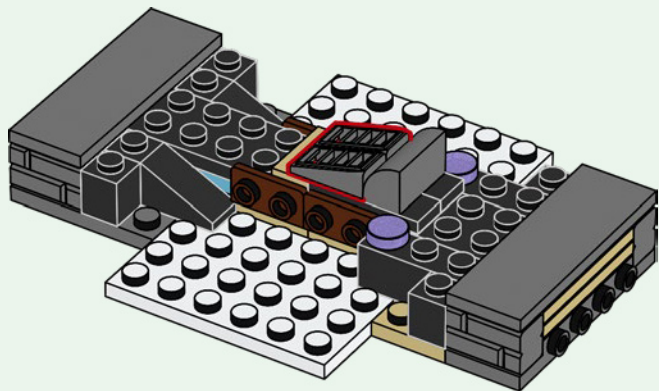

2x

19

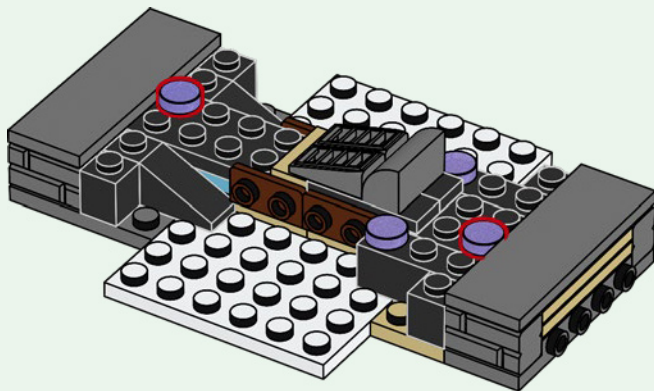



2x

20



2x

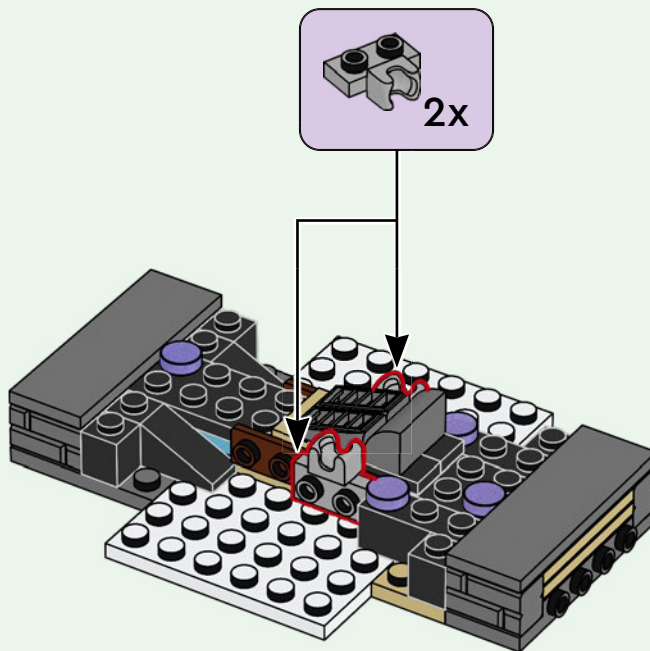

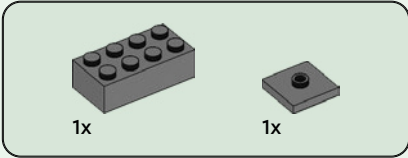
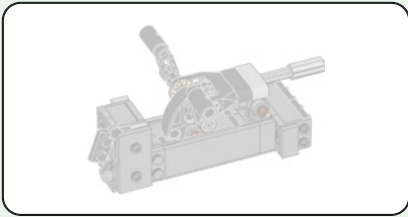

21

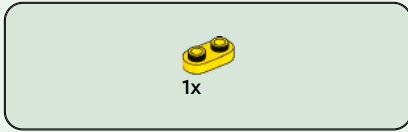
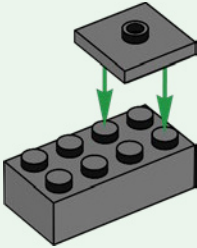

22

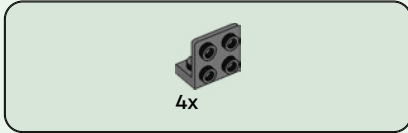
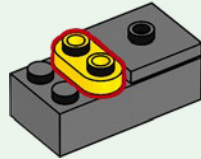

23

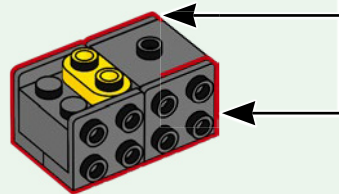
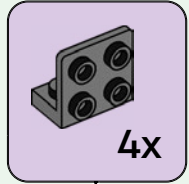



1x

24

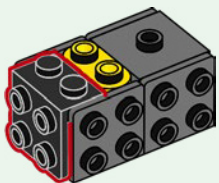

2x

25

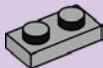
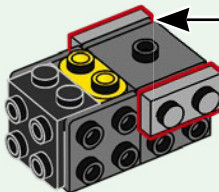

2x

27



2x

26

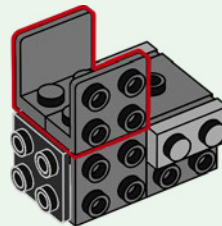

1x

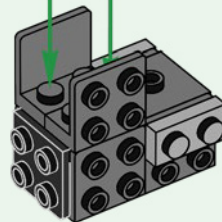
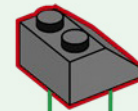



1x

28

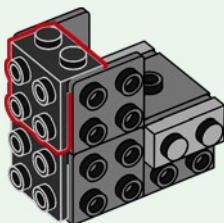

1x

29

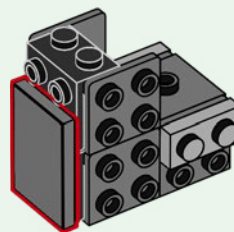

1x

30

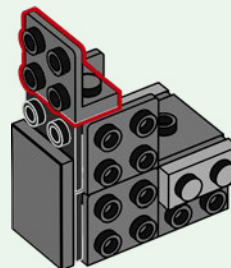

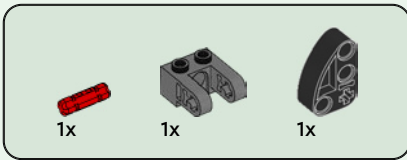

31

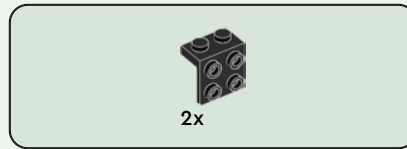
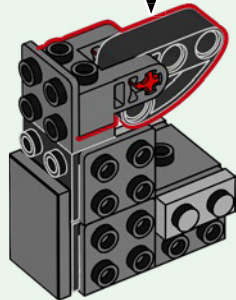
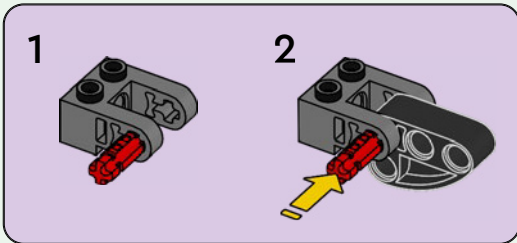

32

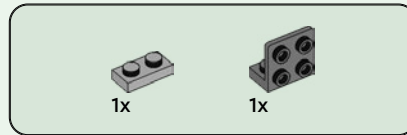
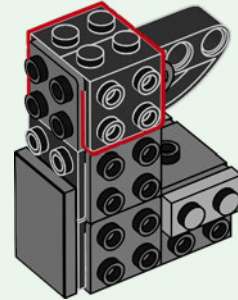

33

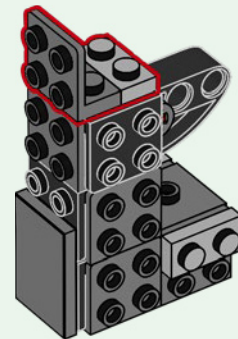



1x

34

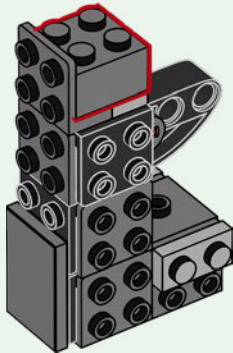

2x

35

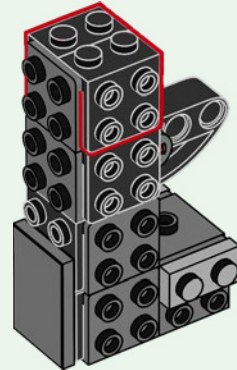



2x

36

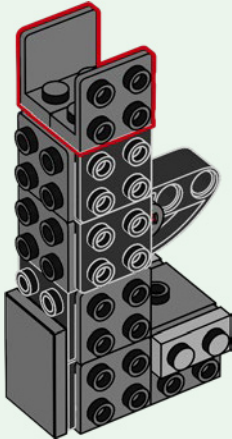

1x



1x

37

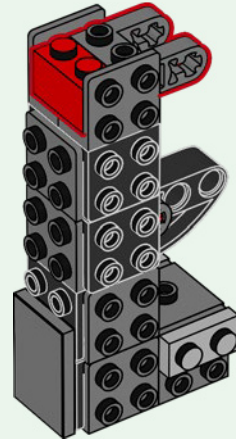

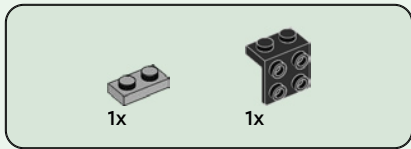

38

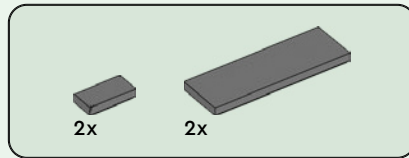
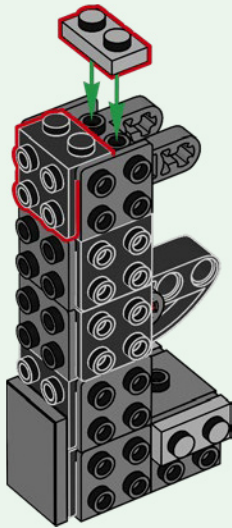

39

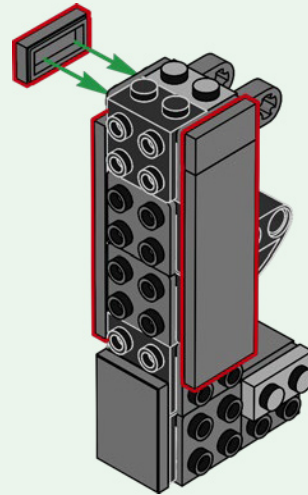

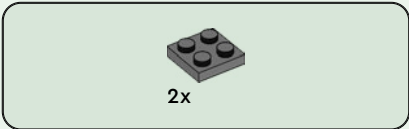

40

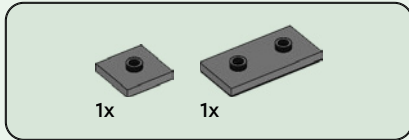
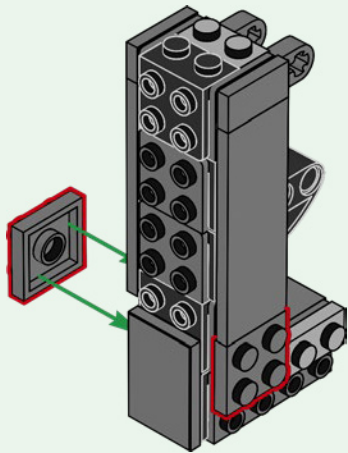

41

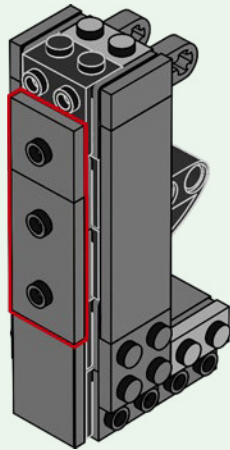

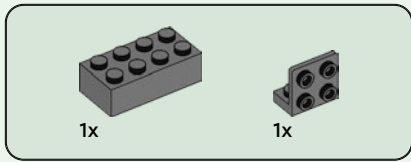

42

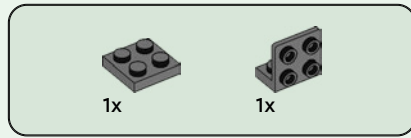
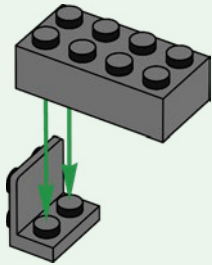

43

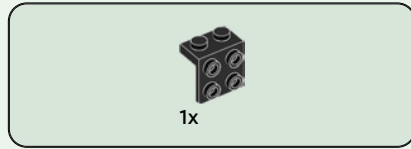
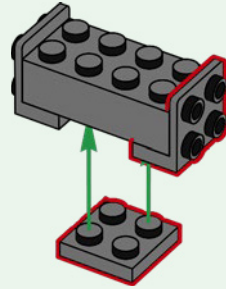

44

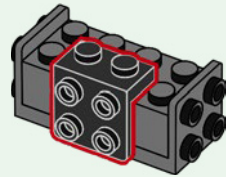



2x

45

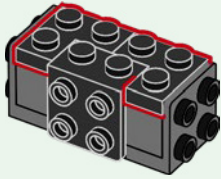

2x

46

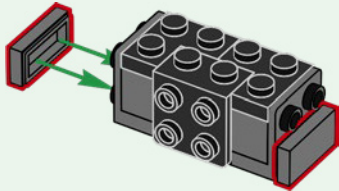

47

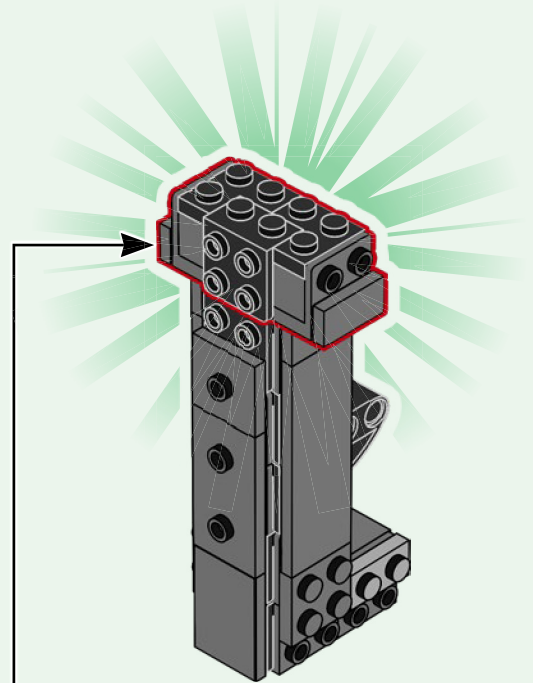

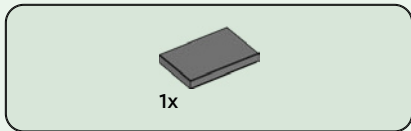

48

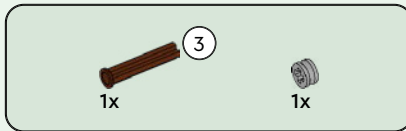
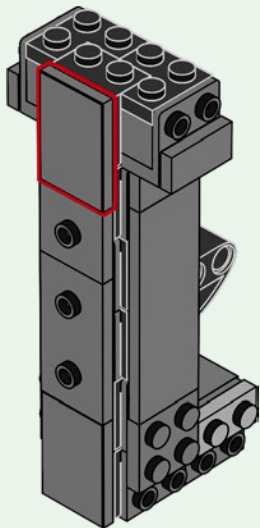

49

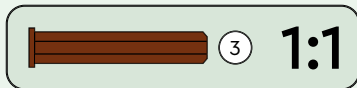
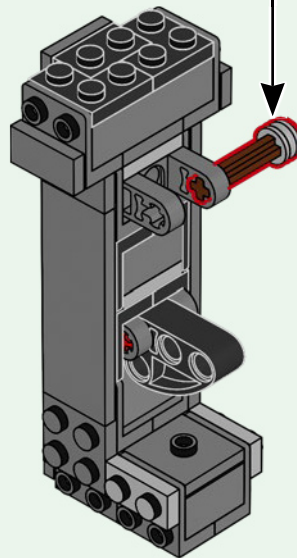
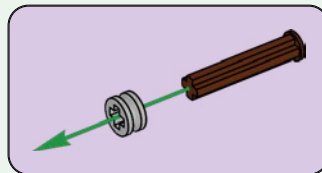

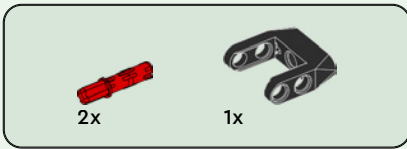

50

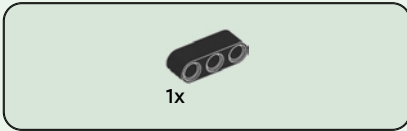
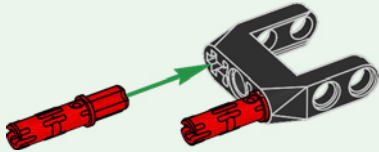

51

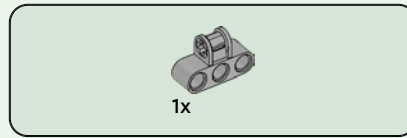
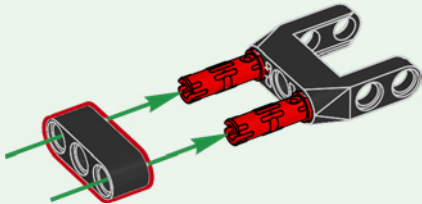

52

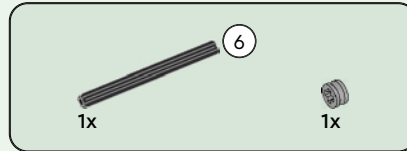
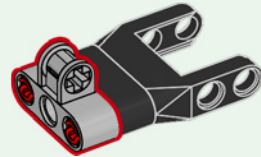

53

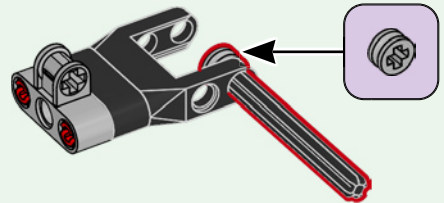

54

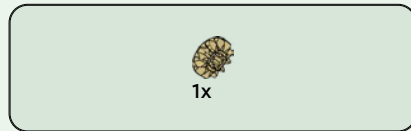
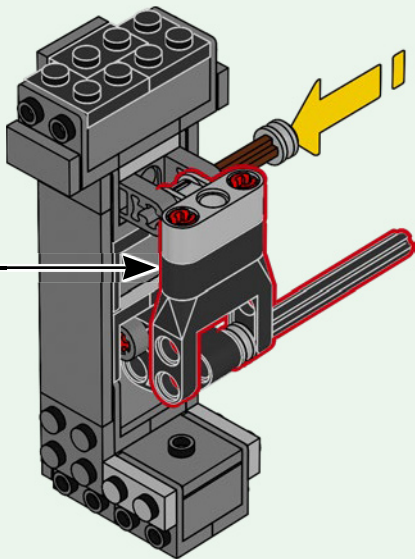

55

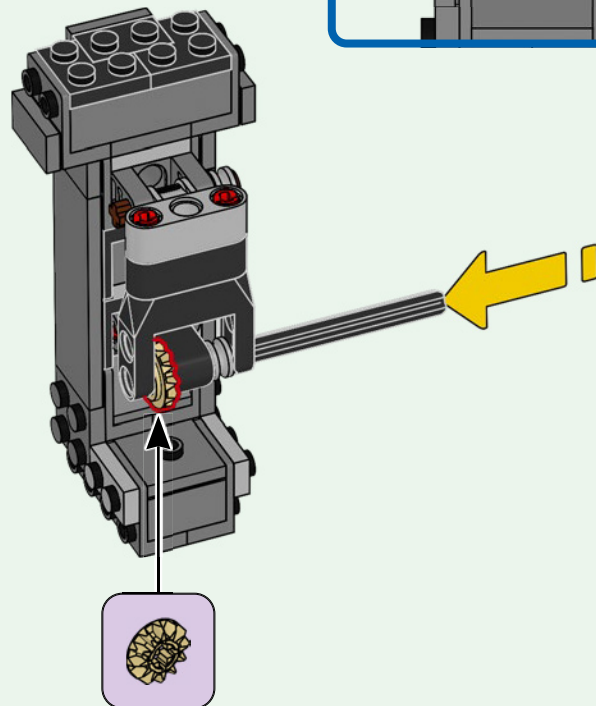
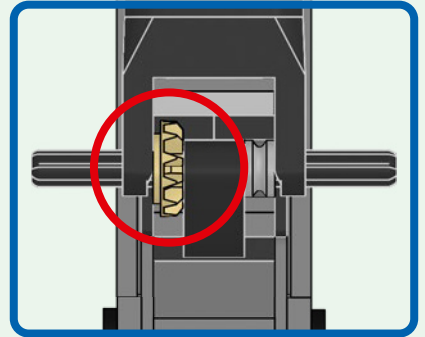

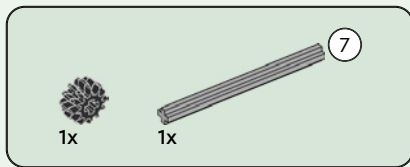

56

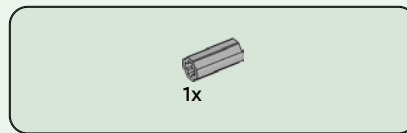
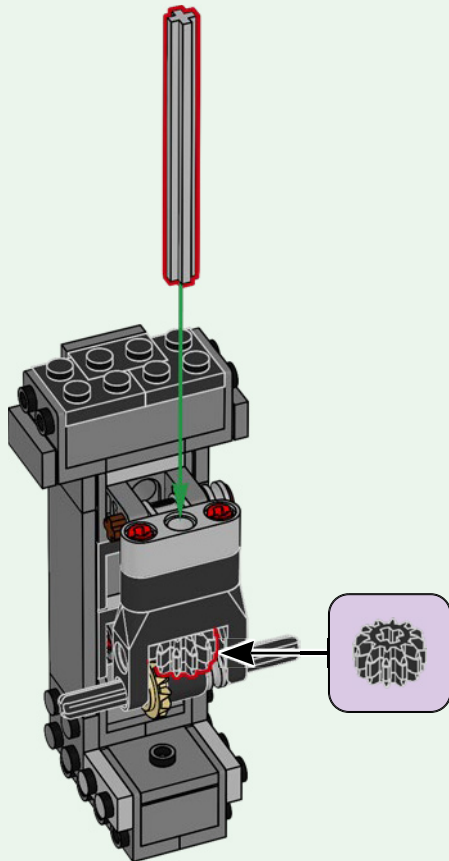

57

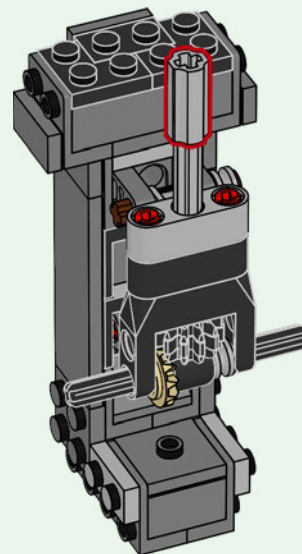

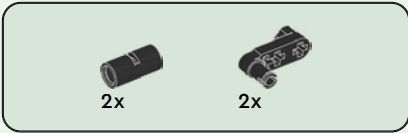

58

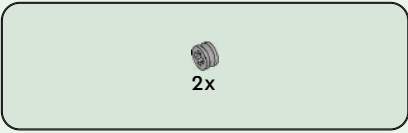
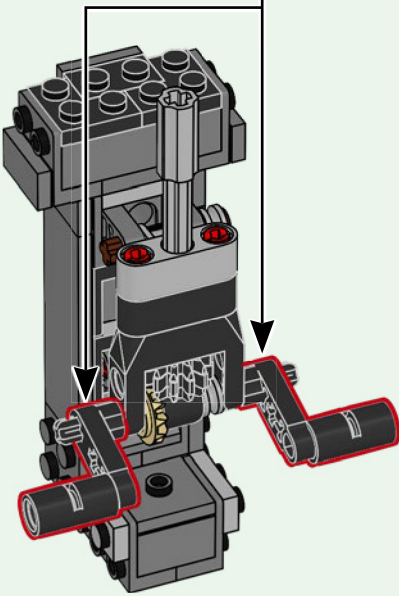
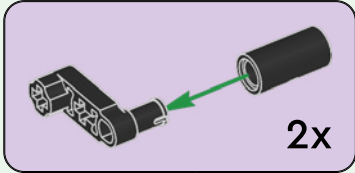

59

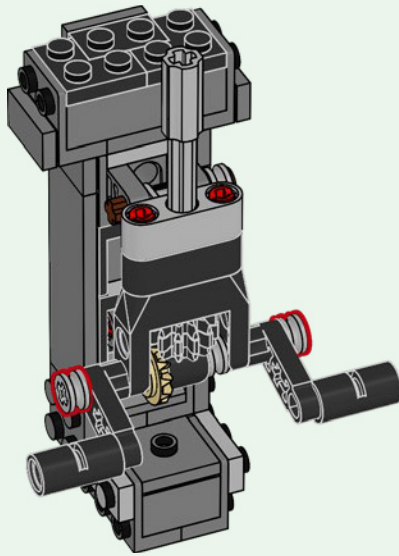

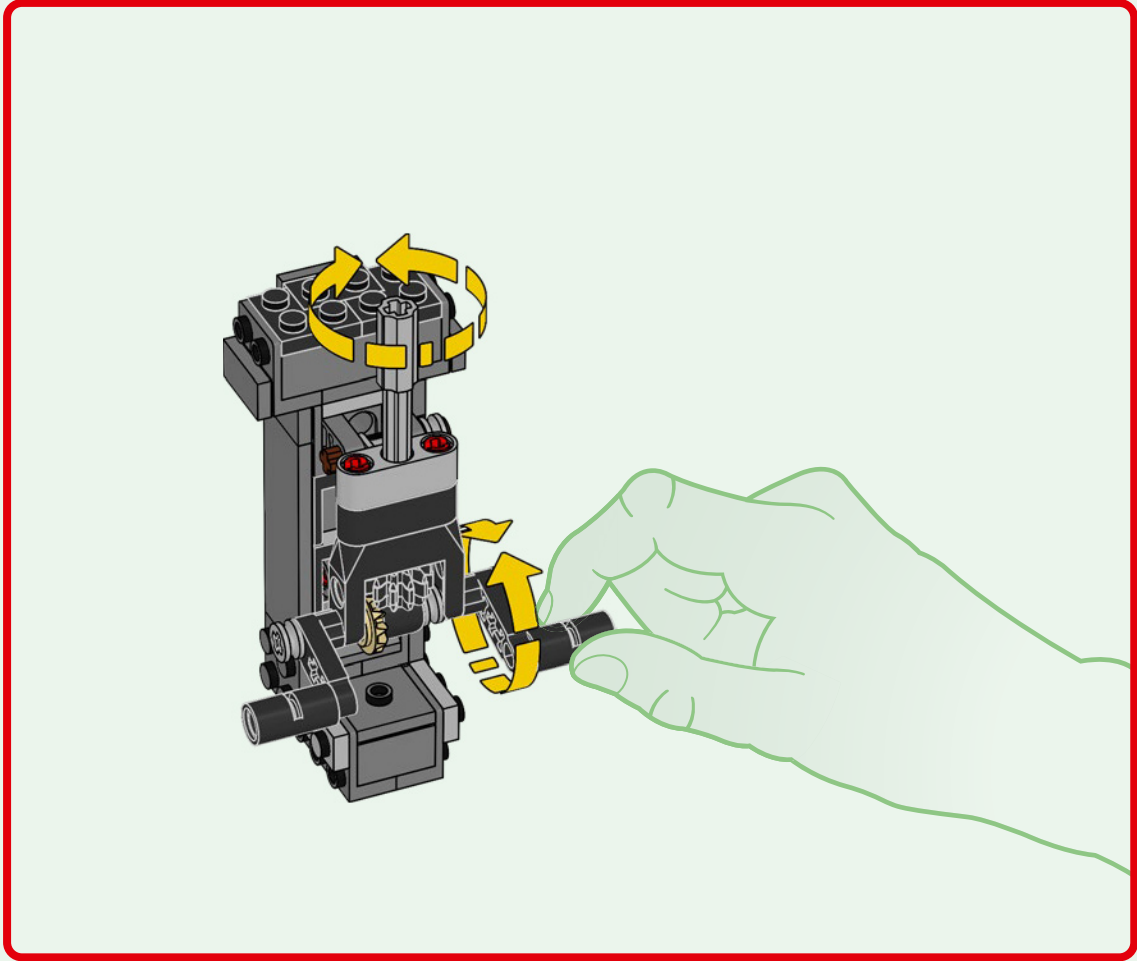

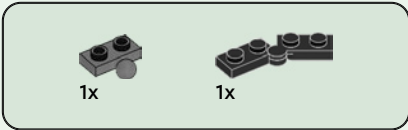

60

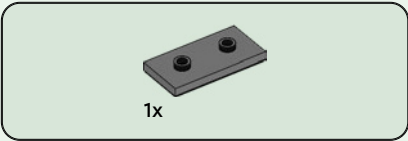
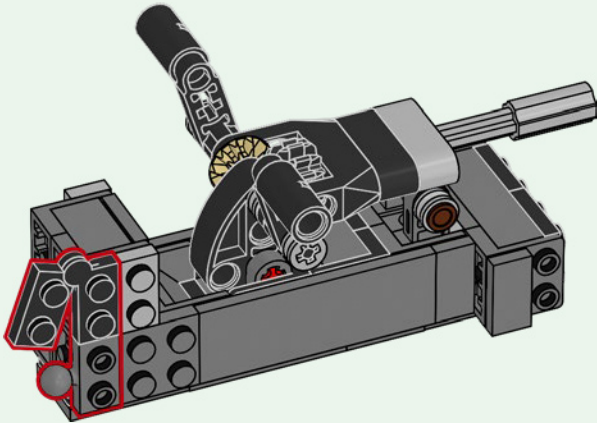

61

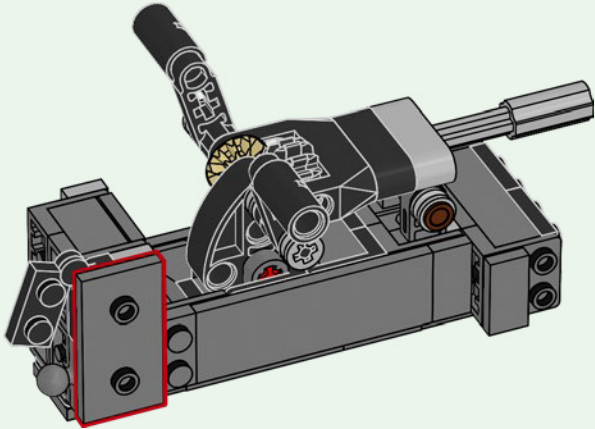

62

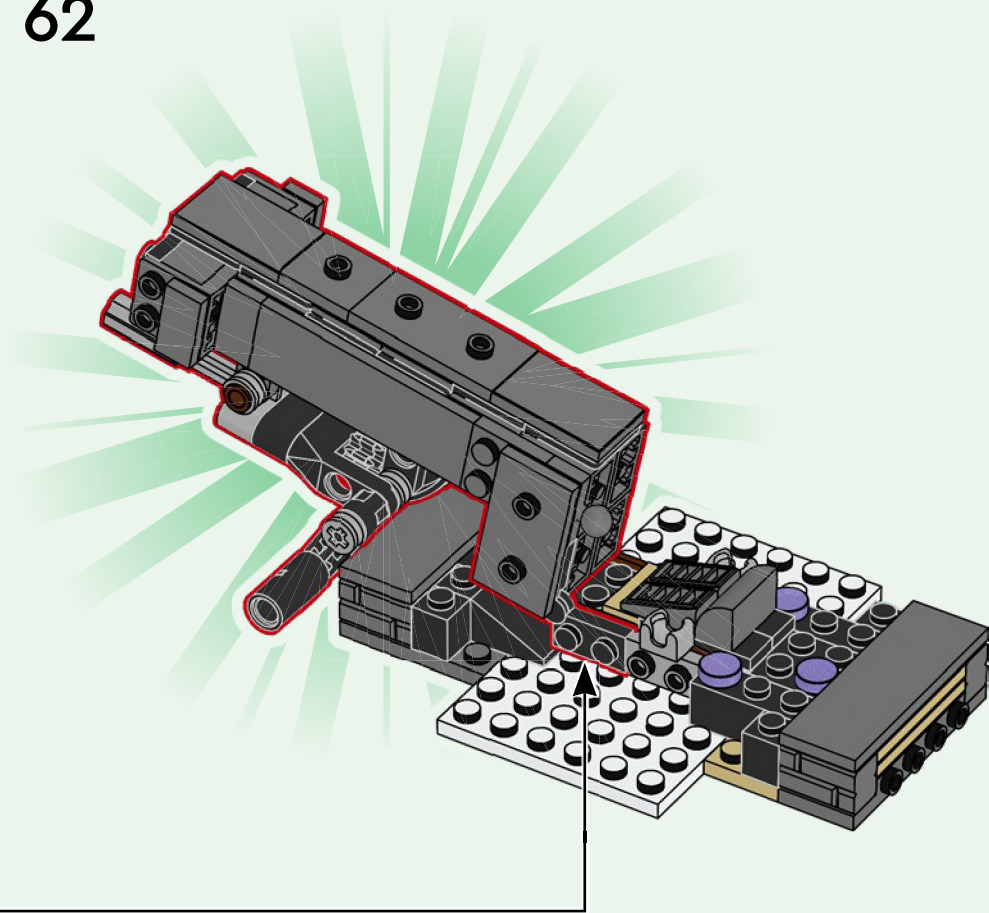



1x

63

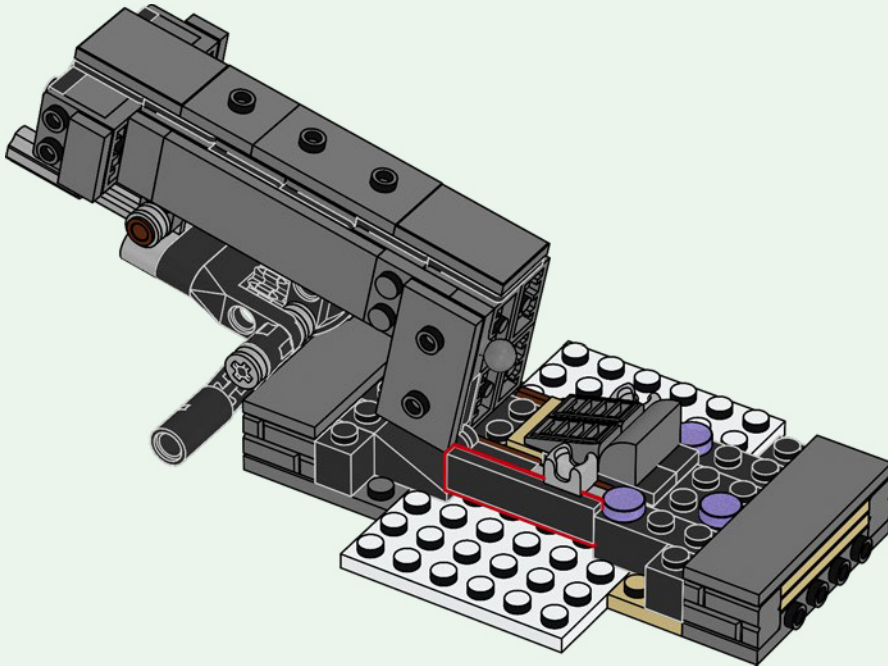

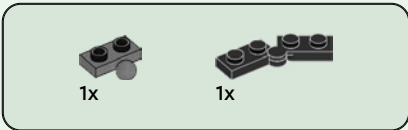

64

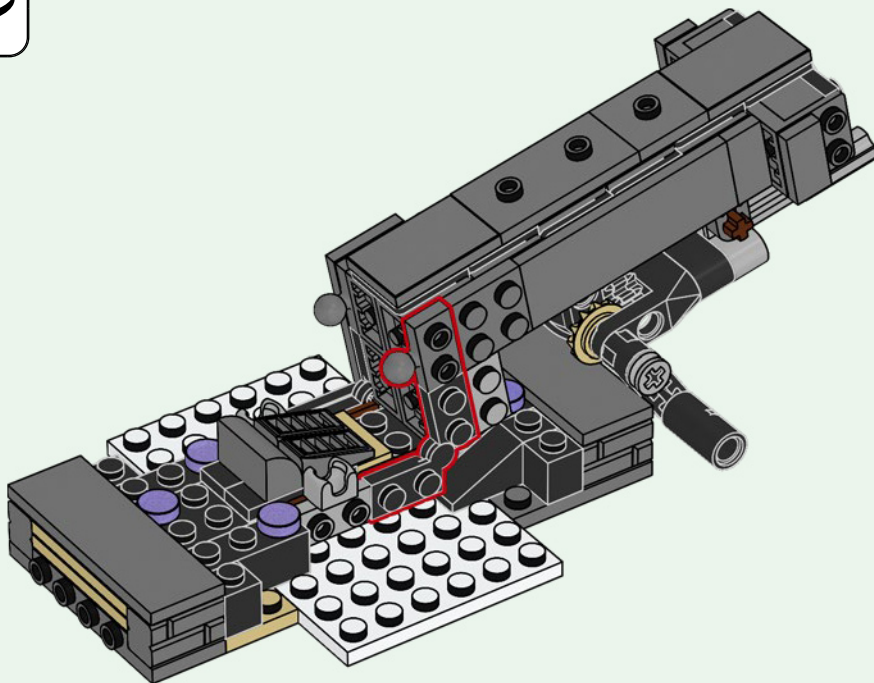

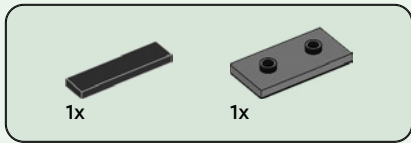

65

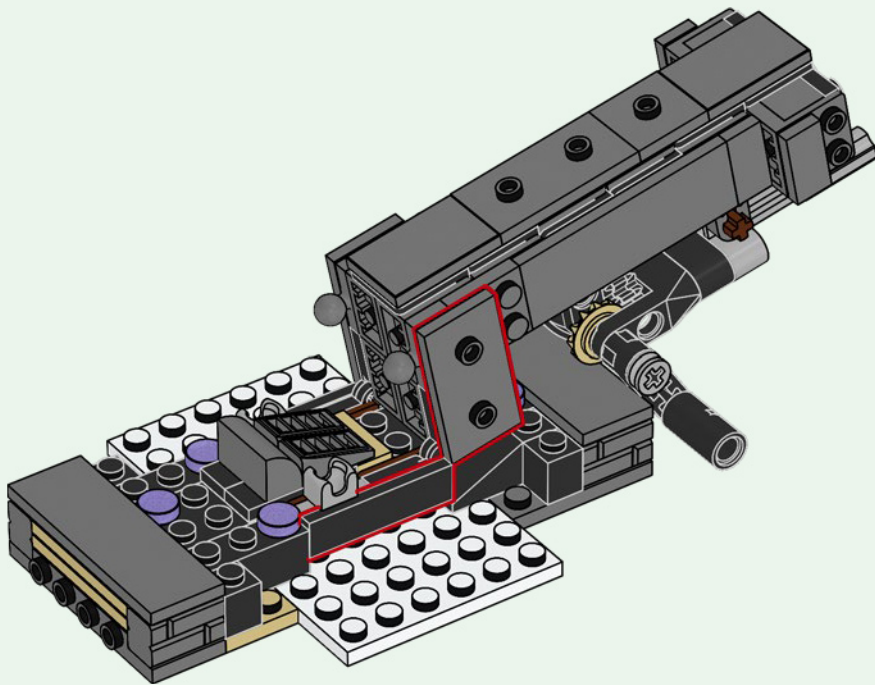



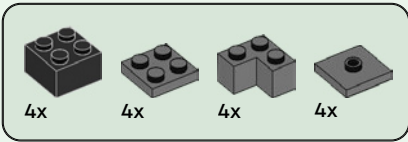

67

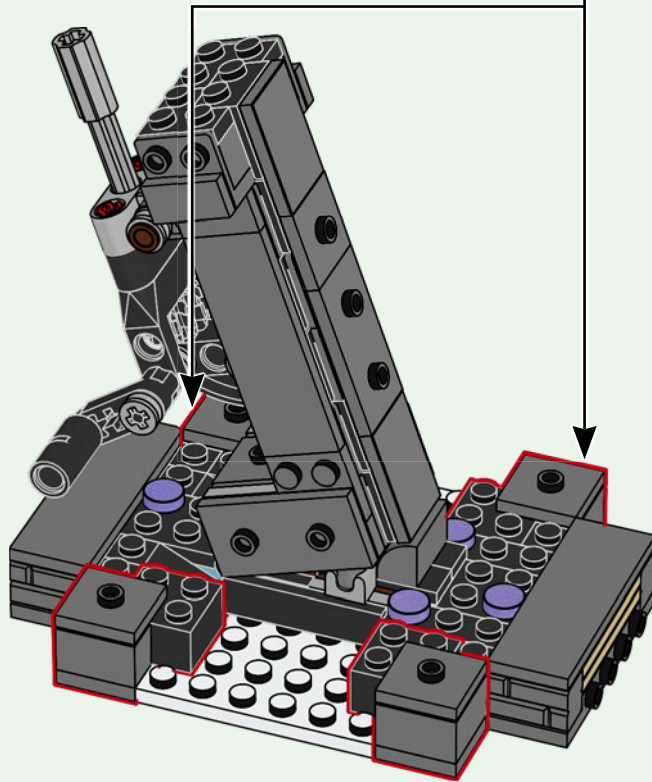
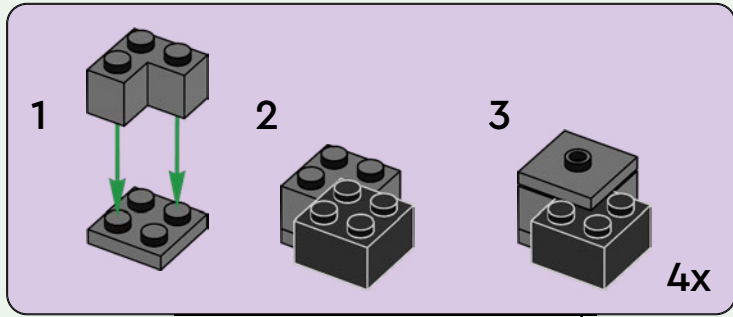



2x

68

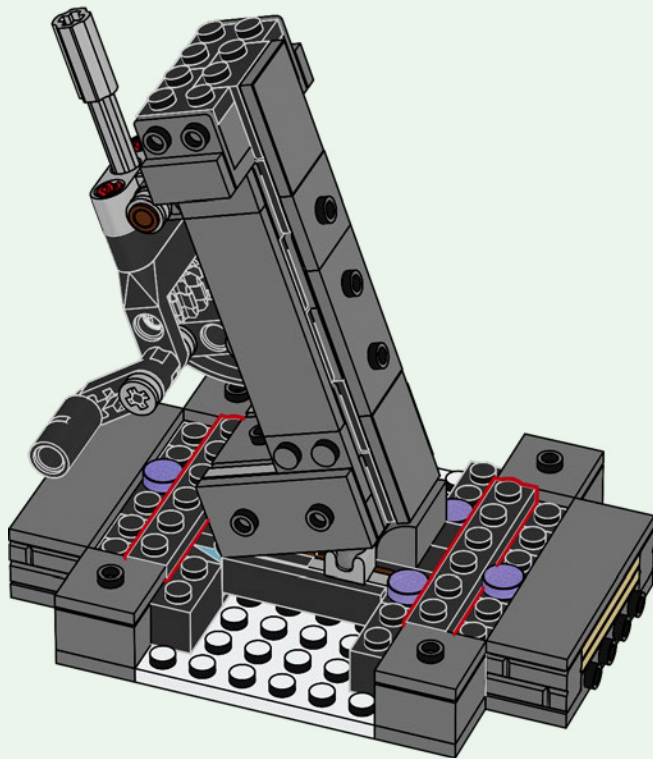



69

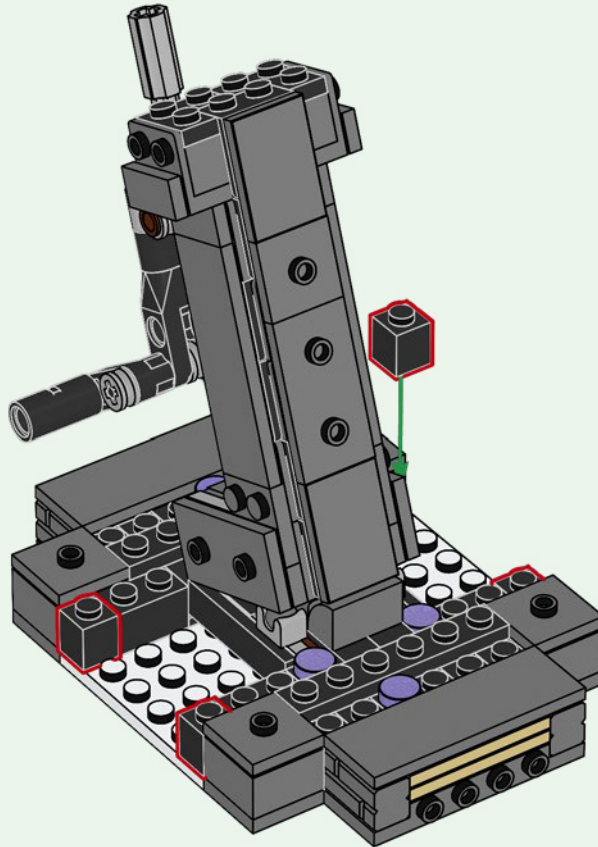



2x



1x



1x

70

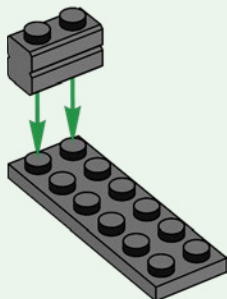

3x

71

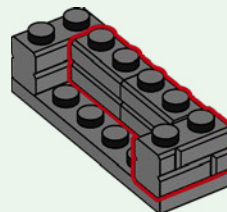

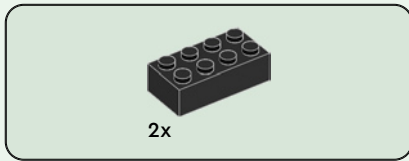

72

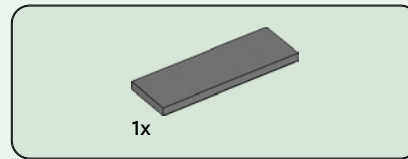
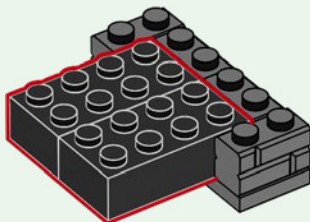

73

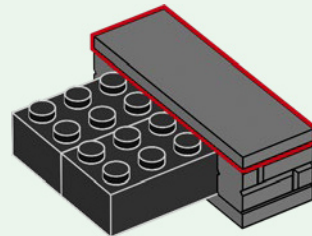

74

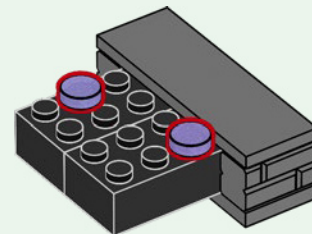

2x

75

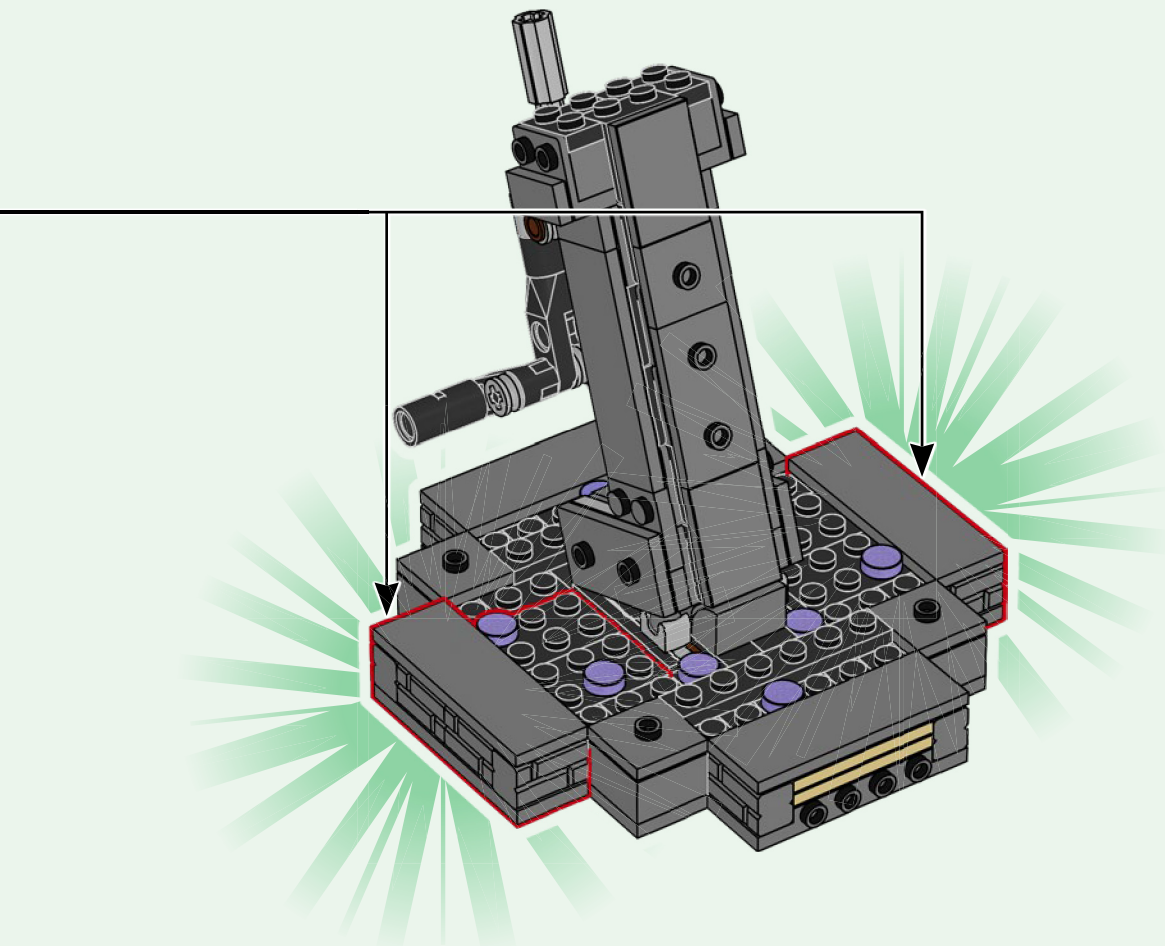

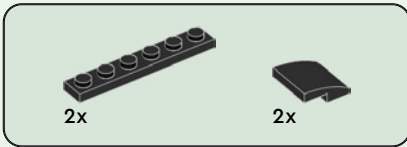

76

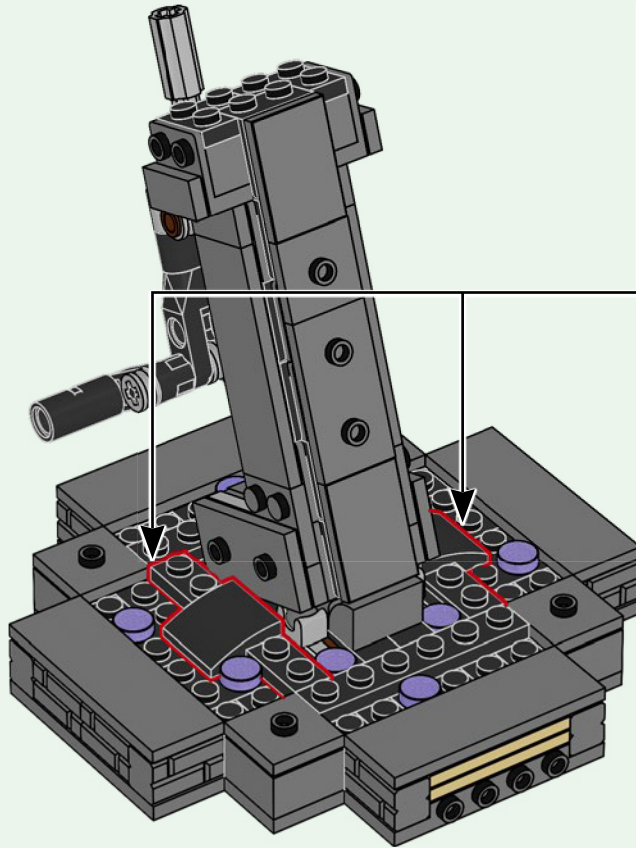
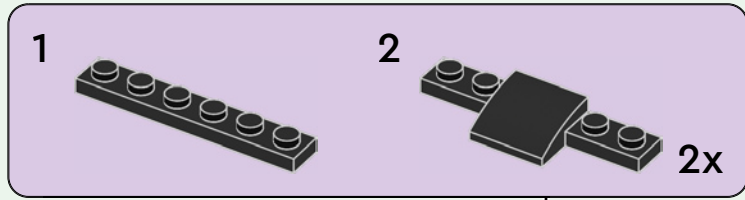



1x

77

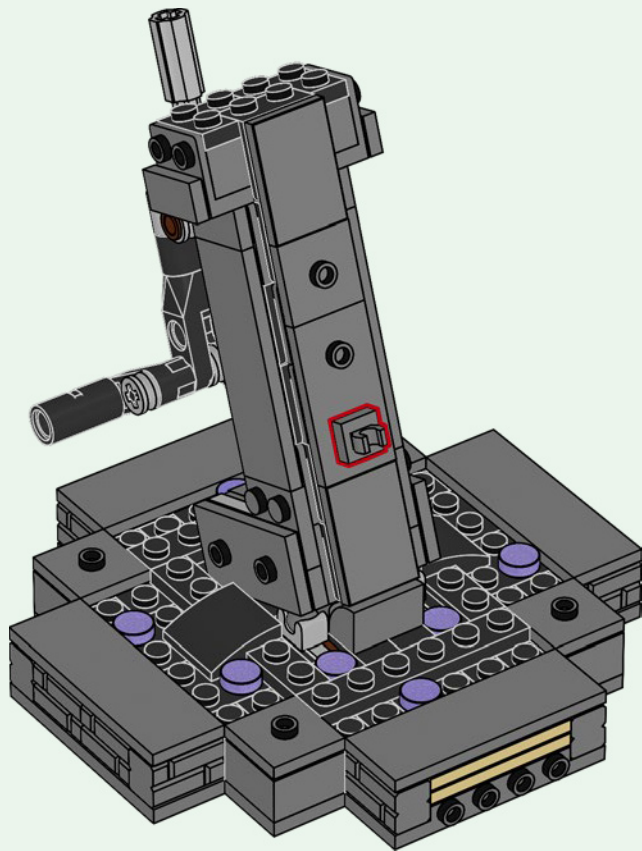

1x



1x



1x

78

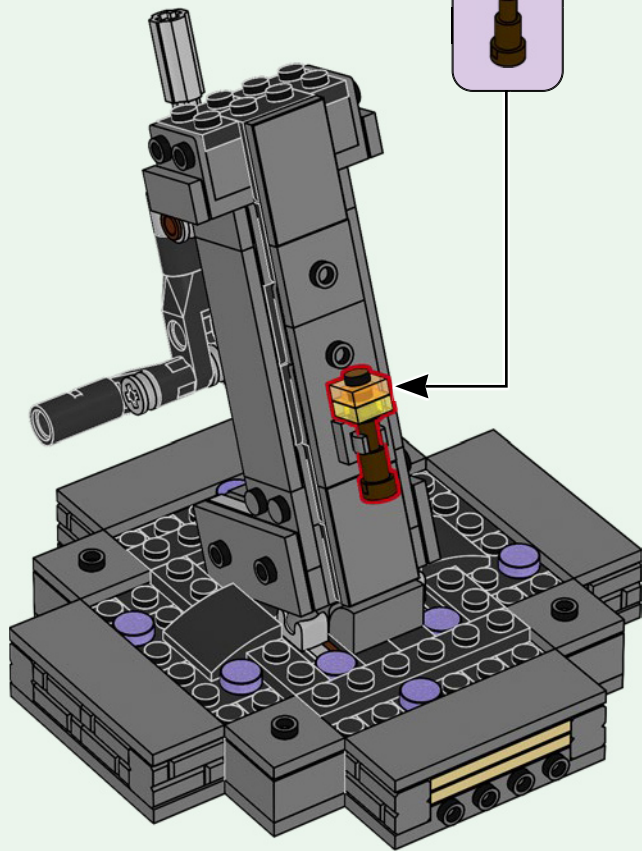

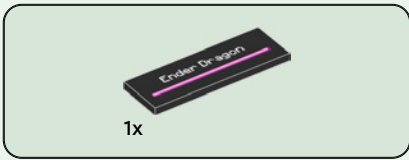

79

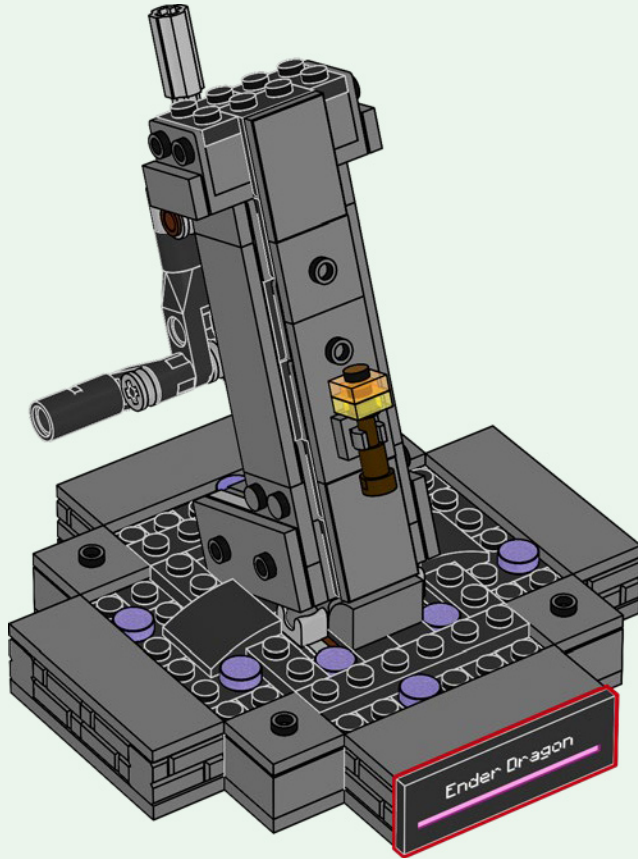

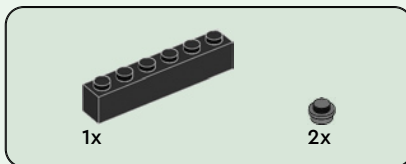
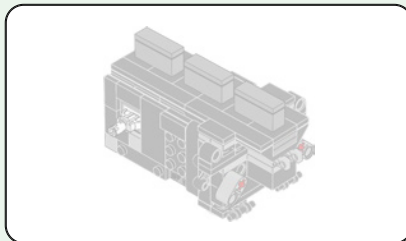

80

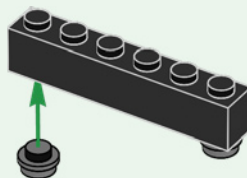

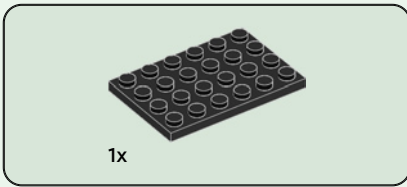

81

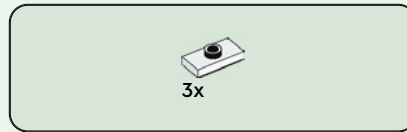
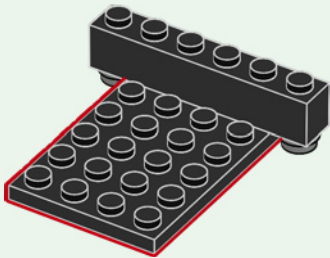

82

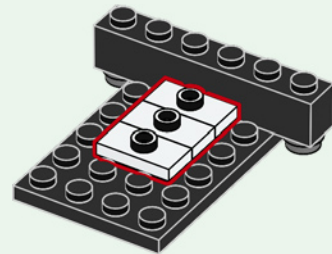



1x

83

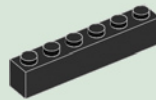
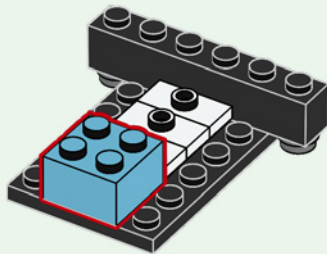

2x



2x

84

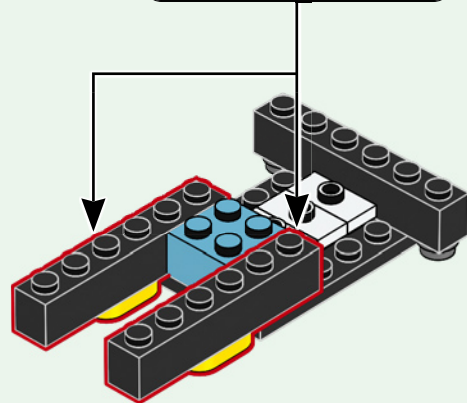
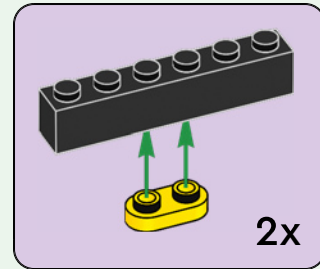

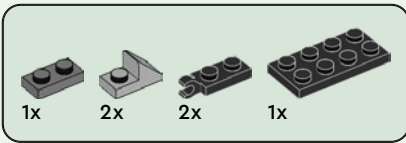

85

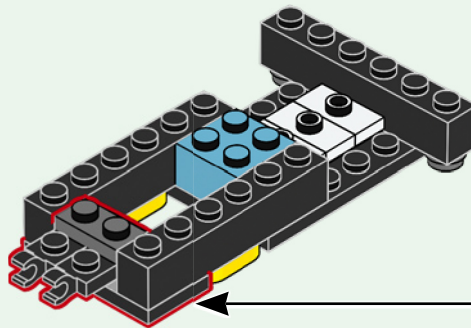
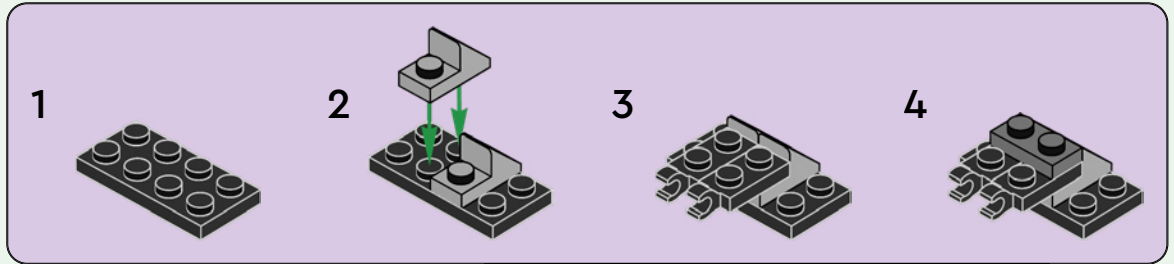



1x



1x

86

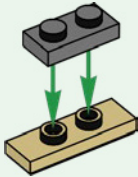

1x

87

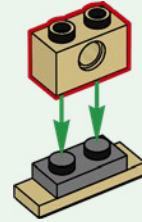

1x



1x

88

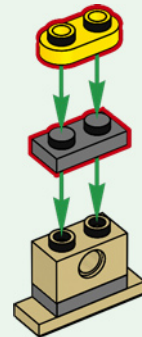

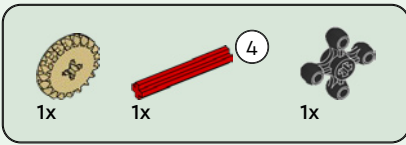

89

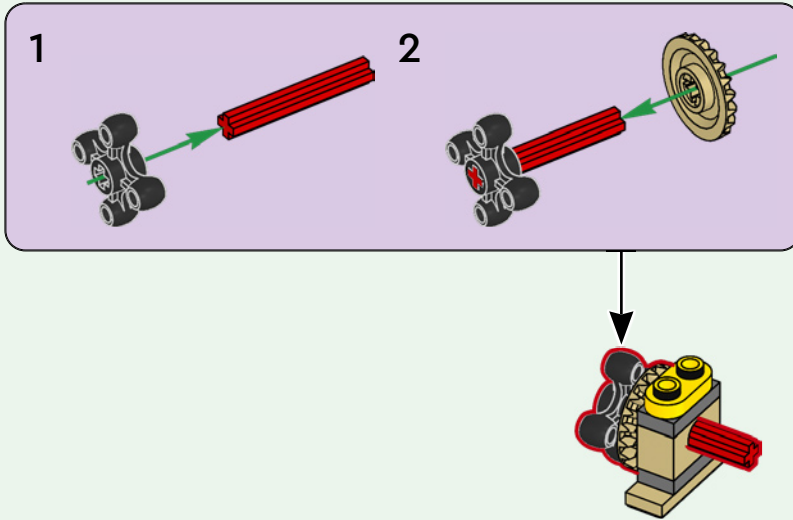

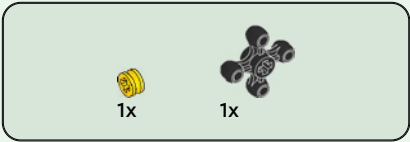

90

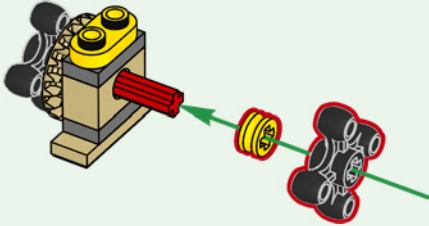

91

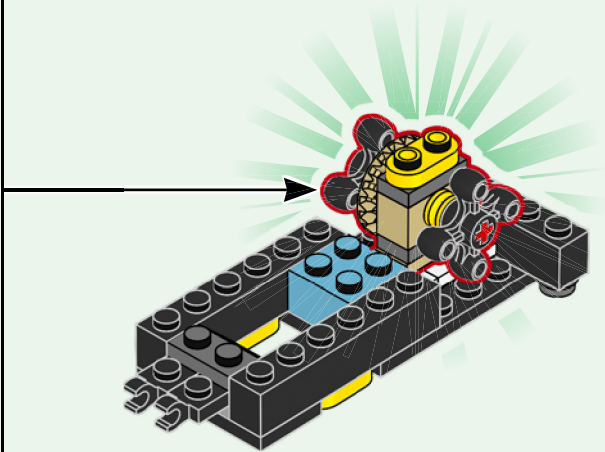

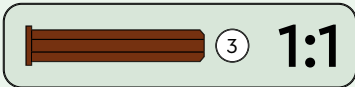
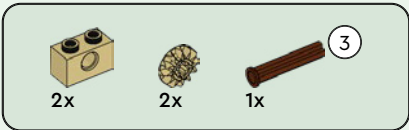

92

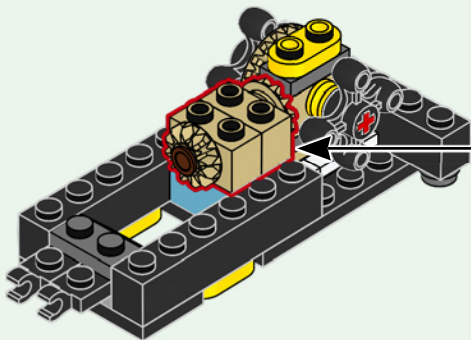
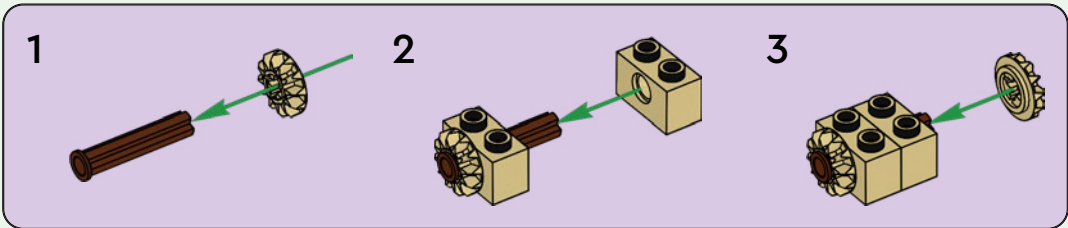

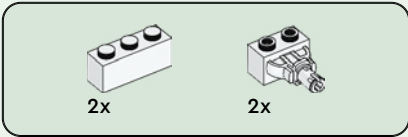

93

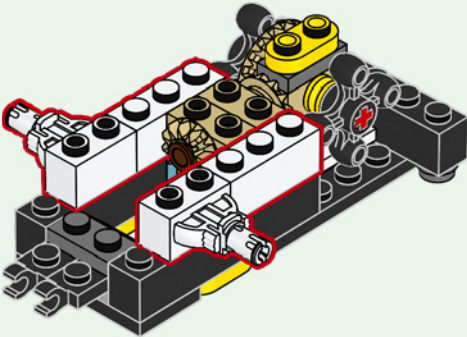

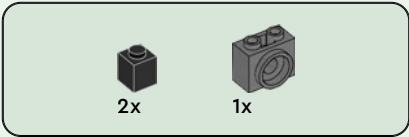

94

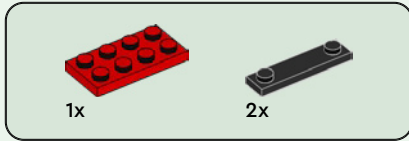
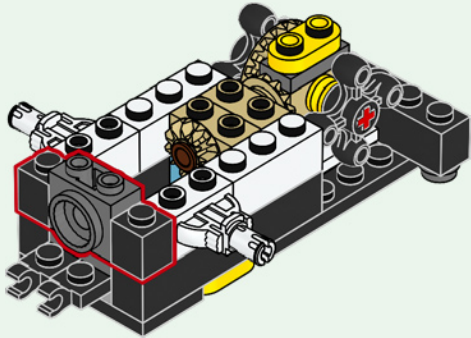

95

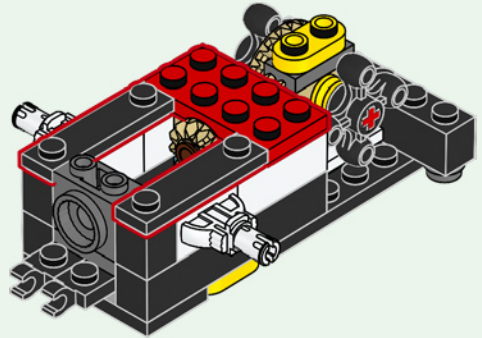

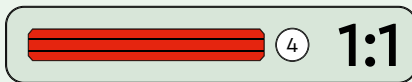
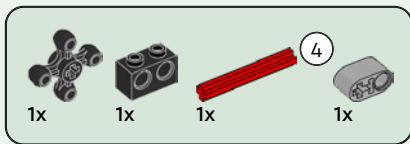

96

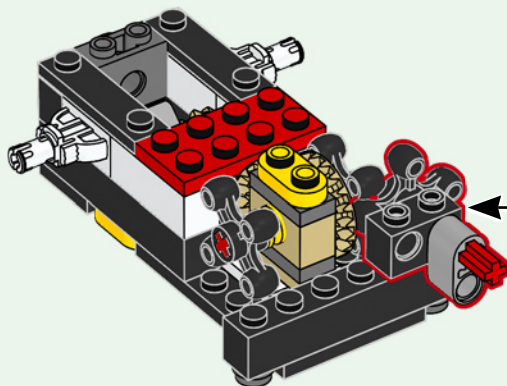
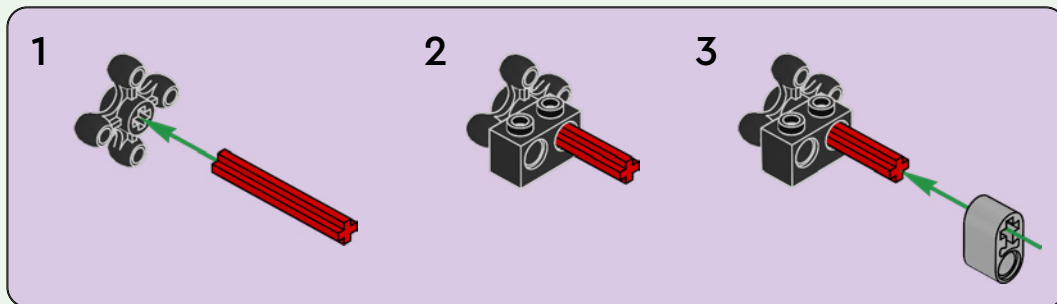

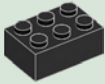

1x

97

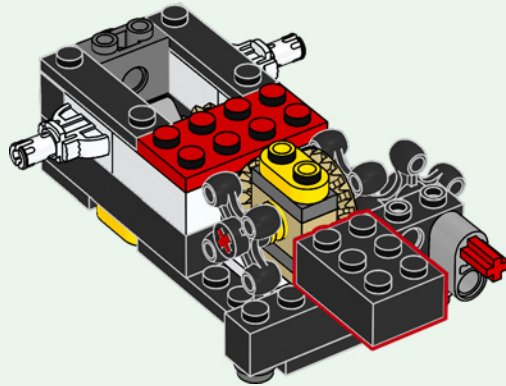

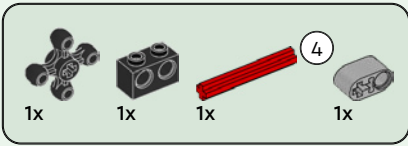

98

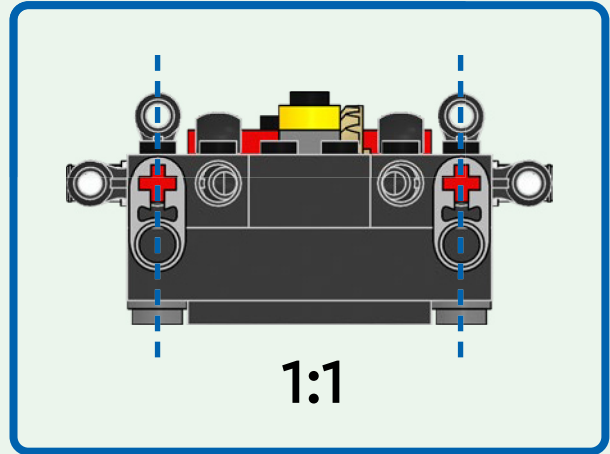
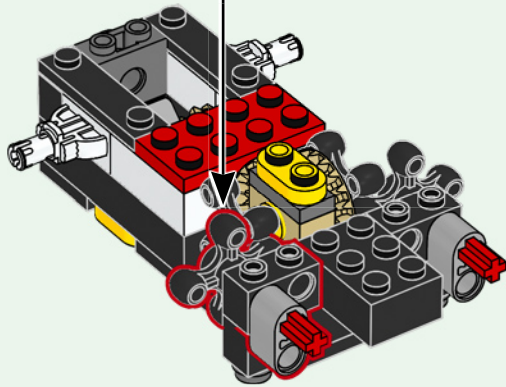
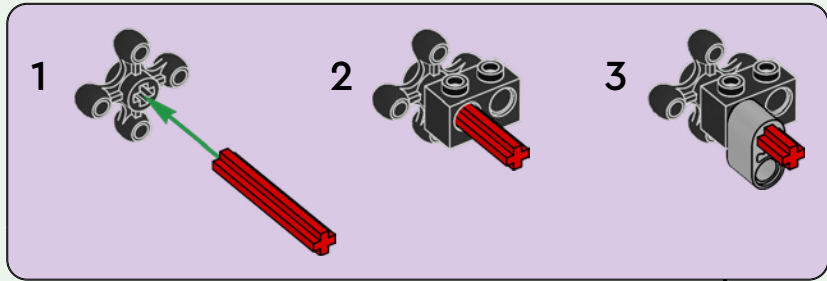



2x

99

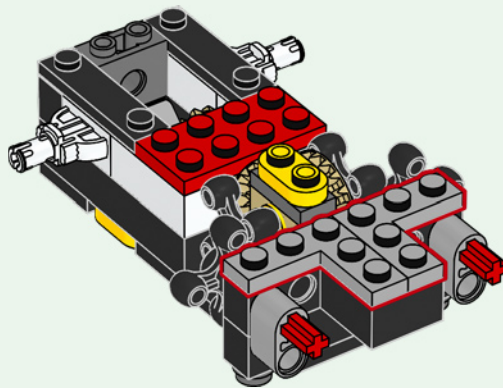

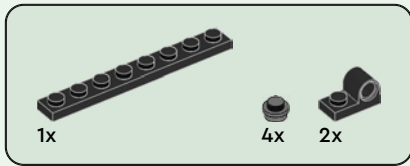

100

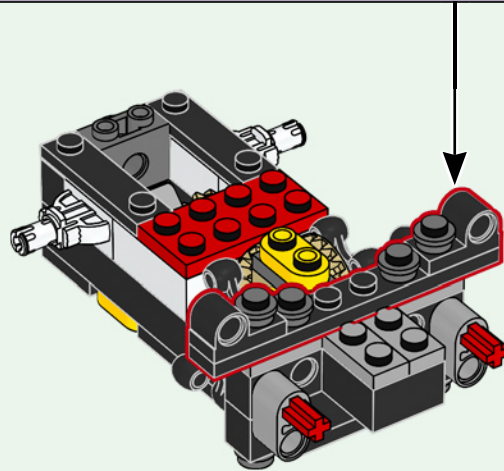
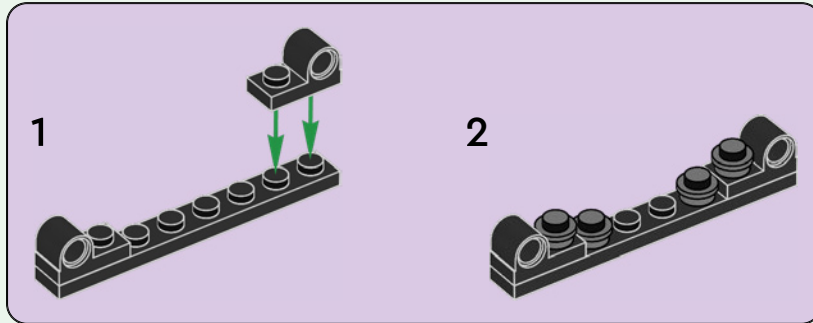

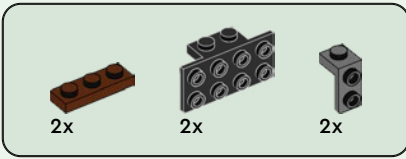

101

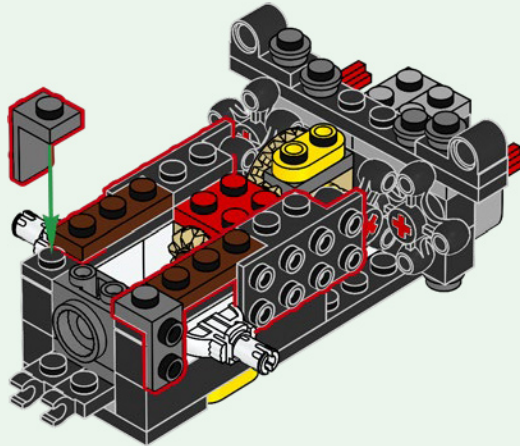

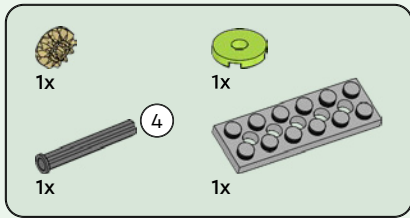

102

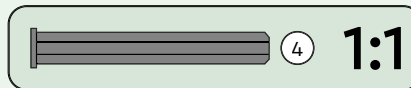
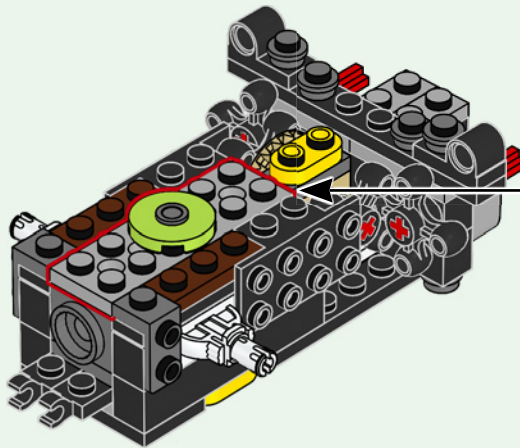
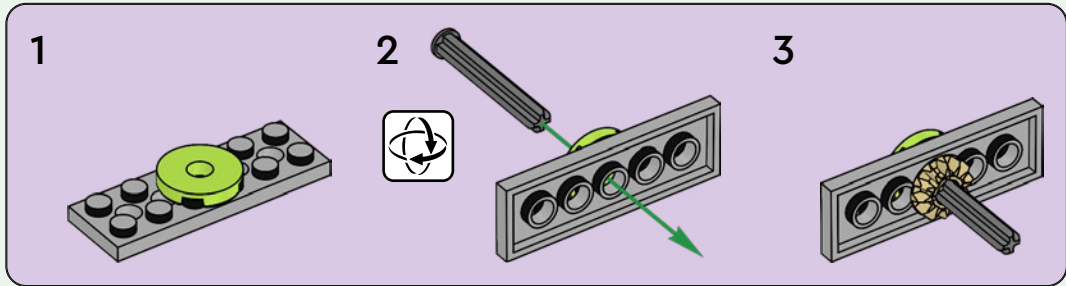

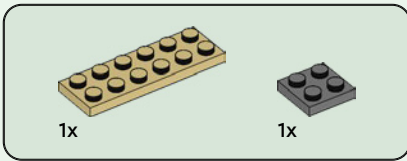

103

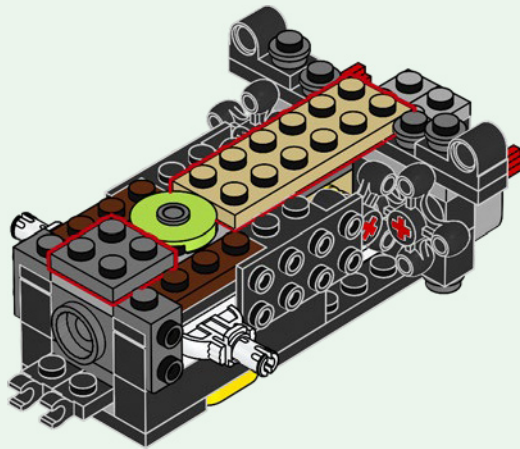

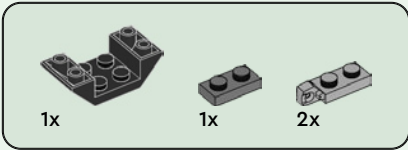

104

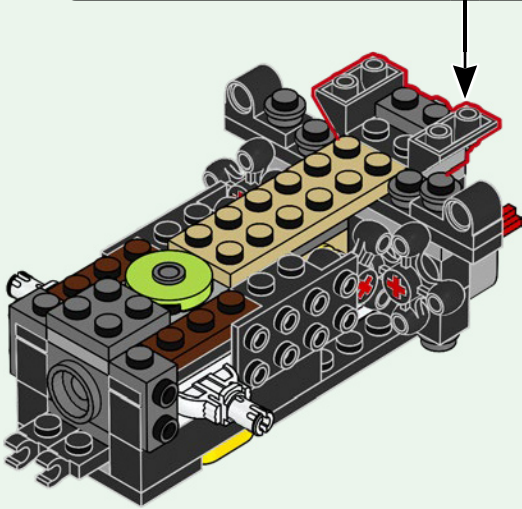
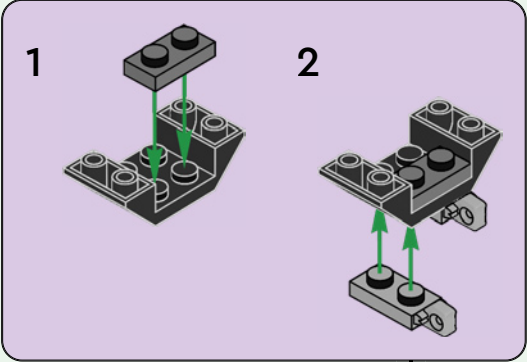



6x

105

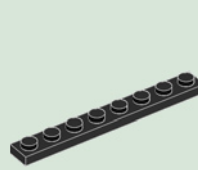
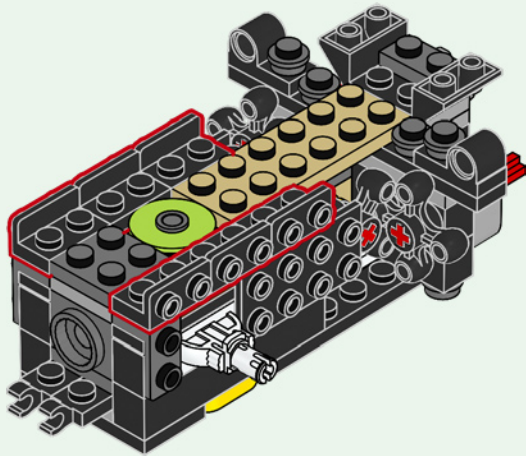

2x



1x



1x

106

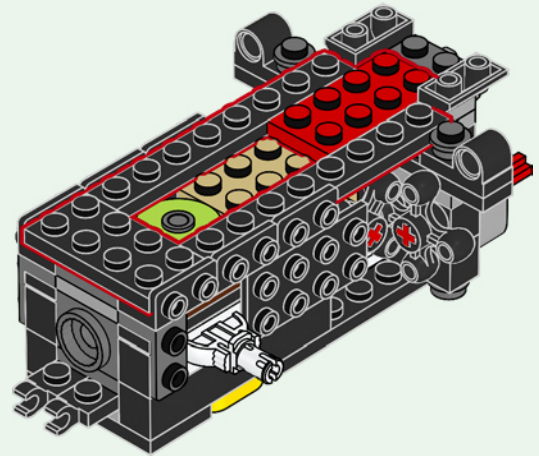

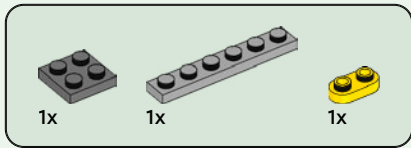

107

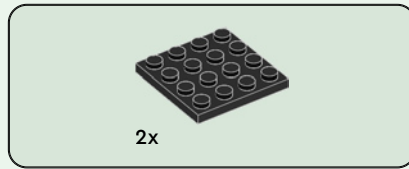
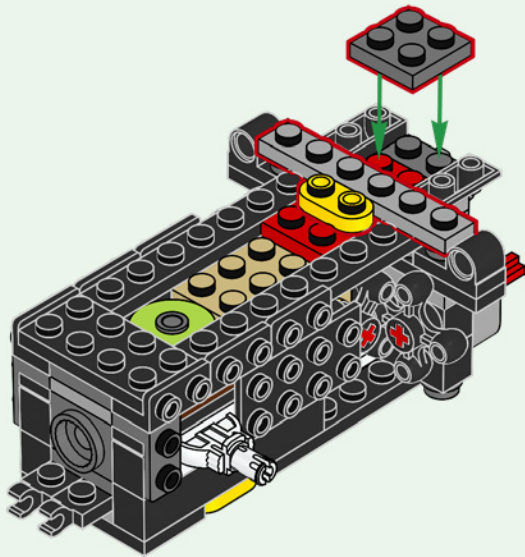

108

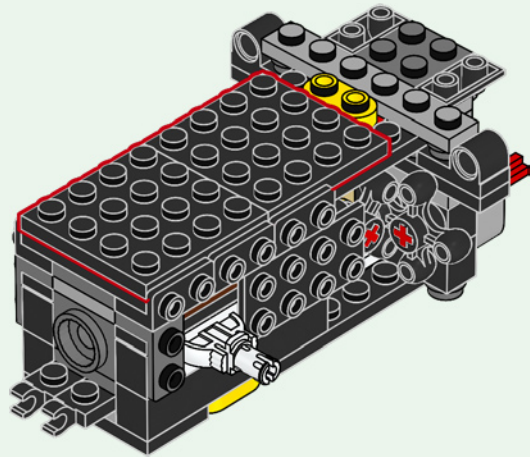



1x

109

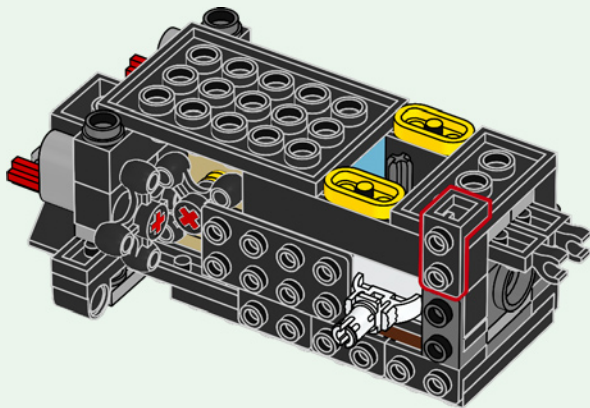

3x

110

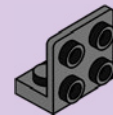

3x

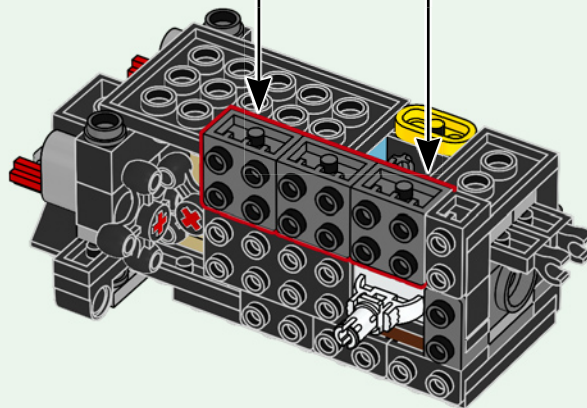

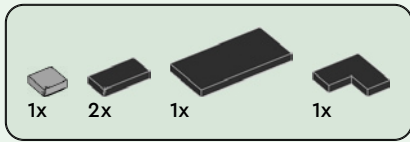

111

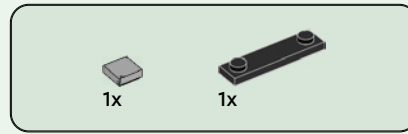
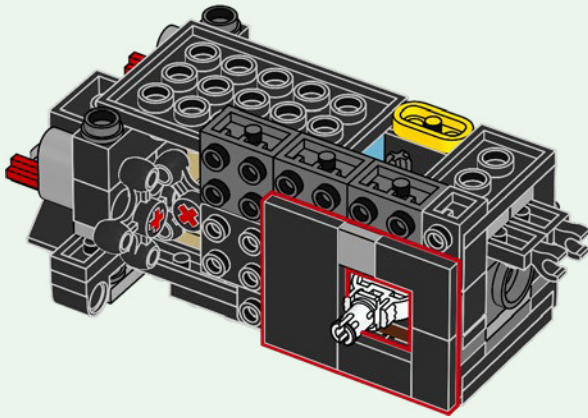

112

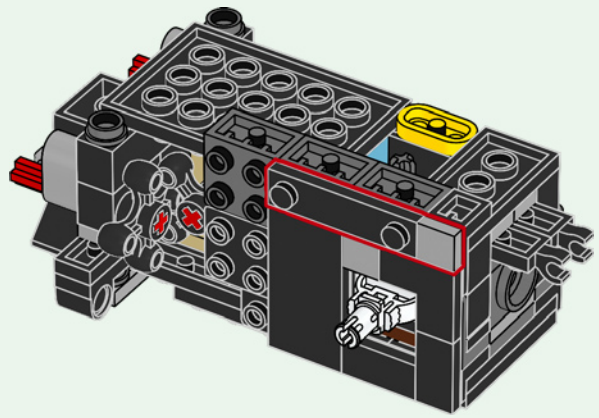

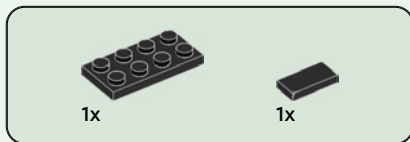

113

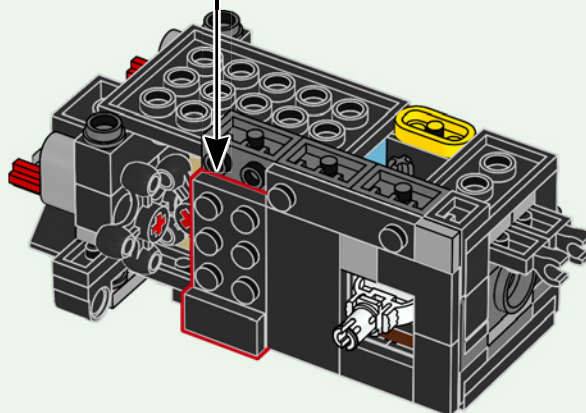
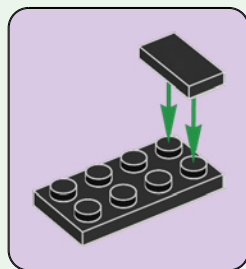

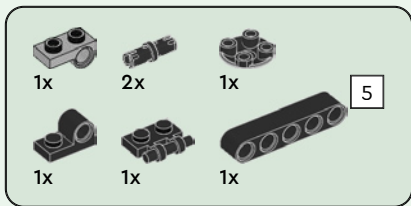

114

1

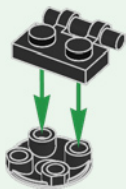

2



3

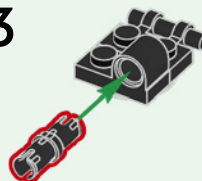

4

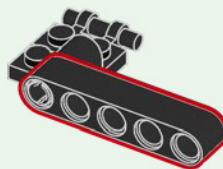

5

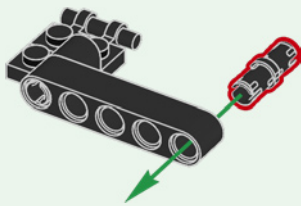

6

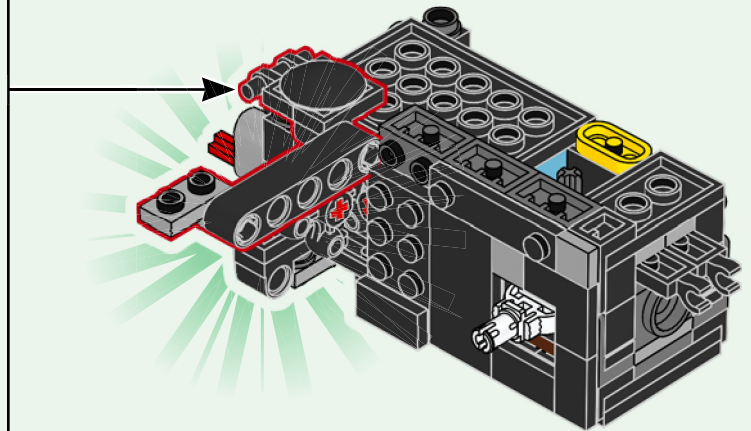
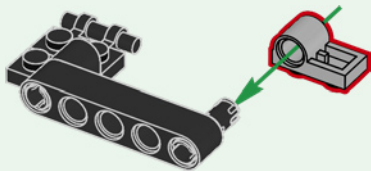

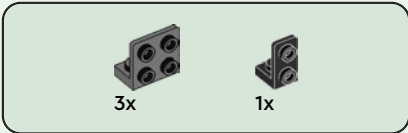

115

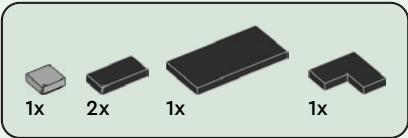
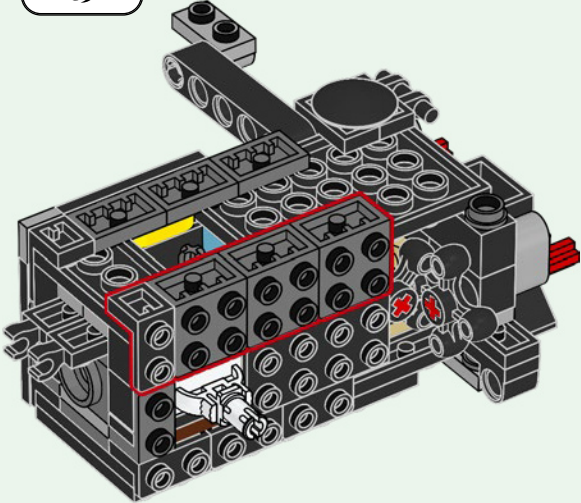

116

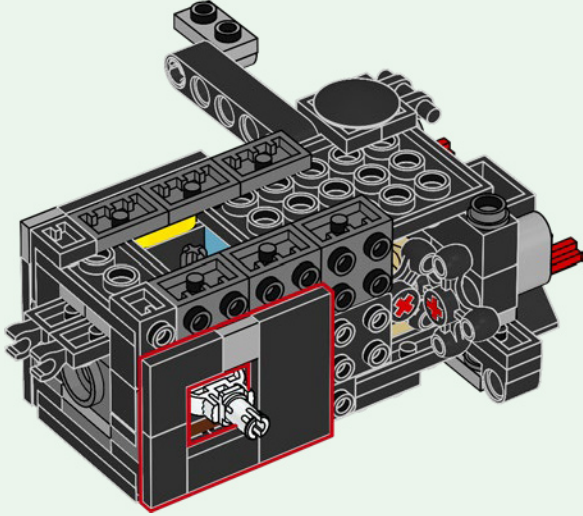

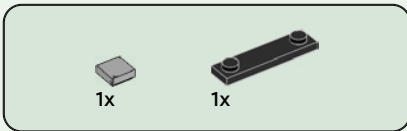

117

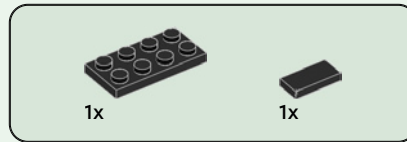
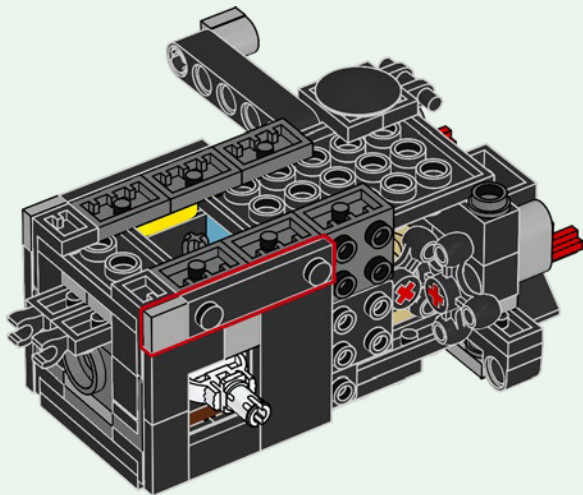

118

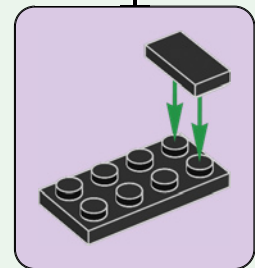
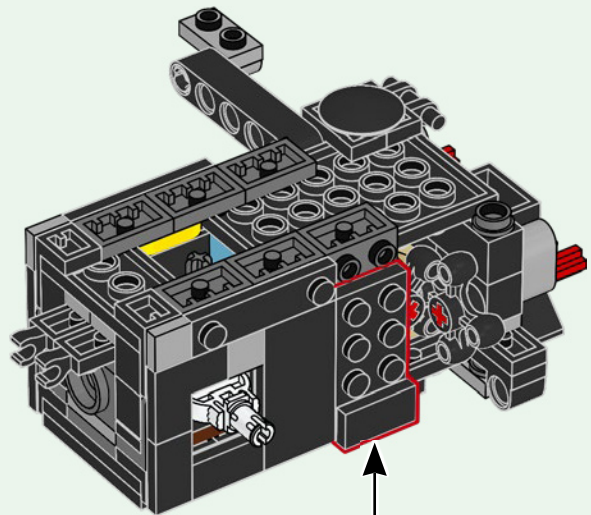

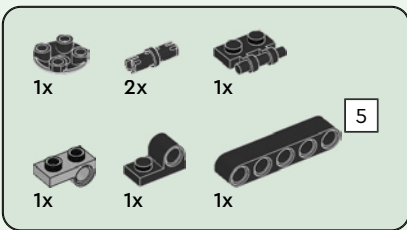

119

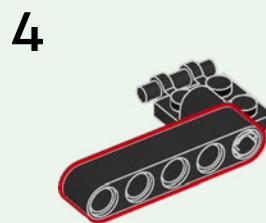
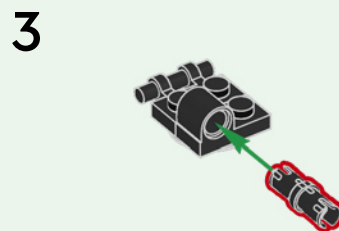
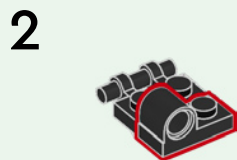
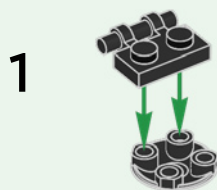

5

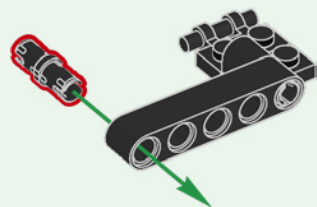

6

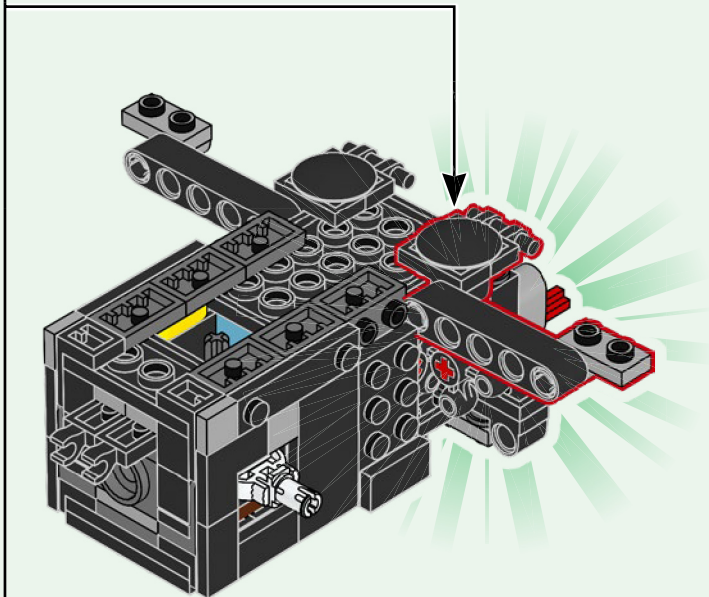
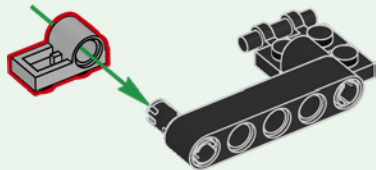

120

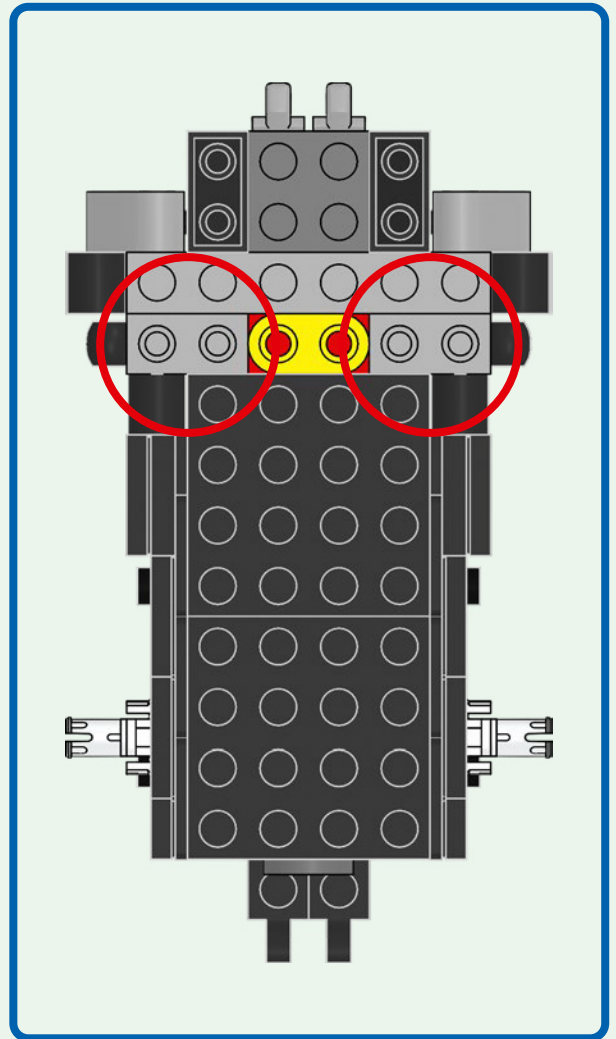
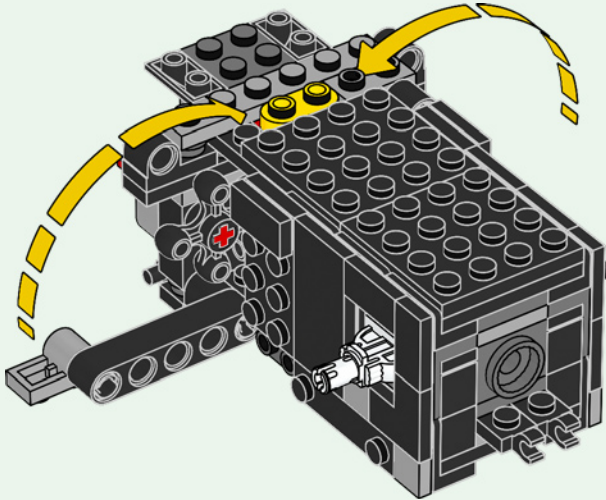

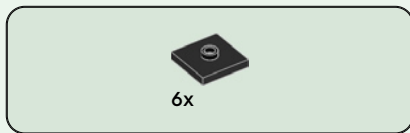

121

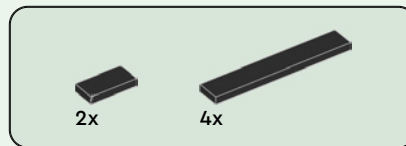
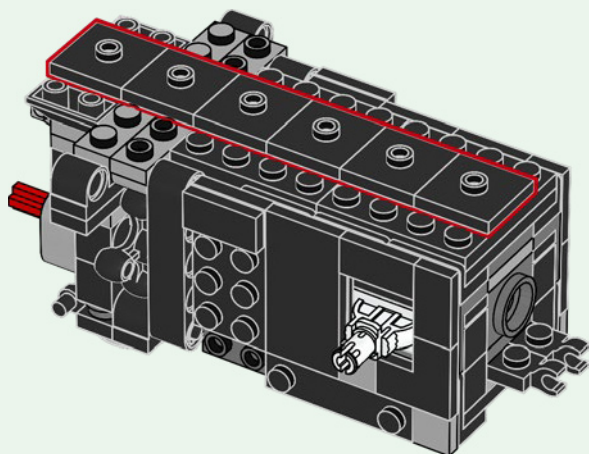

122

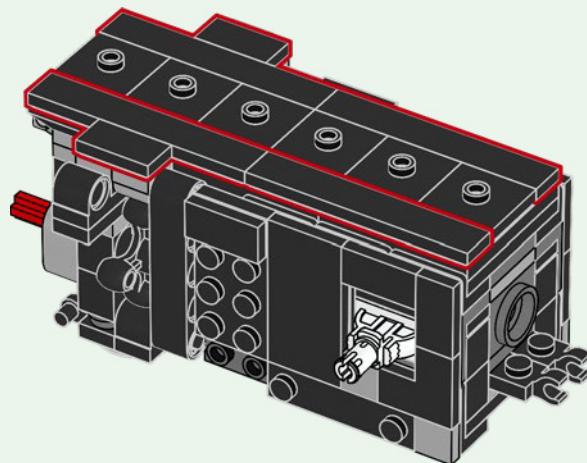

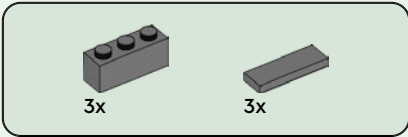

123

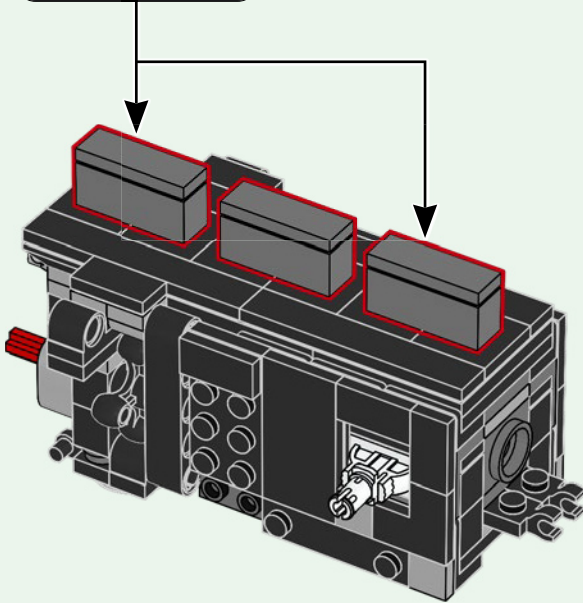
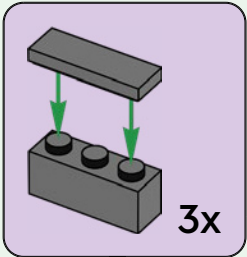

124

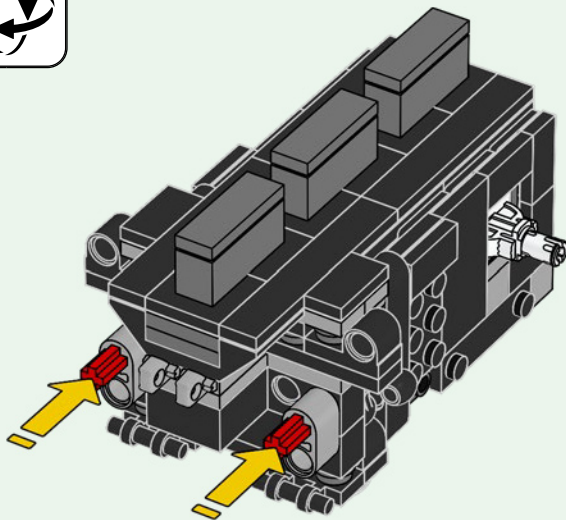

125

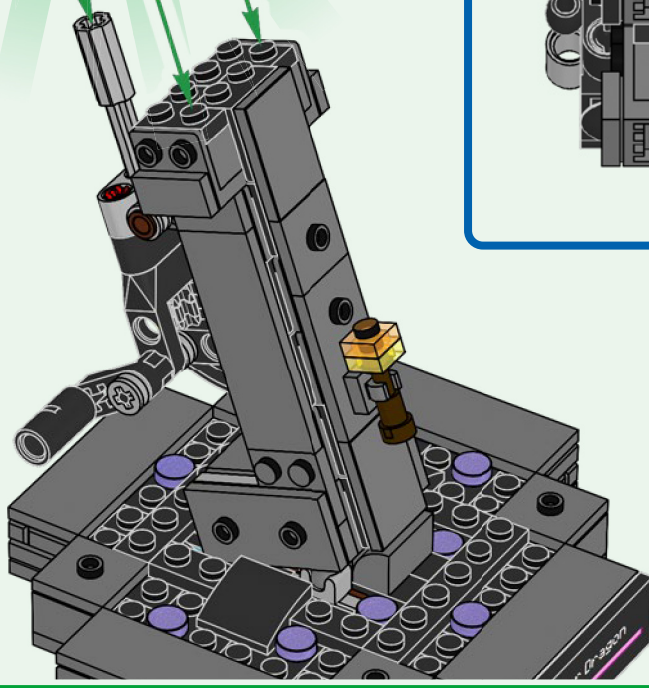
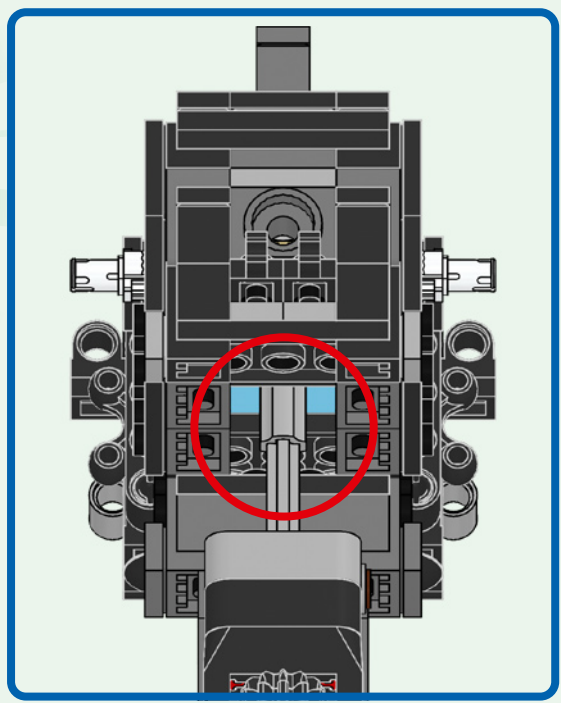
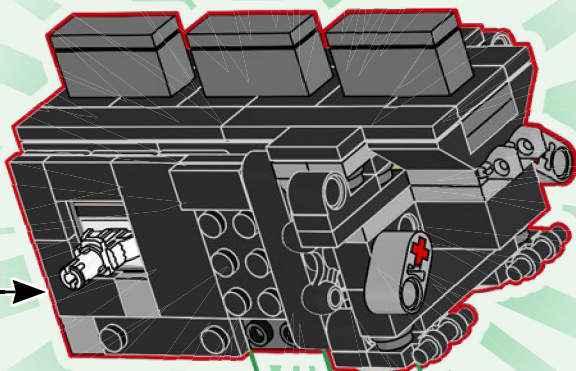



2x

126

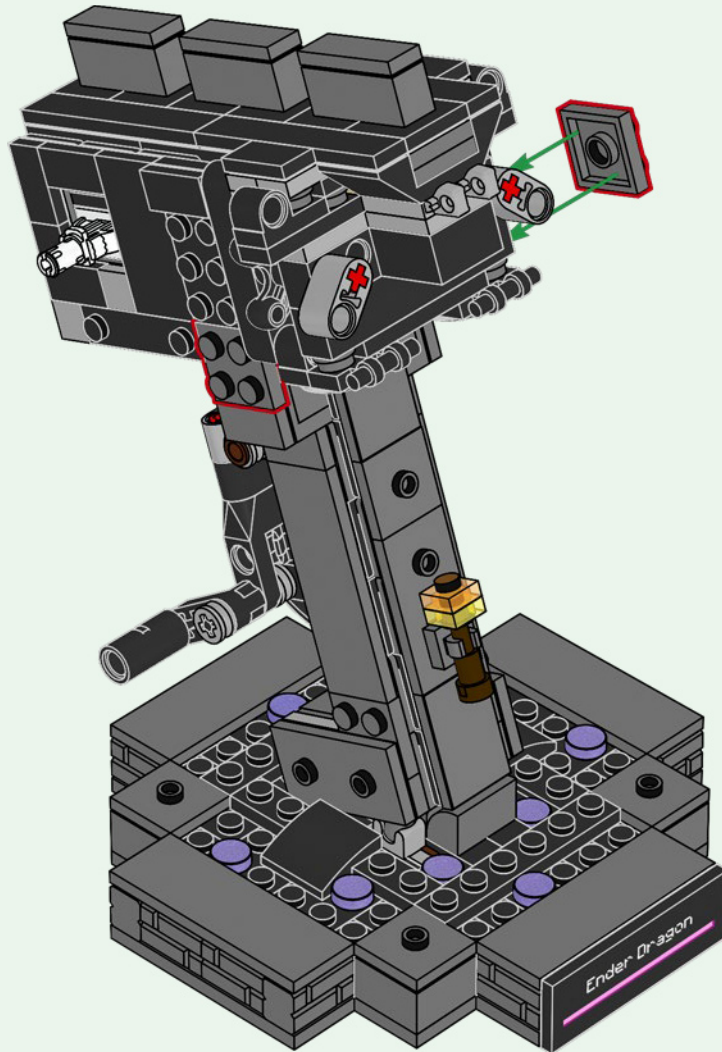



2x

127

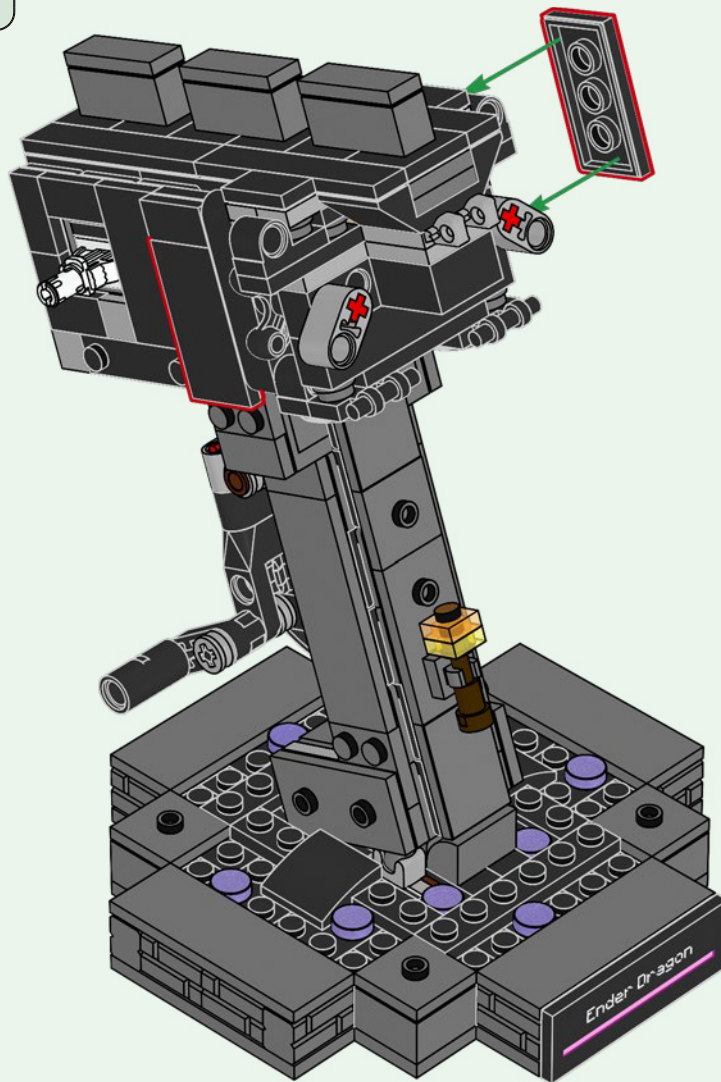

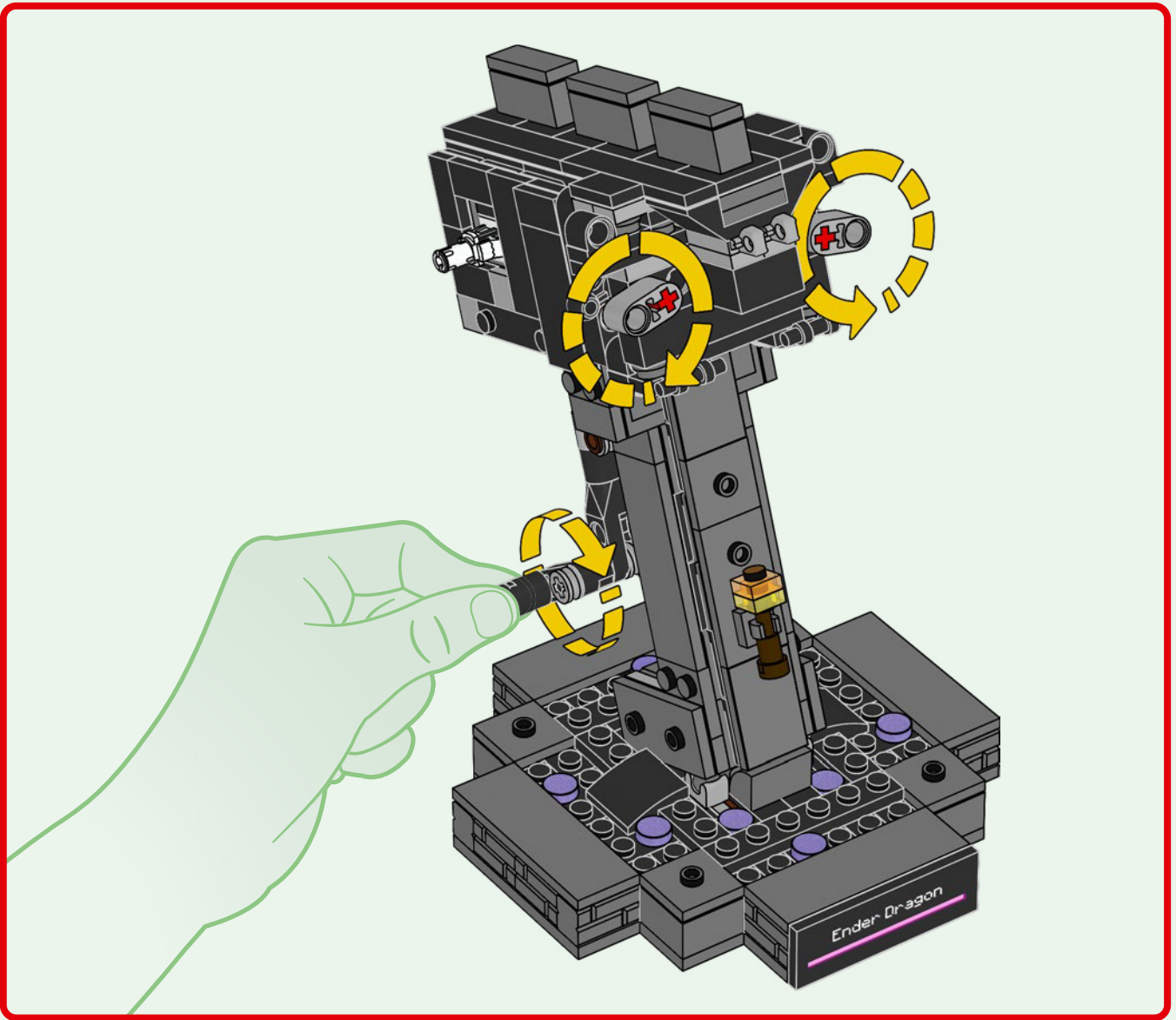

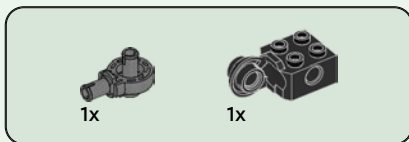
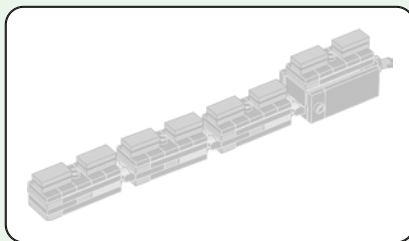

128

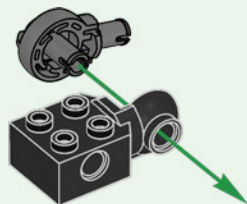

129



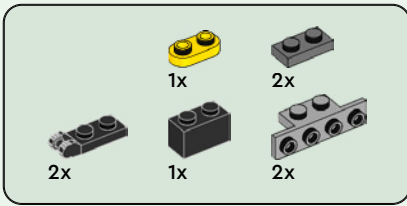

130

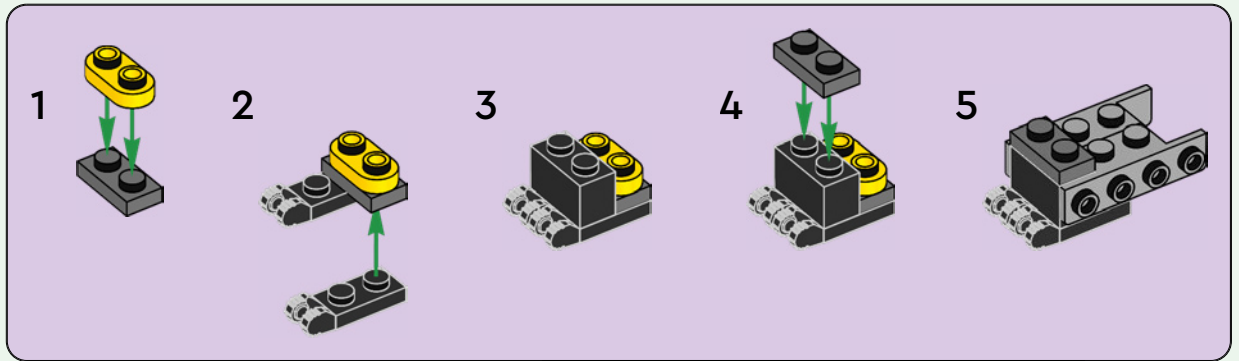

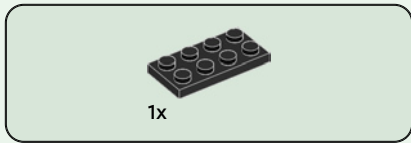

131

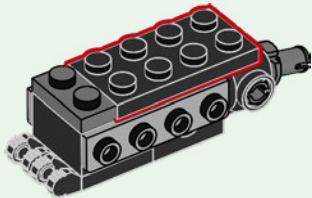

132

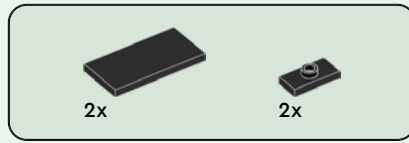
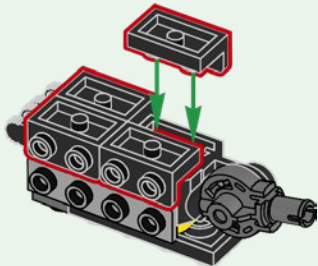

133

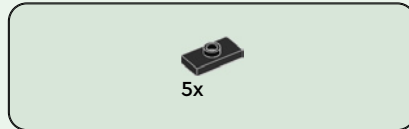
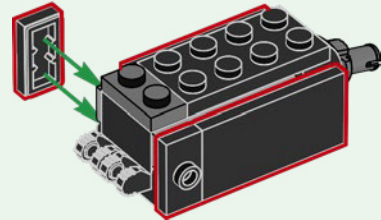
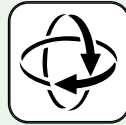

134

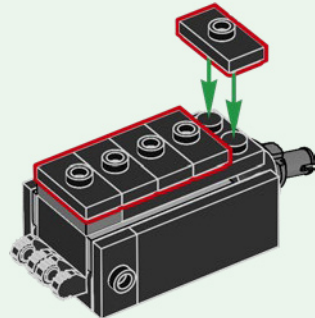



2x



1x



1x

135

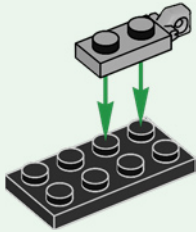

1x



1x

136

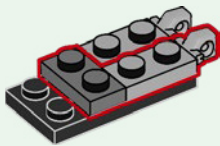

2x

137

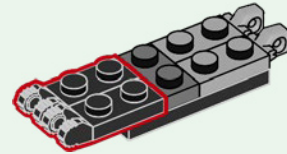

1x

138

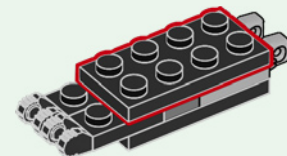



1x

139

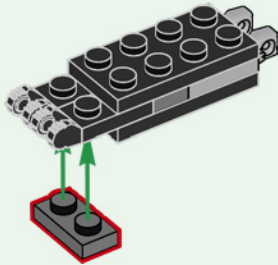

1x

140

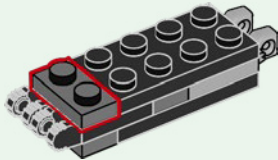

5x

141

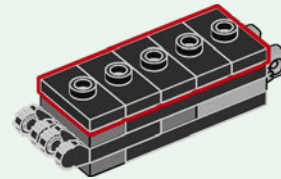

2x

142

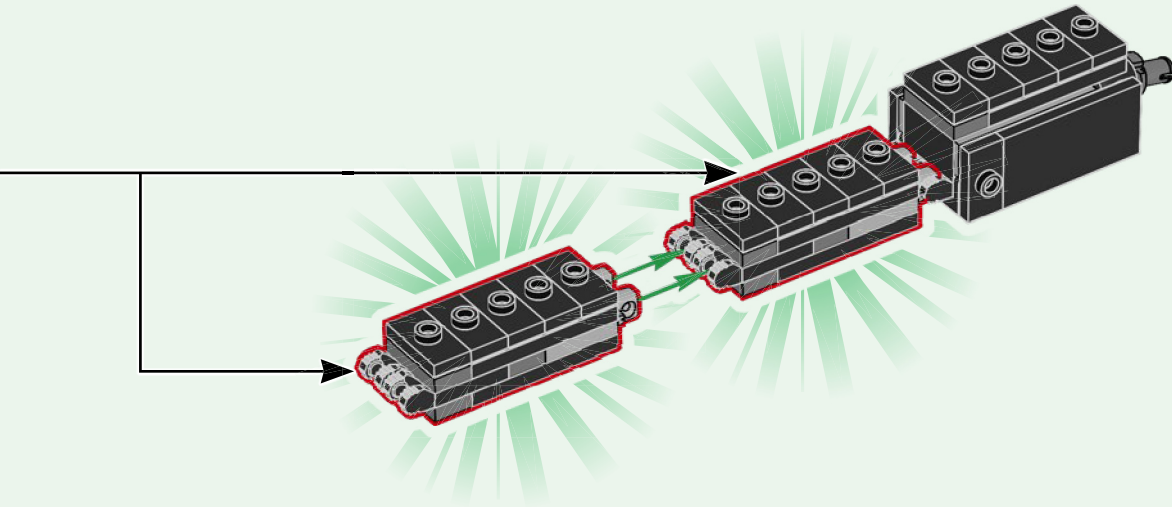

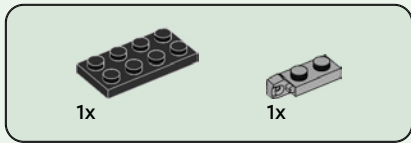

143

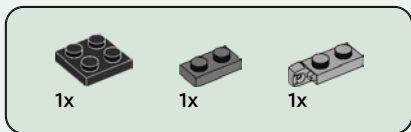
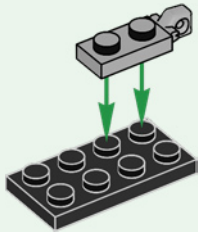

144

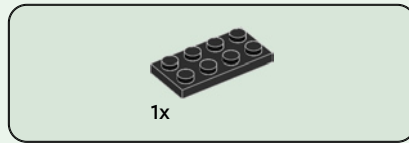

145

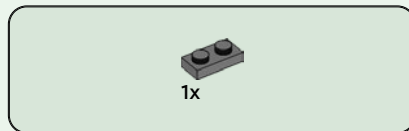
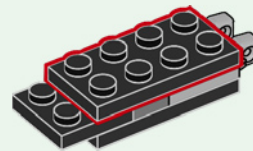

146

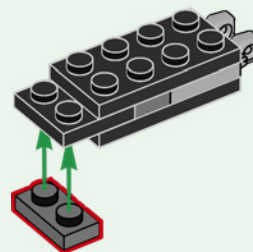



1x

147

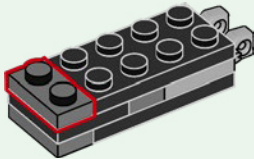

5x

148

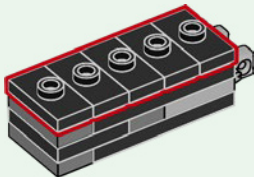

149

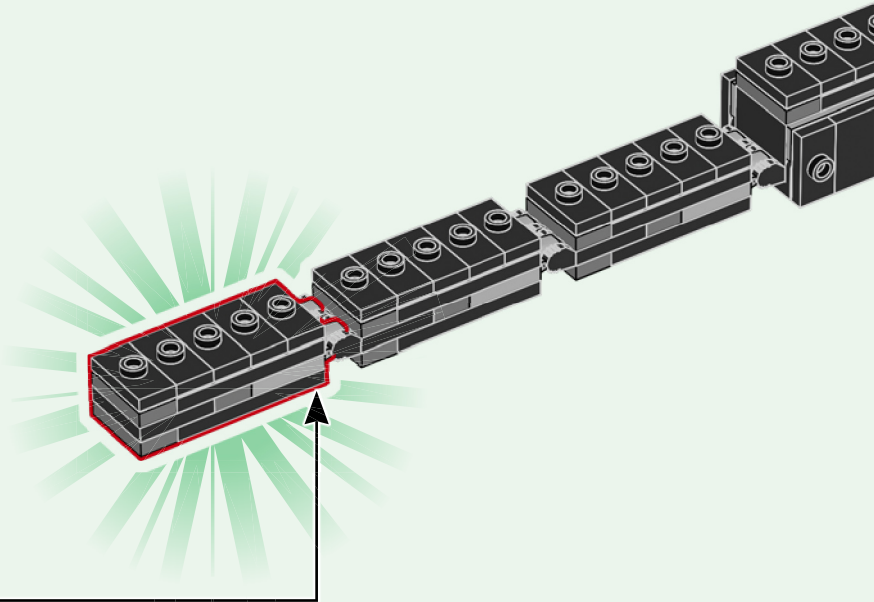

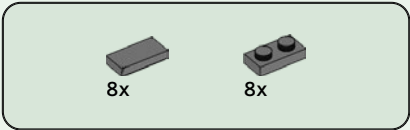

150

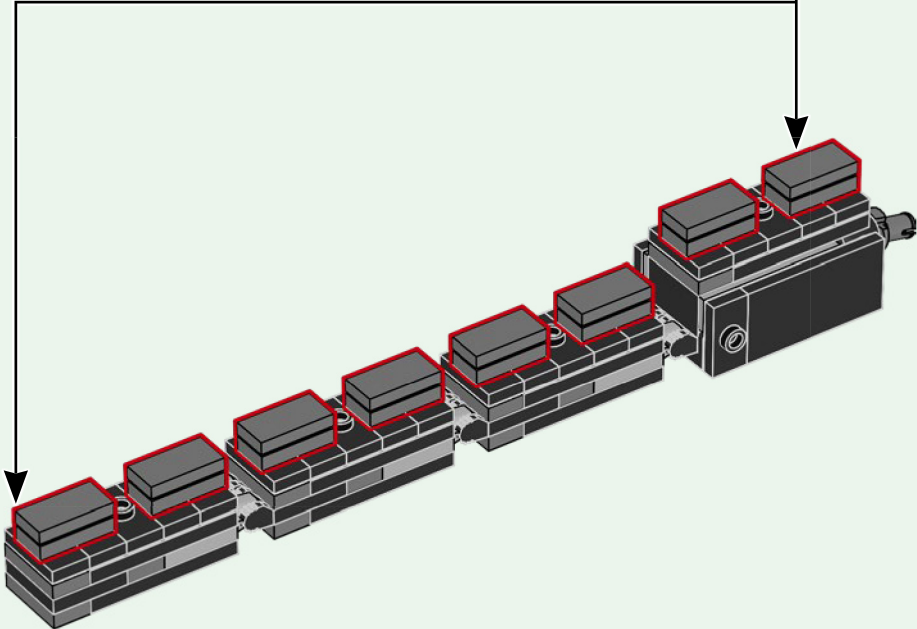
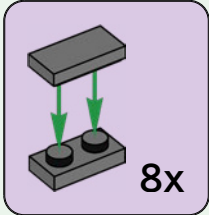

151

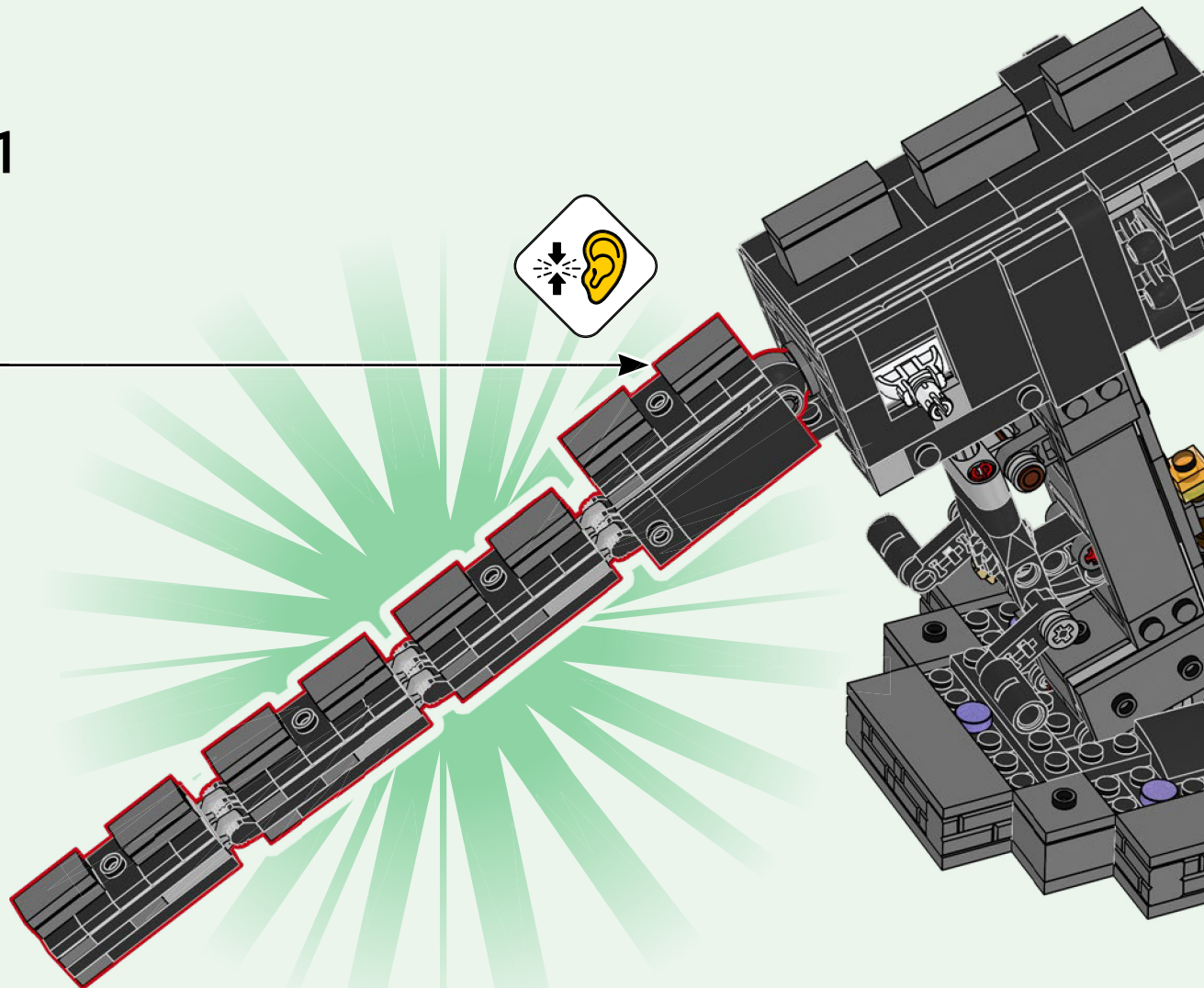

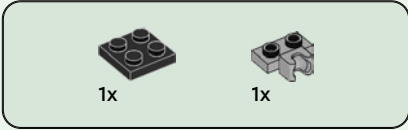
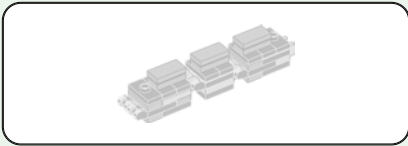

152

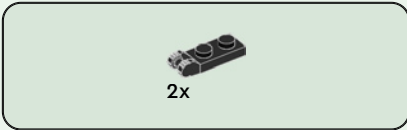
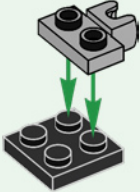

153

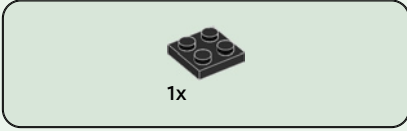
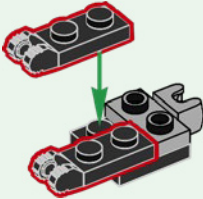

154

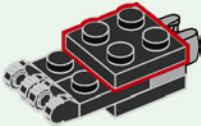



1x

155

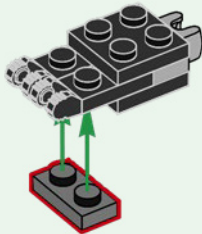

1x

156

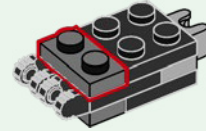

3x

157

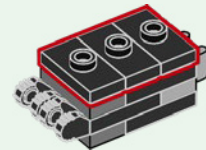

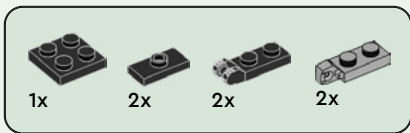

158

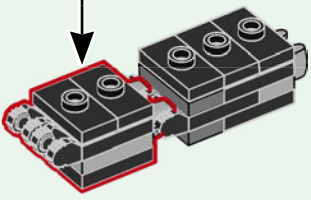
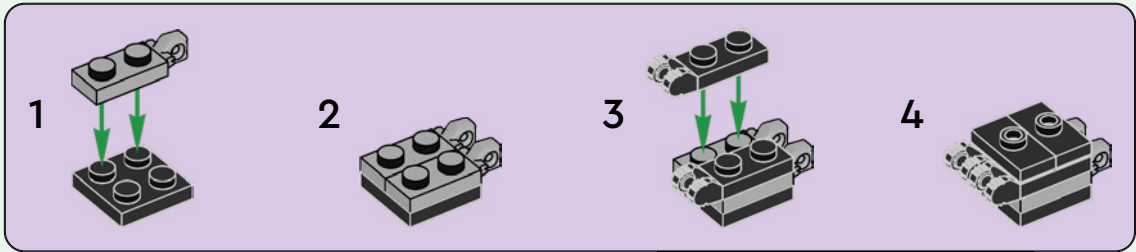

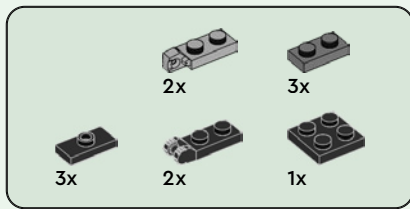

159

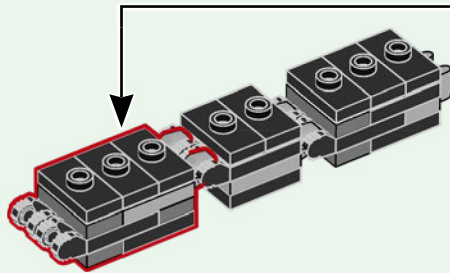
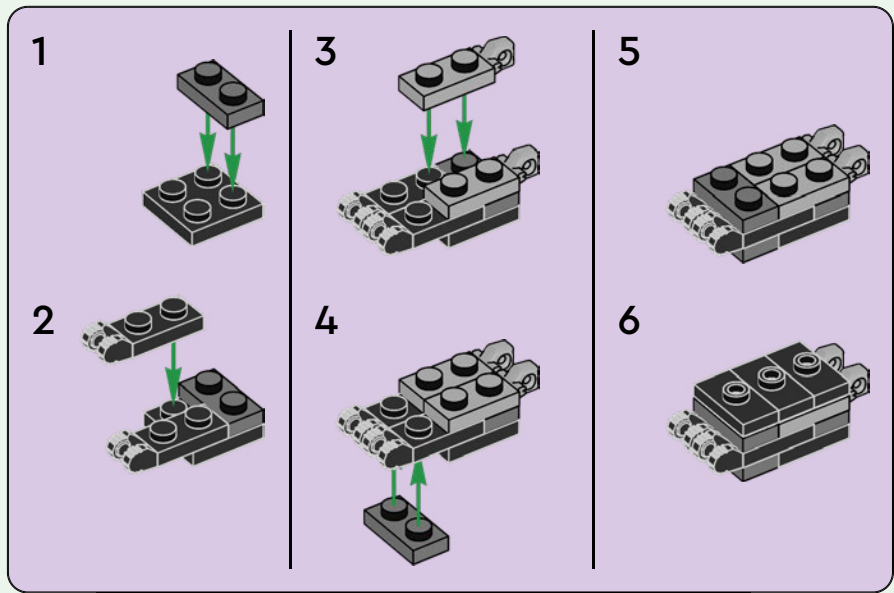

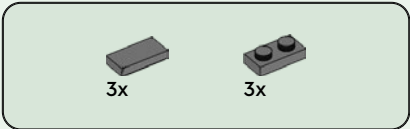

160

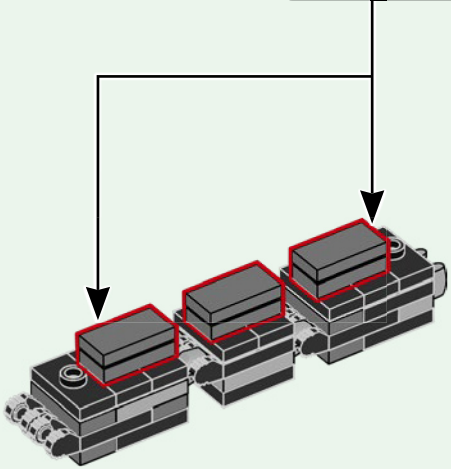
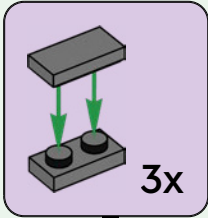

161

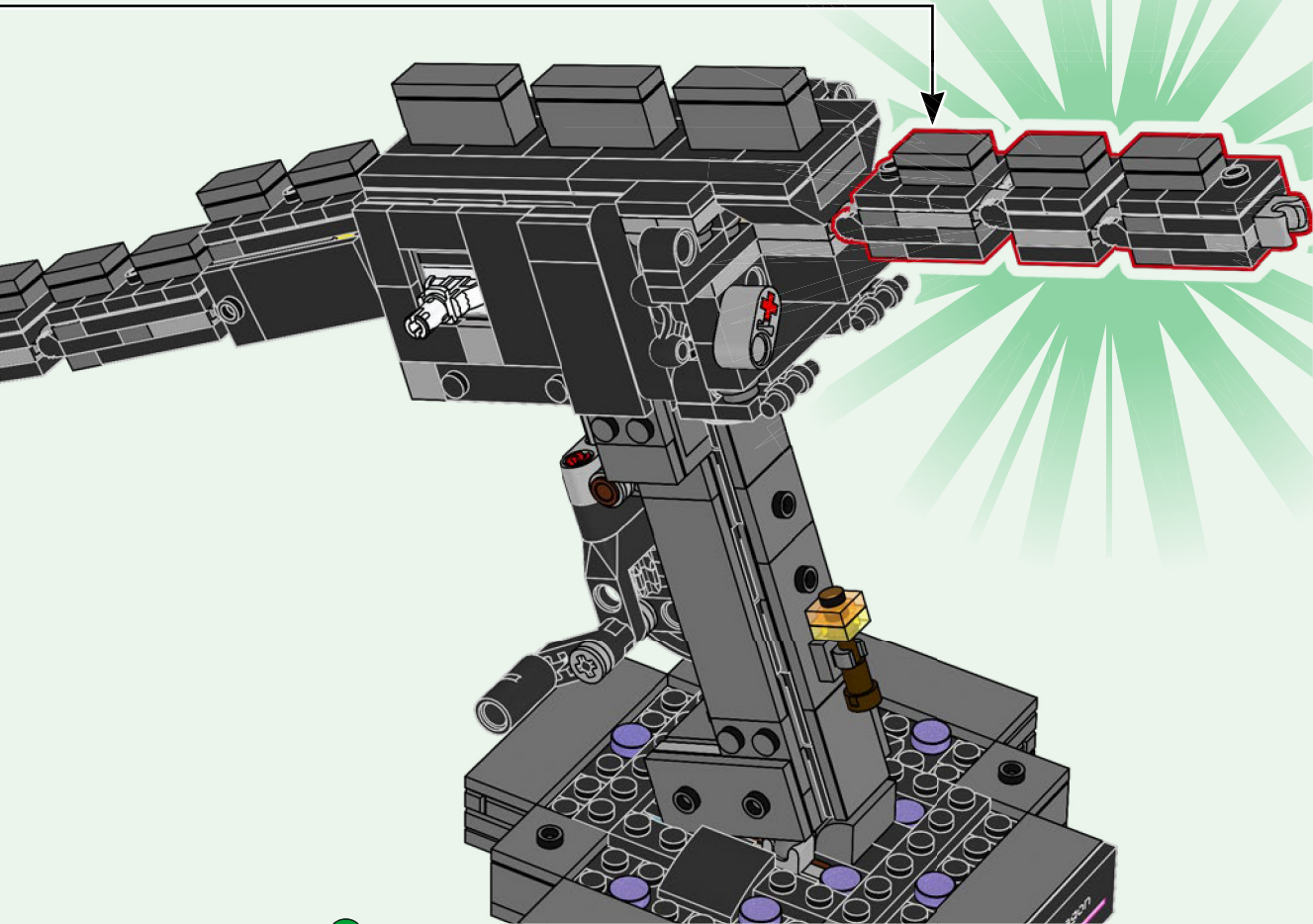



2x

163

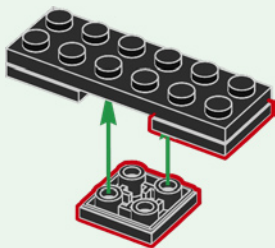

1x



1x

164

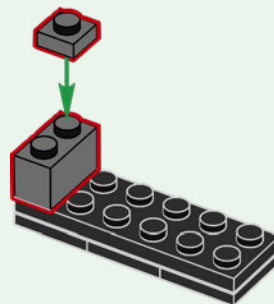



1x

165

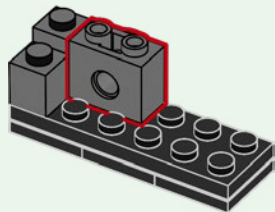

1x



1x

166

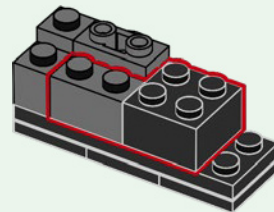



2x



1x

167

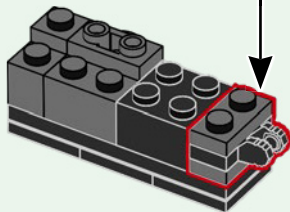
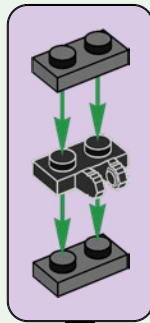

1x

168

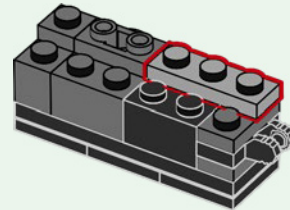

1x



1x

169

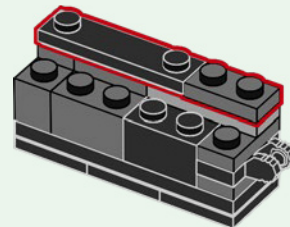



1x

170

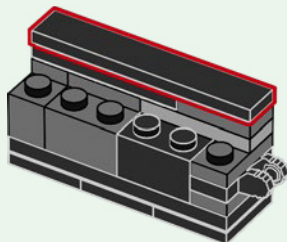

1x



2x

171

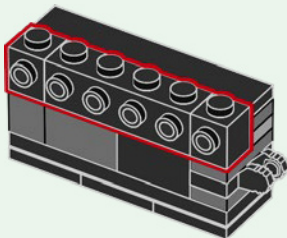

3x

172

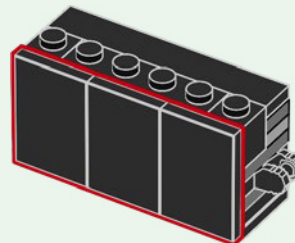

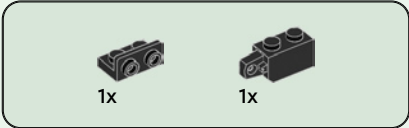
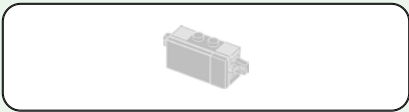

173

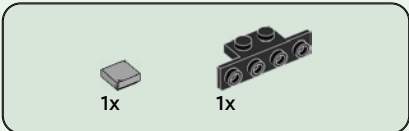
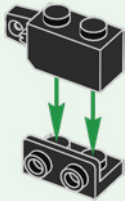

174

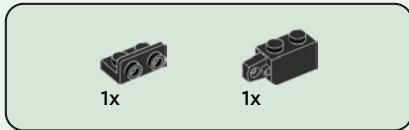
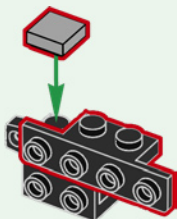

175

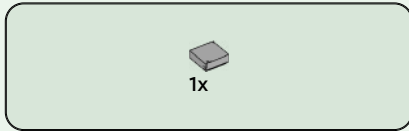
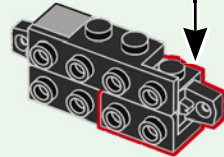
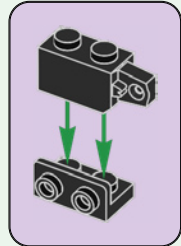

176

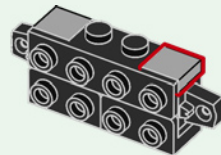

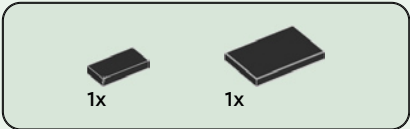

177

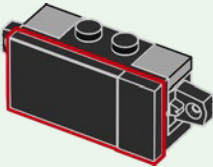

178

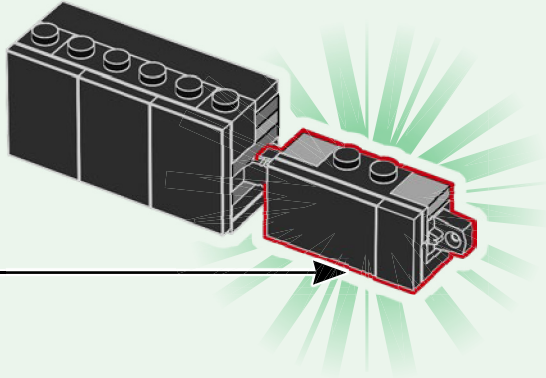

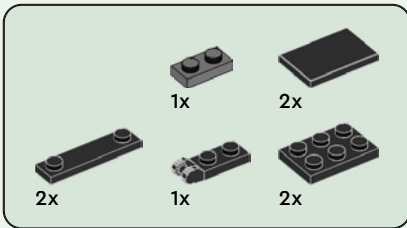

179

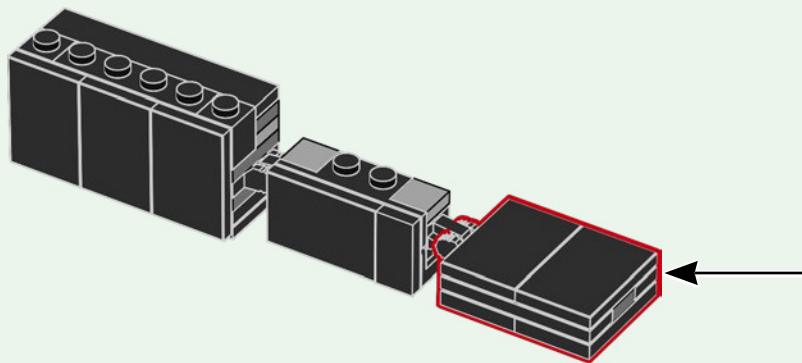
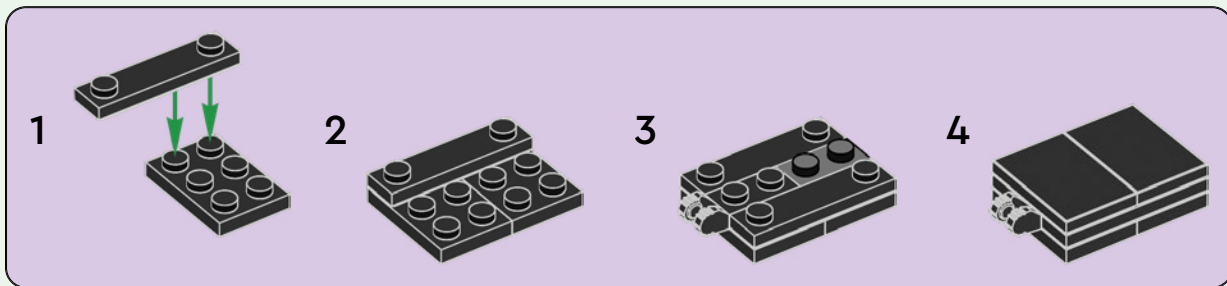

180

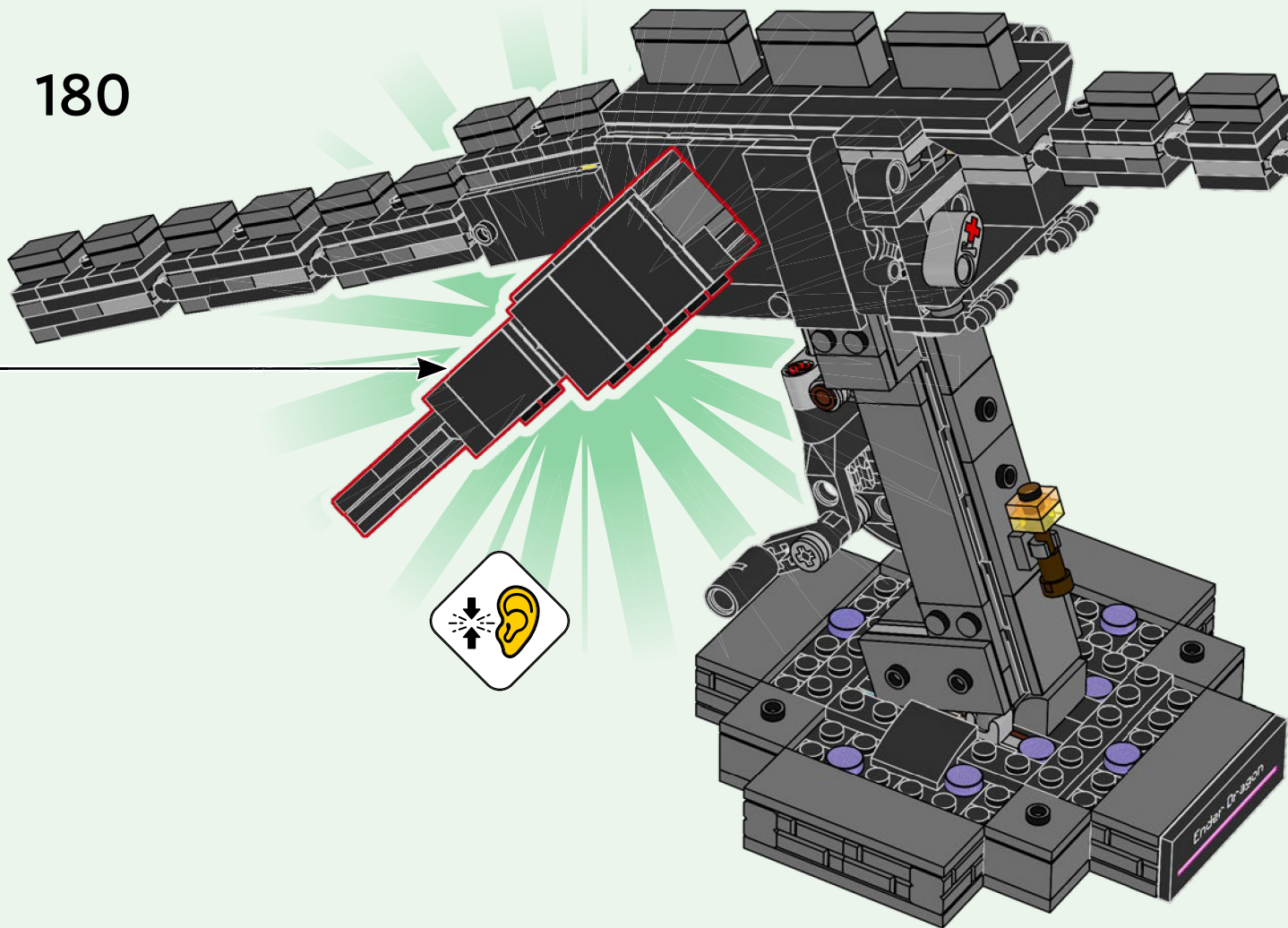

181

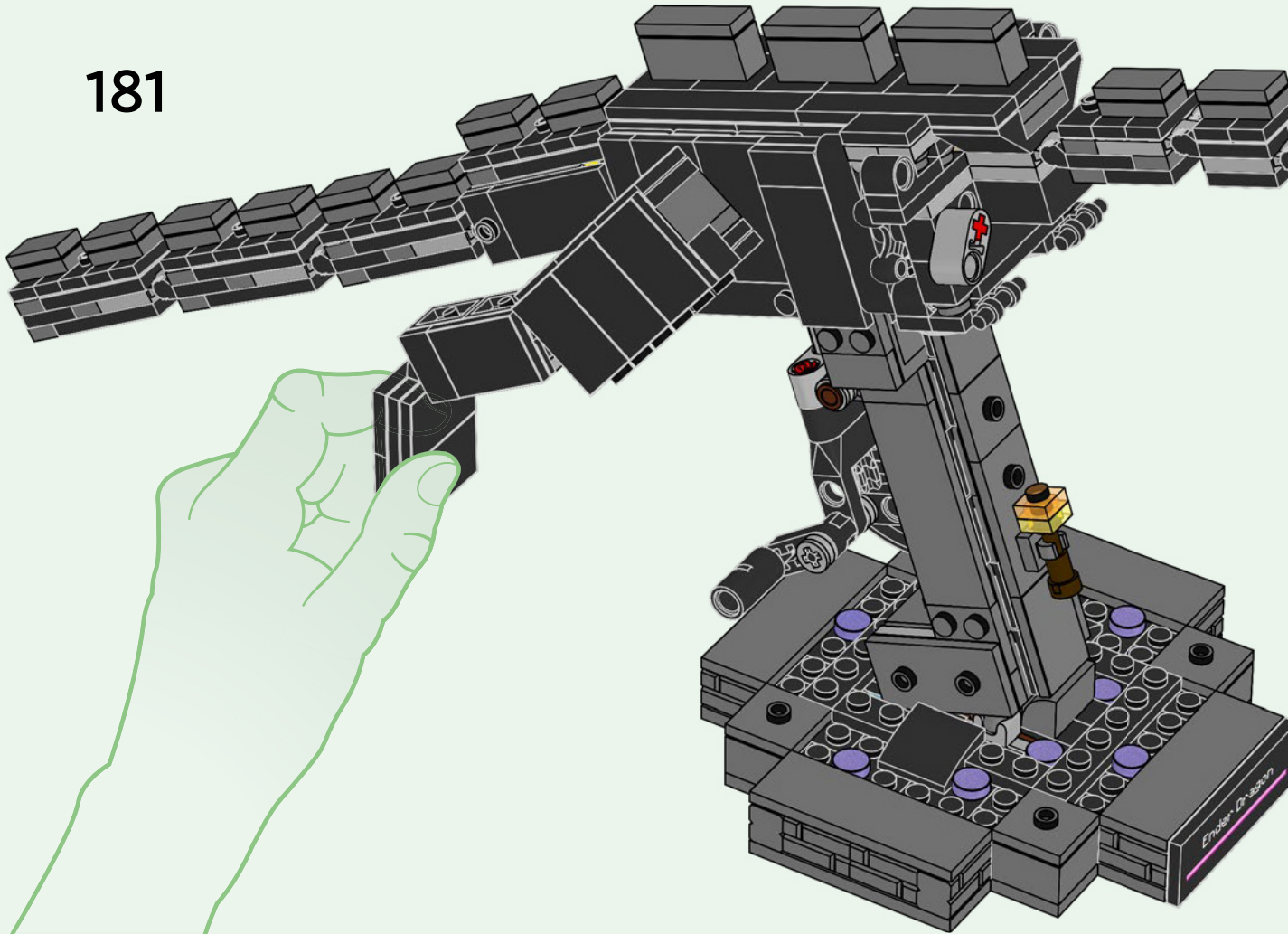

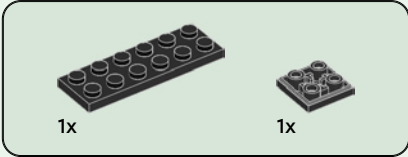
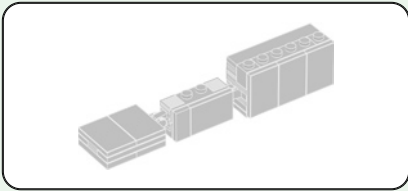

182

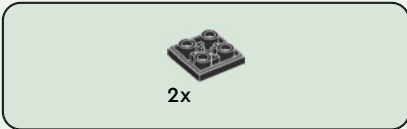
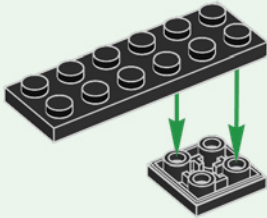

183

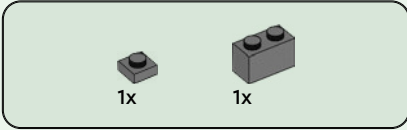
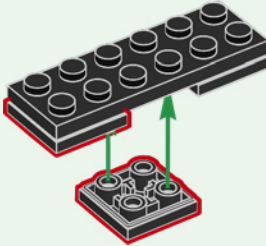

184

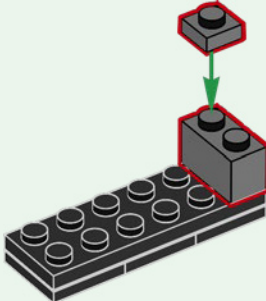



1x

185

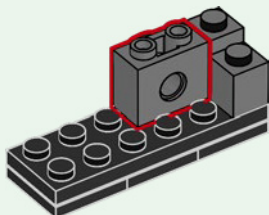

1x



1x

186

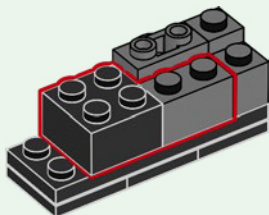

2x



1x

187

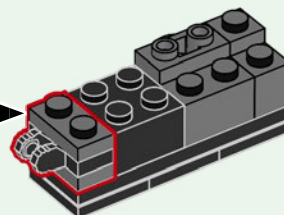
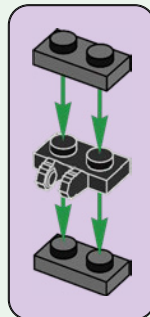

1x

188

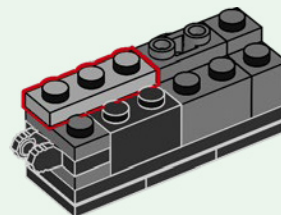

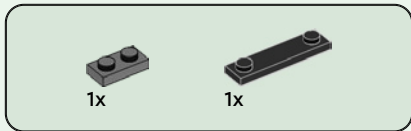

189

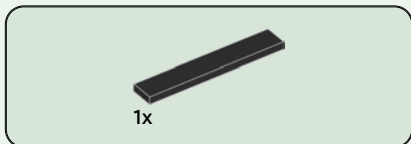
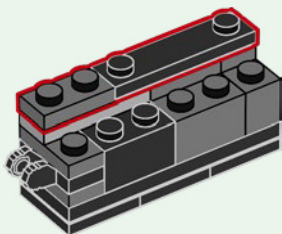

190

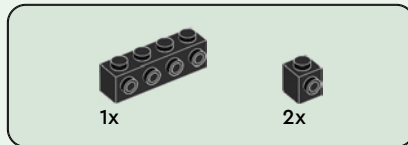
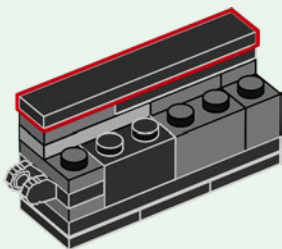

191

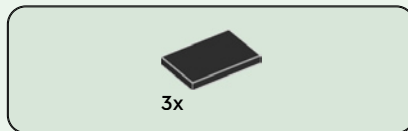
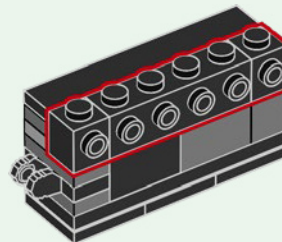

192

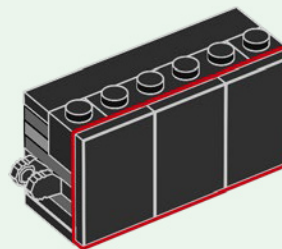

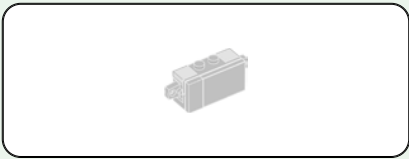

193

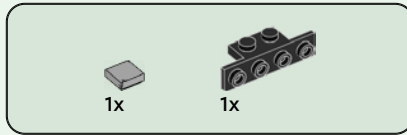
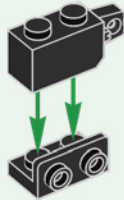

194

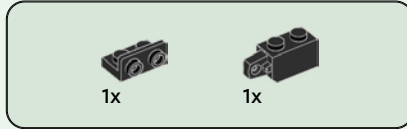
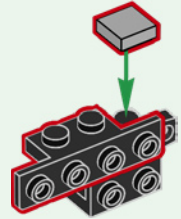

195

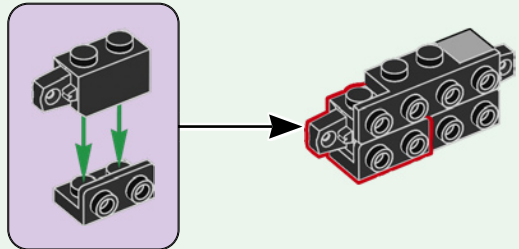



196

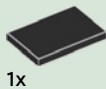
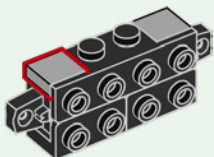

197

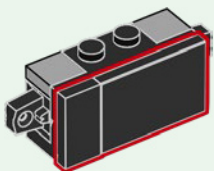

198

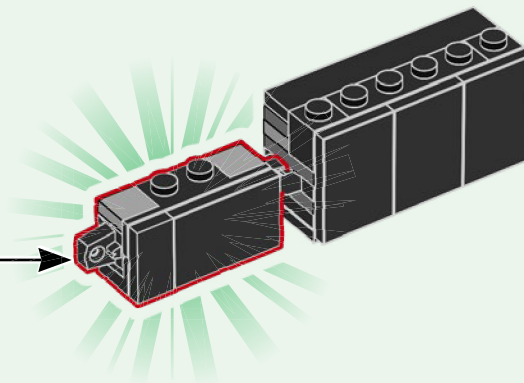

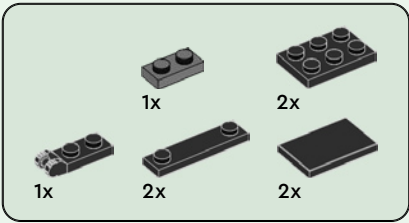

199

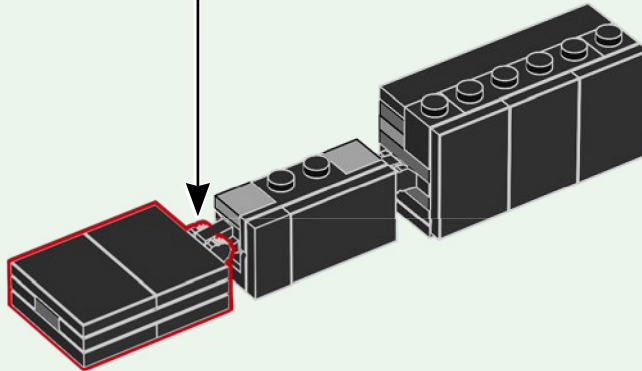
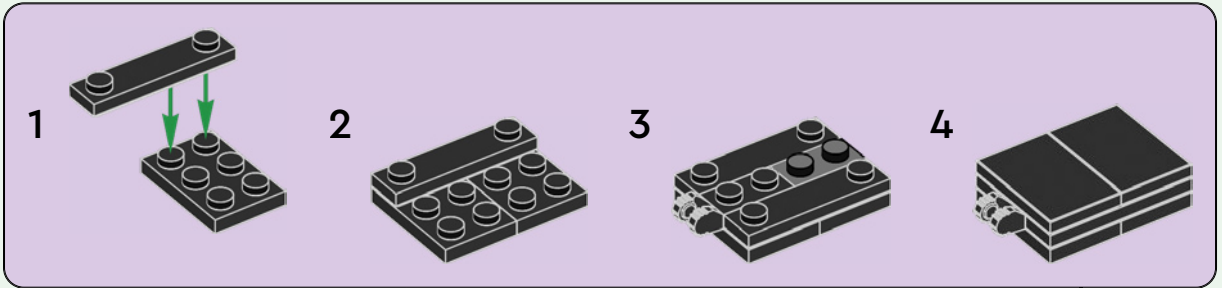

200

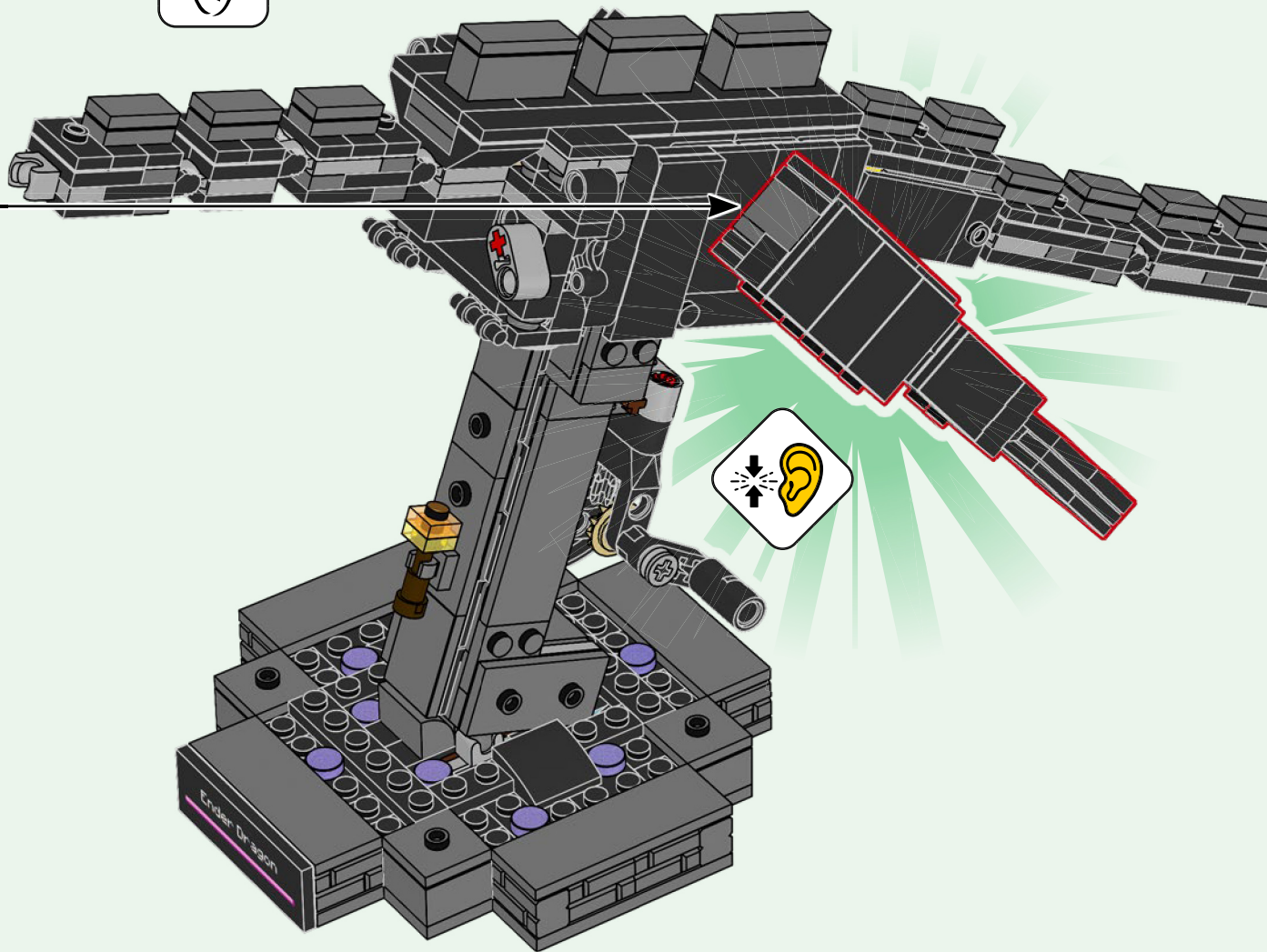

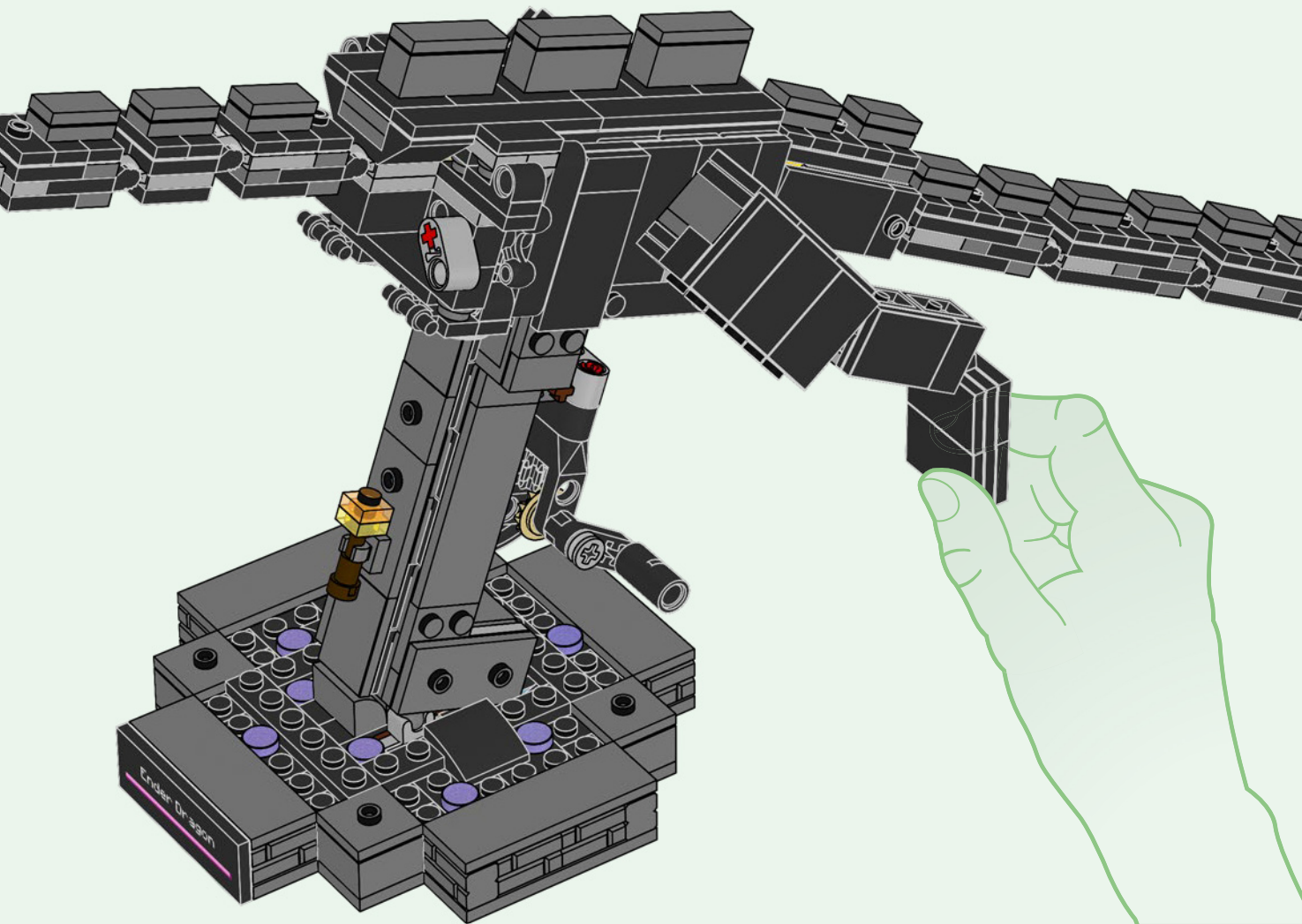



2x



1x



1x

202

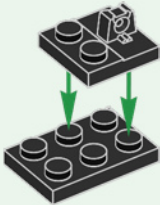

1x

203

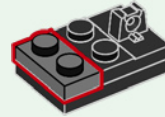

2x

204

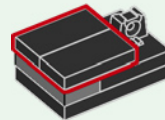

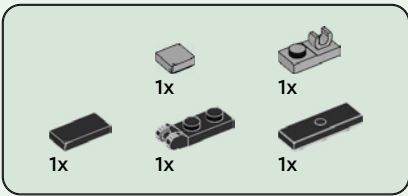

205

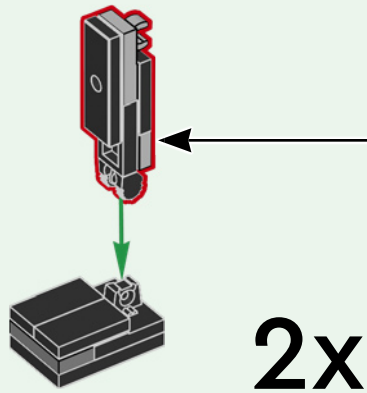
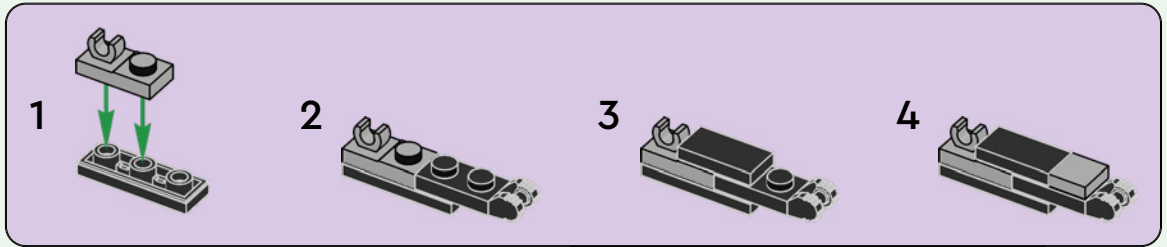

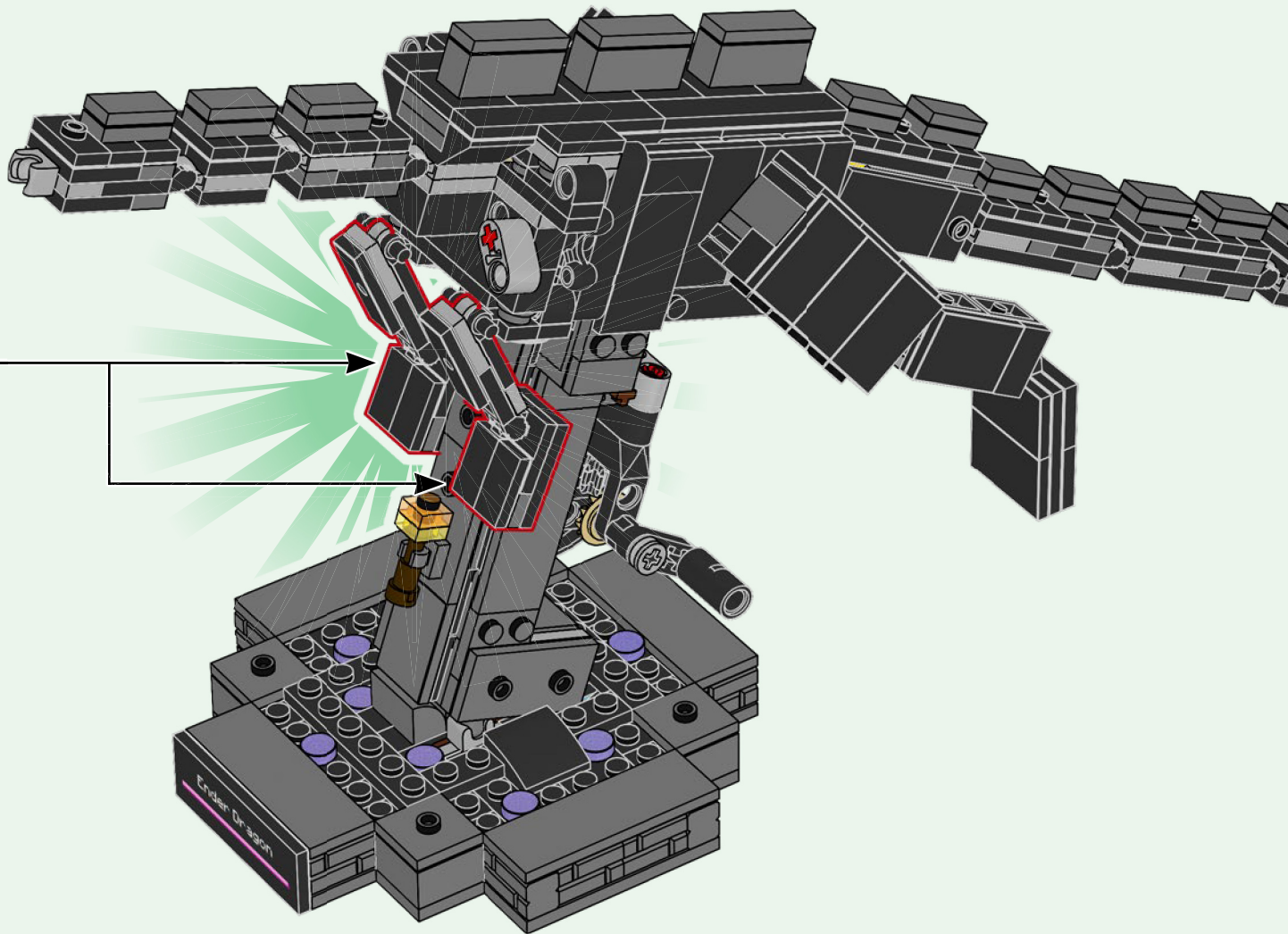

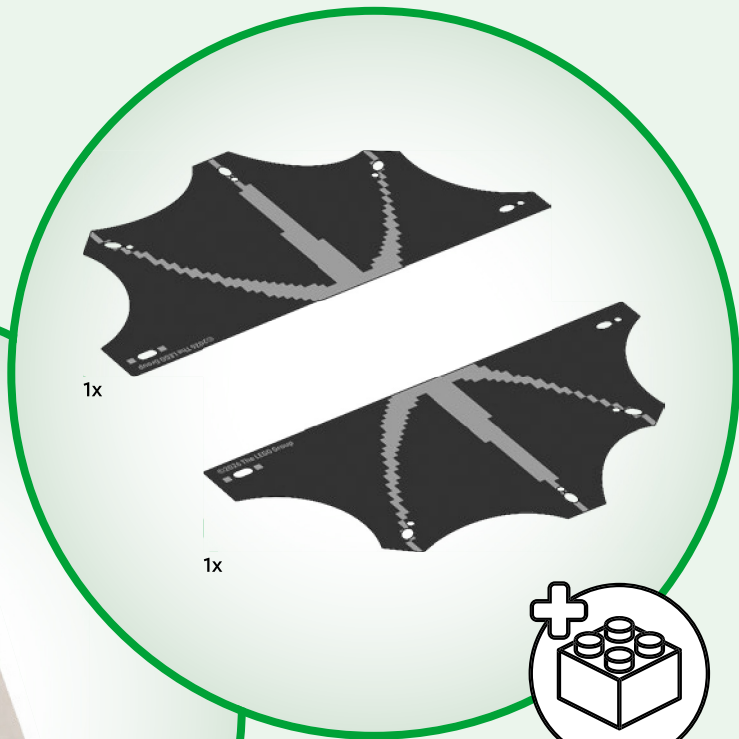
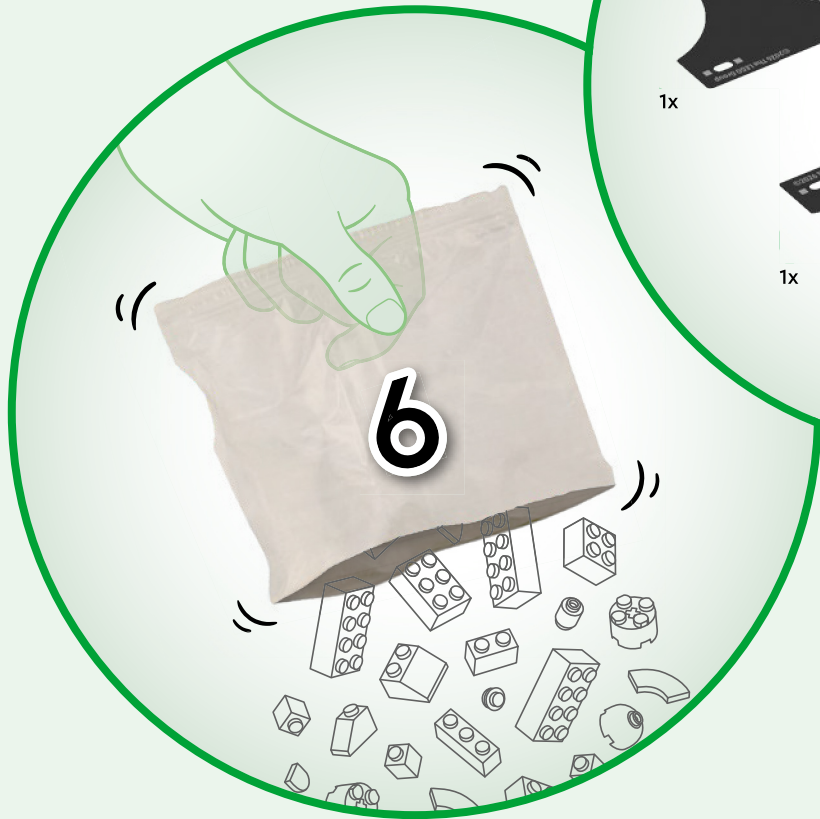

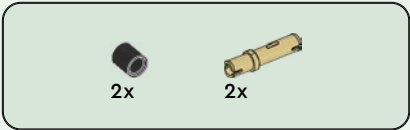

207

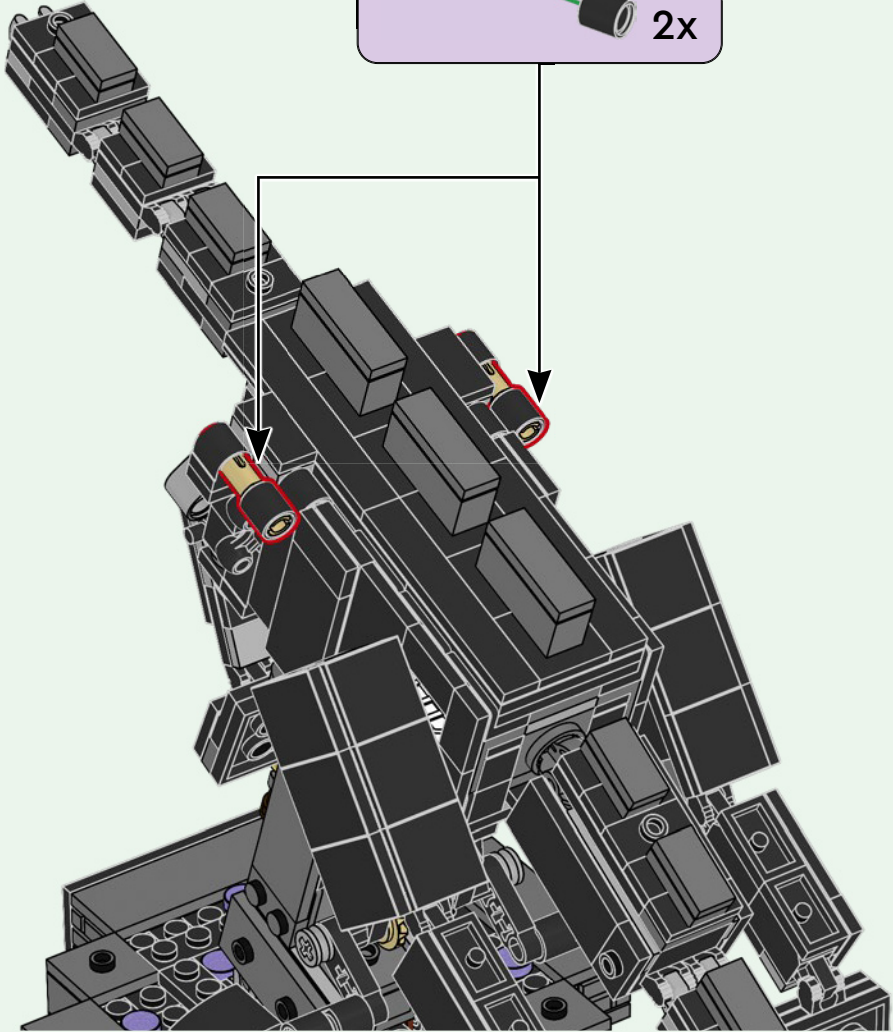
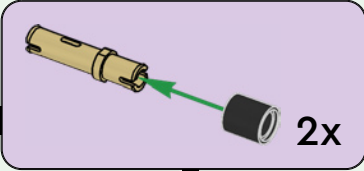

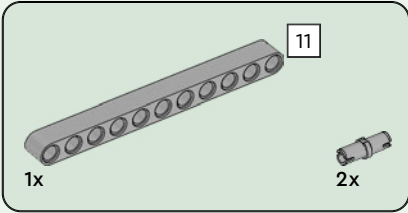
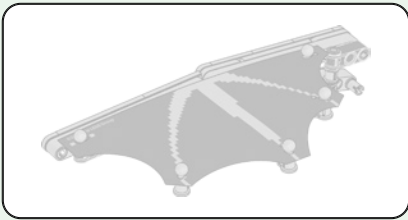

208

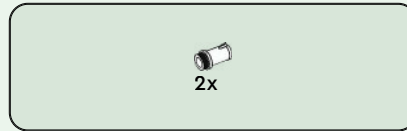
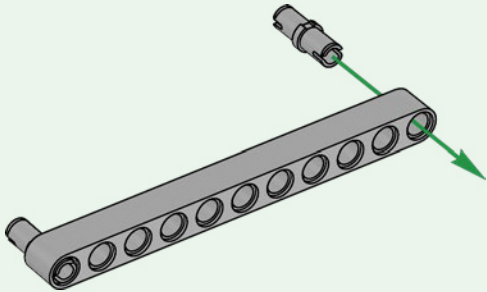

209

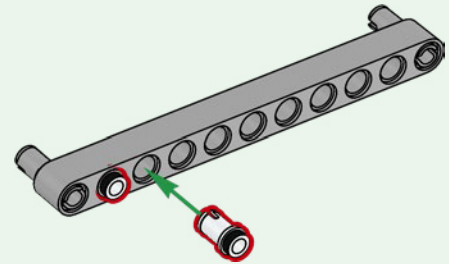

210

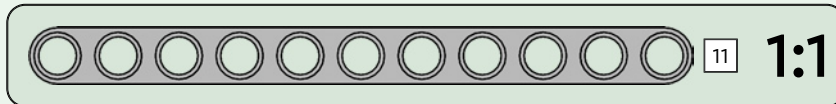
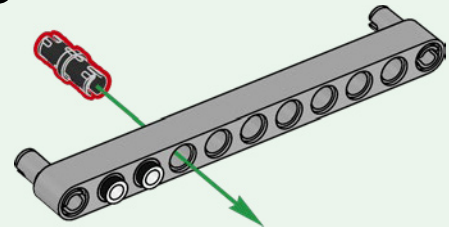

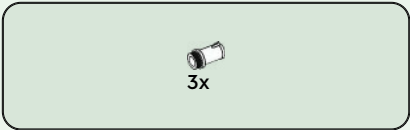

211

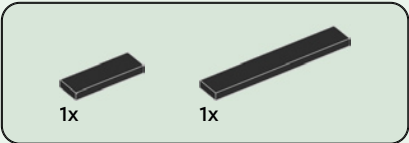
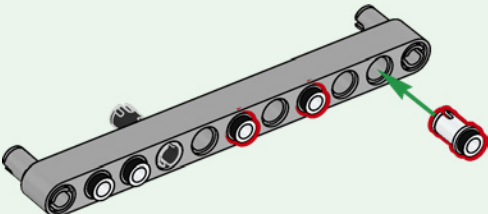

212

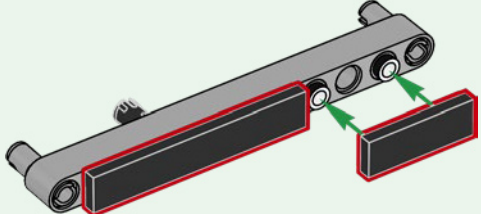

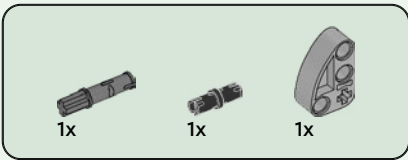

213

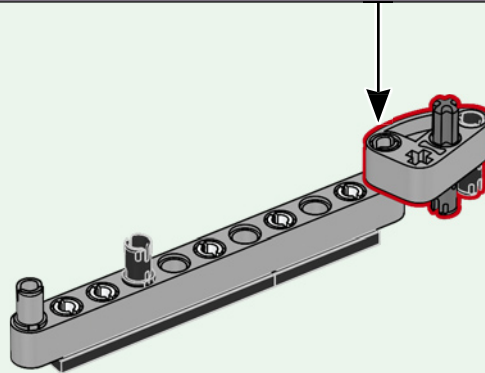
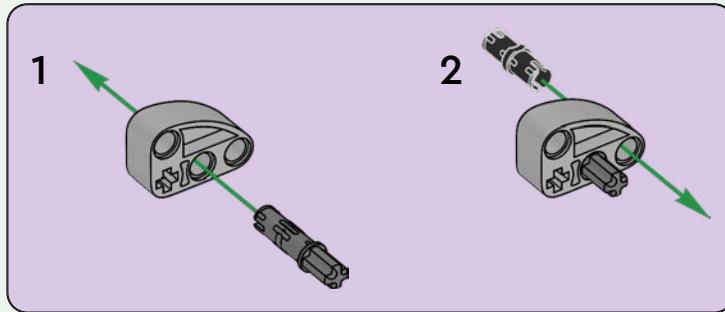

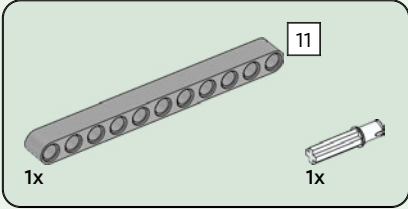
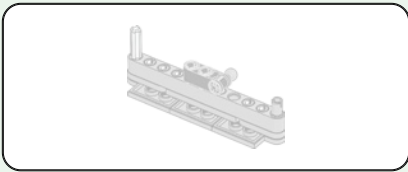

214

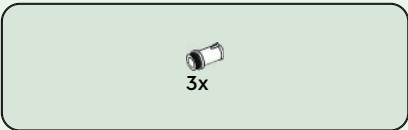
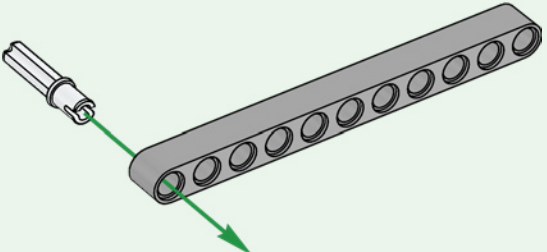

215

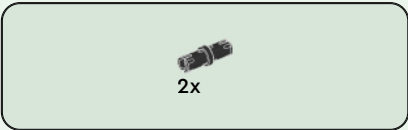
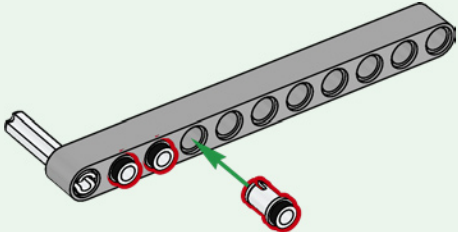

216

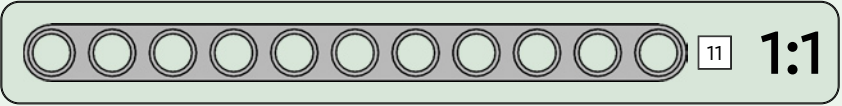
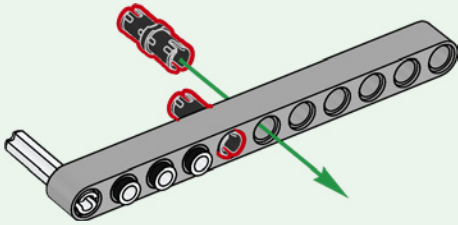

1x

217

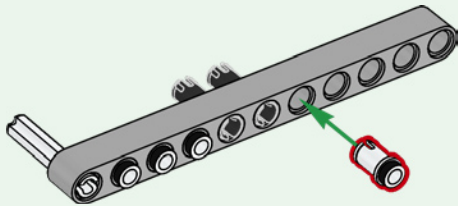

1x

218

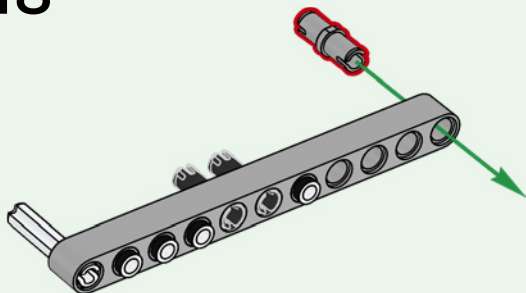

2x

219

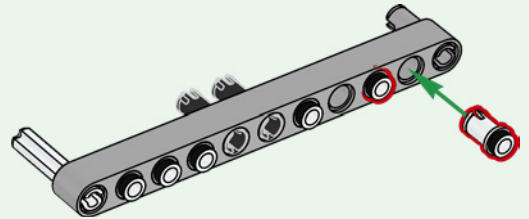

1x

2x

220

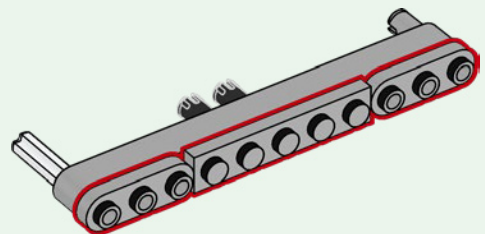



221

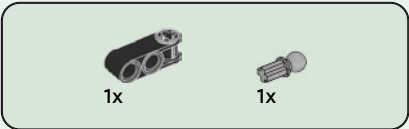
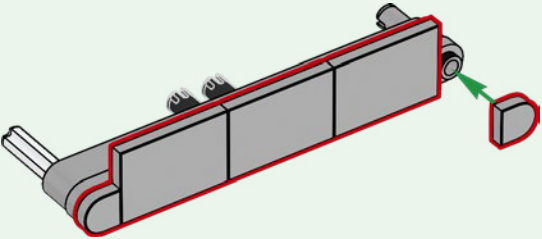

222

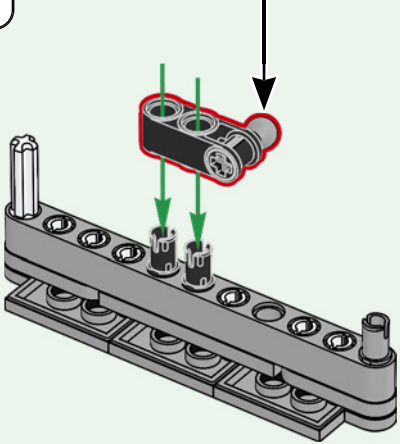
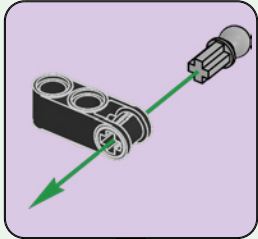

223

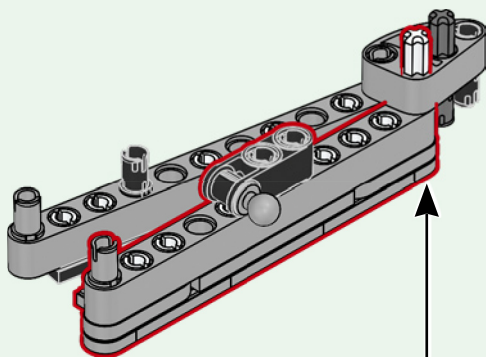

224

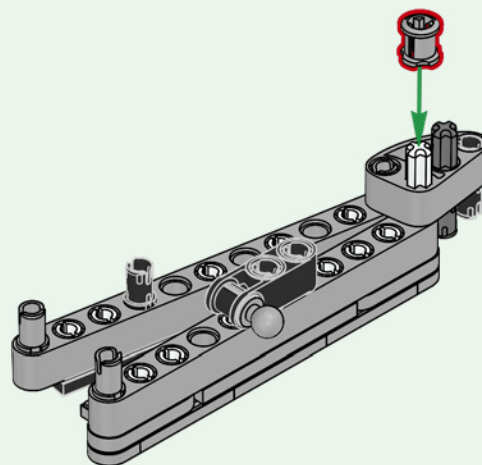
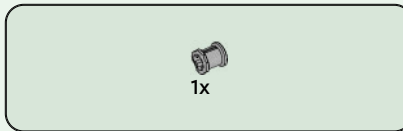

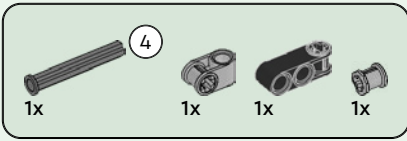

225

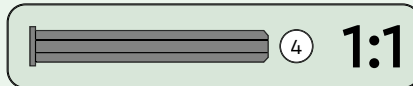
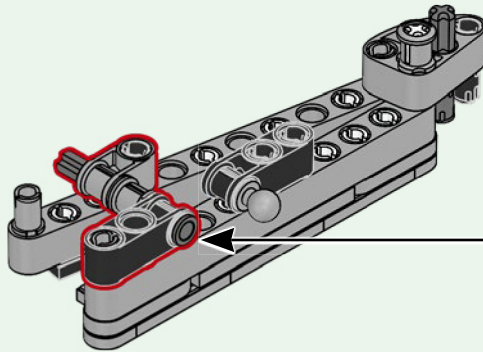
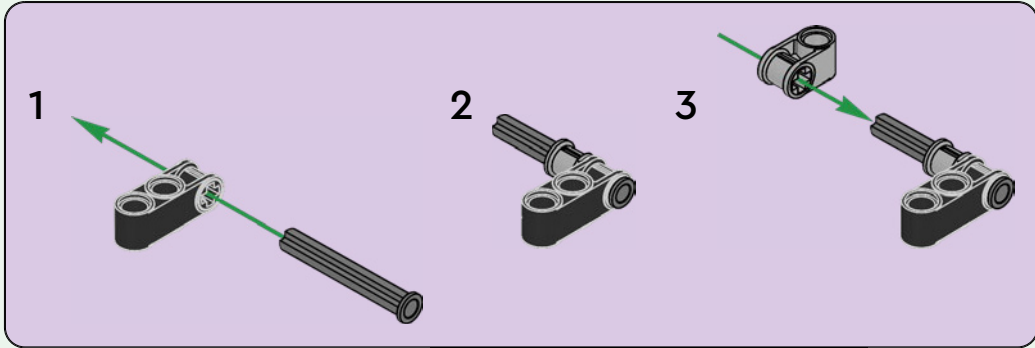

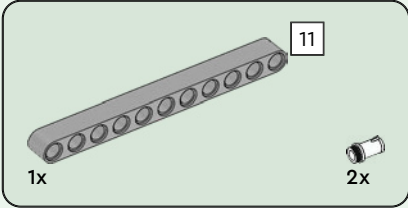
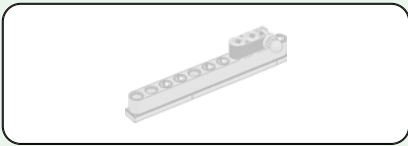

226

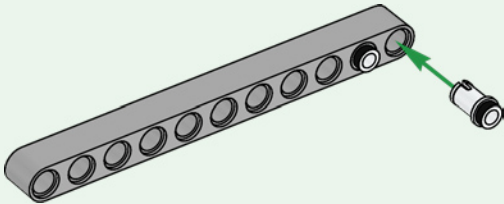

227

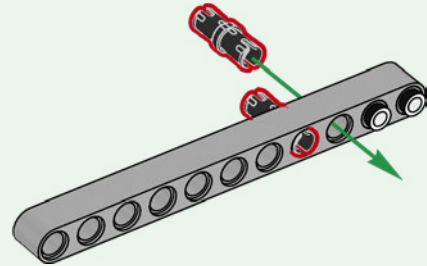

228

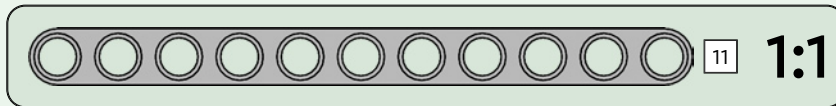
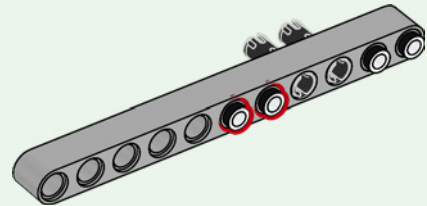

2x

229

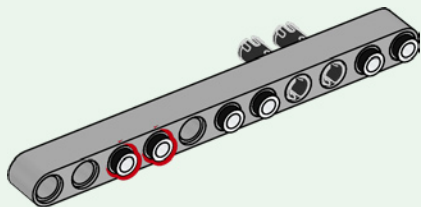

1x

1x

1x

230

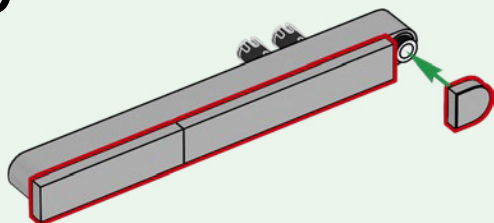

1x

1x

231

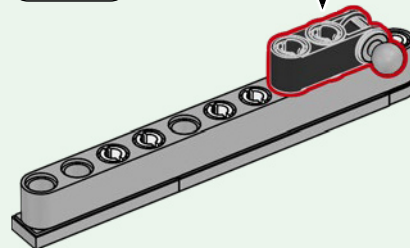
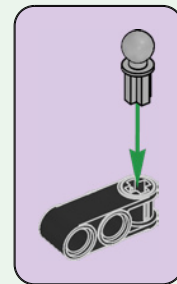
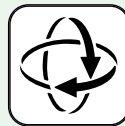

232

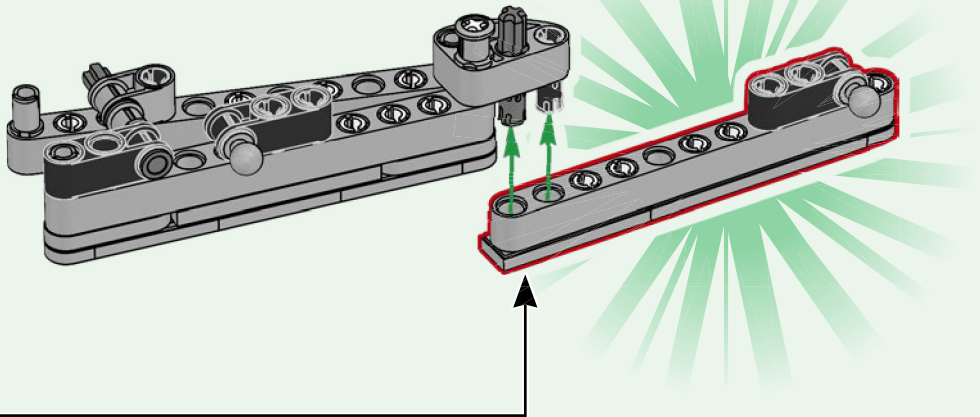

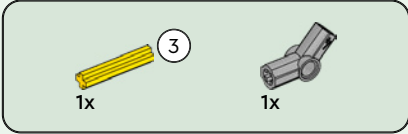
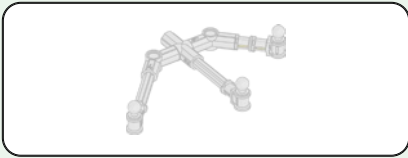

233

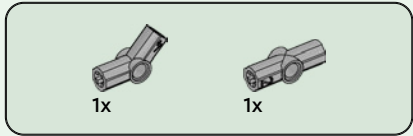
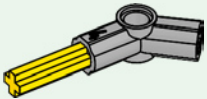

234

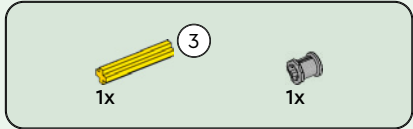
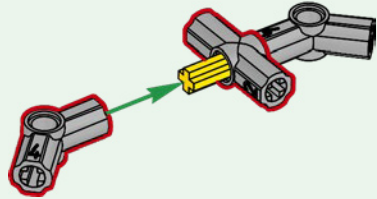

235

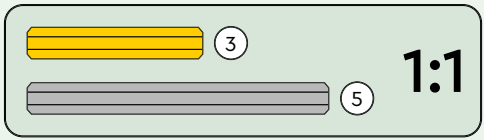
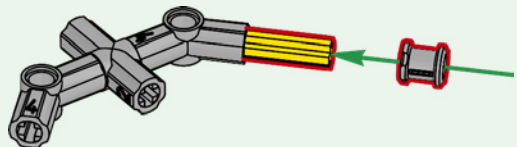

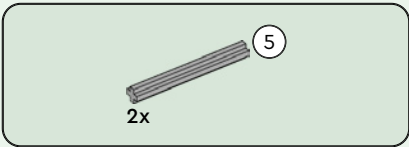

236

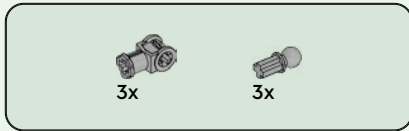
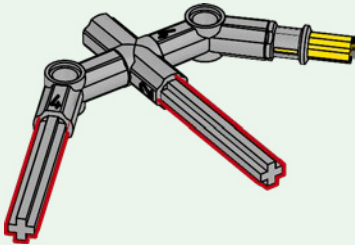

237

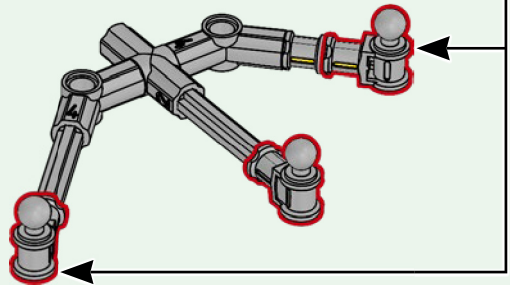
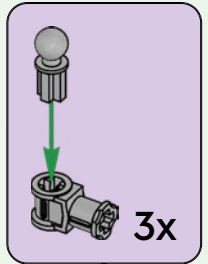

238

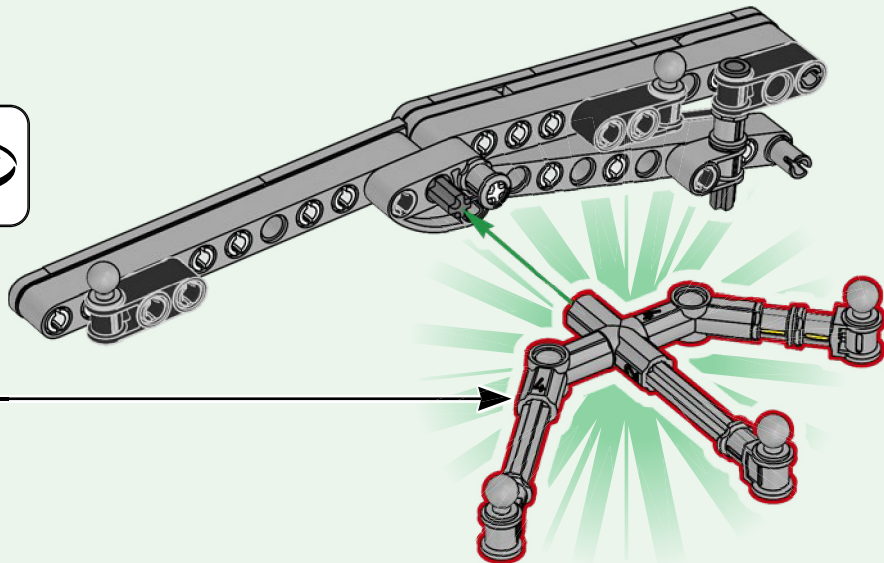
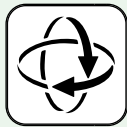

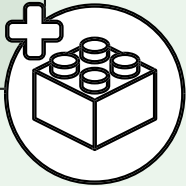
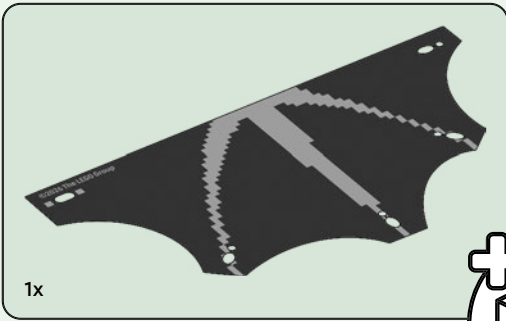

239

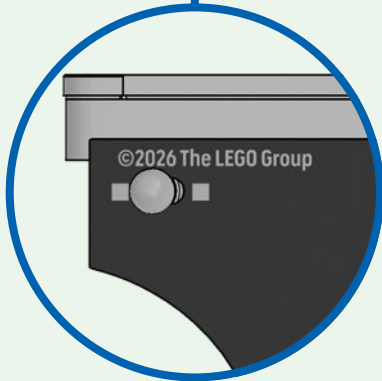
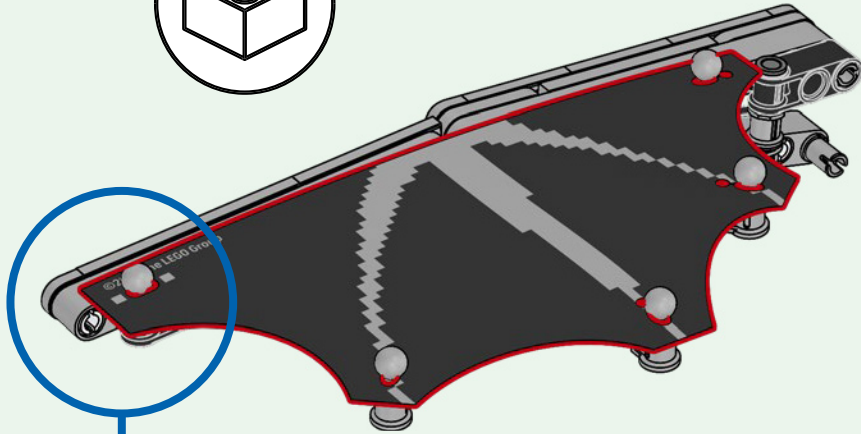

240

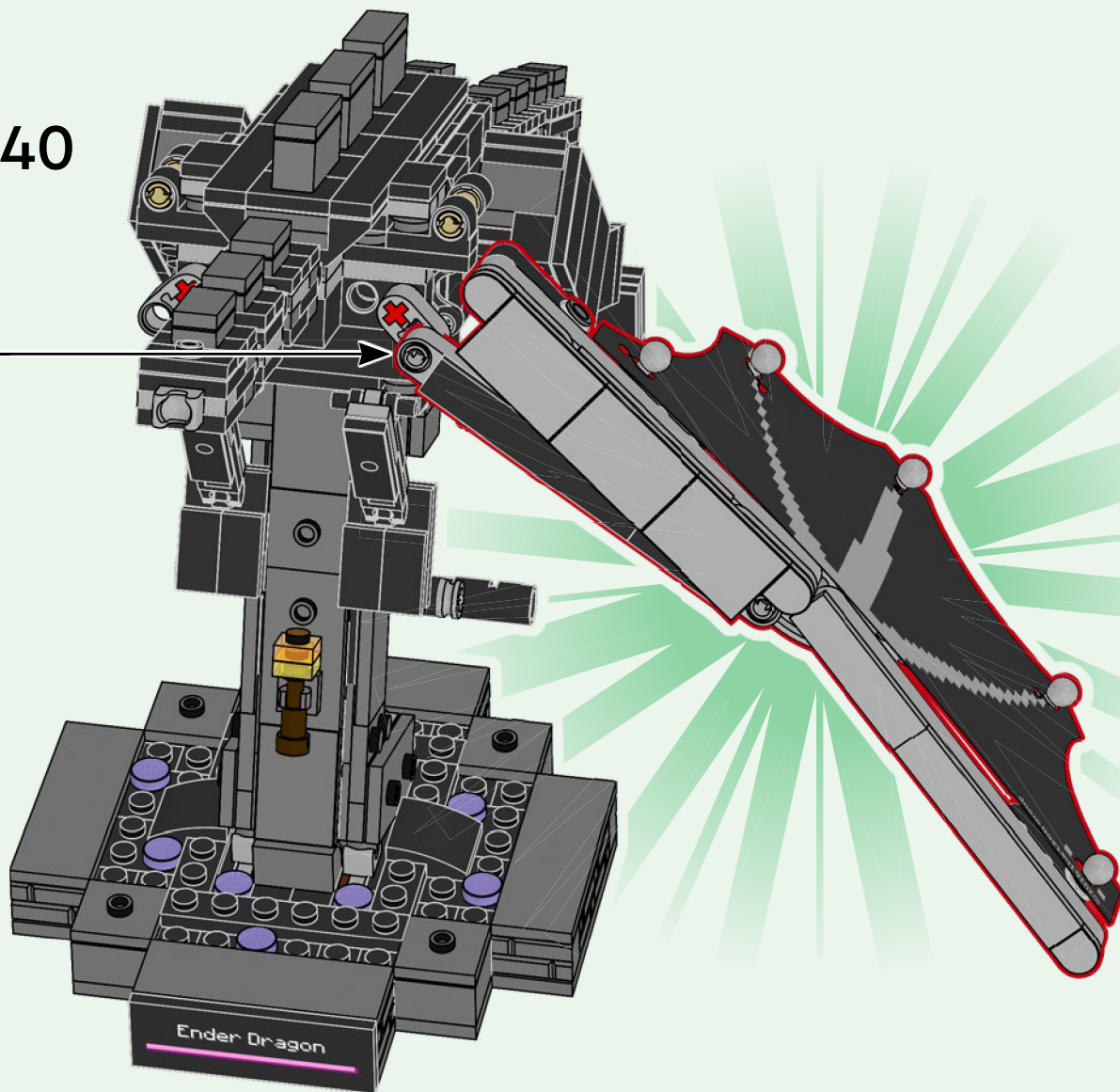

241

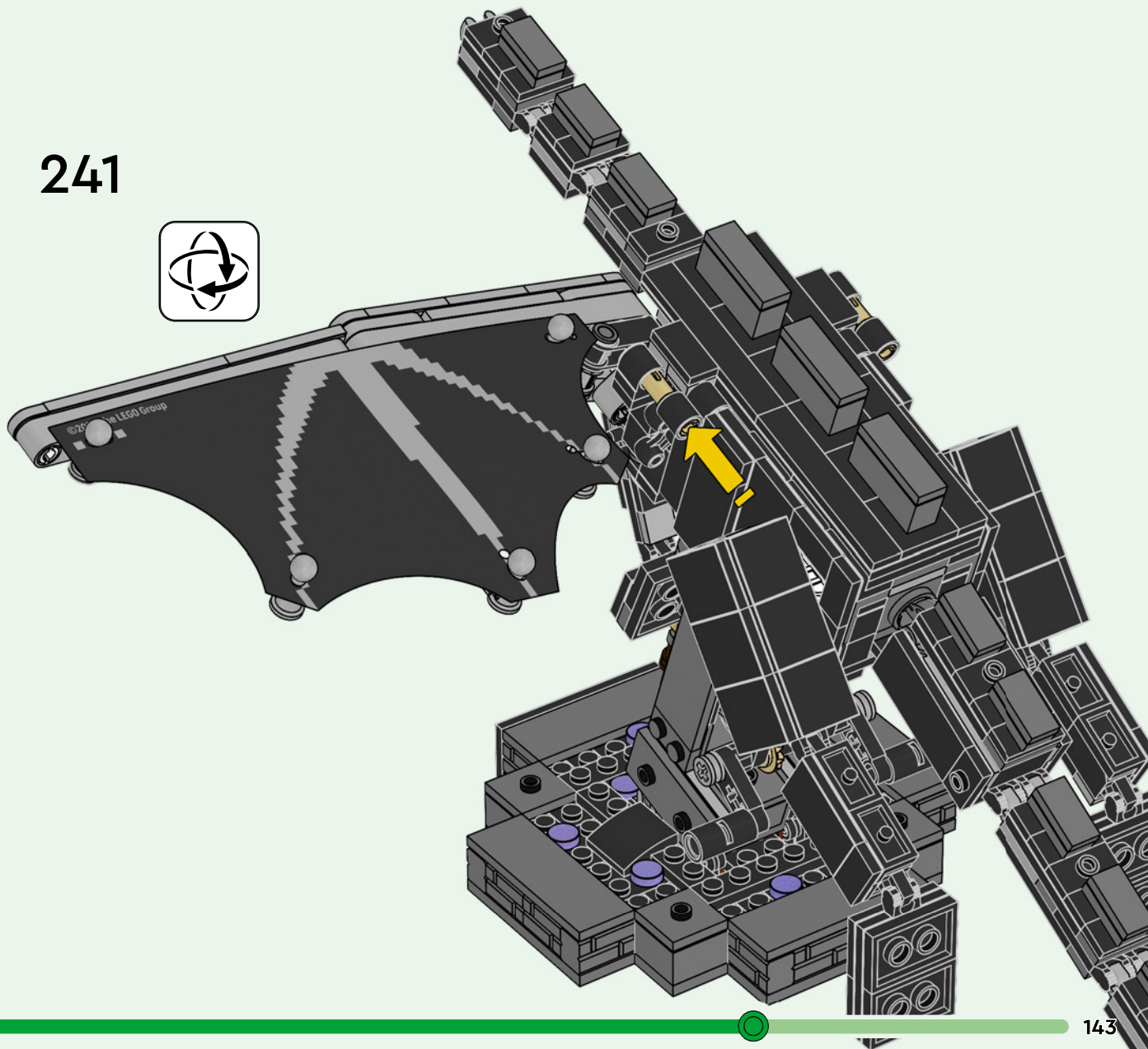

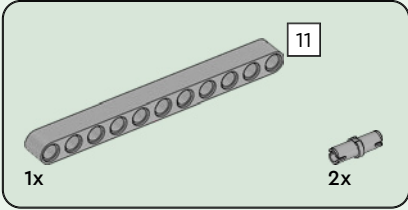
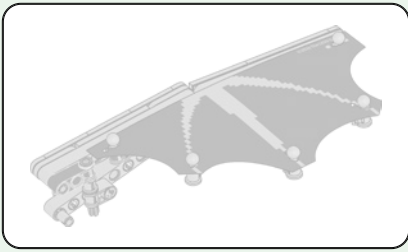

242

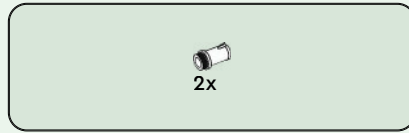
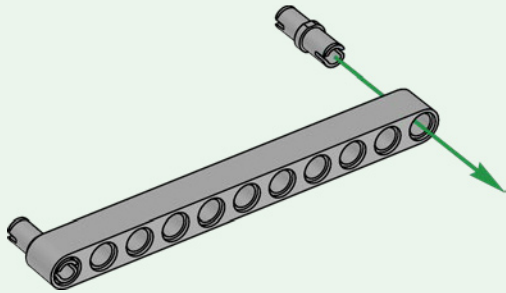

243

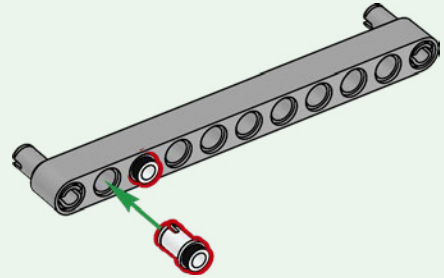

244

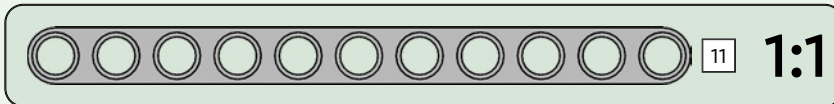
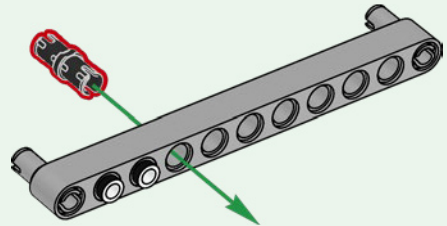

3x

245

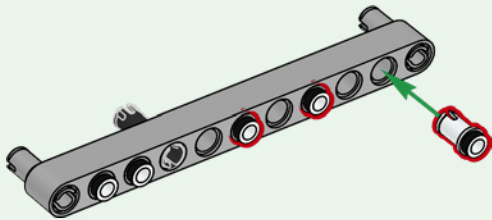

1x

1x

246

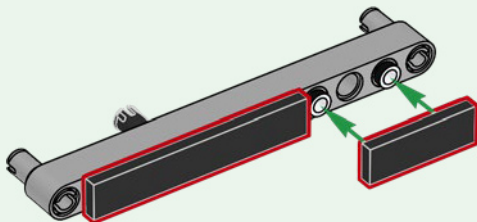

1x

1x

1x

247

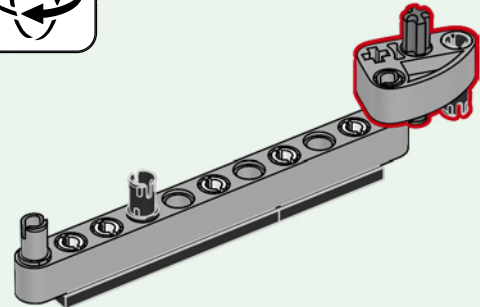
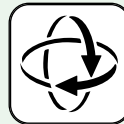
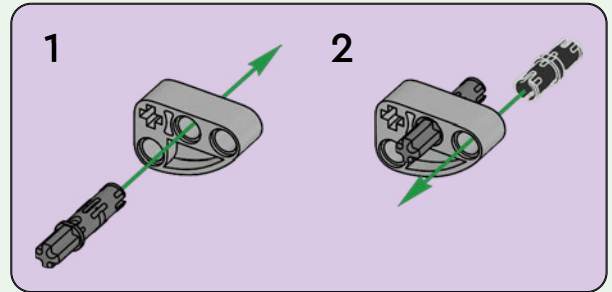

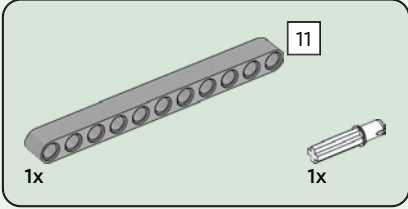
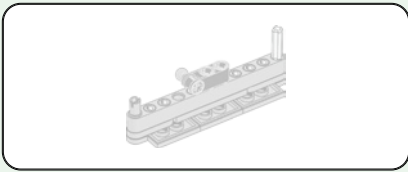

248

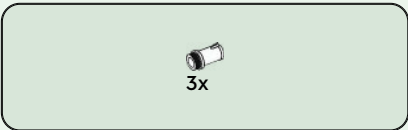
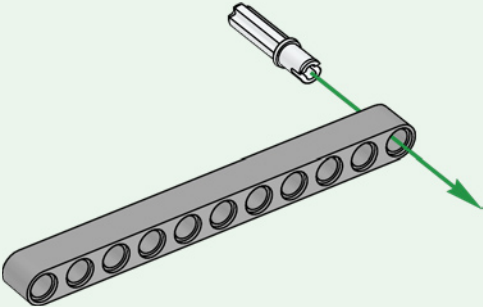

249

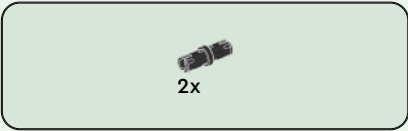
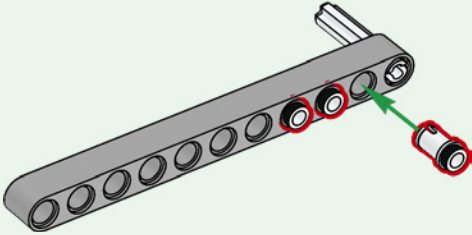

250

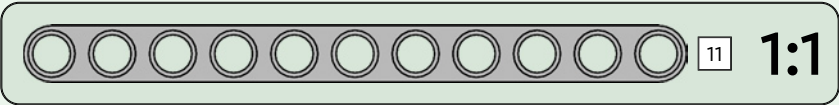
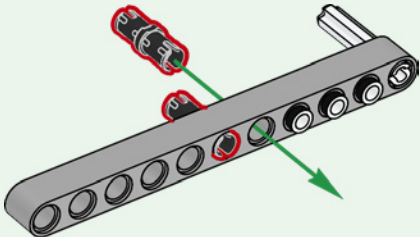

1x

251

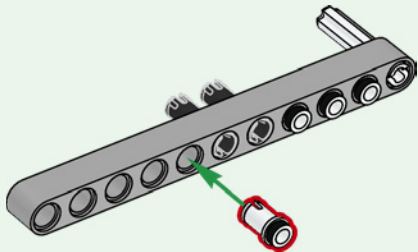

1x

252

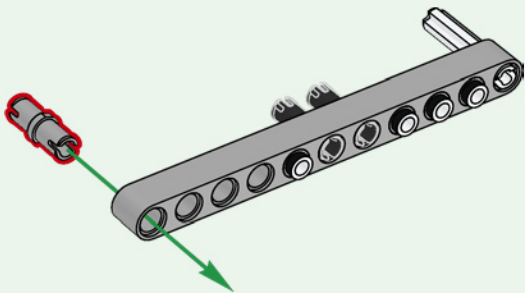

2x

253

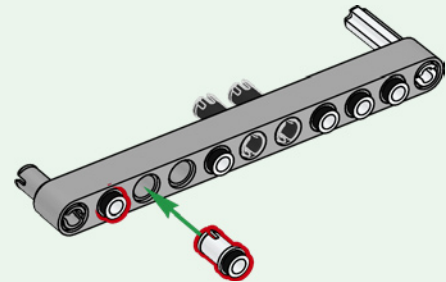

1x

2x

254

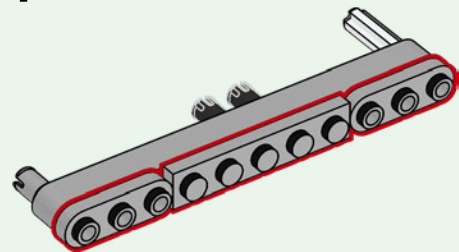

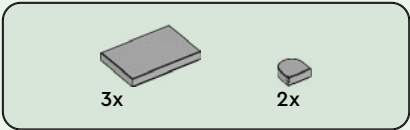

255

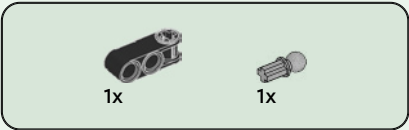
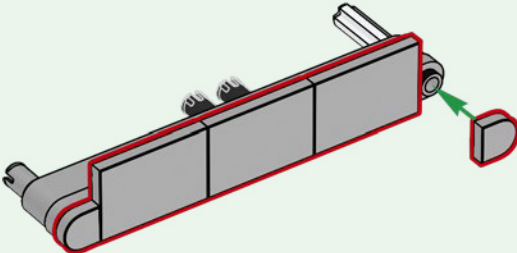

256

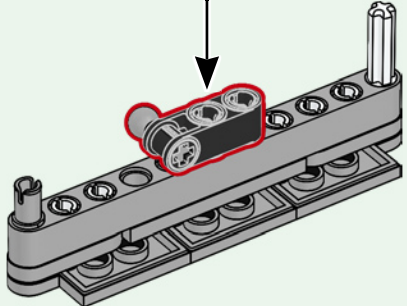
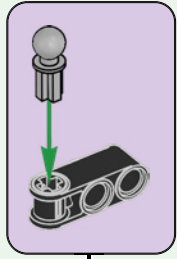

257

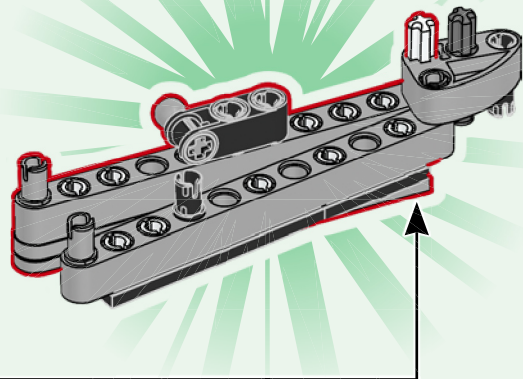

258

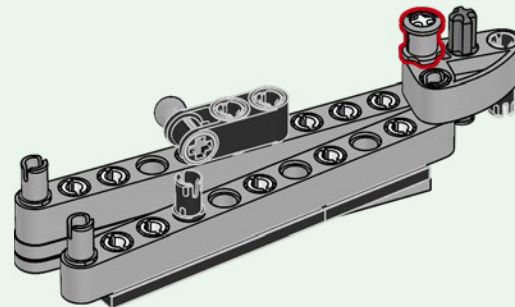
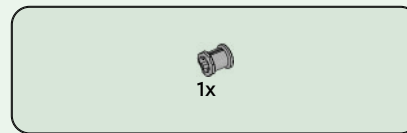

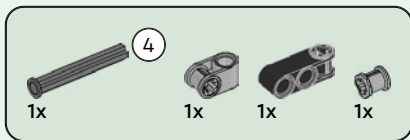

259

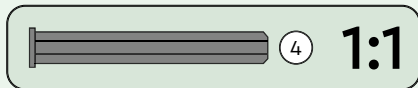
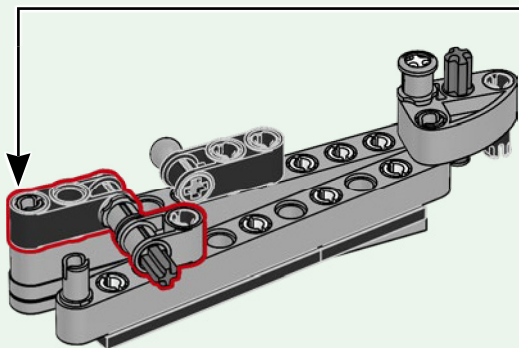
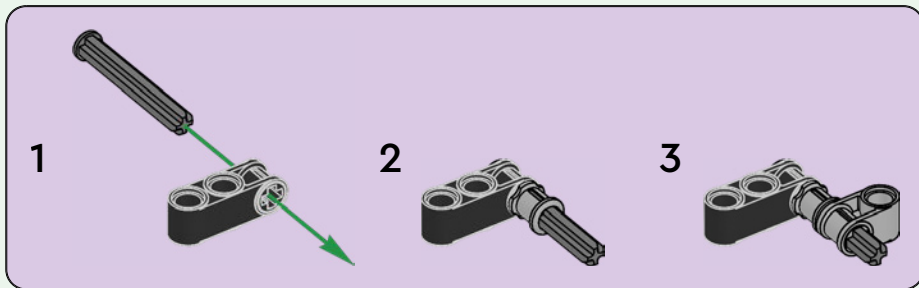

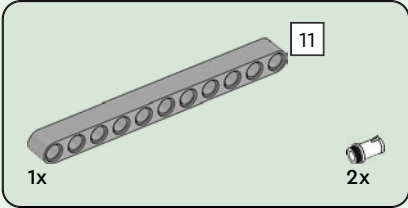
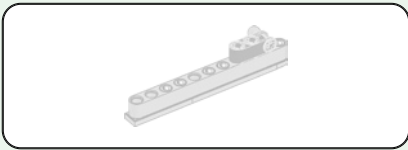

260

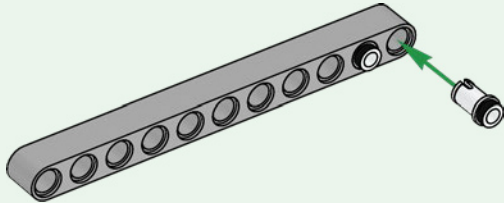

261

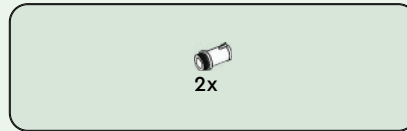
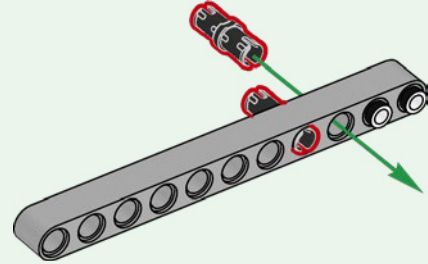

262

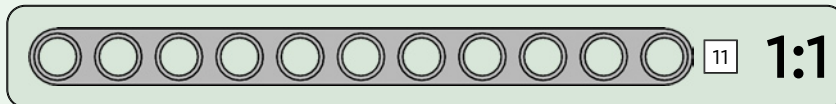
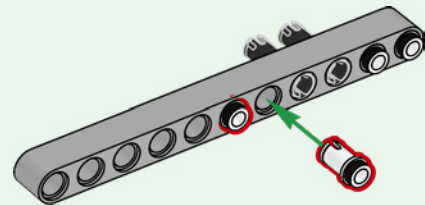



263

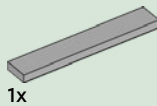
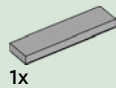
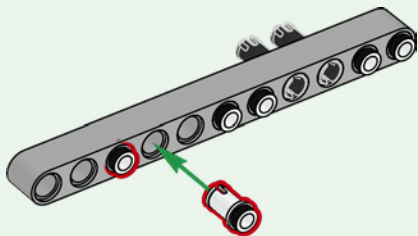

264

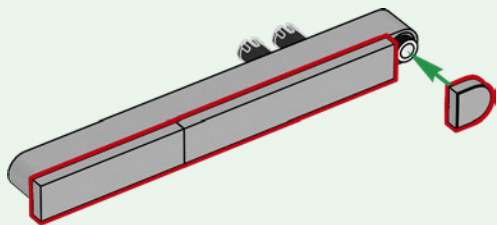

265

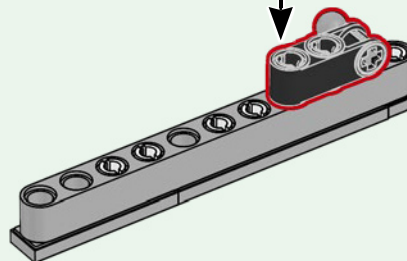
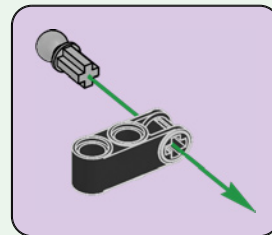

266

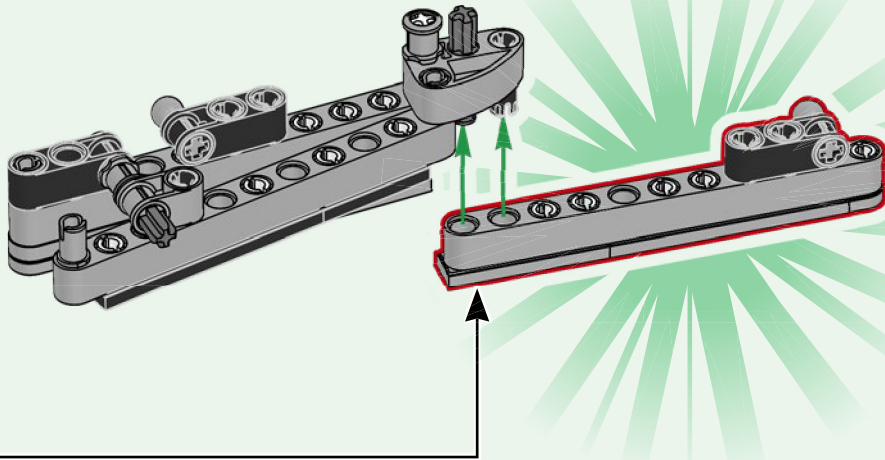

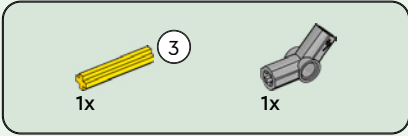
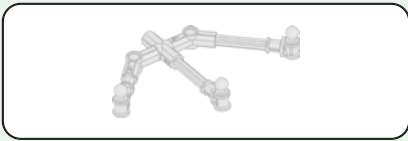

267

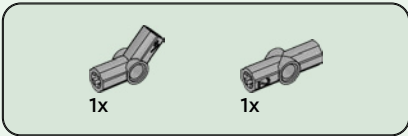
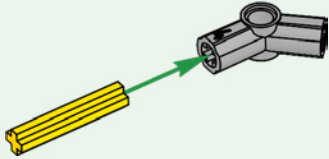

268

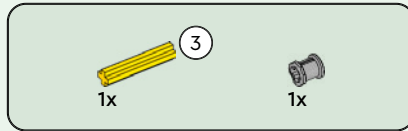
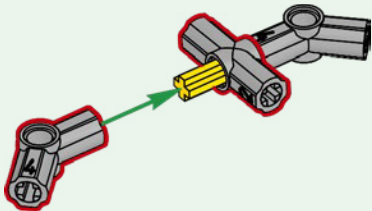

269

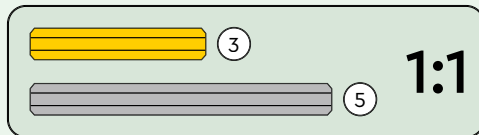
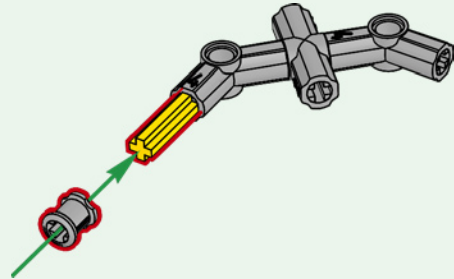

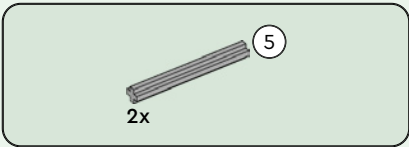

270

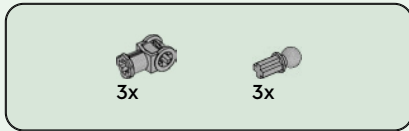
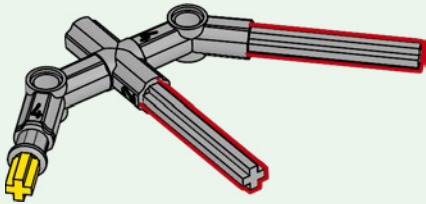

271

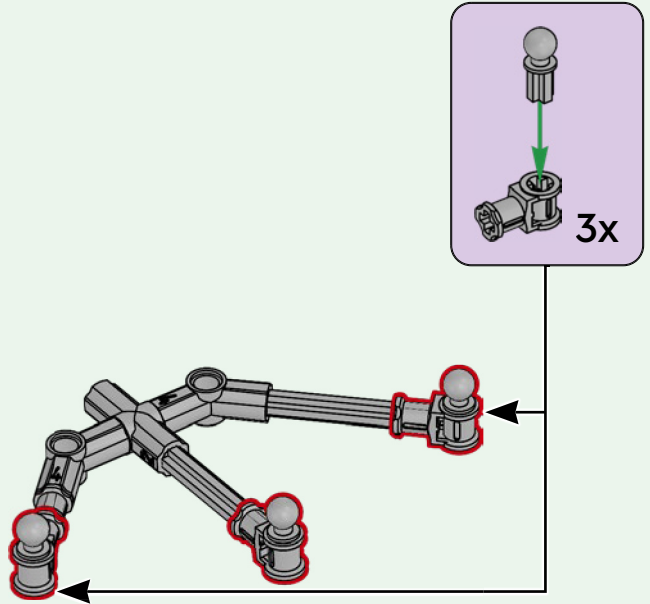

272

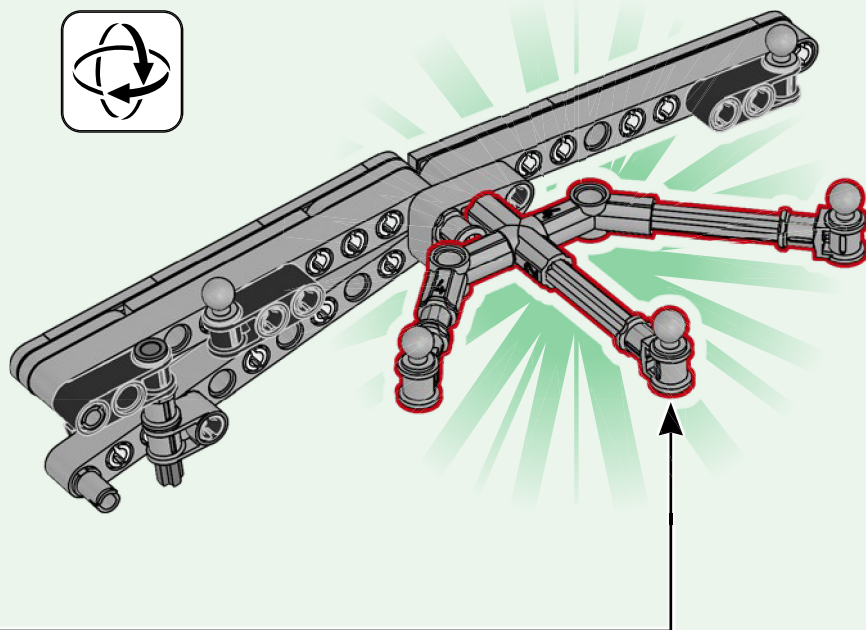
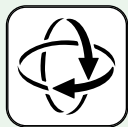

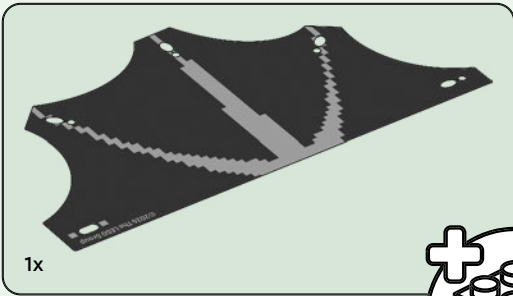

273

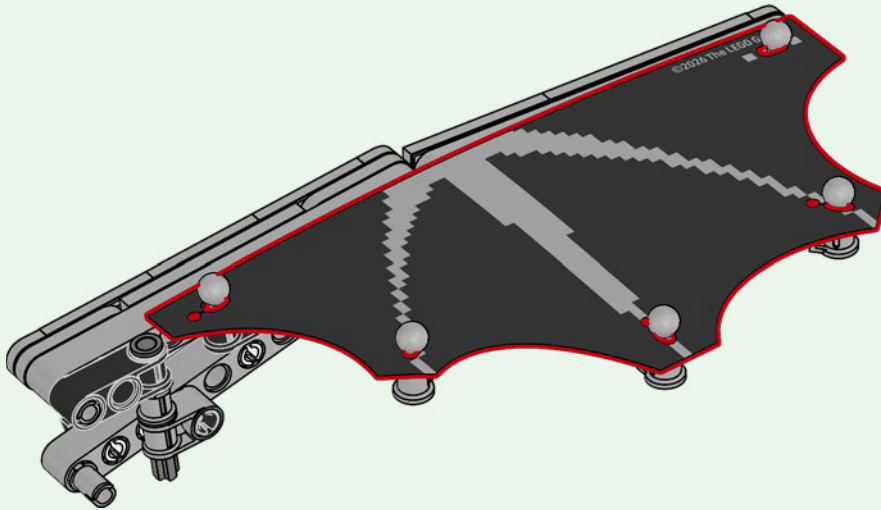
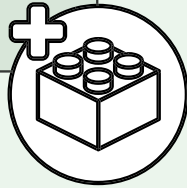

274

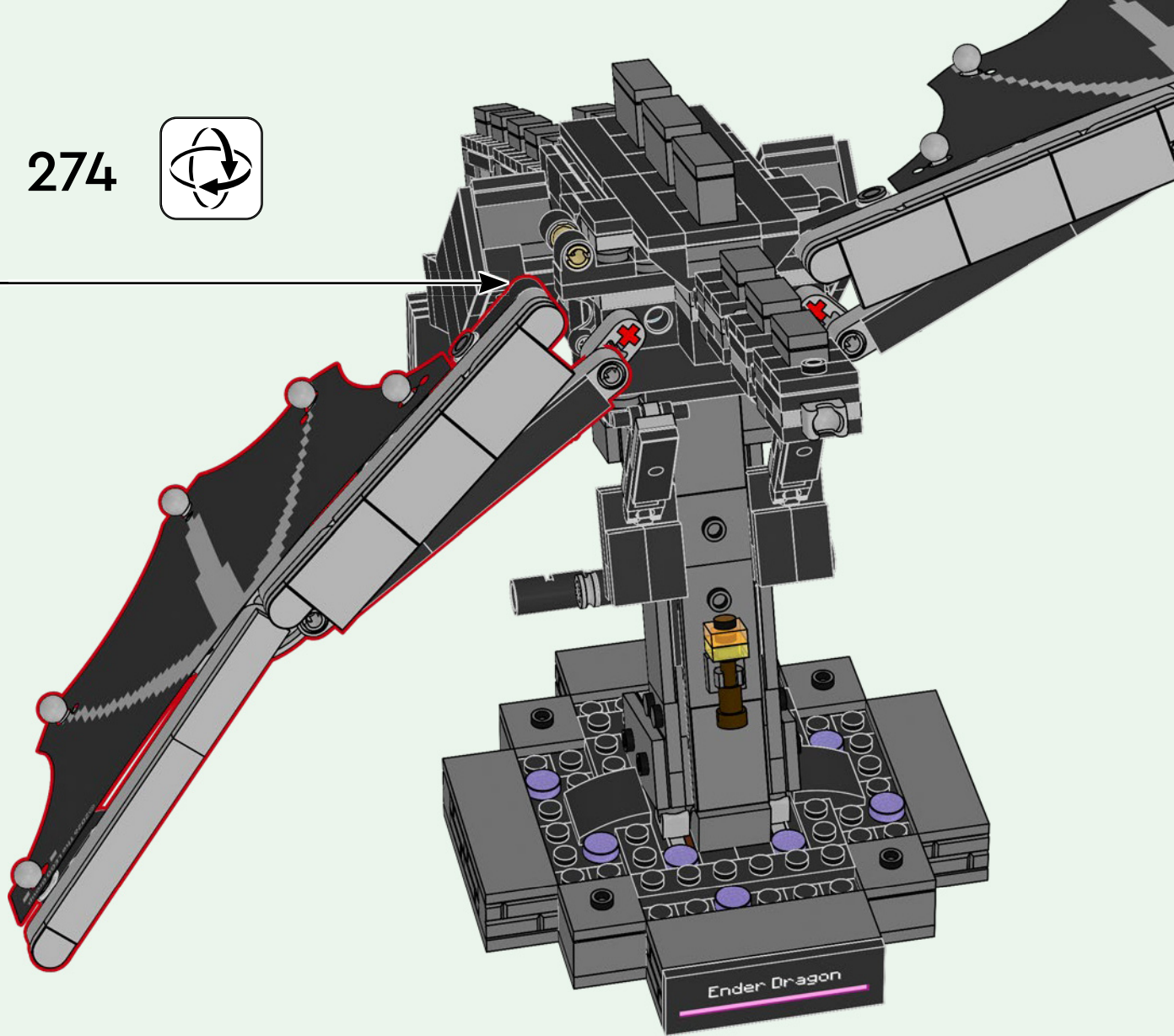
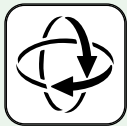

275

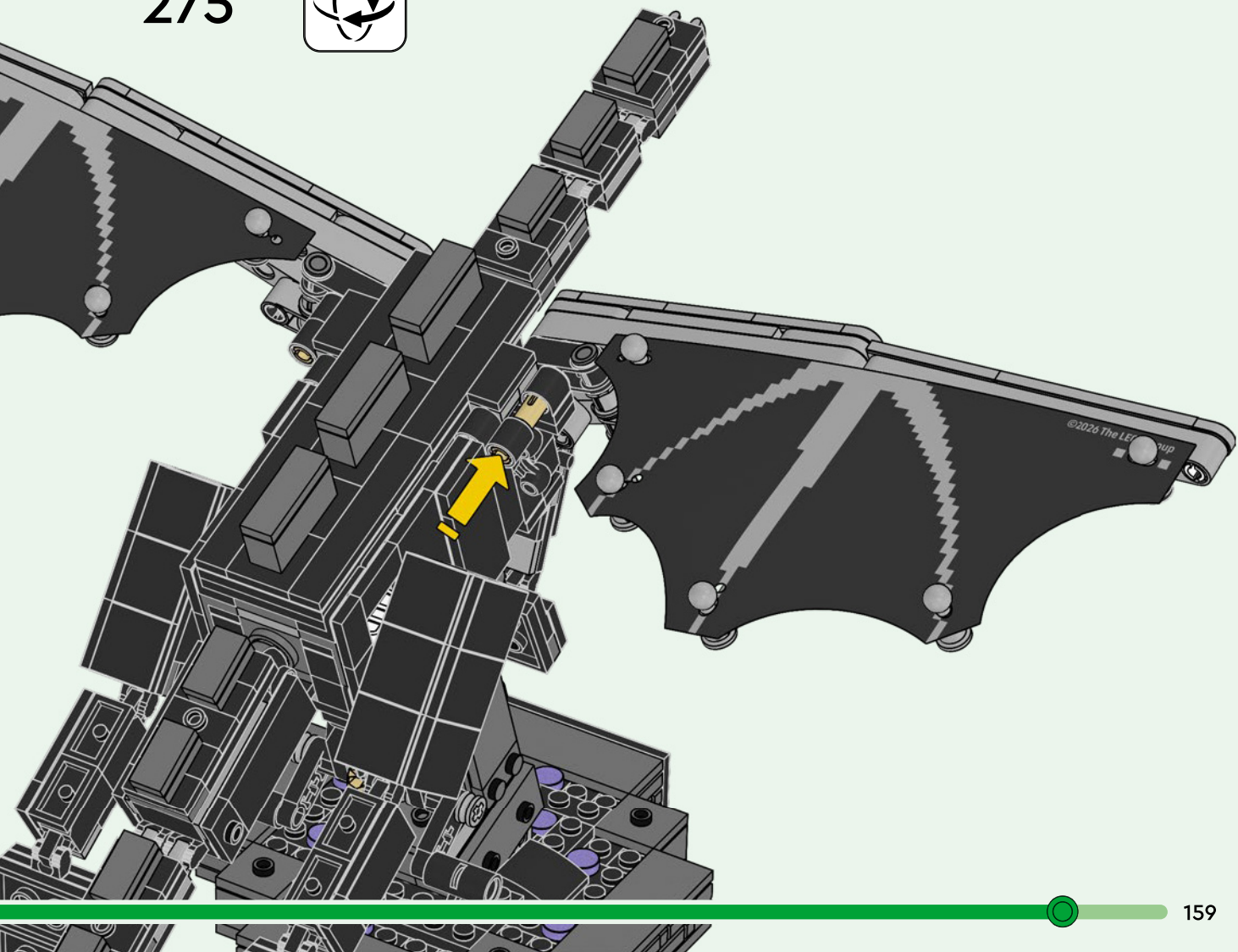
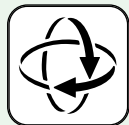



2x



1x

276

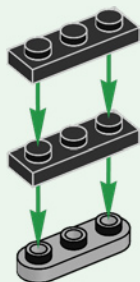

1x

277

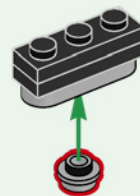

2x

278

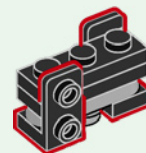



1x

279



1x

280

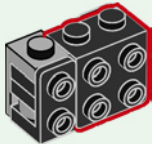

2x

281

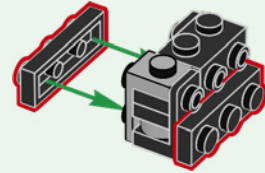

2x

282

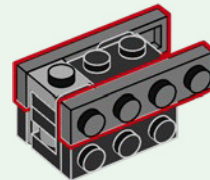



2x

283

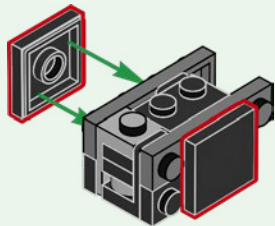

1x



1x

285



1x



1x

284

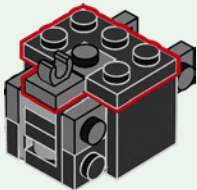

2x

286

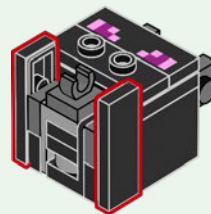

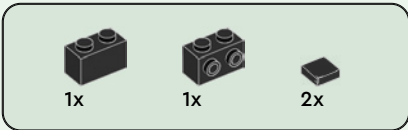

287

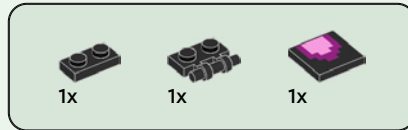
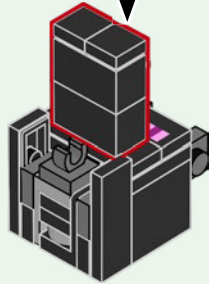
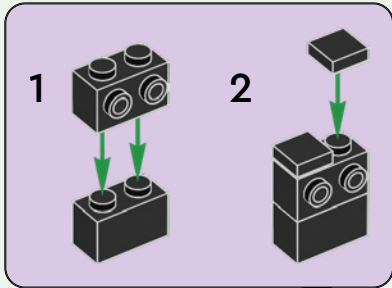

288

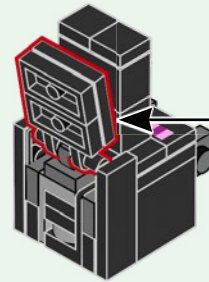
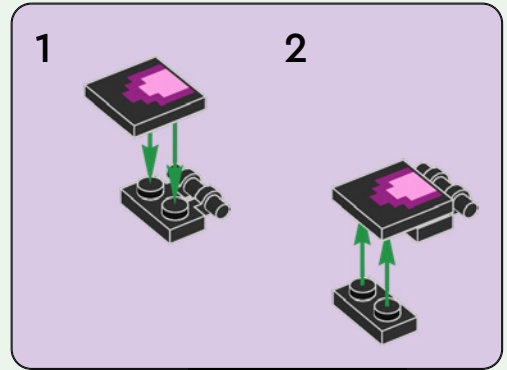



1x

289

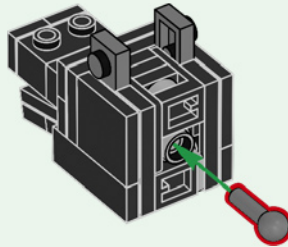

290

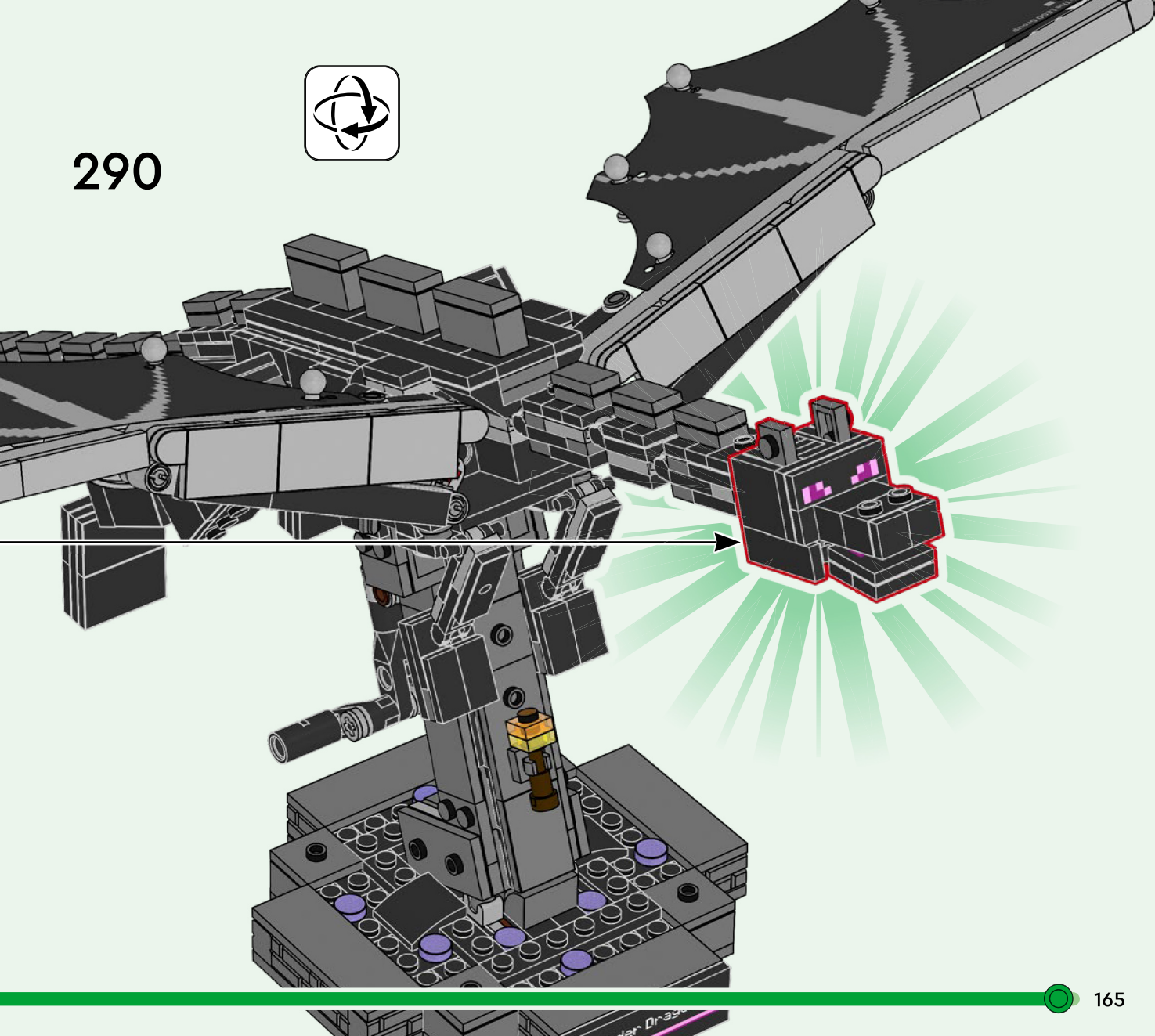
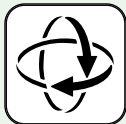

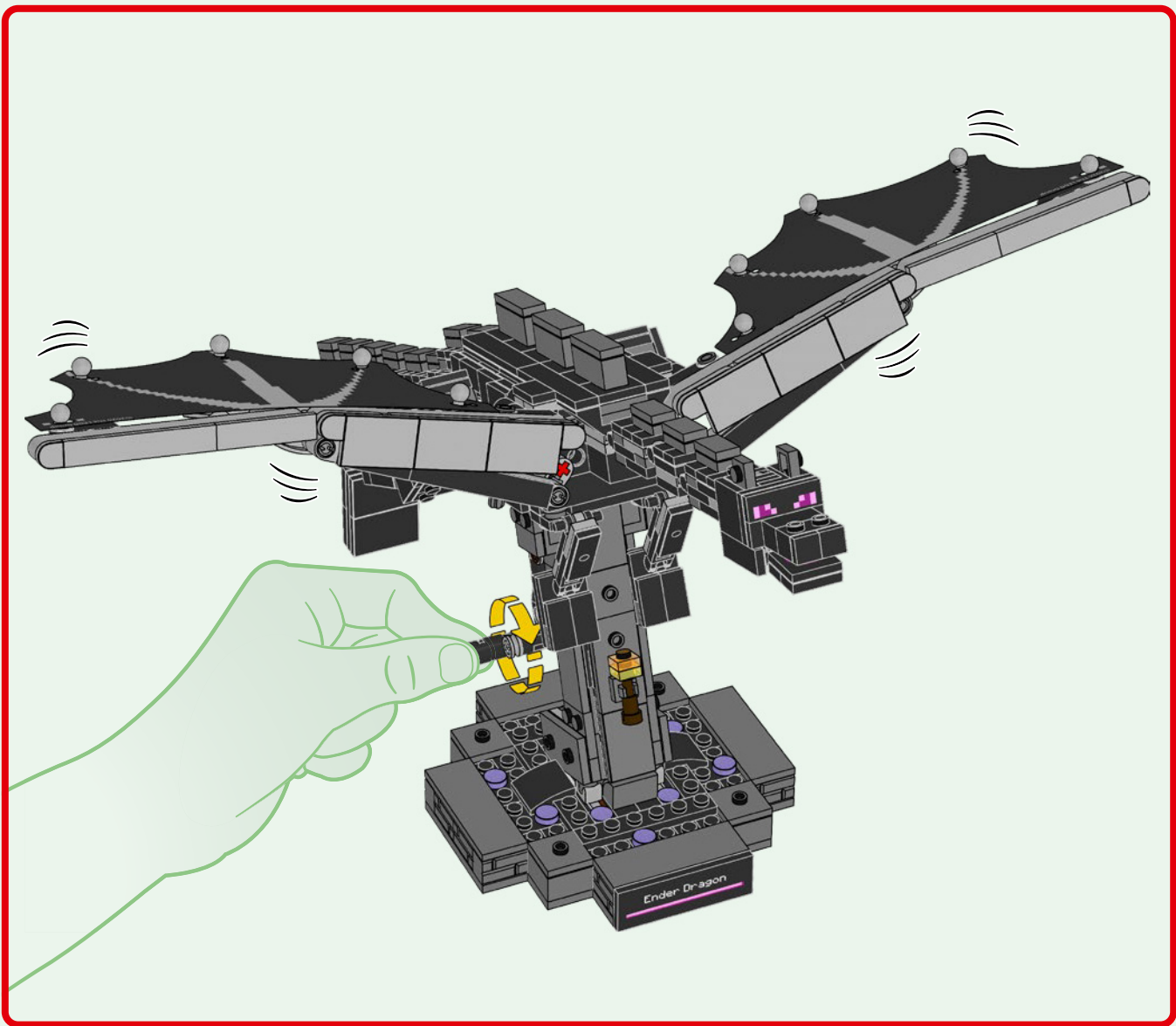

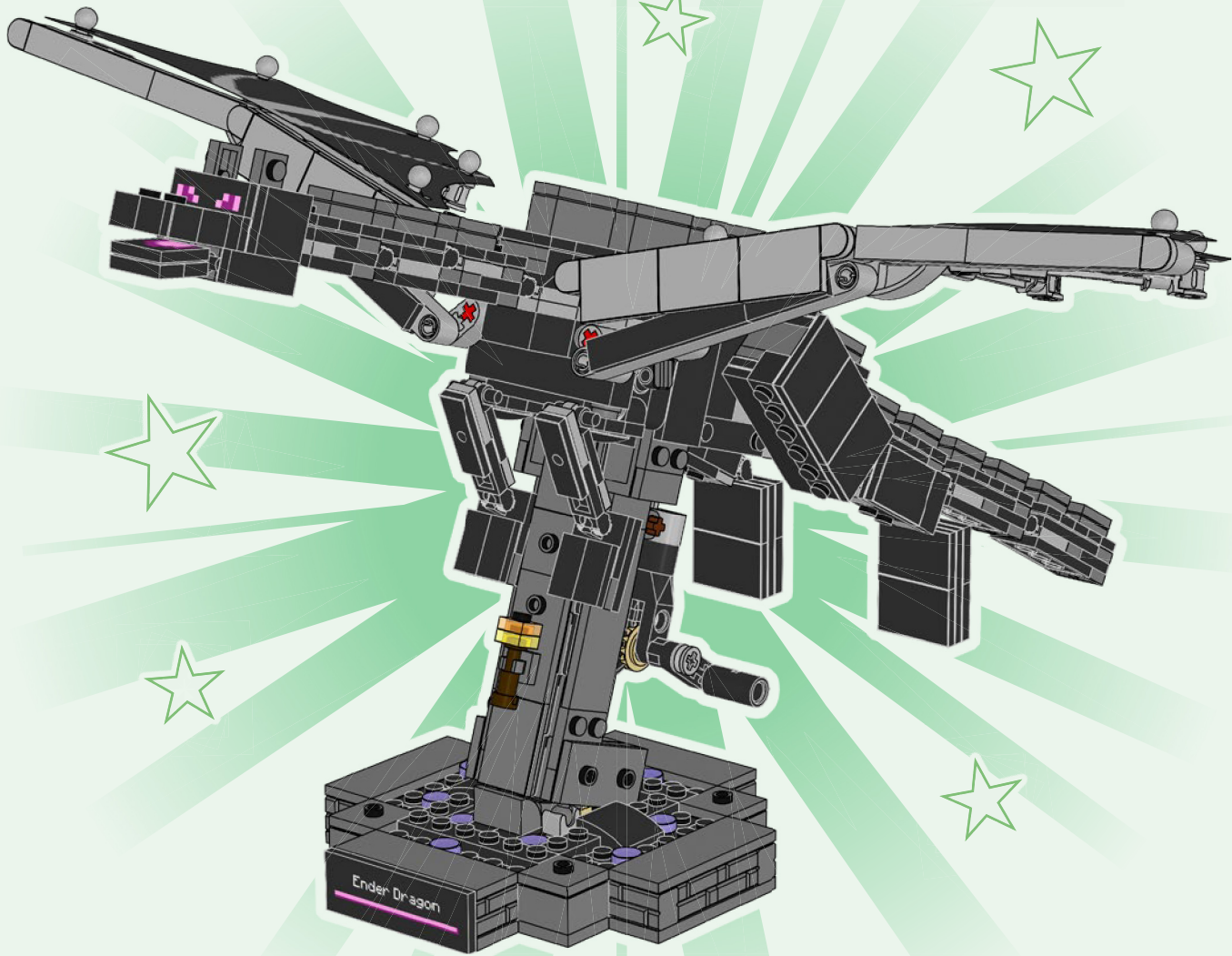



MINECRAFT



21592



21594



21593



21595



21597



21596

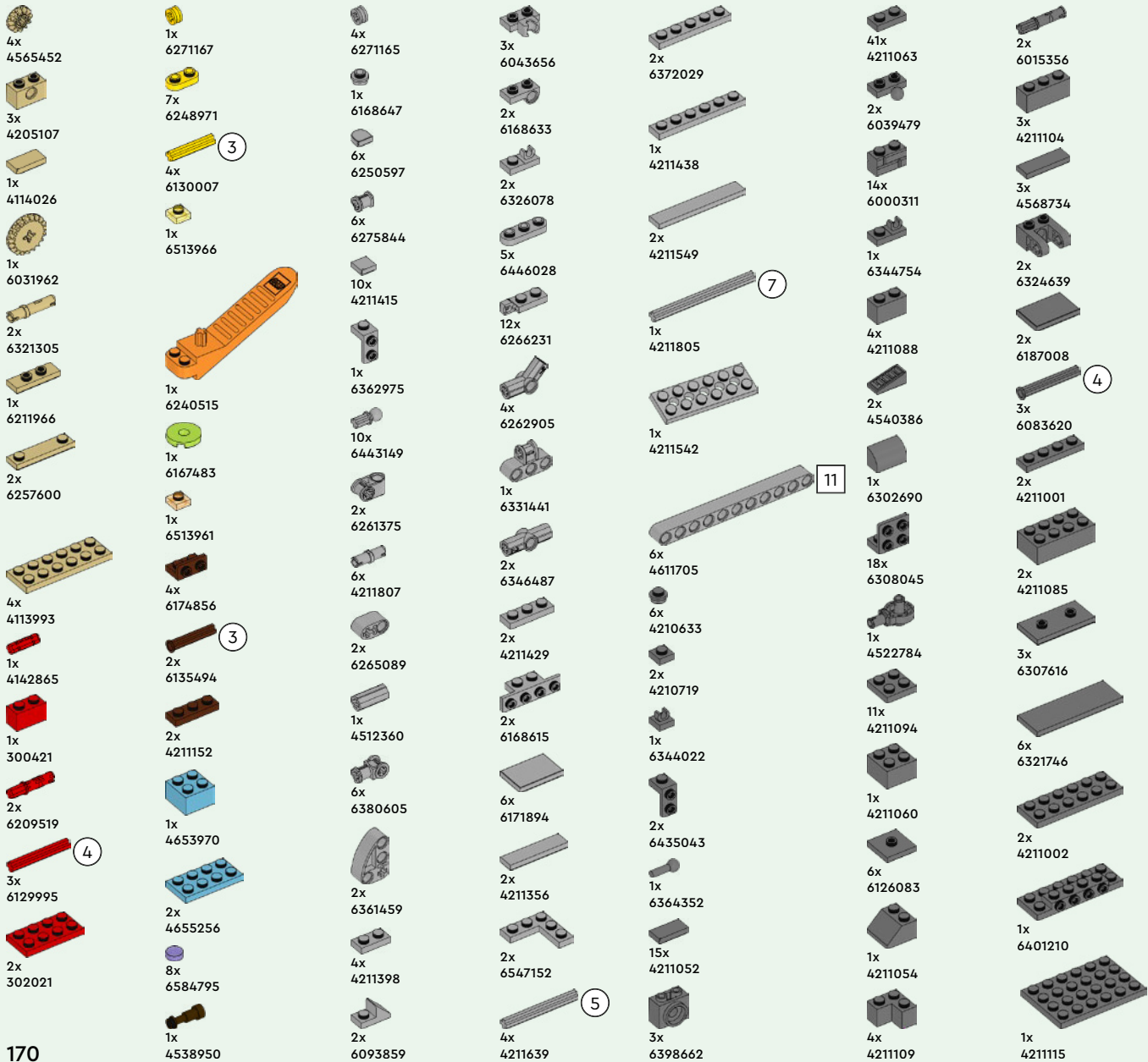

2x
6121485

10x
300526

2x
307026

4x
4558954

4x
6335317

1x
4177431

16x
6279875

2x
4278359

1x
6326047

2x
6173119

16x
306926

4x
6114987

2x
3200026

1x
6138173

2x
300426

30x
6092585

2x
6266207

1x
302326

9x
6117973

14x
6020193

2x
6313520

3x
4140588

2x
6336989

4x
6284188

4x
6266306

2x
242026

2x
6133722

6x
4565323

2x
6053077

6x
300326

5x
302226

2x
306826

6x
6273708

6x
6013867

2x
6265730

1x
6600934

16x
6267045

1x
4142822

2x
428626

3x
6199908

1x
6600933

4x
362326

2x
6272184

4x
4558170

2x
6118829

2x
6168620

1x
300226

1x
6493691

12x
6162892

6x
302126

10x
6254045

2x
243126

2x
301026

8x
663626

4x
366626

1x
6302828

2x
6416444

1x
6278412

6x
4560182

11x
302026

4x
300126

1x
4188534

2x
4142135

1x
370626

3x
300926

8x
663626

4x
366626

2x
4243819

5

6

4x
379526

1x
6600935

3x
346026

1x
303226

1x
4528341

34x
6388018

3x
6051511

2x
6472887

2x
6289797

2x
362201

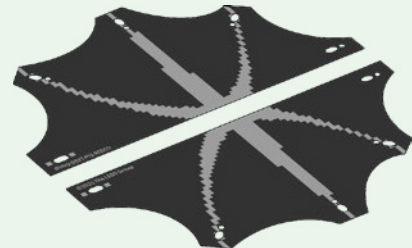

1x
6624323

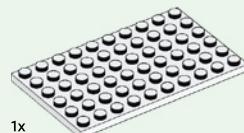

1x
4528341

34x
6388018

3x
6051511

2x
6472887

2x
6289797

2x
362201

 [LEGO.com/service](https://www.LEGO.com/service)



YOU COULD
WIN

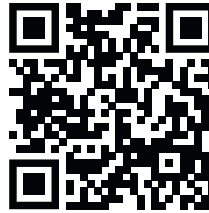

Scan this QR code or go to
LEGO.COM/PRODUCTFEEDBACK and give us
your short feedback about this LEGO® set
for a chance to win a cool LEGO prize.

Terms and Conditions apply*

EN: YOU COULD WIN. Terms and Conditions apply* **DE: Du könntest GEWINNEN.** Es gelten die Teilnahmebedingungen* **FR: TU POURRAIS GAGNER.** Des conditions s'appliquent* **IT: Potresti VINCERE tu.** Termini e condizioni sono applicabili* **ES: PUEDES GANAR.** Aplican términos y condiciones* **PT: PODERÁ GANHAR.** Aplicam-se Termos e Condições* **ZH: 轻松获奖. 条款和条件适用*** **PL: Szansa na WYGRANĄ.** Obowiązuje regulamin* **CS: Máte šanci VYHRÁT.** Platí všeobecné smluvní podmínky* **SK: Máte šancu VYHRÁŤ.** Platia všeobecné zmluvné podmienky* **HU: TE IS NYERHETSZ!** Felhasználási feltételek érvényesek* **UA: ВИ МОЖЕТЕ ВИГРАТИ.** Застосовуються загальні положення та умови* **RO: Ai putea CÂȘTIGA.** Se aplică termenii și condițiile* **BG: Можете да СПЕЧЕЛИТЕ.** Има определени правила и условия* **LV: Tu vari LAIMĒT.** Ir spēkā noteikumi un nosacījumi.* **ET: Sul on võimalus VÕITA.** Kehtivad tingimused* **LT: Jūs galite LAIMĖTI.** Taikomos sąlygos* **TR: KAZANABİLİRSİN.** Şartlar ve Koşullar geçerlidir*

*[LEGO.com/productfeedback-terms](https://www.lego.com/productfeedback-terms)

LEGO and the LEGO logo are trademarks of the LEGO Group. ©2026 The LEGO Group.

© 2026 Mojang AB. All Rights Reserved. Minecraft, the Minecraft logo, the Mojang Studios logo and the Creeper logo are trademarks of the Microsoft group of companies.

 6650200