



# NINJAGO

DRAGONS RISING

71862



LEGO® Builder



LEGO.com/sustainable-packaging



FR  
DONNEZ  
OU  
RECYCLEZ



ASSOCIATION

OU



MAGASIN

OU



DÉCHÈTERIE

Adresses sur [quefairedemesdechets.fr](http://quefairedemesdechets.fr)



LEGO® Builder



# BUILDER



Apple and the Apple logo are trademarks of Apple Inc., registered in the U.S. and other countries and regions. App Store is a service mark of Apple Inc. Google Play and the Google Play logo are trademarks of Google LLC. Tencent and the Tencent logo are trademarks of Tencent Inc.

## LEGO.com/devicecheck

**EN** Ask parents' permission before going online | **DE** Eltern um Erlaubnis bitten, bevor du online gehst | **FR** Demande l'autorisation d'un parent avant d'aller en ligne | **IT** Chiedi il permesso ai tuoi genitori prima di andare online | **ES** Pídeles permiso a tus papás antes de conectarte a Internet | **PT** pede autorização aos teus pais antes de ficares online | **ZH** 上网前应先征得父母的同意 | **PL** Poproś rodziców o zgodę, zanim wejdiesz do Internetu | **CS** Než půjdeš na internet, požádej rodiče o svolení | **SK** Skôr než pôjdeš na Internet, vypýtaj si povolenie od rodičov | **HU** Kérj szülői engedélyt, mielőtt online csatlakoznál! | **UA** Запитуйте дозволу батьків, перш ніж користуватися інтернетом | **RO** Cere permisiunea părinților înainte de a te conecta online | **BG** Поискайте разрешение от родител, преди да влезете онлайн | **LV** Pirms došanās tiešsaistē palūdz atļauju vecākiem | **ET** Enne Interneti kasutamist küsi vanematelt luba | **LT** Prieš prisijungdami prie interneto, atsiklauskite tėvų | **TR** İnternete girmeden önce anne babandan izin iste



1

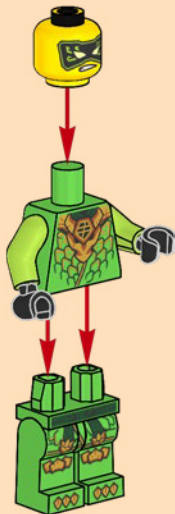

2



1

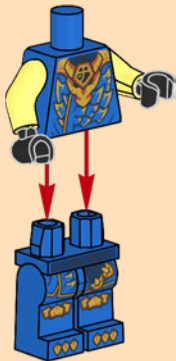

2

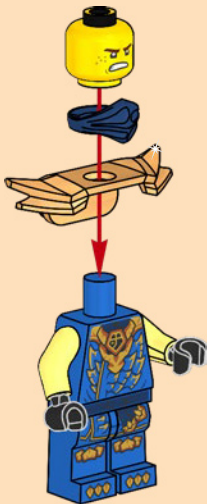

3



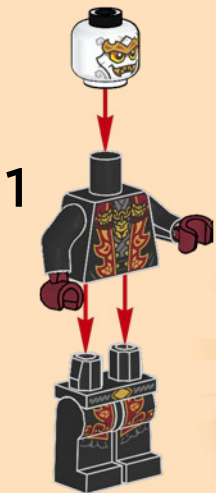

2

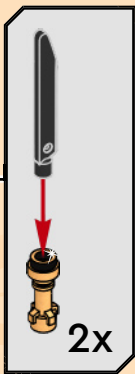

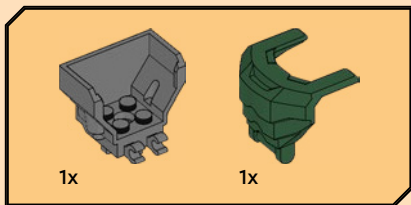

1

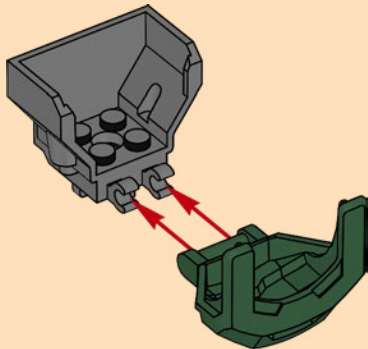

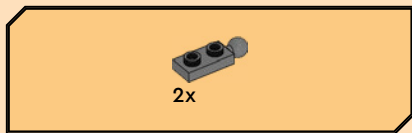

2

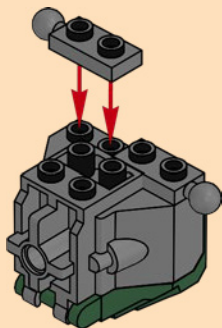

10





2x

3

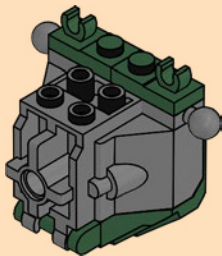

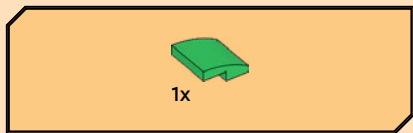

4

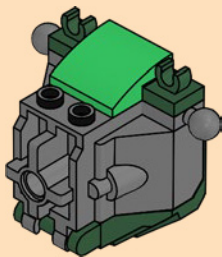

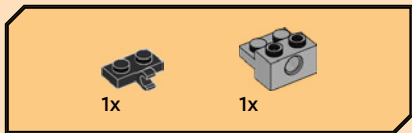
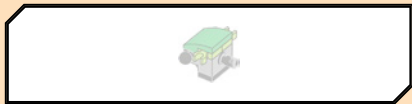

5

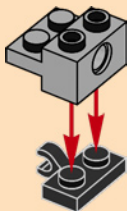

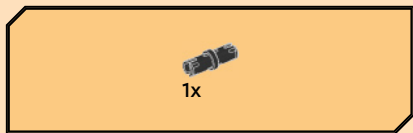

6

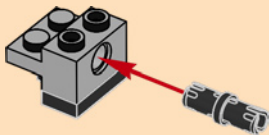

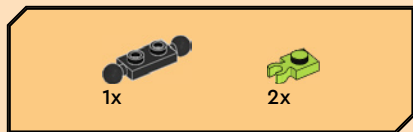

7

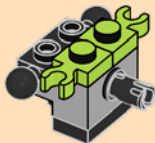

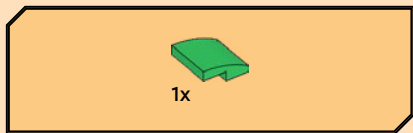

8

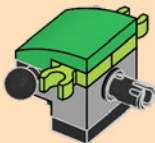



9

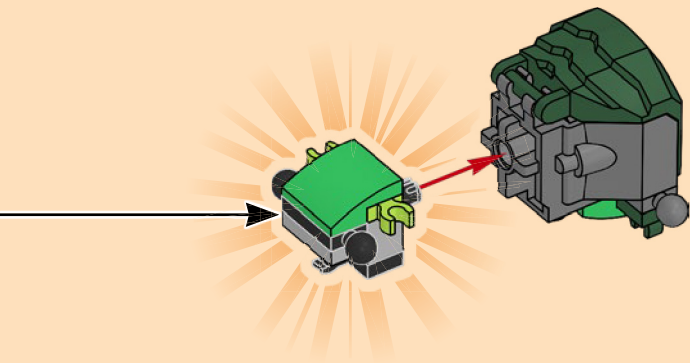

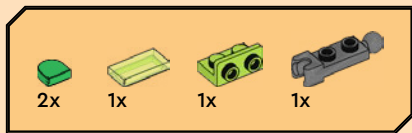

# 10

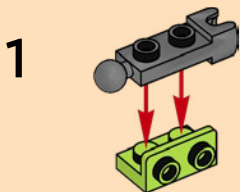

2



3

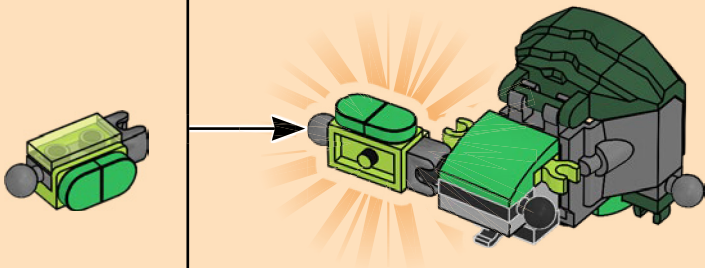

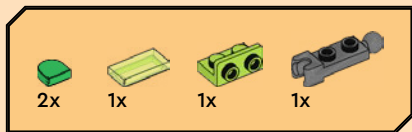

11

1

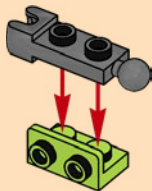

2



3

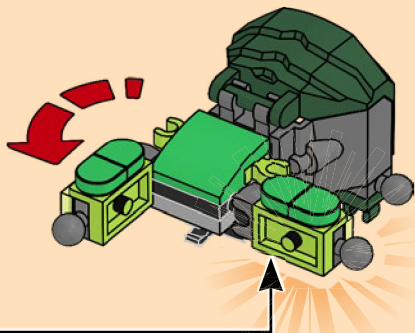



1x



1x

# 12

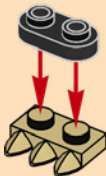

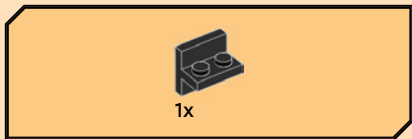

13

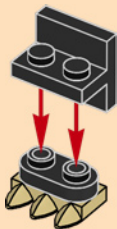



1x

14





1x



1x



1x

# 15

## 1

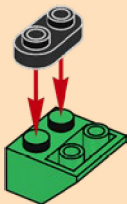

## 2

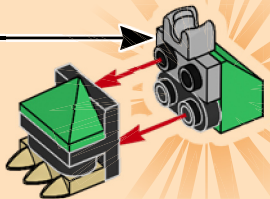
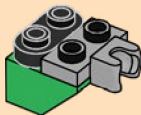

# 2x



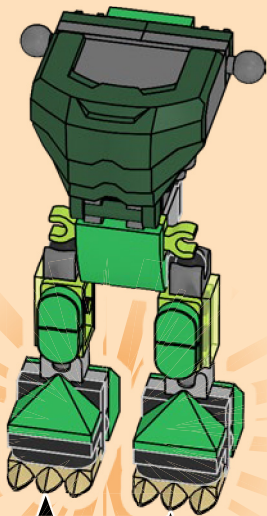

16

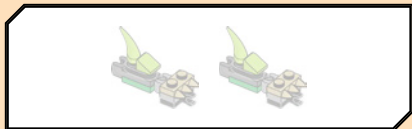

17

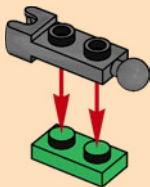



1x

18

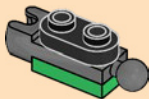

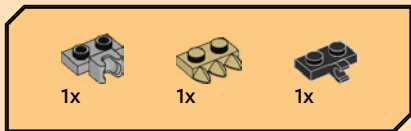

19

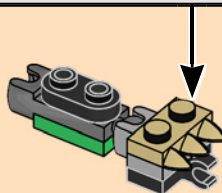
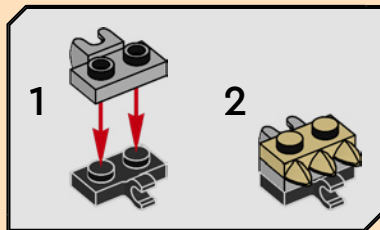

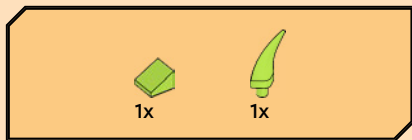

20

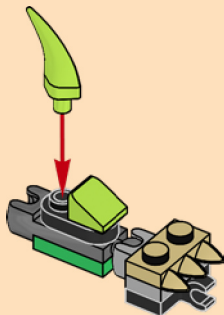

2x

21

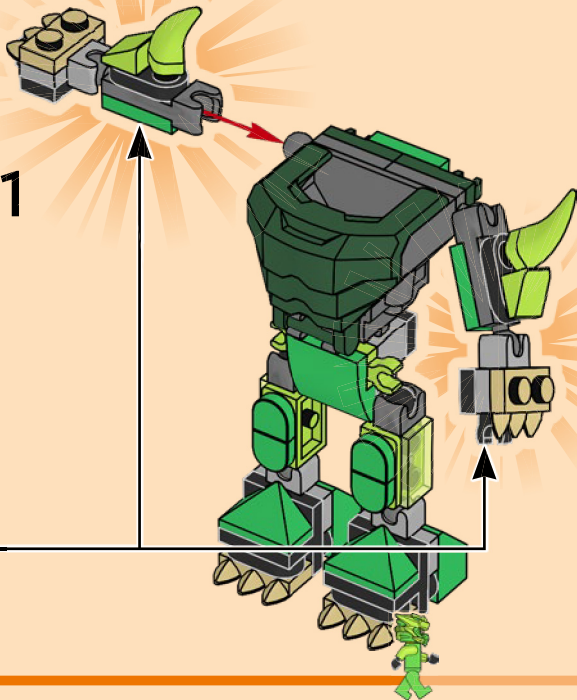

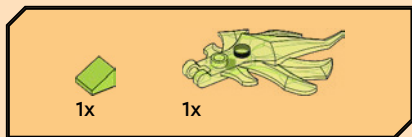

# 22

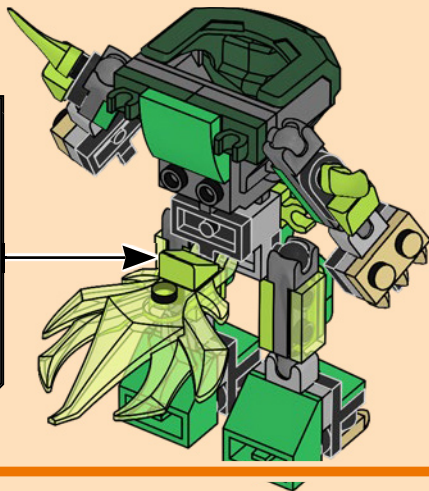
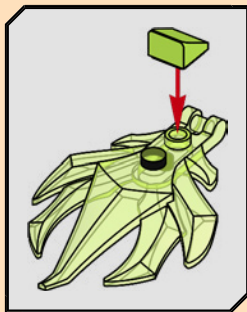

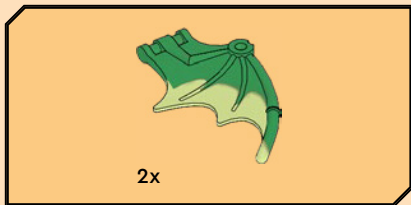

23

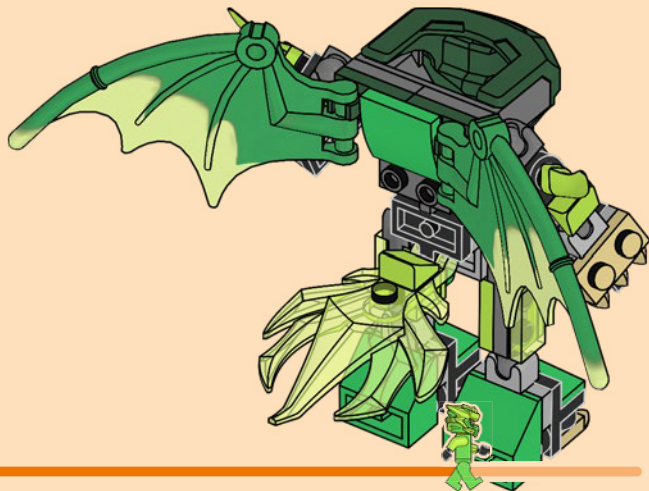

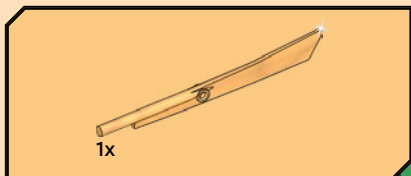

24

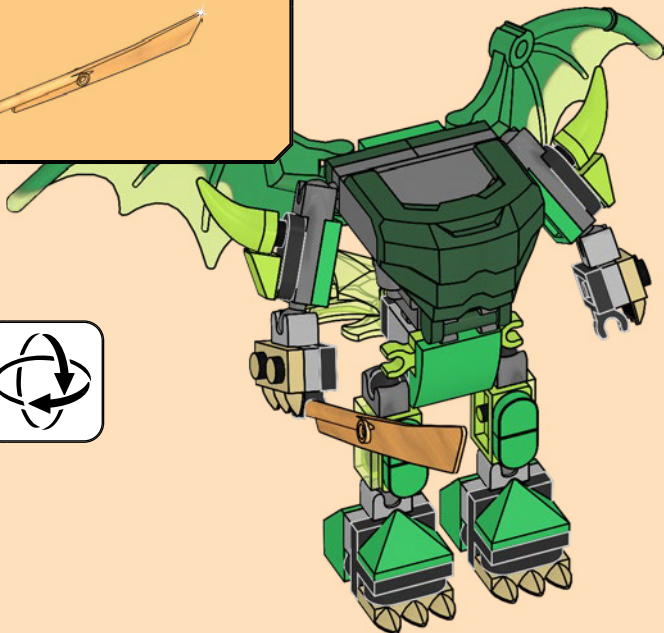

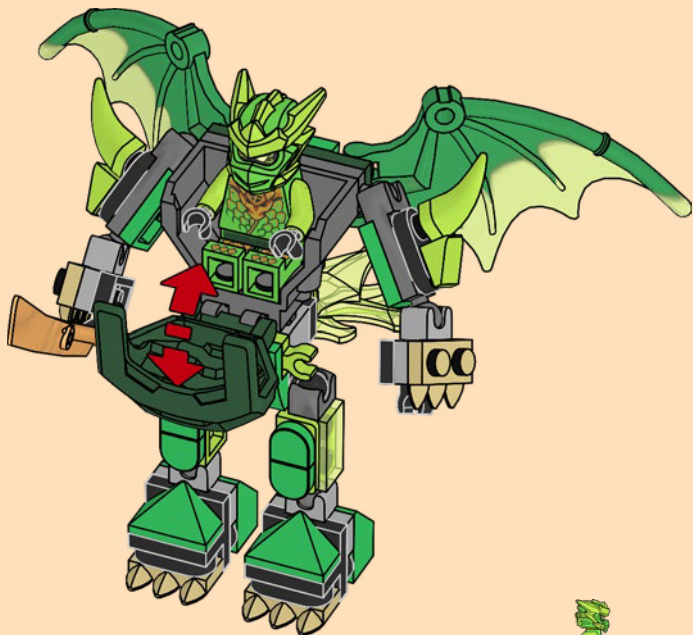







1x  
6579040



4x  
6046907



1x  
6578520



1x  
6591330



1x  
6434435



1x  
6587171



2x  
6566261

38



6x  
6210270



1x  
6279875



1x  
6579042



3x  
6313116



2x  
6250020



1x  
6591923



1x  
6416838



4x  
6250600



2x  
6314380



2x  
302328



2x  
6116259



2x  
4142717



1x  
6578464



1x  
6593633



1x  
6586096



2x  
6311215



3x  
4504372



2x  
6533509



2x  
6218266



1x  
6474842



2x  
6375006



1x  
6612984



1x  
6384443



1x  
6270131



1x  
6591858



1x  
6586346



2x  
6003147



1x  
6584977



2x  
6502368



4x  
6043656



1x  
6274711



2x  
6606286



1x  
6326478



1x  
6245239



2x  
6123814



2x  
6575802



4x  
6039482



1x  
6554868

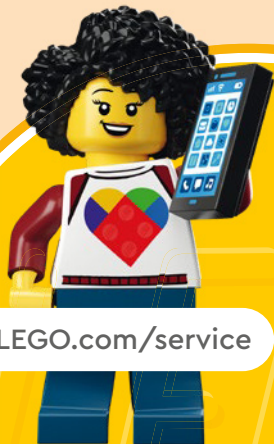

[LEGO.com/service](https://www.LEGO.com/service)

YOU COULD

WIN



Scan this QR code or go to  
**LEGO.COM/PRODUCTFEEDBACK** and give us  
your short feedback about this LEGO® set for  
a chance to win a cool LEGO prize.

Terms and Conditions apply\*

**EN: YOU COULD WIN.** Terms and Conditions apply\* **DE: Du könntest GEWINNEN.** Es gelten die Teilnahmebedingungen\* **FR: TU POURRAIS GAGNER.** Des conditions s'appliquent\* **IT: Potresti VINCERE tu.** Termini e condizioni sono applicabili\* **ES: PUEDES GANAR.** Aplican términos y condiciones\* **PT: PODERÁ GANHAR.** Aplicam-se Termos e Condições\* **ZH: 轻松获奖.** 条款和条件适用\* **PL: Szansa na WYGRANĄ.** Obowiązuje regulamin\* **CS: Máte šanci VYHRÁT.** Platí všeobecné smluvní podmínky\* **SK: Máte šancu VYHRÁT.** Platia všeobecné zmluvné podmienky\* **HU: TE IS NYERHETSZ!** Felhasználási feltételek érvényesek\* **UA: ВИ МОЖЕТЕ ВИГРАТИ.** Застосовуються загальні положення та умови\* **RO: Ai putea CÂȘTIGA.** Se aplică termenii și condiții\* **BG: Можете да СПЕЧЕЛИТЕ.** Има определени правила и условия\* **LV: Tu vari LAIMĒT.** Ir spēkā noteikumi un nosacījumi.\* **ET: Sul on võimalus VÕITA.** Kehtivad tingimused\* **LT: Jūs galite LAIMĖTI.** Taikomos sąlygos\* **TR: KAZANABİLİRSİN.** Şartlar ve Koşullar geçerlidir\*

\*[LEGO.com/productfeedback-terms](https://www.lego.com/productfeedback-terms)

LEGO, the LEGO logo and NINJAGO are trademarks of the LEGO Group.  
©2026 The LEGO Group.



6650086