



CREATOR™



31390



LEGO® Builder



Get excited about our new packaging!

We're switching from plastic to paper-based packaging. That's why you might find a mix of paper and plastic in our boxes!

Nos nouveaux emballages vous emballeront !

Nous passons des emballages en plastique aux emballages à base de papier. C'est pourquoi vous pourriez trouver un mélange de papier et de plastique dans nos boîtes !

¡Te presentamos nuestros nuevos empaques!

Estamos sustituyendo las bolsas de plástico por bolsas con base de papel. ¡Por eso, puedes encontrar una mezcla de papel y de plástico en nuestras cajas!

[LEGO.com/sustainable-packaging](https://www.lego.com/sustainable-packaging)

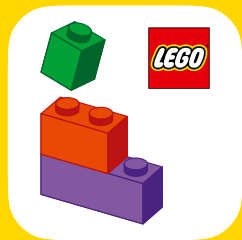

LEGO® Builder



BUILDER



Apple and the Apple logo are trademarks of Apple Inc., registered in the U.S. and other countries and regions. App Store is a service mark of Apple Inc. Google Play and the Google Play logo are trademarks of Google LLC. Tencent and the Tencent logo are trademarks of Tencent Inc.

LEGO.com/devicecheck

EN Ask parents' permission before going online | DE Eltern um Erlaubnis bitten, bevor du online gehst | FR Demande l'autorisation d'un parent avant d'aller en ligne | IT Chiedi il permesso ai tuoi genitori prima di andare online | ES Pídeles permiso a tus papás antes de conectarte a Internet | PT Pede autorização aos teus pais antes de ficares online | ZH 上网前应先征得父母的同意 | PL Poproś rodziców o zgodę, zanim wejdiesz do Internetu | CS Než půjdeš na internet, požádej rodiče o svolení | SK Skôr než pôjdeš na internet, vypýtaj si povolenie od rodičov | HU Kérj szülői engedélyt, mielőtt online csatlakoznál! | UA Запитуйте дозволу батьків, перш ніж користуватися інтернетом | RO Cere permisiunea părinților înainte de a te conecta online | BG Поискайте разрешение от родител, преди да влезете онлайн | LV Pirms došanās tiešsaistē palūdz atļauju vecākiem | ET Enne Interneti kasutamist küsi vanematelt luba | LT Prieš prisijungdami prie interneto, atsiklauskite tėvų | TR İnternete girmeden önce anne babandan izin iste



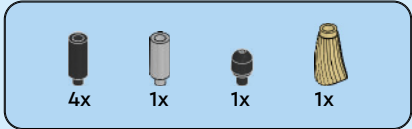

1

1



2



3

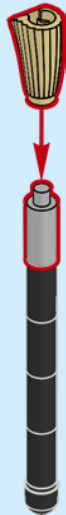

4

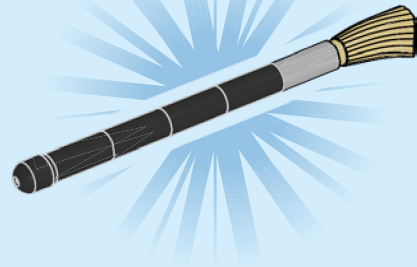
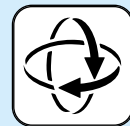

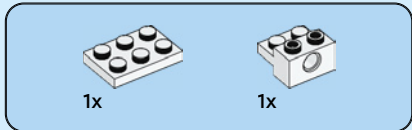
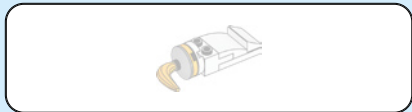

2

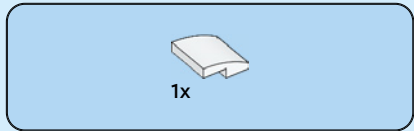
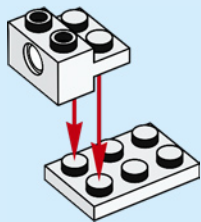

3





1x

4

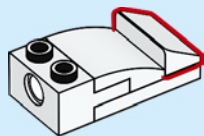

1x

5

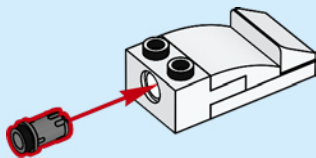

1x



1x



1x



1x

6

1



2



3

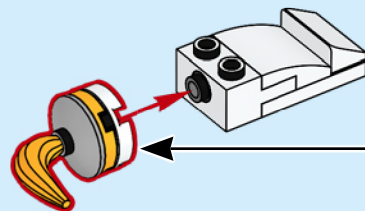
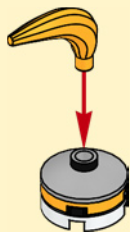

7

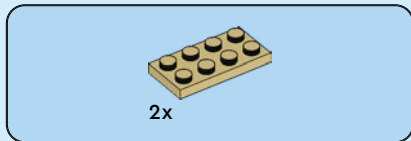
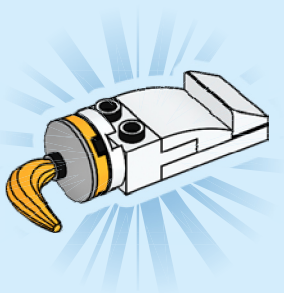

8

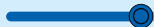
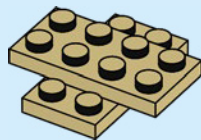

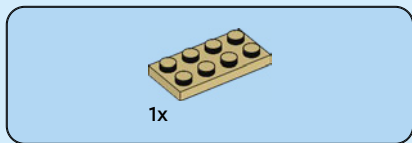

9

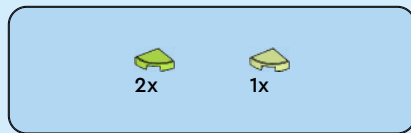
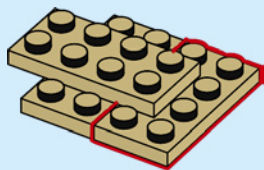

10

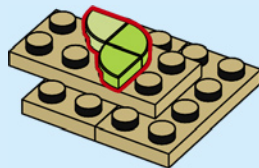

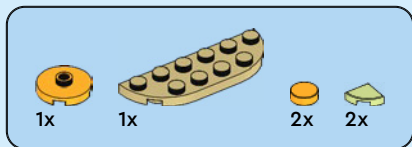

11

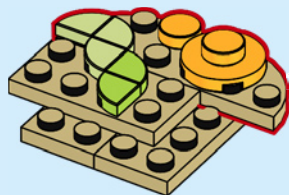
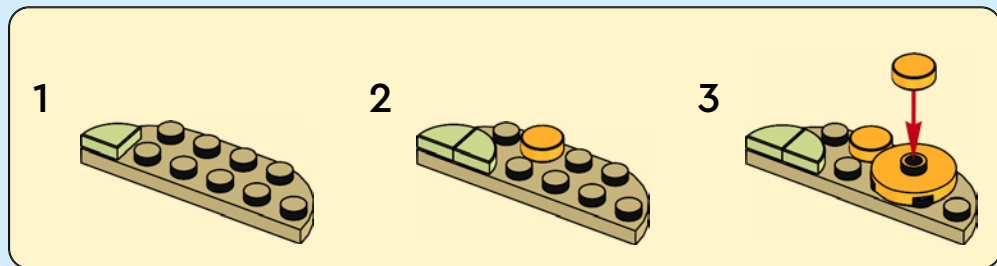

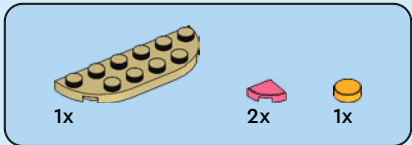

12

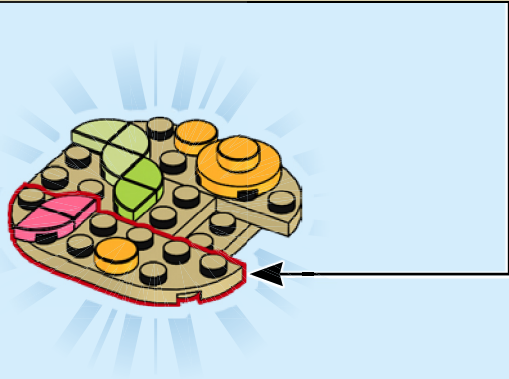
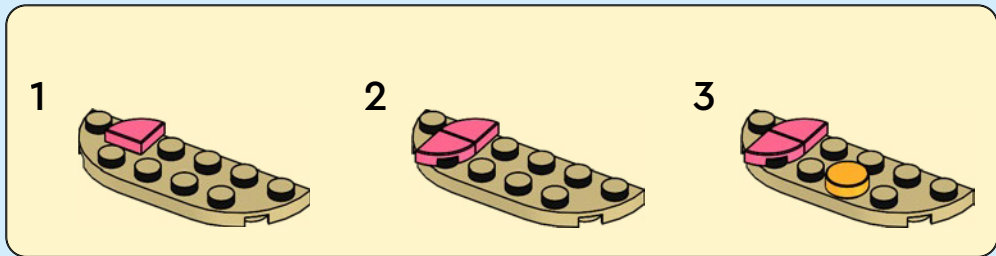

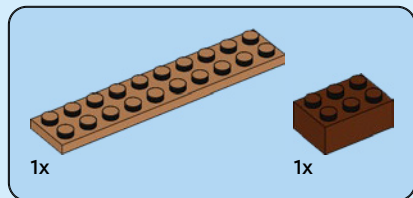
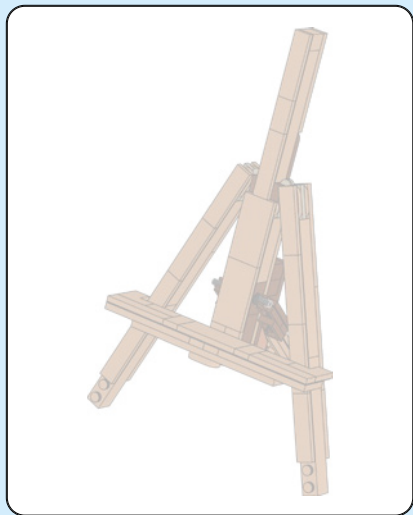

13

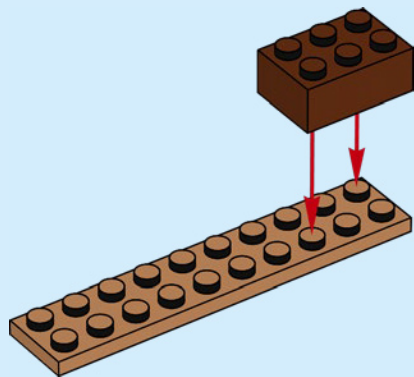

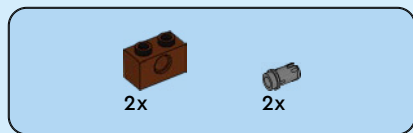

14

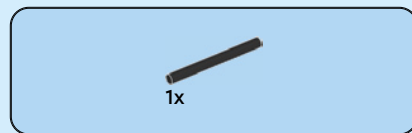
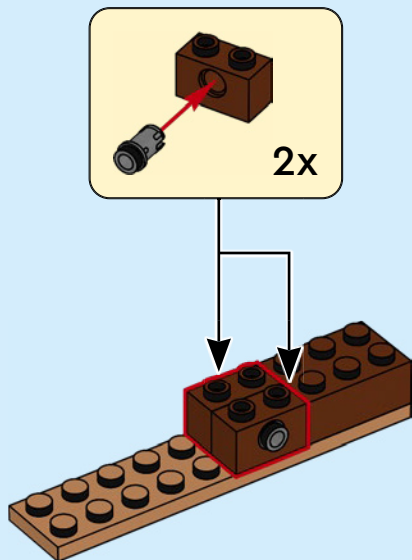

15

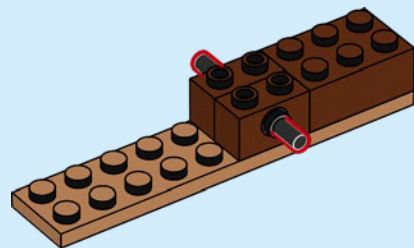

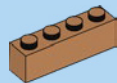

2x

16

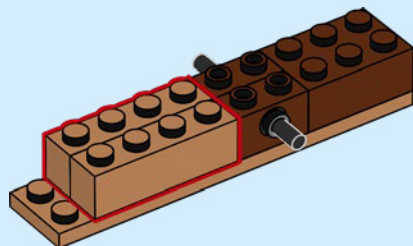

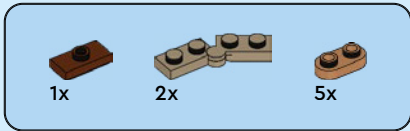

17

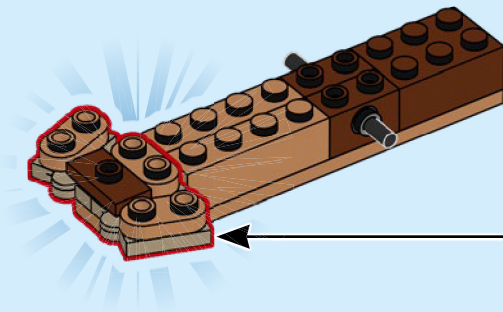
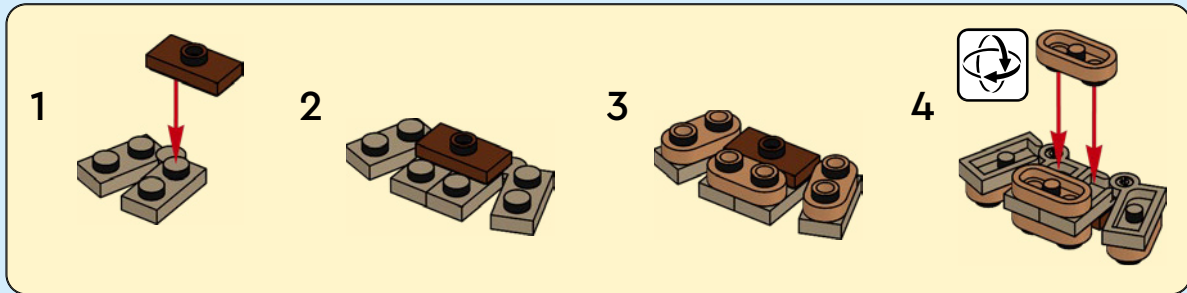

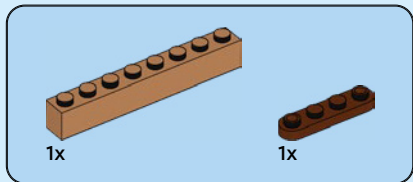
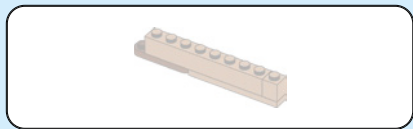

18

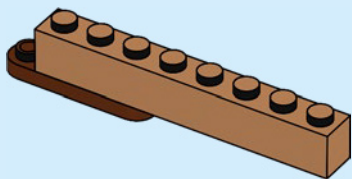

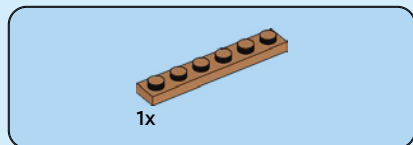

19

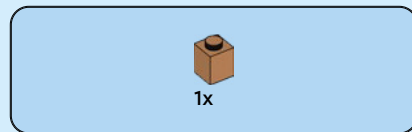
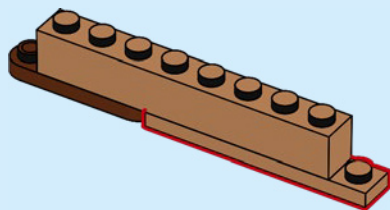

20

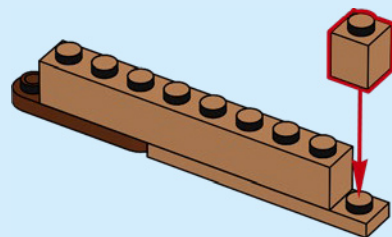

21

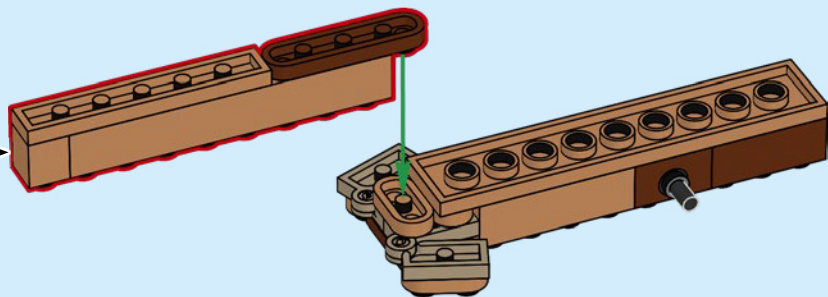

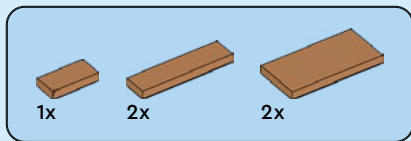

22

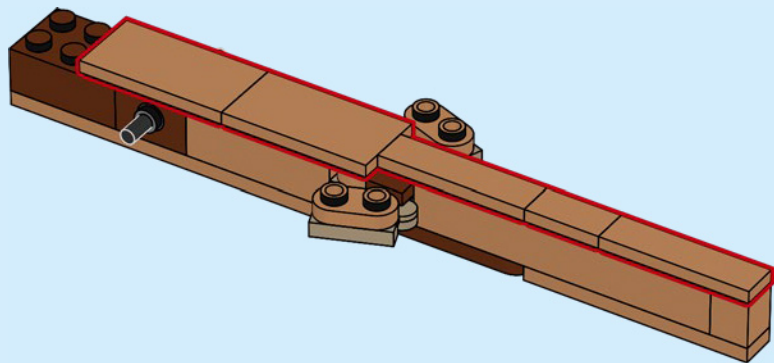

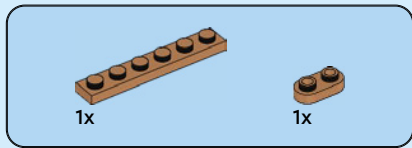
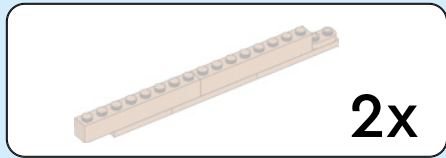

23

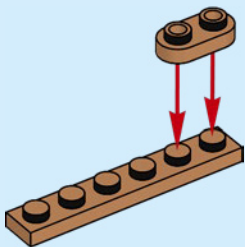

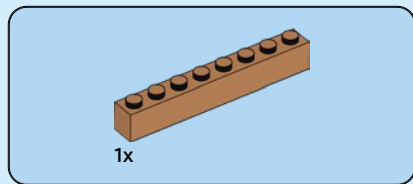

24

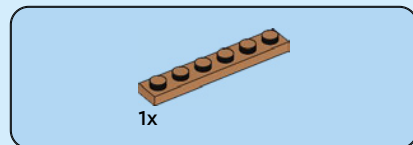
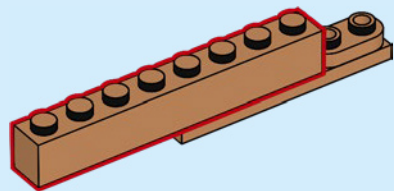

25

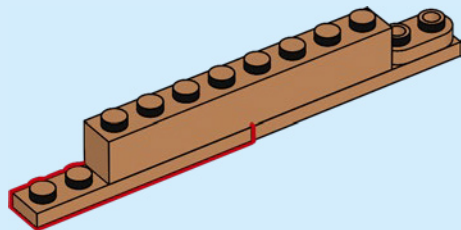

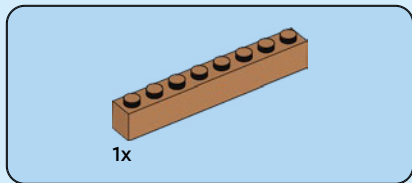

26

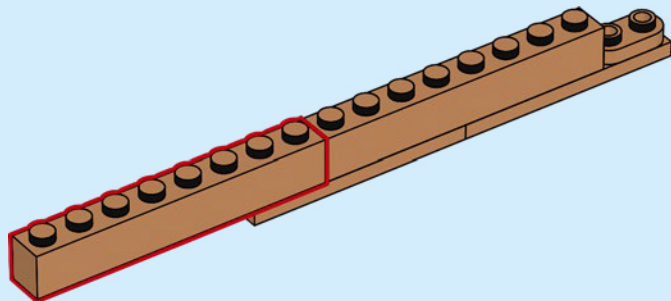

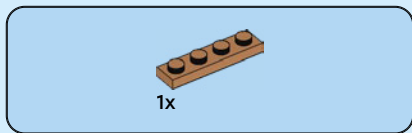

27

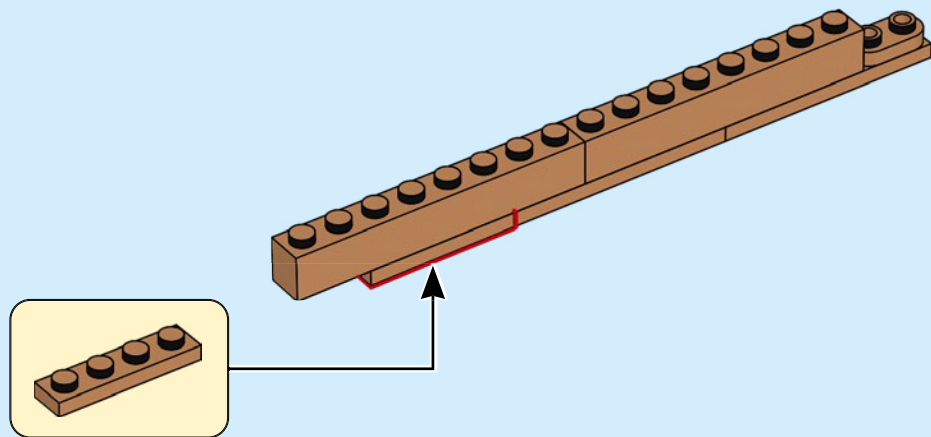

28

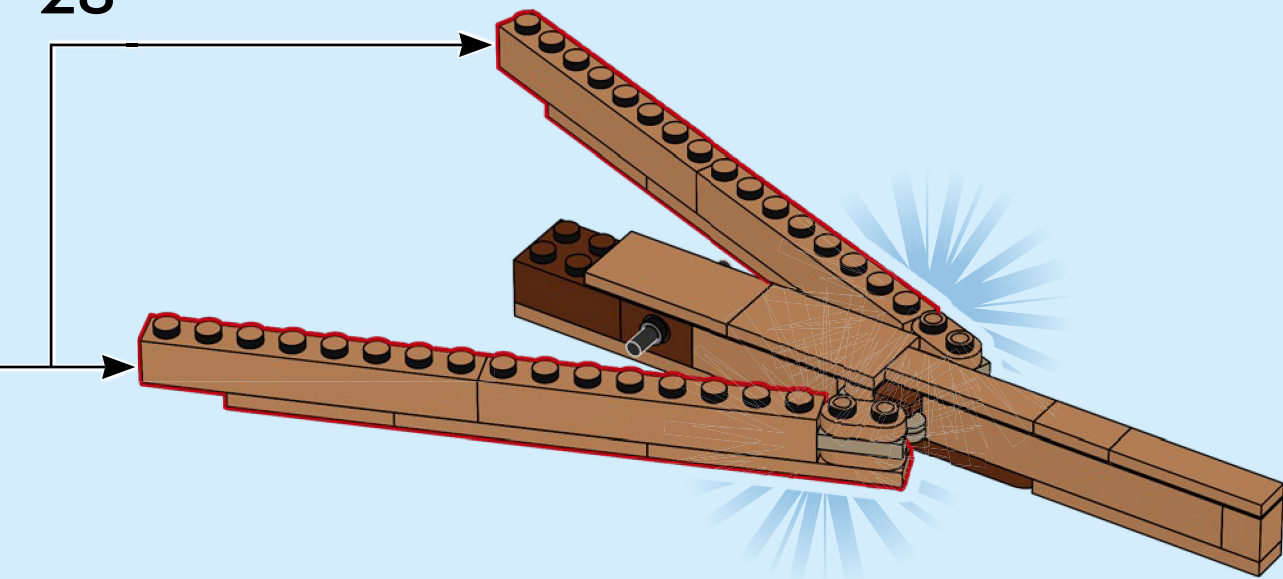

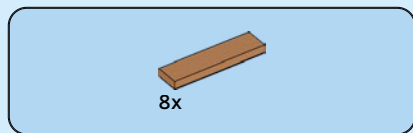

29

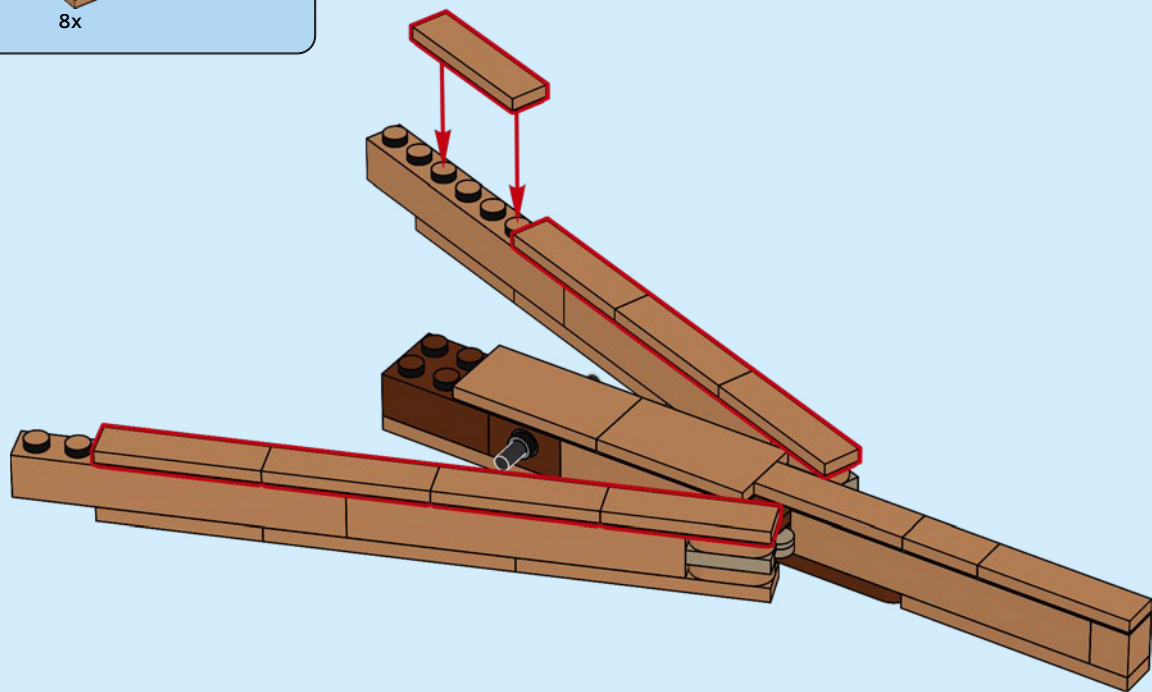



30

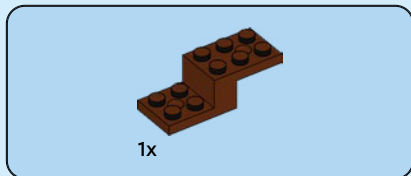
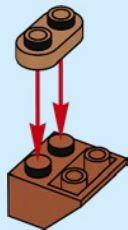

31

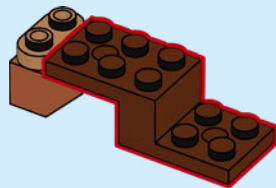



2x

32

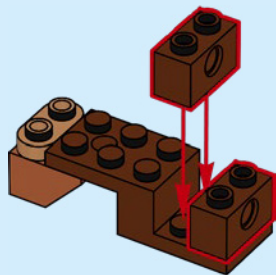

33

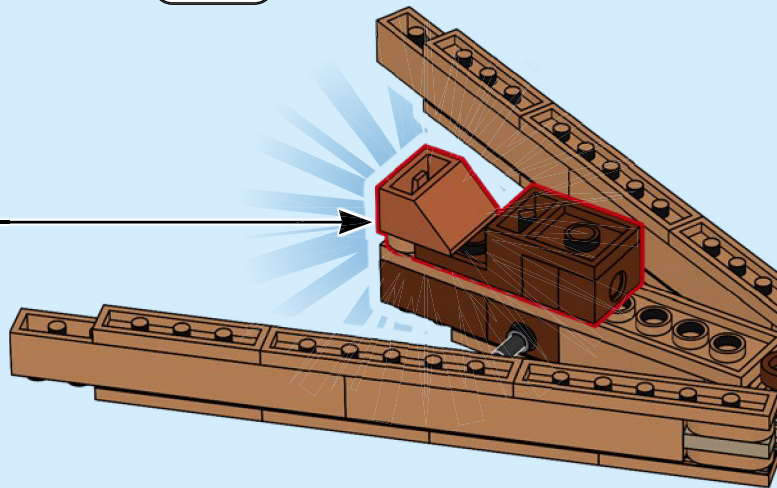
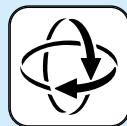

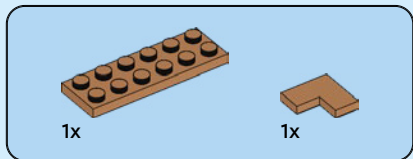
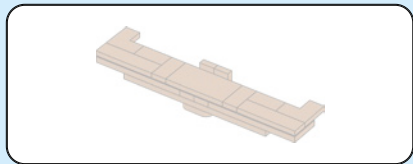

34

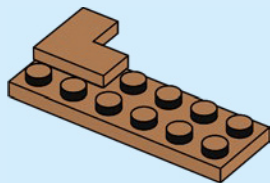

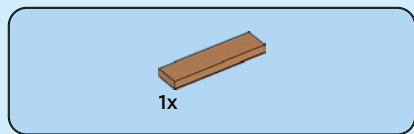

35

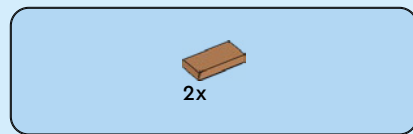
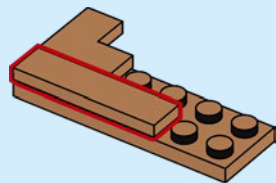

36

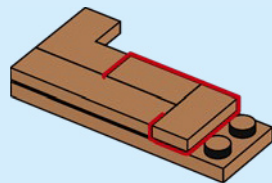

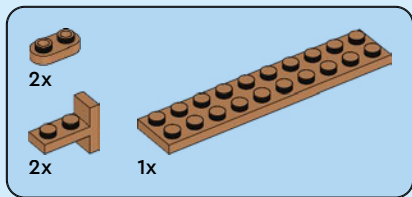

37

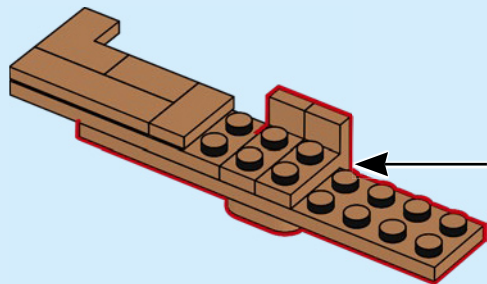
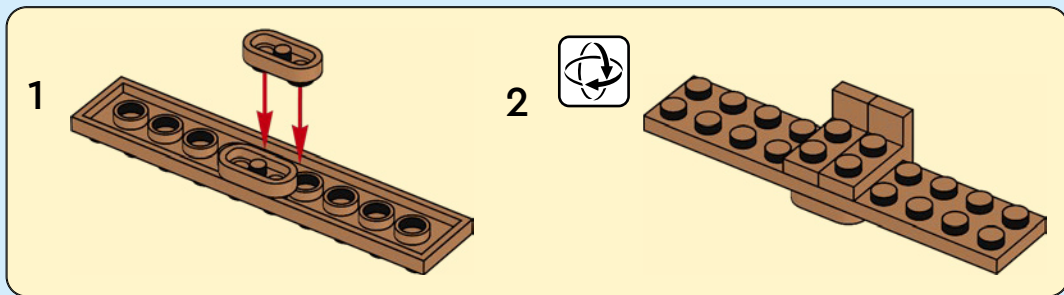

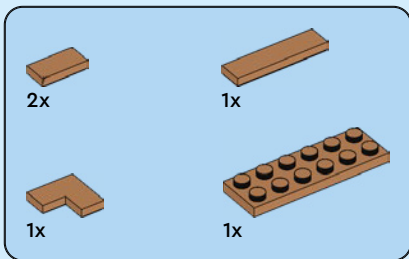

38

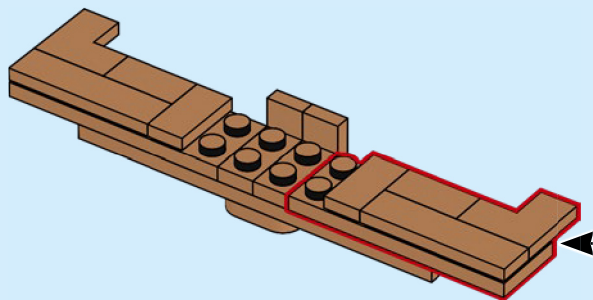
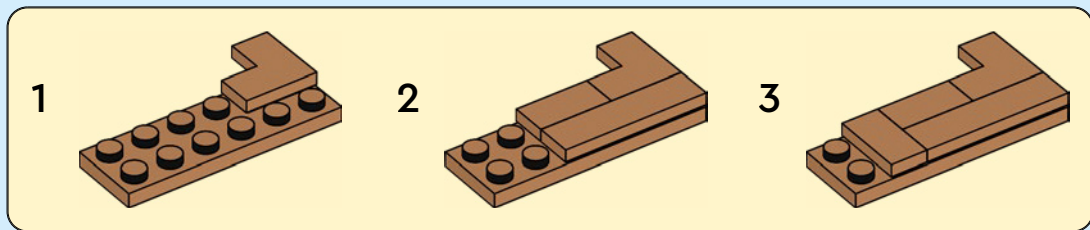

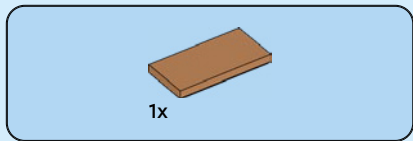

39

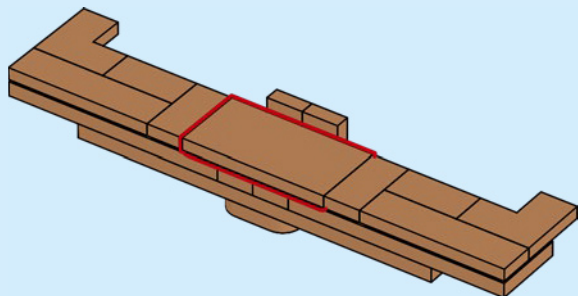

40

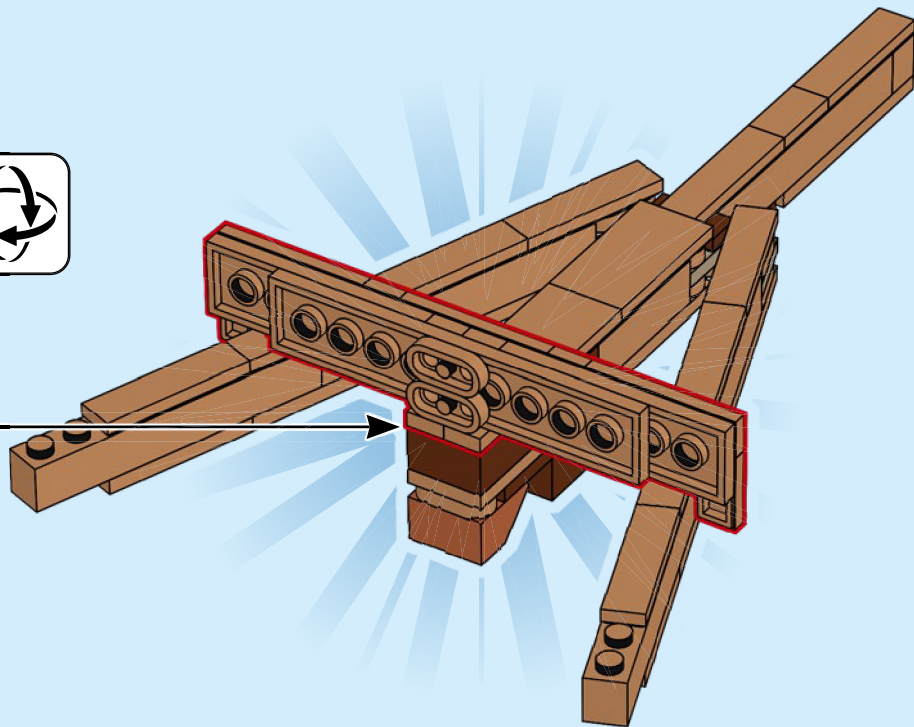
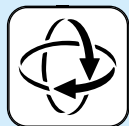

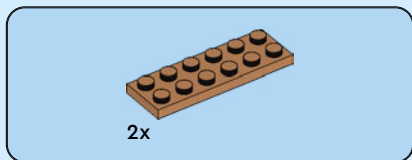
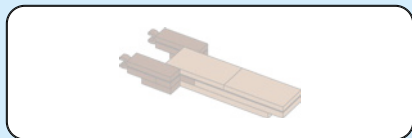

41

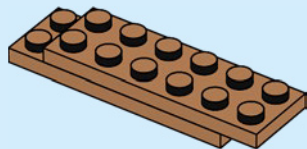

42

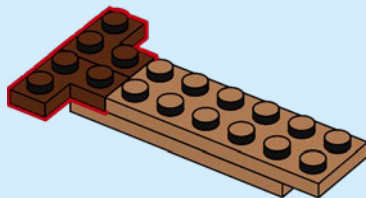

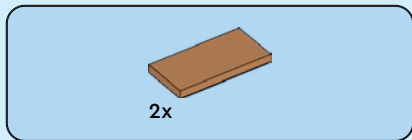

43

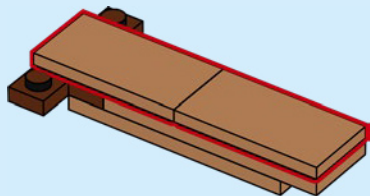

44

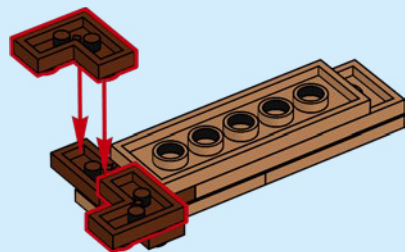



45

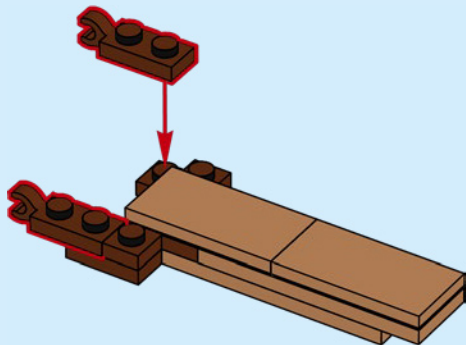
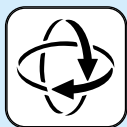

46

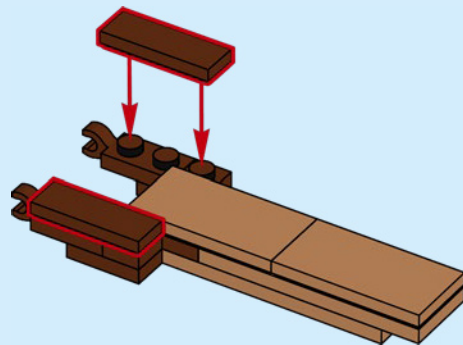

47

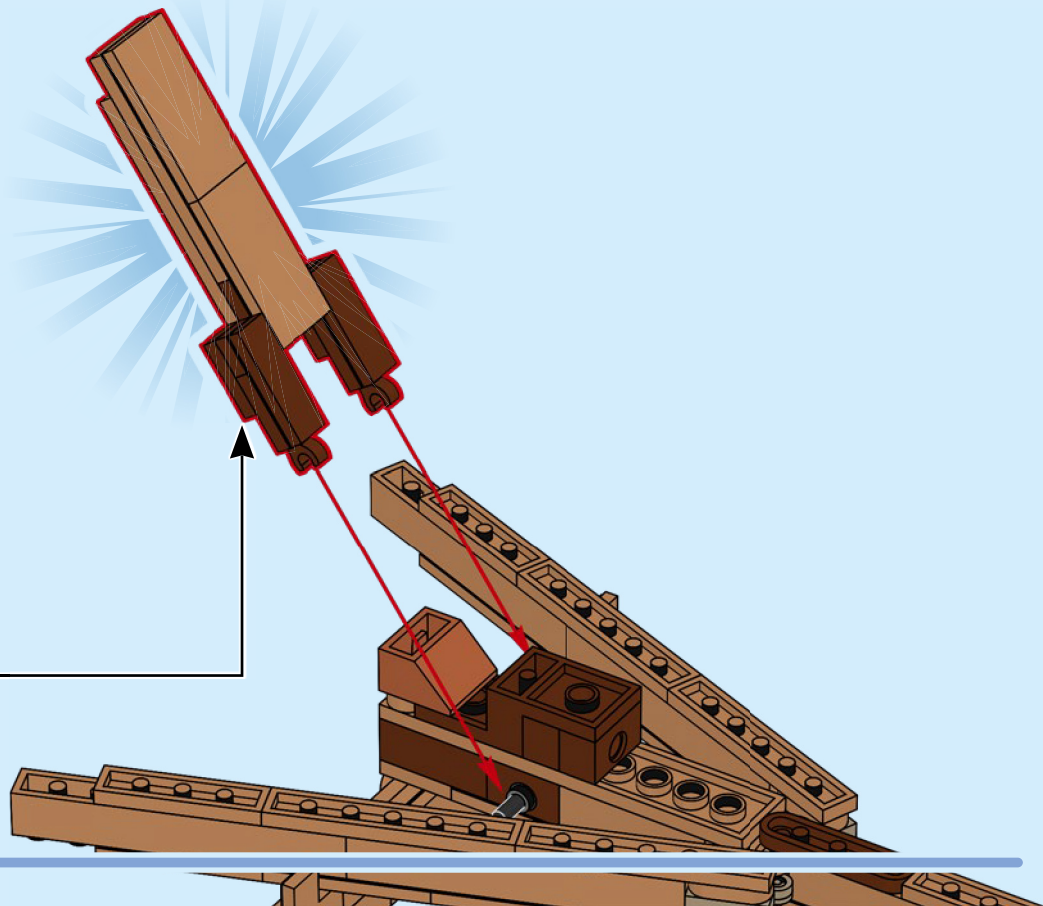

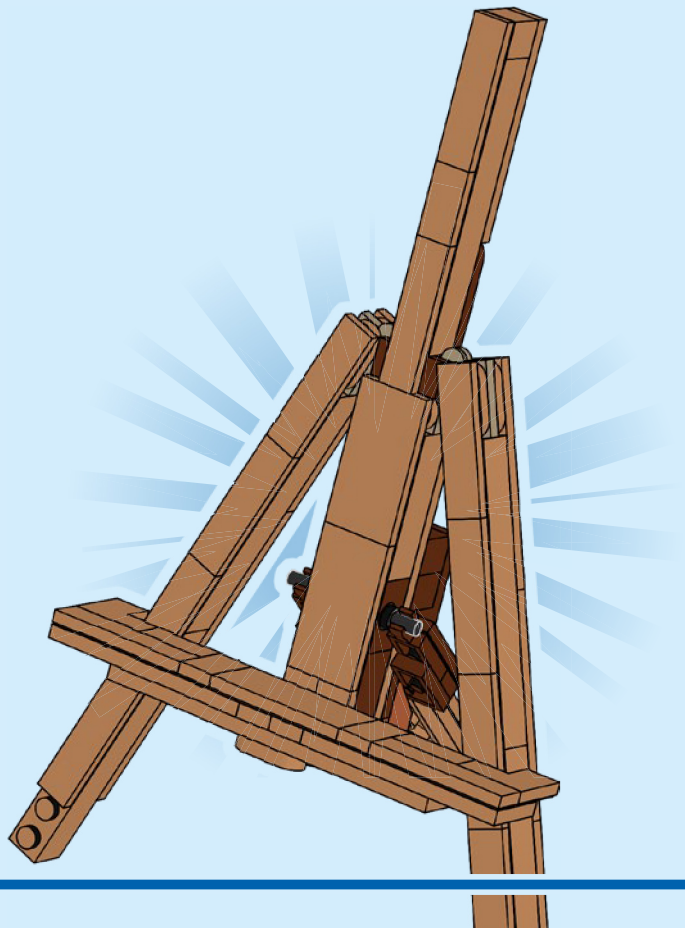

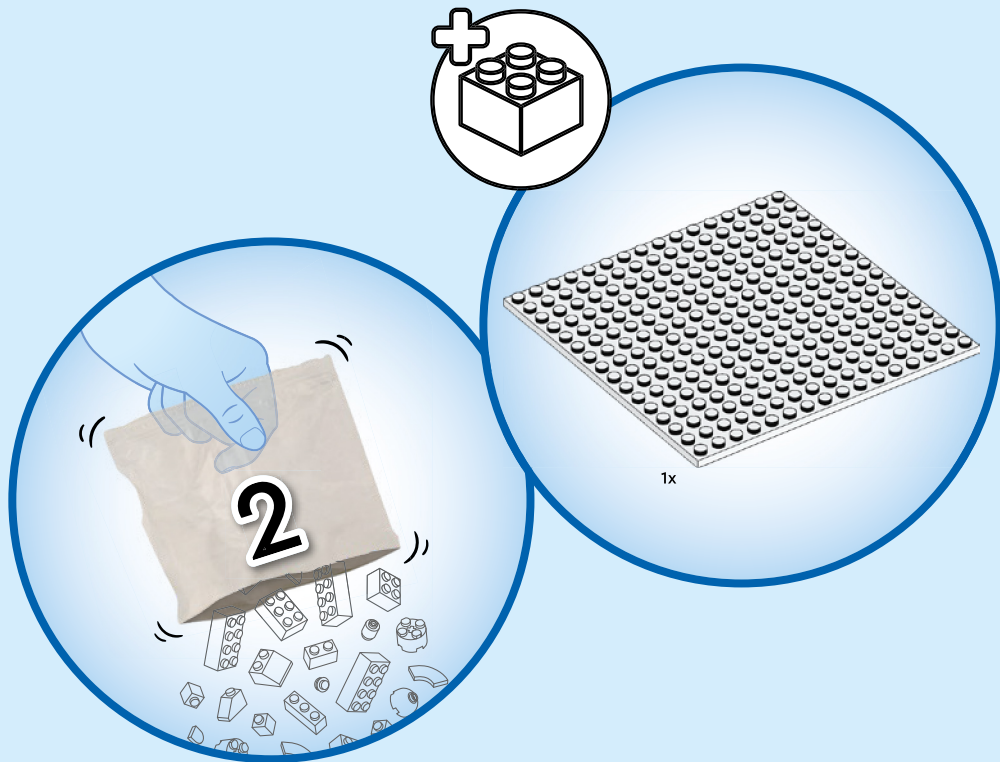

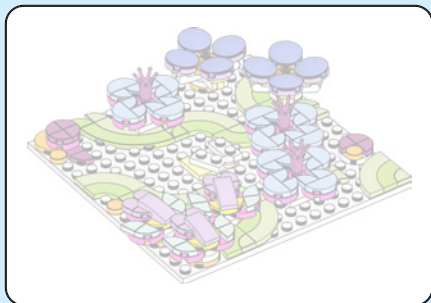

48

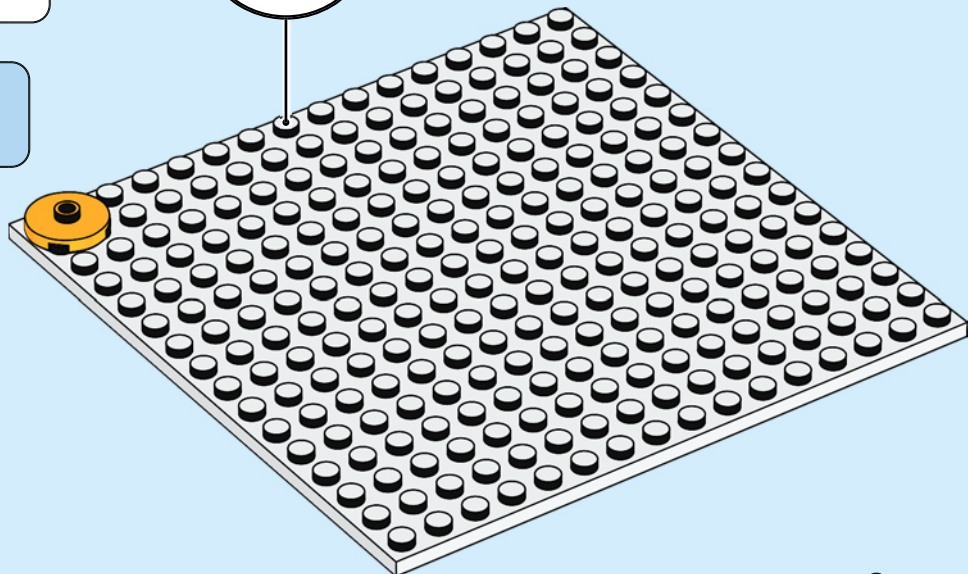
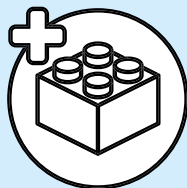



1x



1x



1x

49

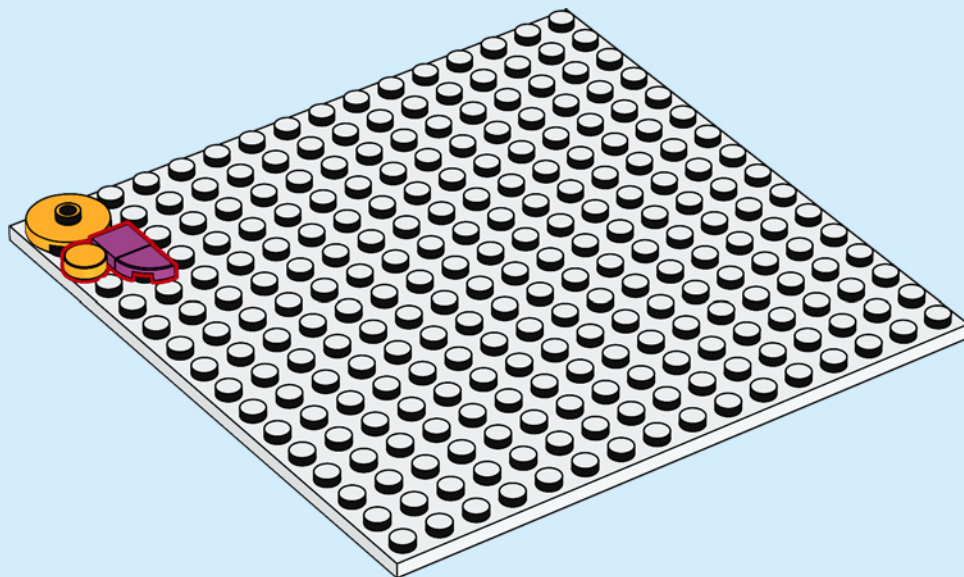

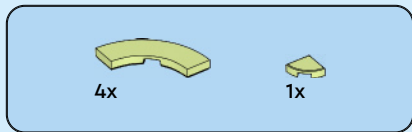

50

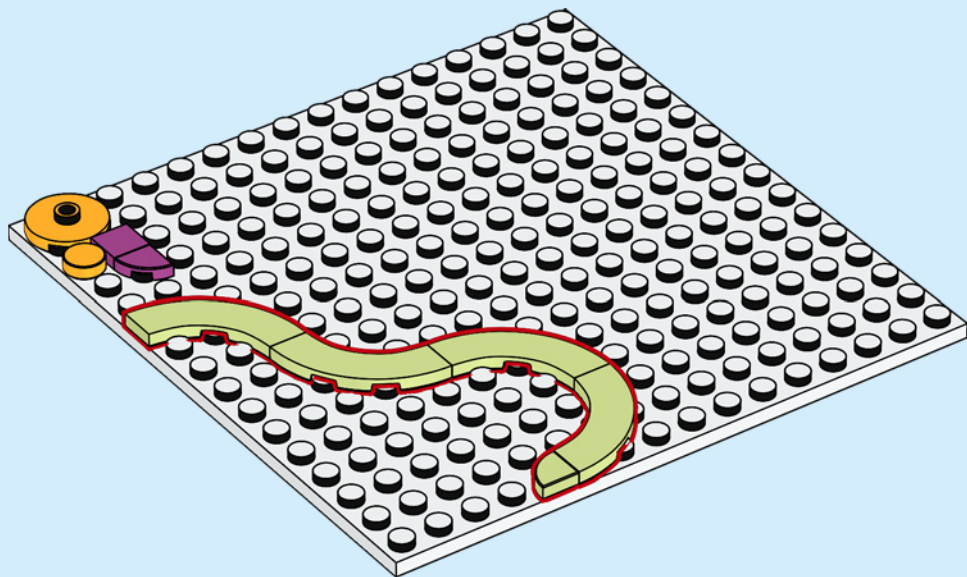

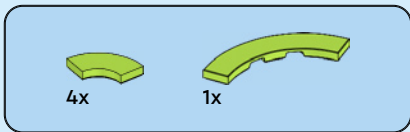

51

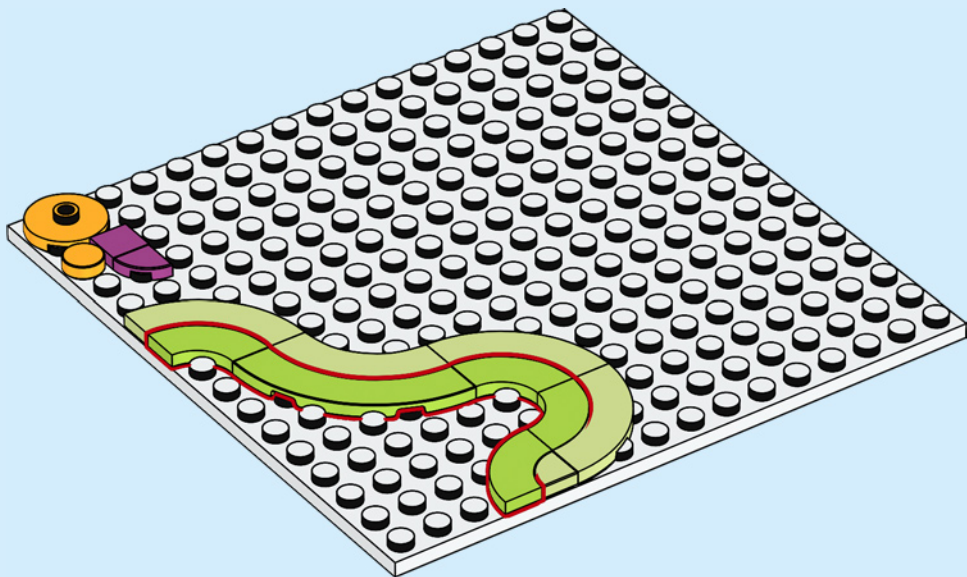



3x



1x

52

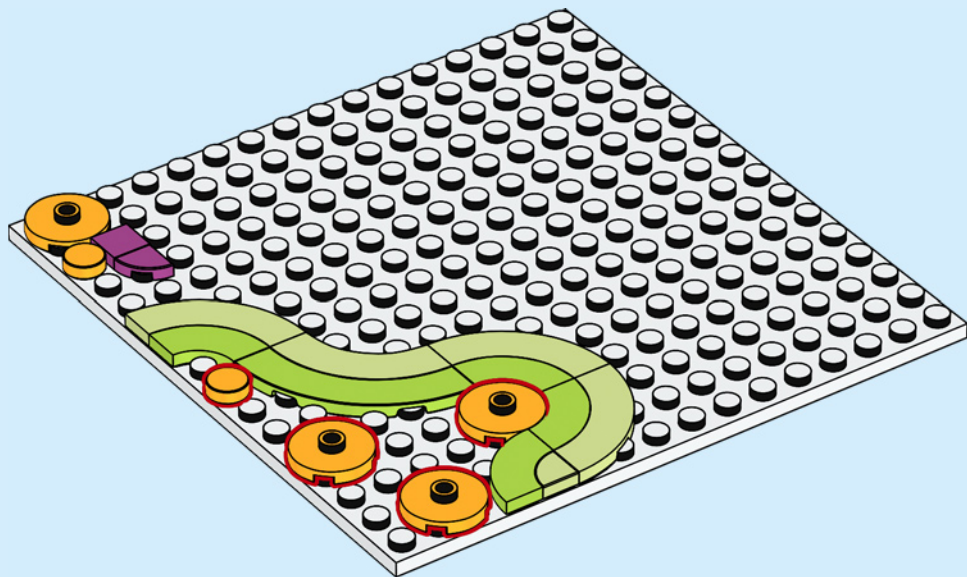

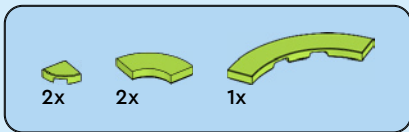

53

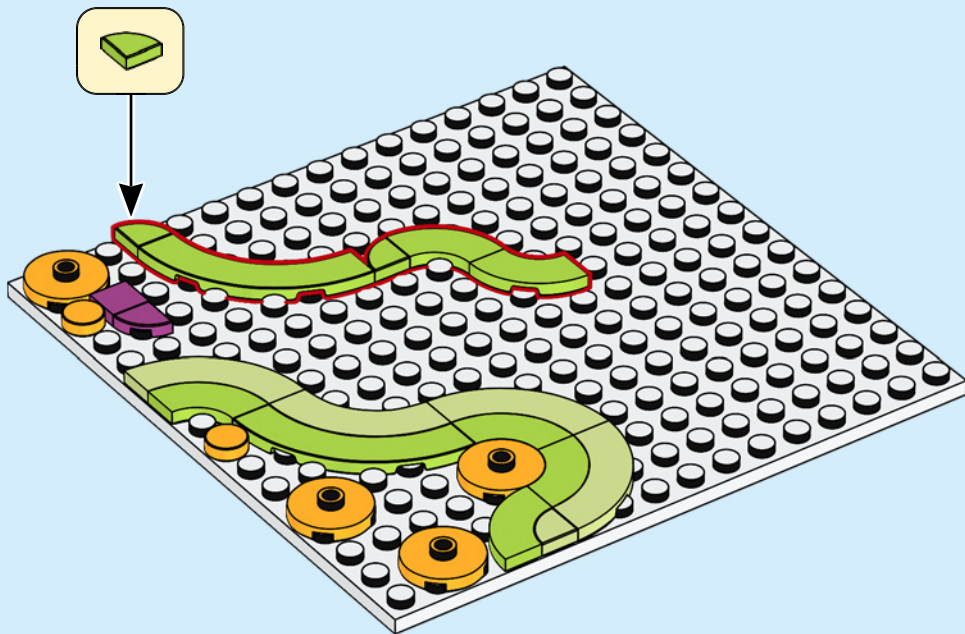

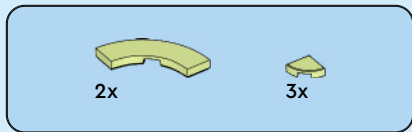

54

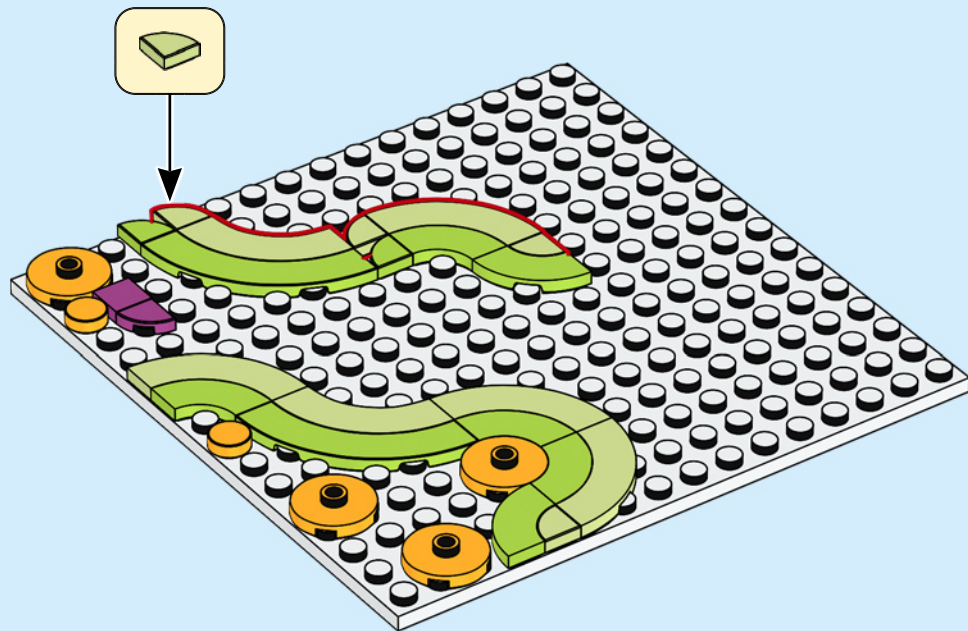



1x



1x

55

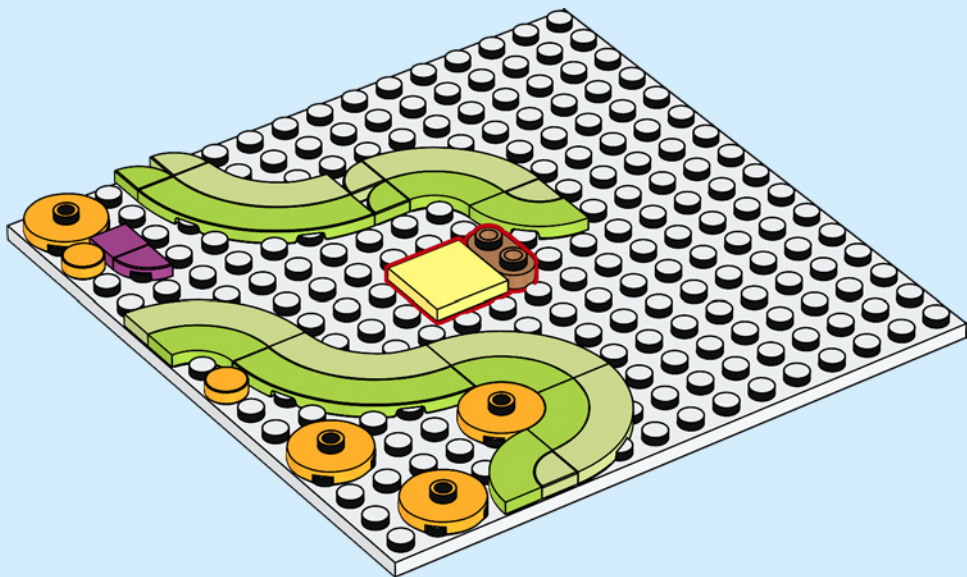



3x

56

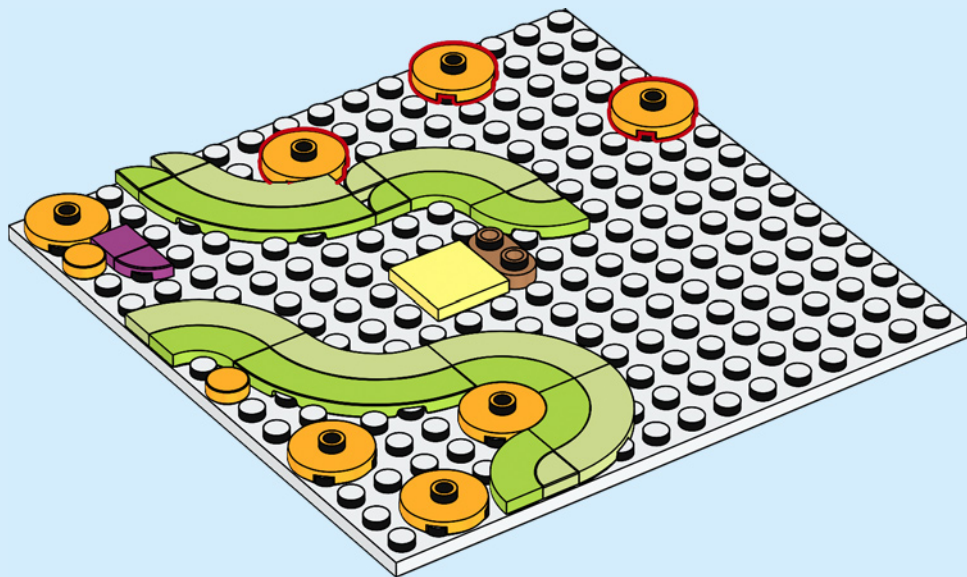



2x



2x

57

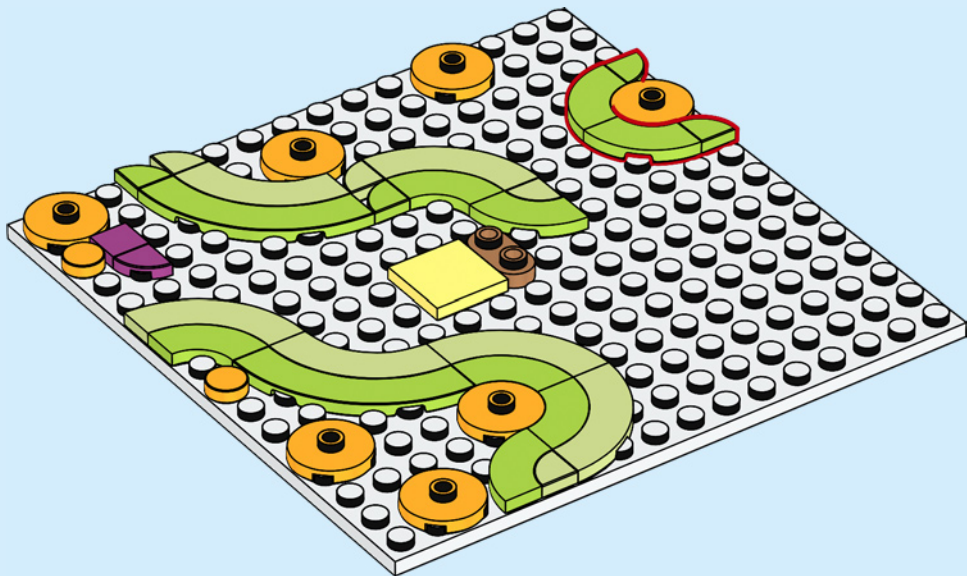

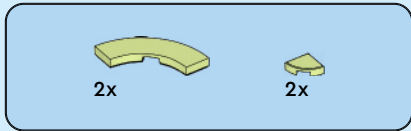

58

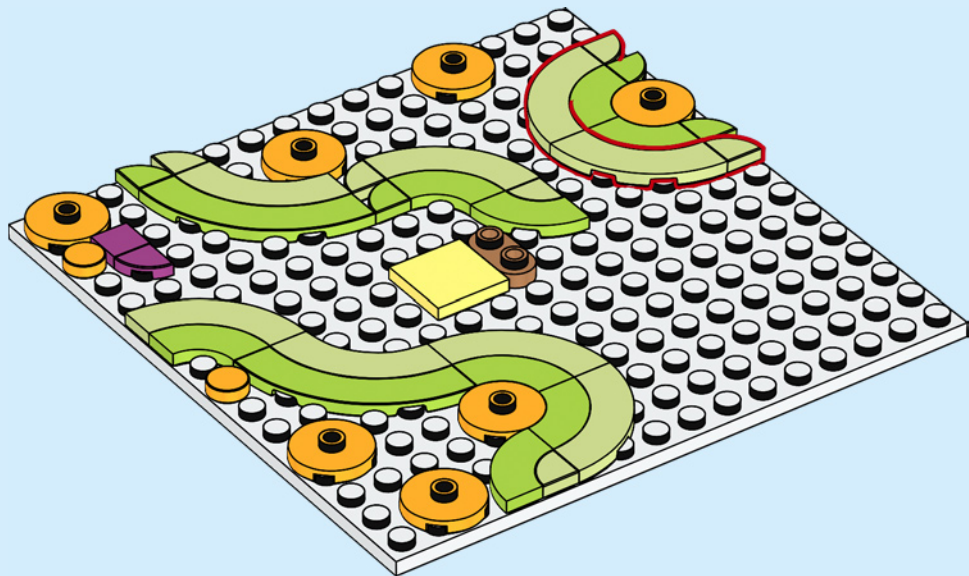



2x

59

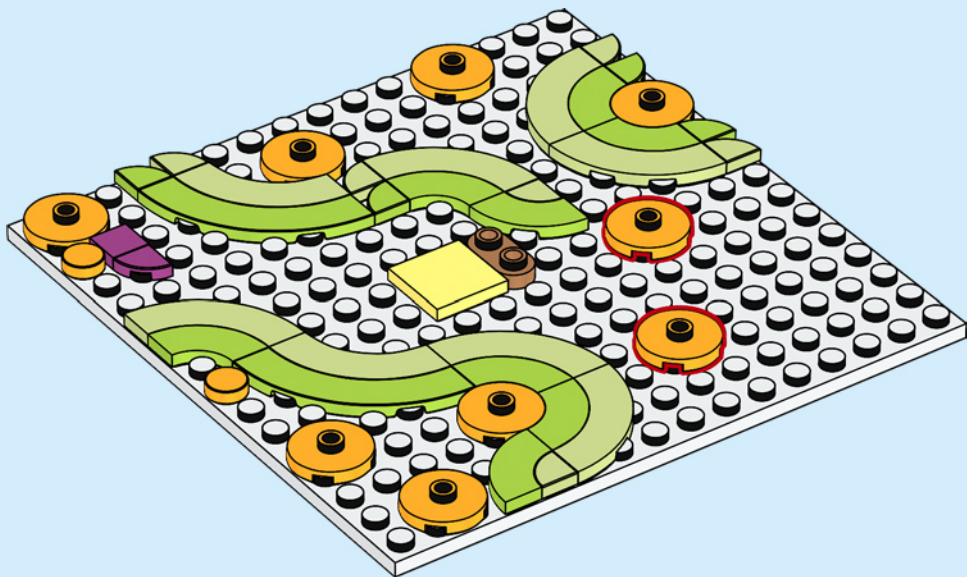



2x



1x

60

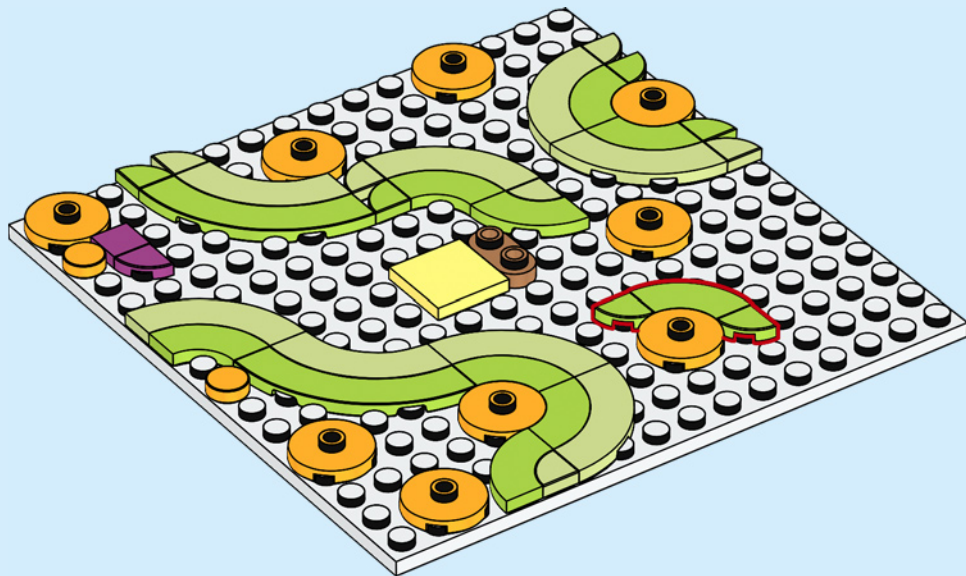



1x



1x

61

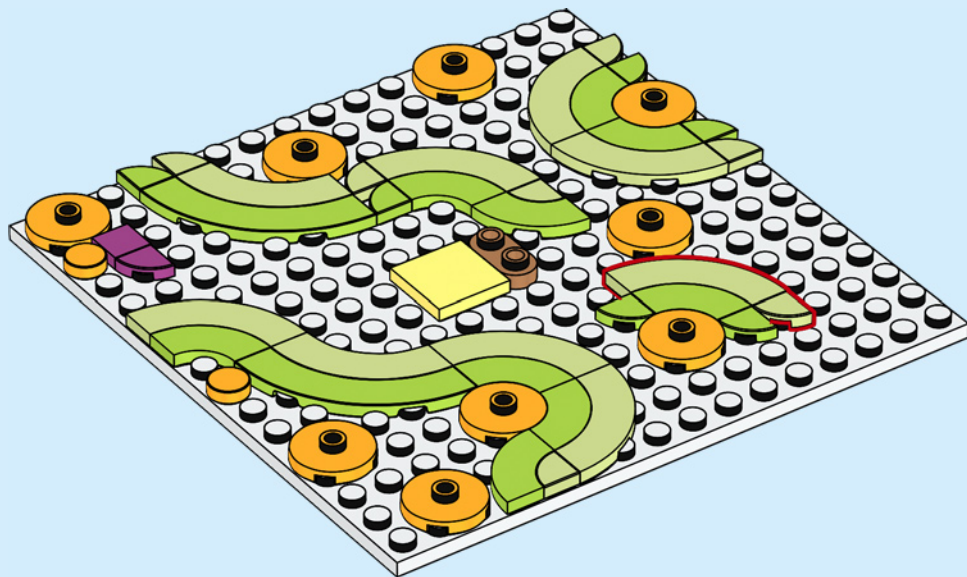

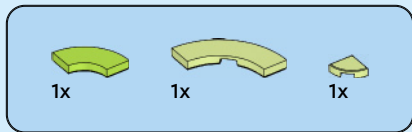

62

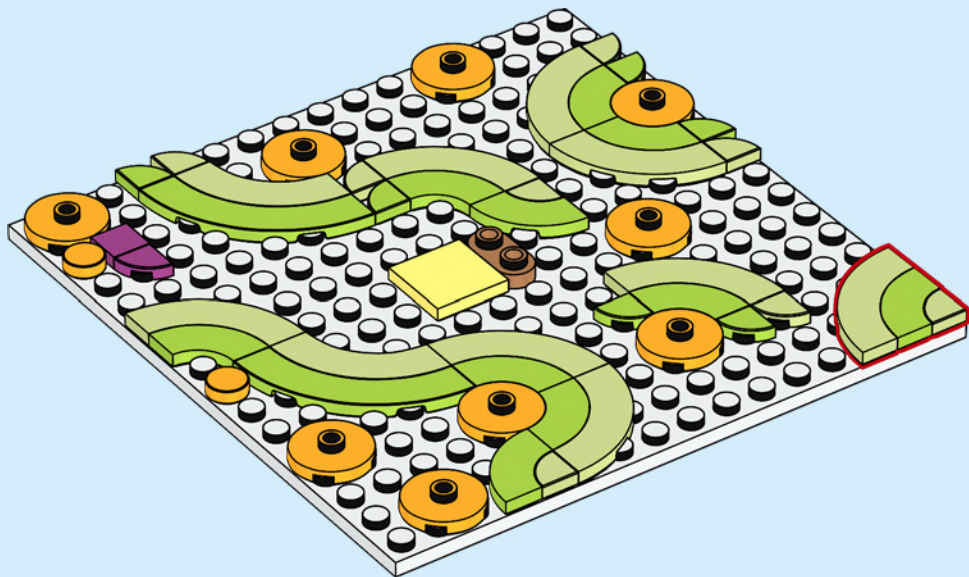

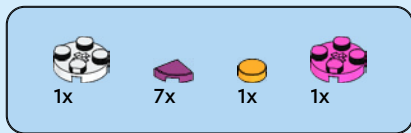

63

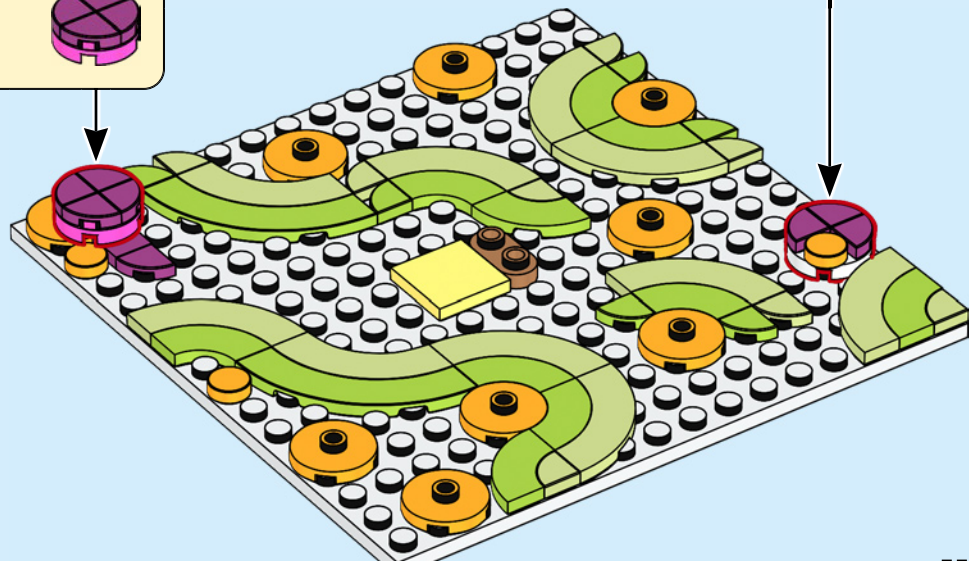
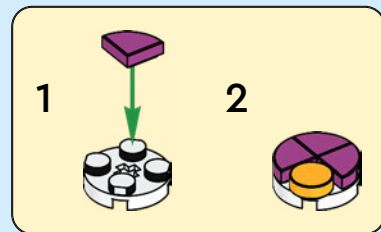
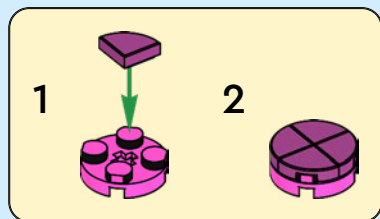



1x

64

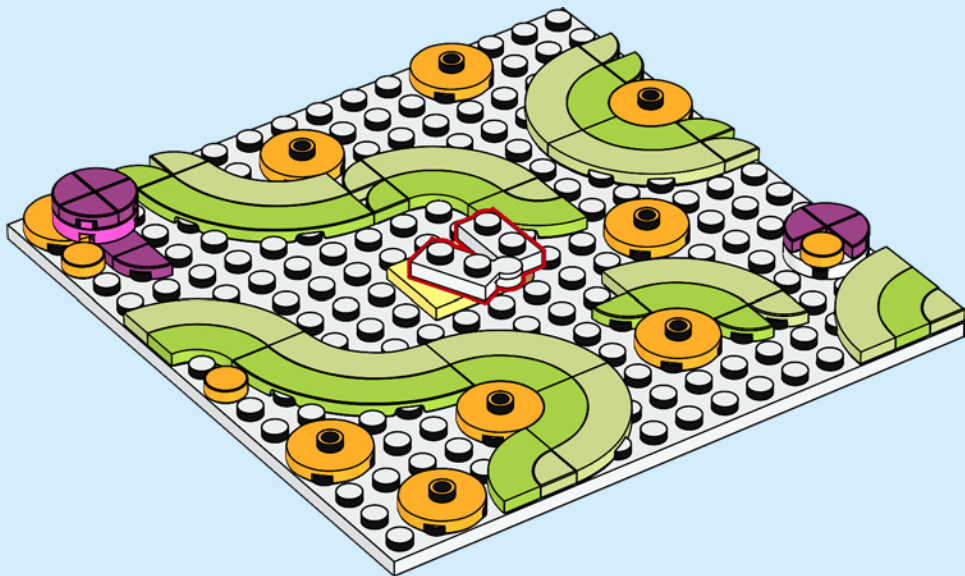

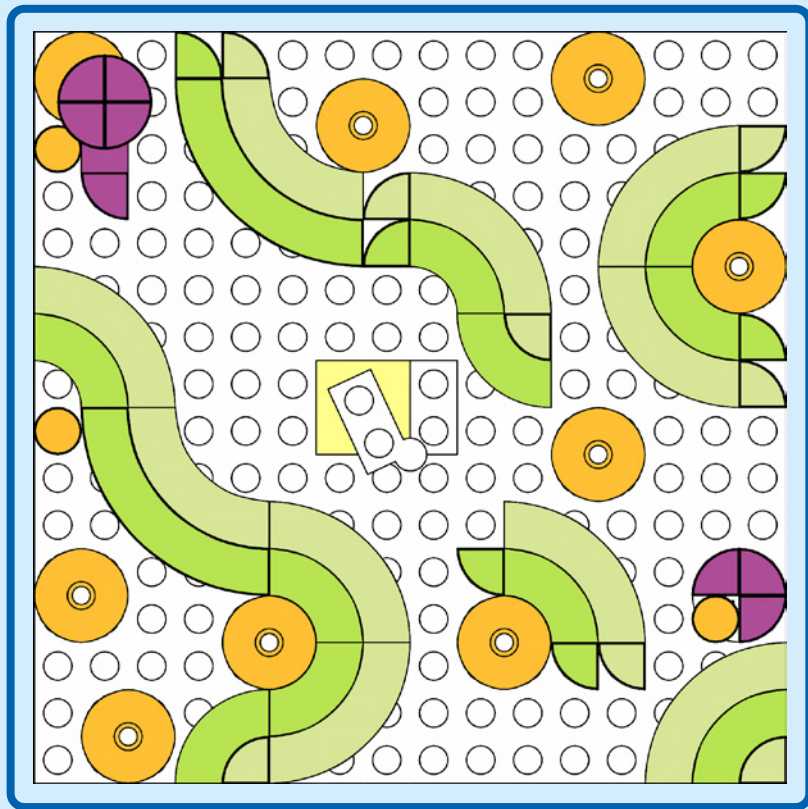



3x



1x



1x

65

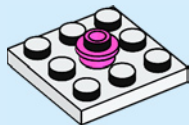

8x



4x



4x

66

1



2



4x

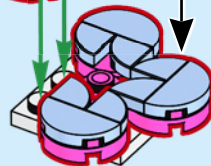



1x

67

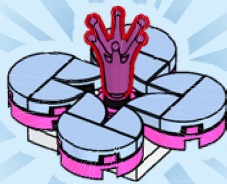

3x

68

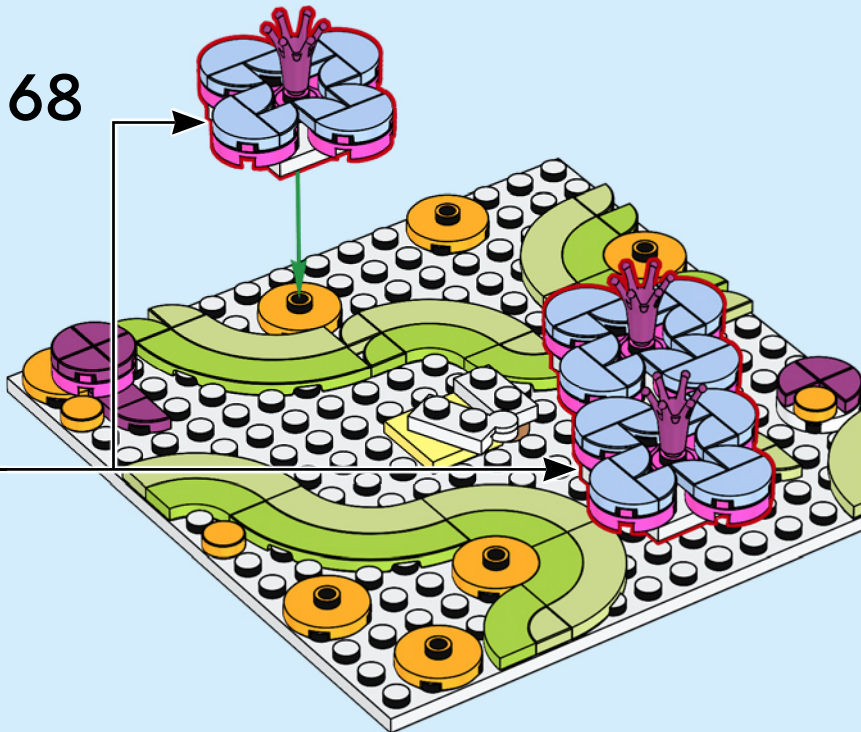



3x



1x



1x

69



1x

70



1x

71

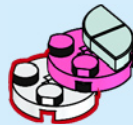



2x



1x

72

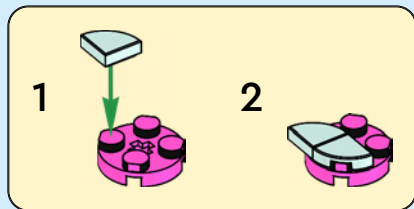

2

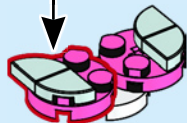

1x

73



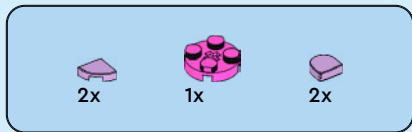

74

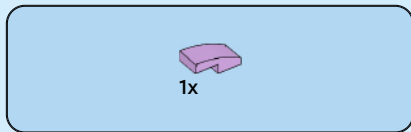
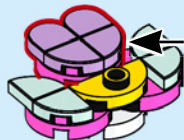

75



3x

76

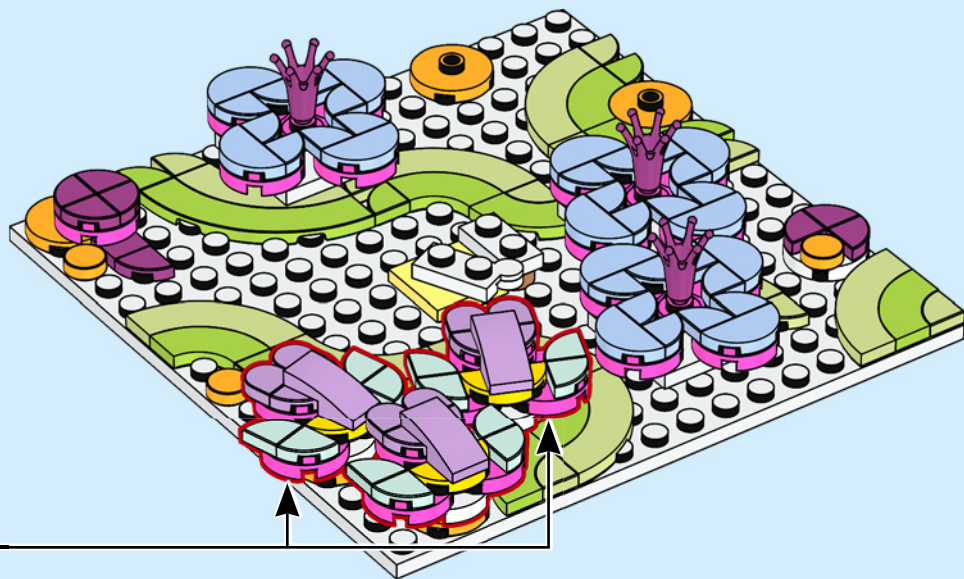





2x



1x



1x

77

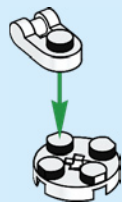

3x

78





1x



1x

79

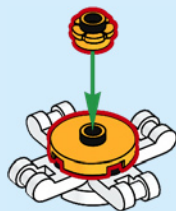

4x



4x



4x

80

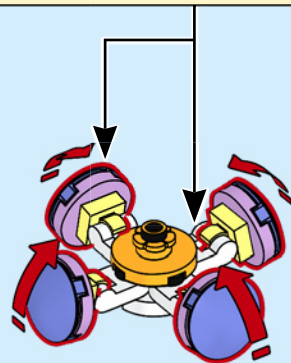
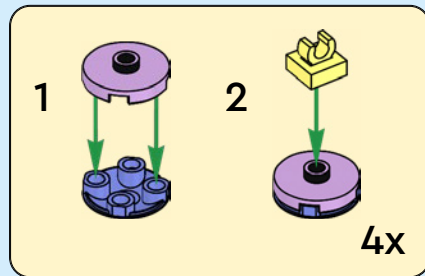

2x

81

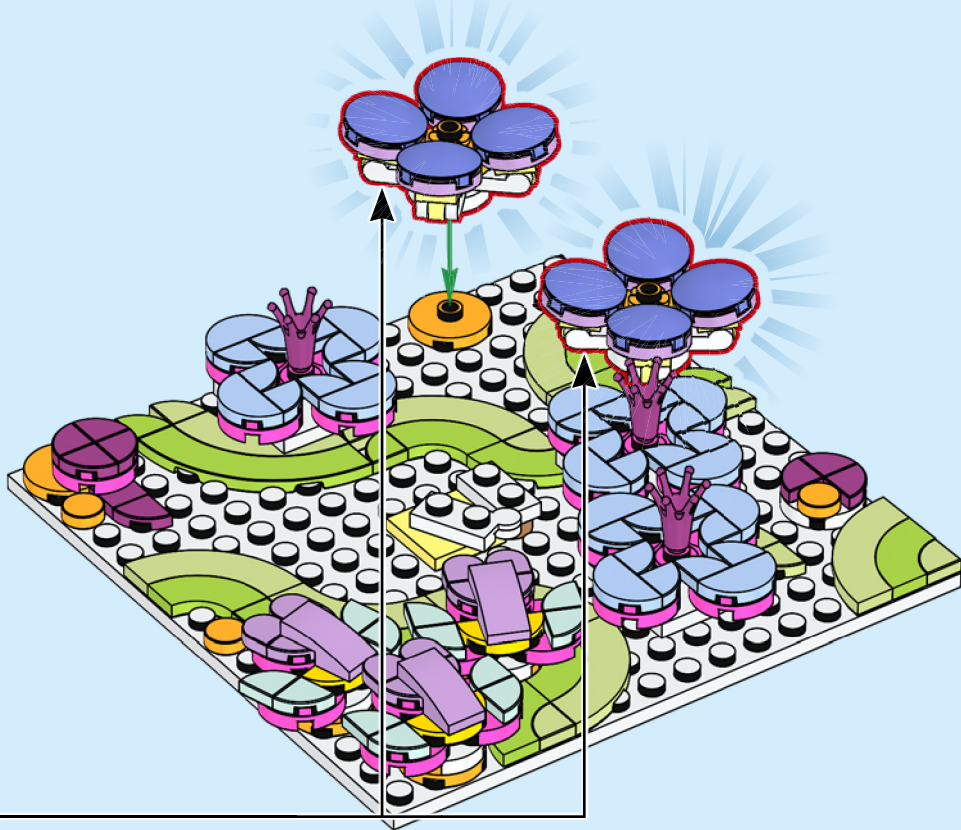



1x



3x



1x



1x

82

1

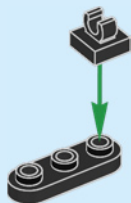

2

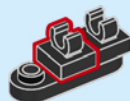

3

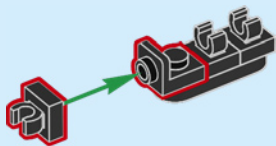

4

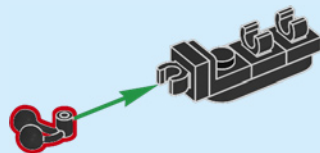

83



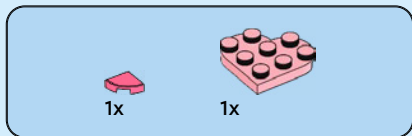

84

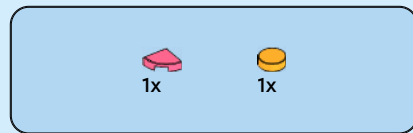
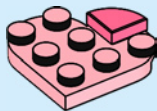

85

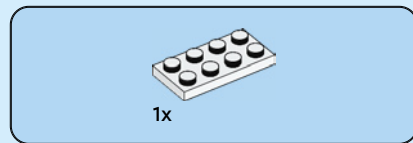
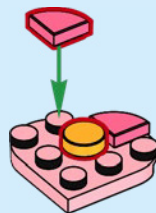

86

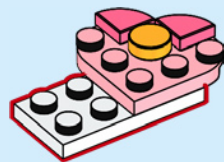



1x

87

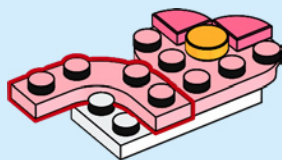

1x

88

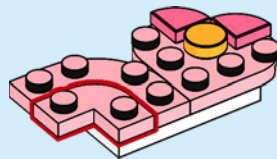



1x

89

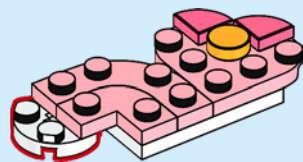

1x

90

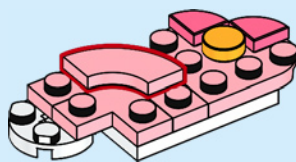



91

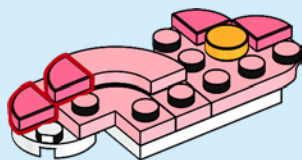

92

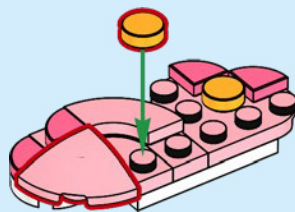



1x

93

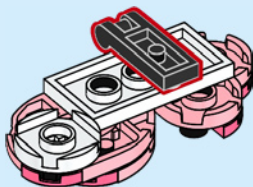
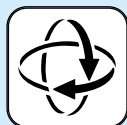

1x

94

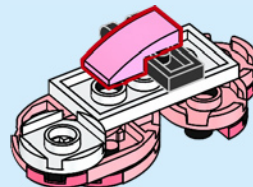

95



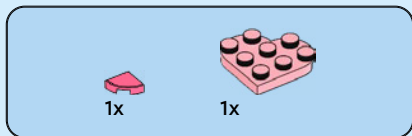

96



97

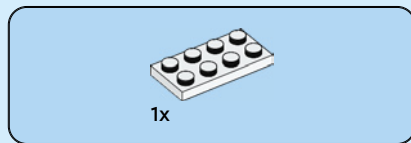

98

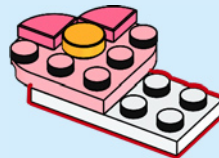



1x

99

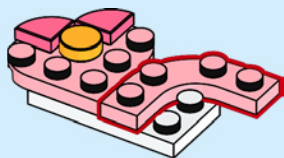

1x

100

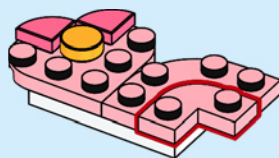



1x

101

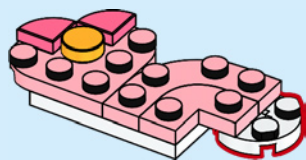

1x

102

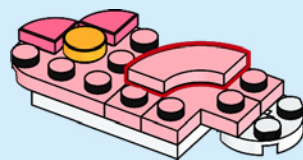



2x

103

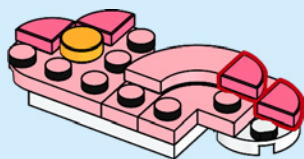

1x



1x

104

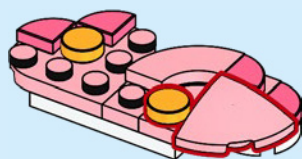



1x

105

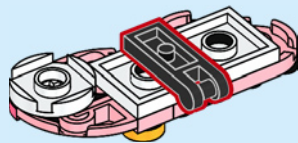

1x

106

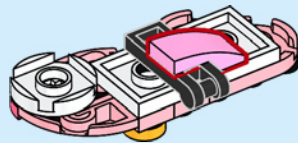







CREATOR™



LEGO

CREATOR™

**3
IN
1**

31385



31389



31386



31392



8x
6174937



1x
4547489



9x
403201



1x
6342970



1x
6047220



1x
302101



3x
6104805



1x
6497109



2x
302001

86

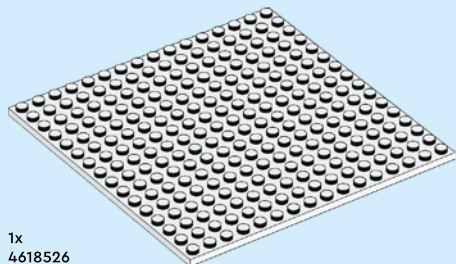

1x
4618526



1x
6514488



3x
4114309



2x
6210759



3x
6547142



4x
6290456



1x
6448948



1x
6607349



3x
6335388



1x
6234695



1x
6428168



2x
4515368



1x
6116604



1x
6187575



8x
6211875



10x
6441114



2x
6458173



8x
6199889



1x
6099364



3x
6607371



2x
6458397



2x
6209681



10x
6322822



13x
6133933



1x
6512533



1x
6436421



1x
4211512



3x
6395635



4x
4211252



1x
6092590



2x
6338135



4x
4211257



2x
6100769



1x
6463591



1x
4216668



1x
6535982



24x
6316571



12x
6587510



8x
6348060



1x
6286832



1x
6057986



11x
6517675



5x
6021997



2x
6607365



2x
6349274



12x
6102998



2x
6167700



2x
6223183



5x
6218359



5x
6295464



4x
6313600



5x
6396749



2x
6607346



3x
6230582



22x
6326495



2x
6296041



12x
6199886



6x
6329119



6x
6240465



8x
6223598



3x
6097647



11x
6607364



10x
6443414



10x
6250022



2x
6607335



2x
6607343



2x
6607347



2x
6607370



2x
6607366



1x
6375932



8x
6607372



 [LEGO.com/service](https://www.LEGO.com/service)

YOU COULD
WIN

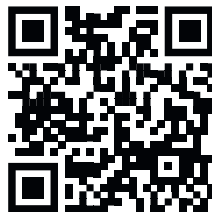

Scan this QR code or go to
LEGO.COM/PRODUCTFEEDBACK and give us
your short feedback about this LEGO® set
for a chance to win a cool LEGO prize.

Terms and Conditions apply*



EN: YOU COULD WIN. Terms and Conditions apply* **DE: Du könntest GEWINNEN.** Es gelten die Teilnahmebedingungen* **FR: TU POURRAIS GAGNER.** Des conditions s'appliquent* **IT: Potresti VINCERE tu.** Termini e condizioni sono applicabili* **ES: PUEDES GANAR.** Aplican términos y condiciones* **PT: PODERÁ GANHAR.** Aplicam-se Termos e Condições* **ZH: 轻松获奖.** 条款和条件适用* **PL: Szansa na WYGRANĄ.** Obowiązuje regulamin* **CS: Máte šanci VYHRÁT.** Platí všeobecné smluvní podmínky* **SK: Máte šancu VYHRAŤ.** Platia všeobecné zmluvné podmienky* **HU: TE IS NYERHETSZ!** Felhasználási feltételek érvényesek* **UA: ВИ МОЖЕТЕ ВИГРАТИ.** Застосовуються загальні положення та умови* **RO: Ai putea CÂȘTIGA.** Se aplică termenii și condiții* **BG: Можете да СПЕЧЕЛИТЕ.** Има определени правила и условия* **LV: Tu vari LAIMĒT.** Ir spēkā noteikumi un nosacījumi.* **ET: Sul on võimalus VÕITA.** Kehtivad tingimused* **LT: Jūs galite LAIMĖTI.** Taikomos sąlygos* **TR: KAZANABİLİRSİN.** Şartlar ve Koşullar geçerlidir*

*[LEGO.com/productfeedback-terms](https://www.lego.com/productfeedback-terms)

LEGO and the LEGO logo are trademarks of the/son des marques de commerce du/
son marcas registradas de LEGO Group. ©2026 The LEGO Group.

 6650074