



CREATOR™



31383





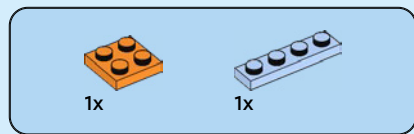

1

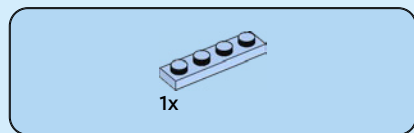
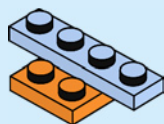

2

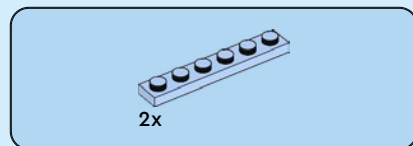
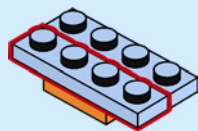

3

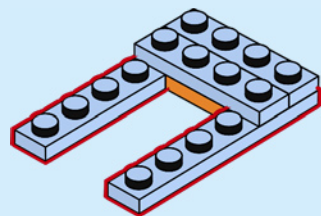



2x

4

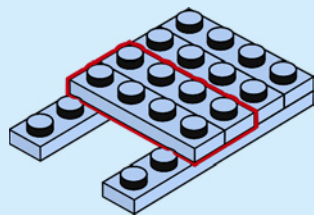

1x



2x

5

1

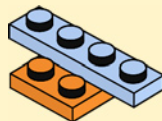

2

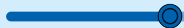
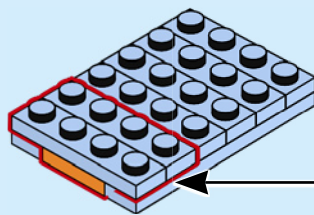
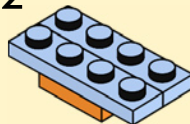



8x

6

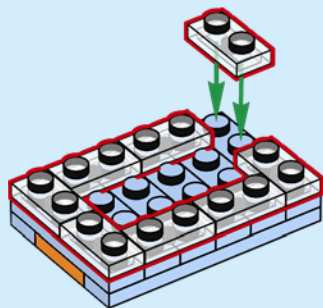

4x

7

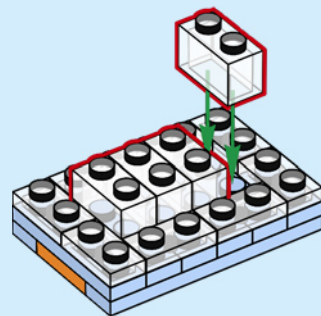



2x

8

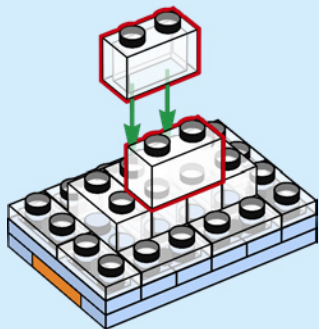

2x

9

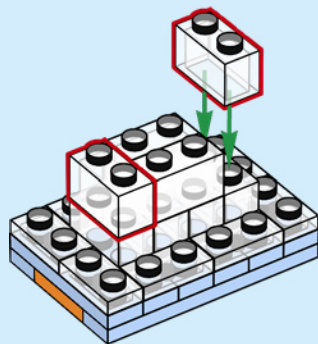



4x

10

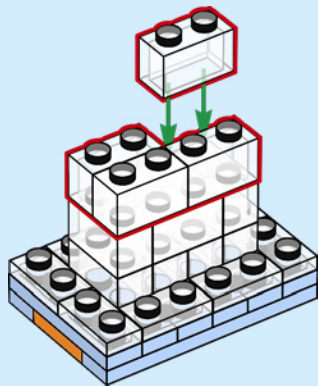

2x



1x

11

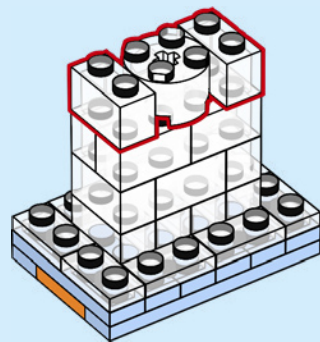

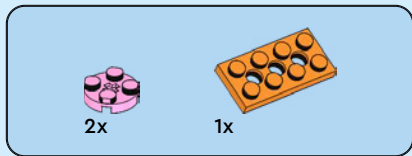

12

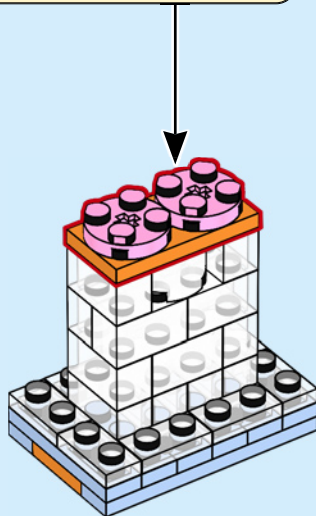
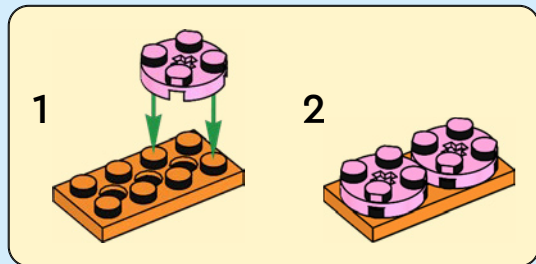



2x

13

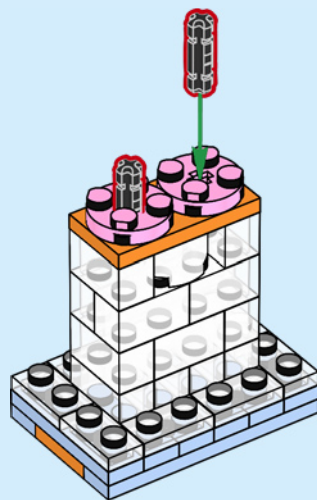



3x



2x

14

1

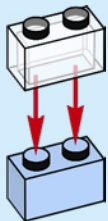

2

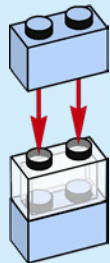

3

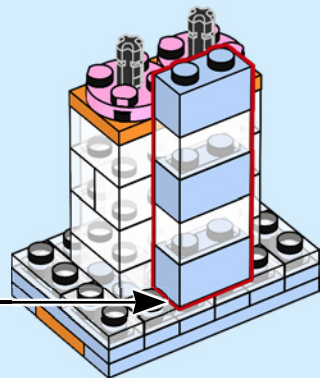
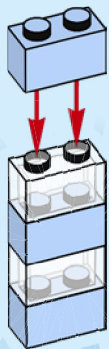

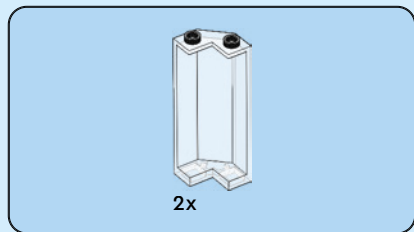

15

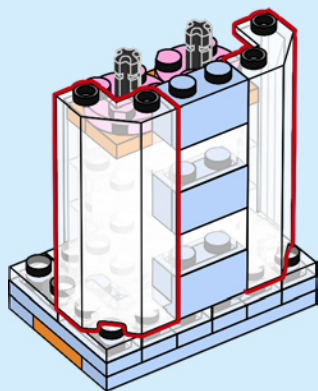

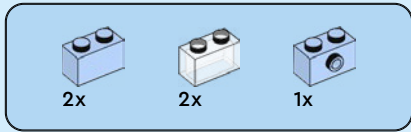

16

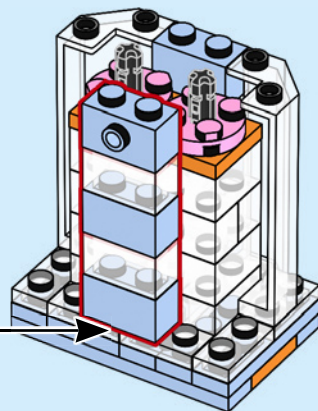
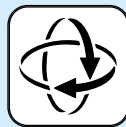
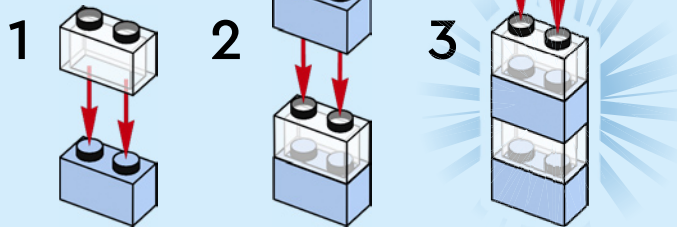

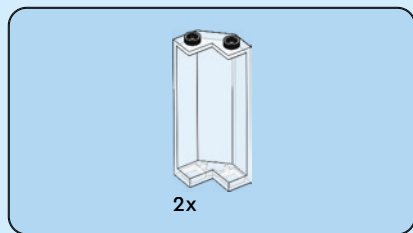

17

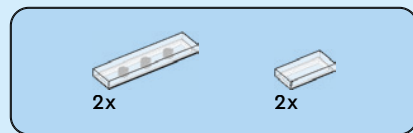
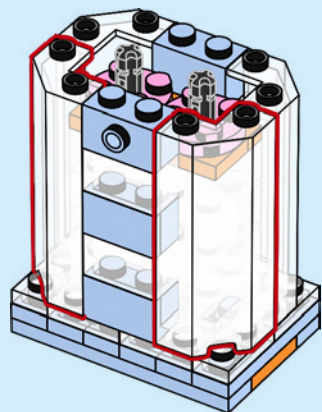

18

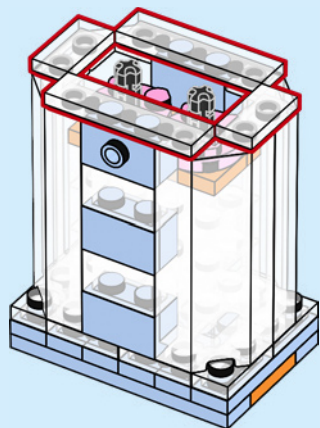

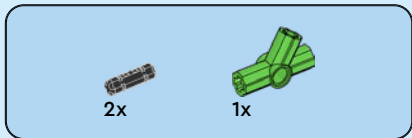

19

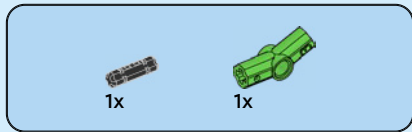
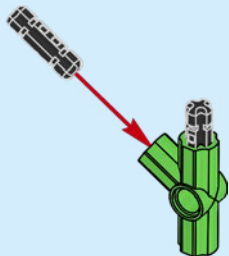

20



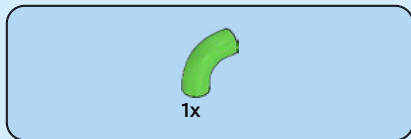

21

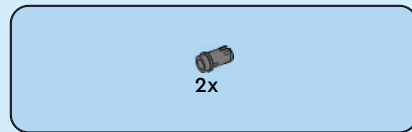
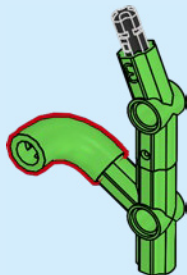

22

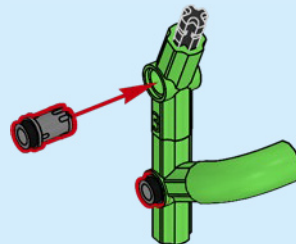



1x



1x

23

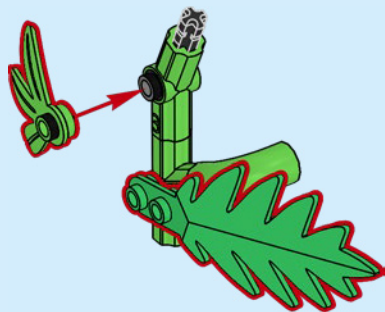

2x

24

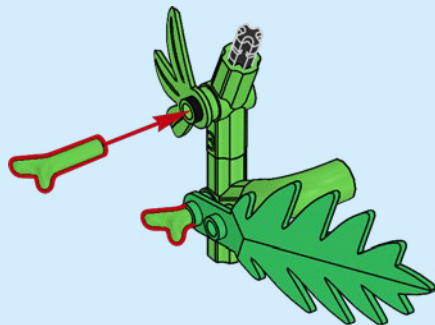

25

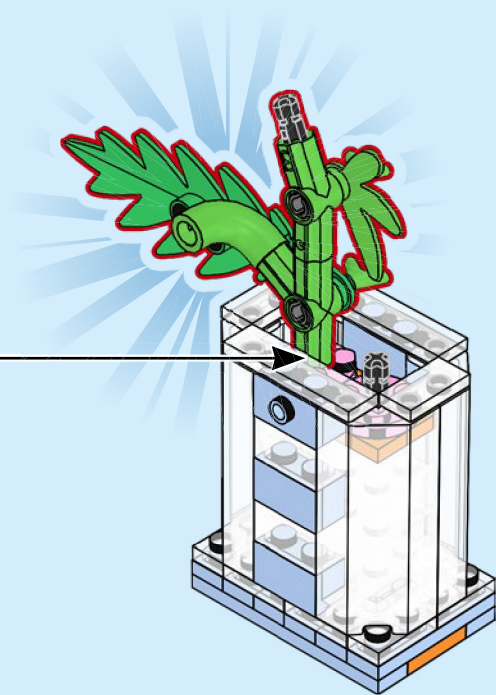

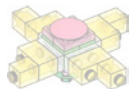

1x



1x

26

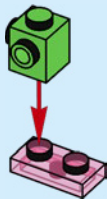

1x

27



2x

28

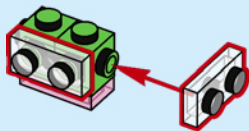

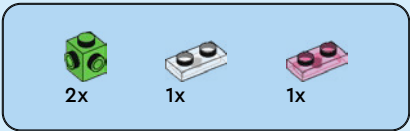

29

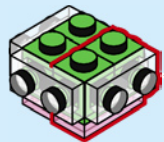
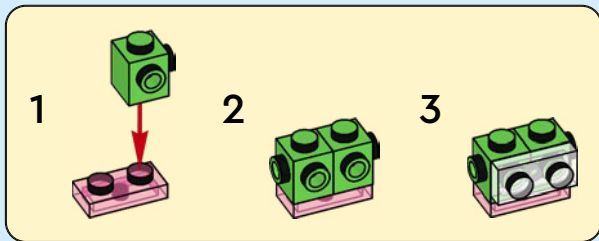



1x

30

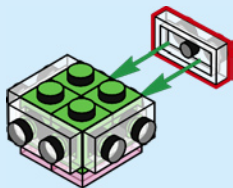

1x



1x

31

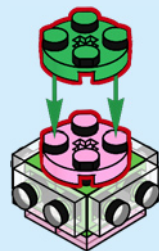



4x



4x

32

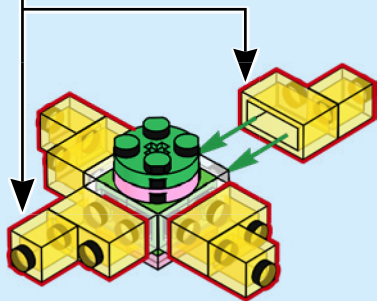
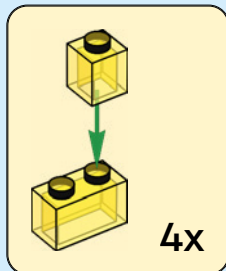

1x

33

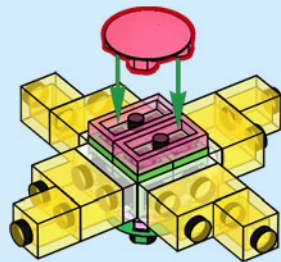

34

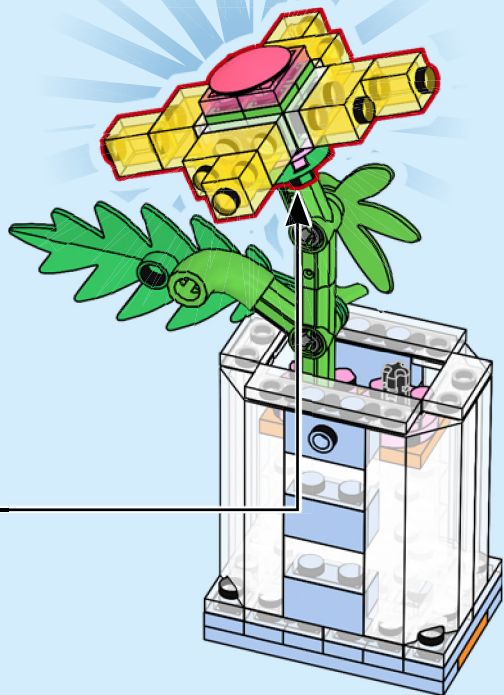



1x



1x

35

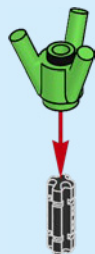

1x

36

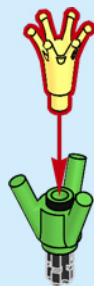



37

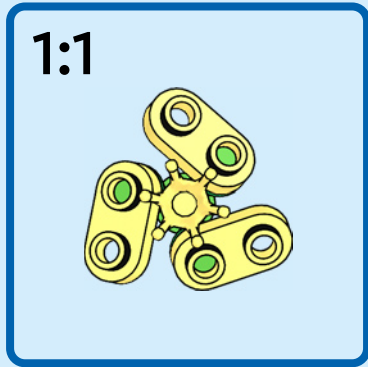
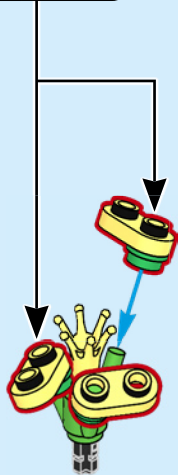
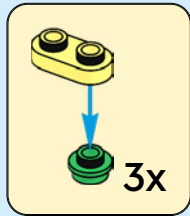



3x

38



3x

39

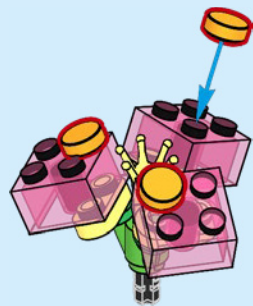

40

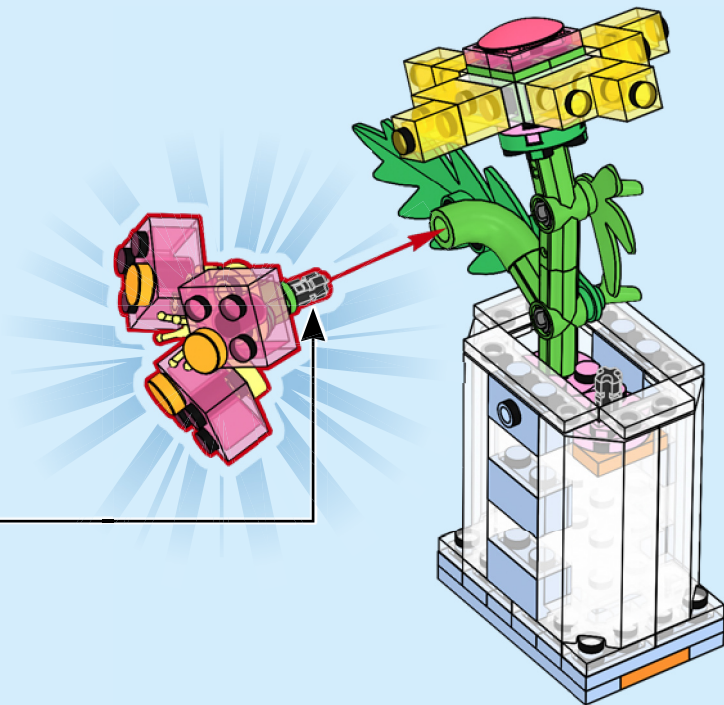

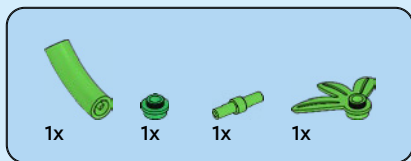

41

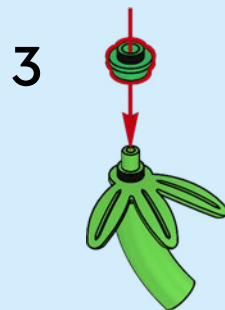
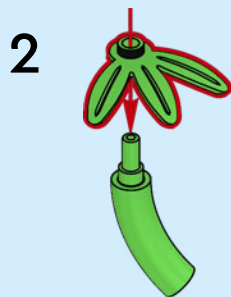
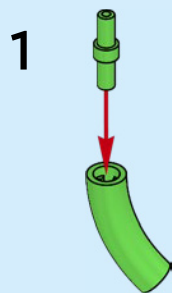

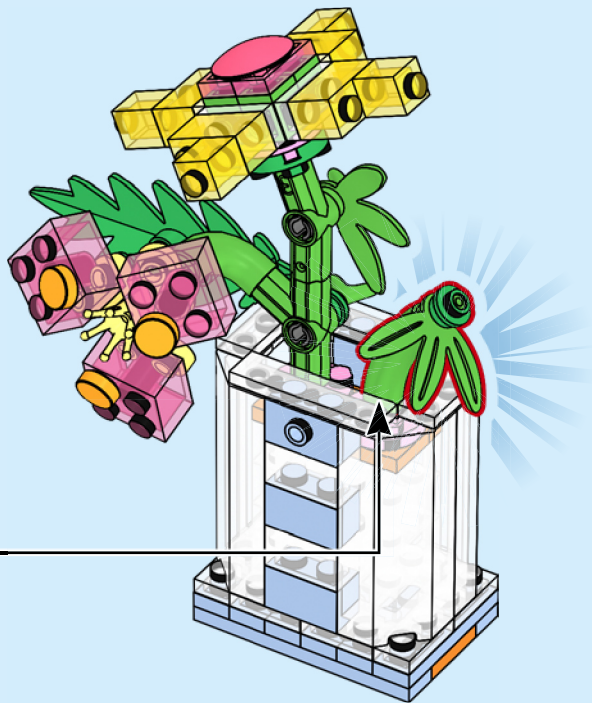



1x



1x

42



1x

43

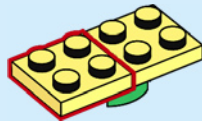



4x



2x

44

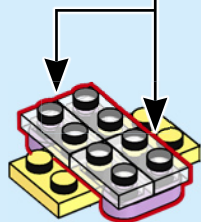
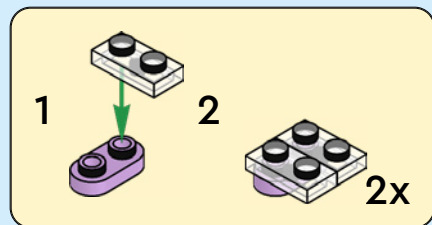

1x

45

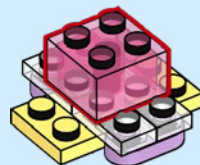



4x

46

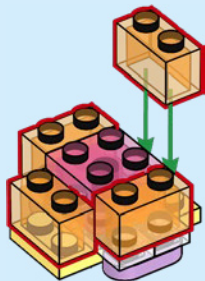

4x

47

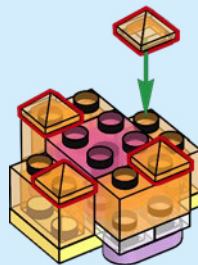



1x



1x

48

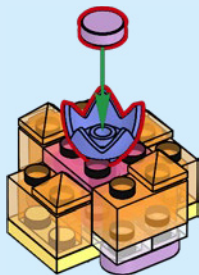

49

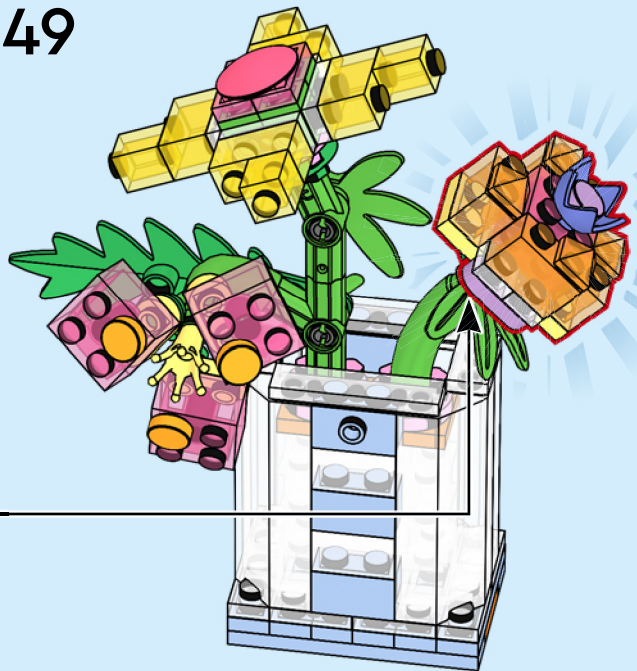



50

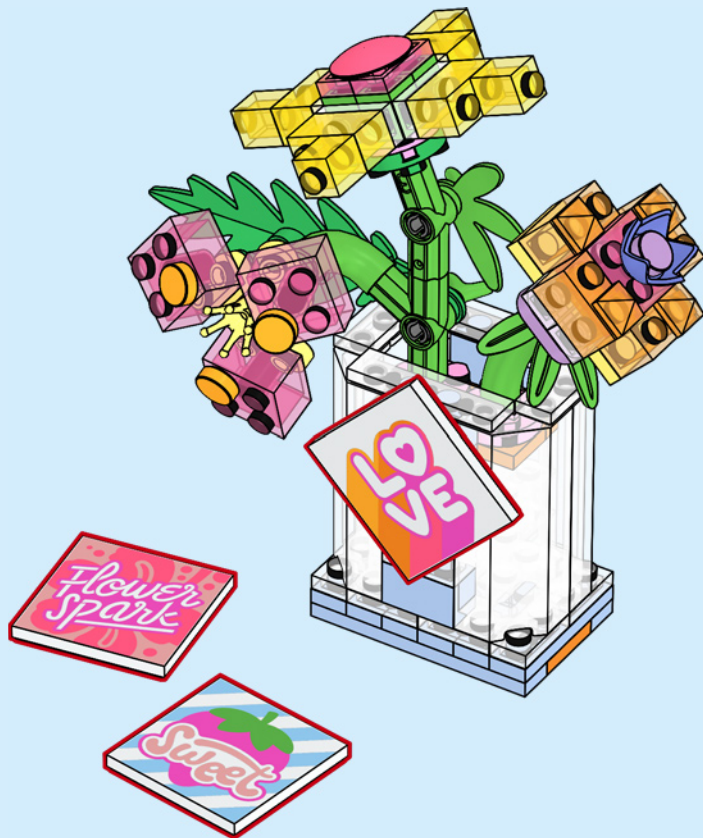

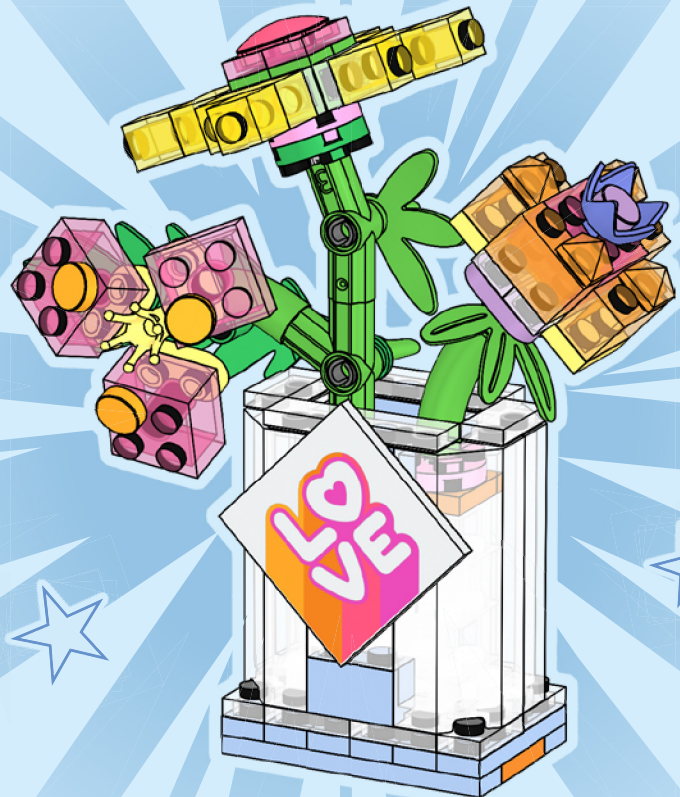



 [LEGO.com/service](https://www.LEGO.com/service)



**Rebuild
the
World™**



LEGO and the LEGO logo are trademarks of the/son des marques
de commerce du/son marcas registradas de LEGO Group.
©2026 The LEGO Group.



6650061