



# CREATOR™



31383



3in1	3en1	3 v 1	„3 b 1”
3-in-1	3em1	3 az 1-ben	3 űhes
3-en-1	3 合 1	3b1	„Trys viename”
3 in 1	3 w 1	3 in 1	3 ű 1 Arada



LEGO® Builder



[LEGO.com/sustainable-packaging](https://LEGO.com/sustainable-packaging)



 <sup>FR</sup> **DONNEZ**  
OU  
**RECYCLEZ**

 OU  OU 

ASSOCIATION    MAGASIN    DÉCHÈTERIE

Adresses sur [quefairedemesdechets.fr](https://quefairedemesdechets.fr)

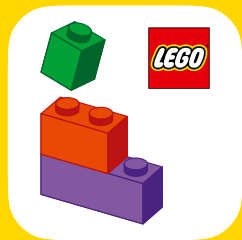

LEGO® Builder



# BUILDER



Apple and the Apple logo are trademarks of Apple Inc., registered in the U.S. and other countries and regions. App Store is a service mark of Apple Inc. Google Play and the Google Play logo are trademarks of Google LLC. Tencent and the Tencent logo are trademarks of Tencent Inc.

[LEGO.com/devicecheck](http://LEGO.com/devicecheck)

EN Ask parents' permission before going online | DE Eltern um Erlaubnis bitten, bevor du online gehst | FR Demande l'autorisation d'un parent avant d'aller en ligne | IT Chiedi il permesso ai tuoi genitori prima di andare online | ES Pídeles permiso a tus papás antes de conectarte a Internet | PT Pede autorização aos teus pais antes de ficares online | ZH 上网前应先征得父母的同意 | PL Poproś rodziców o zgodę, zanim wejdiesz do Internetu | CS Než půjdeš na internet, požádej rodiče o svolení | SK Skôr než pôjdeš na internet, vypýtaj si povolenie od rodičov | HU Kérj szülői engedélyt, mielőtt online csatlakoznál! | UA Запитуйте дозволу батьків, перш ніж користуватися інтернетом | RO Cere permisiunea părinților înainte de a te conecta online | BG Поискайте разрешение от родител, преди да влезете онлайн | LV Pirms došanās tiešsaistē palūdz atļauju vecākiem | ET Enne Interneti kasutamist küsi vanematelt luba | LT Prieš prisijungdami prie interneto, atsiklauskite tėvų | TR İnternete girmeden önce anne babandan izin iste



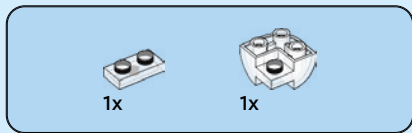

1

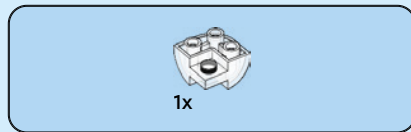
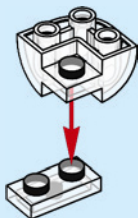

2

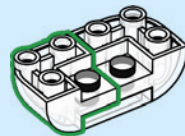



1x

3

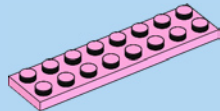
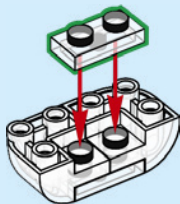

1x

4

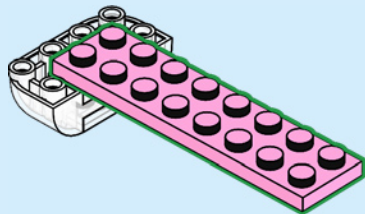



3x

5

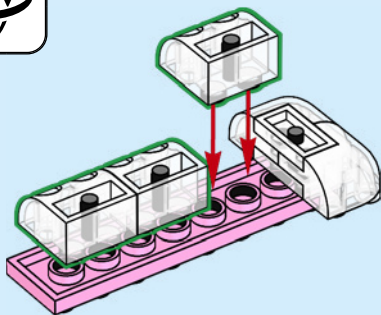

3x

6

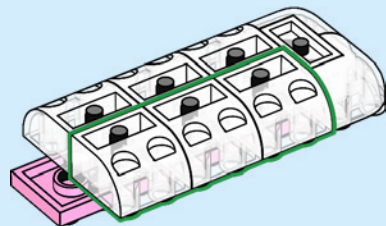



2x



2x

7

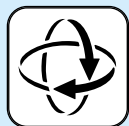

1

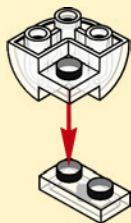

2

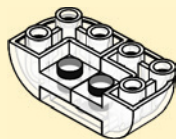

3

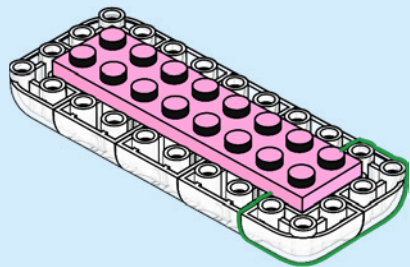
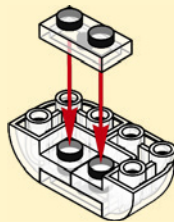



10x

8

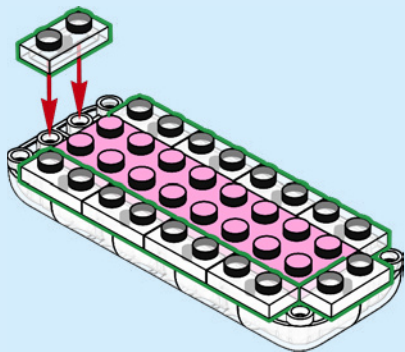

4x

9

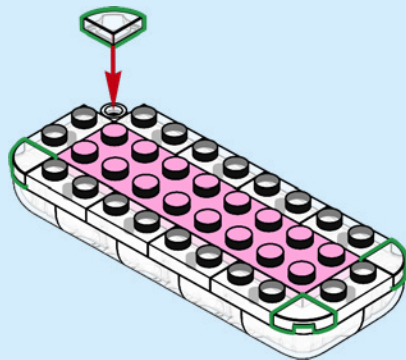



4x

10

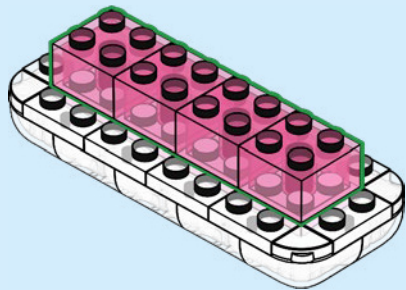

1x



2x

11

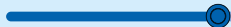
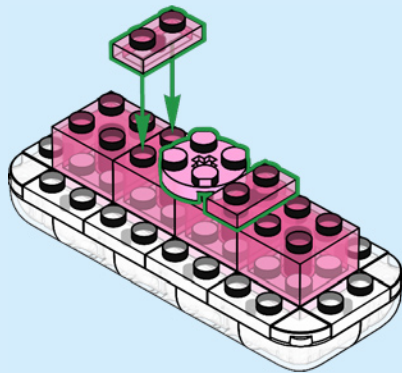

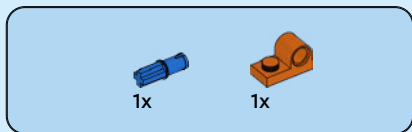

12

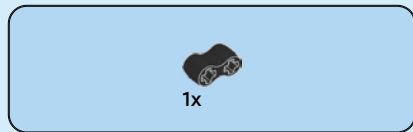
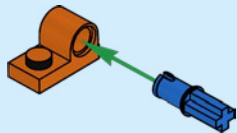

13

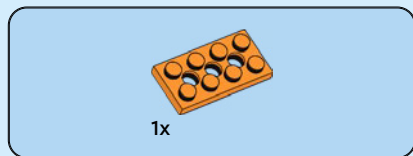

14

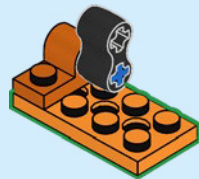



1x

15

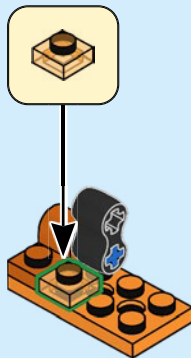

1x

16

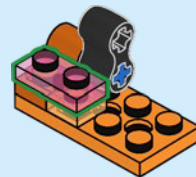



1x



2x

17

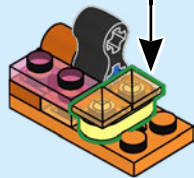
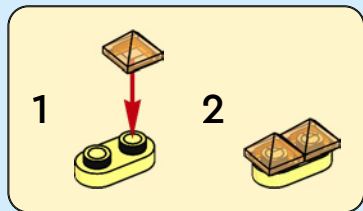

2x



1x



2x

18

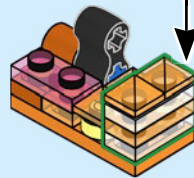
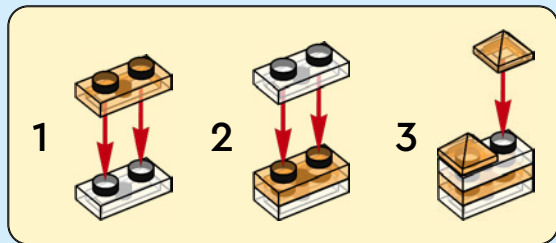

19

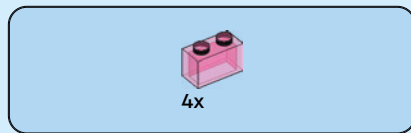
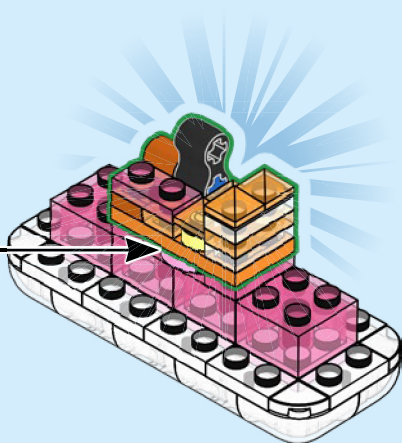

20

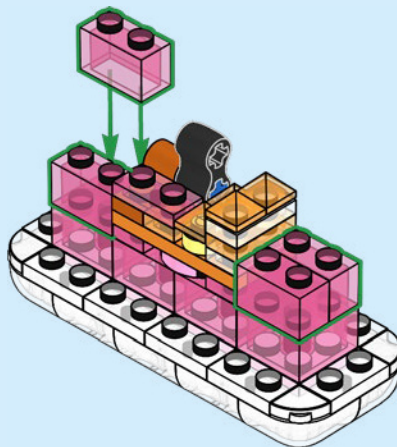



2x



4x

# 21

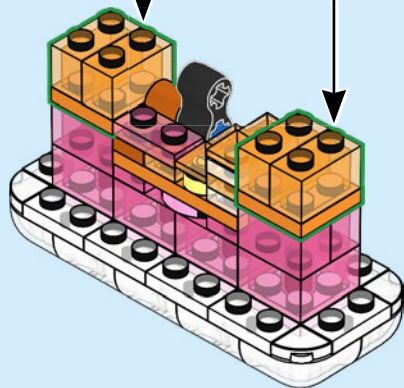
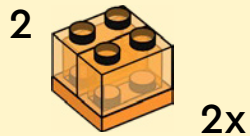
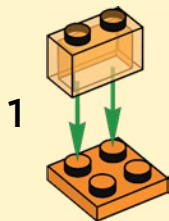



2x



2x 2x 4x 4x 2x

22

1

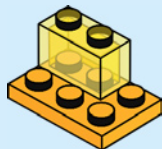

2

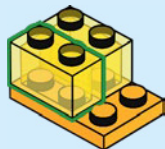

3

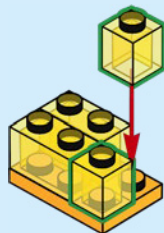

4

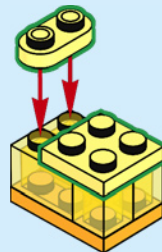

2x

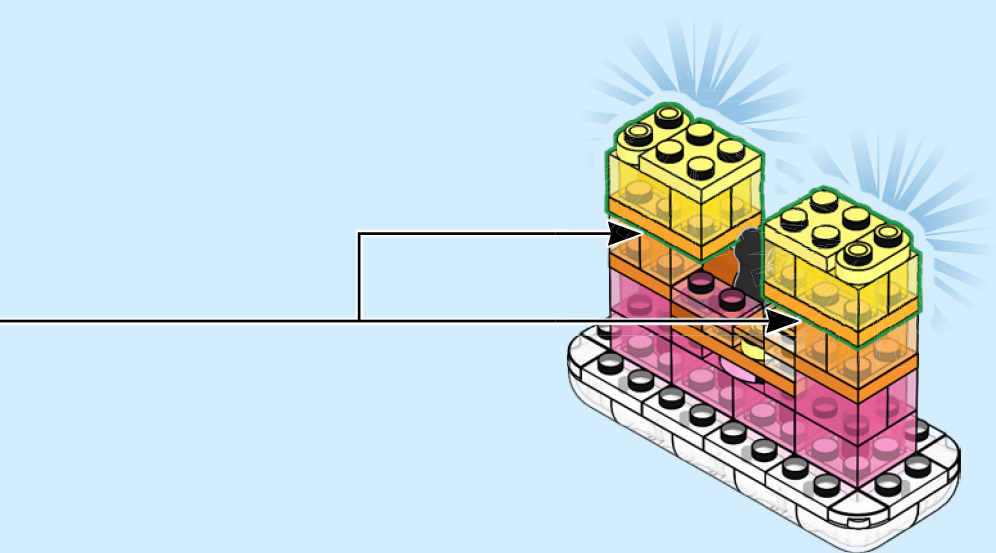

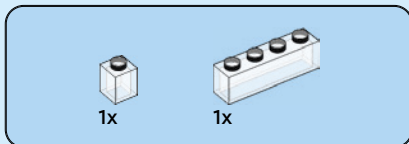
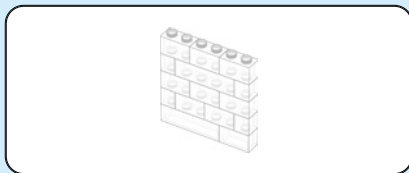

23

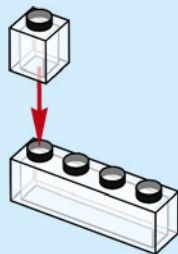



2x

24

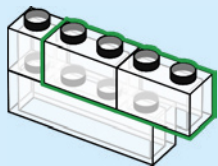

1x

25

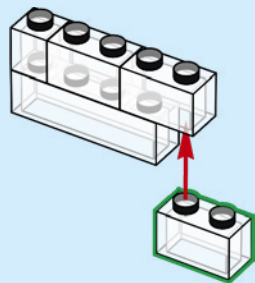



1x

26

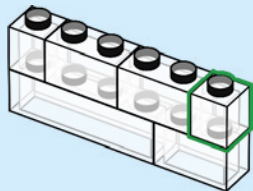

3x

27

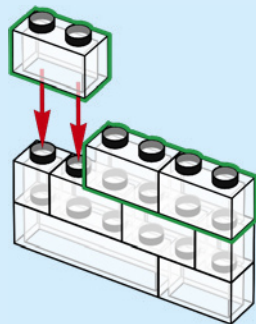



2x



1x

# 28

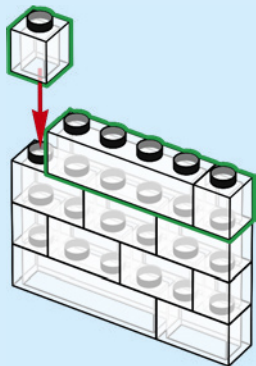

3x

# 29

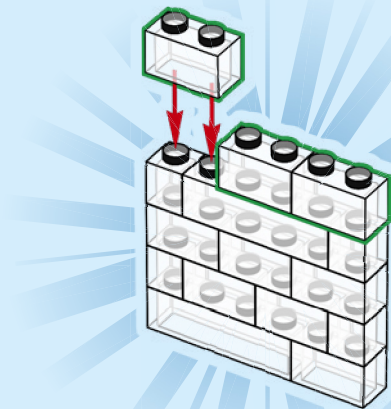

30

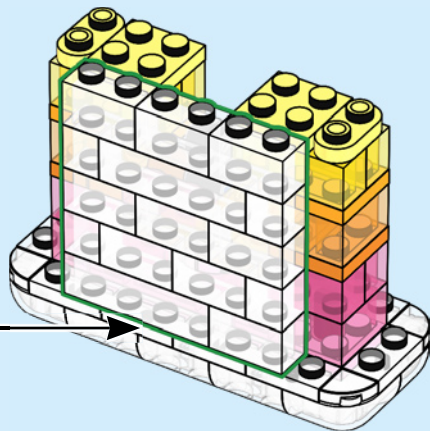

31

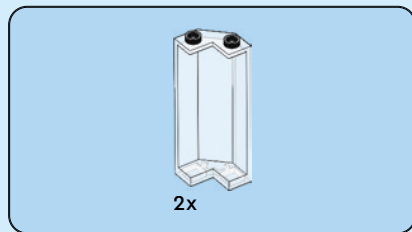
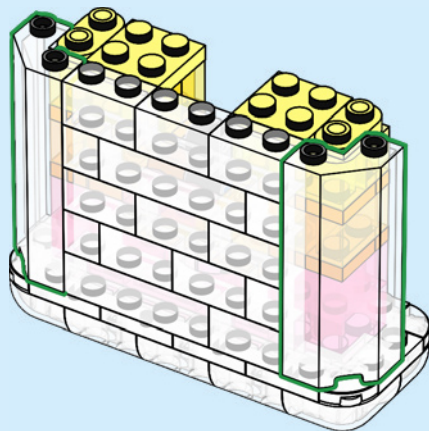

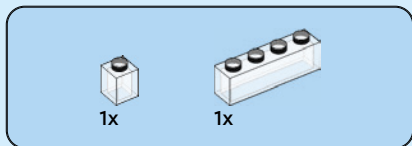
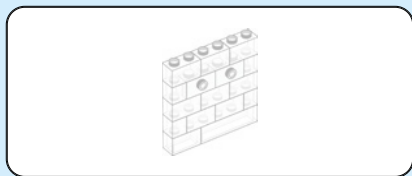

32

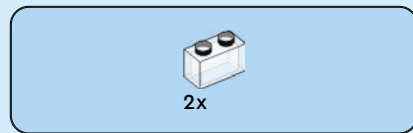
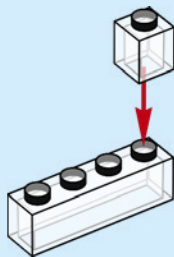

33

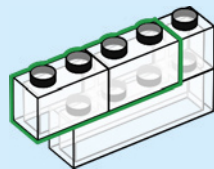



1x

34

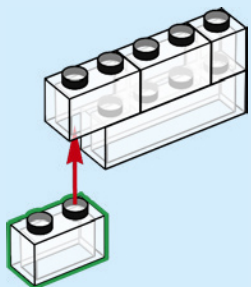

1x

35

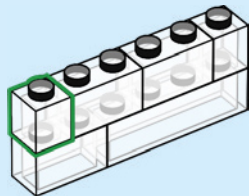



3x

36

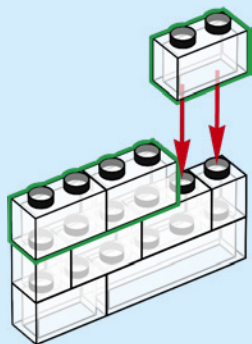

2x



2x

37

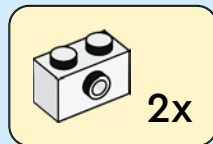

2x

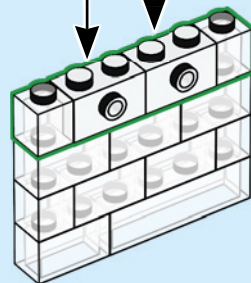



3x

38

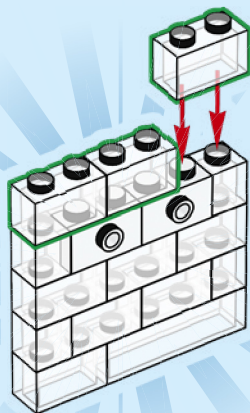

39

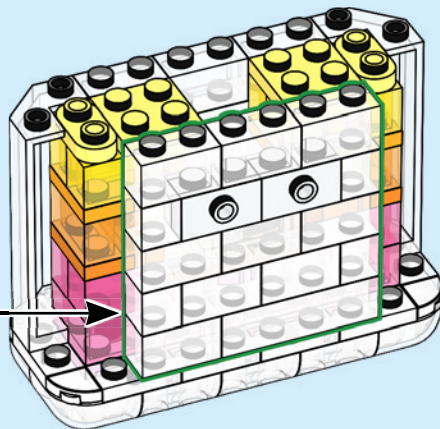

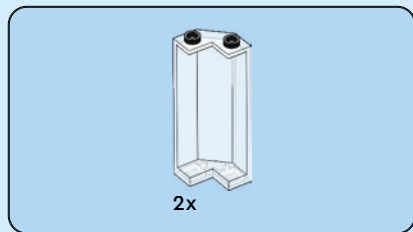

40

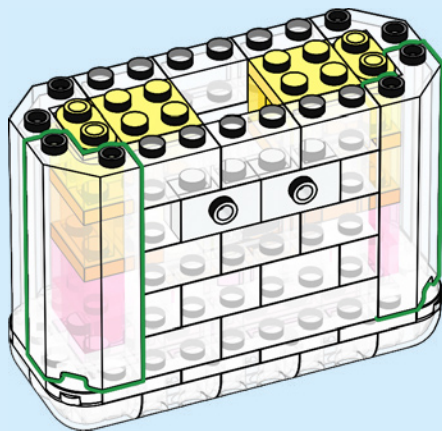



4x

41

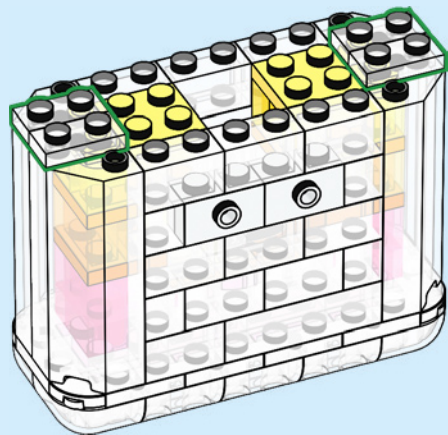

8x

42

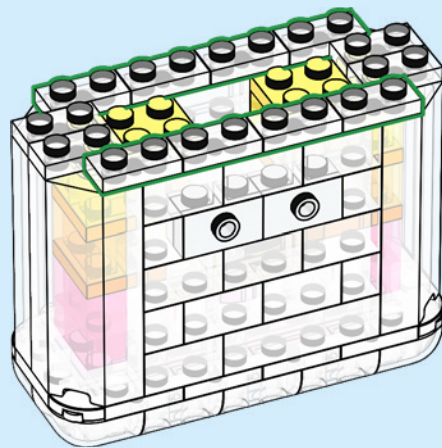

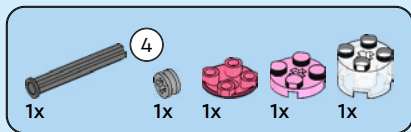

43

1



2

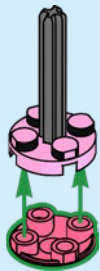

3

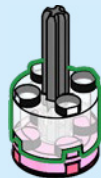

4

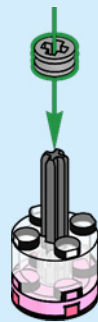

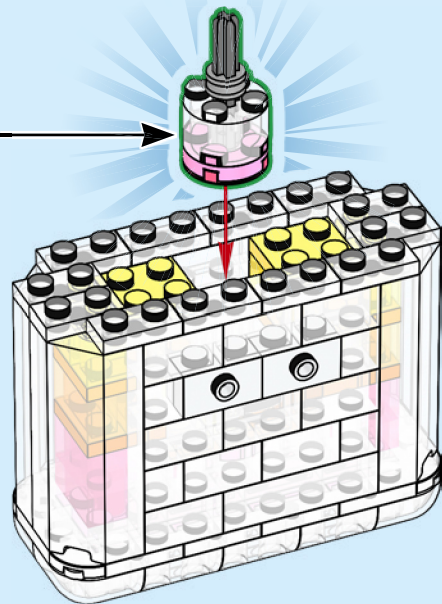



2x



2x

44

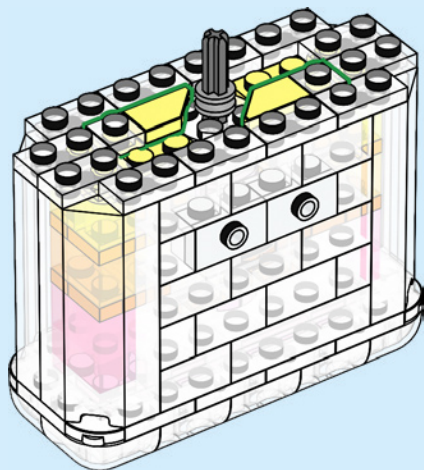

1x

45

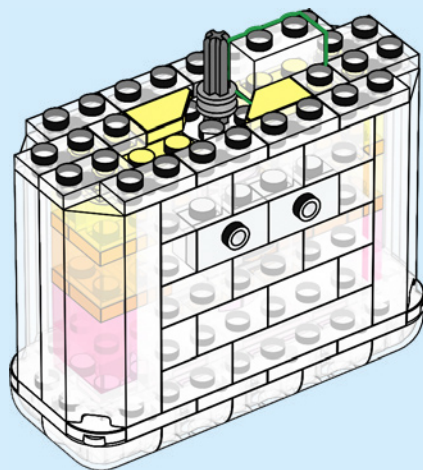



2x

46

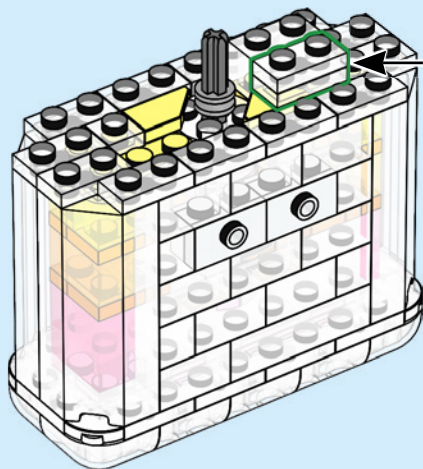
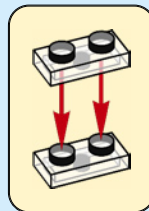



1x

47

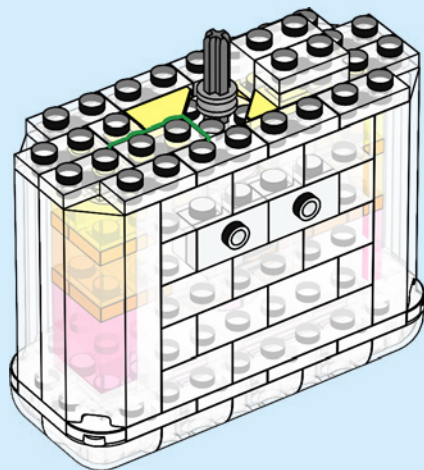

1x

48

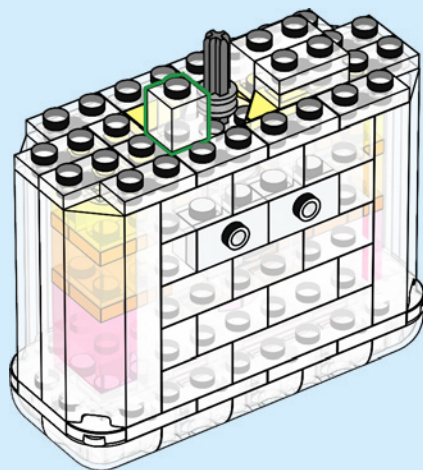



2x



2x

# 49

1

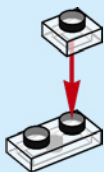

2



3

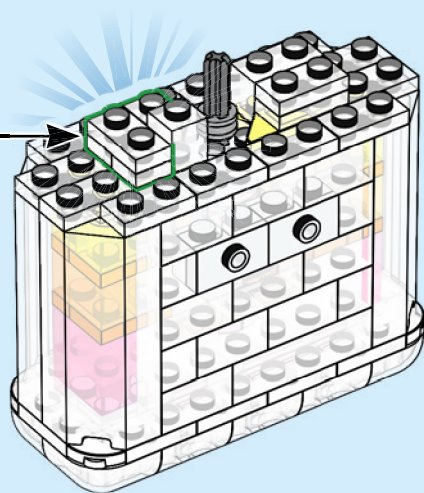
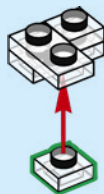



2x

50

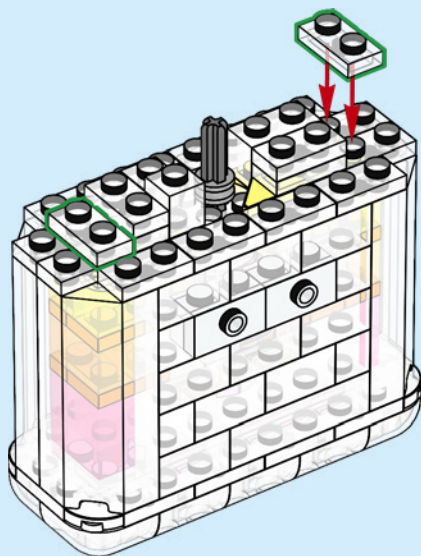



2x



2x

# 51

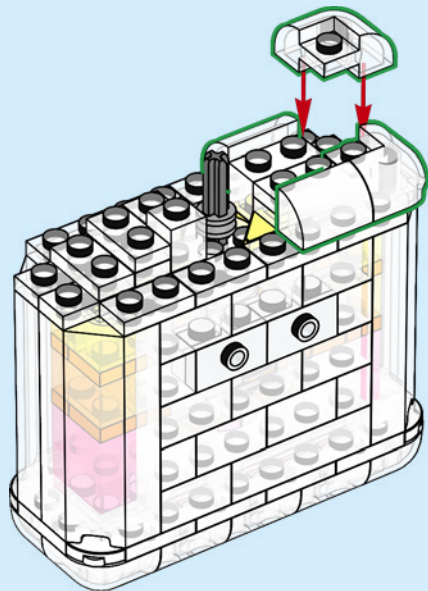



4x



2x

# 52

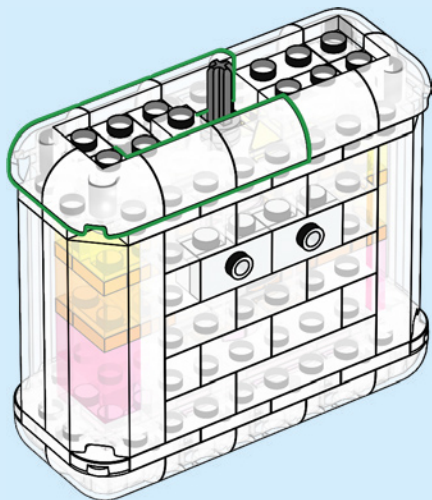

5x



1x

# 53

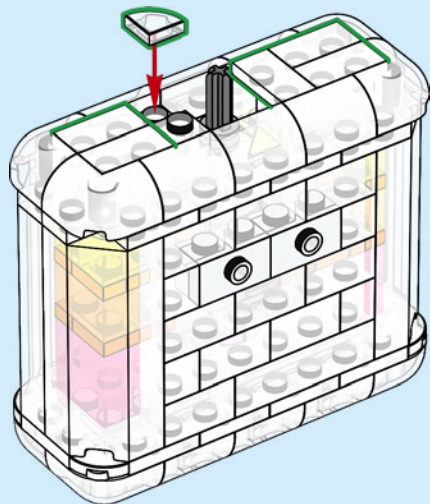



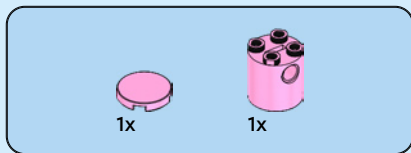

54

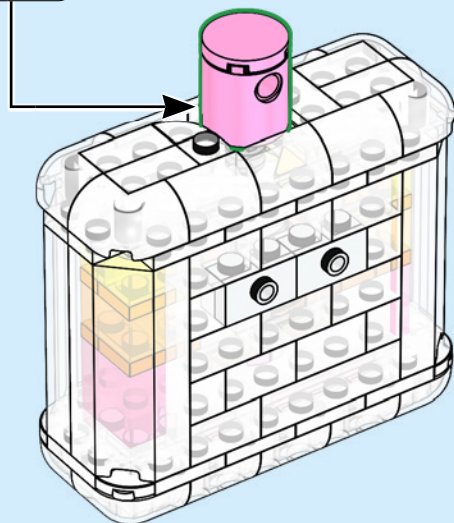
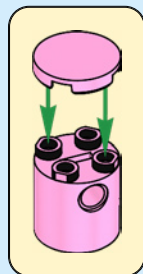

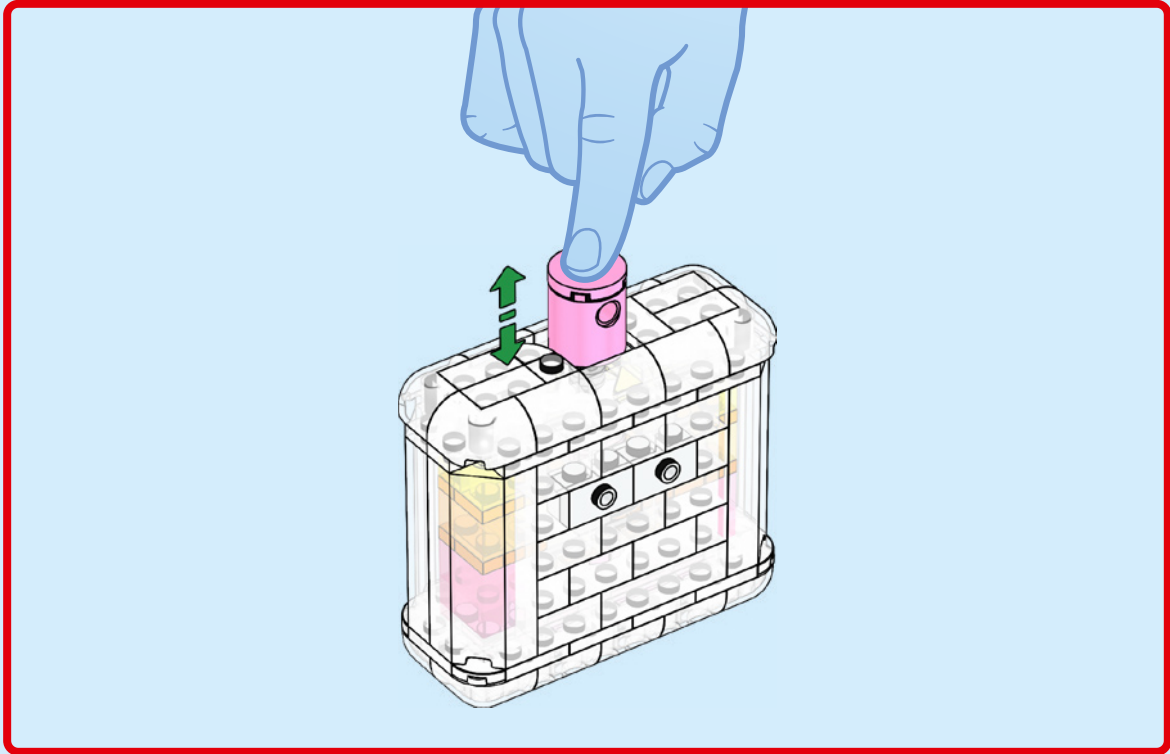

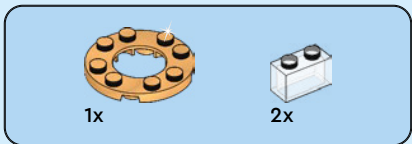

55

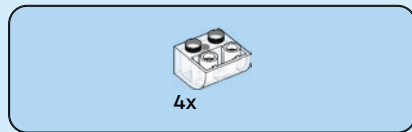
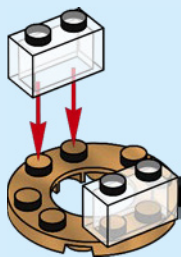

56

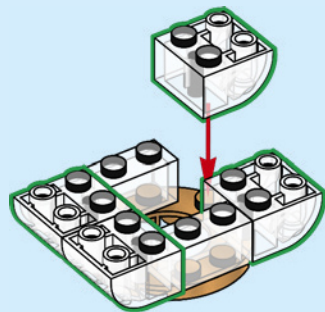



2x

57

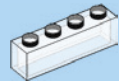
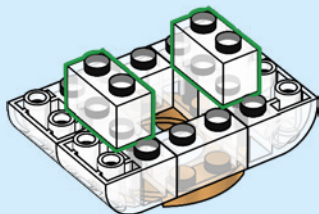

2x

58

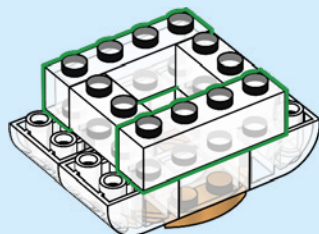

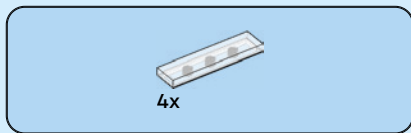

59

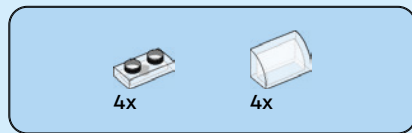
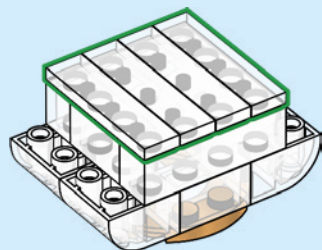

60

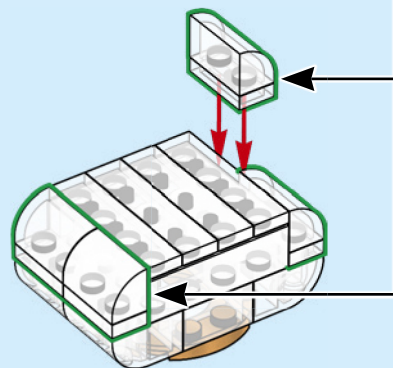
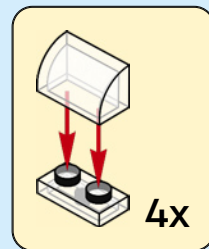

61

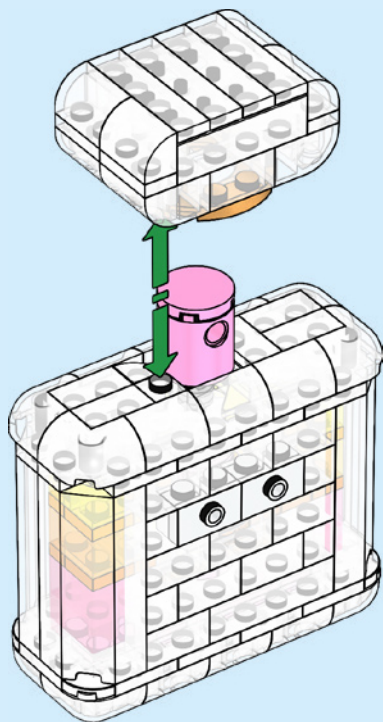
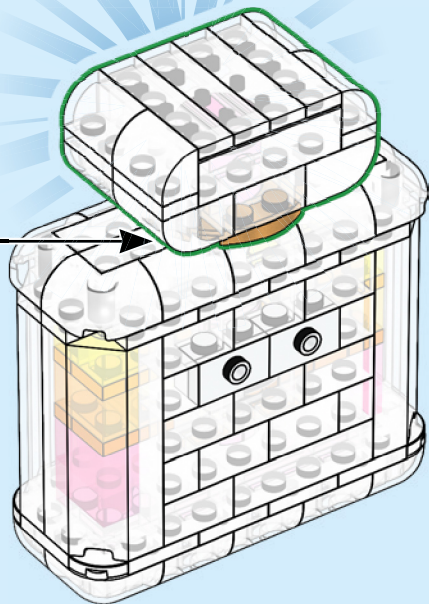



62





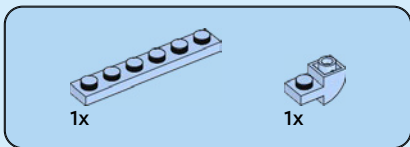
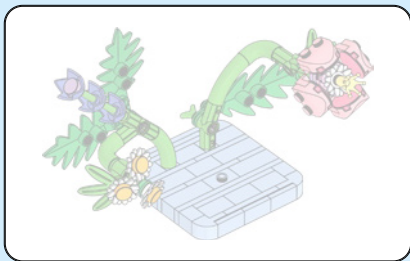

1

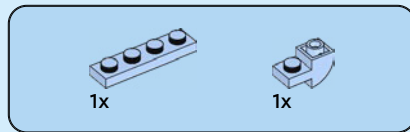
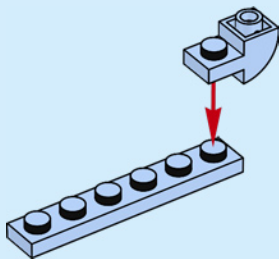

2

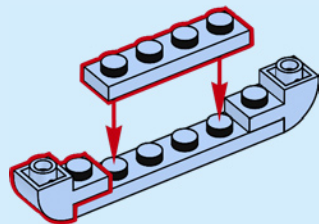

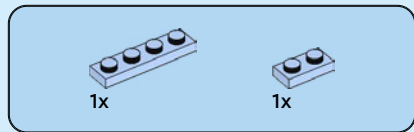

3

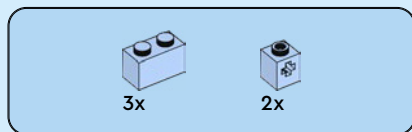
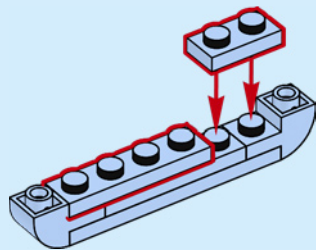

4

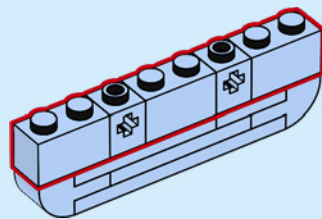

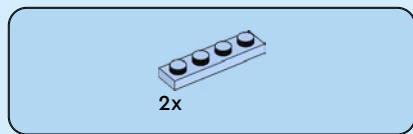

5

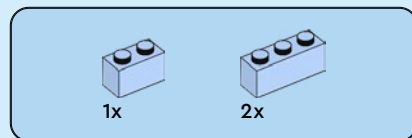
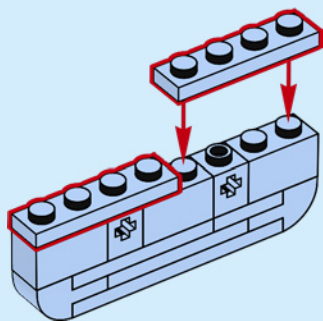

6

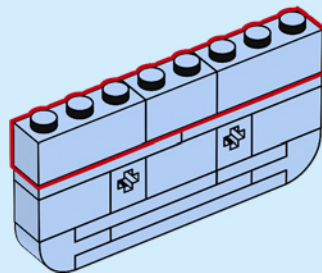

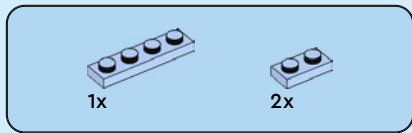

7

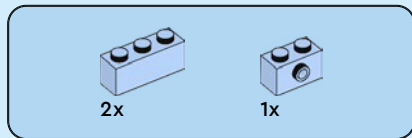
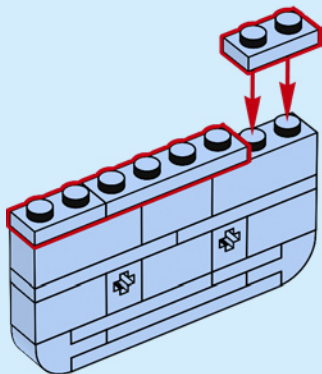

8

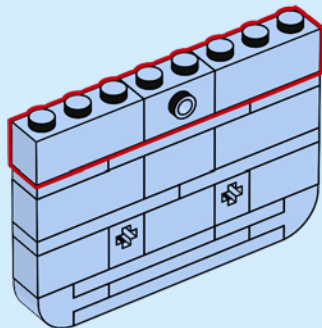

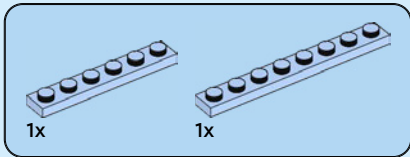
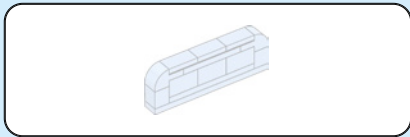

9

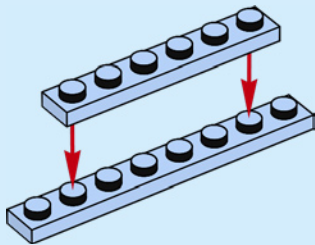

10

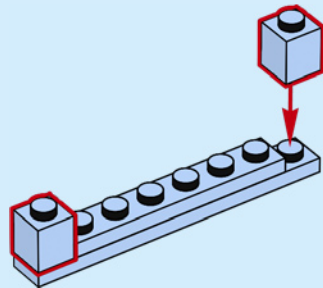



3x

11

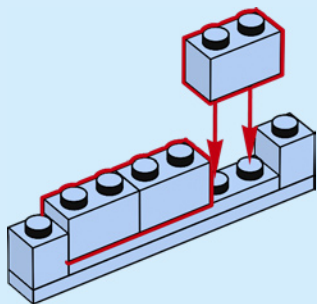

2x

12

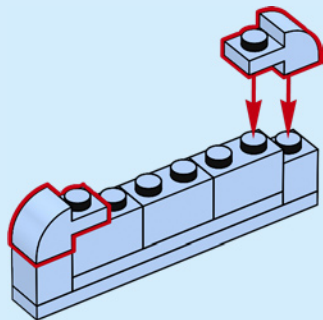

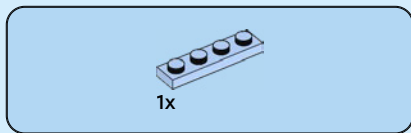

13

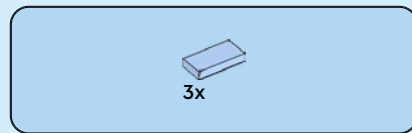
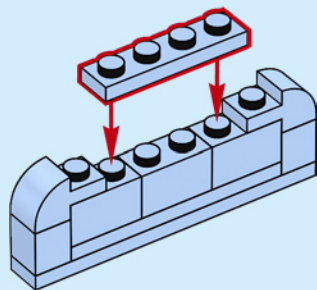

14

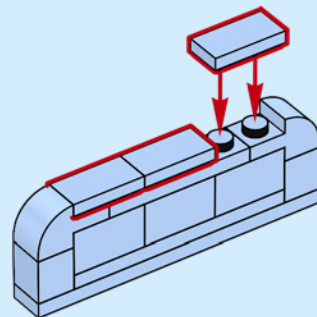

15

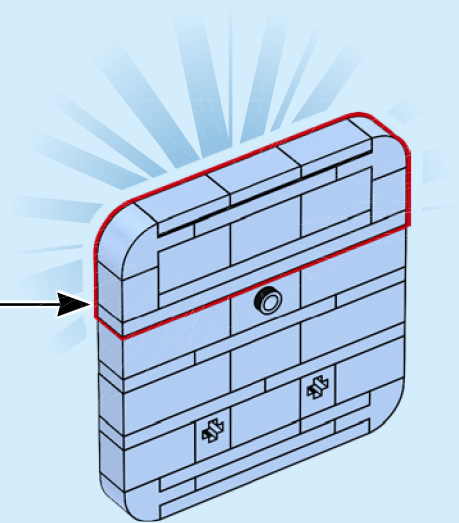

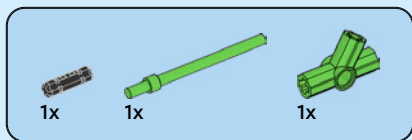

16

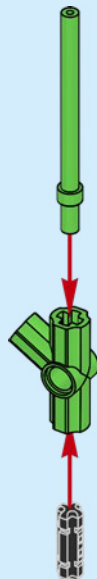

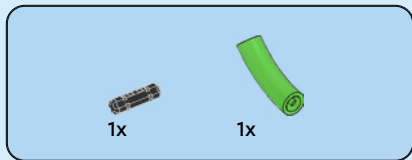

17

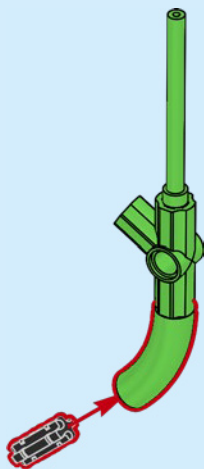

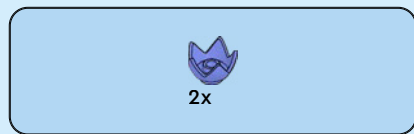

18

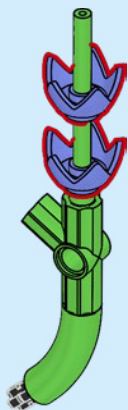

19

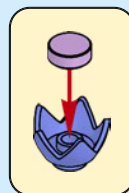

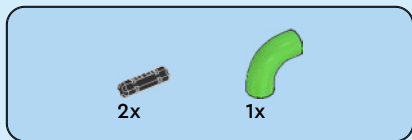

20

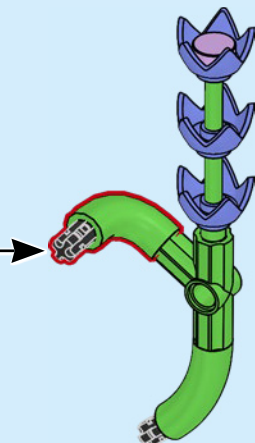
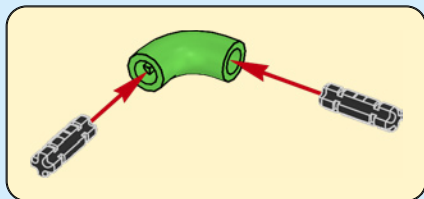



1x

21

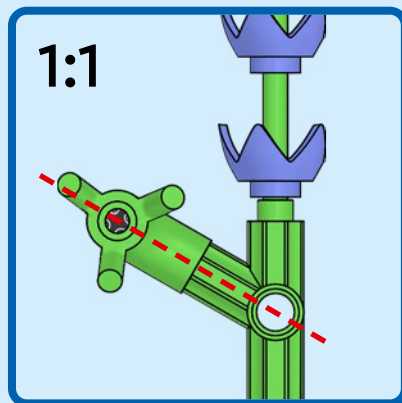
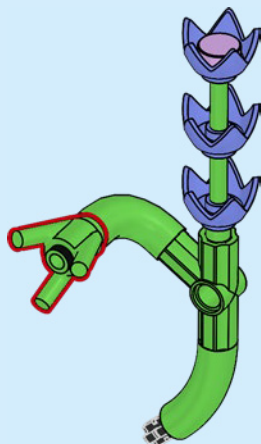

22

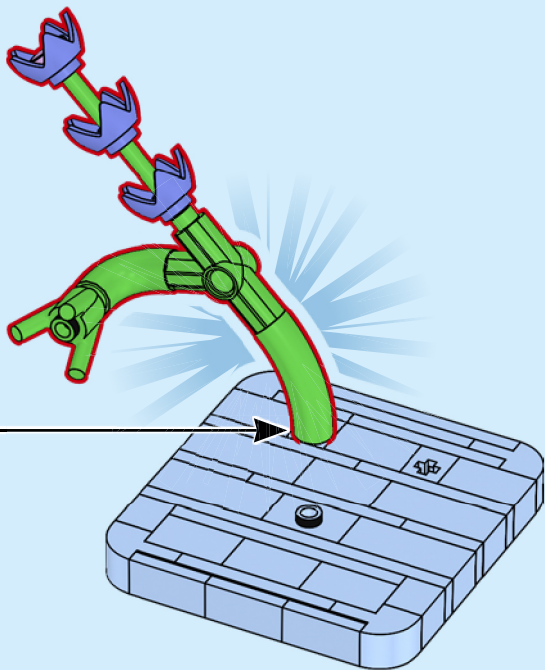
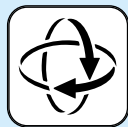



2x



1x

# 23

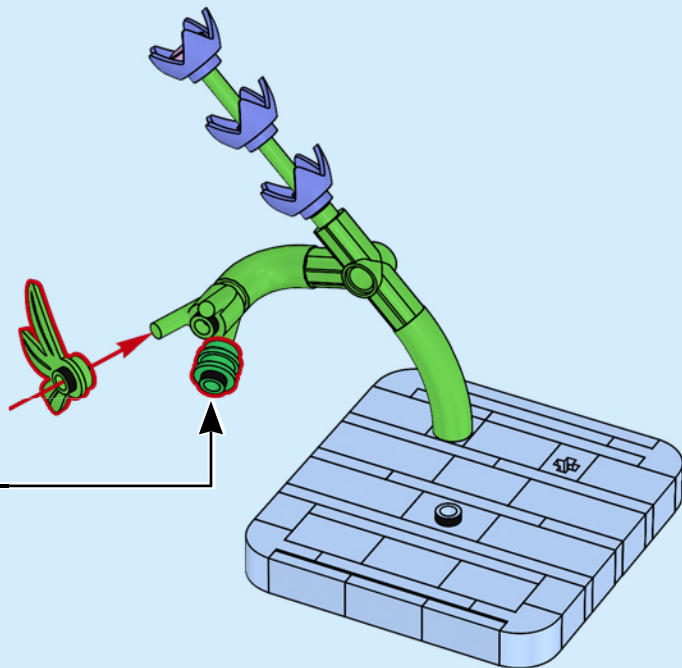
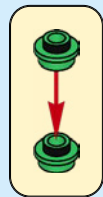



3x



3x

# 24

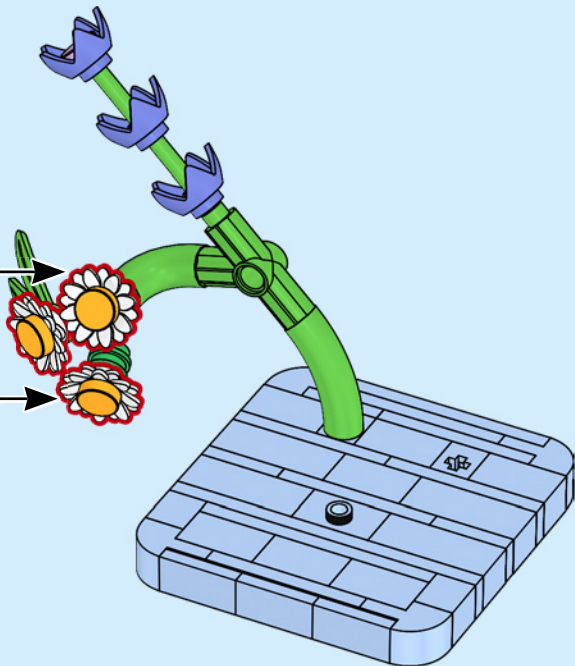
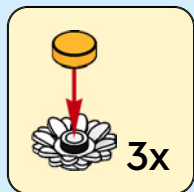



1x

25

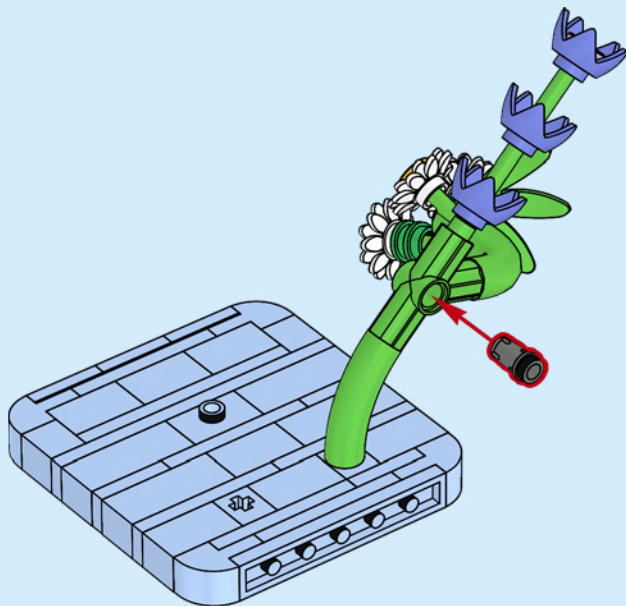
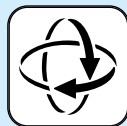

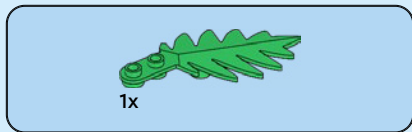

26

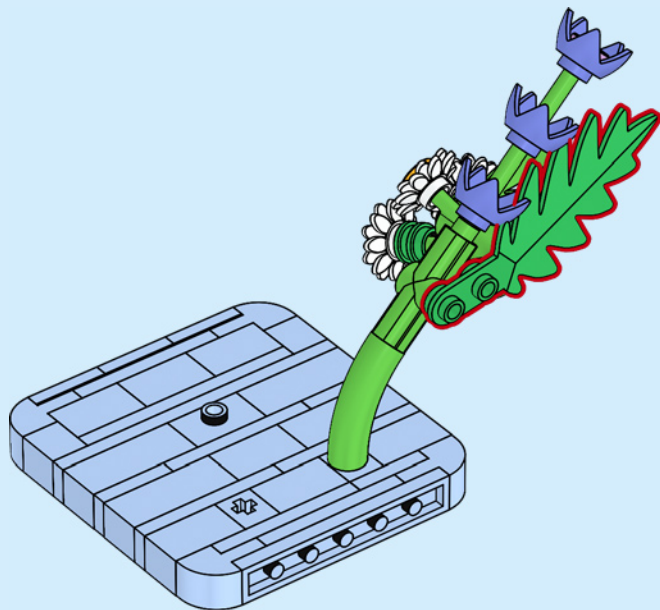

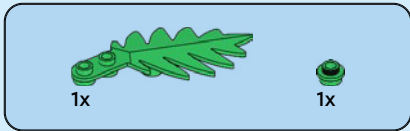

27

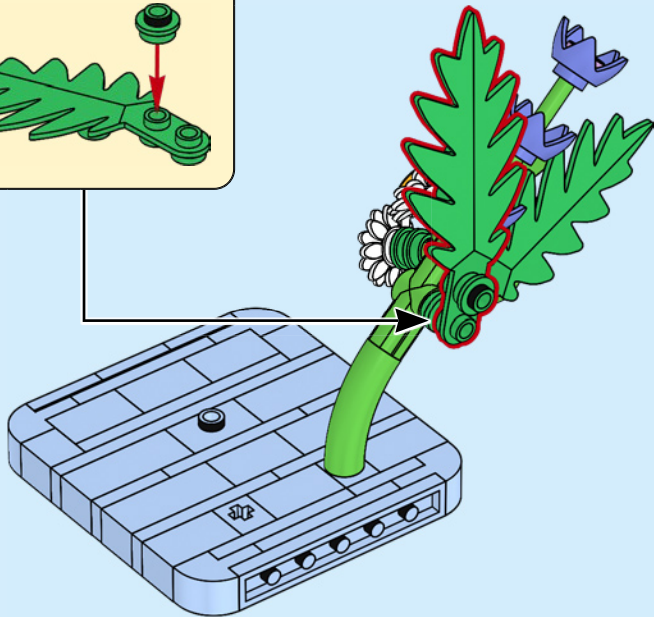
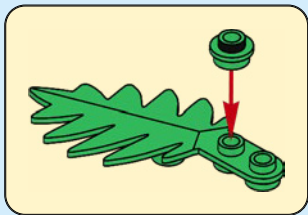



1x

28

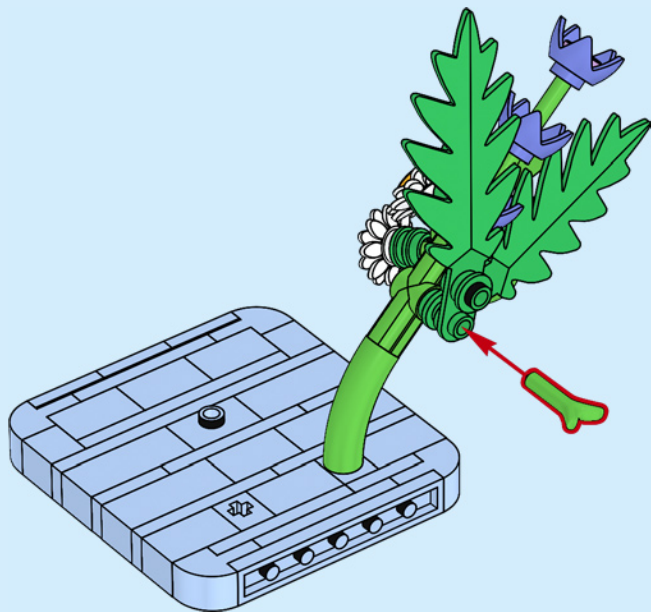

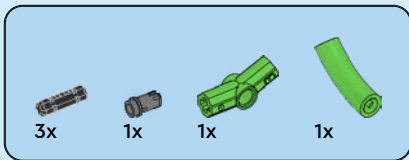

29

1

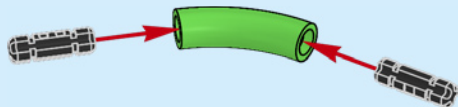

2

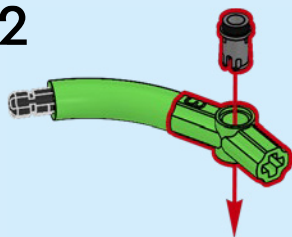

3

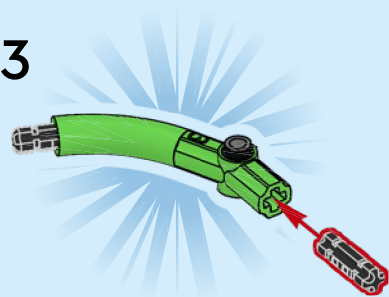

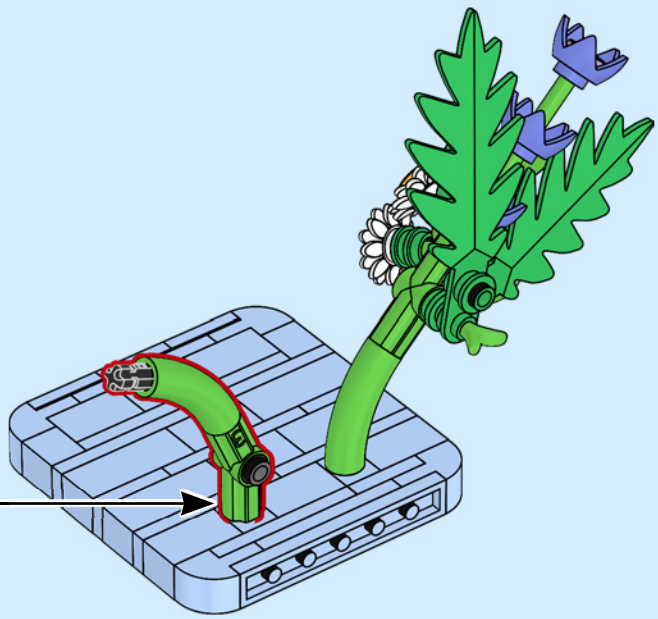

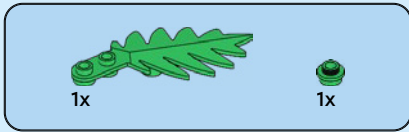

30

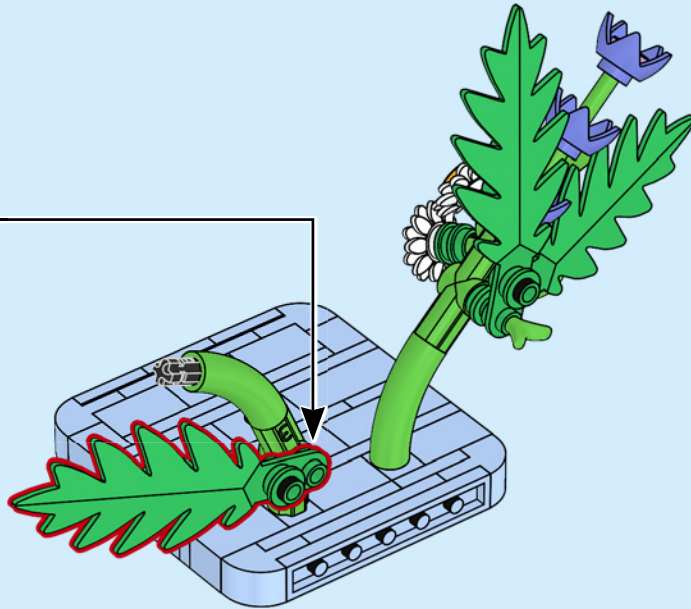
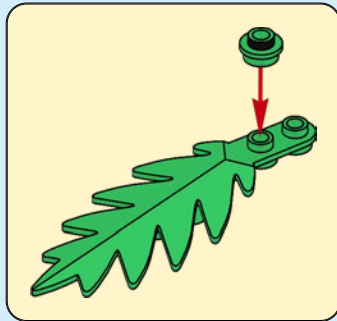



1x

31

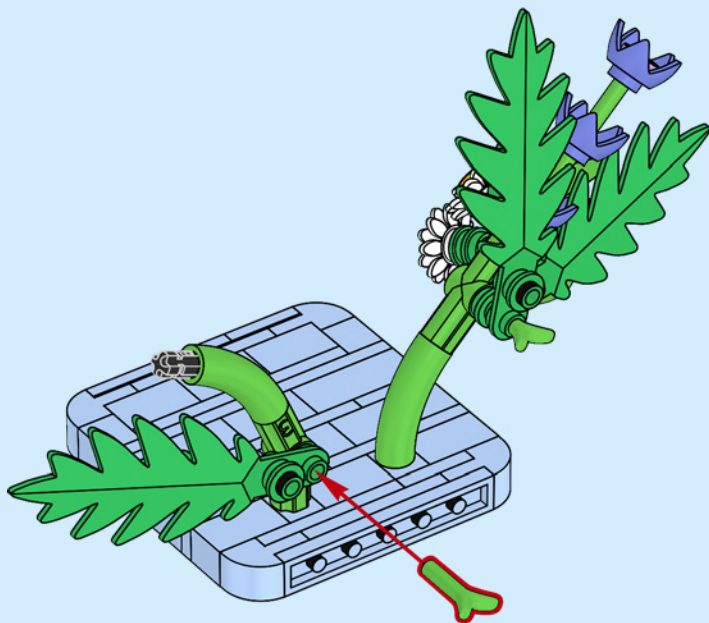

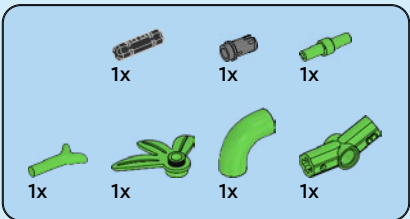

# 32

1

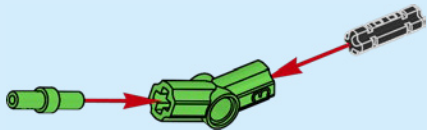

2

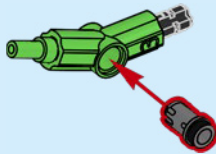

3

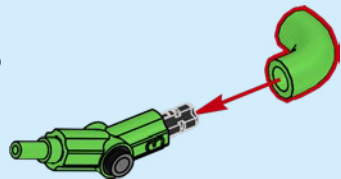

4

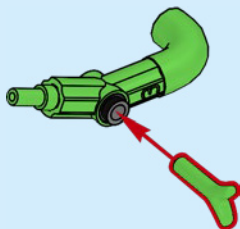

5

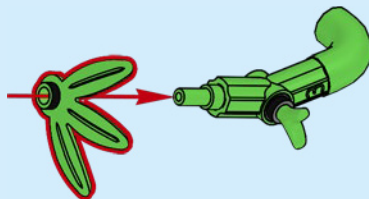

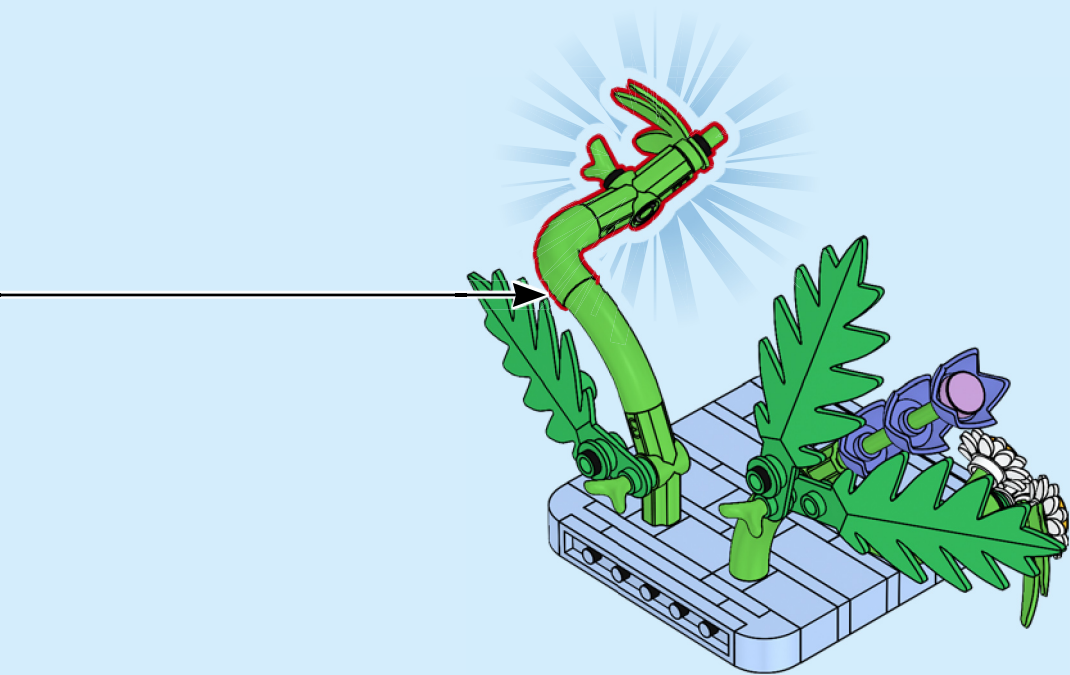



2x

33

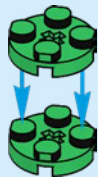

4x

34

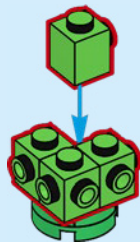



2x

35

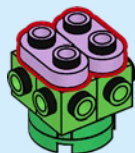

1x

36

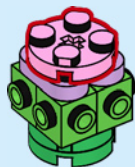

1x



1x

37



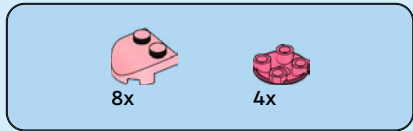

38

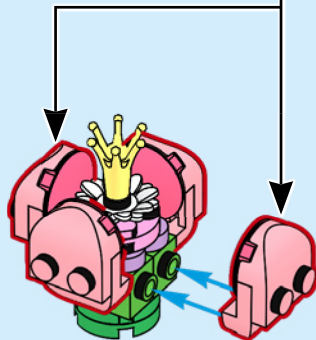
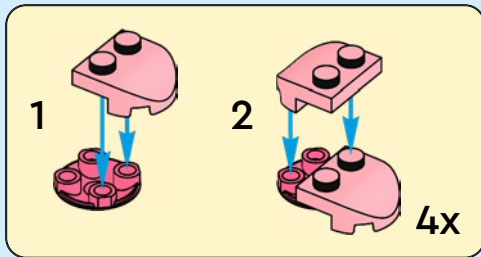

39

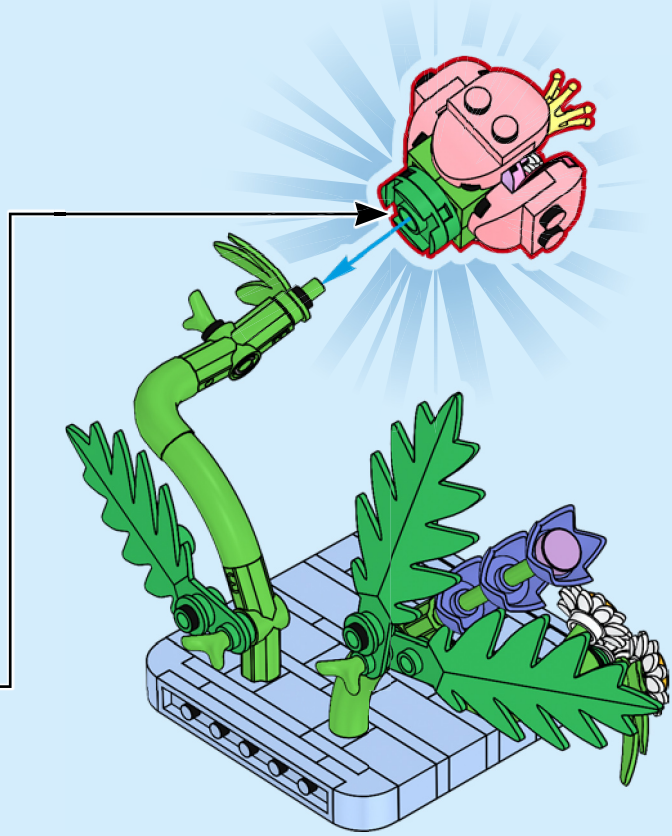





# CREATOR™

# 3 IN 1

31385



31389



31386



31392



YOU COULD **WIN**

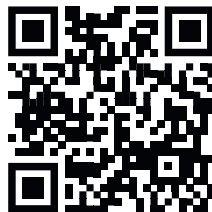

Scan this QR code or go to **LEGO.COM/PRODUCTFEEDBACK** and give us your short feedback about this LEGO® set for a chance to win a cool LEGO prize.

Terms and Conditions apply\*



**EN: YOU COULD WIN.** Terms and Conditions apply\* **DE: Du könntest GEWINNEN.** Es gelten die Teilnahmebedingungen\* **FR: TU POURRAIS GAGNER.** Des conditions s'appliquent\* **IT: Potresti VINCERE tu.** Termini e condizioni sono applicabili\* **ES: PUEDES GANAR.** Aplican términos y condiciones\* **PT: PODERÁ GANHAR.** Aplicam-se Termos e Condições\* **ZH: 轻松获奖.** 条款和条件适用\* **PL: Szansa na WYGRANĄ.** Obowiązuje regulamin\* **CS: Máte šanci VYHRÁT.** Platí všeobecné smluvní podmínky\* **SK: Máte šancu VYHRAŤ.** Platia všeobecné zmluvné podmienky\* **HU: TE IS NYERHETSZ!** Felhasználási feltételek érvényesek\* **UA: ВИ МОЖЕТЕ ВИГРАТИ.** Застосовуються загальні положення та умови\* **RO: Ai putea CÂȘTIGA.** Se aplică termenii și condiții\* **BG: Можете да СПЕЧЕЛИТЕ.** Има определени правила и условия\* **LV: Tu vari LAIMĒT.** Ir spēkā noteikumi un nosacījumi.\* **ET: Sul on võimalus VÕITA.** Kehtivad tingimused\* **LT: Jūs galite LAIMĖTI.** Taikomos sąlygos\* **TR: KAZANABİLİRSİN.** Şartlar ve Koşullar geçerlidir\*

\*[LEGO.com/productfeedback-terms](https://www.lego.com/productfeedback-terms)

LEGO and the LEGO logo are trademarks of the LEGO Group.  
©2026 The LEGO Group.



6650035