

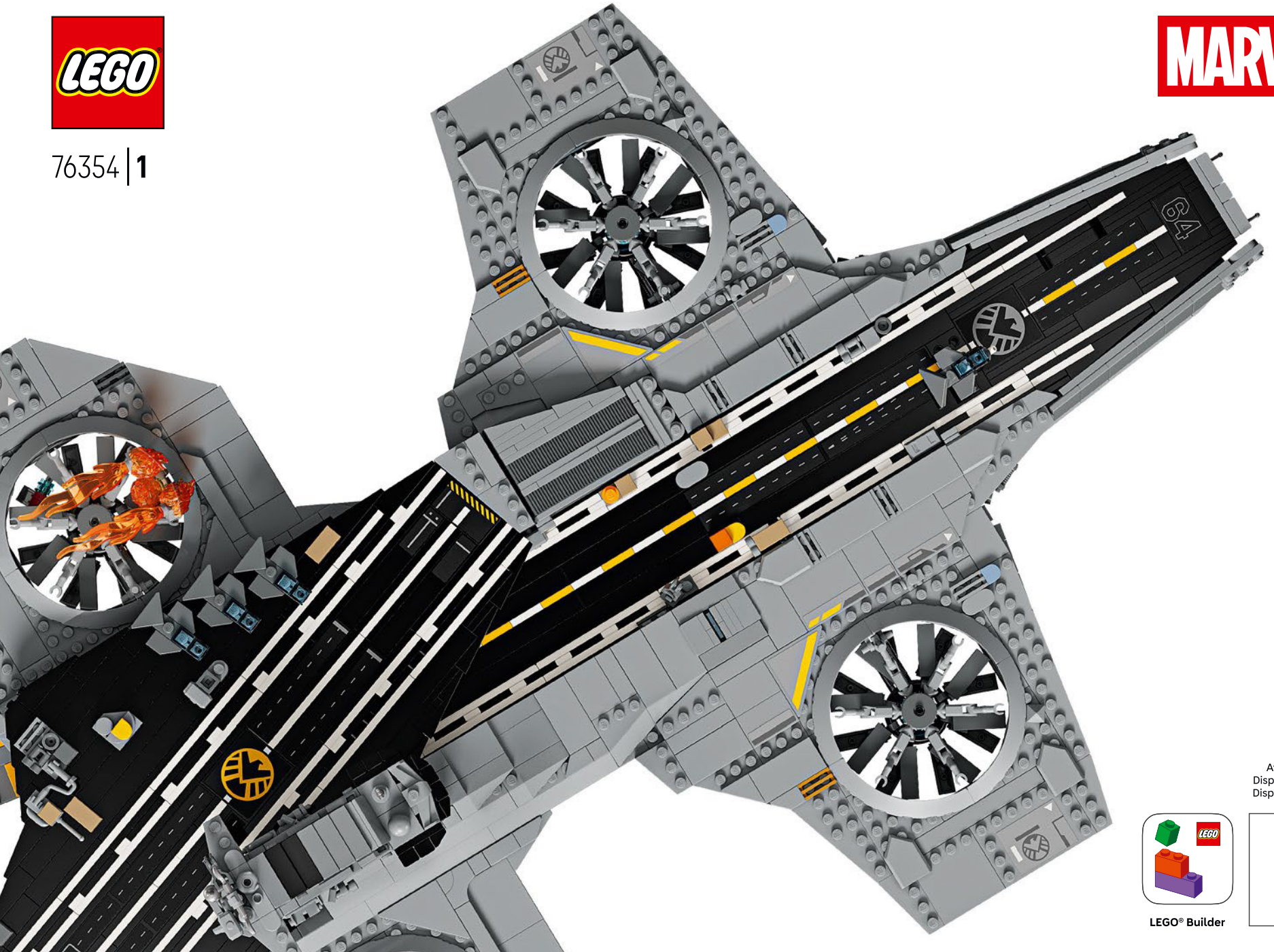

76354 | 1

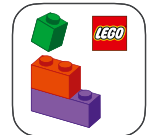

Available in English
Disponible en français
Disponible en español



LEGO® Builder

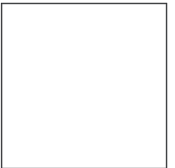



WE'RE MAKING OUR PACKAGING MORE SUSTAINABLE

We're transitioning from single-use plastic to paper-based packaging. As we progress, you may find a mix of paper and plastic in our boxes.

NOUS RENDONS NOS EMBALLAGES PLUS DURABLES

Nous passons des emballages en plastique à usage unique aux emballages à base de papier. Durant la transition, vous pourriez trouver un mélange de papier et de plastique dans nos boîtes.

QUEREMOS HACER MÁS SUSTENTABLES NUESTROS MATERIALES DE EMBALAJE

Estamos cambiando las bolsas de plástico desechables por bolsas con base de papel. Conforme avanzamos en este propósito, puedes encontrar una mezcla de papel y de plástico en nuestras cajas.

LEGO.com/sustainable-packaging



BUILDER



Apple and the Apple logo are trademarks of Apple Inc., registered in the U.S. and other countries and regions. App Store is a service mark of Apple Inc. Google Play and the Google Play logo are trademarks of Google LLC. Tencent and the Tencent logo are trademarks of Tencent Inc.

LEGO.com/devicecheck

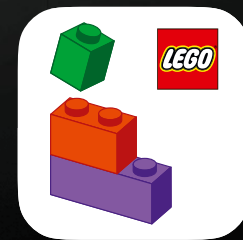

LEGO® Builder



Not a submarine

Commissioned by the UN and led by Nick Fury, the Helicarrier is S.H.I.E.L.D.'s mobile base in the Marvel Cinematic Universe. Equally at home in the air or at sea, it runs on advanced engines, turbines and, later, repulsors. Doubling as an airfield for various aircraft, including Quinjets, it's ideal for reconnaissance, stealth and battle. It hosts key moments in the saga, both funny and solemn. In Marvel Studios' The Avengers (2012), it's an assembly place for the Avengers; Loki is held in a containment cell, the Hulk (inevitably) wreaks havoc and Nick Fury witnesses the heart-wrenching demise of Phil Coulson. In Avengers: Age of Ultron, without on-deck amenities, when Fury makes a grand entrance in the "pulled her out of mothballs" Helicarrier to aid the Avengers in Sokovia.

Pas un sous-marin

Commandé par l'ONU et dirigé par Nick Fury, l'hélicoptère est la base mobile du S.H.I.E.L.D. dans l'univers cinématographique Marvel. Aussi à l'aise dans les airs qu'en mer, il fonctionne à l'aide de moteurs, de turbines et, plus tard, de répulseurs perfectionnés. Servant également d'aérodrome pour divers aéronefs, dont les Quinjets, il est idéal pour la reconnaissance, la furtivité et le combat. Il accueille des moments clés de la saga, à la fois drôles et solennels. Dans le film Avengers de Marvel Studios (2012), il s'agit d'un lieu de rassemblement pour les Avengers; Loki est détenu dans une cellule de confinement, Hulk fait (inévitavelmente) des ravages et Nick Fury assiste à la mort déchirante de Phil Coulson. Dans Avengers : L'ère d'Ultron, sans équipement sur le pont, lorsque Fury fait une entrée remarquée dans l'hélicoptère « sorti de la naphtaline » pour aider les Avengers à Sokovia.

No es un submarino

Encargado por Naciones Unidas y con Nick Fury al frente, el Helitransporte es la base móvil de S.H.I.E.L.D. en el universo cinematográfico Marvel. Se mueve con la misma agilidad por el aire que por el mar, y funciona con motores avanzados, turbinas y, posteriormente, repulsos. Además de servir como aeródromo para diversas aeronaves, incluidos los Quinjets, es ideal para misiones de reconocimiento, sigilo y combate. Es el escenario de numerosos momentos clave de la saga, tanto divertidos como solemnes. En la película de Marvel Studios The Avengers: Los Vengadores (2012), es el lugar de reunión de los Vengadores donde mantienen a Loki confinado en una celda, Hulk causa estragos (lo haría también en cualquier otro lugar) y Nick Fury es testigo de la desgarradora muerte de Phil Coulson. Avengers: Era de Ultrón nos permitió ver una versión "sacada del baúl de los recuerdos" y desprovista de cualquier comodidad a bordo del Helitransporte en la que Nick Fury hace una entrada triunfal para ayudar a los Vengadores en Sokovia.







From the LEGO® Marvel Design Team

We made a significant effort to make this model as close to the Helicarrier seen in Marvel Studios' The Avengers (2012) as possible, with references to multiple movie scenes. (The Helicarriers seen in Captain America: The Winter Soldier (2014) serve a different purpose.) Advanced hinge, clip and sloped building techniques recreate the Helicarrier's unusual shapes and angled runways. The lower runway slides out to reveal interior rooms, and throughout the model, stacked 1x1 round tiles mark the S.H.I.E.L.D. agents and Avengers in action.

De l'équipe de conception LEGO® Marvel

Nous avons fait un effort significatif pour rendre ce modèle aussi proche que possible de l'hélicoptère vu dans le film Avengers de Marvel Studios (2012), avec des références à de nombreuses scènes du film. (Les hélicoptères vus dans Capitaine America : le Soldat de l'hiver (2014) ont une fonction différente.) Les techniques avancées de construction à charnière, à clip et à pente permettent de recréer les formes inhabituelles et les pistes d'atterrissage inclinées de l'hélicoptère. La piste inférieure est coulissante afin pour révéler les pièces intérieures, et dans tout le modèle, des tuiles rondes 1x1 empilées indiquent les agents du S.H.I.E.L.D. et les Avengers en action.

Impresiones del equipo de diseño de LEGO® Marvel

Hicimos un gran esfuerzo para que este modelo se pareciera lo máximo posible al Helitransporte que aparece en la cinta The Avengers: Los Vengadores (2012) de Marvel Studios, con referencias a numerosas escenas de la película. (Los Helitransportes que aparecen en Capitán América y el Soldado del Invierno (2014) tienen una finalidad distinta). Las formas inusuales y las pistas en ángulo del Helitransporte se construyen aplicando técnicas de construcción avanzadas con articulaciones, fijaciones y pendientes. La pista inferior se desliza hacia un lado para revelar las habitaciones del interior y, por todo el modelo, puedes encontrar pequeñas torres de cubiertas 1x1 redondas que representan a los agentes de S.H.I.E.L.D. y los Vengadores en acción.

Step inside for a minute

The LEGO® version of this base for S.H.I.E.L.D. – Strategic Homeland Intervention, Enforcement and Logistics Division – is full of authentic details and a few creative modifications.* To keep the model balanced and sturdy, the rear lab is moved back, and the watchtower is slightly oversized to fit more details. And Captain America's table is round (instead of a pentagon shape) for easy recognition.

Entrez pour une minute

La version LEGO® de cette base pour le S.H.I.E.L.D. – Strategic Homeland Intervention, Enforcement and Logistics Division – est pleine de détails authentiques et compte quelques modifications créatives*. Pour que le modèle reste équilibré et solide, le laboratoire arrière est reculé et la tour de guet est légèrement surdimensionnée pour accueillir plus de détails. La table de Capitaine America est ronde (au lieu d'être pentagonale), ce qui permet de la reconnaître facilement.

Un minuto por el interior

La versión LEGO® de esta base de S.H.I.E.L.D. (Sistema Homologado de Inteligencia, Espionaje, Logística y Defensa) está repleta de detalles auténticos y algunas modificaciones creativas.* Para mantener el equilibrio y la resistencia del modelo, el laboratorio trasero se recorrió un poco hacia atrás y la torre de vigilancia se hizo ligeramente más grande, lo que también permite incluir más detalles. La mesa del Capitán América también se recreó con forma redonda (a diferencia de la original, que es pentagonal), lo que facilita su identificación.

*Disclaimer: Cloaking capabilities not included.

*Avertissement : Les capacités d'occultation ne sont pas incluses.

* Exención de responsabilidad: No incluye capacidades de invisibilidad.



An enraged Hulk goes on a rampage.
Hulk, furieux, se déchaîne.
Un Hulk enfurecido haciendo destrozos.

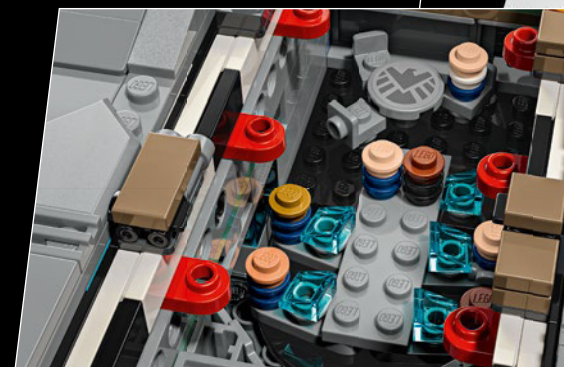

Avengers and agents assemble on the bridge.
Les Avengers et les agents se rassemblent sur le pont.
Los Vengadores y los agentes se reúnen en el puente.

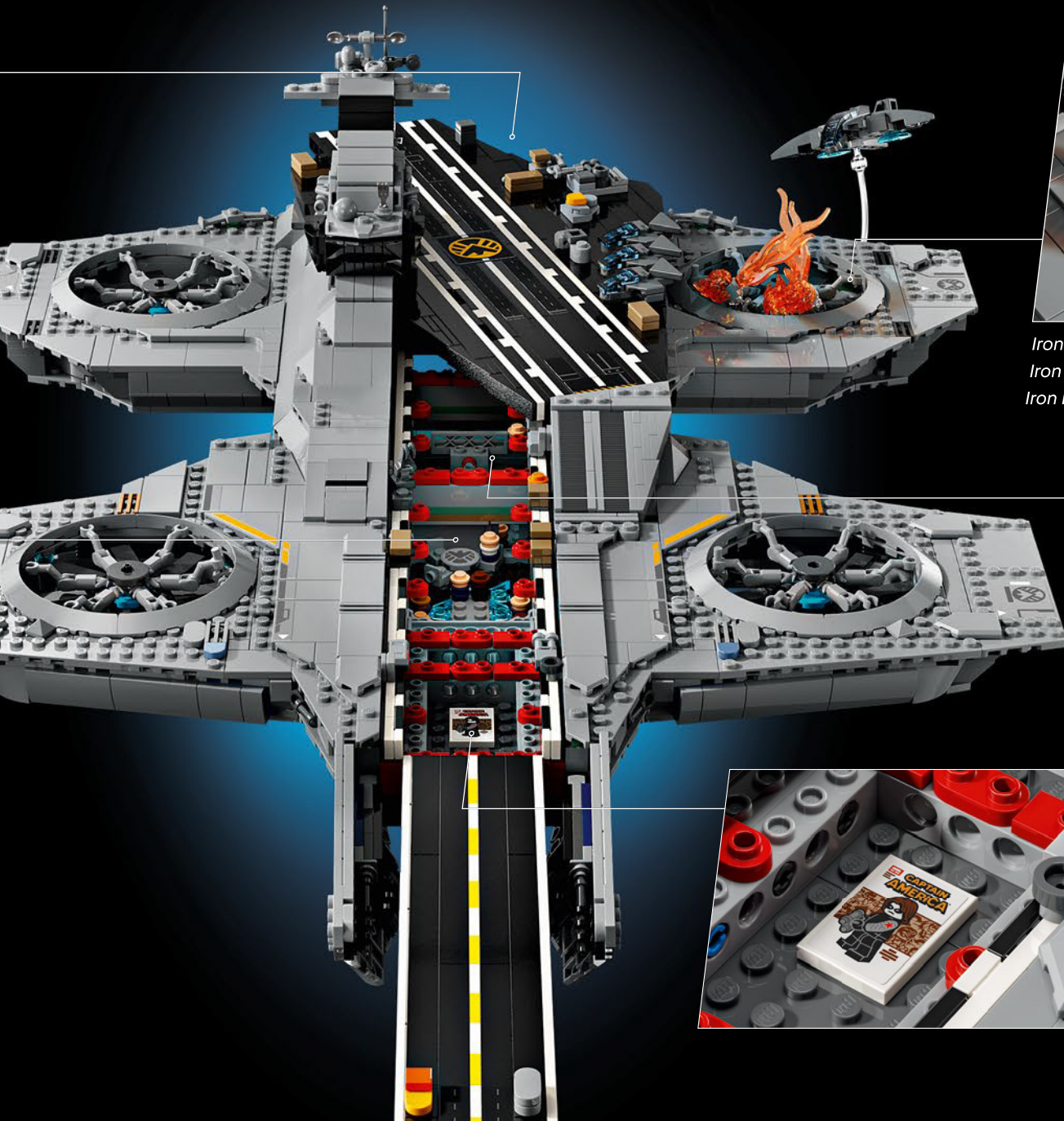

*Iron Man tries to restart the exploded engine.
Iron Man tente de redémarrer le moteur qui a explosé.
Iron Man intenta reiniciar el motor después de una explosión.*

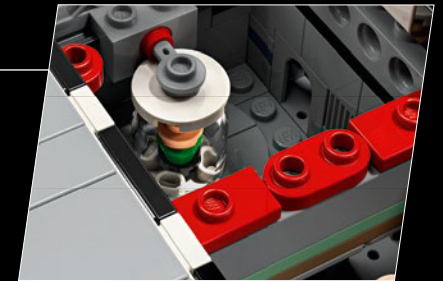

*Loki in the removable detention pod.
Loki dans le module de détention amovible.
Loki en la cápsula de detención removable.*



*Marvel comic book with the Winter
Soldier on the cover.
Une bande dessinée Marvel avec le
Soldat de l'Hiver sur la couverture.
Cómic de Marvel con el Soldado del
Invierno en la portada.*



Phil Coulson
The Avengers (2012)

Loyal and highly respected S.H.I.E.L.D. agent whose death unites the Avengers.

Phil Coulson
Avengers (2012)

Agent loyal et très respecté du S.H.I.E.L.D. dont la mort unit les Avengers.

Phil Coulson
The Avengers: Los Vengadores (2012)

Agente leal y muy respetado de S.H.I.E.L.D., cuyo deceso une a los Vengadores.



Hawkeye
The Avengers (2012)

Exceptional archer-turned-Avenger (after a bout of mind control).

Hawkeye
Avengers (2012)

Archer exceptionnel devenu Avenger (après un contrôle mental).

Hawkeye
The Avengers: Los Vengadores (2012)

Excepcional arquero convertido en Vengador (luego de un episodio de control mental).



The Winter Soldier
Captain America: The Winter Soldier (2014)

Deadly Hydra sleeper agent revealed as Steve Rogers' old friend.

Le Soldat de l'hiver
Capitaine America : Le Soldat de l'hiver (2014)

Un agent dormant de l'Hydra se révèle être un vieil ami de Steve Rogers.

Soldado del Invierno
Capitán América y el Soldado del Invierno (2014)

El letal agente durmiente de Hydra resulta ser un viejo amigo de Steve Rogers.



Captain America

Captain America: The Winter Soldier (2014)

WWII hero Steve Rogers uncovers Hydra conspiracies in S.H.I.E.L.D.

Capitaine America

Capitaine America : Le Soldat de l'hiver (2014)

Steve Rogers, héros de la Seconde Guerre mondiale, découvre les conspirations de l'Hydra dans le S.H.I.E.L.D.

Capitán América

Capitán América y el Soldado del Invierno (2014)

Steve Rogers, el héroe de la Segunda Guerra Mundial, descubre las conspiraciones de Hydra en S.H.I.E.L.D.



Maria Hill

Avengers: Age of Ultron (2015)

Trusted and skilled ex-S.H.I.E.L.D. deputy director aids Nick Fury's team.

Maria Hill

Avengers : L'ère d'Ultron (2015)

L'ex-directrice adjointe du S.H.I.E.L.D. fiable et compétente, aide l'équipe de Nick Fury.

Maria Hill

Avengers: Era de Ultrón (2015)

La confiable exdirectora adjunta de S.H.I.E.L.D. ayuda al equipo de Nick Fury con su gran experiencia.



Nick Fury

Avengers: Age of Ultron (2015)

Former S.H.I.E.L.D. agent responsible for reuniting the Avengers.

Nick Fury

Avengers : L'ère d'Ultron (2015)

Ancien agent du S.H.I.E.L.D. responsable de la réunification des Avengers.

Nick Fury

Avengers: Era de Ultrón (2015)

Antiguo agente de S.H.I.E.L.D., responsable de reunir a los Vengadores.

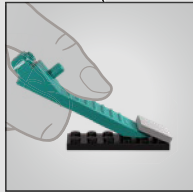
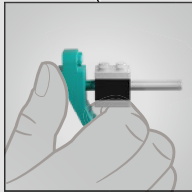
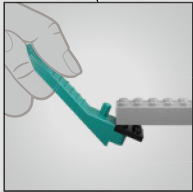
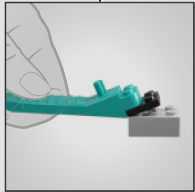
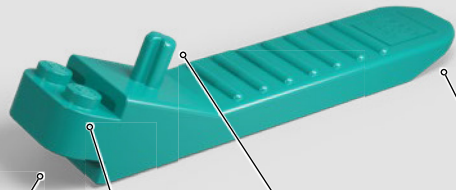

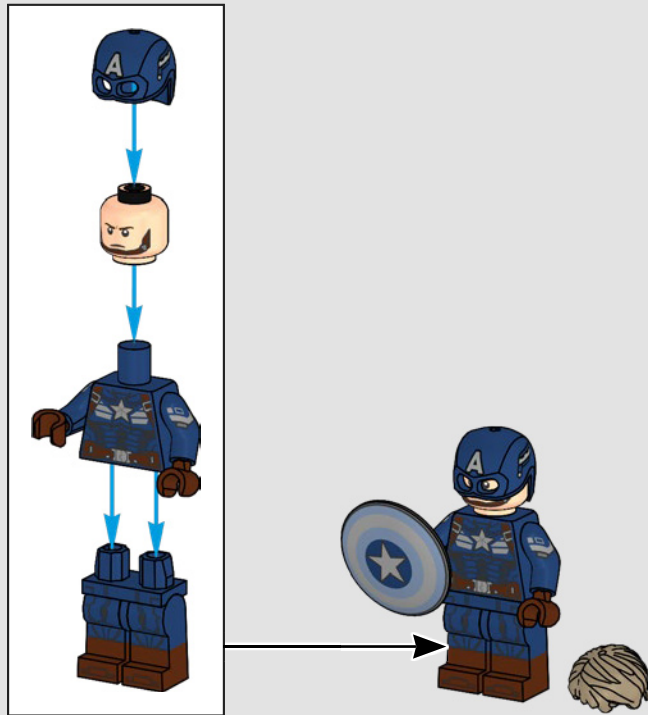
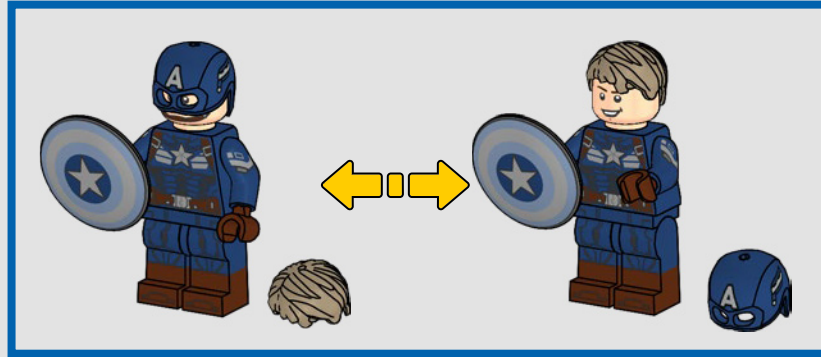

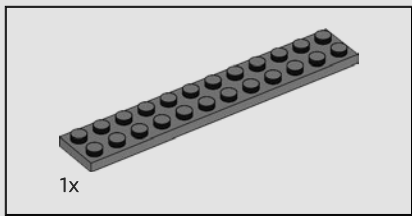

1

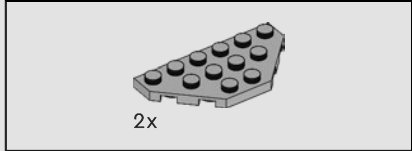
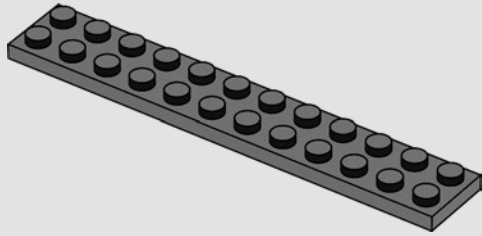

2

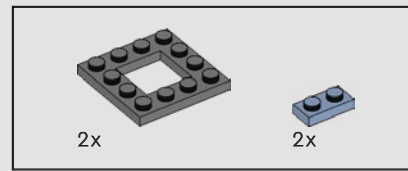
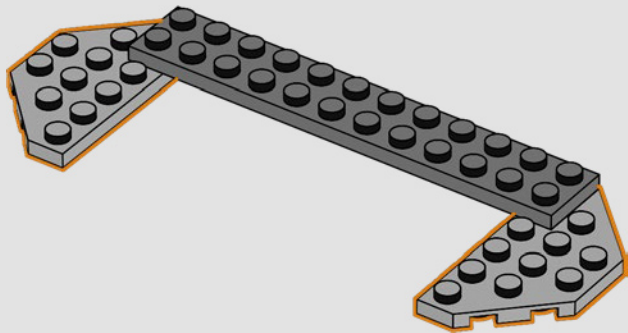

3

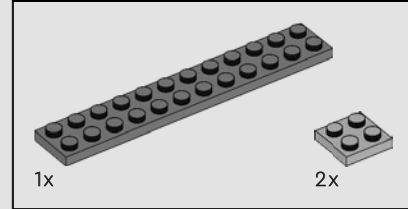
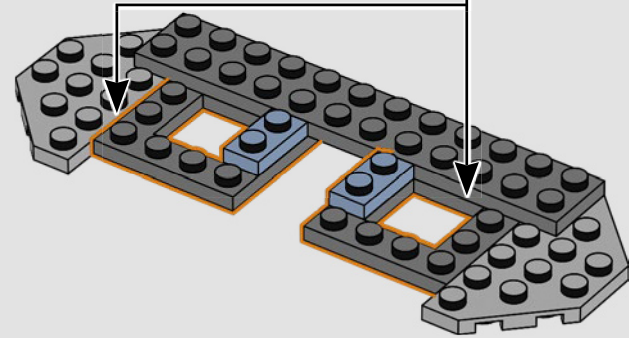
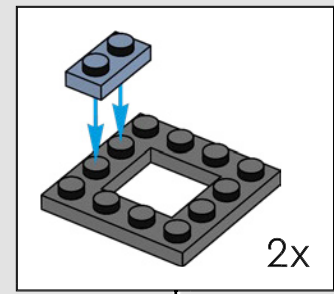

4

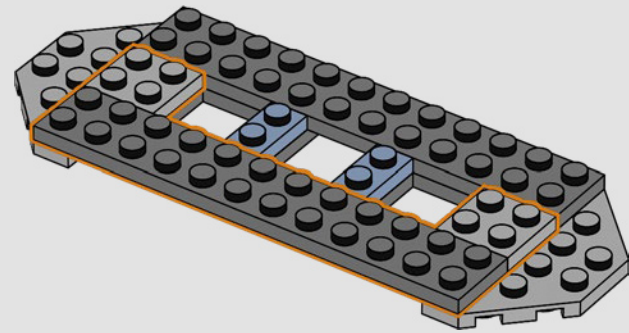

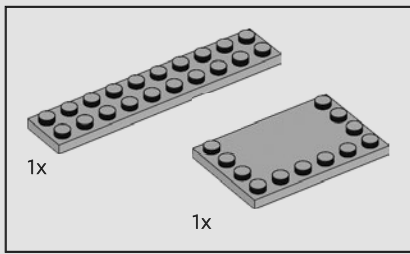

5

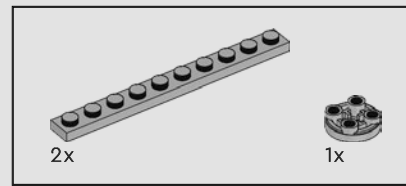
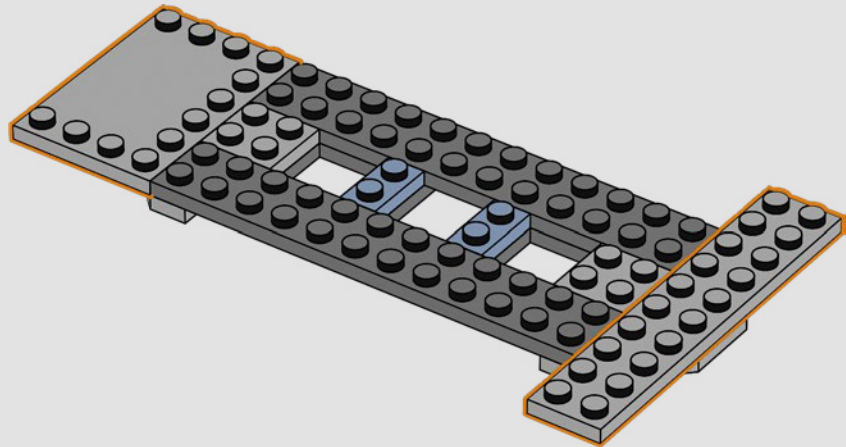

6

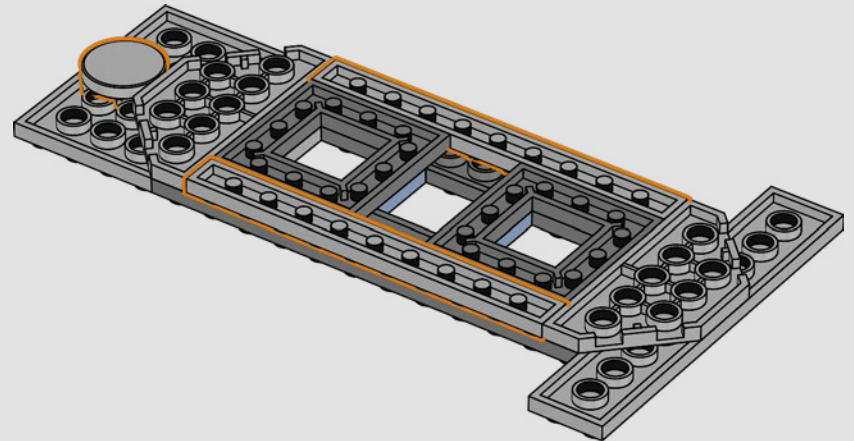
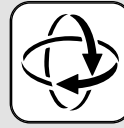

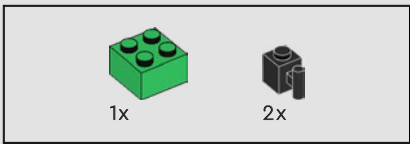

7

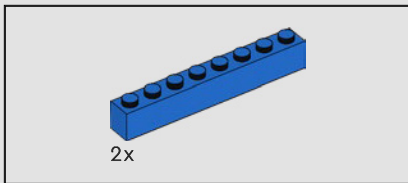
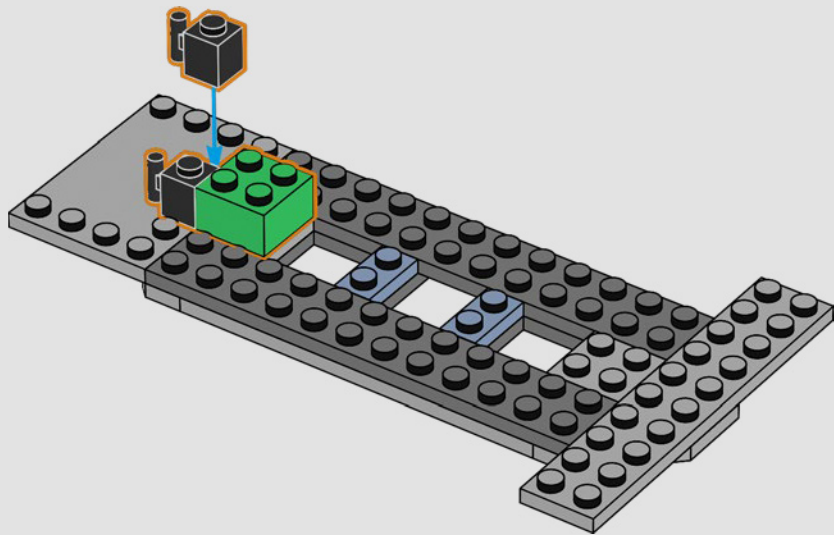

8

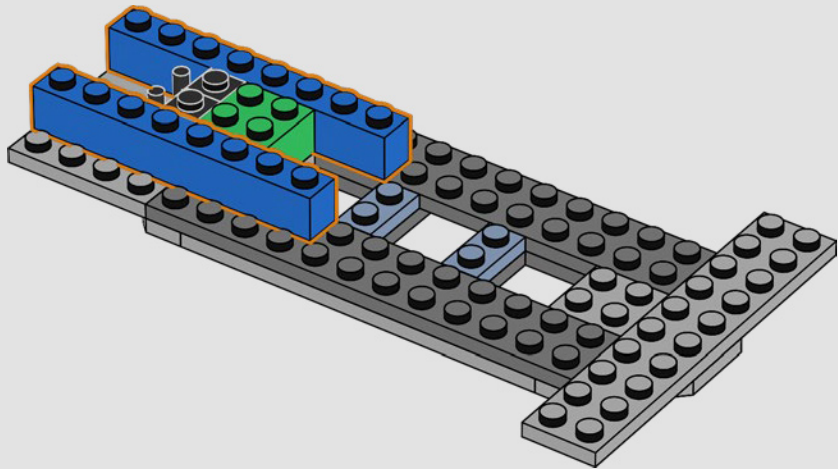

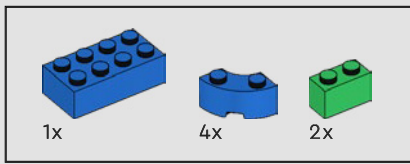

9

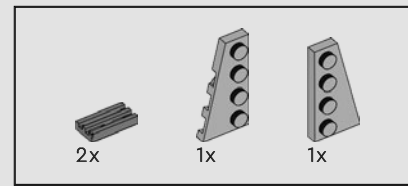
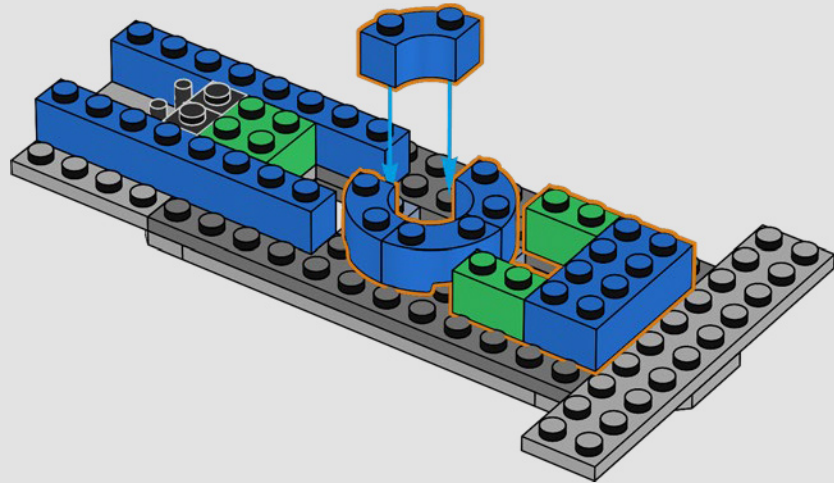

10

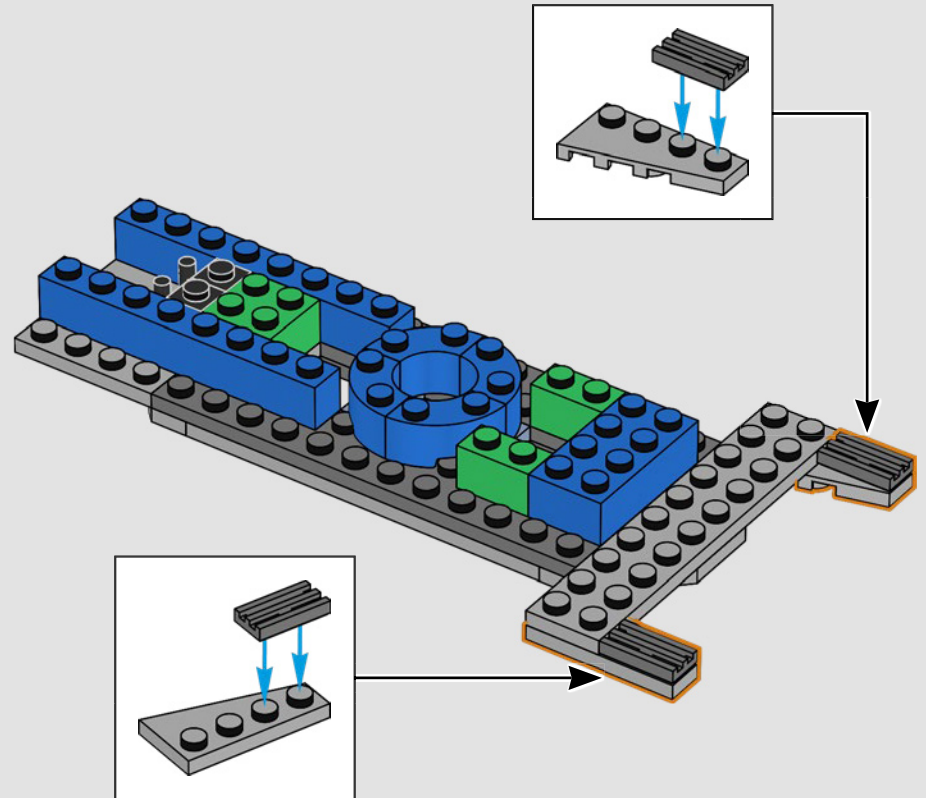



11

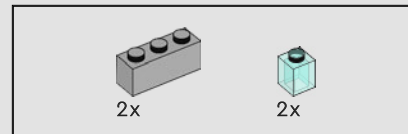
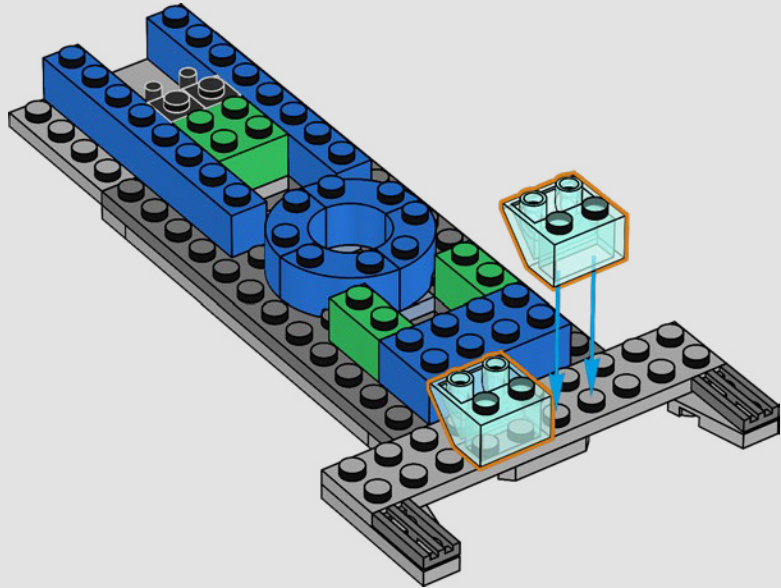

12

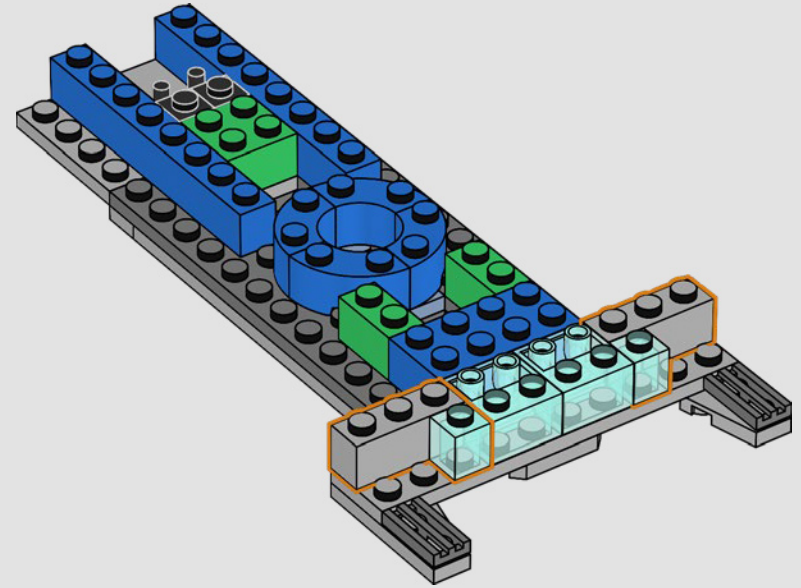

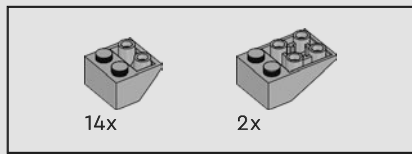

13

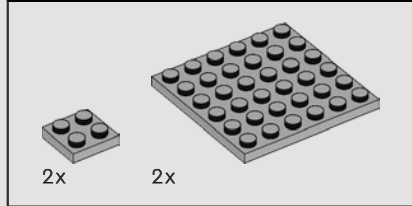
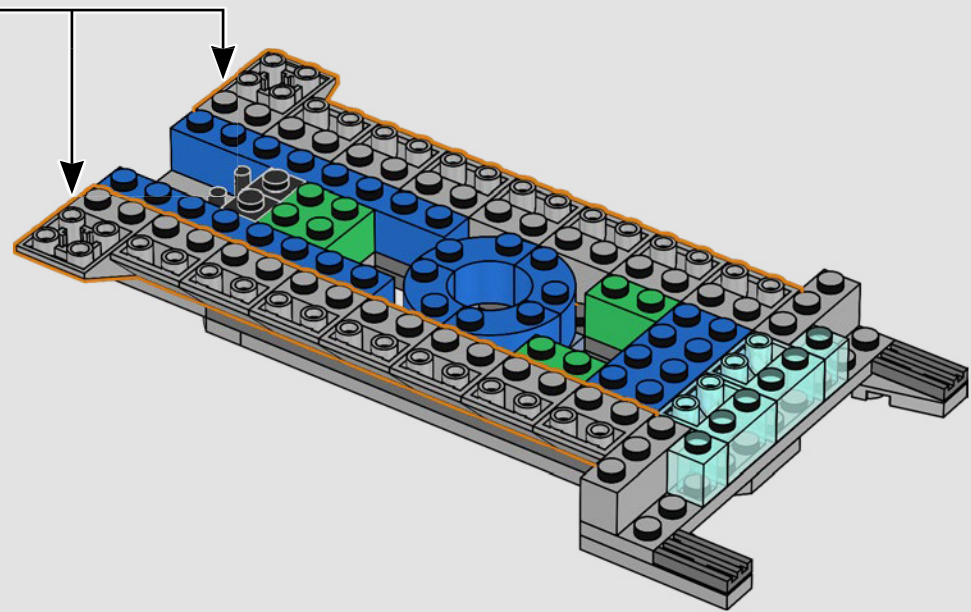
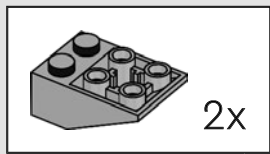

14

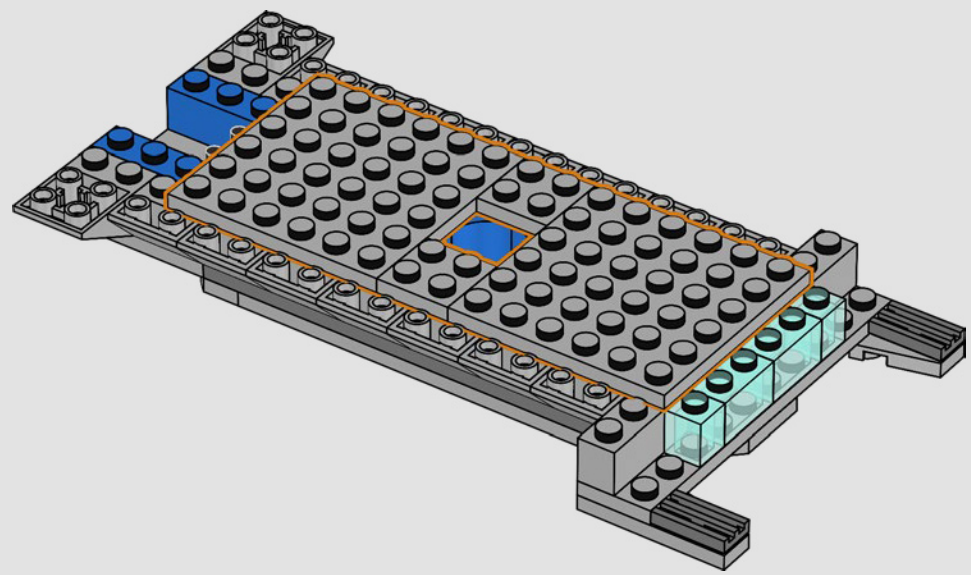

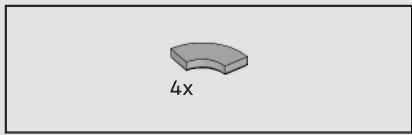

15

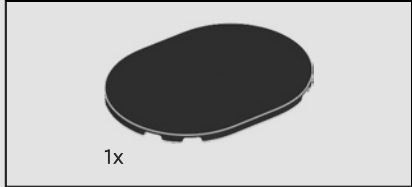
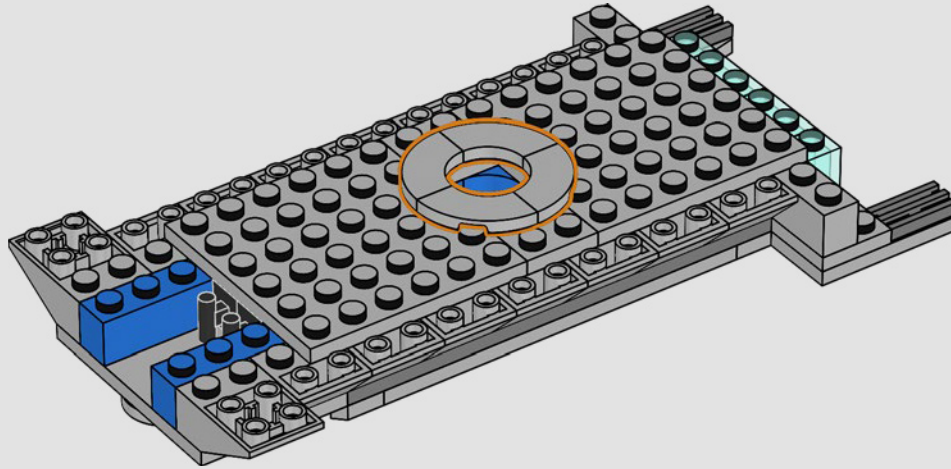

16

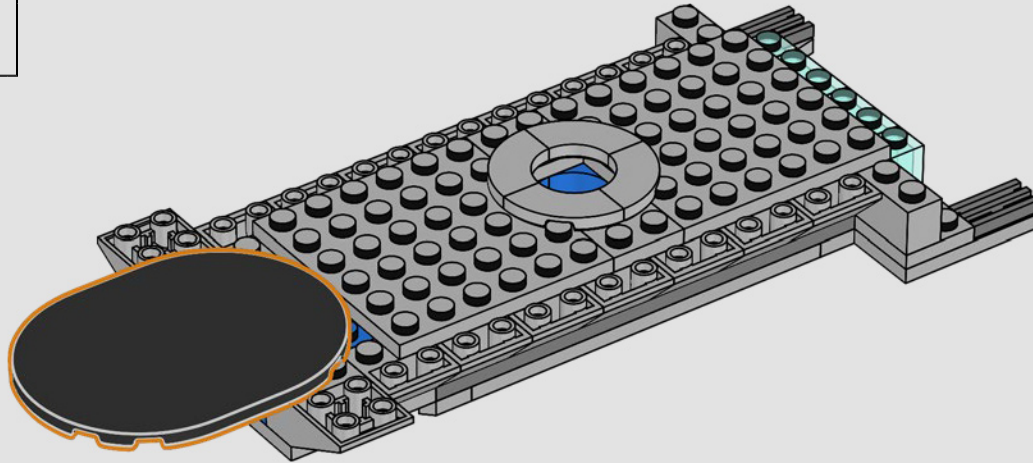

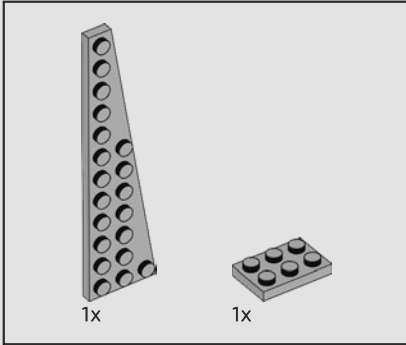
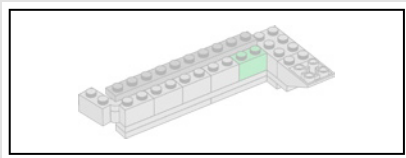

17

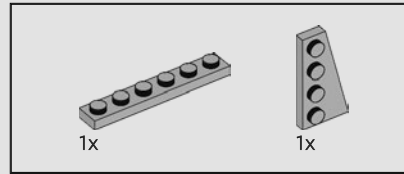
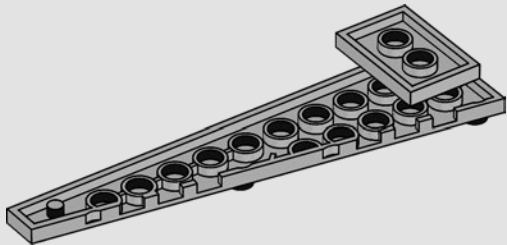

18

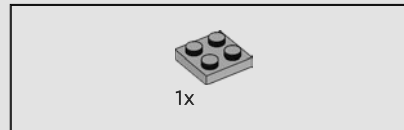
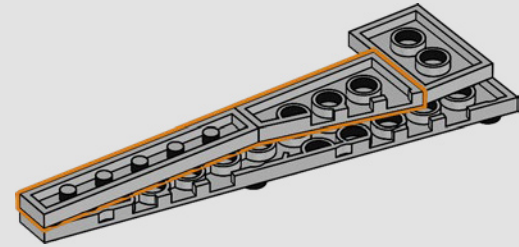

19

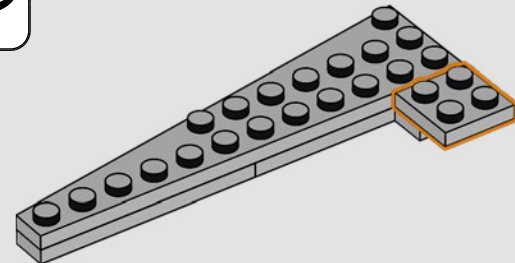
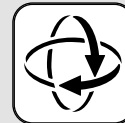

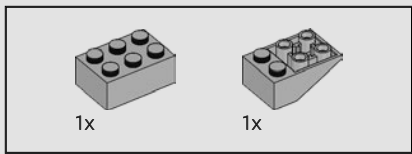

20

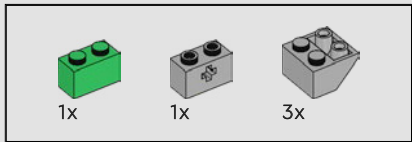
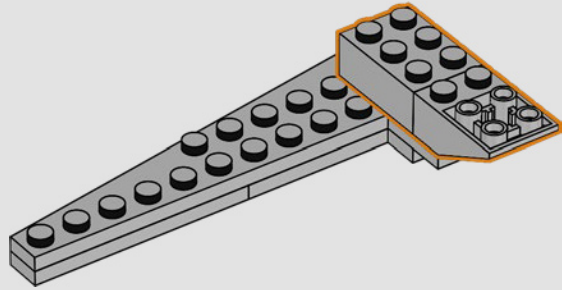

21

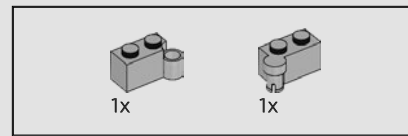
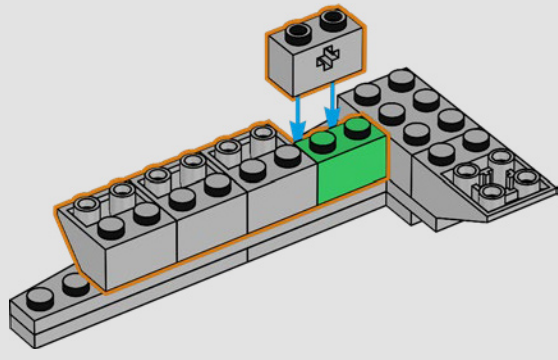

22

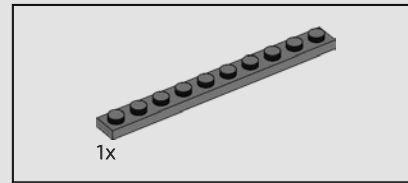
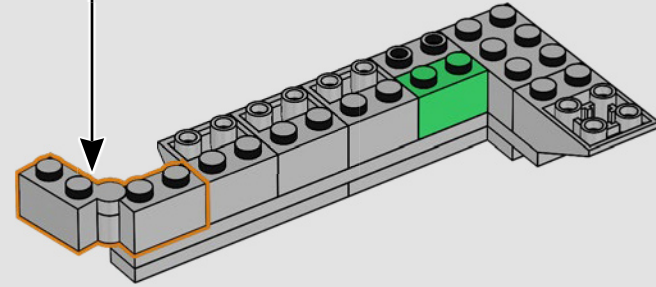
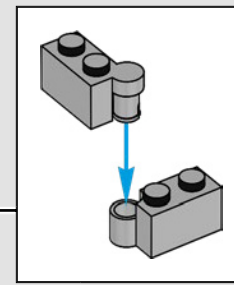

23

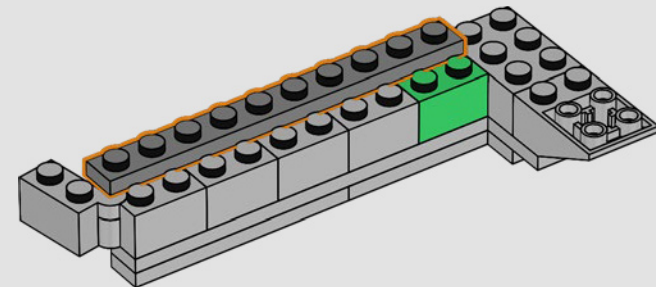

24

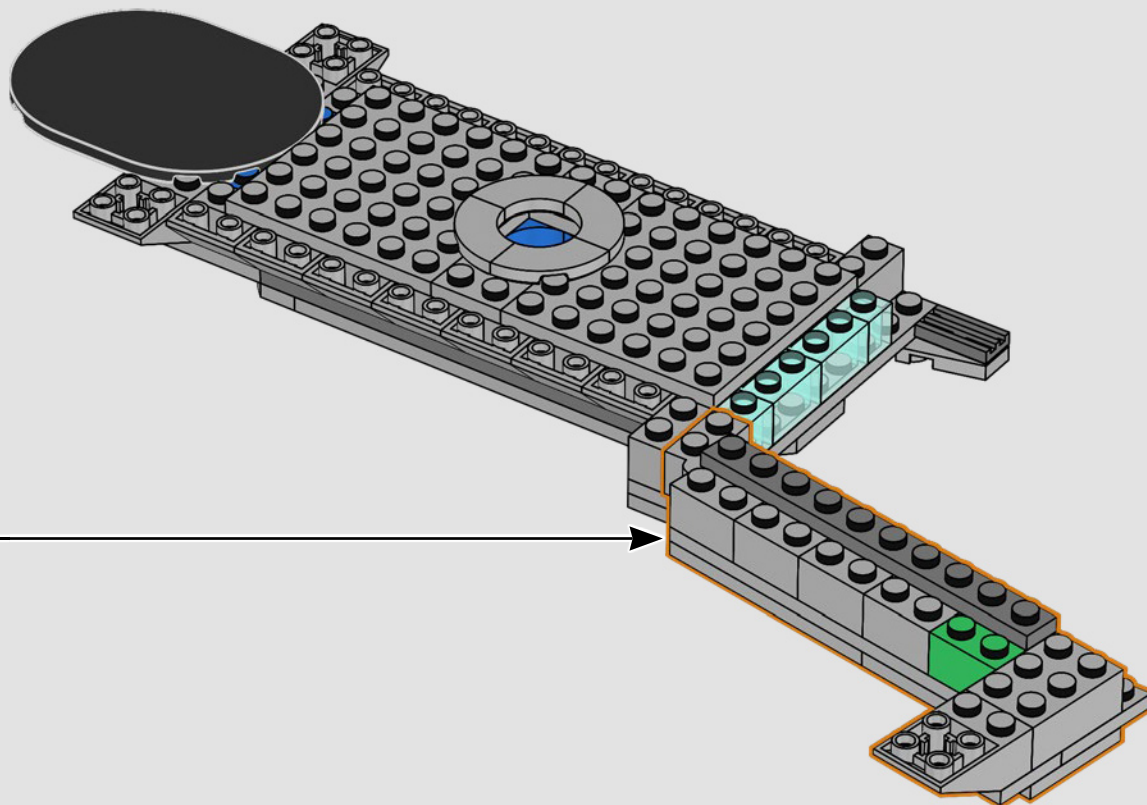

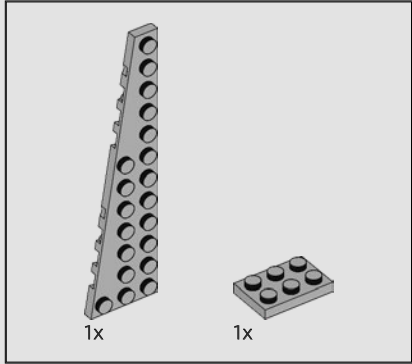
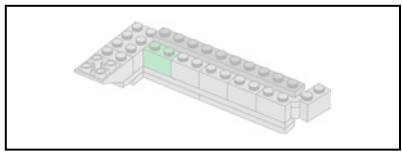

25

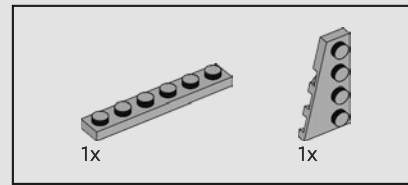
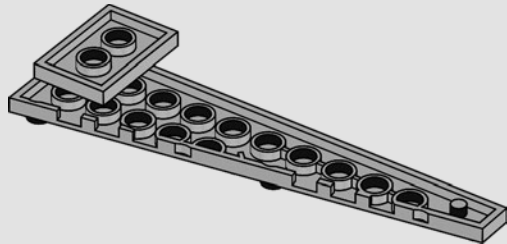

26

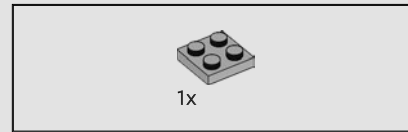
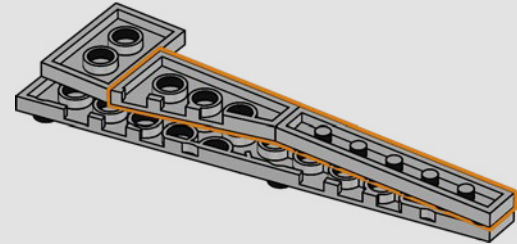

27

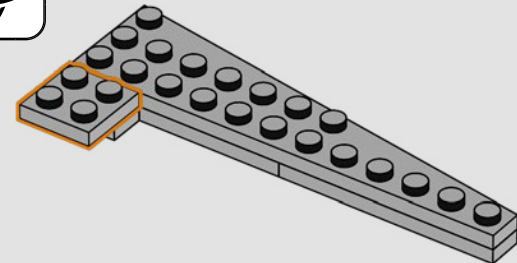
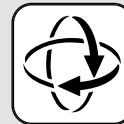

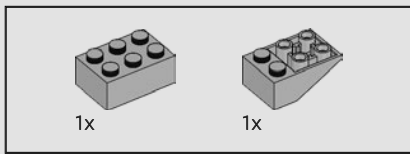

28

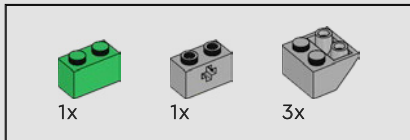
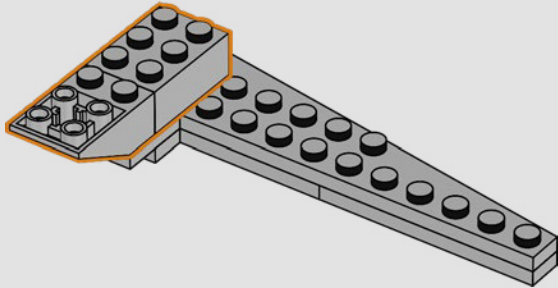

29

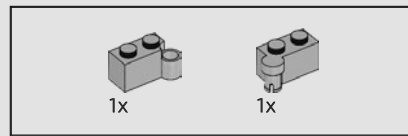
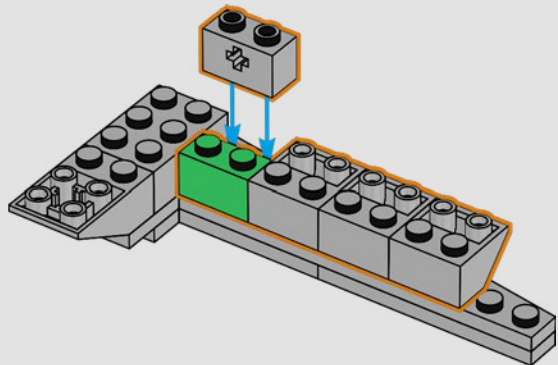

30

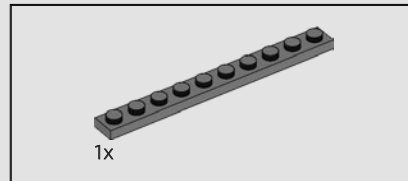
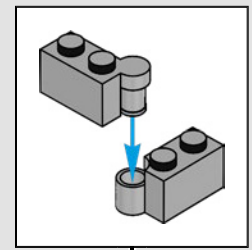
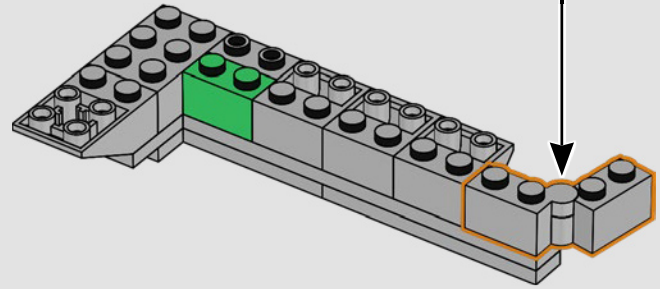

31

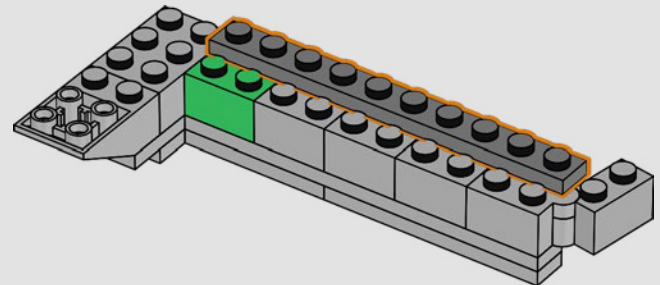

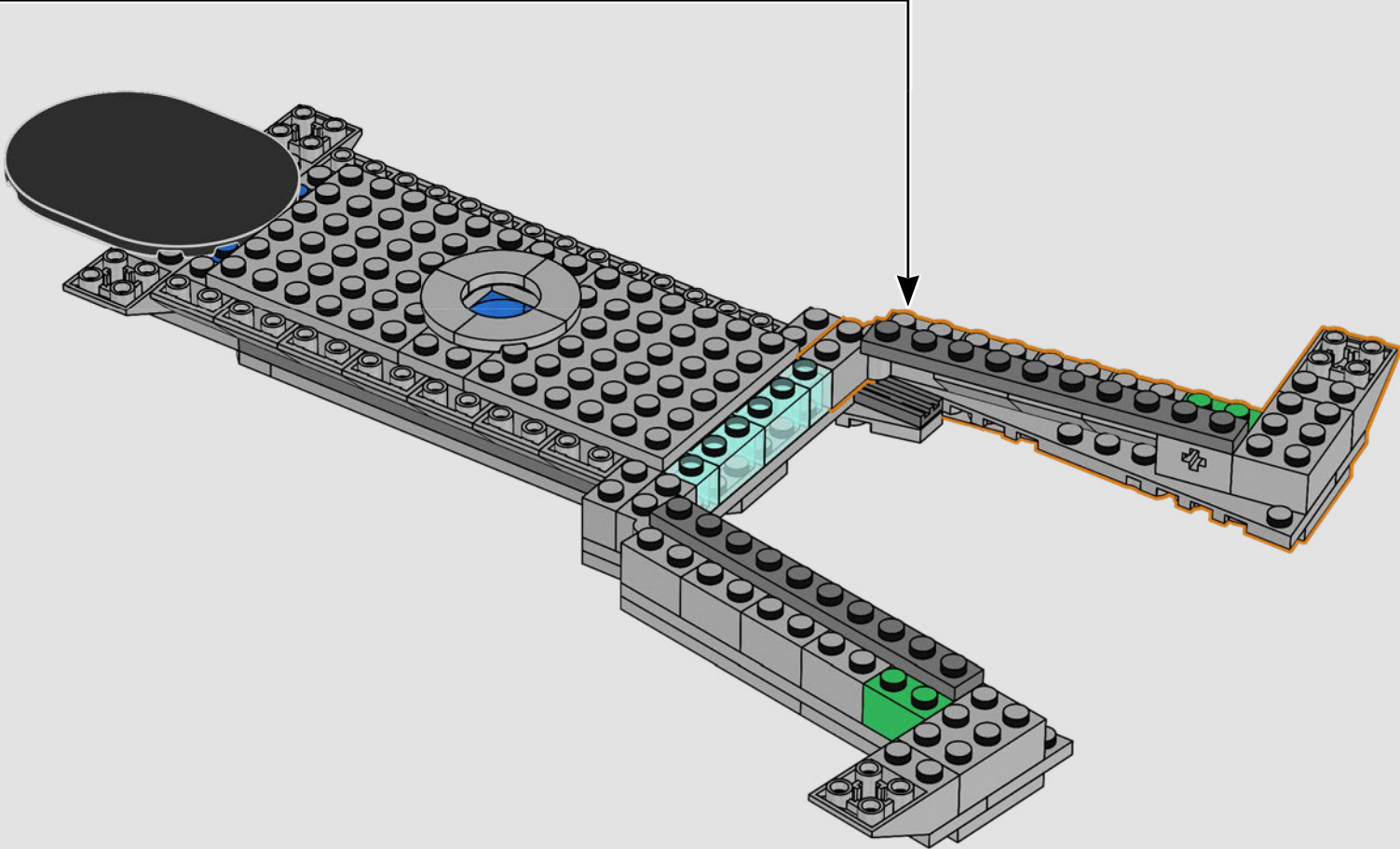

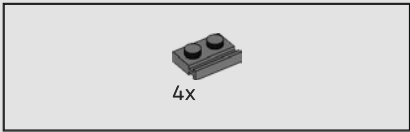

33

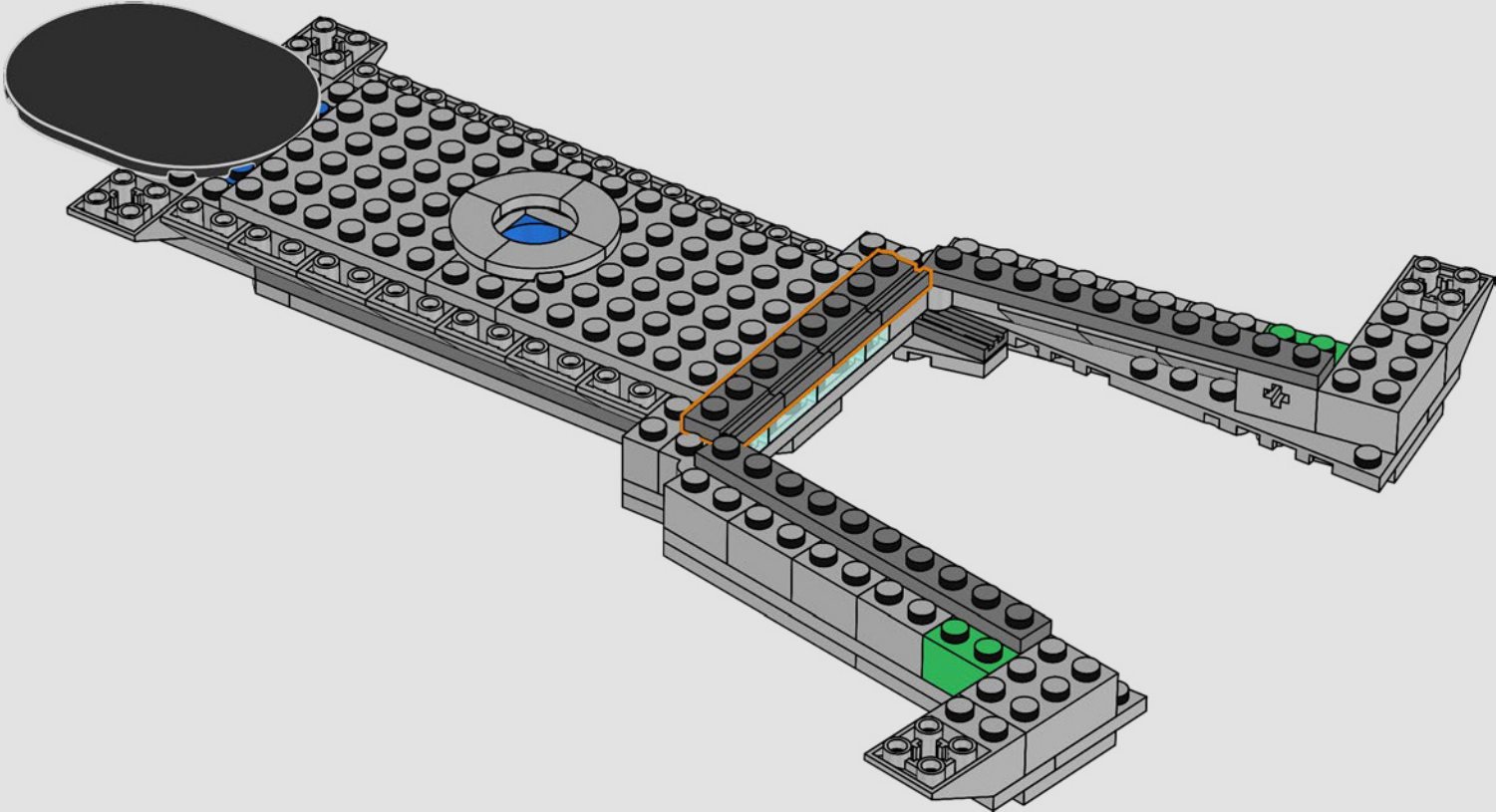

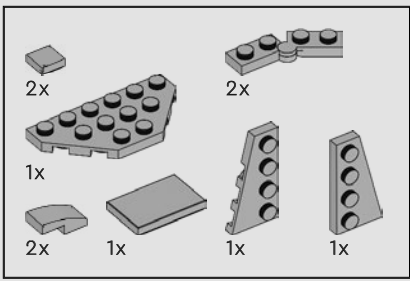

34

1

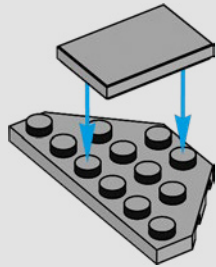

2

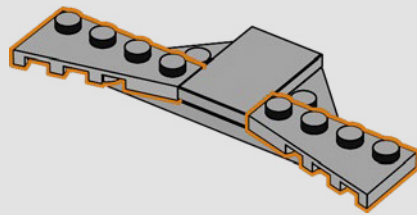

3

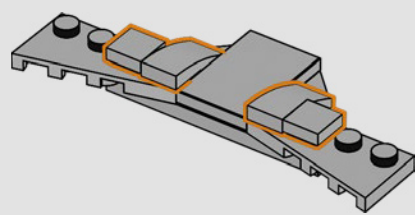

4

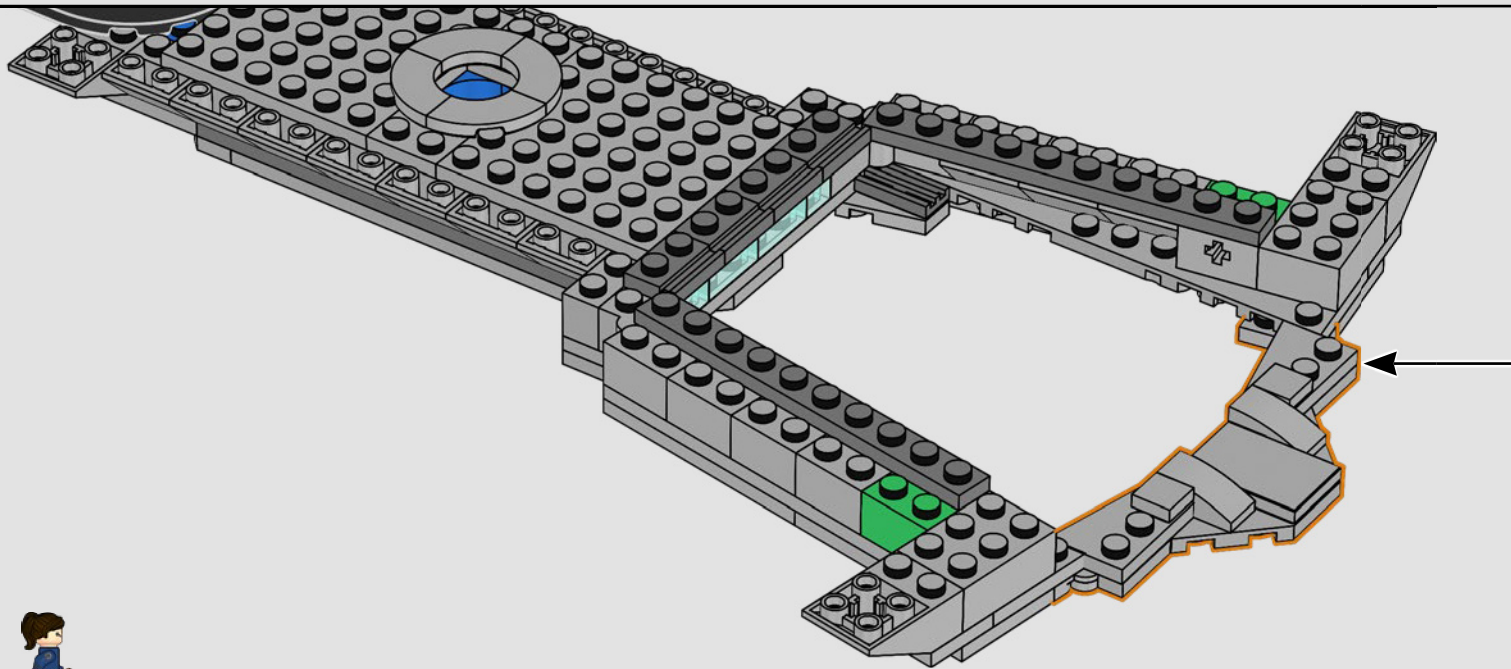
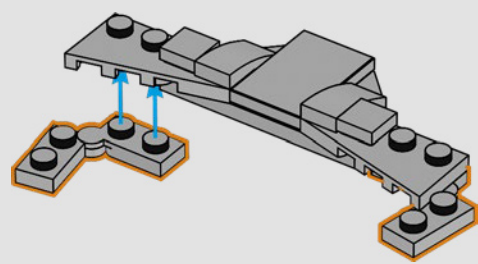

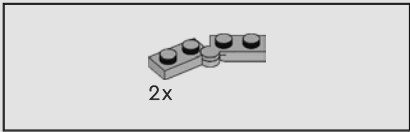

35

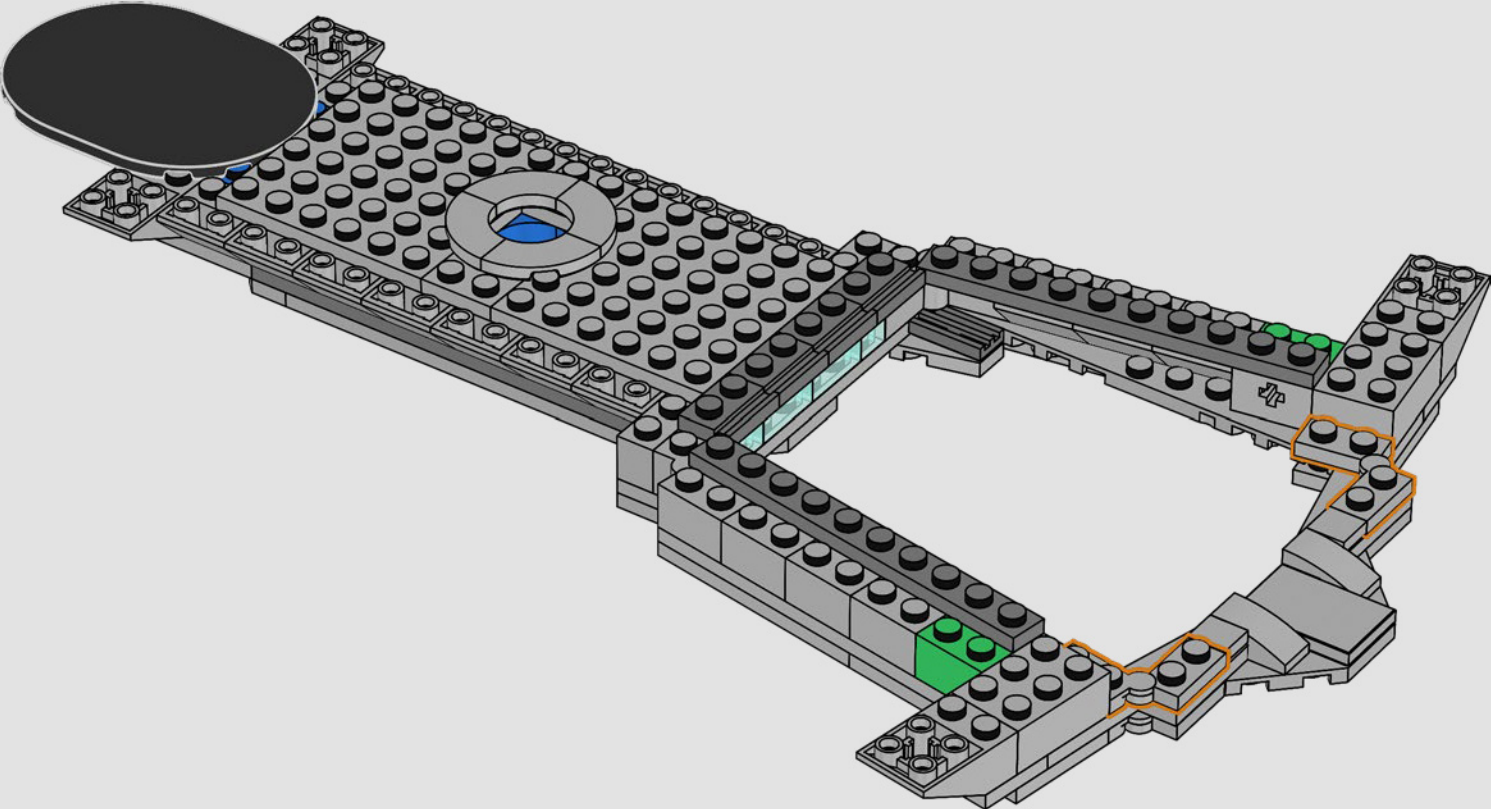

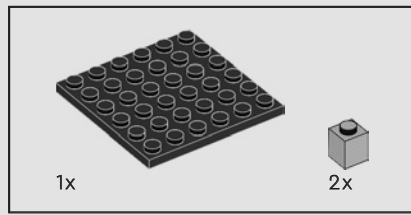

36

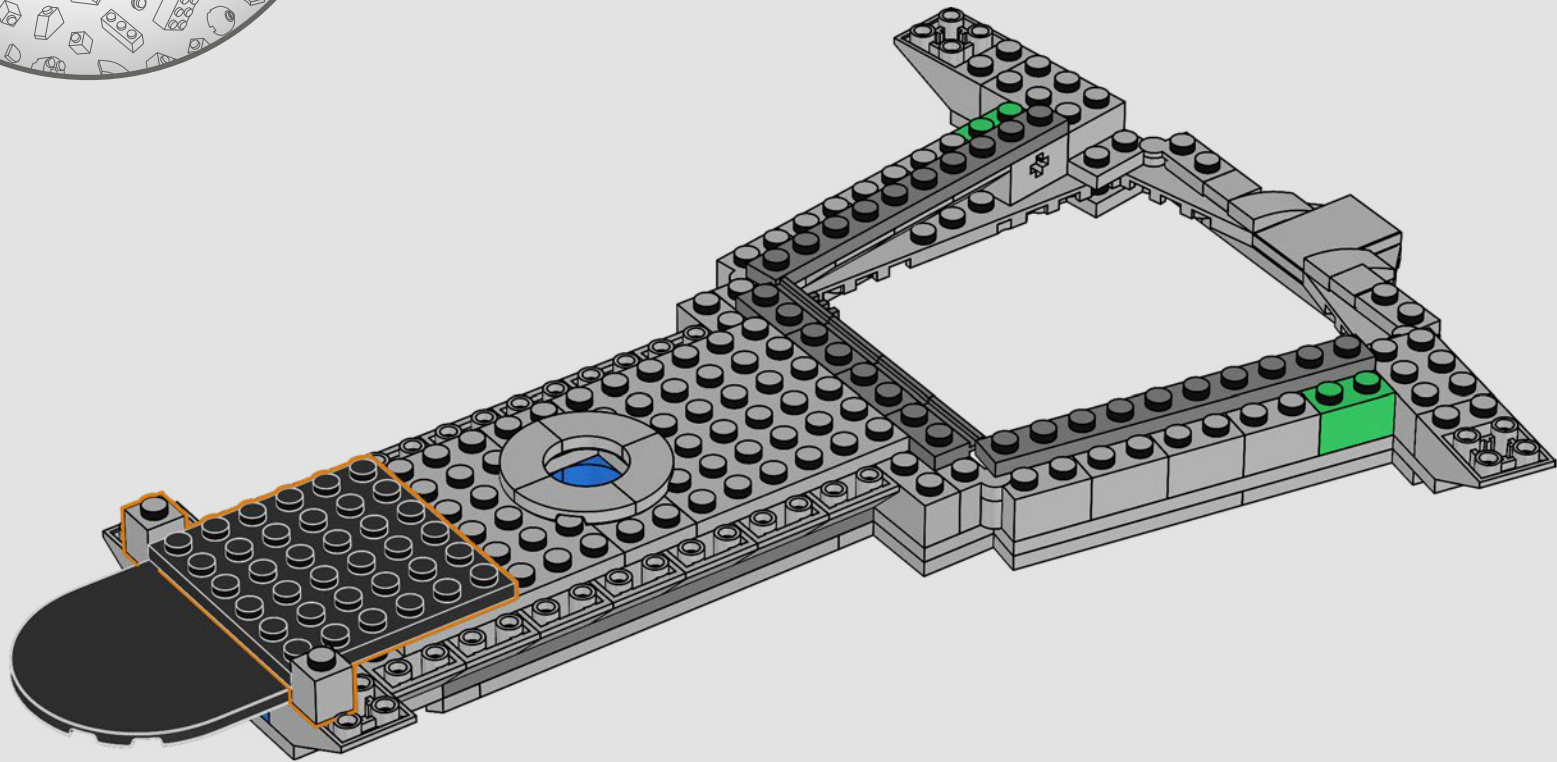

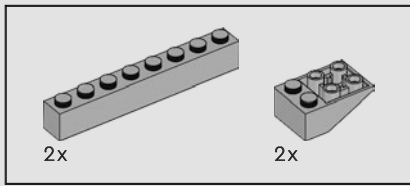

37

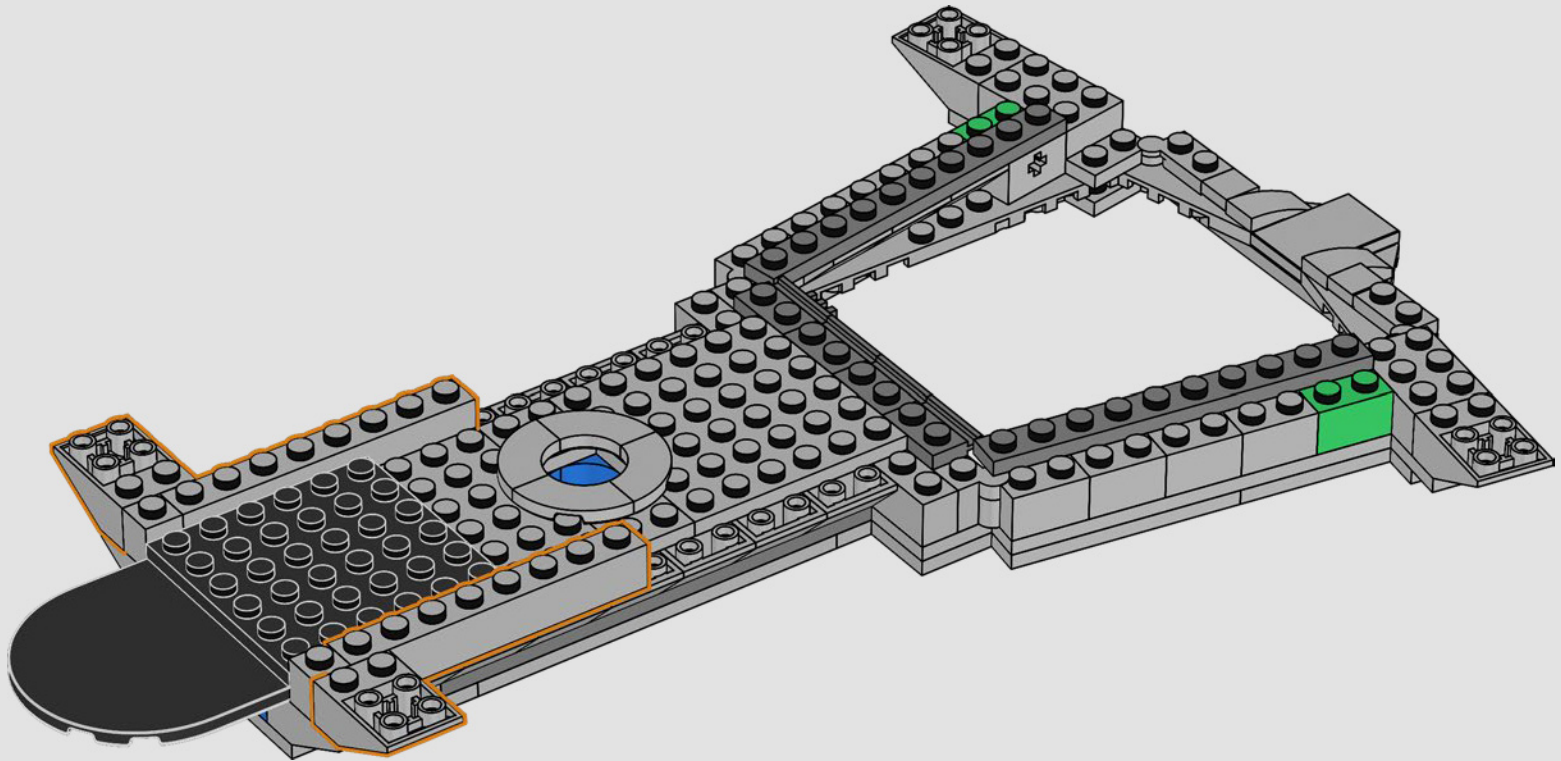

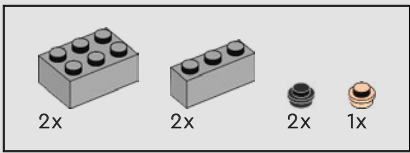

38

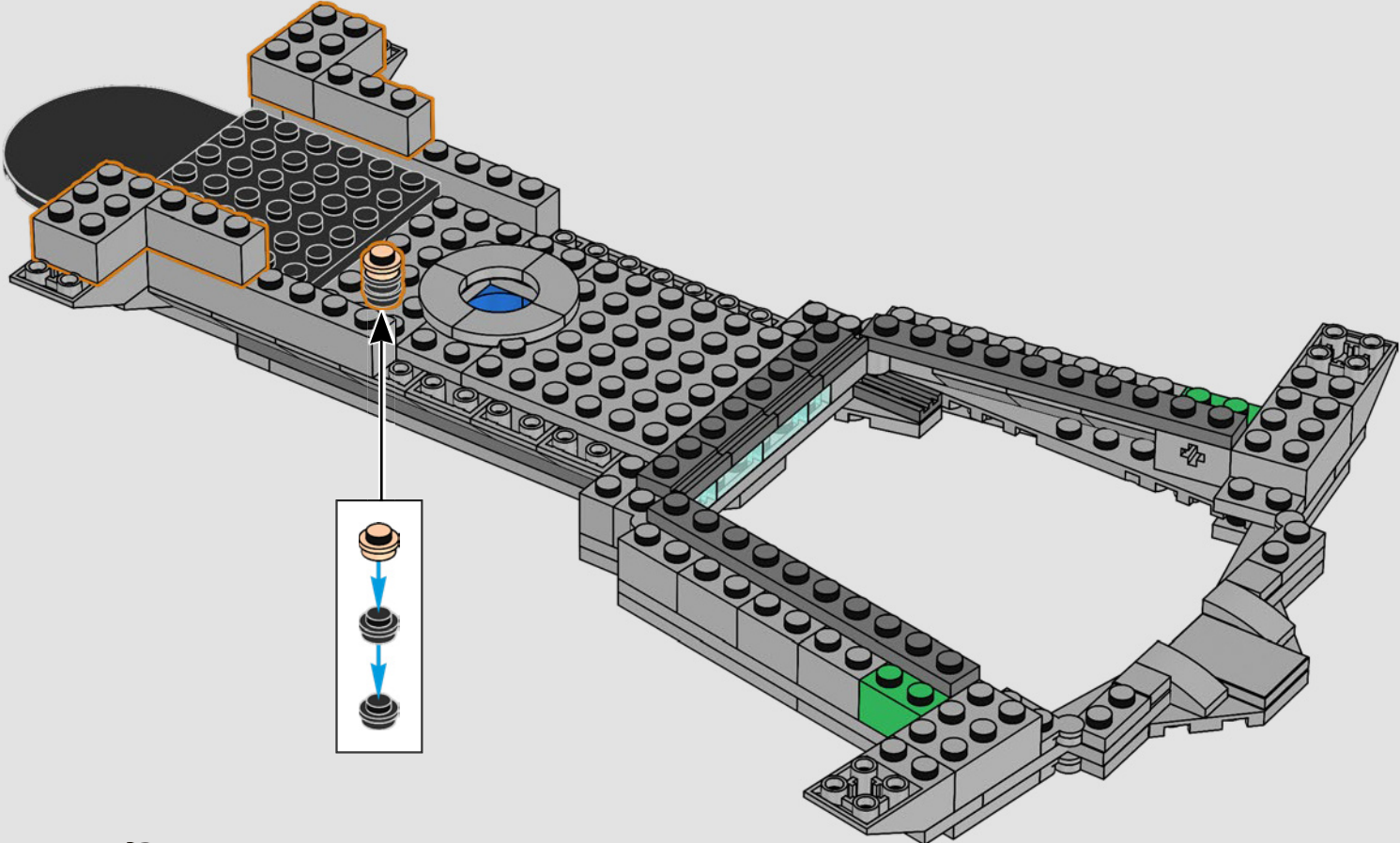

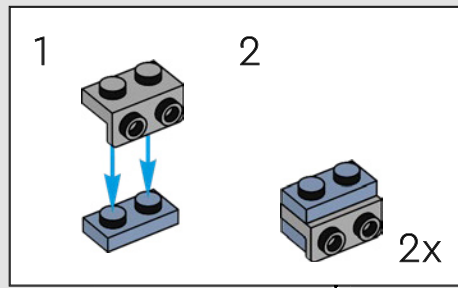
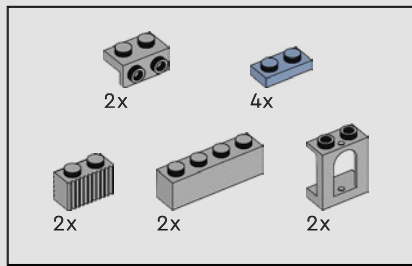

39

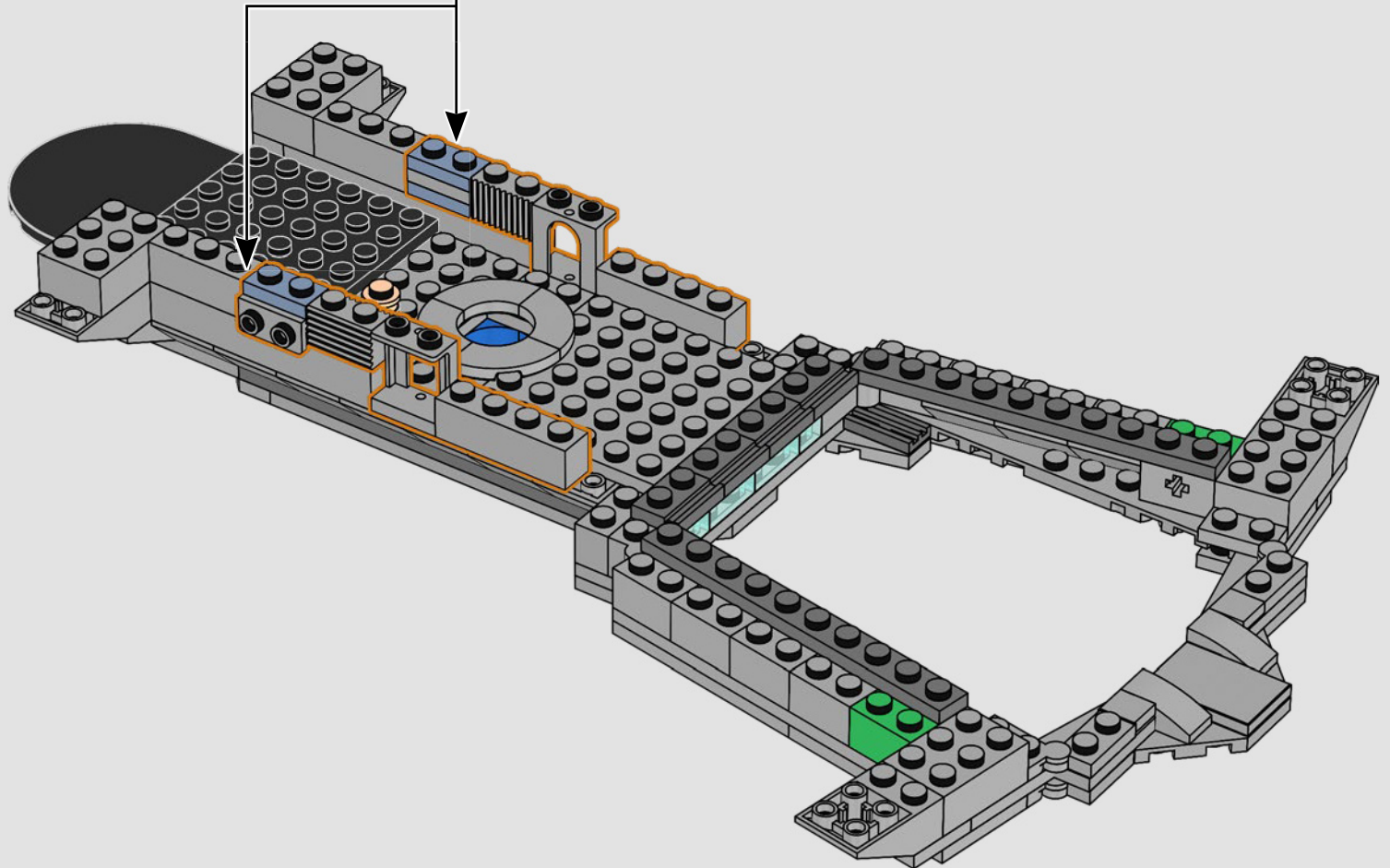

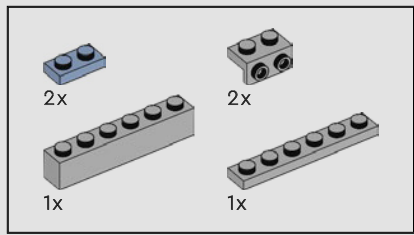

40

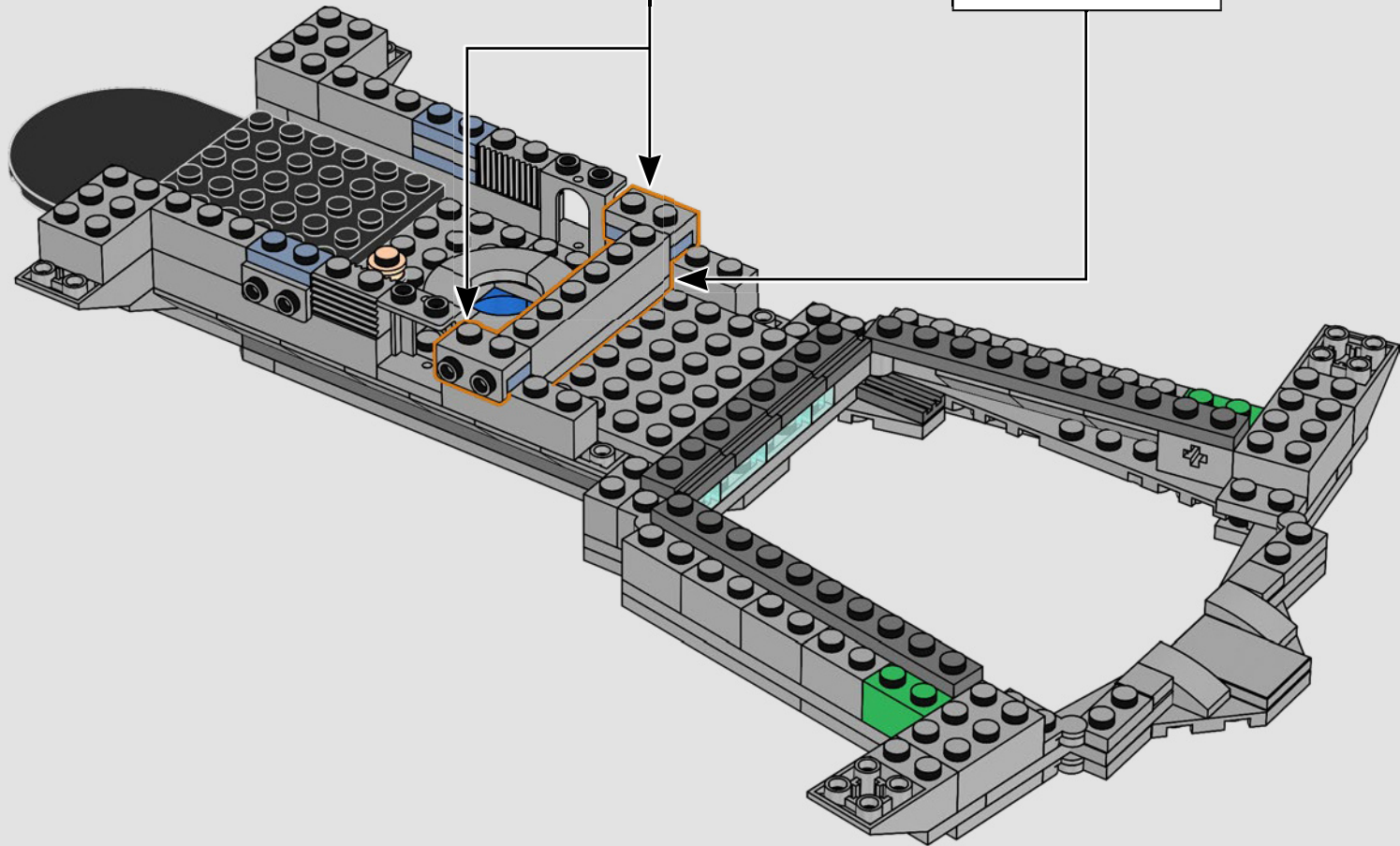
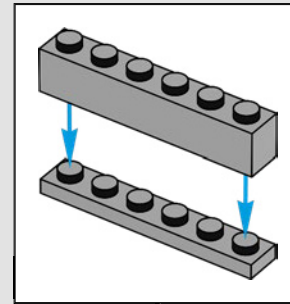
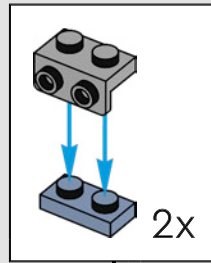

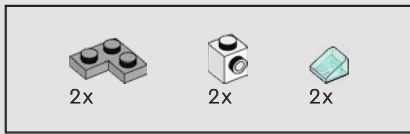

41

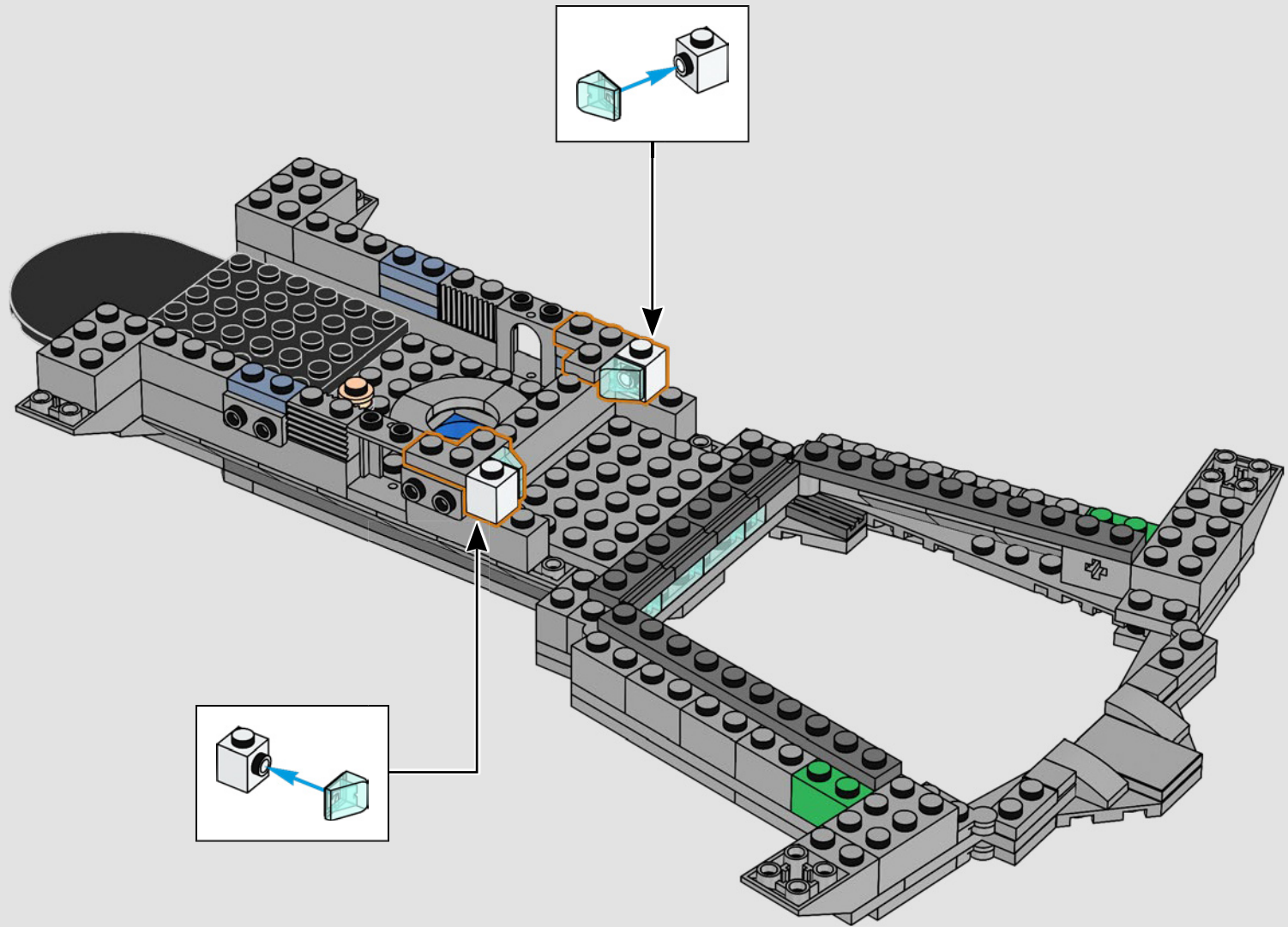



42

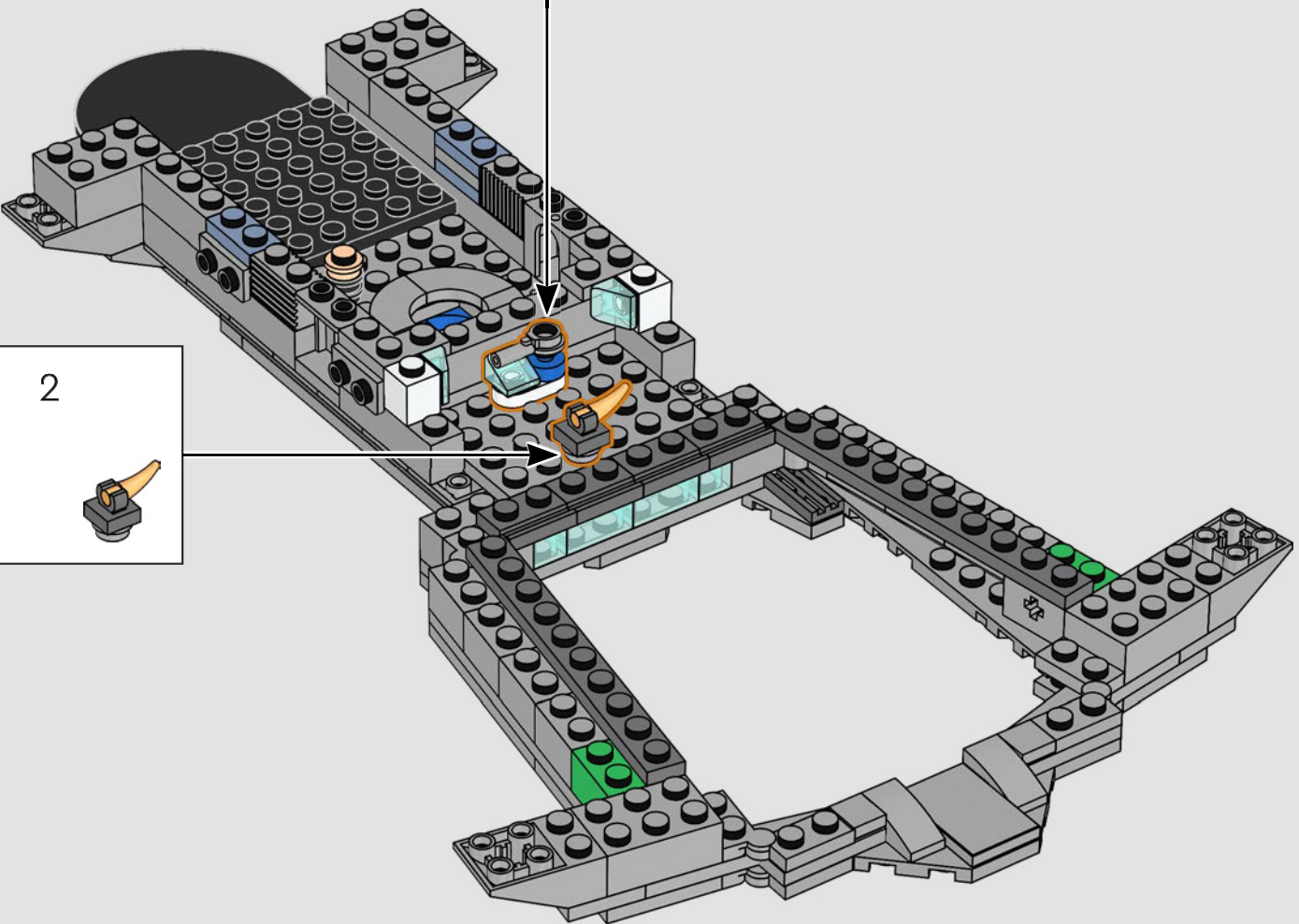
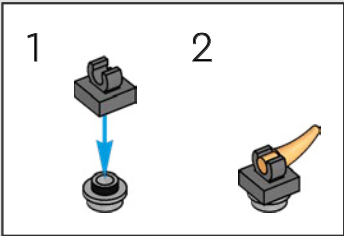
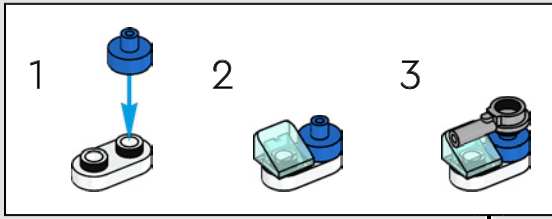

-  1x
-  1x
-  1x
-  4x
-  3x
-  2x

43

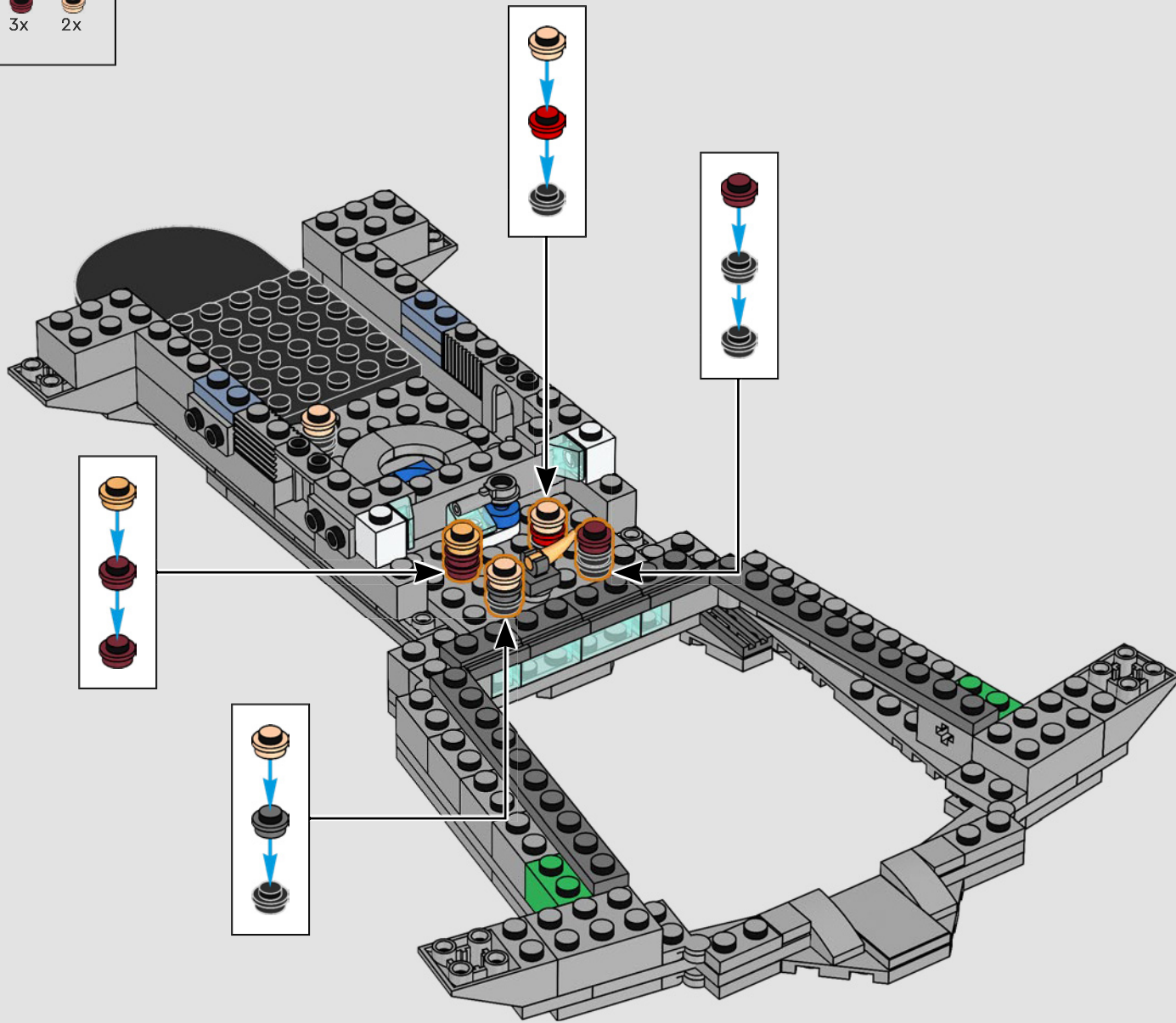

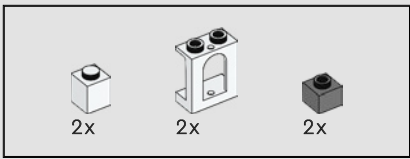

44

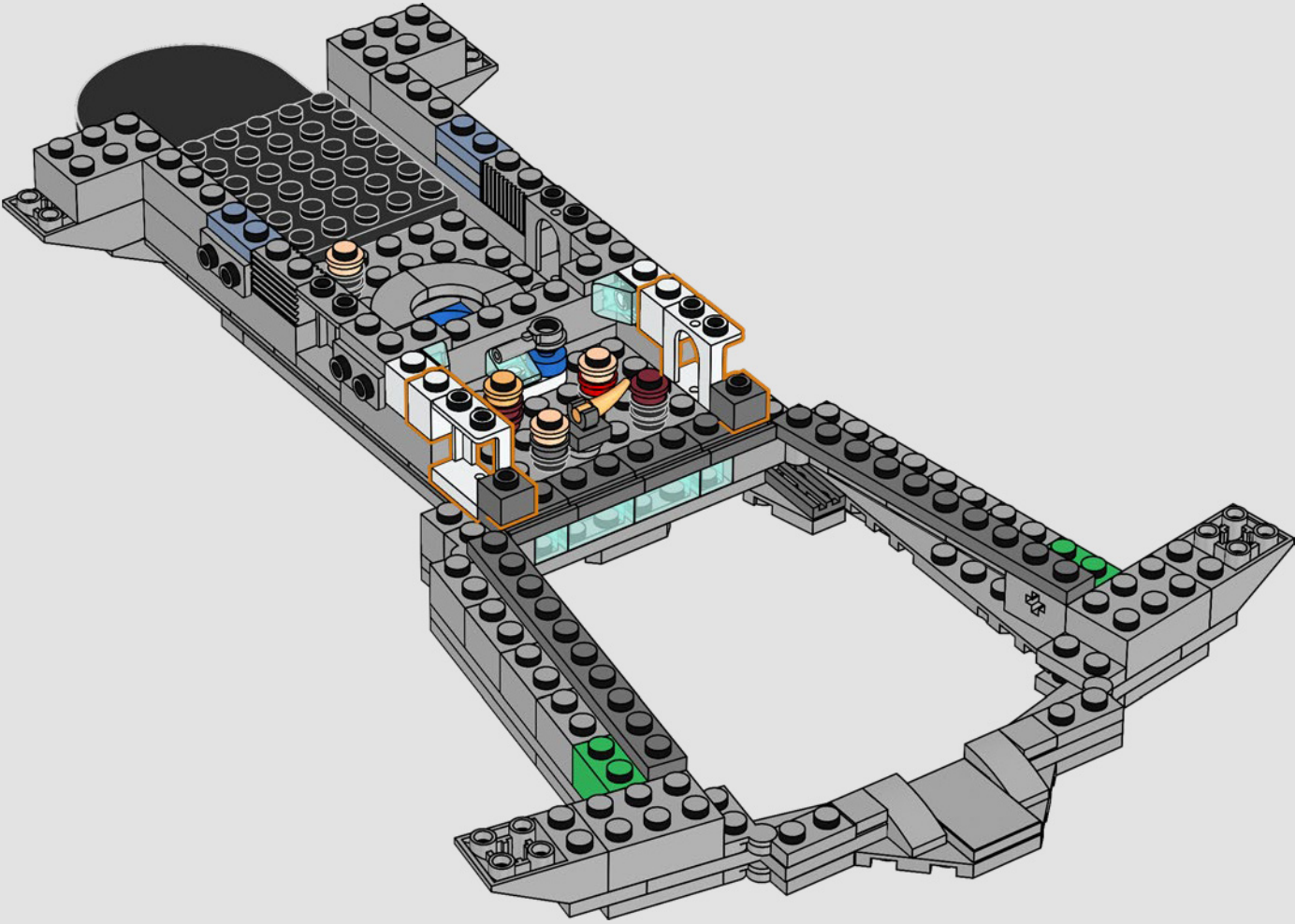

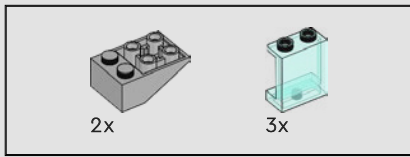

45

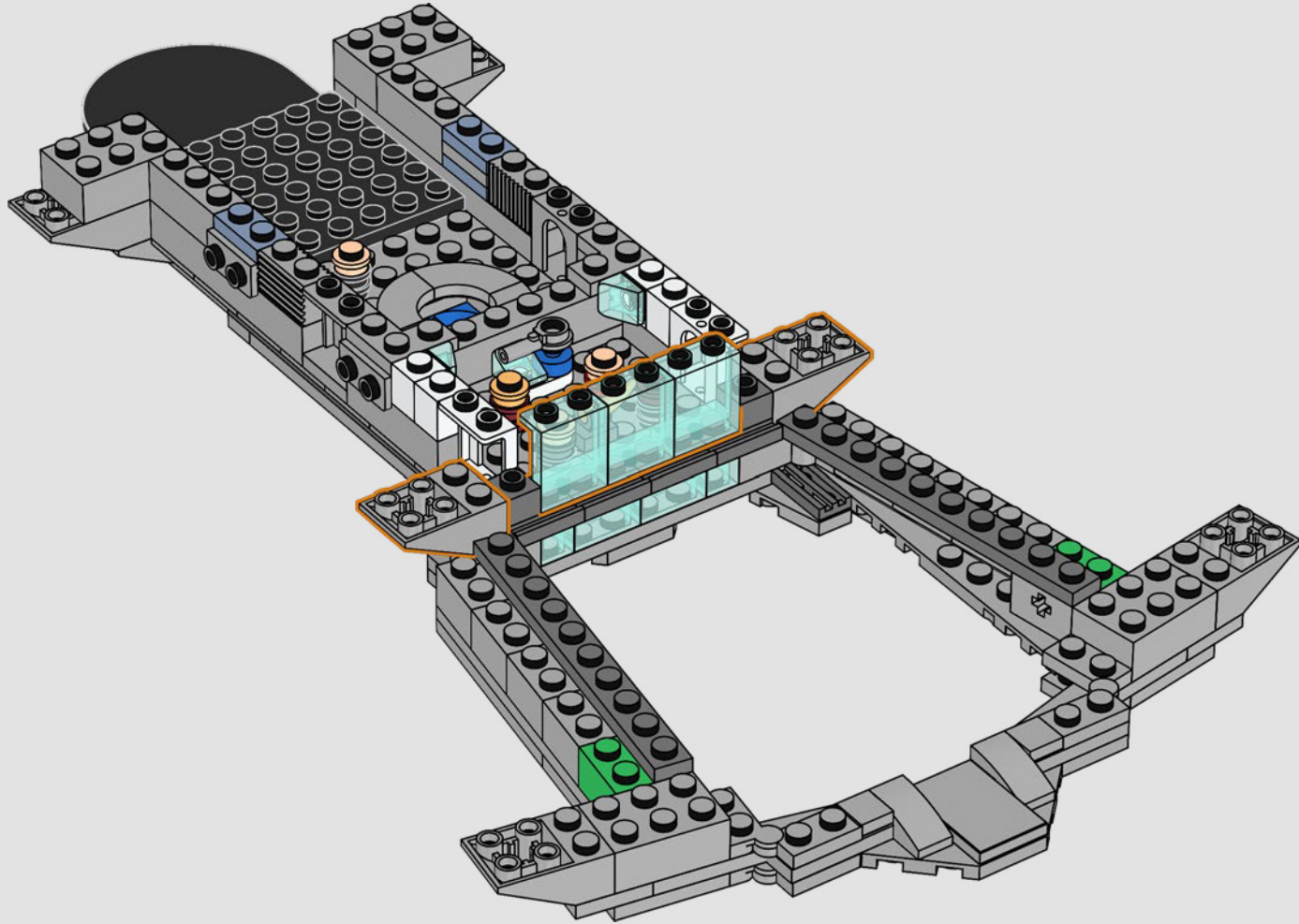

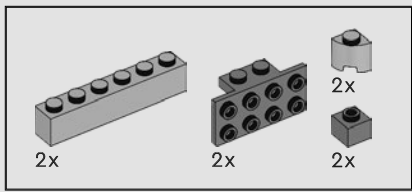

46

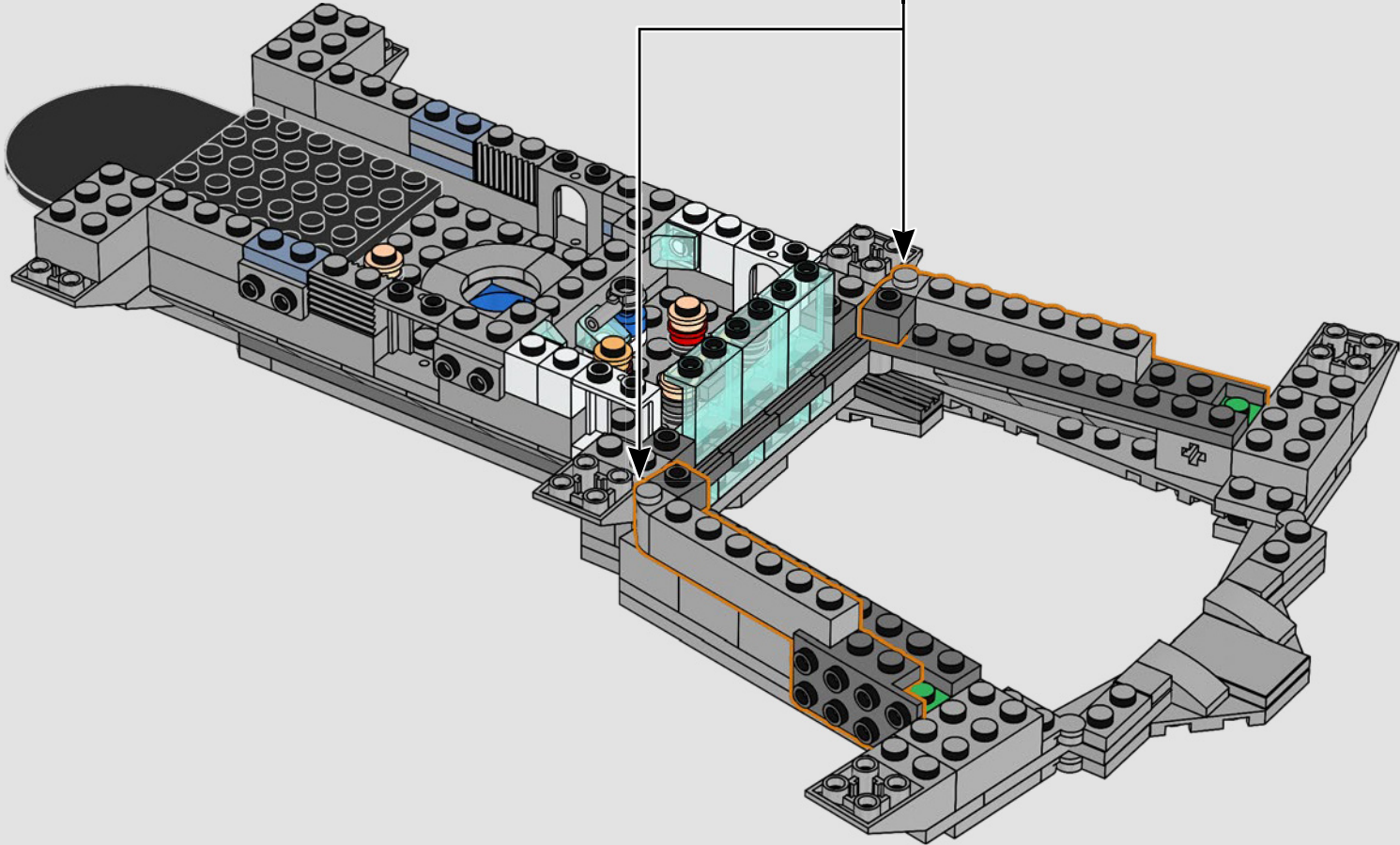
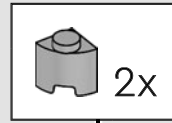

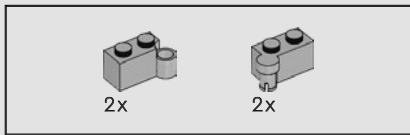

47

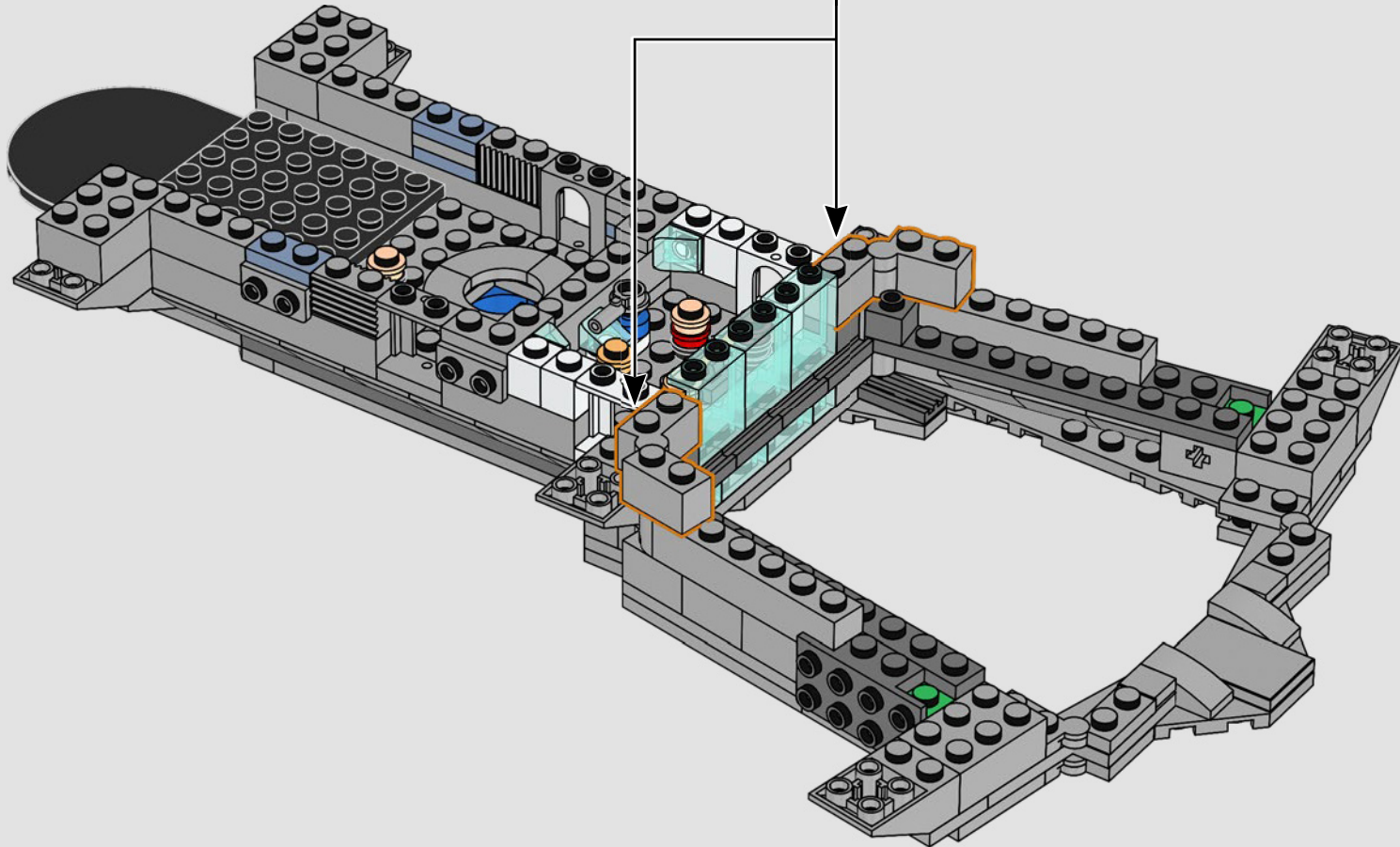
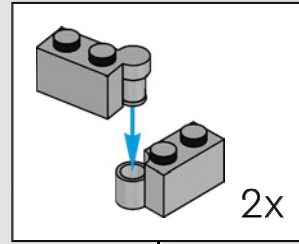



2x

48

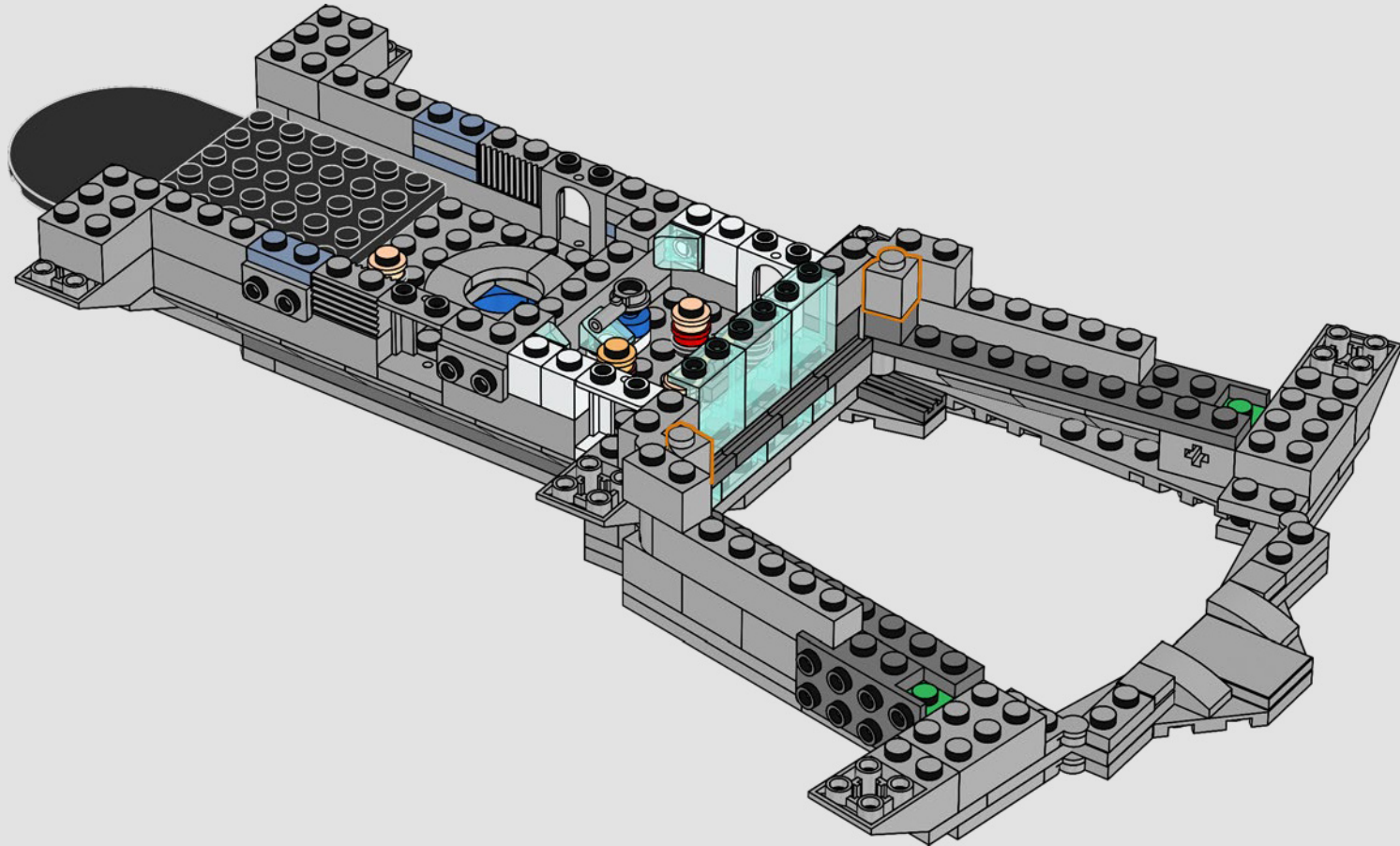

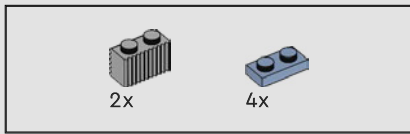

49

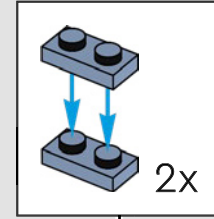
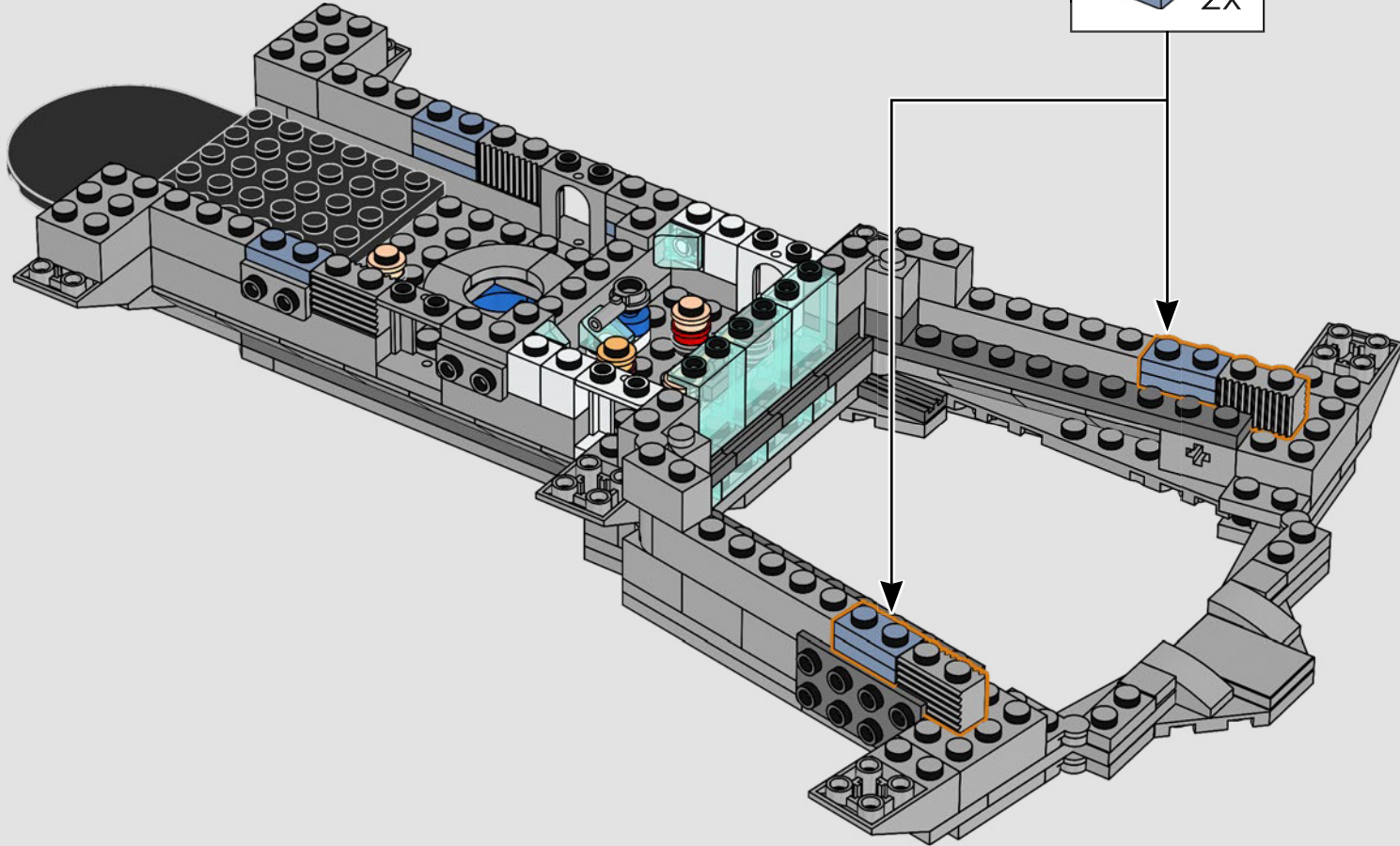

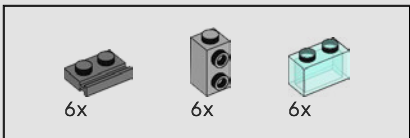

50

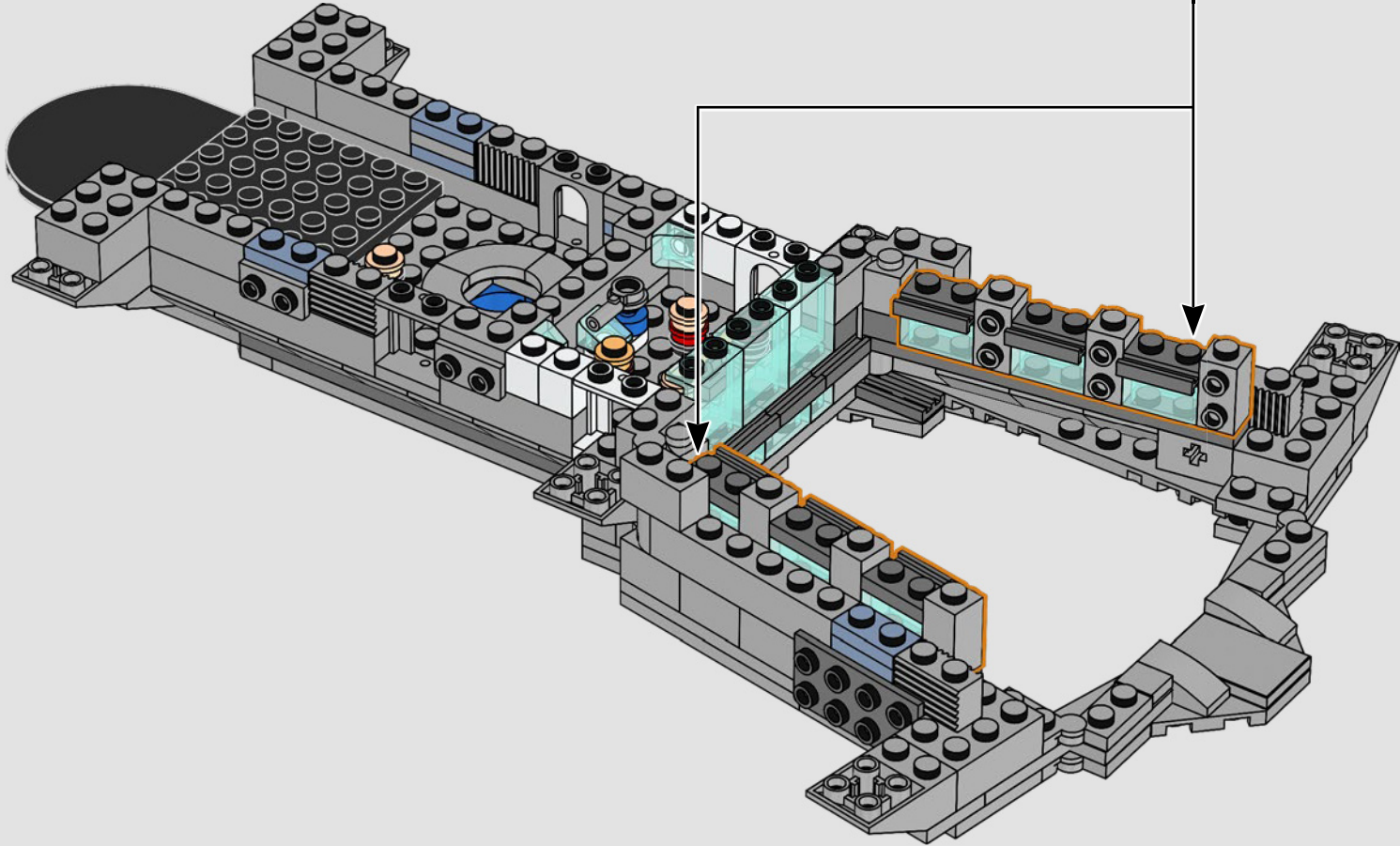
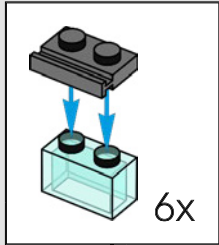

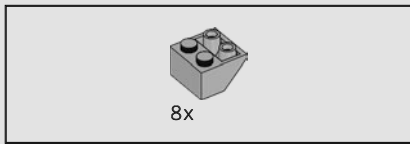

51

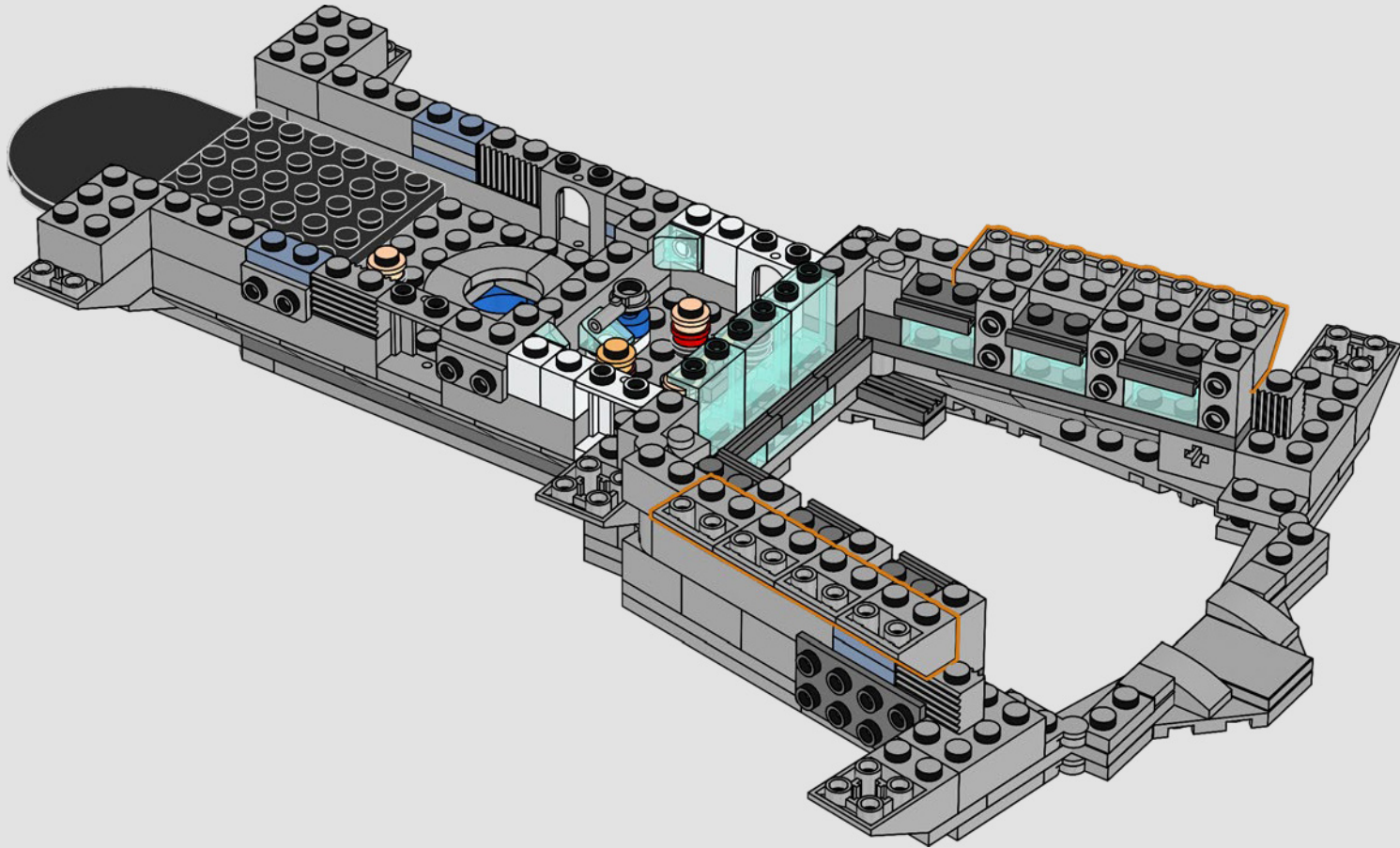

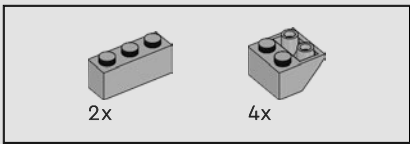

52

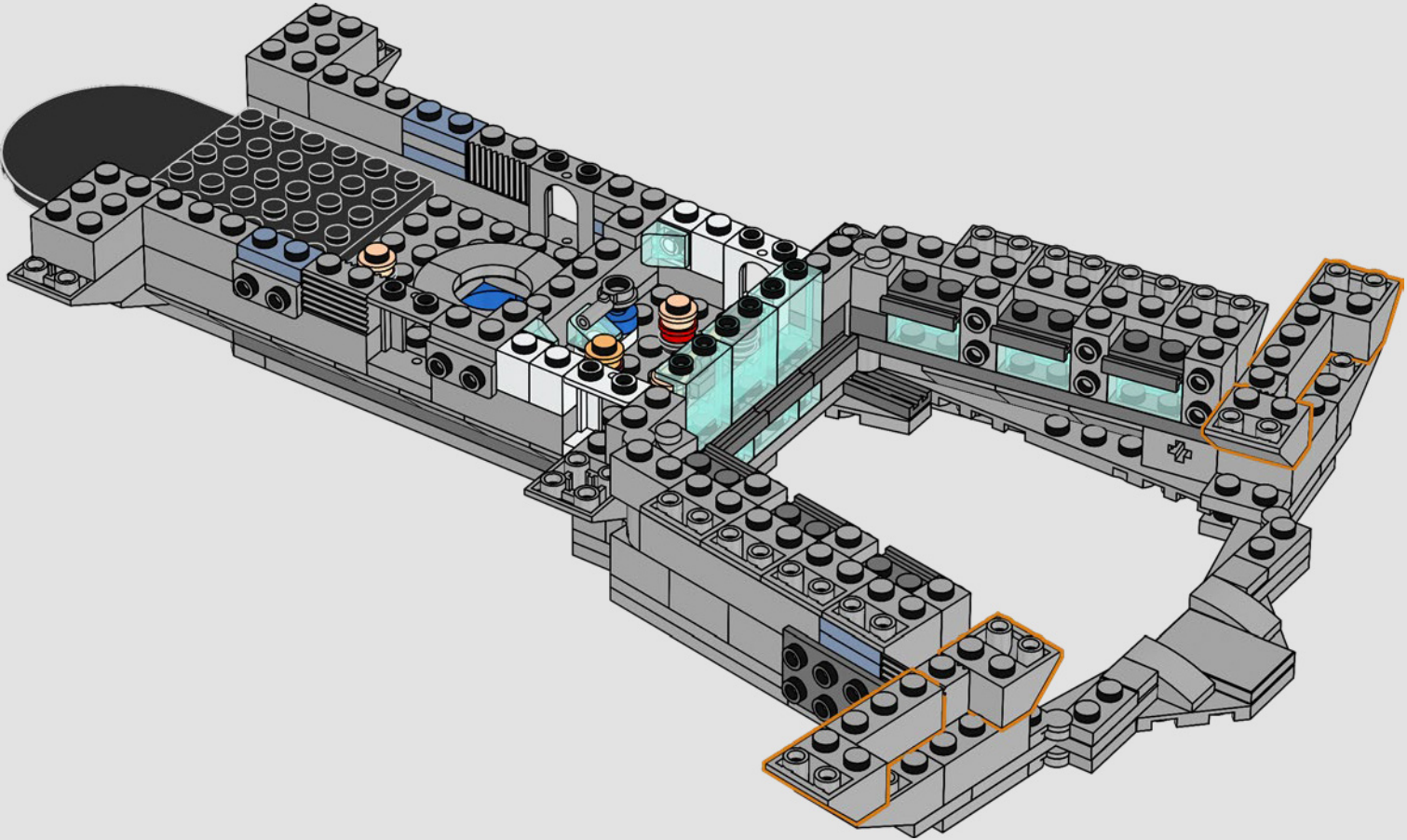

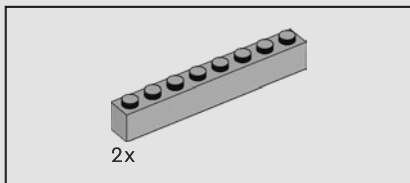

53

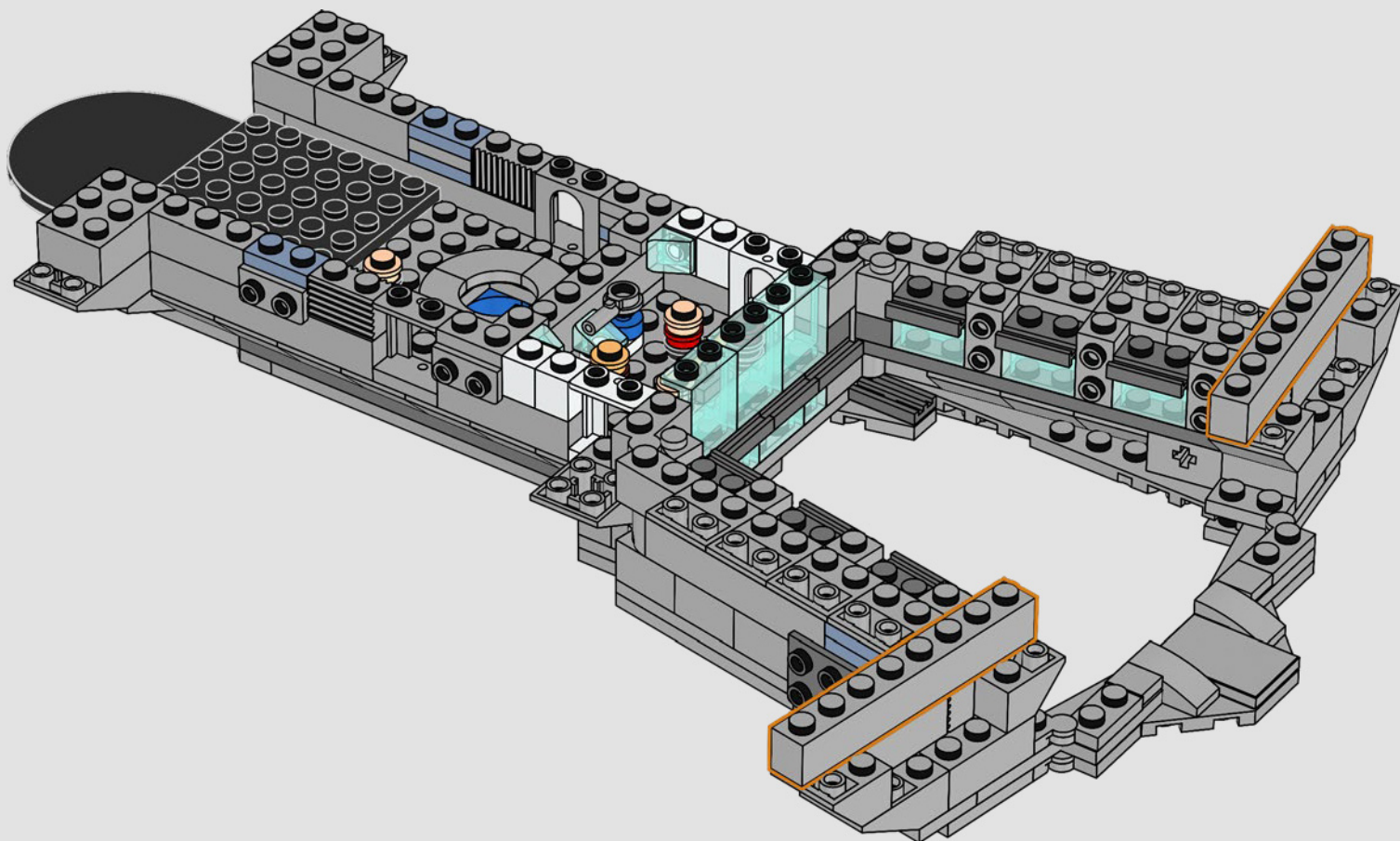

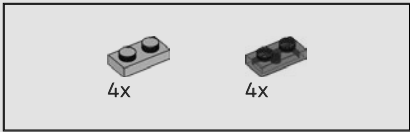

54

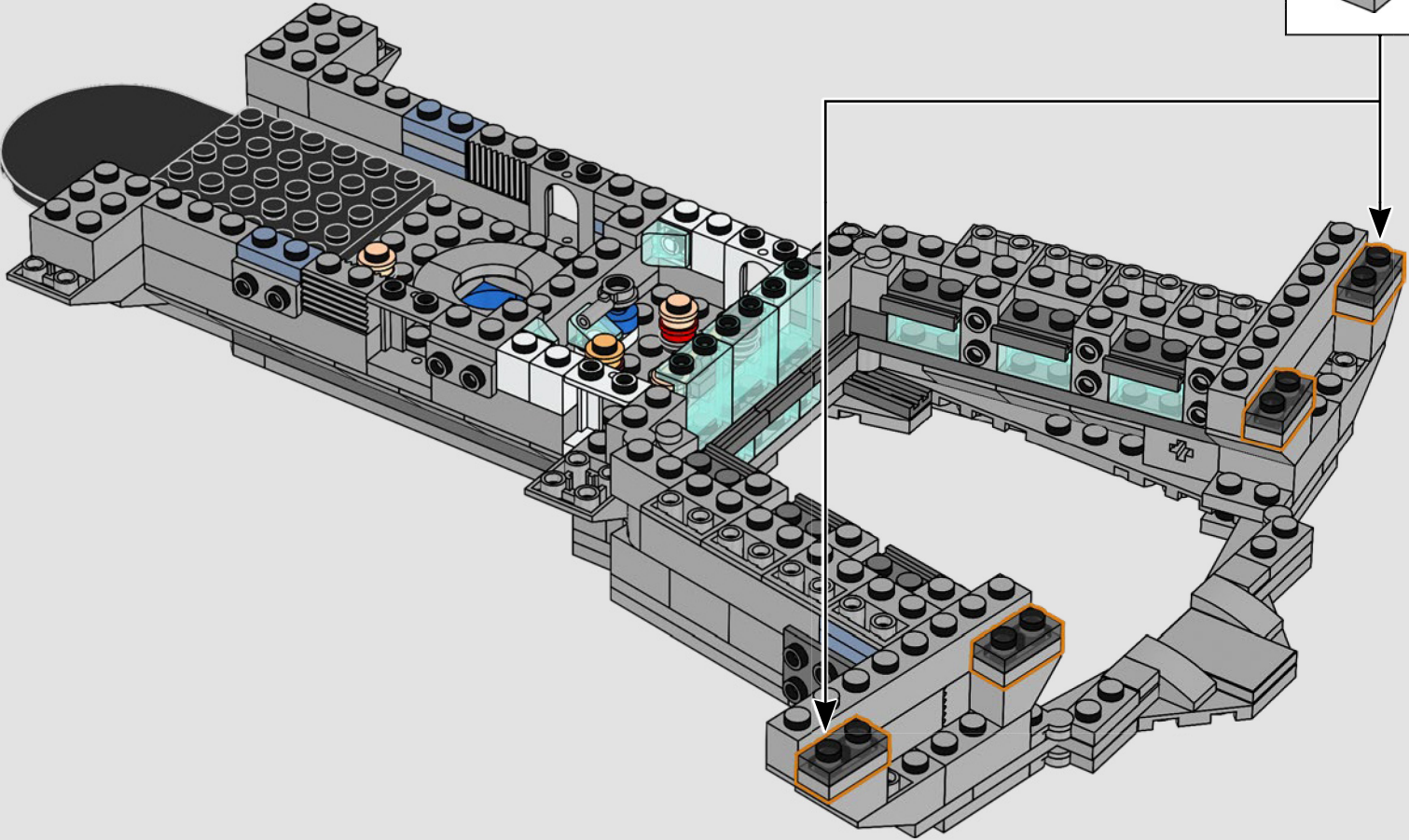
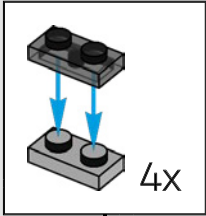

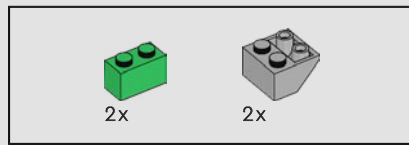

55

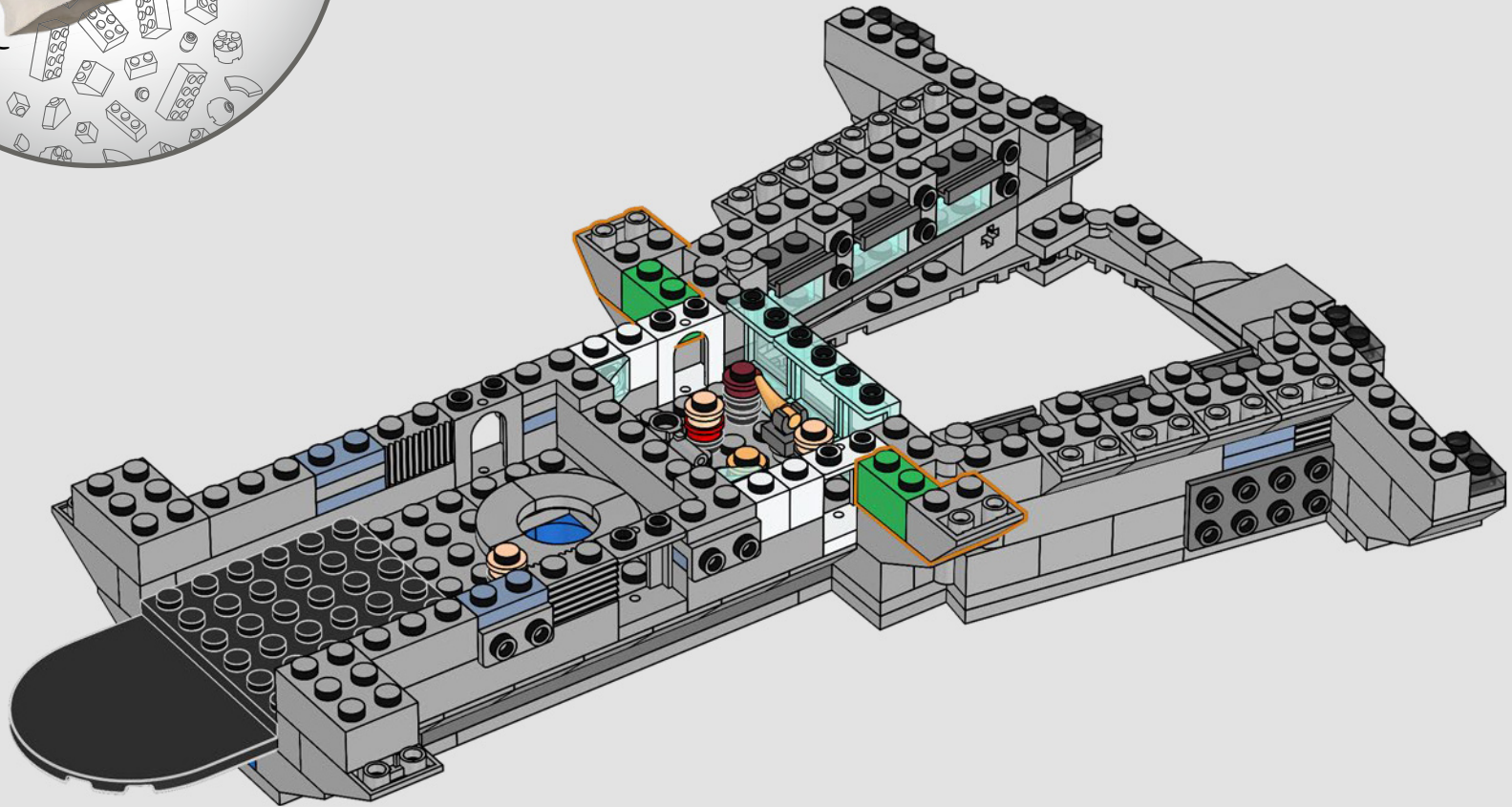

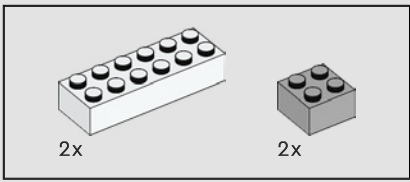

56

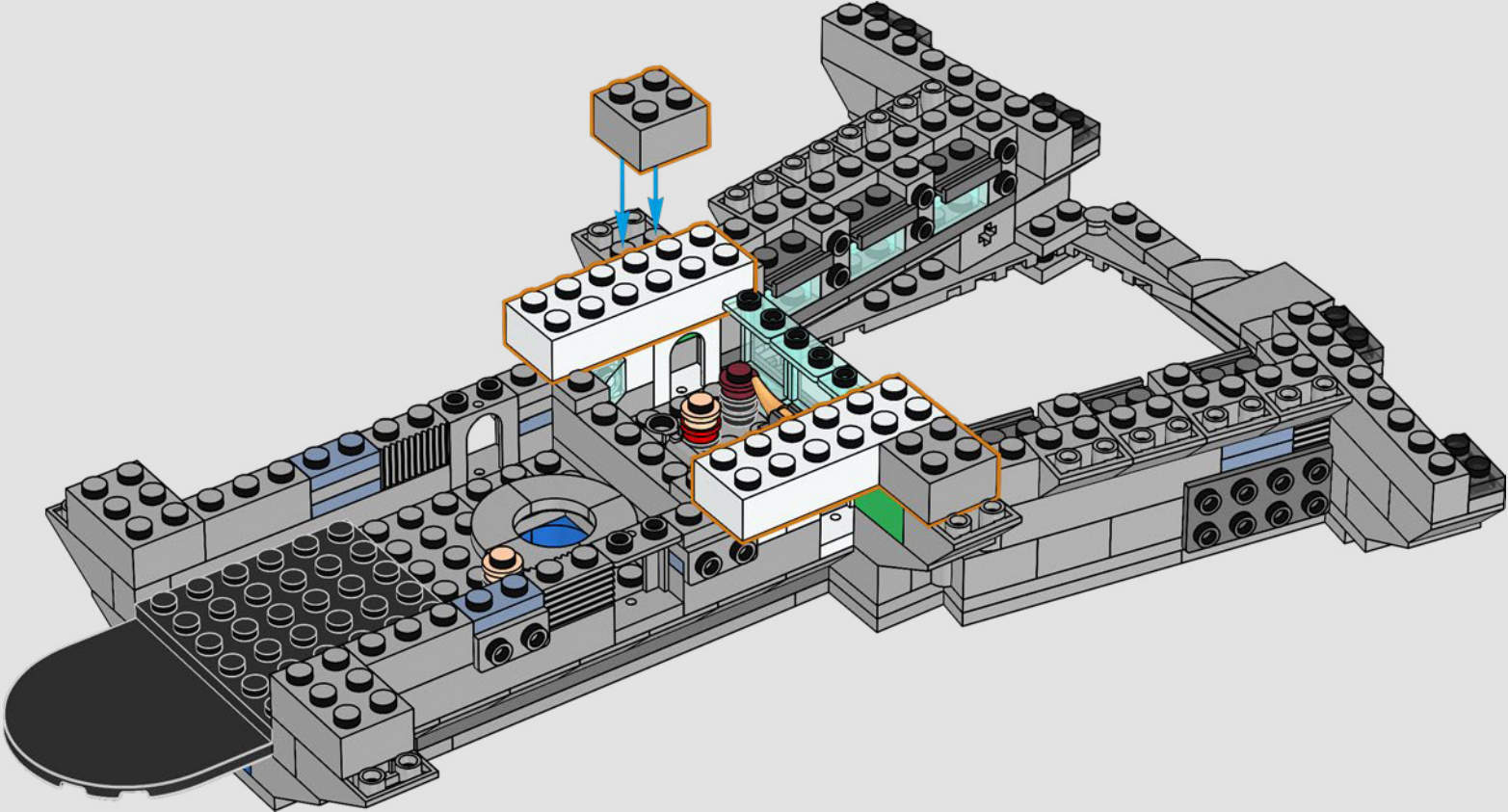

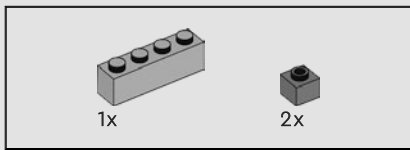

57

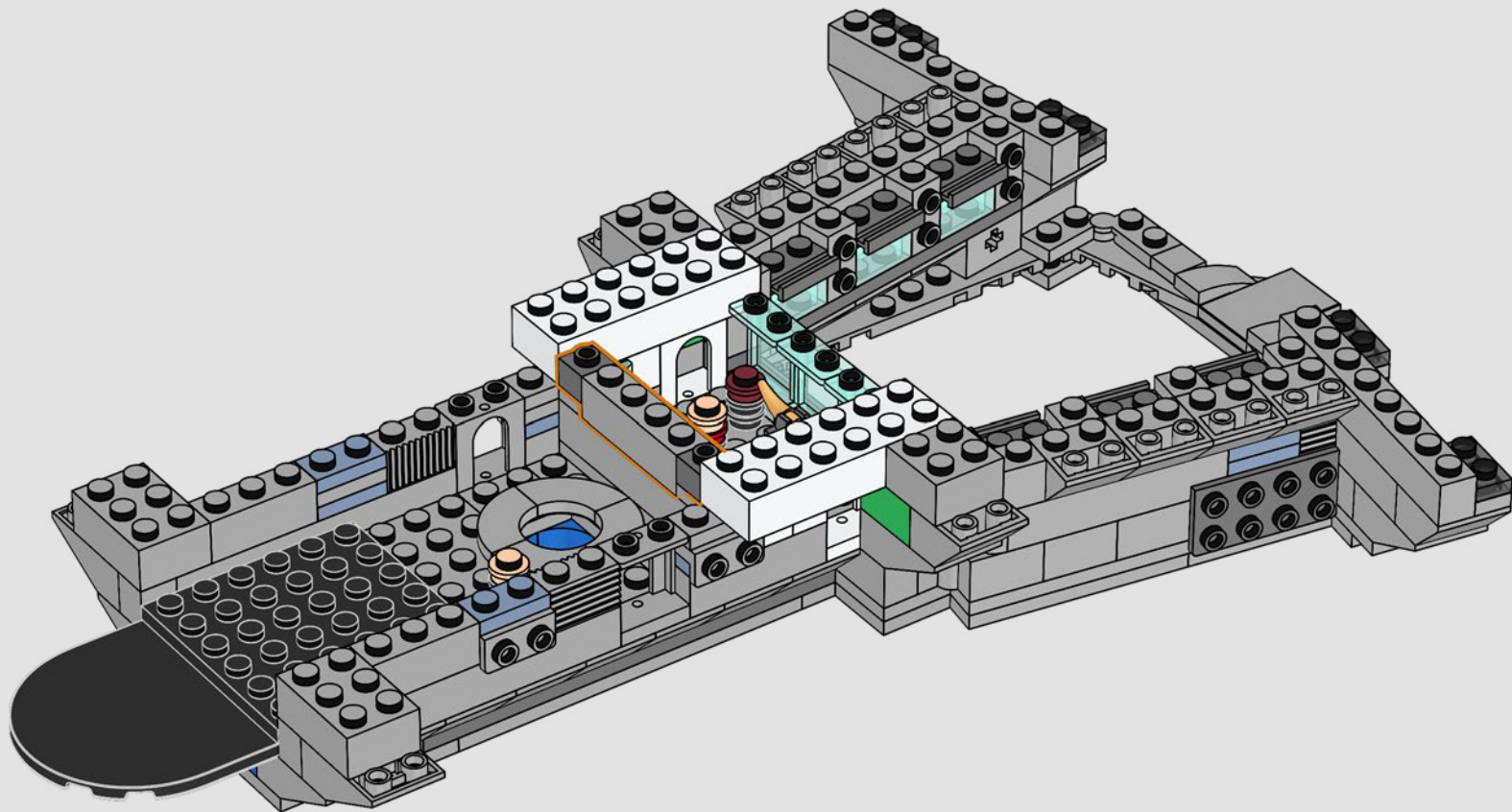



2x

58

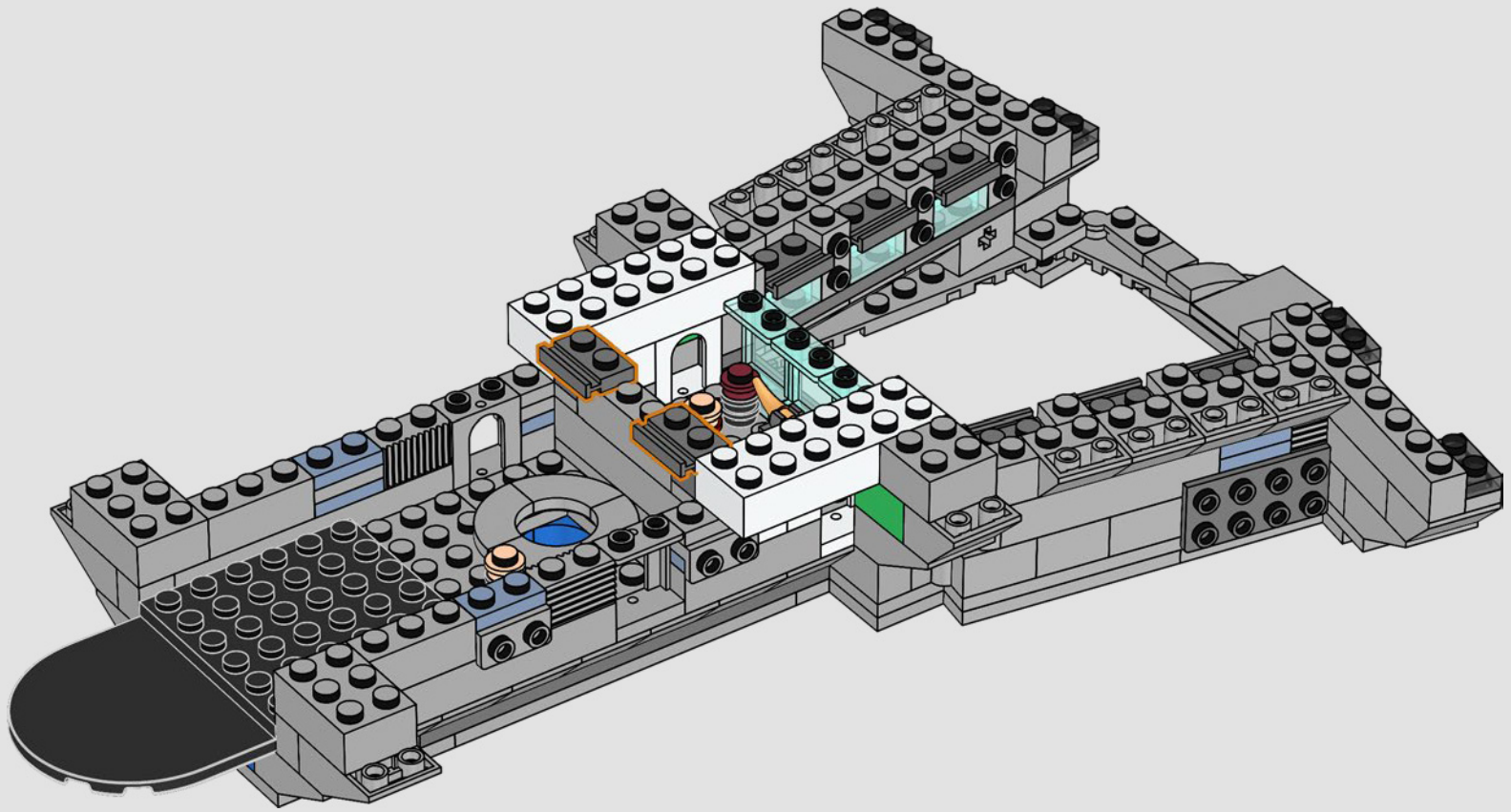

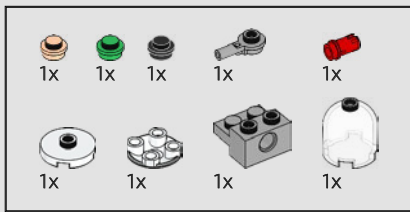

59

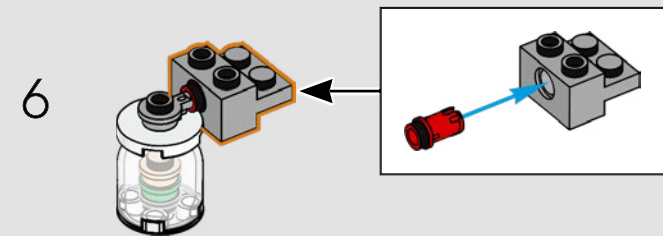
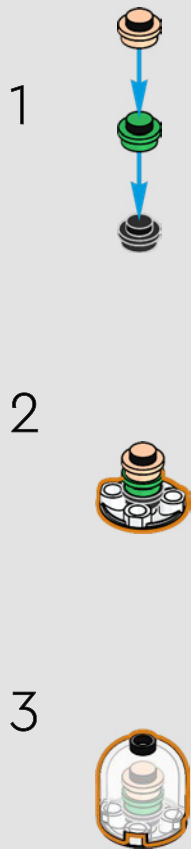

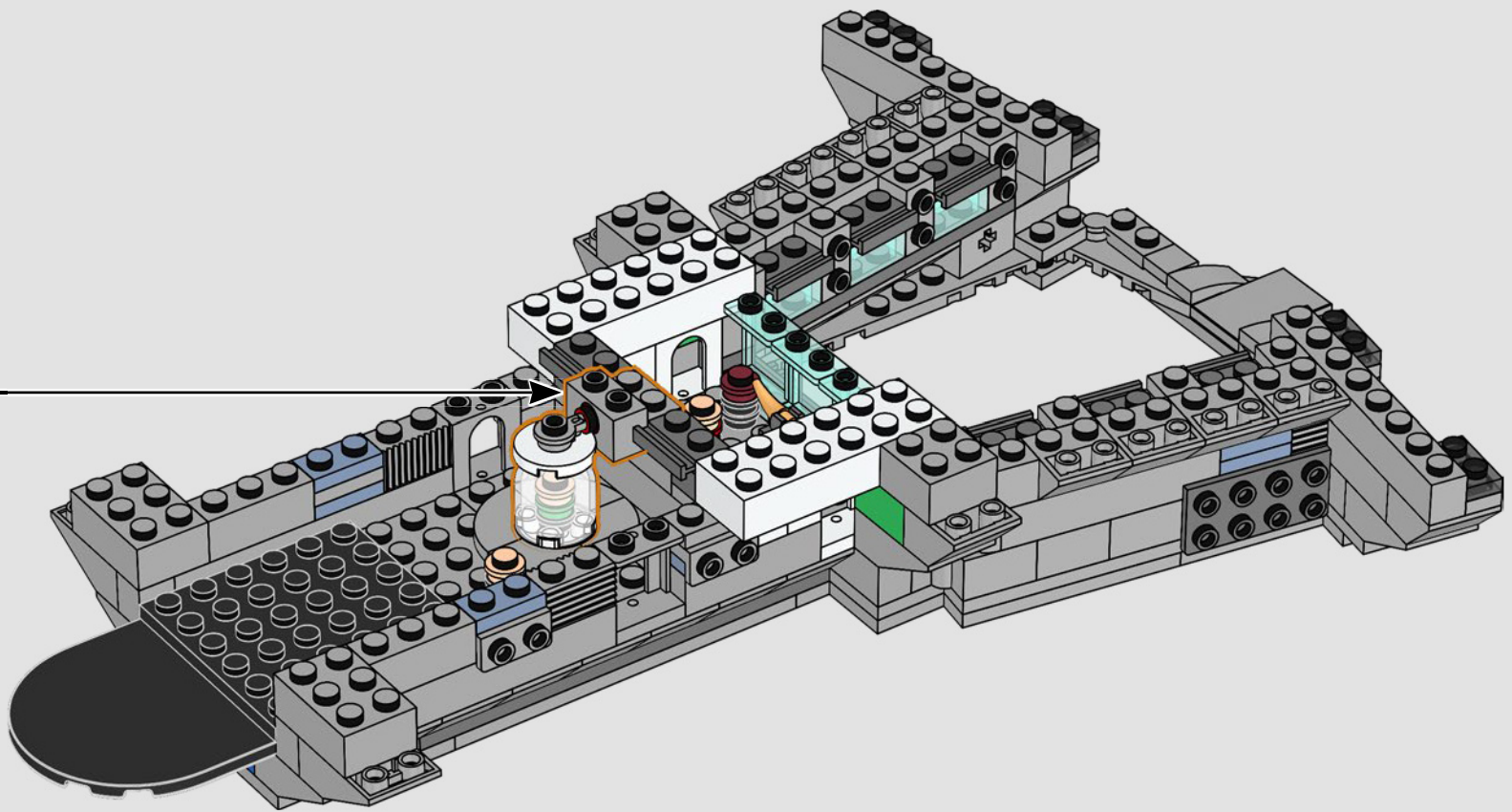

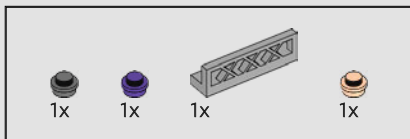

60

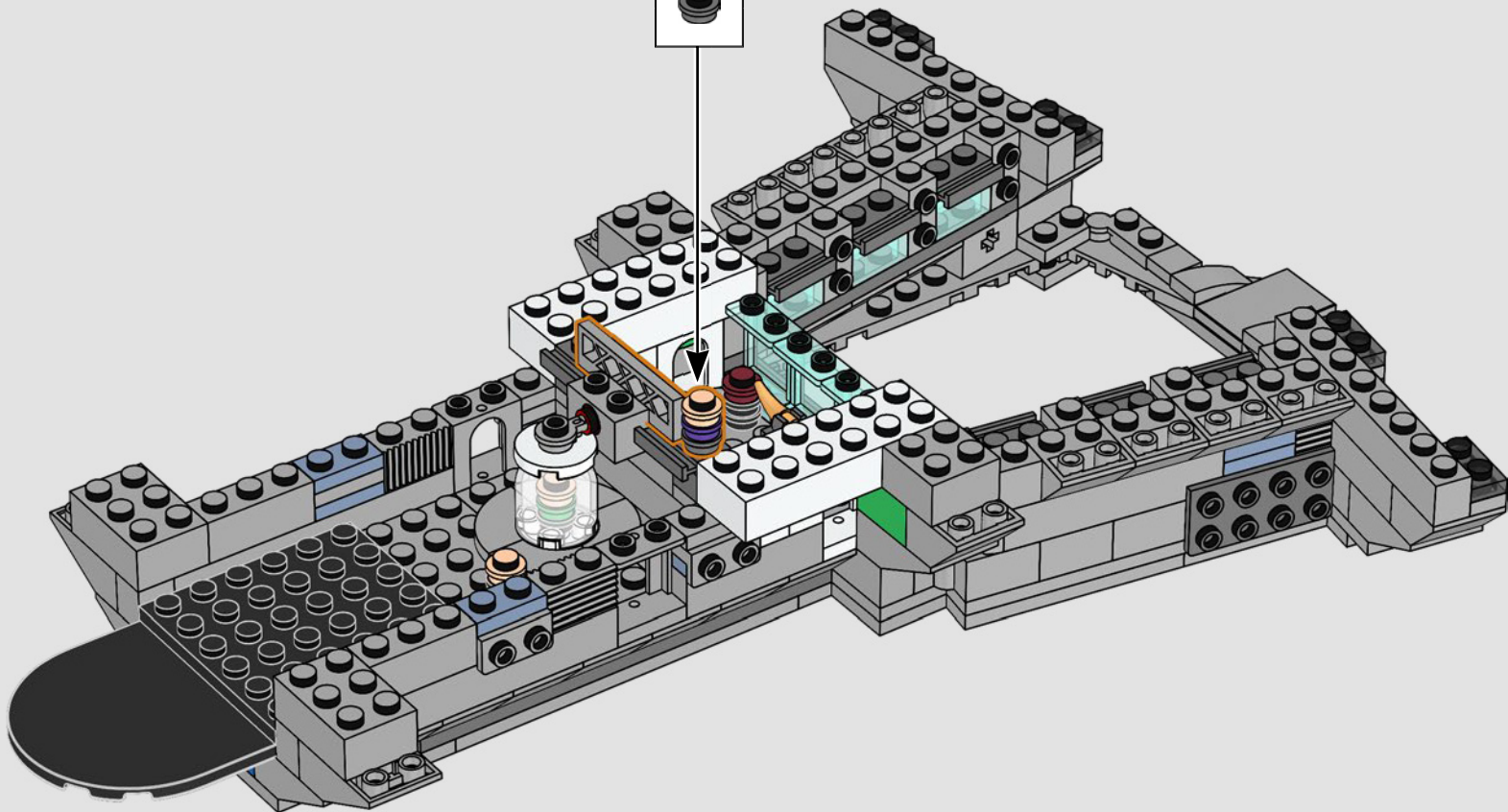
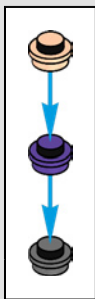

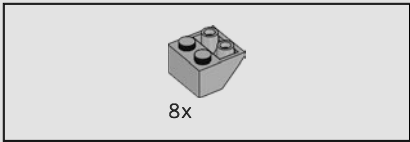

61

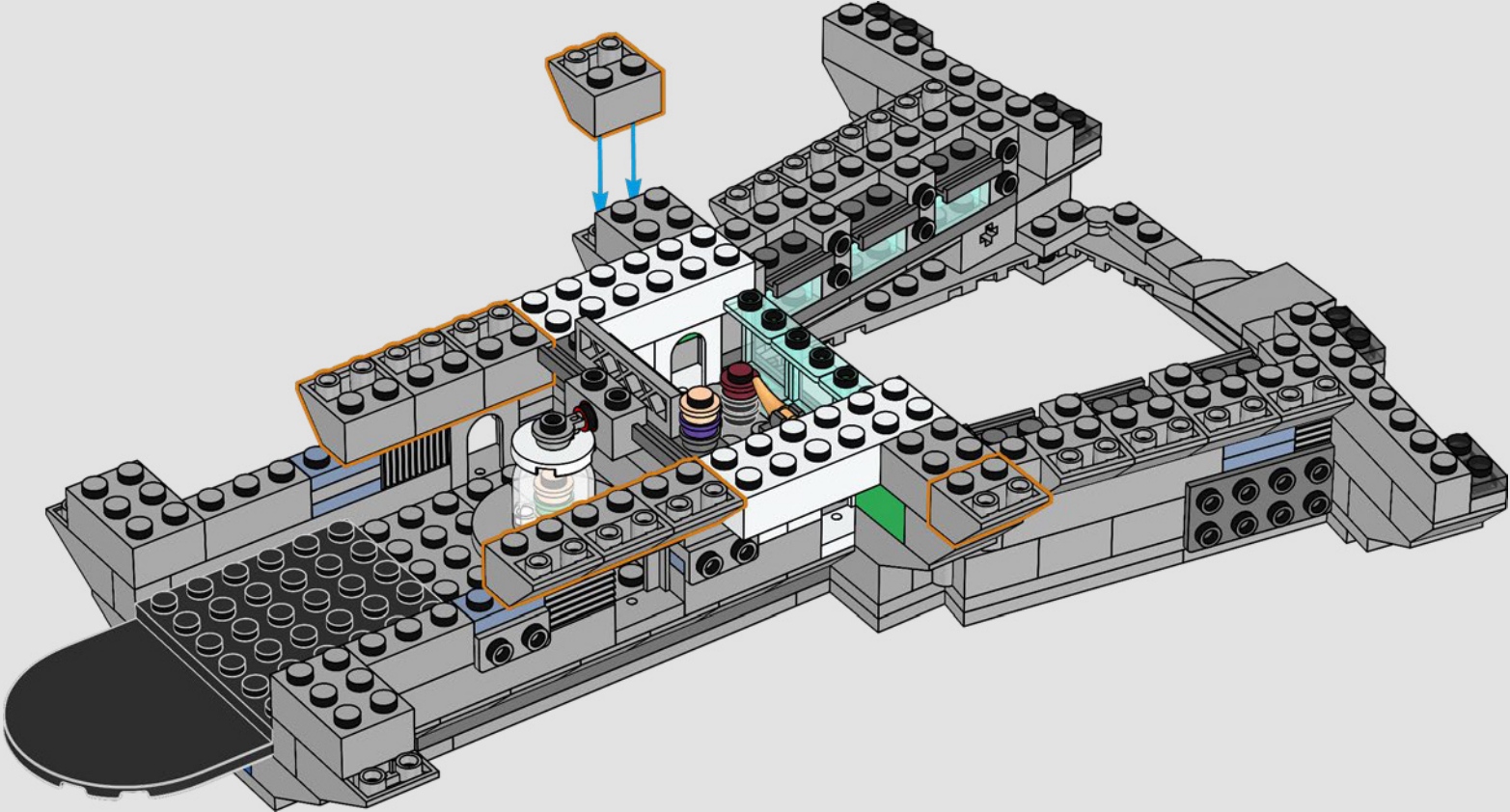

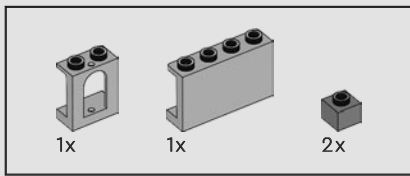

62

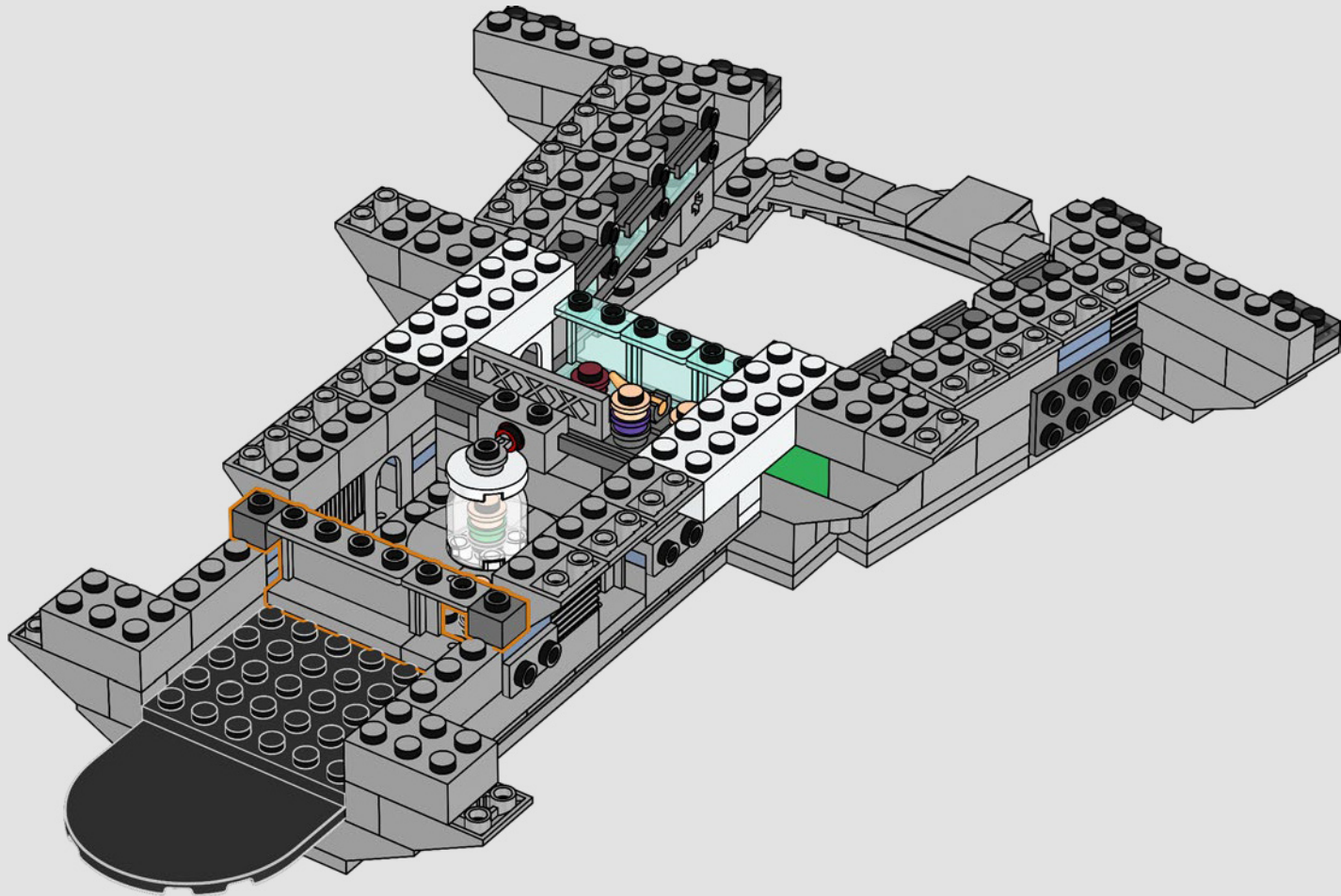

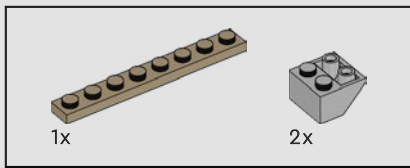

63

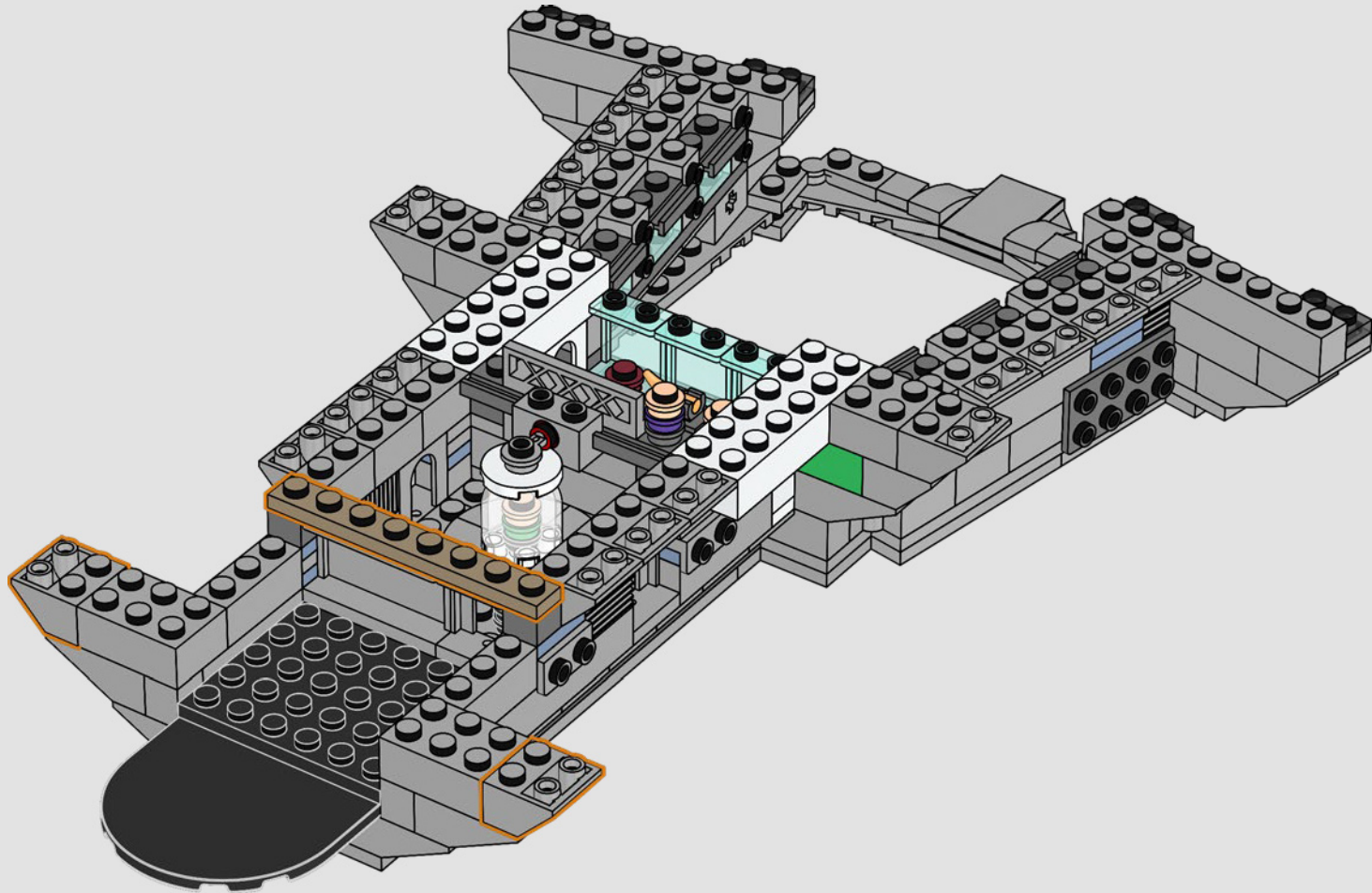

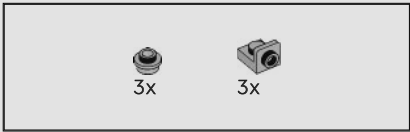

64

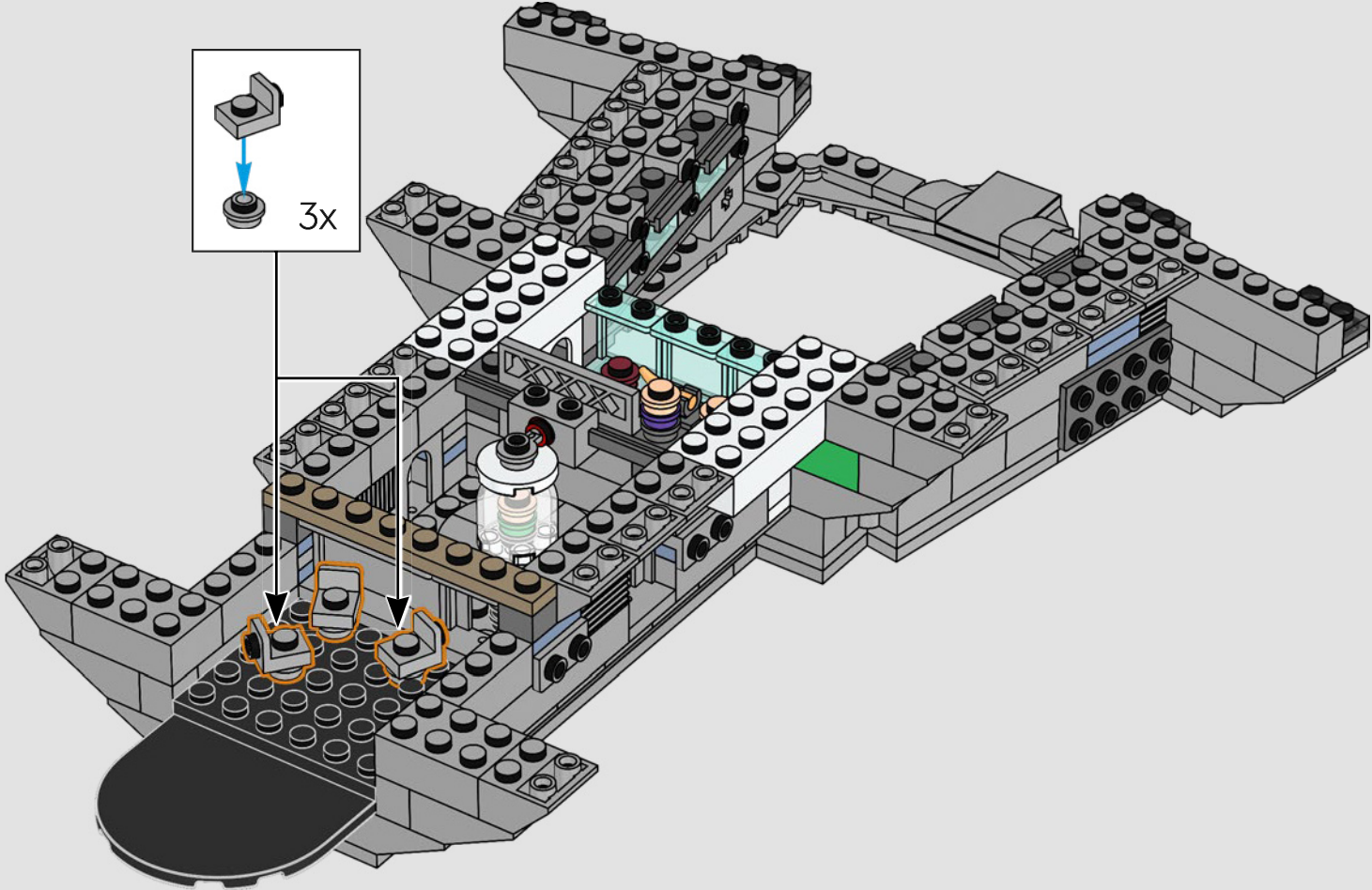

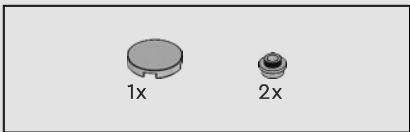

65

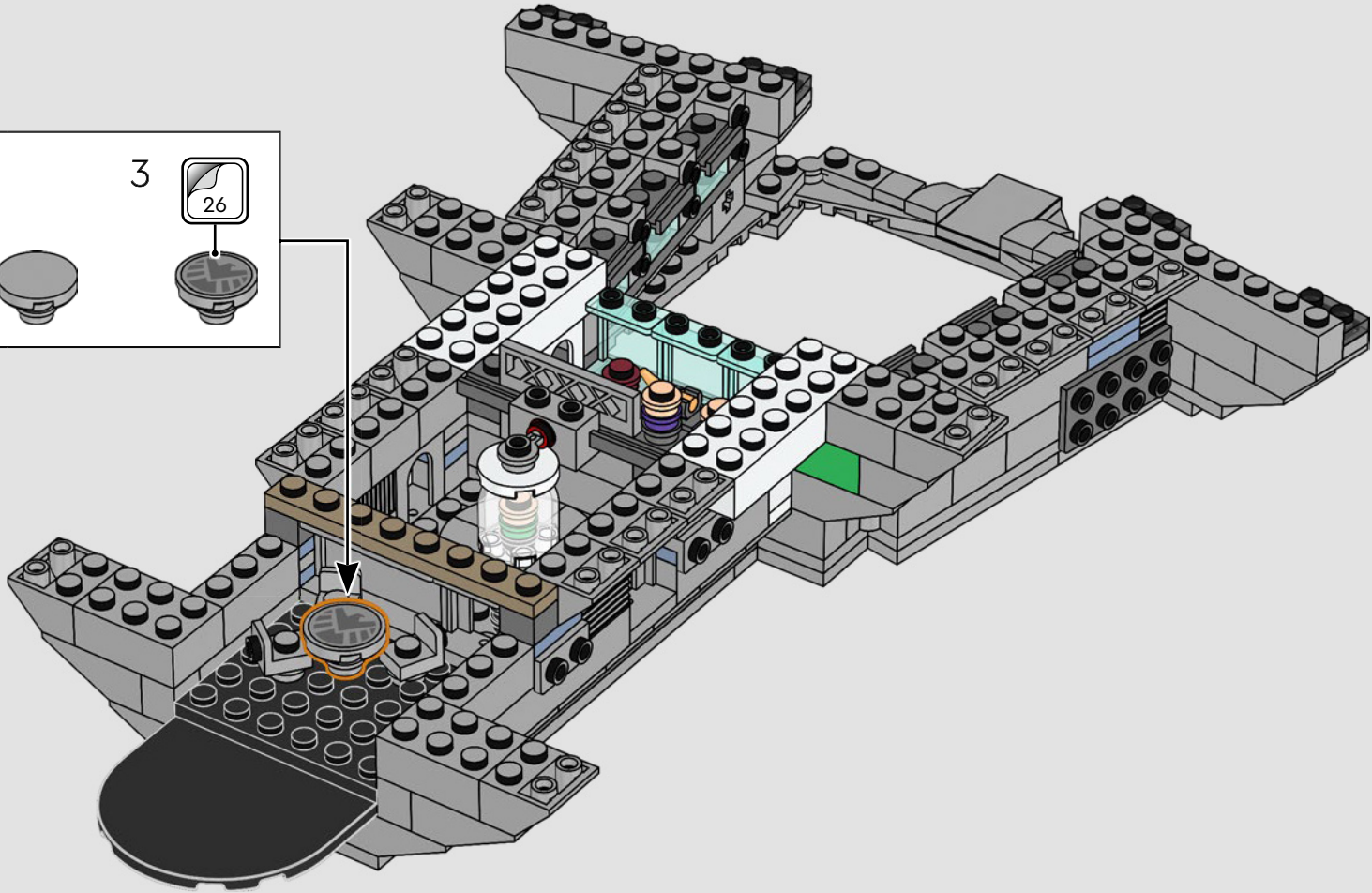
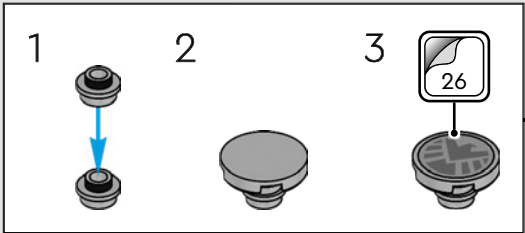

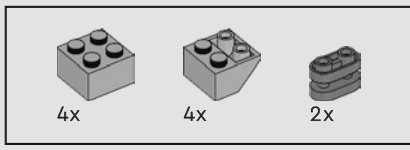

66

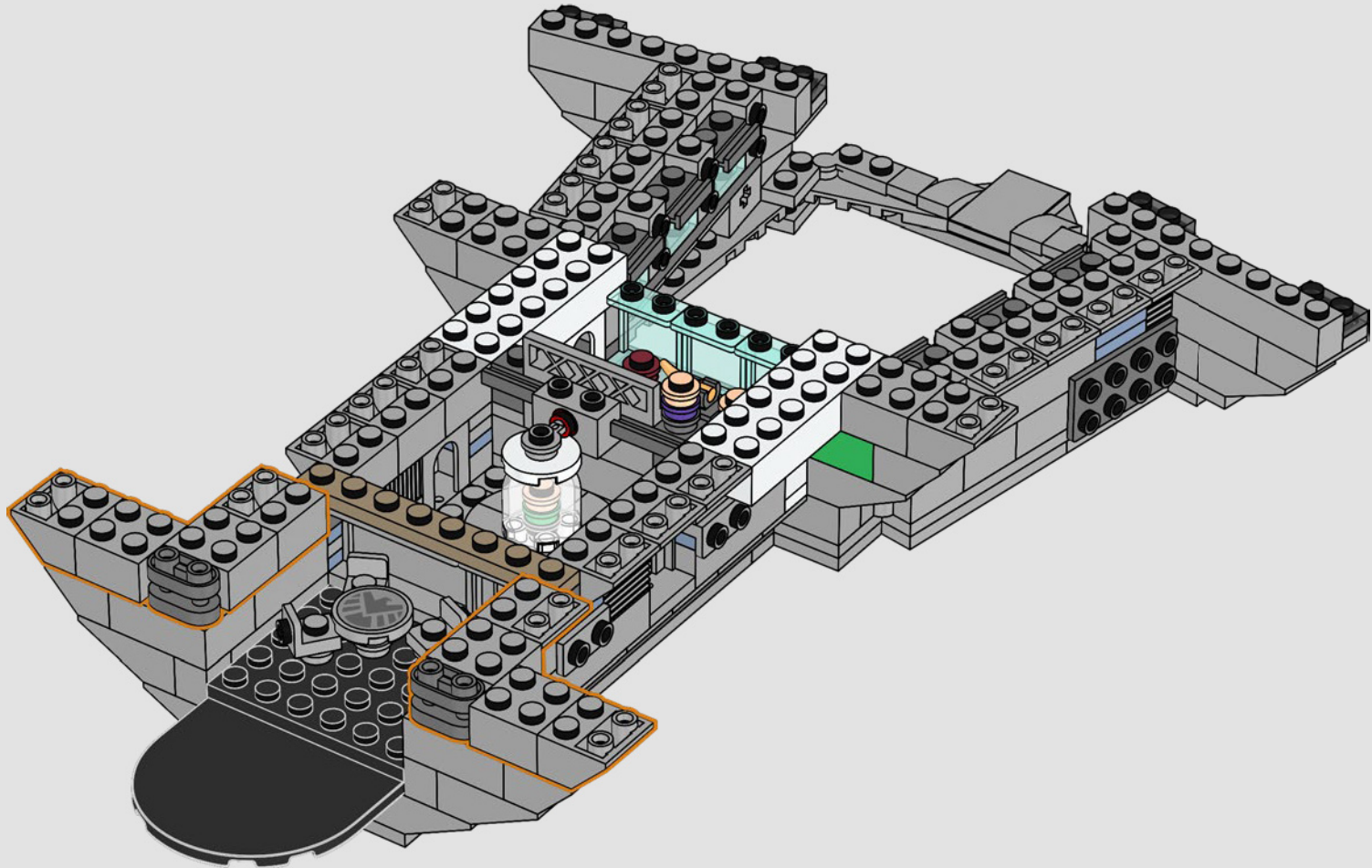

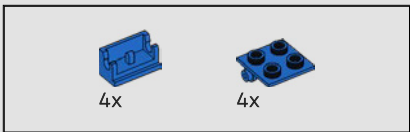

67

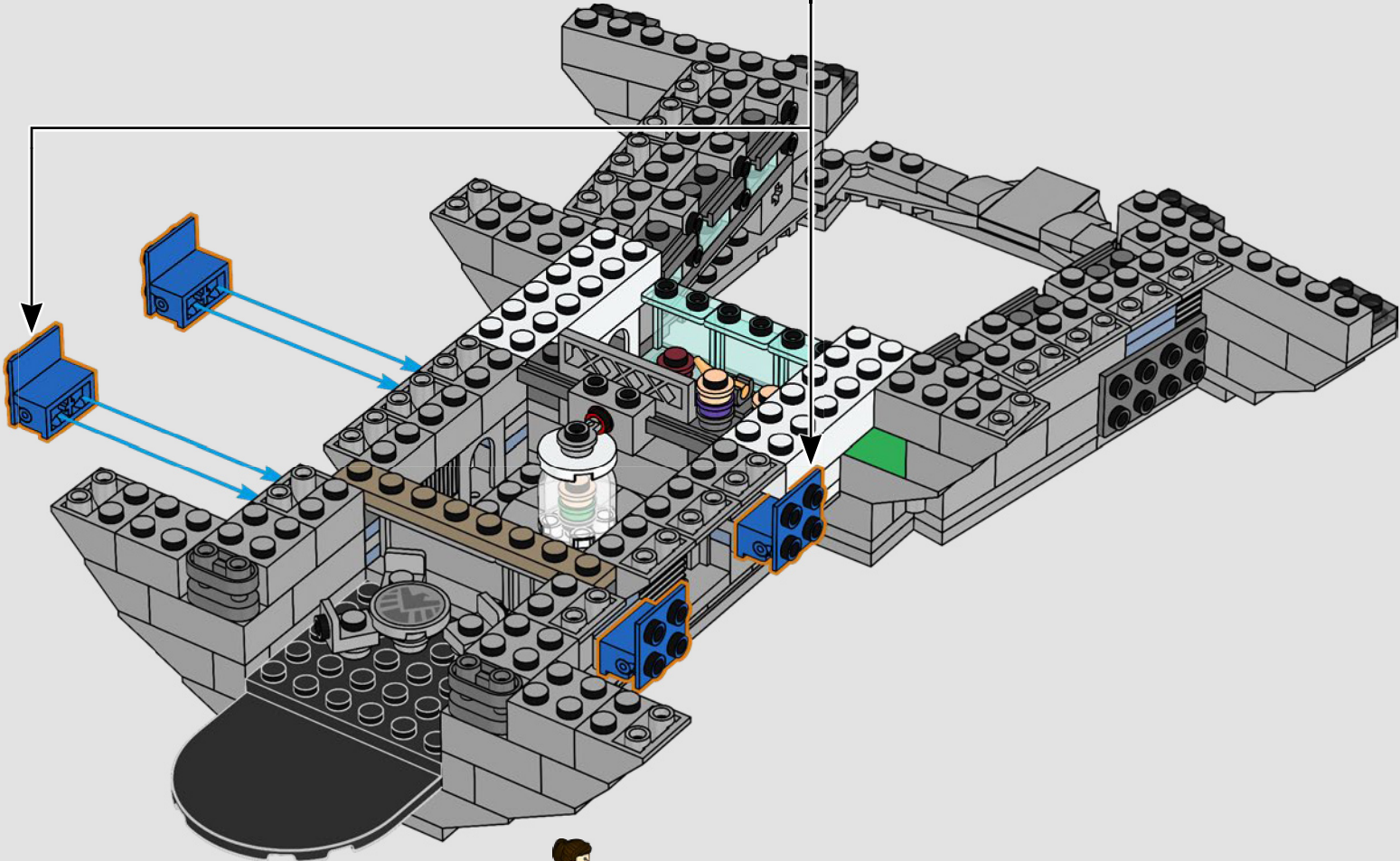
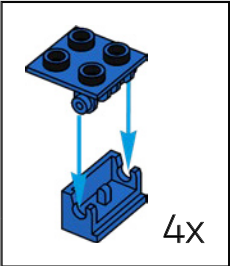

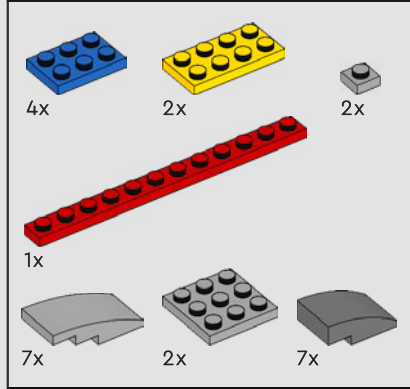
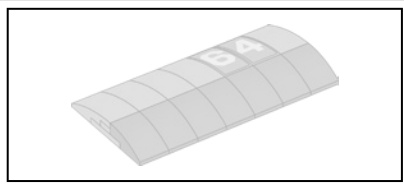

68

1

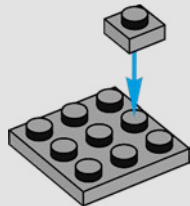

2

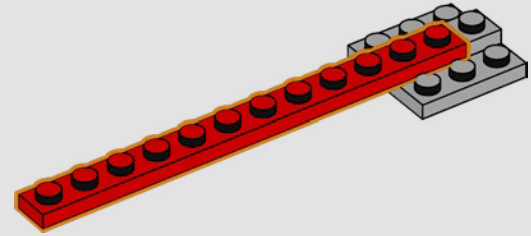

3

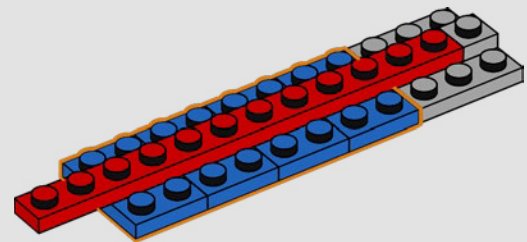

4

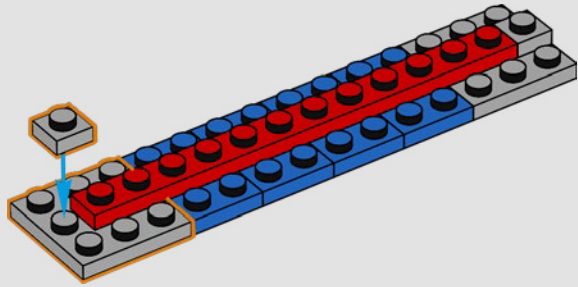

5

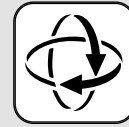
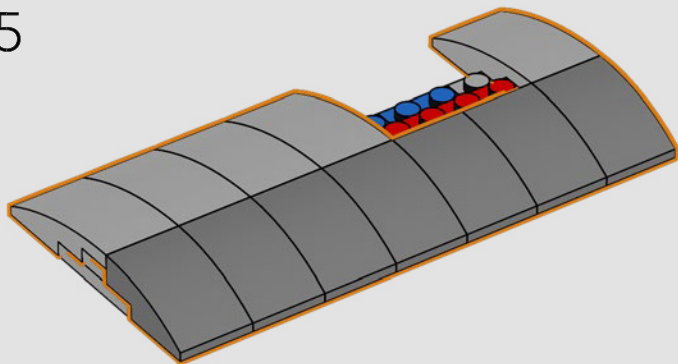

6

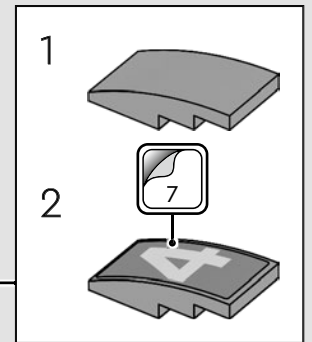
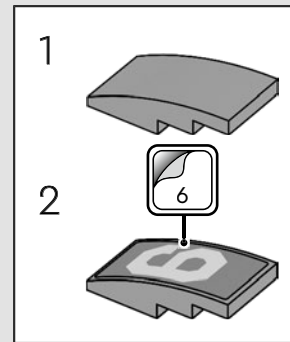
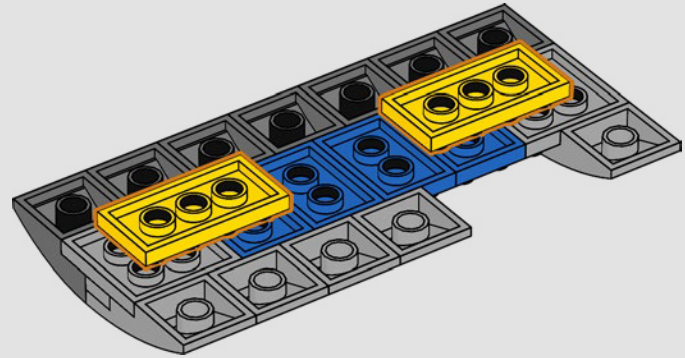

7

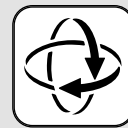
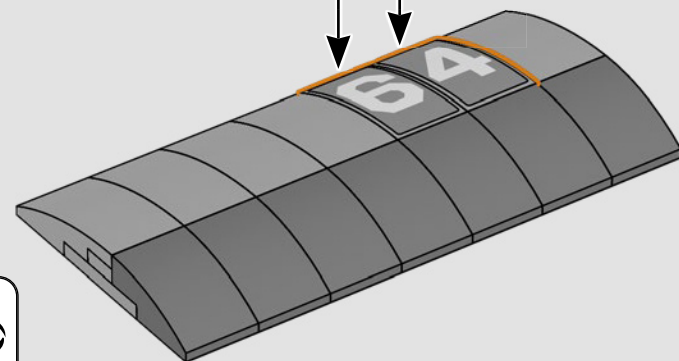

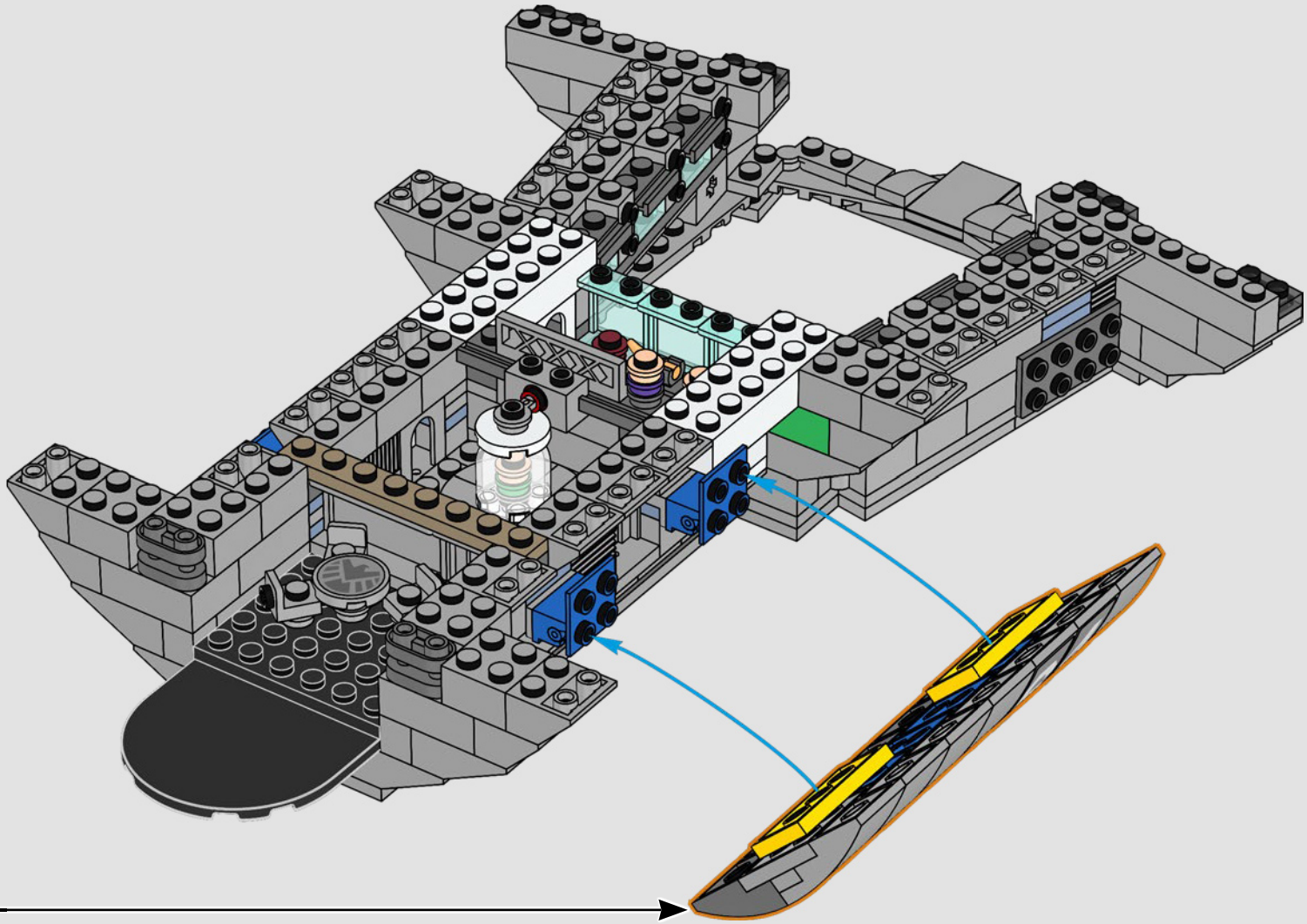

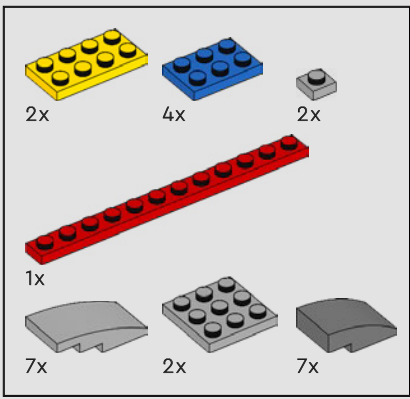

69

1

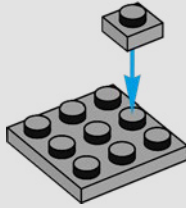

2

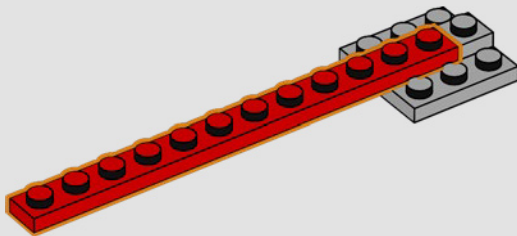

3

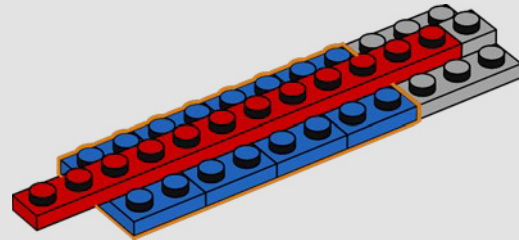

4

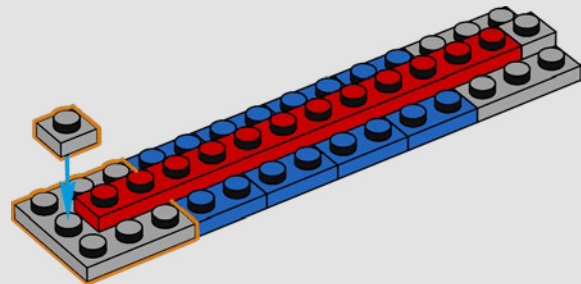

5

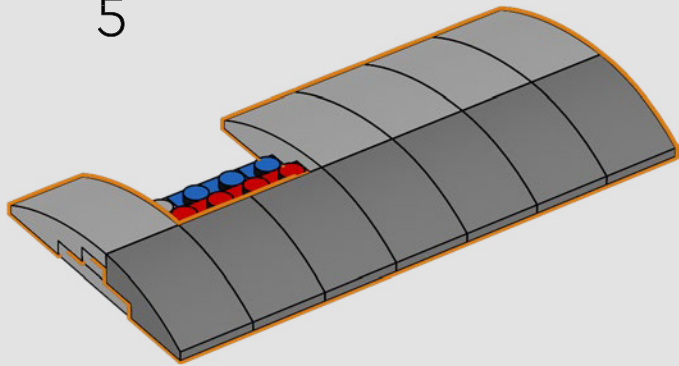

6

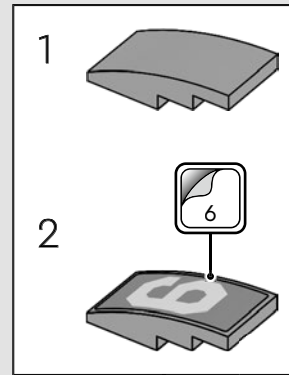
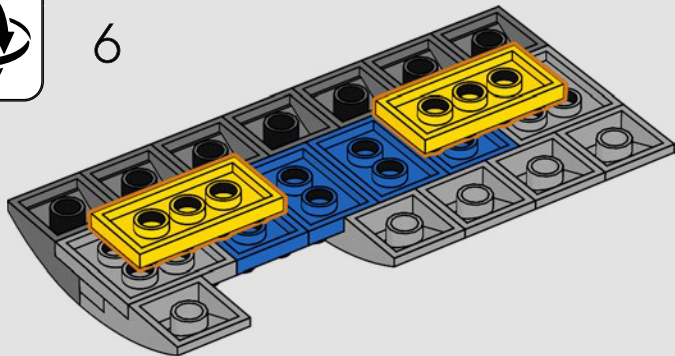

2

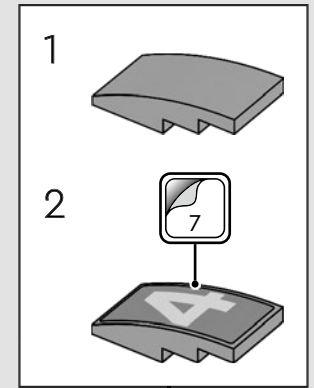

2

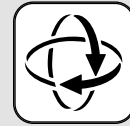

7

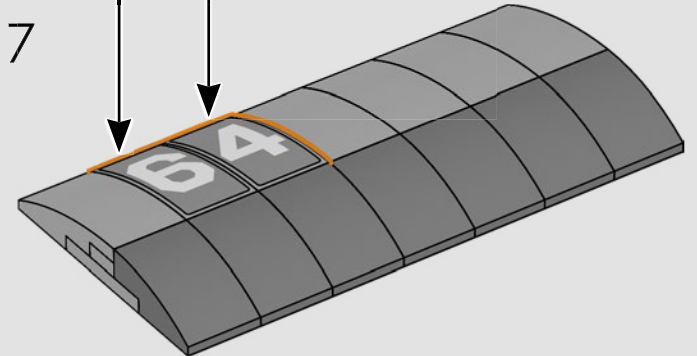

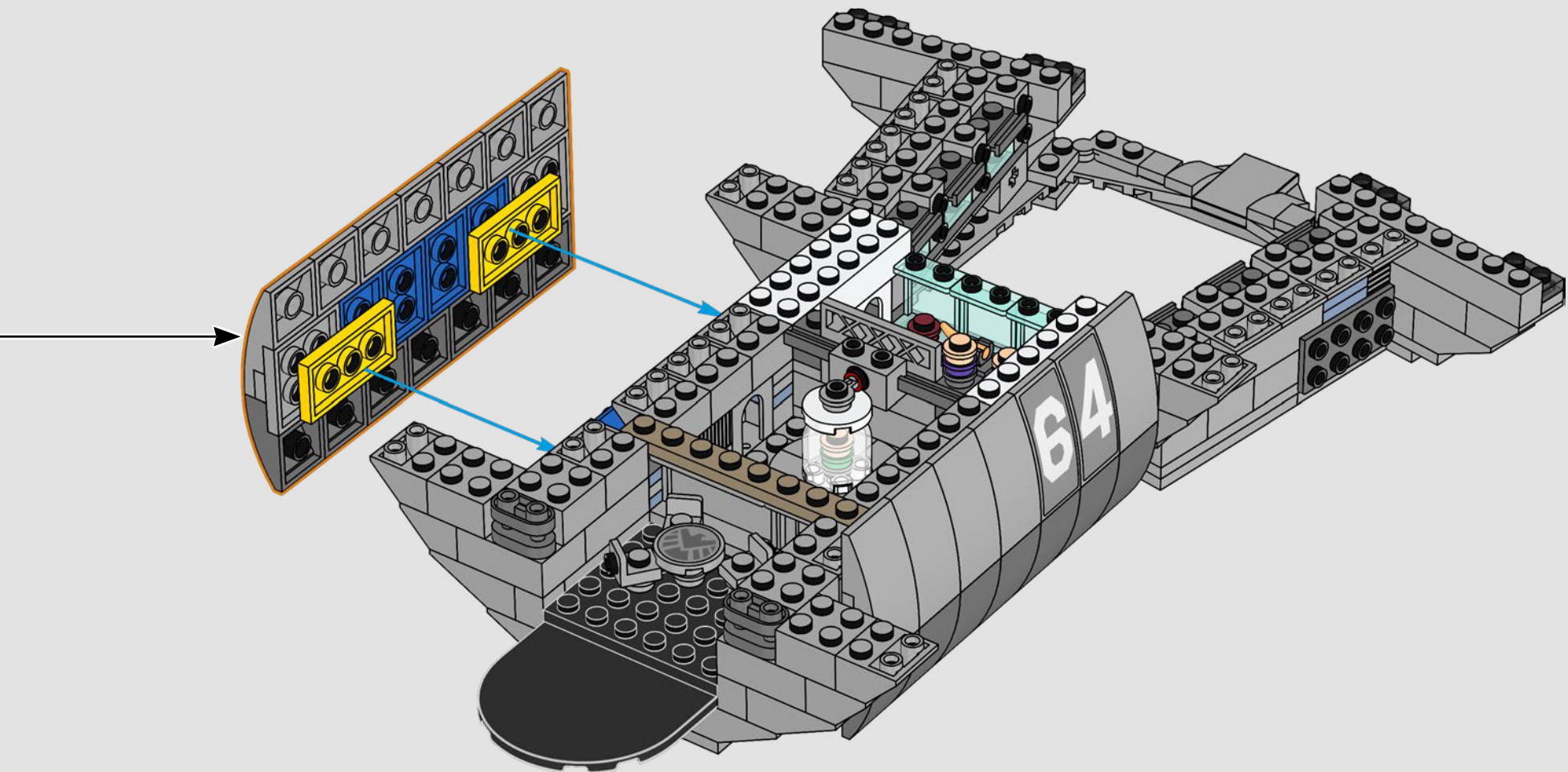

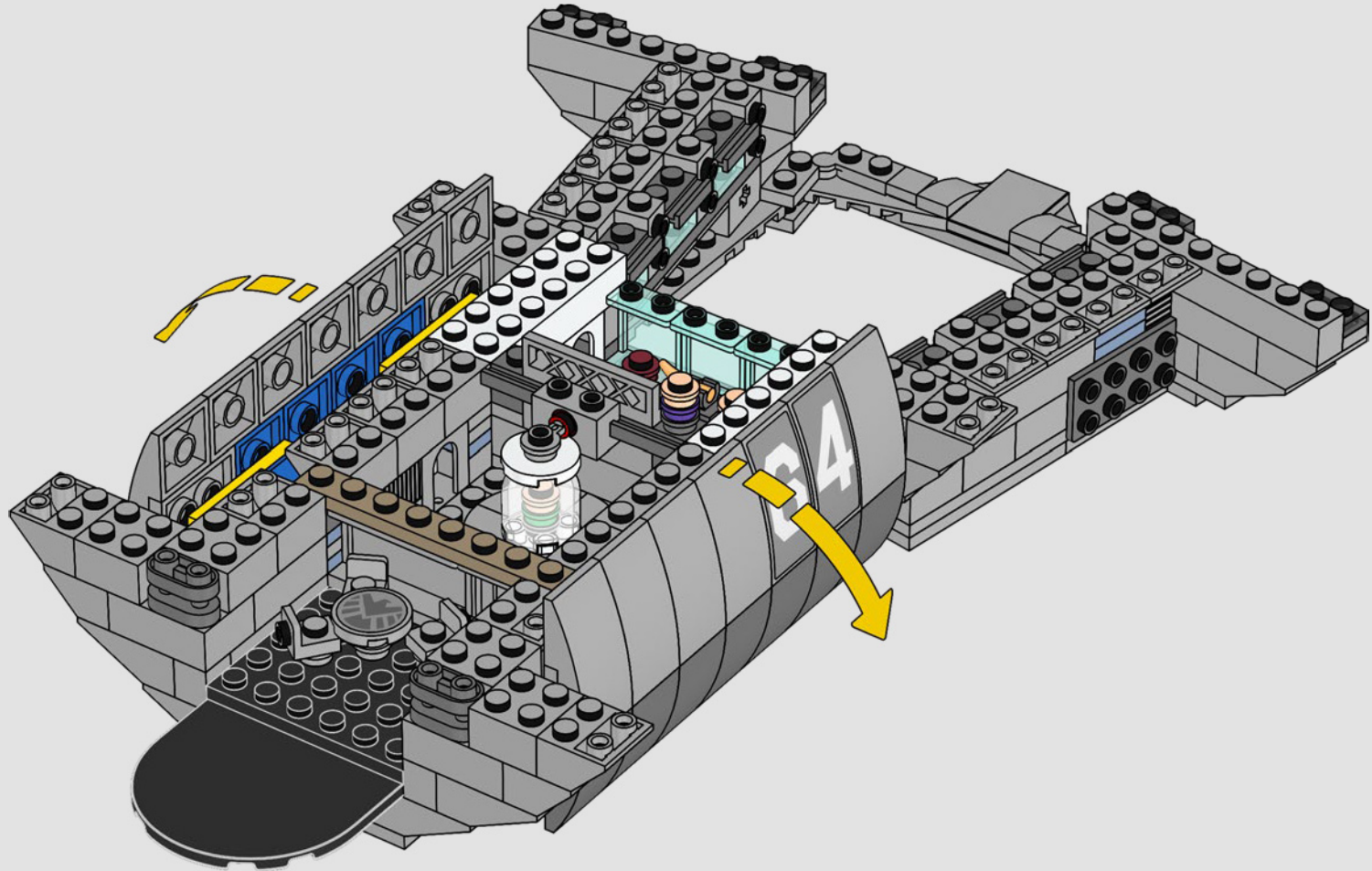

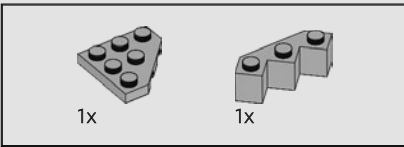
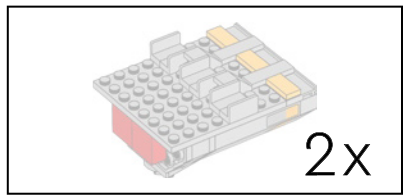

71

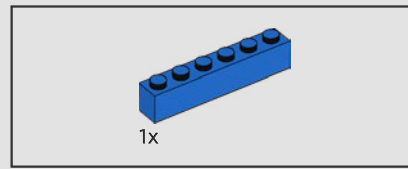
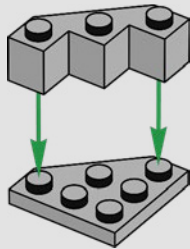

72

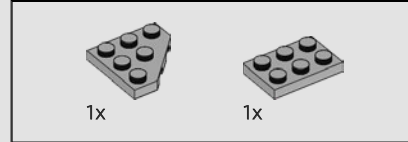
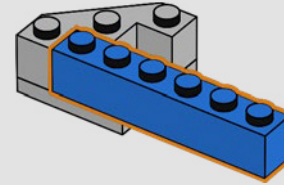

73

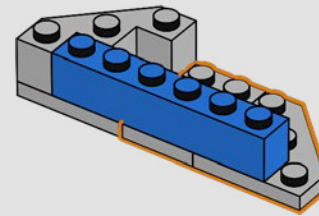

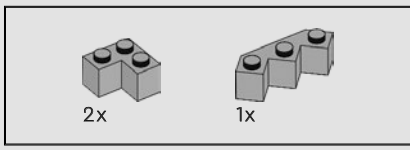

74

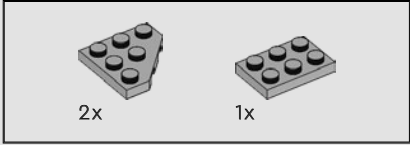
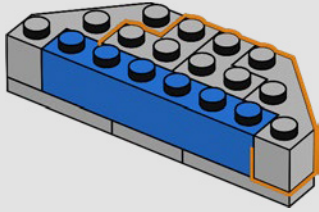

75

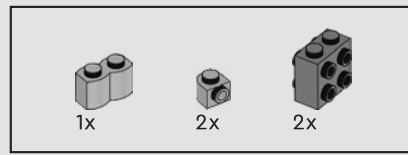
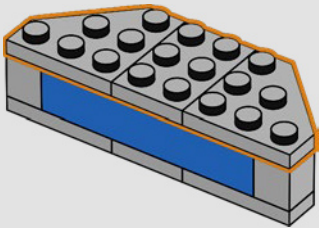

76

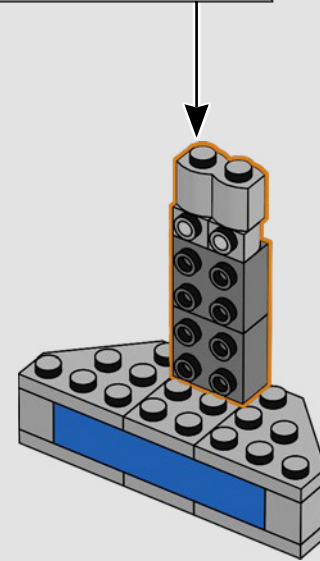
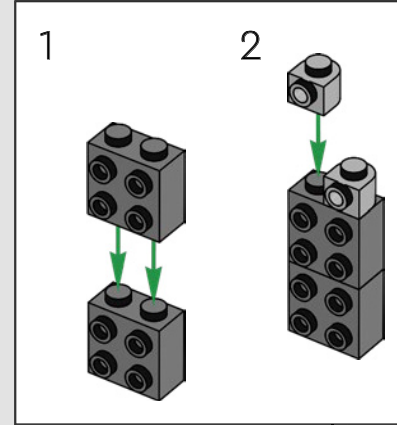

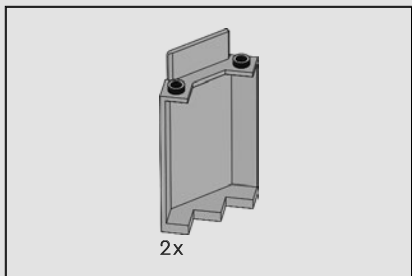

77

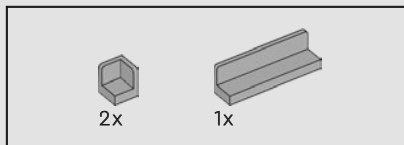
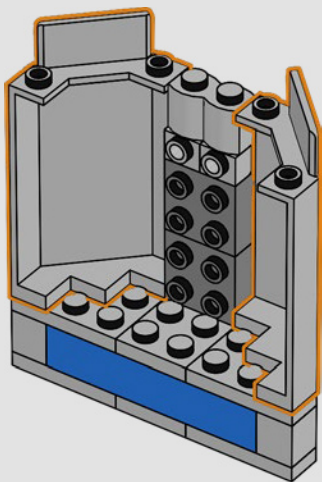

78

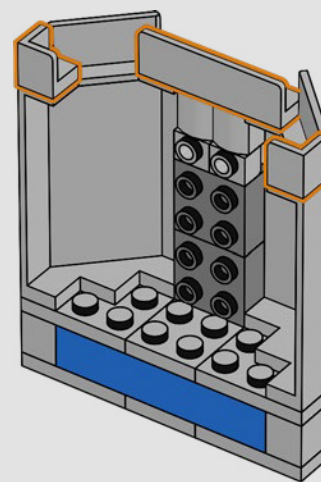

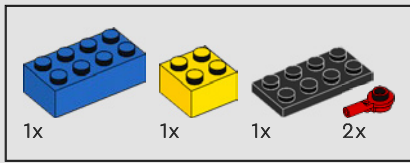

79

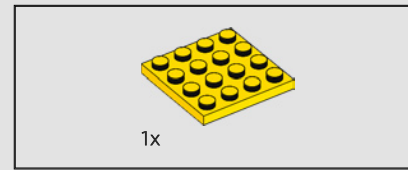
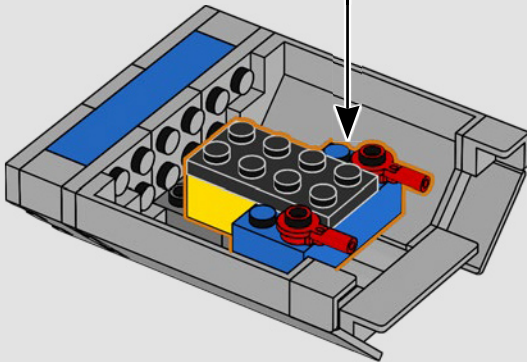
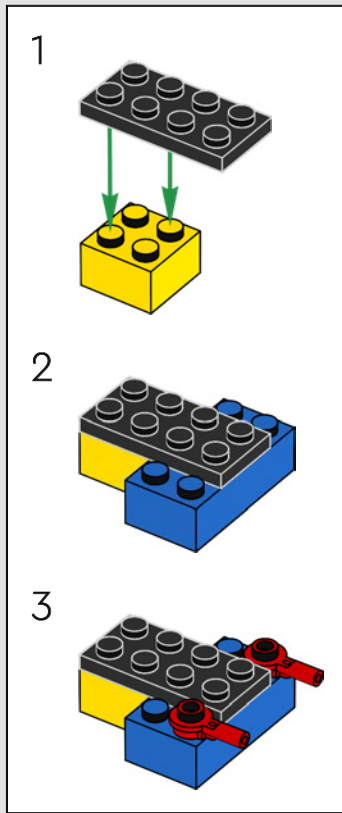

80

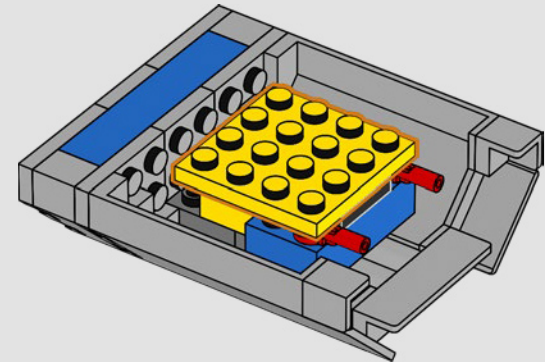

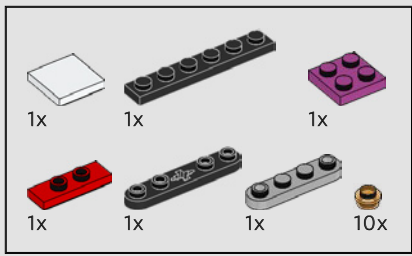

81

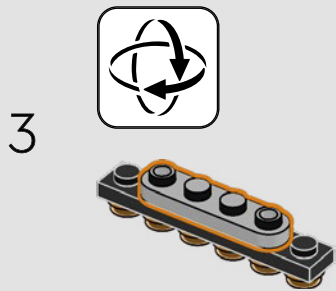
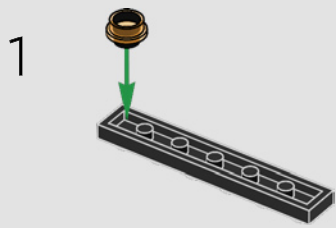

4

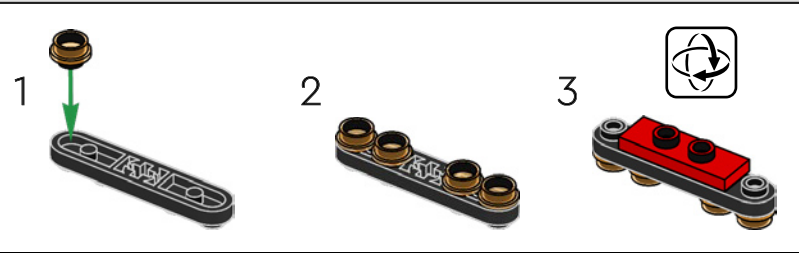
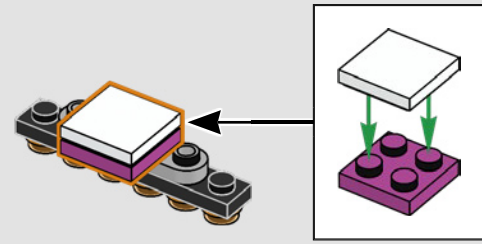

5

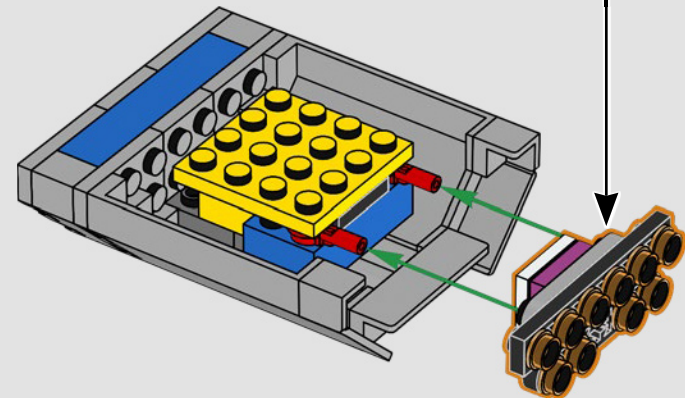
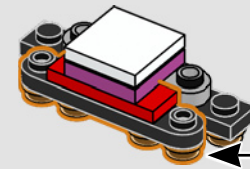

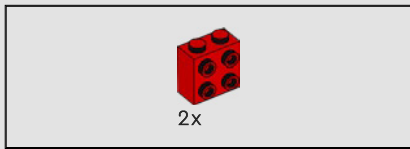

82

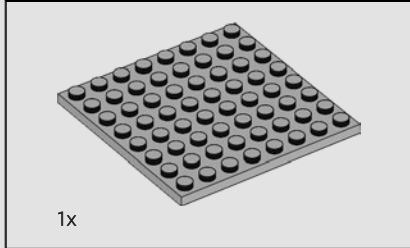
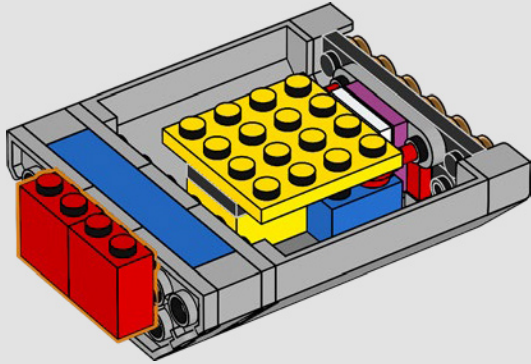

83

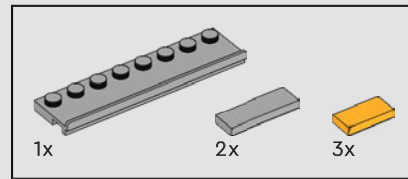
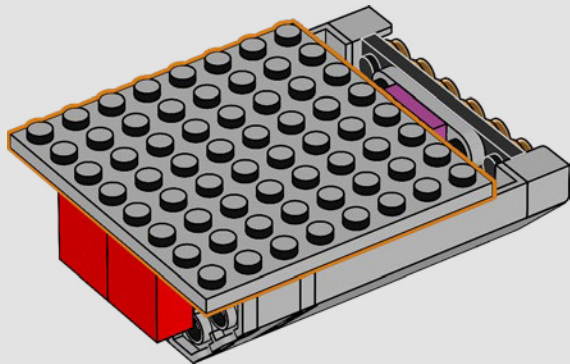

84

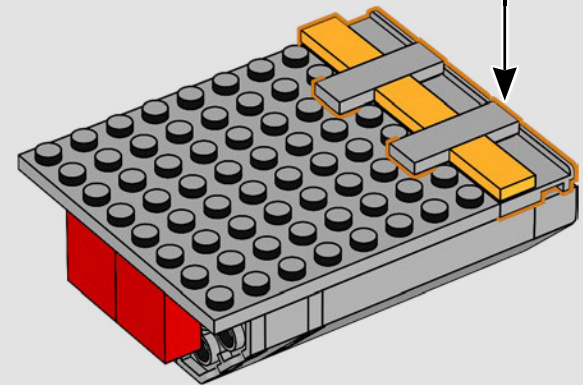
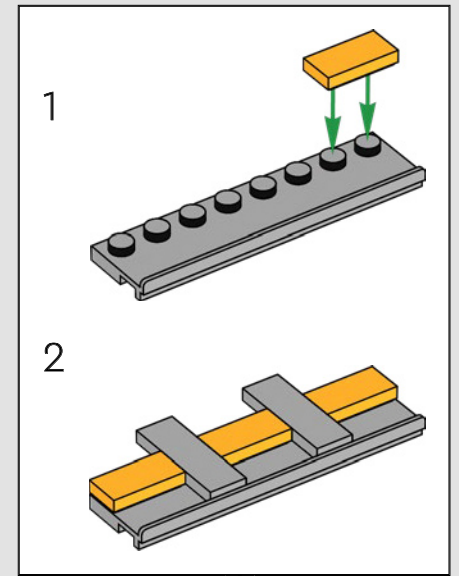

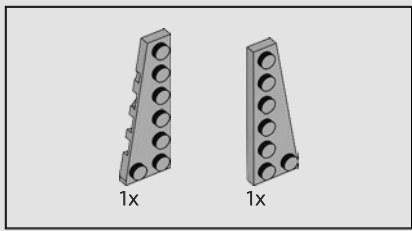

85

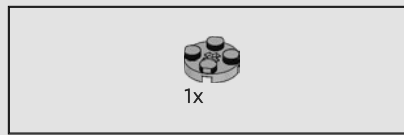
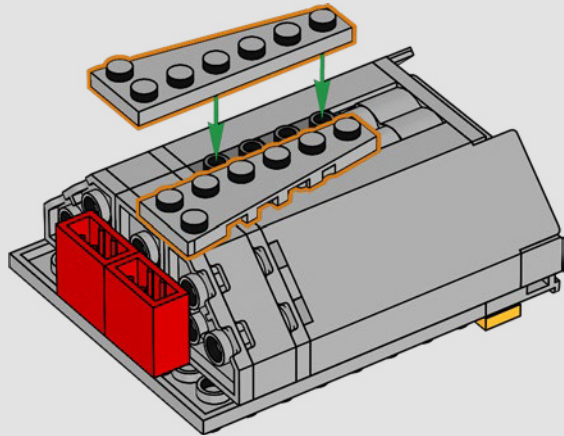

86

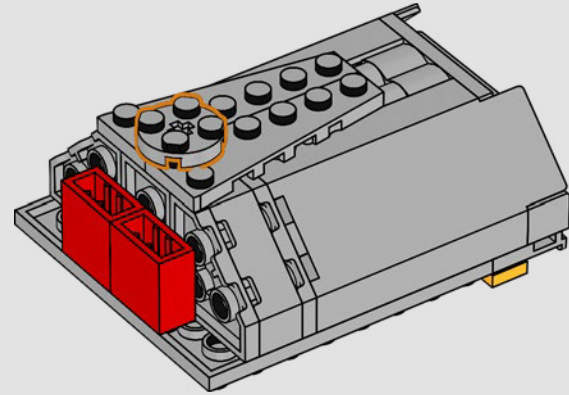

87

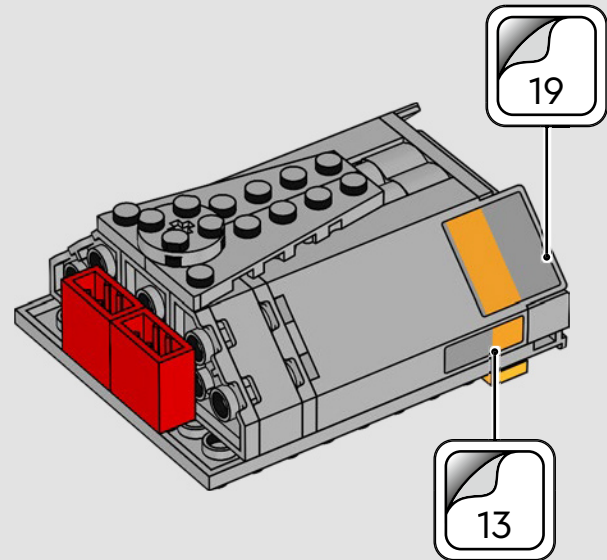

88

19



13

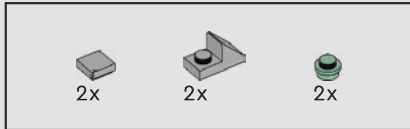
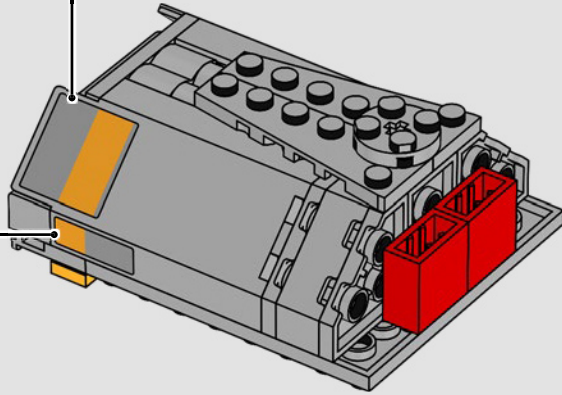

89

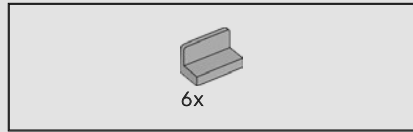
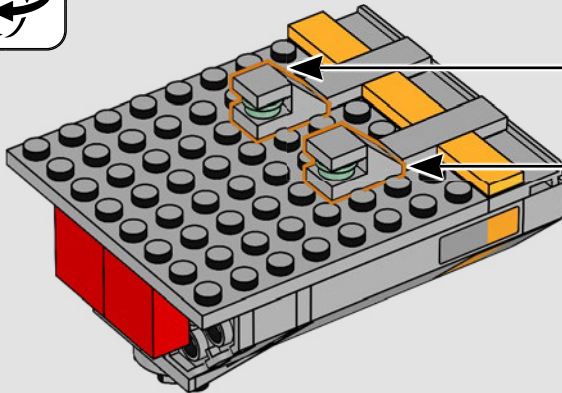
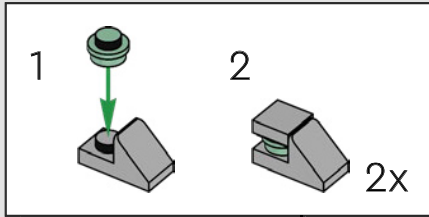

90

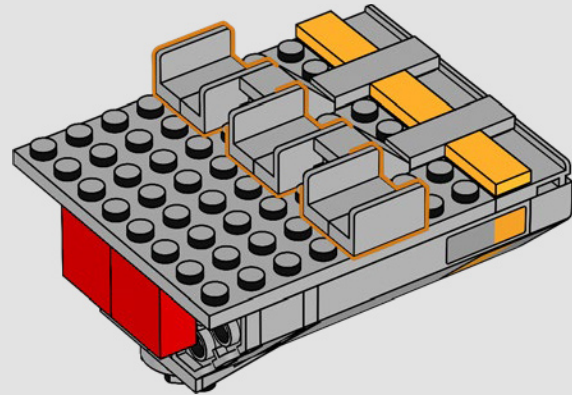

2x

91

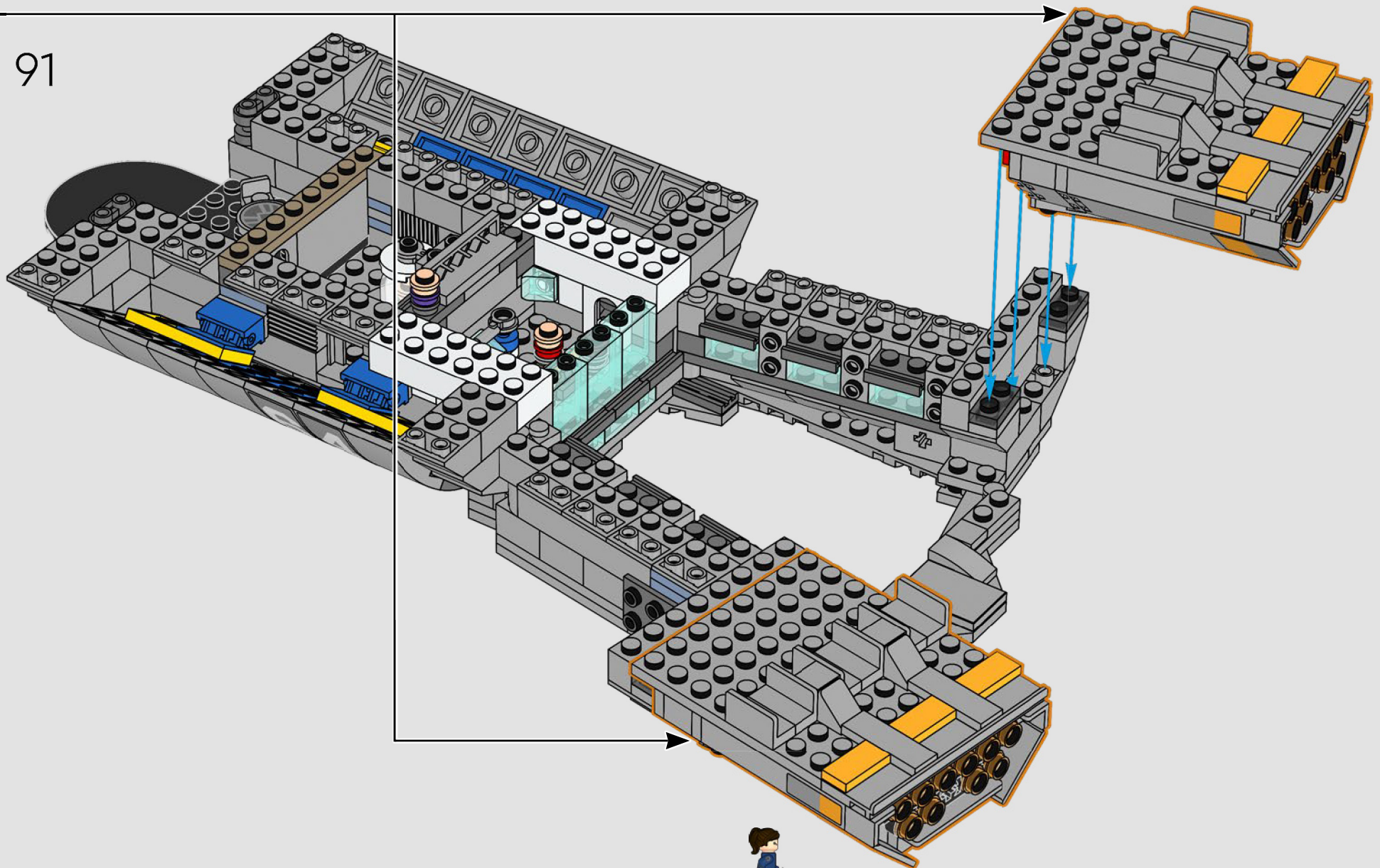



92

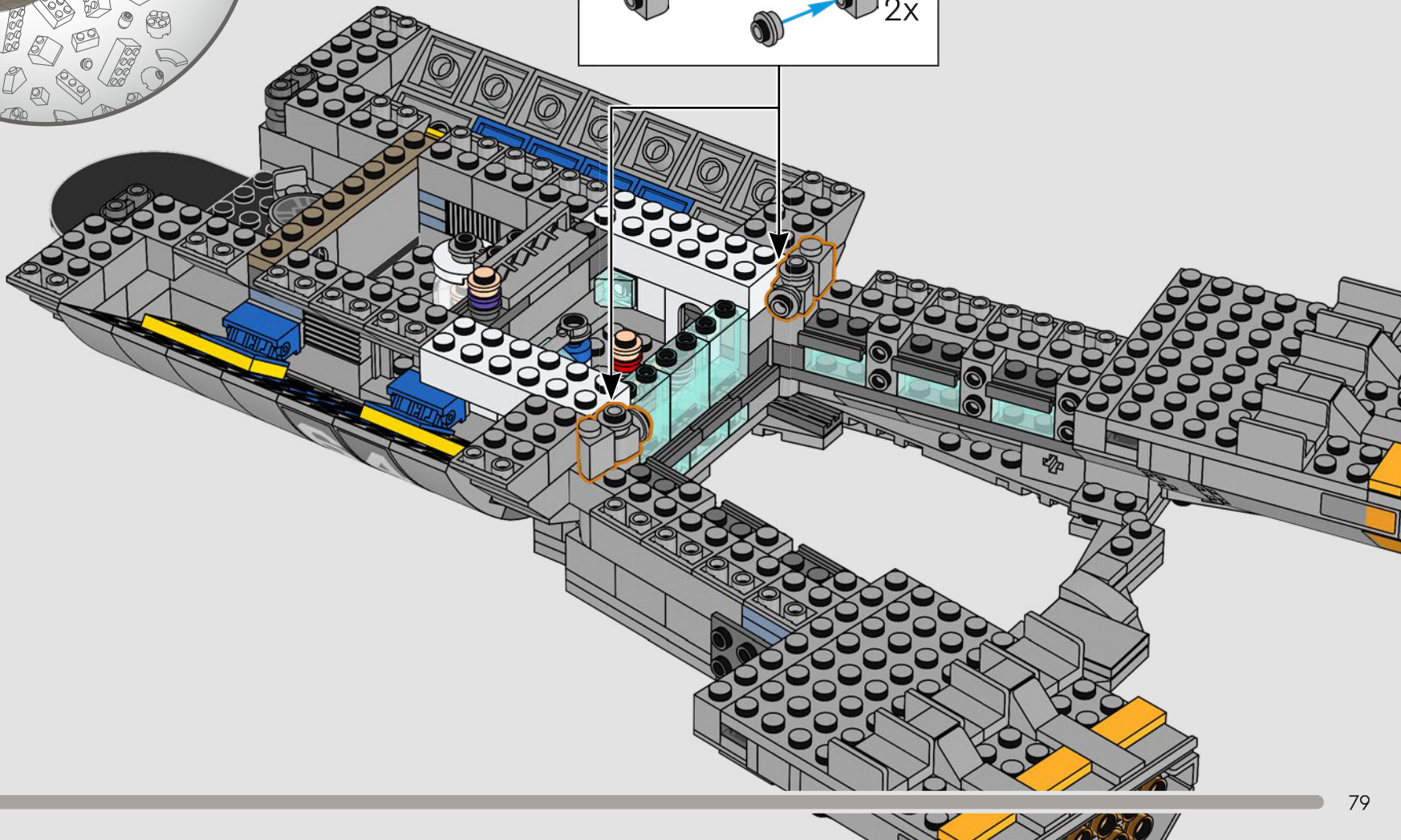
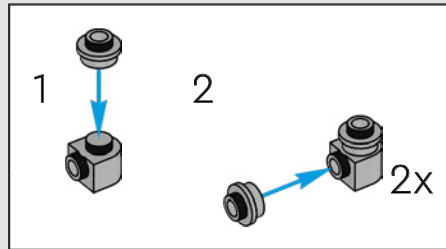



2x

93

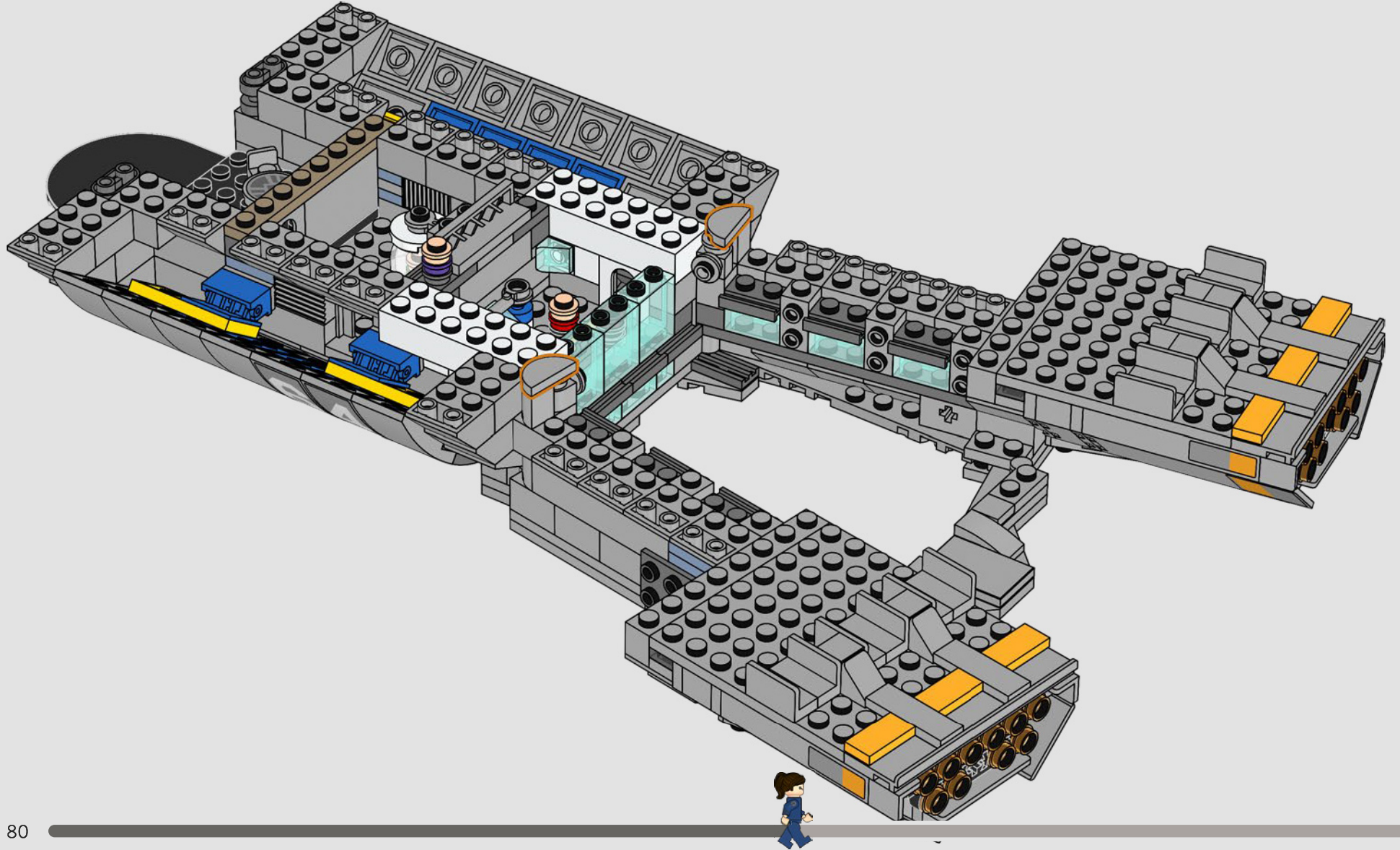

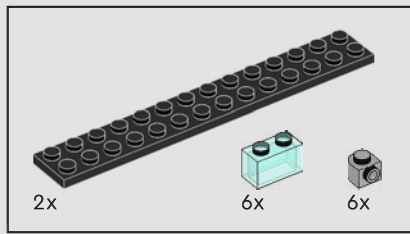

94

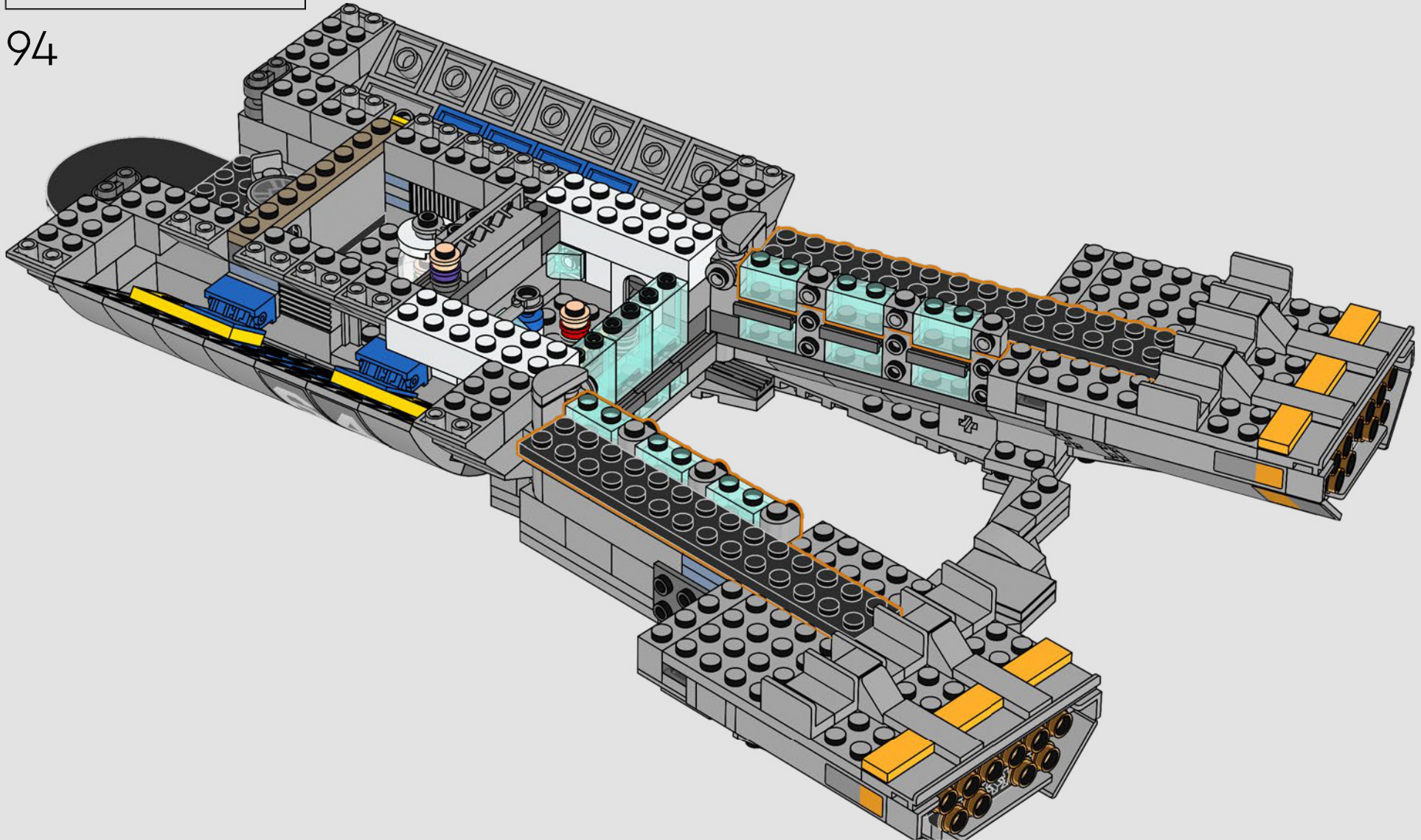

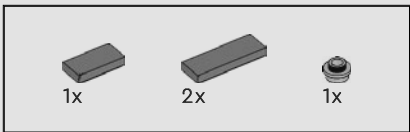

95

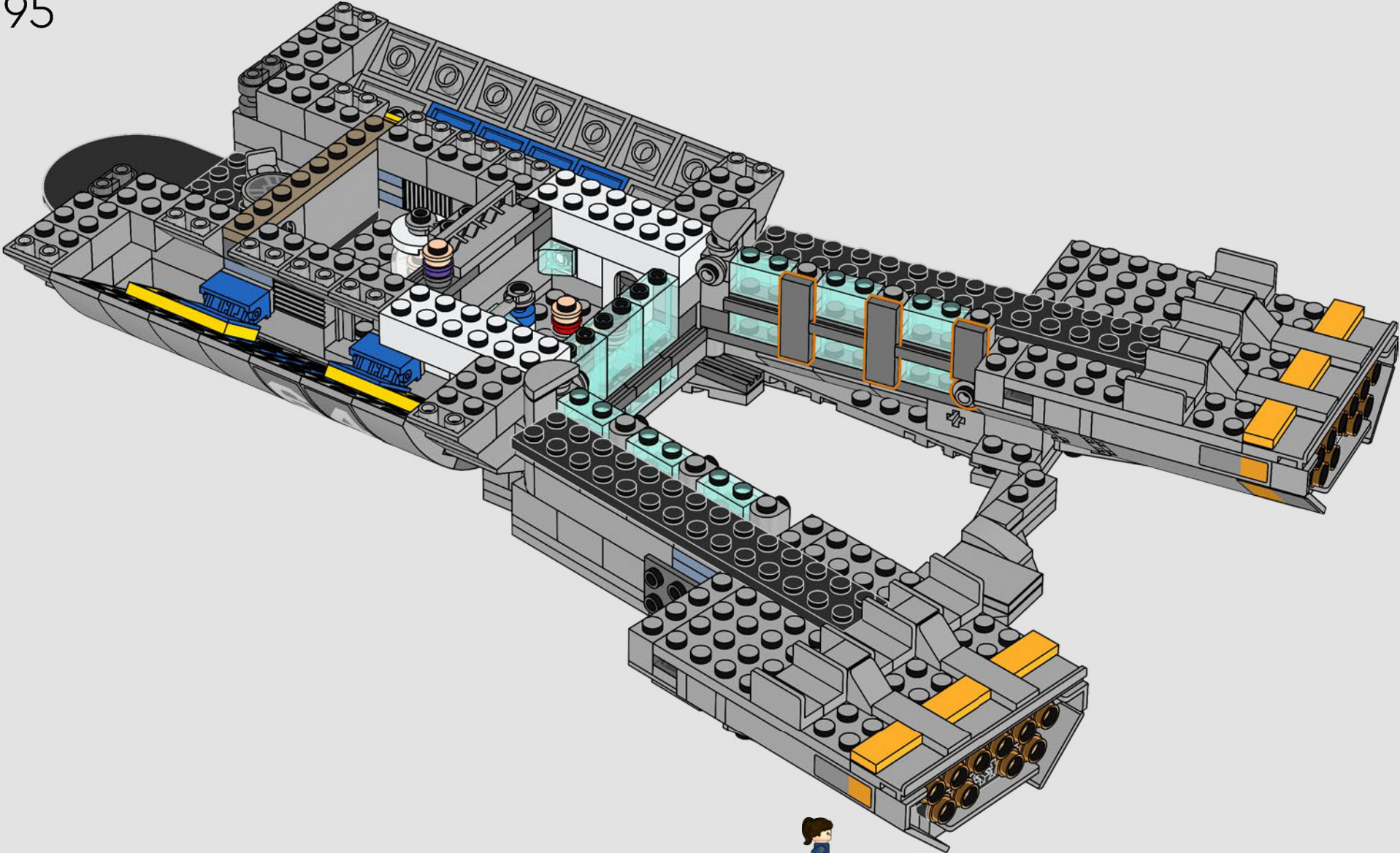

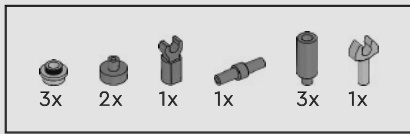

96

1



2



3



4

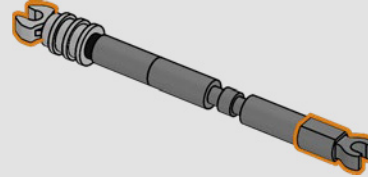
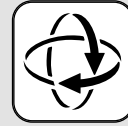

5

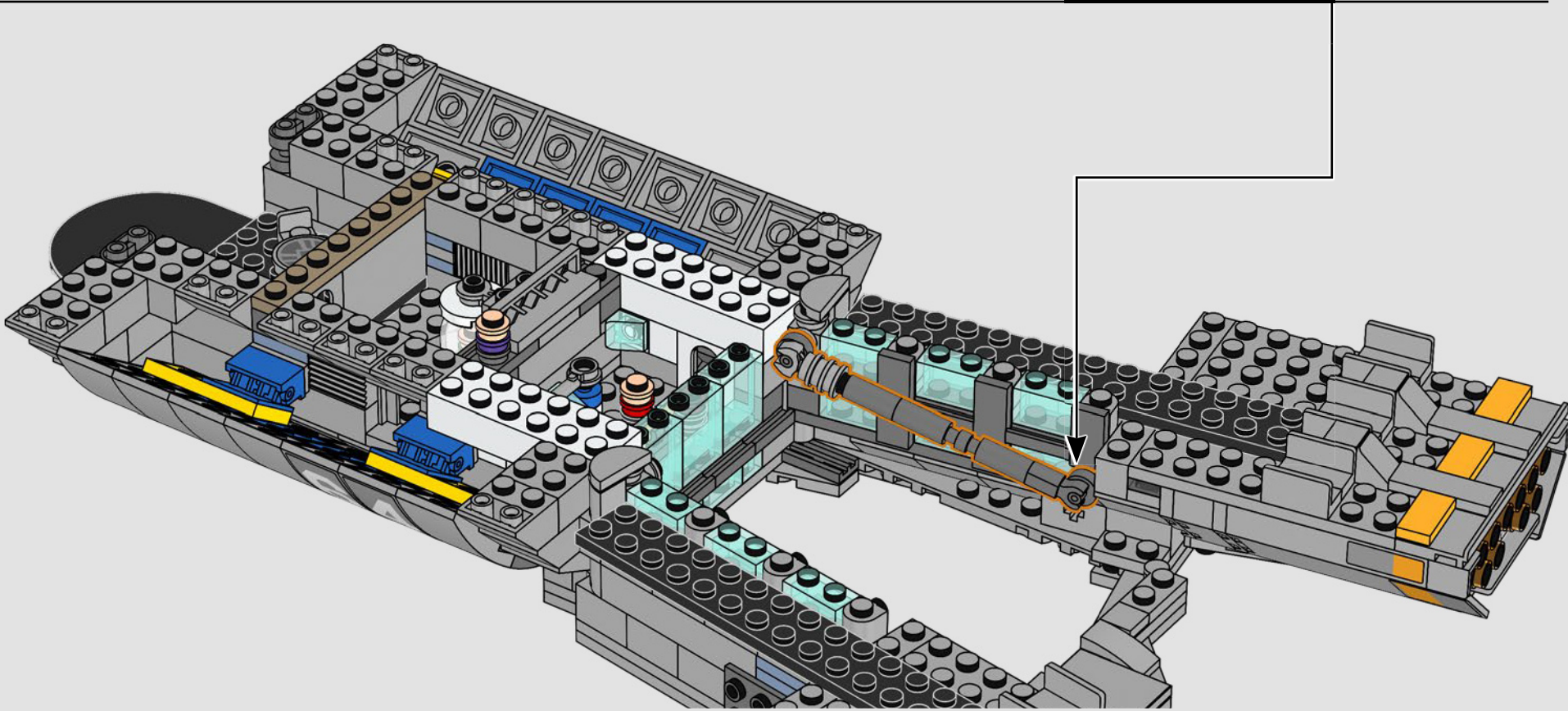
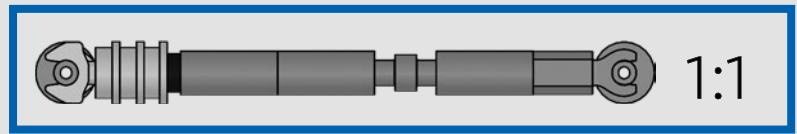
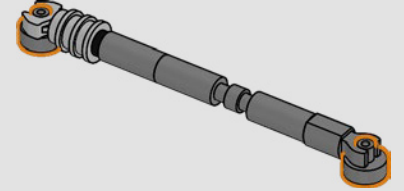

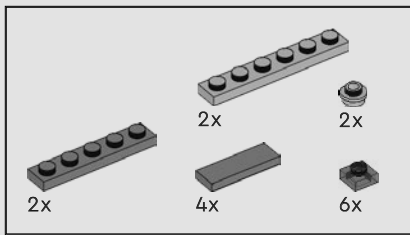

97

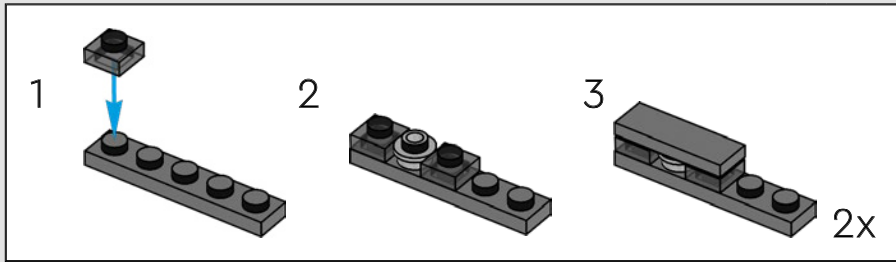
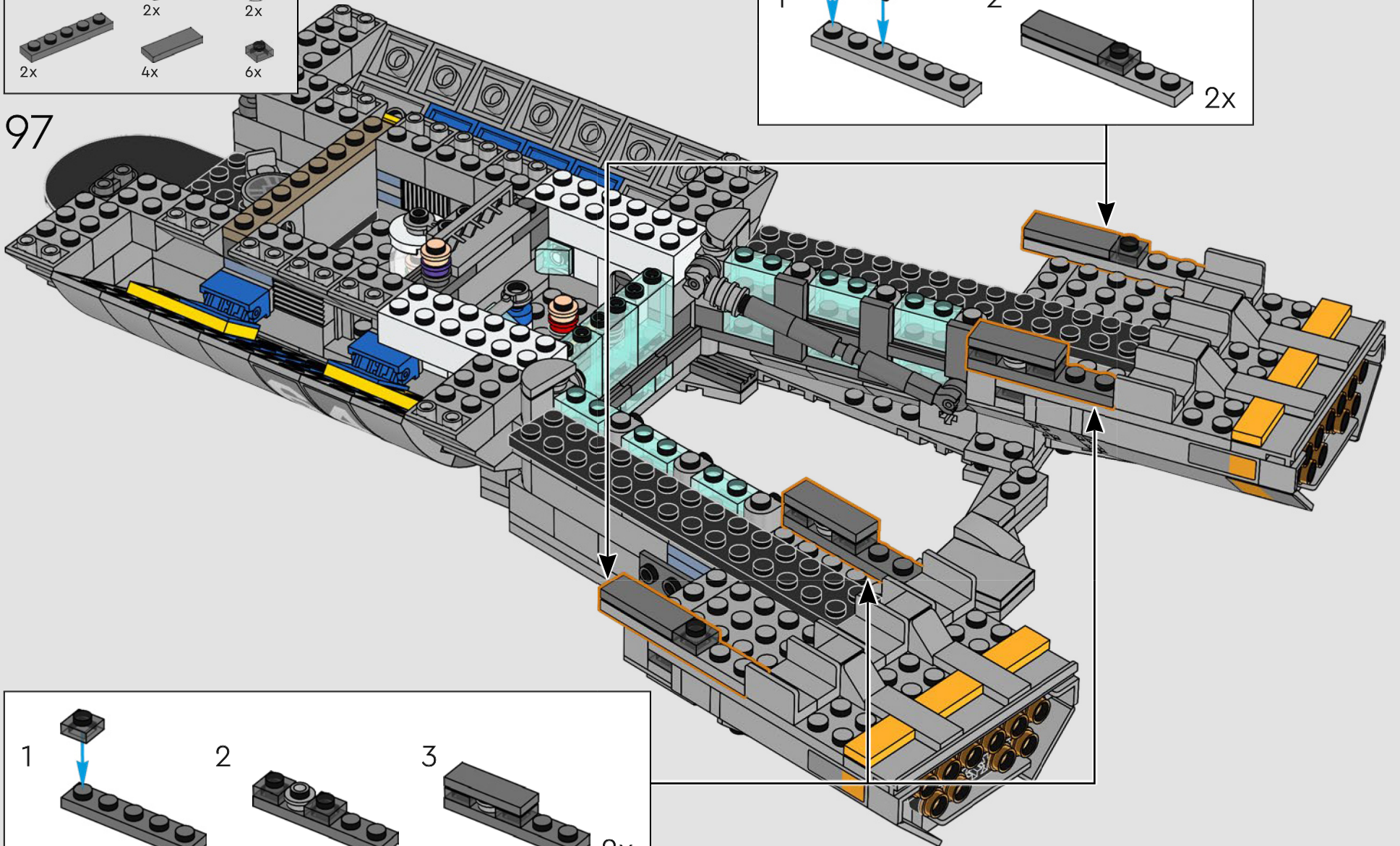
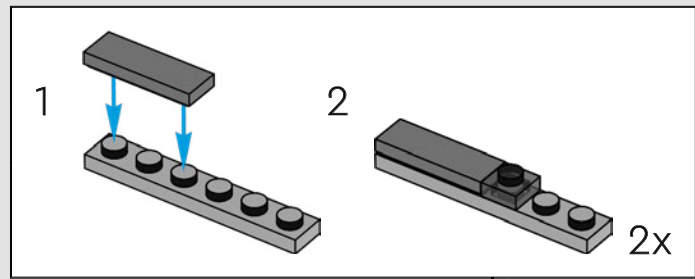

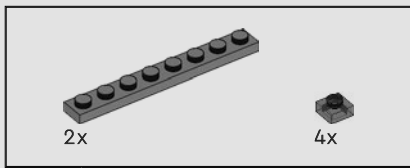

98

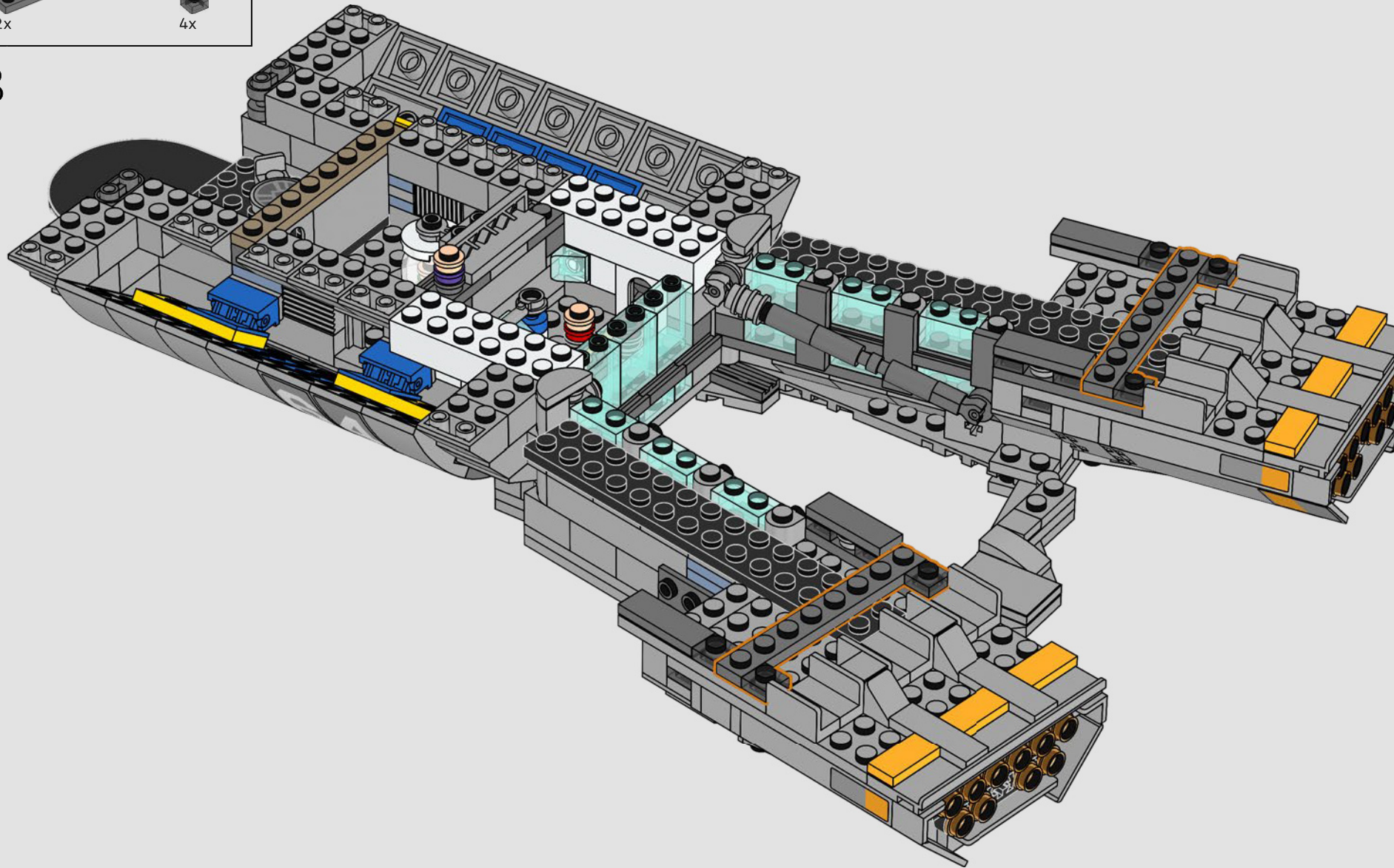

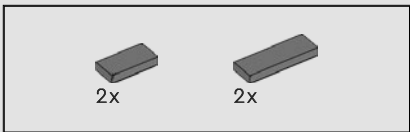

99

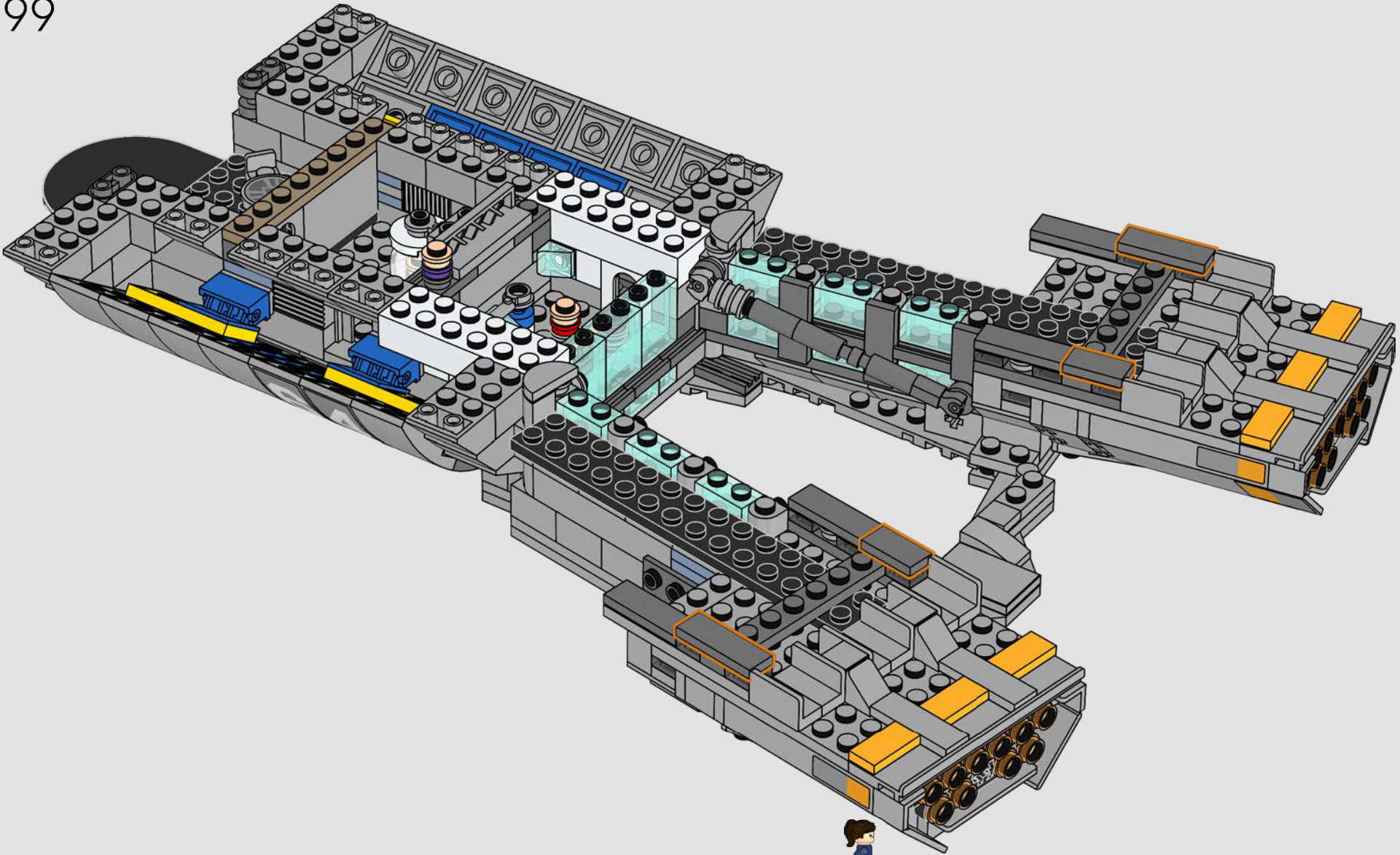

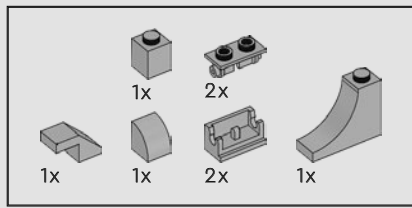

100

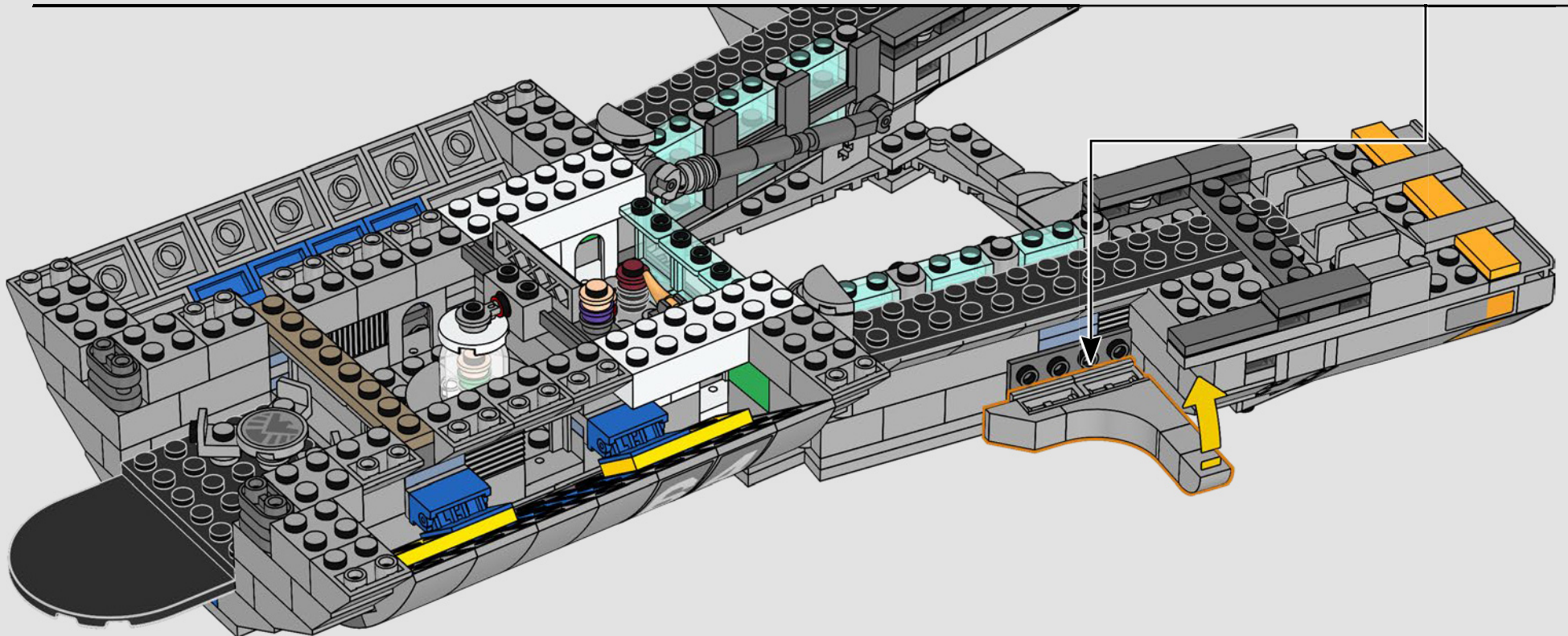
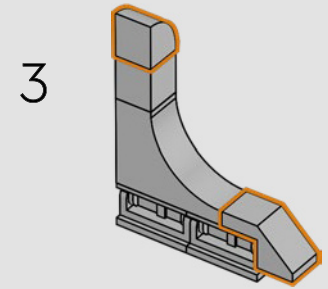
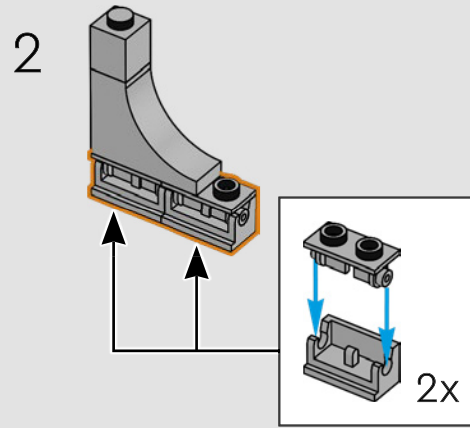
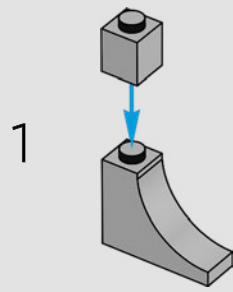

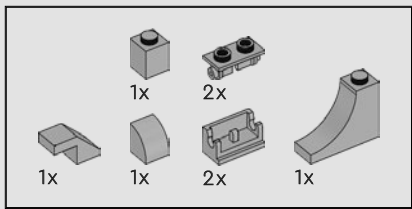

101

1

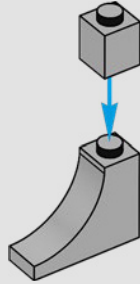

2

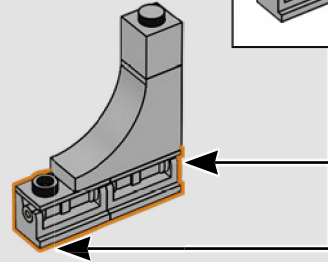

2x

3

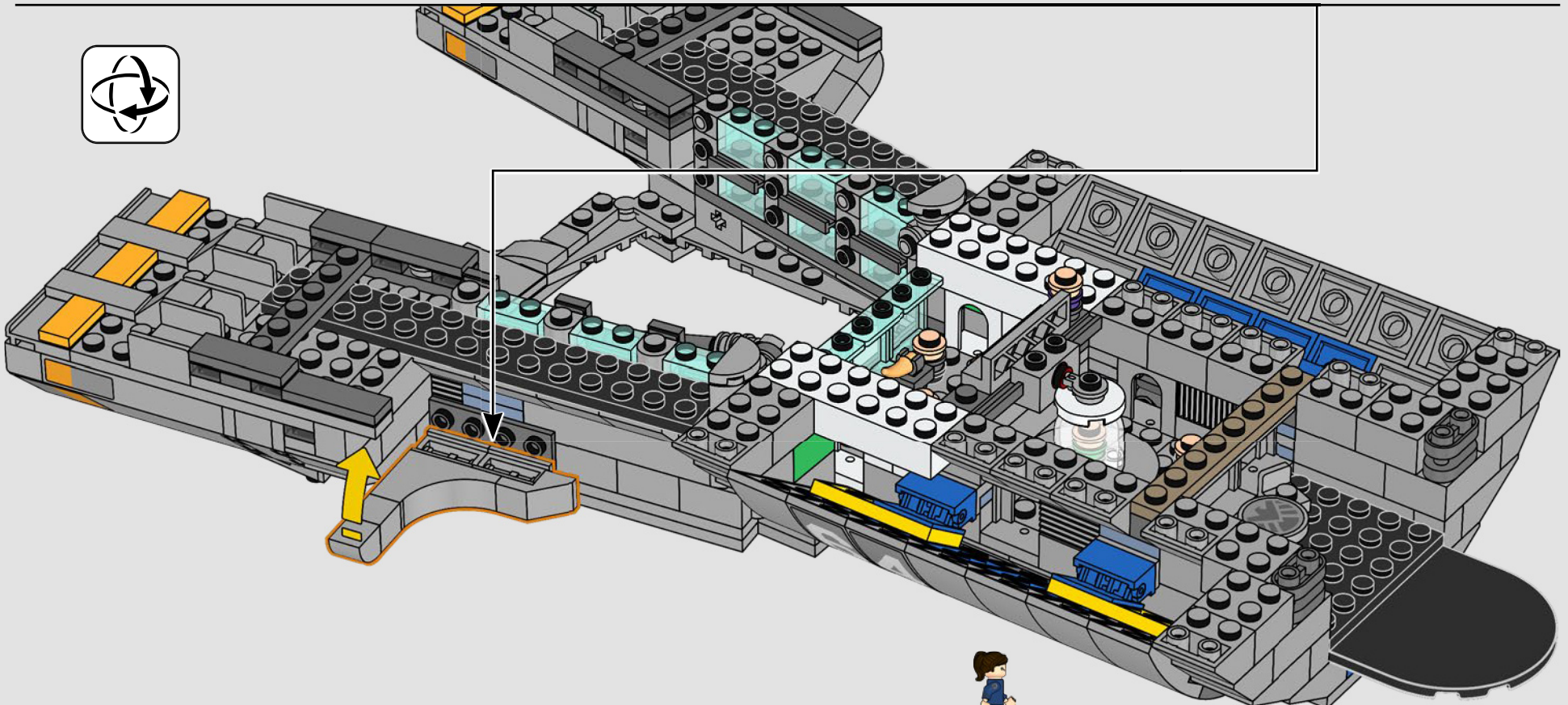
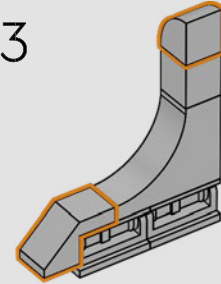

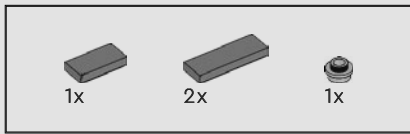

102

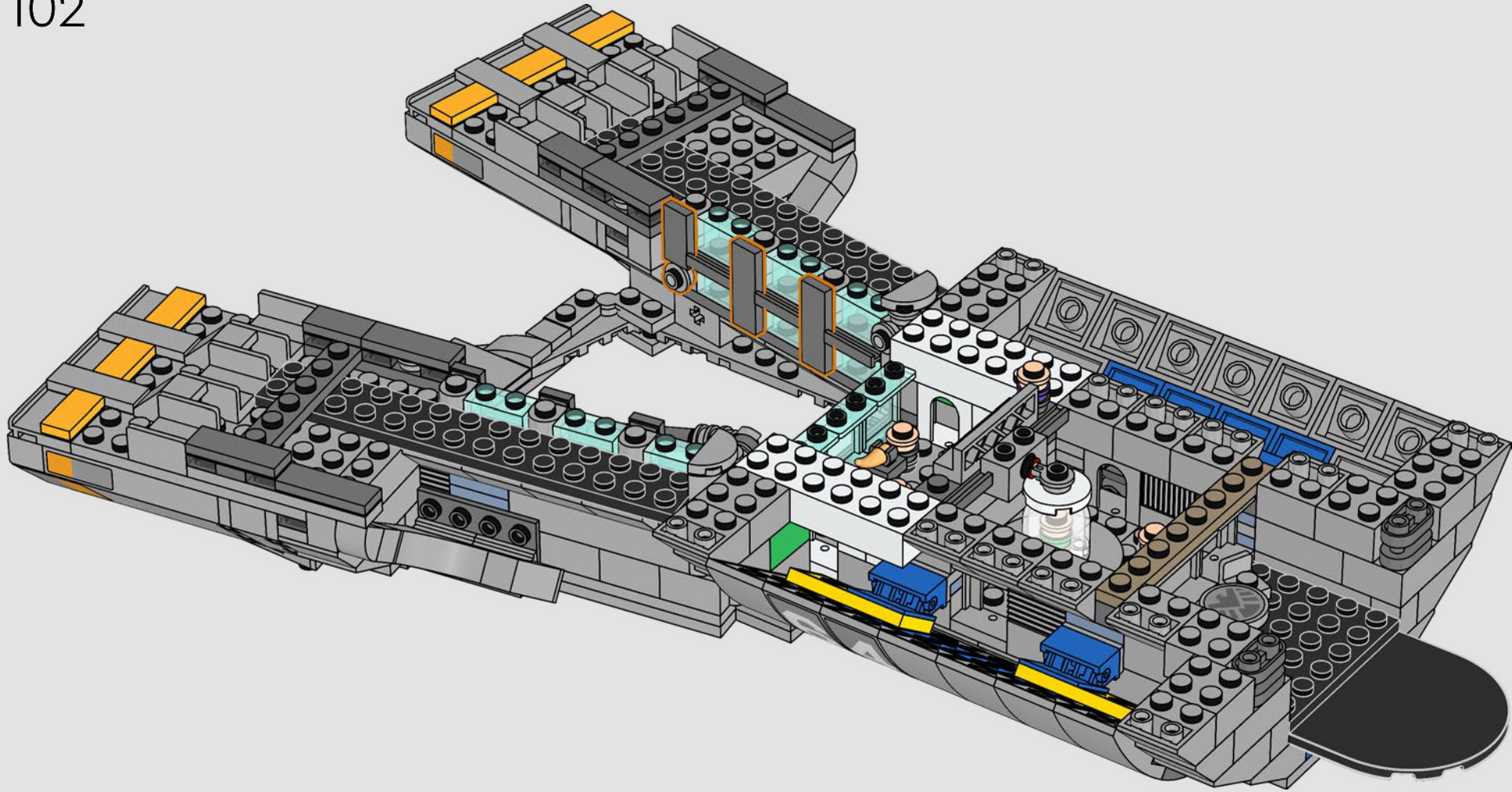

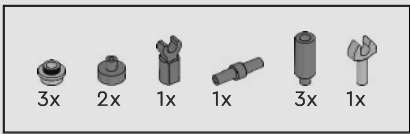

103

1



2



3



4

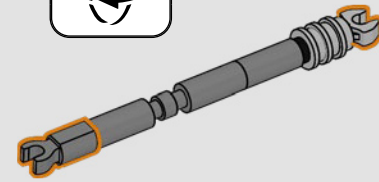

5

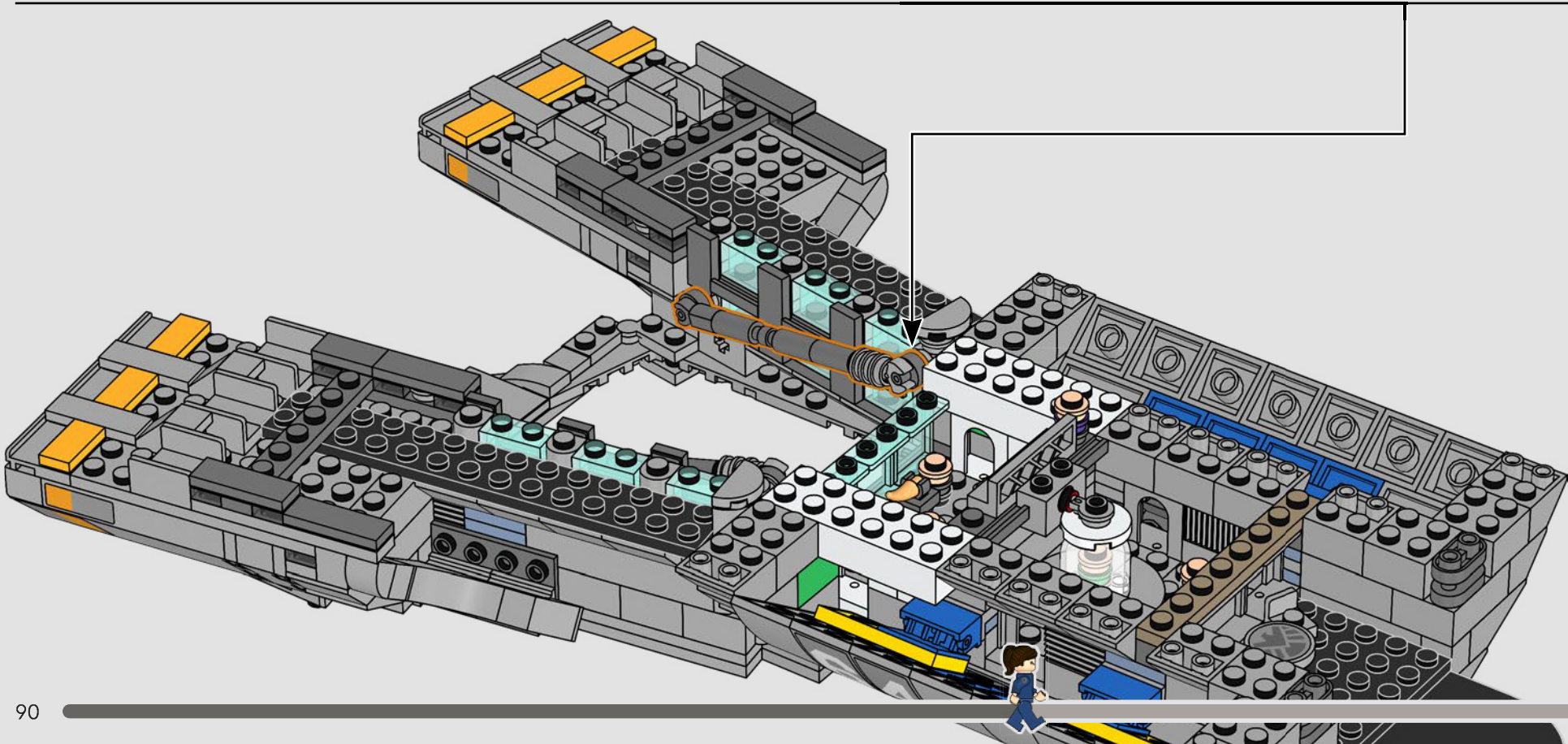
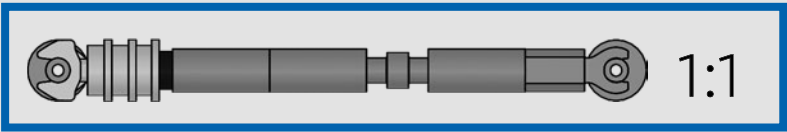
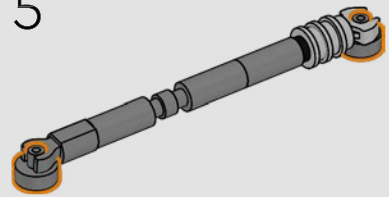

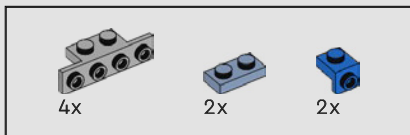

104

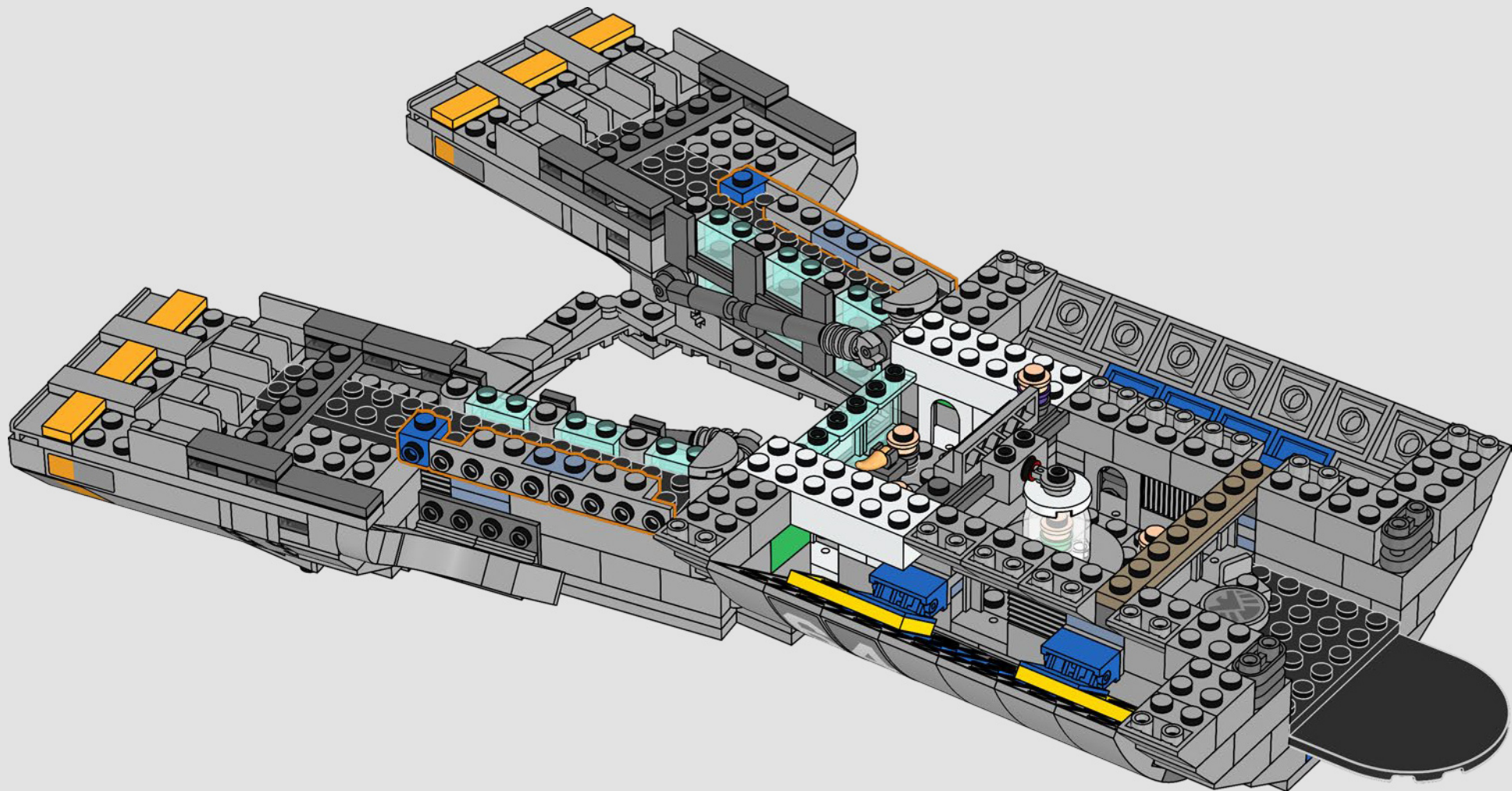

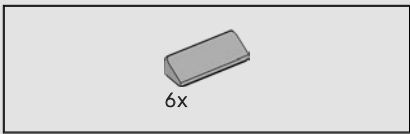

105

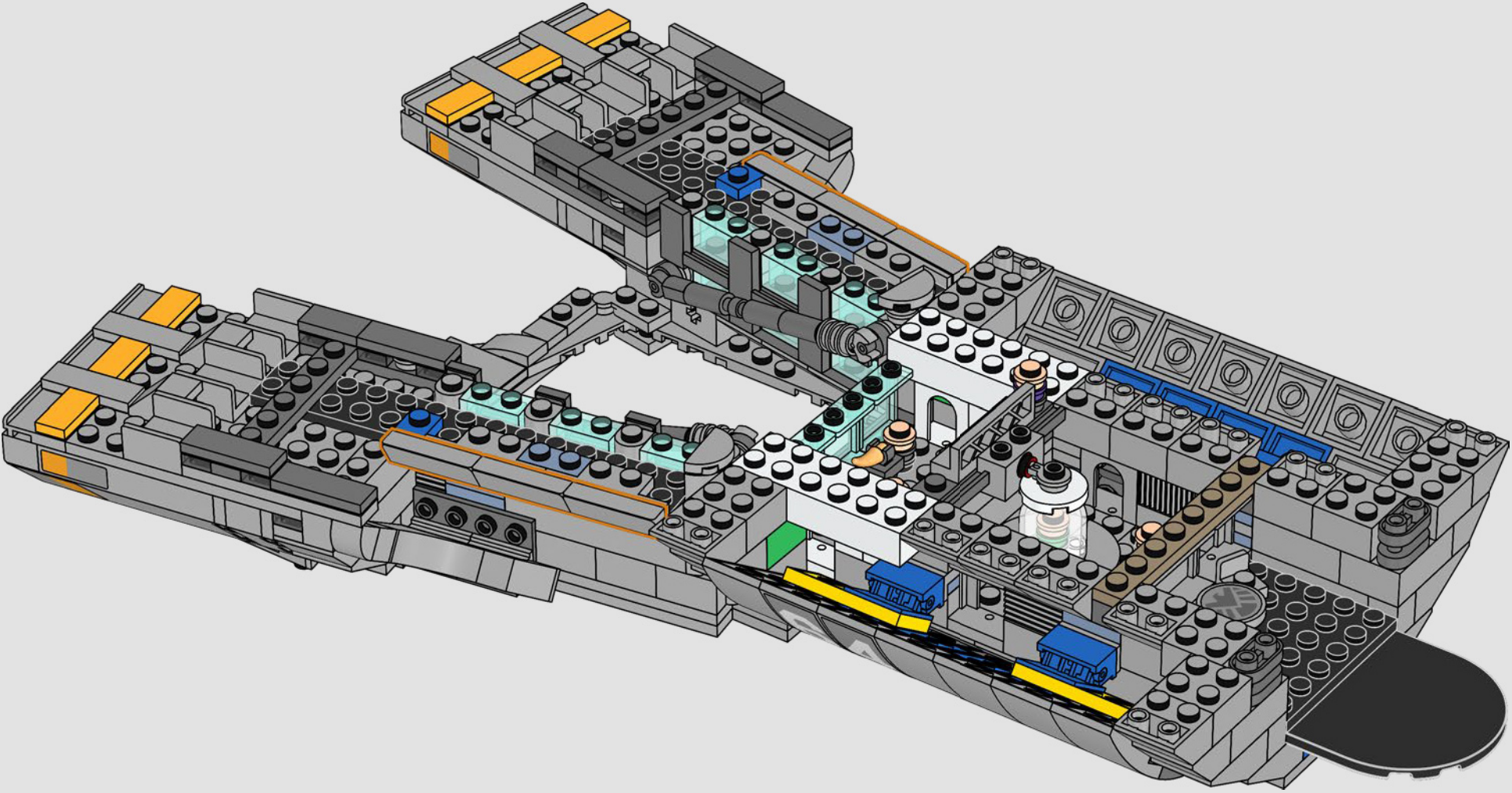

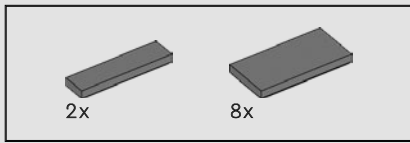

106

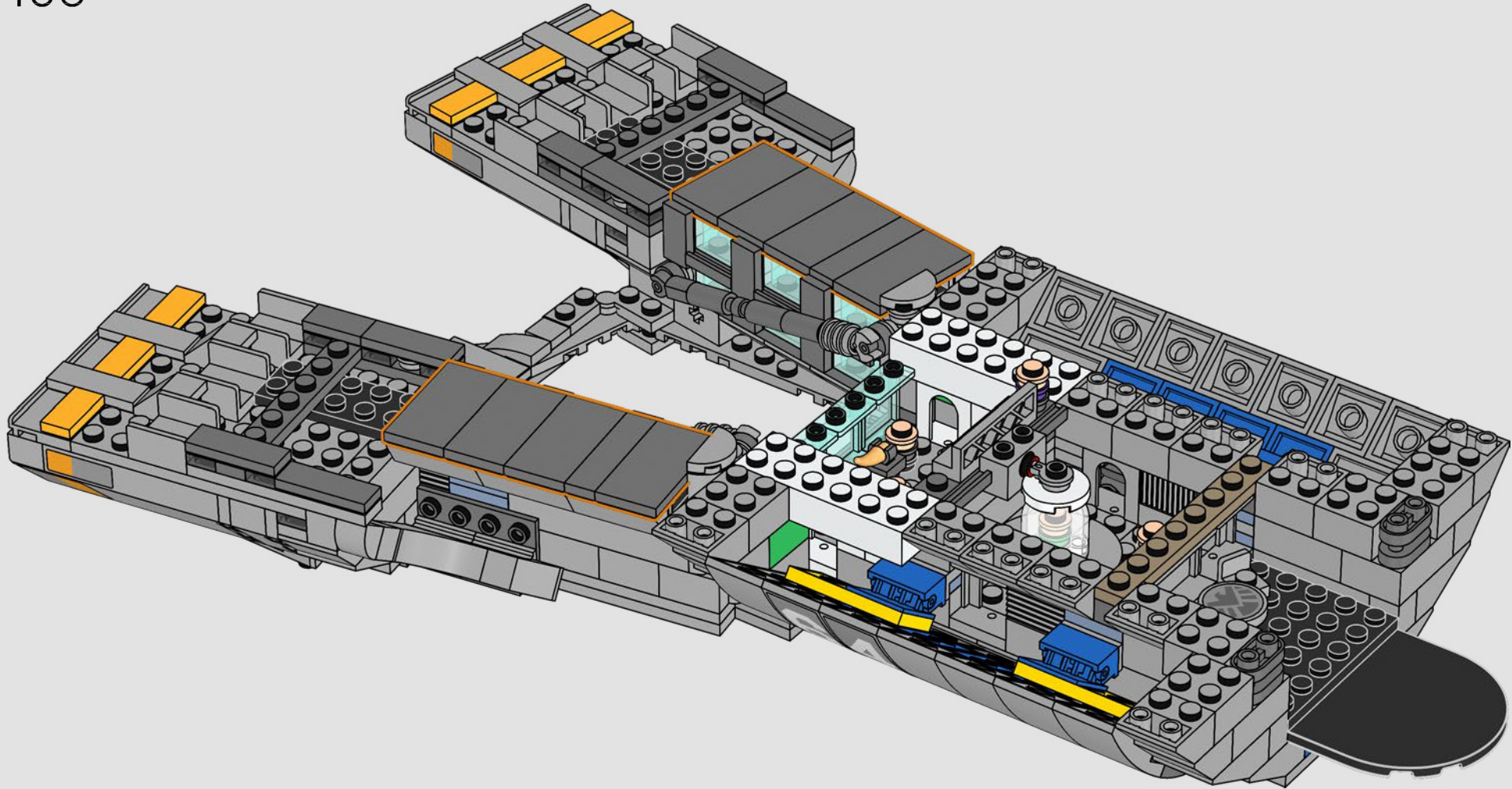

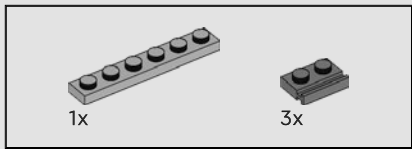

107

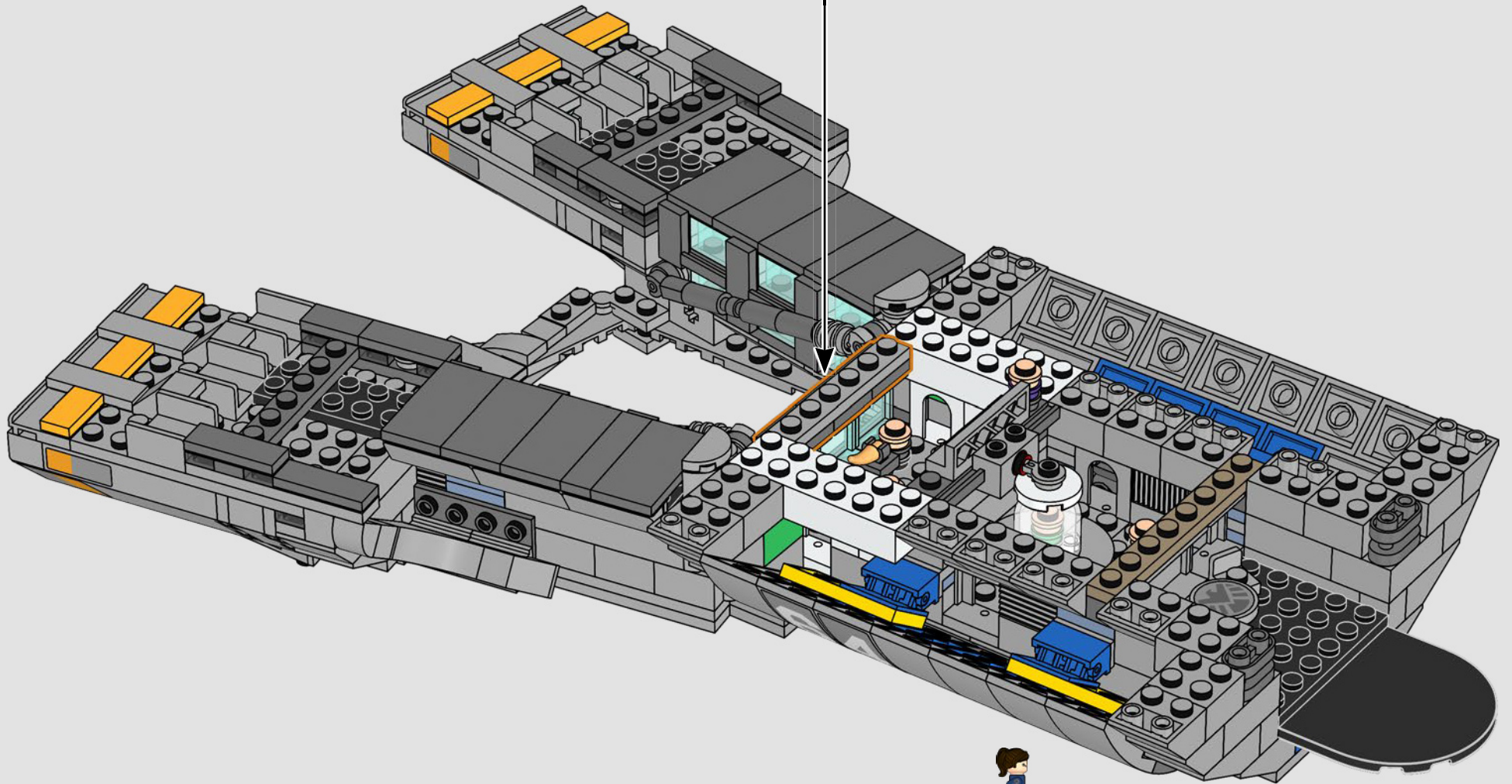
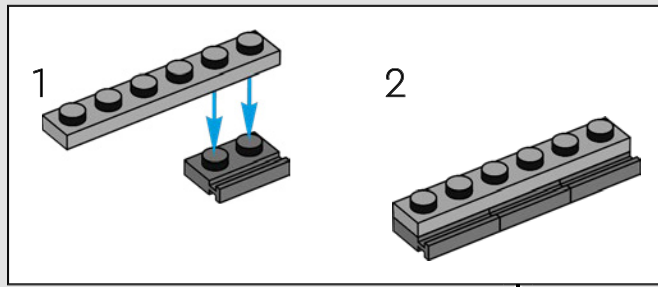

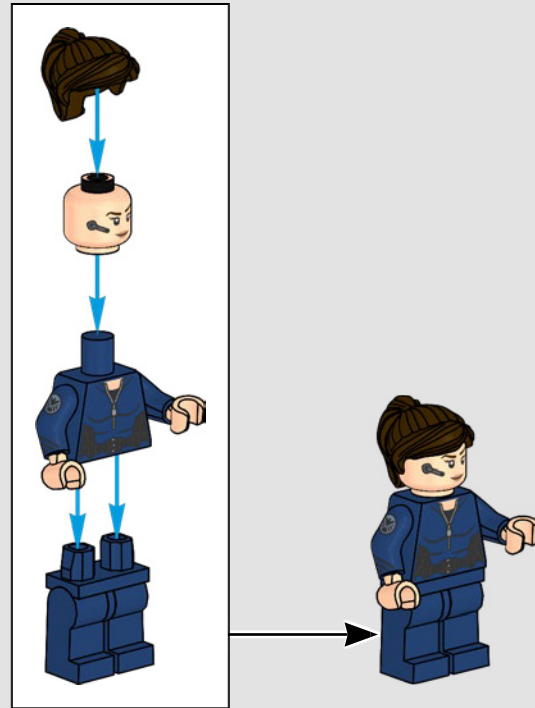
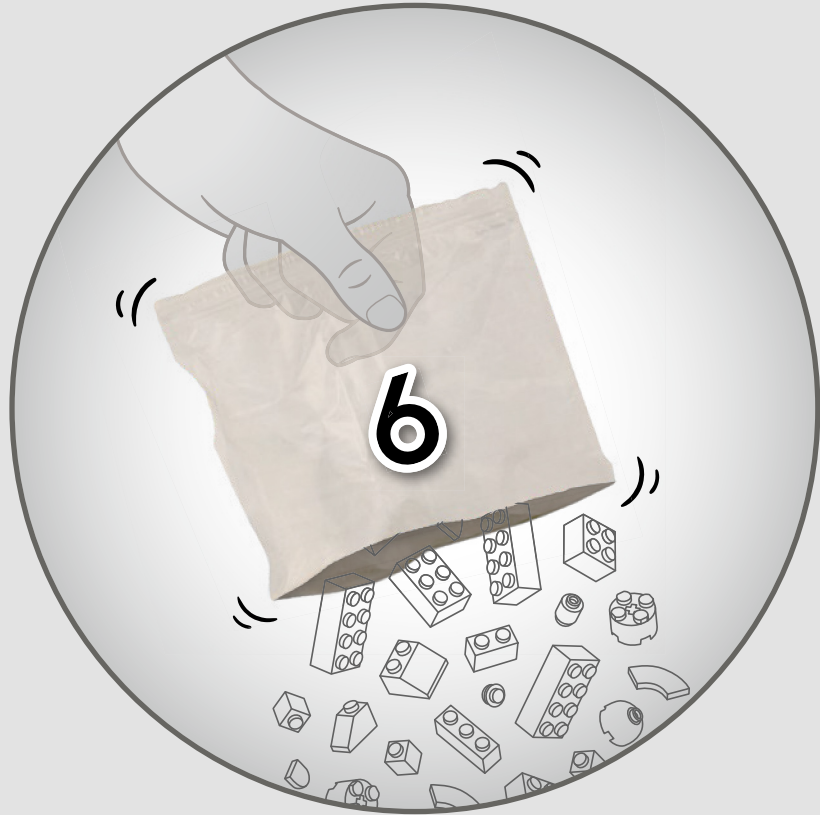



108

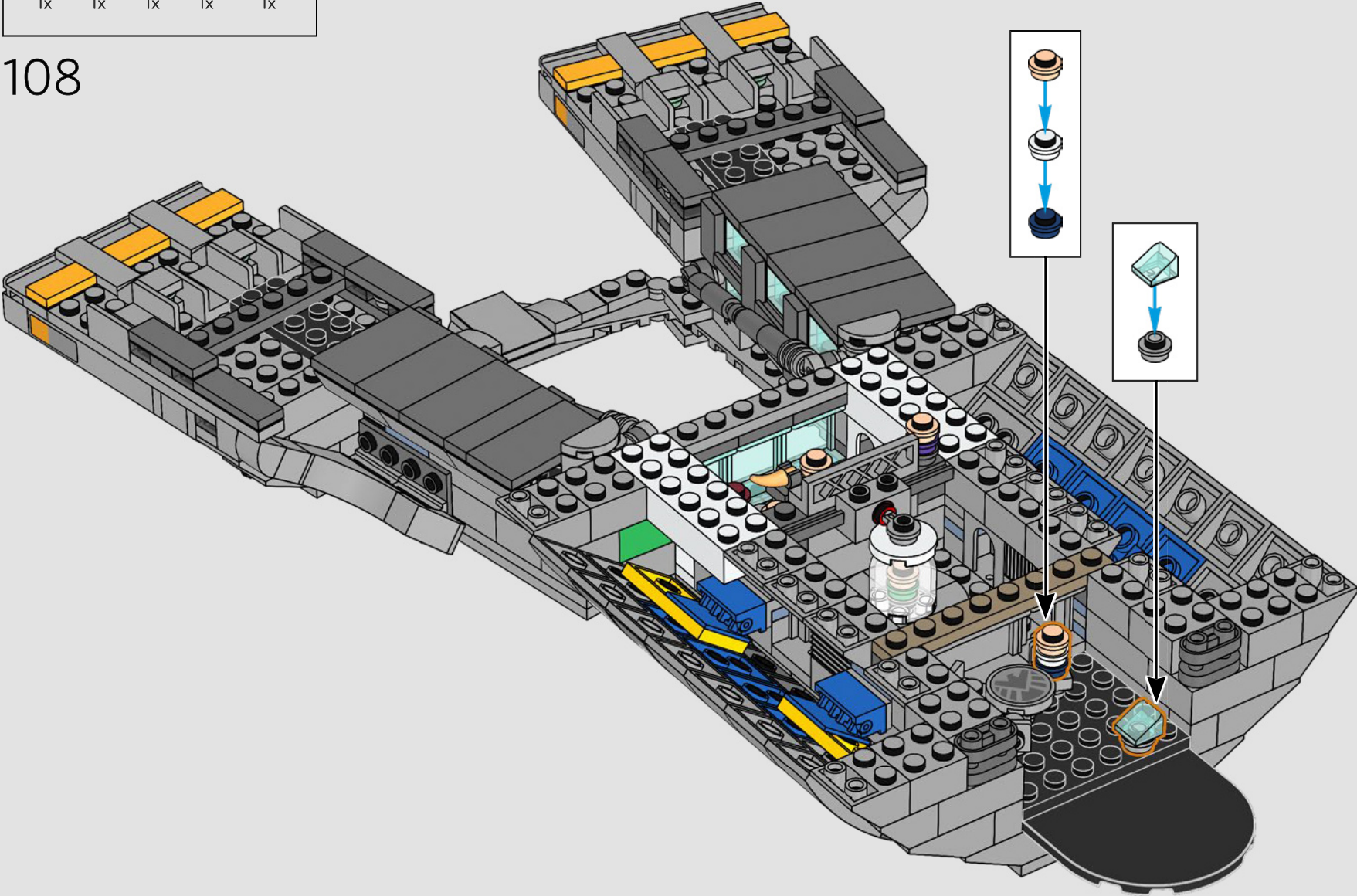

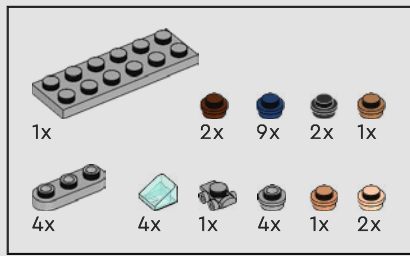

109

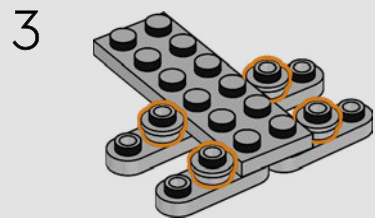
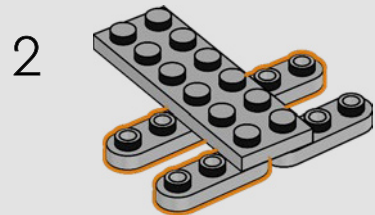
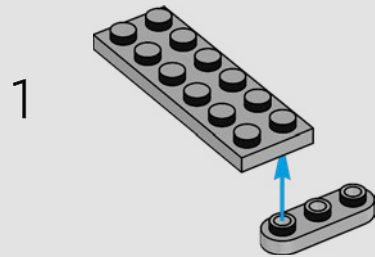

4

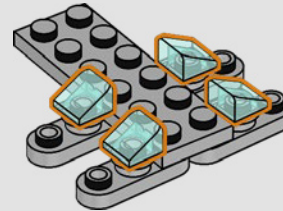

5

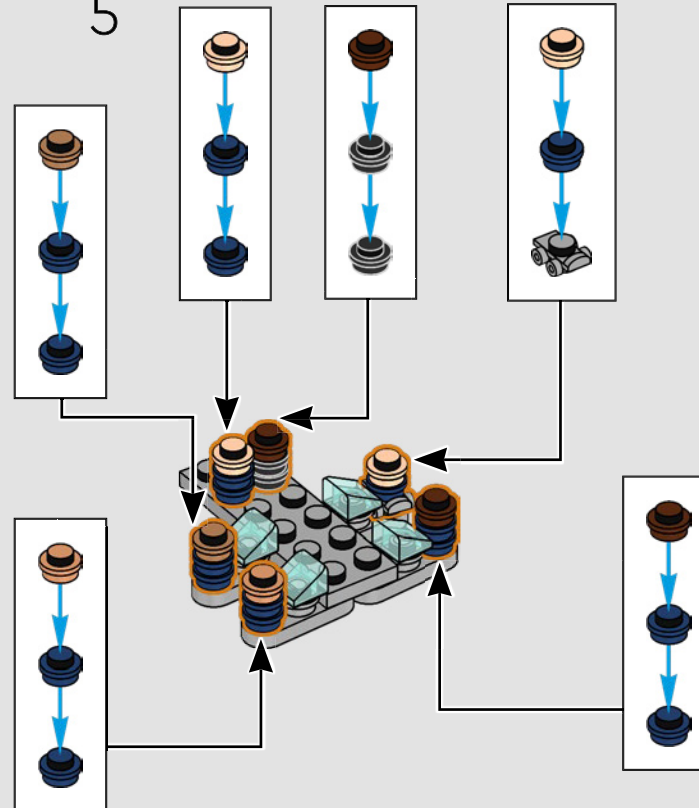

Meet Agent Rachael! One of the stacks of 1x1 plates representing a S.H.I.E.L.D. agent has a LEGO® roller skate element as its lower part – a nod to our design-team intern who uses a wheelchair.

Rencontrez l'agent Rachael! L'une des piles de plaques 1x1 représentant un agent du S.H.I.E.L.D. a un élément de patin à roulettes LEGO® comme partie inférieure – un clin d'œil à notre stagiaire de l'équipe de conception qui utilise un fauteuil roulant.

¡Conoce a la agente Rachael! Una de las torres de cubiertas 1x1 que representan a una agente de S.H.I.E.L.D. tiene un elemento comúnmente utilizado en un patín LEGO® en su parte inferior como referencia a nuestra becaria del equipo de diseño que usa una silla de ruedas.

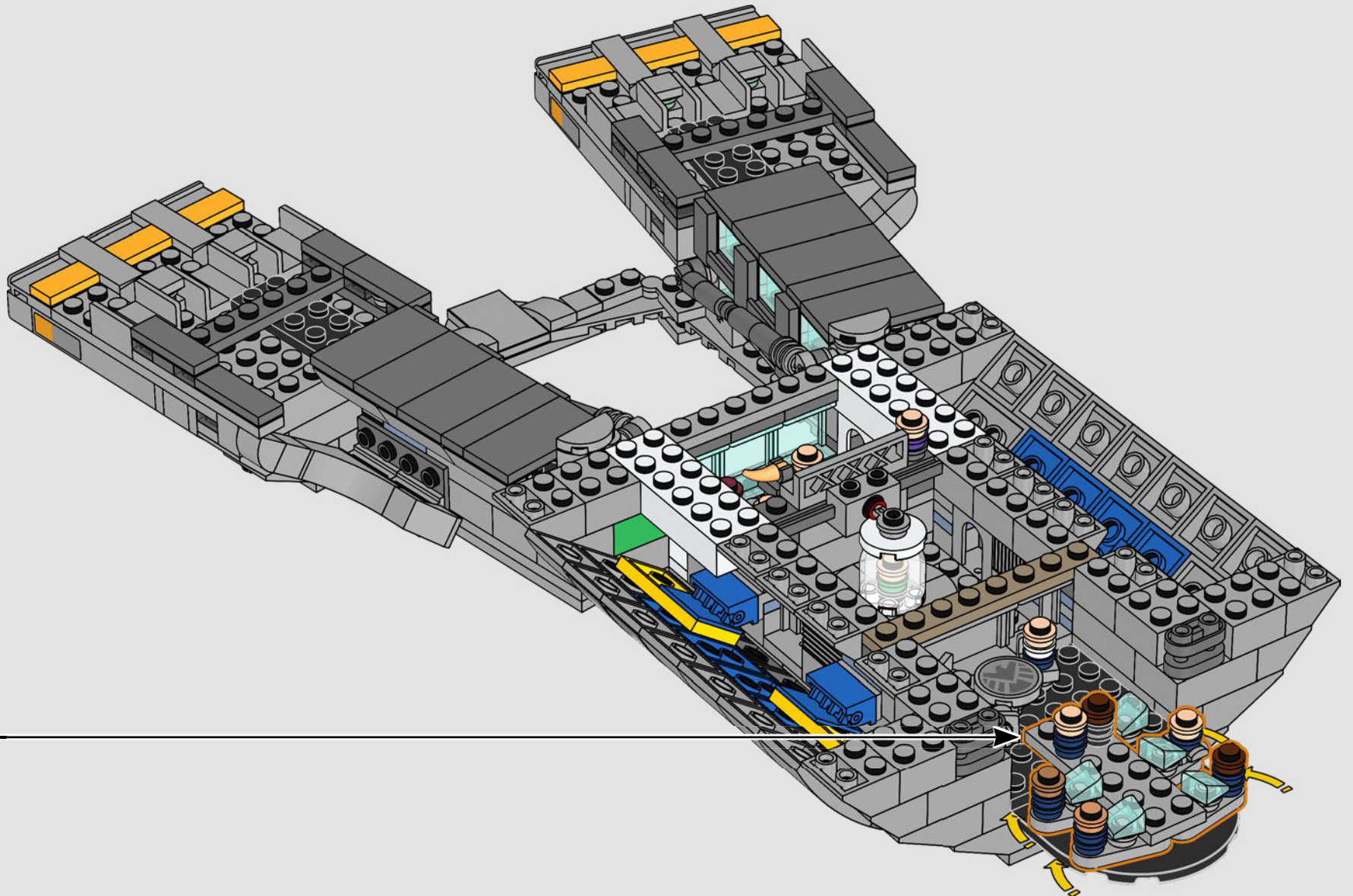

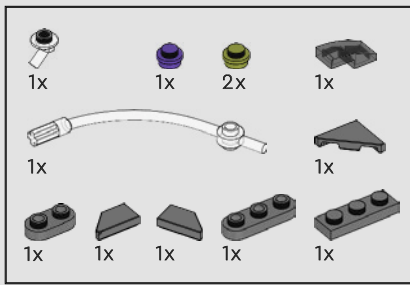

110

1

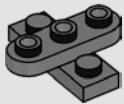

2

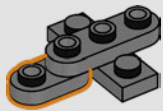

3



4



5



6

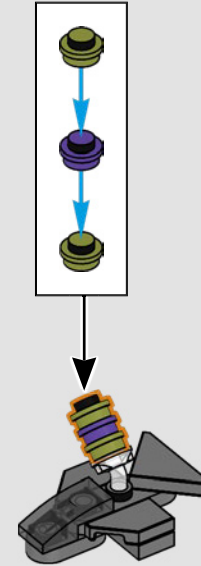

7

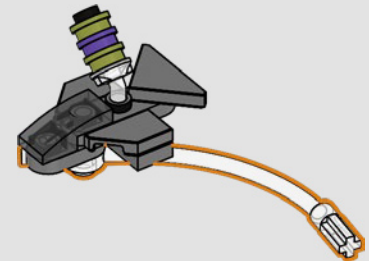

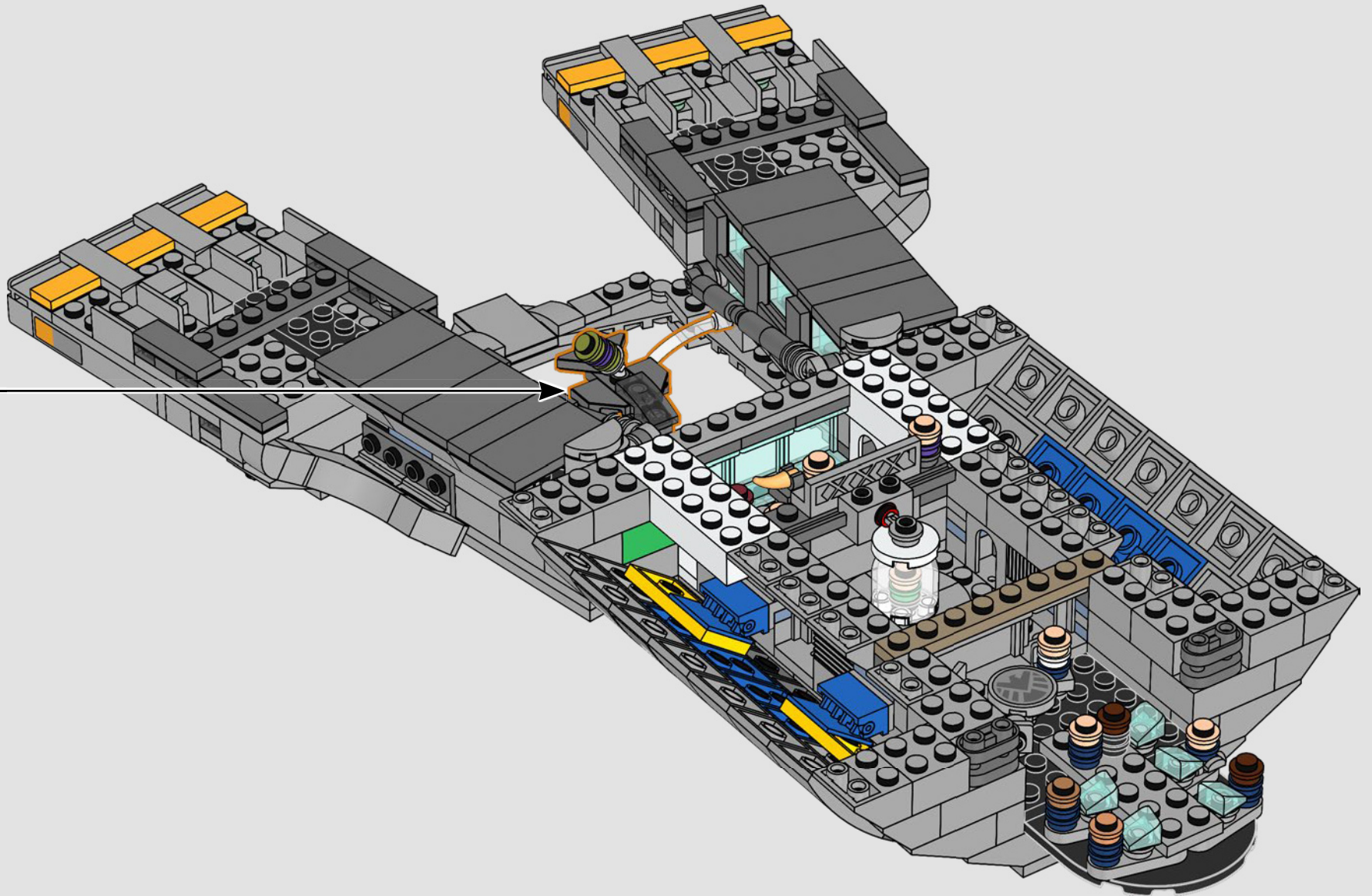

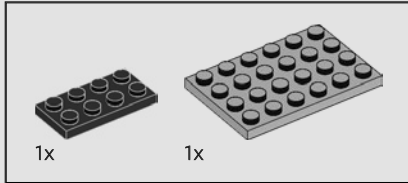
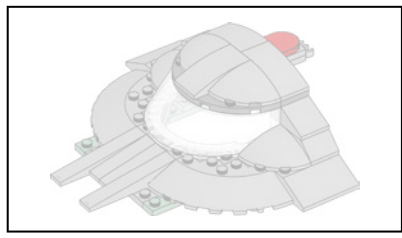

111

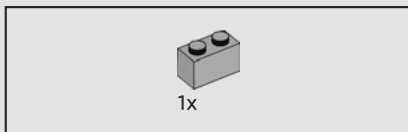
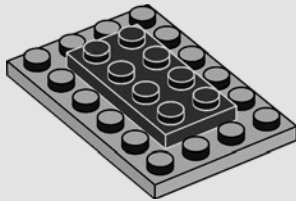

112

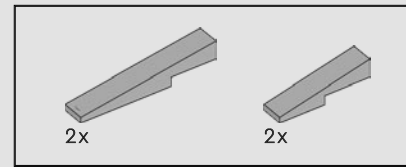
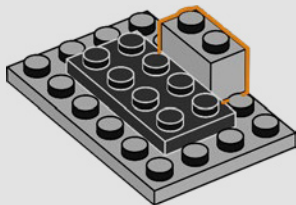

113

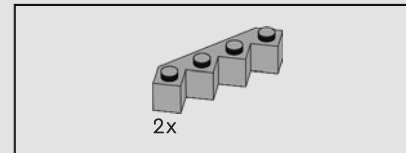
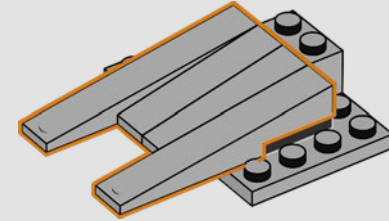

114

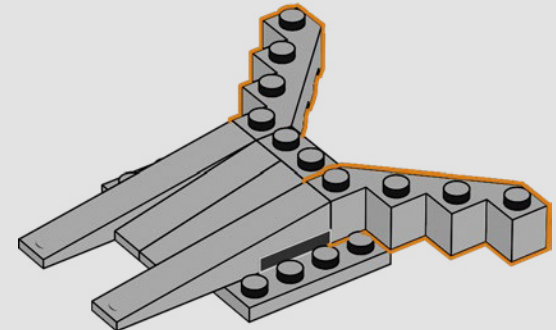

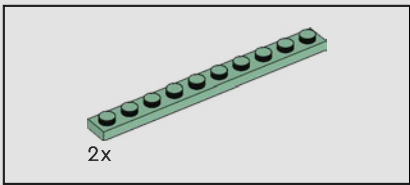

115

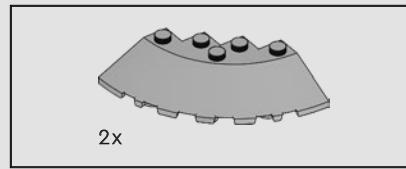
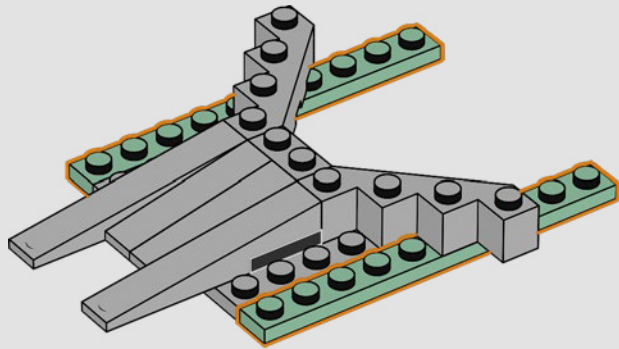

116

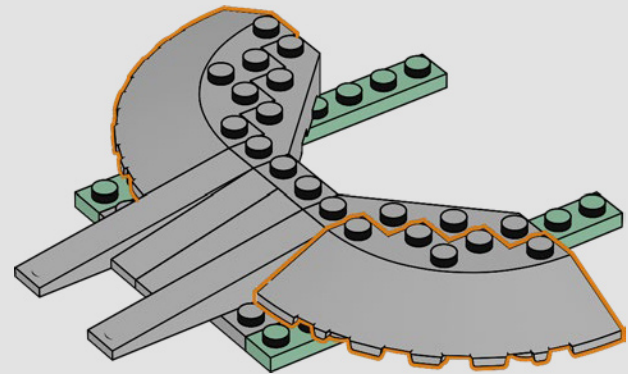

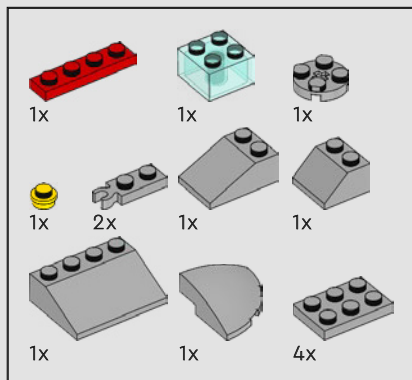

117

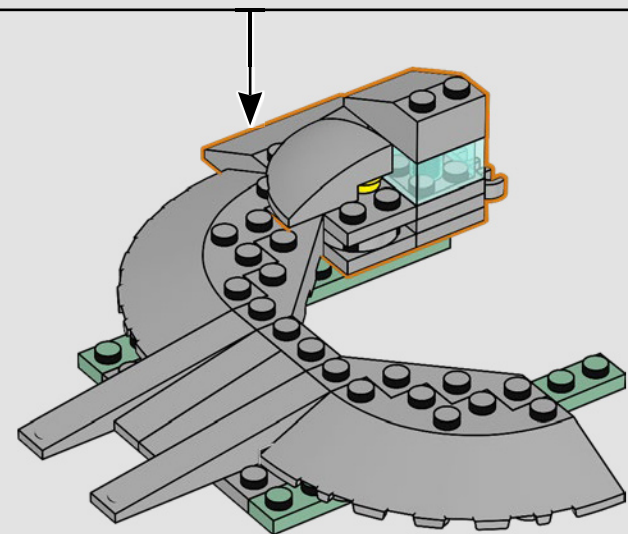
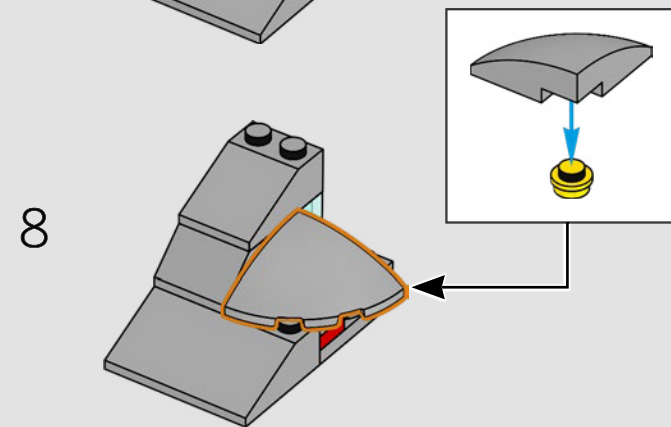
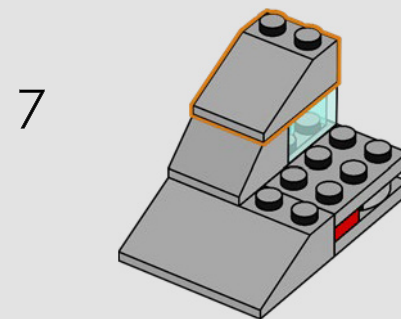
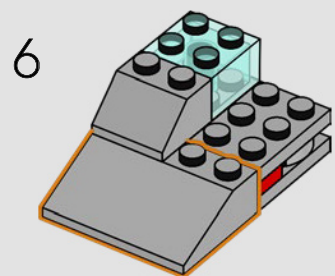
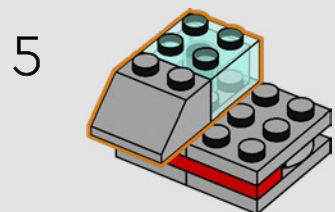
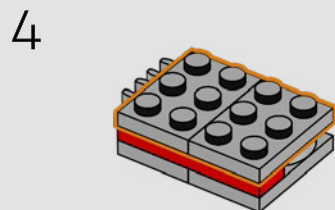
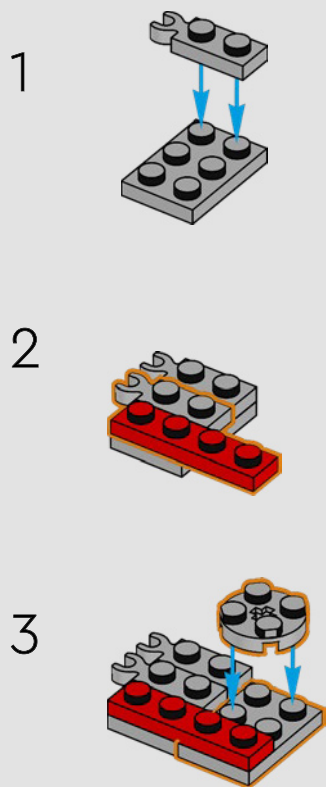

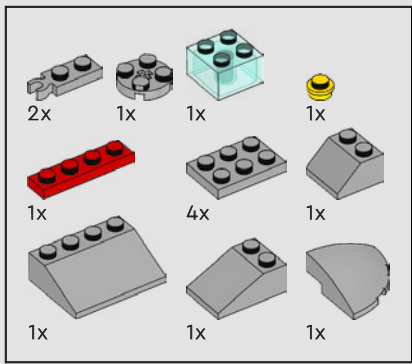

118

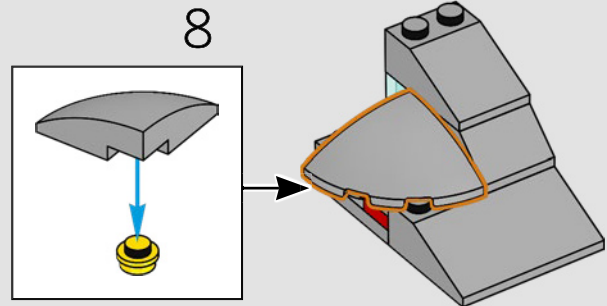
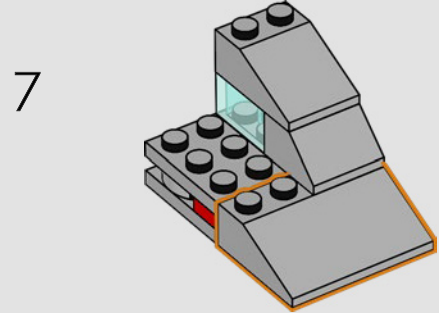
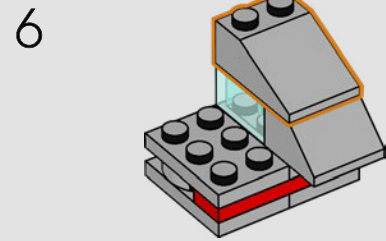
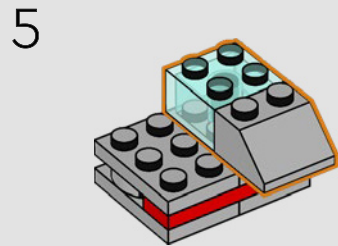
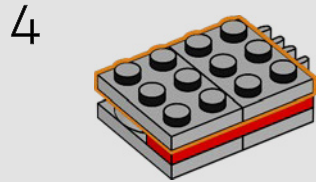
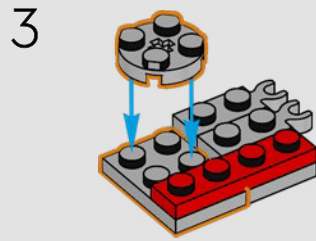
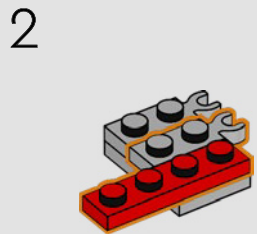
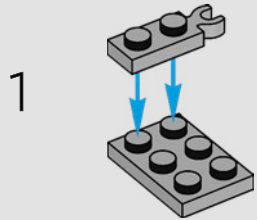

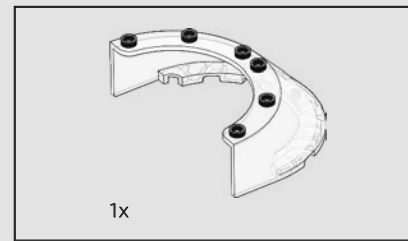
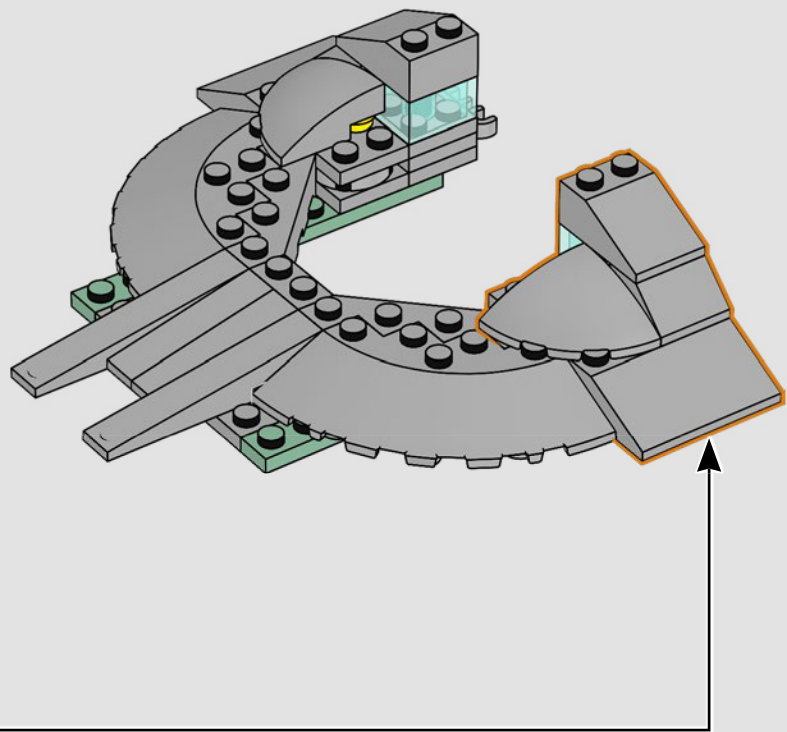

119

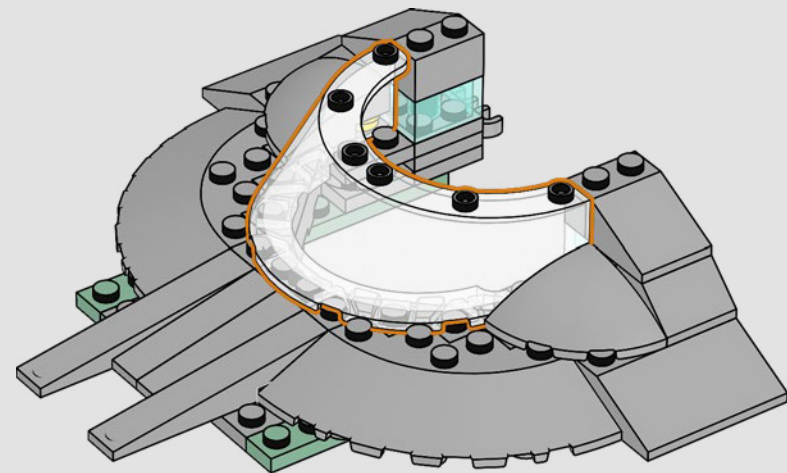

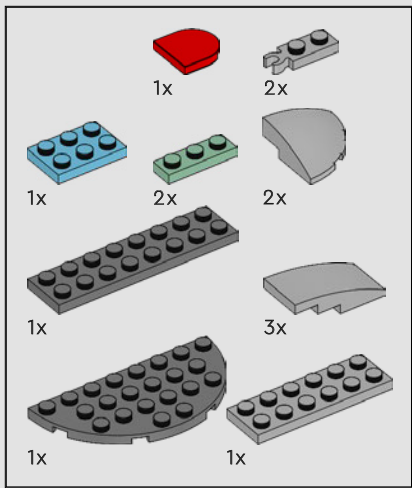

120

1

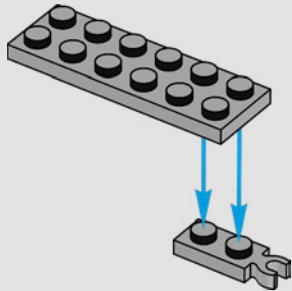

2

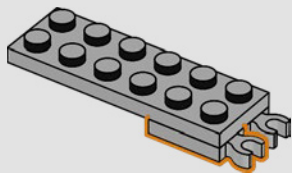

3

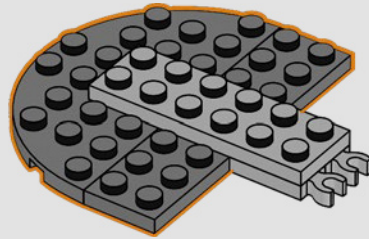

4

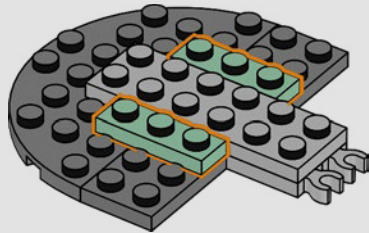

5

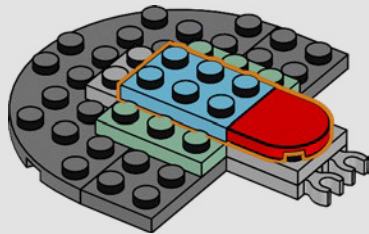

6

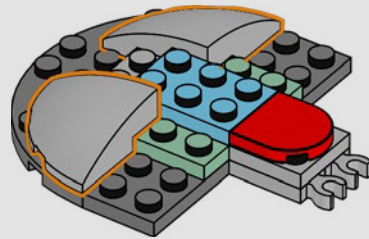

7

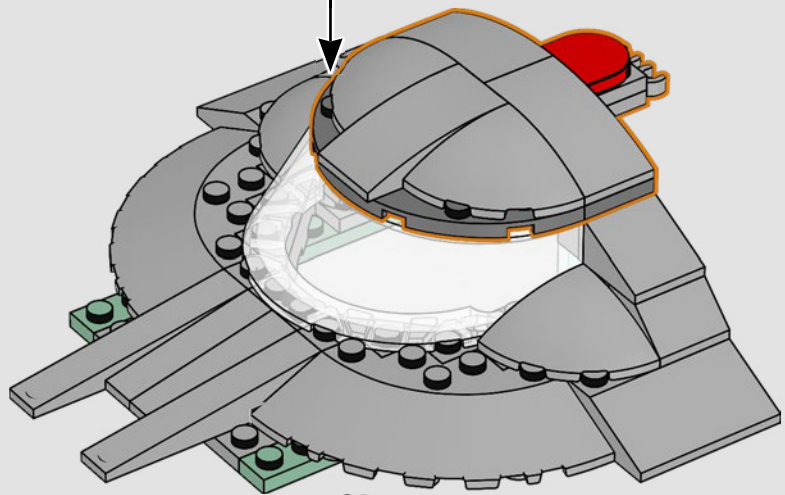
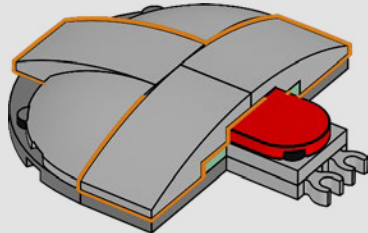

121

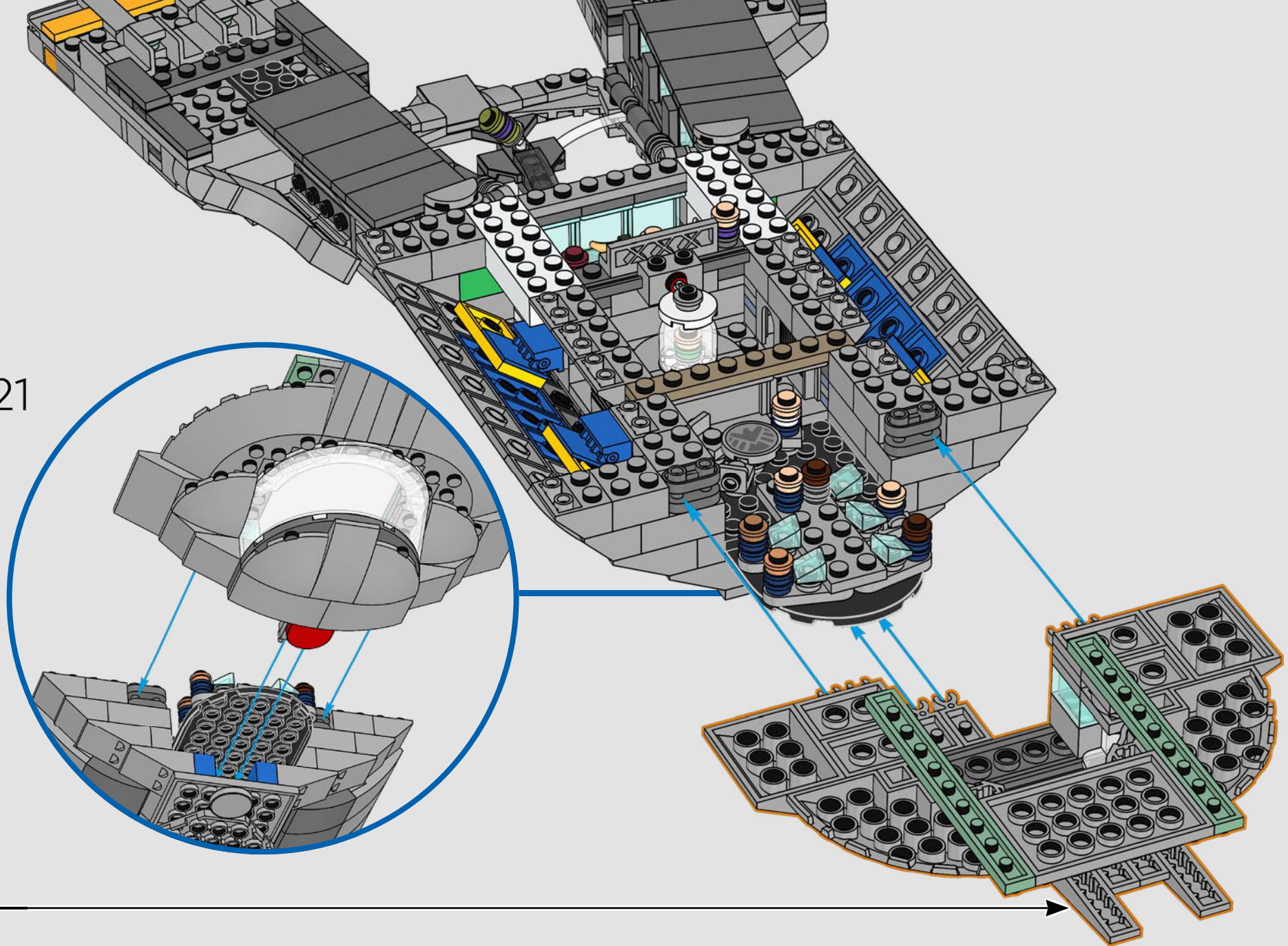

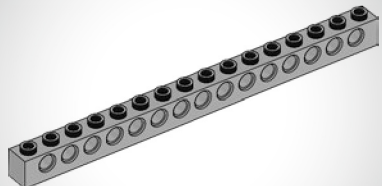
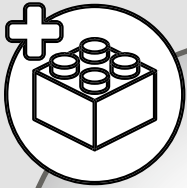

12x

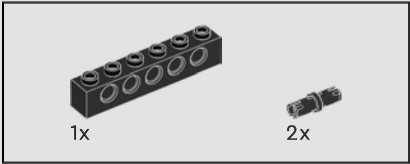
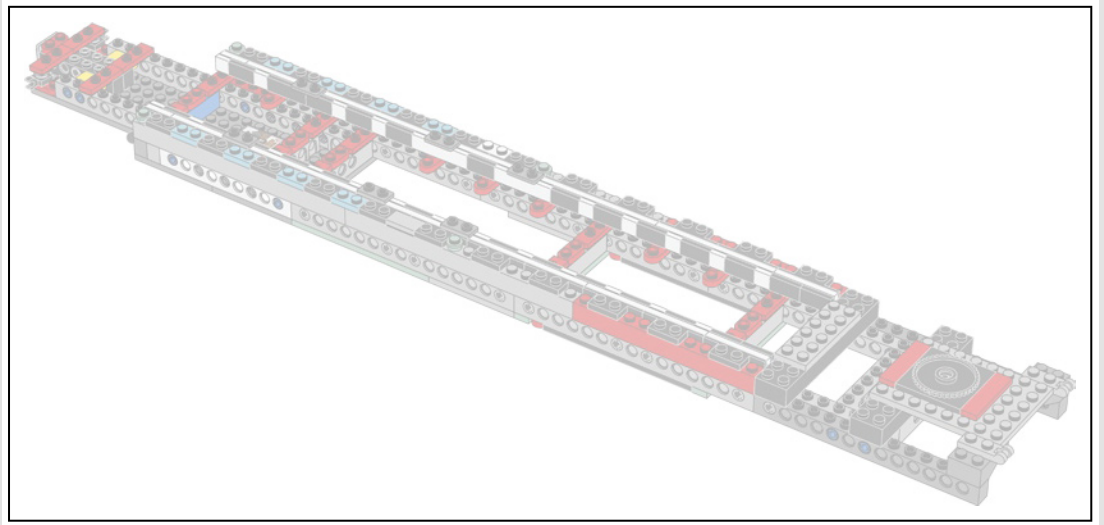

1x

2x

122

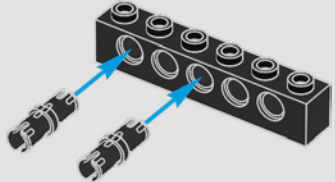

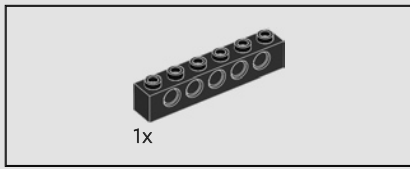

123

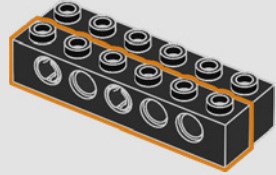

124

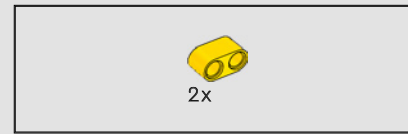
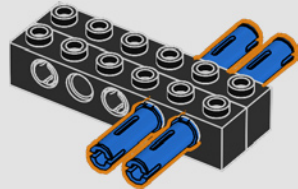

125

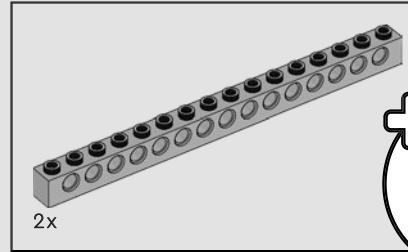
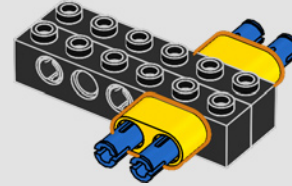

126

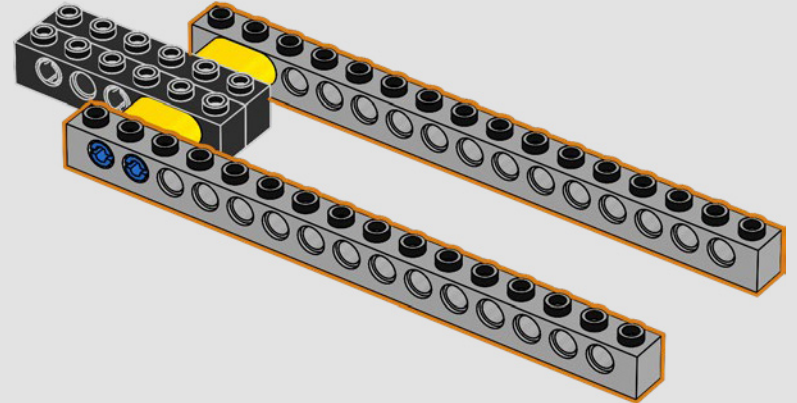

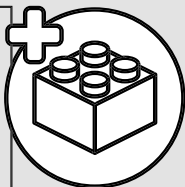
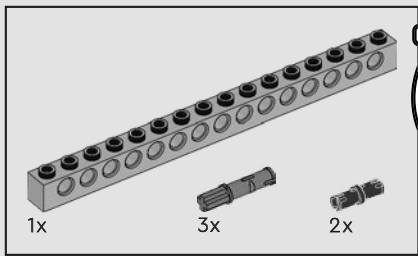

127

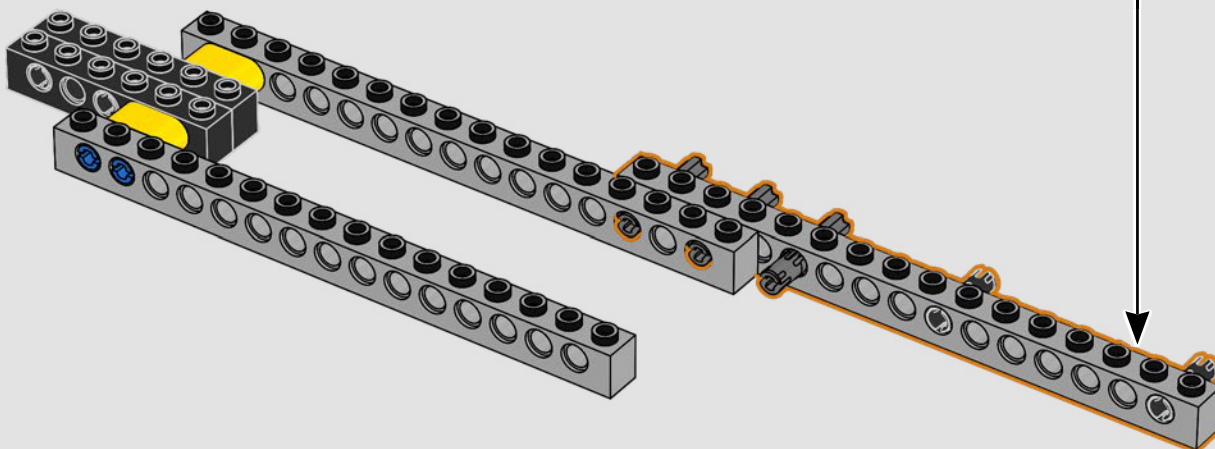
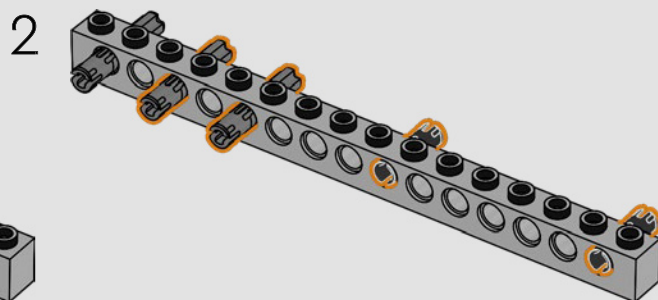
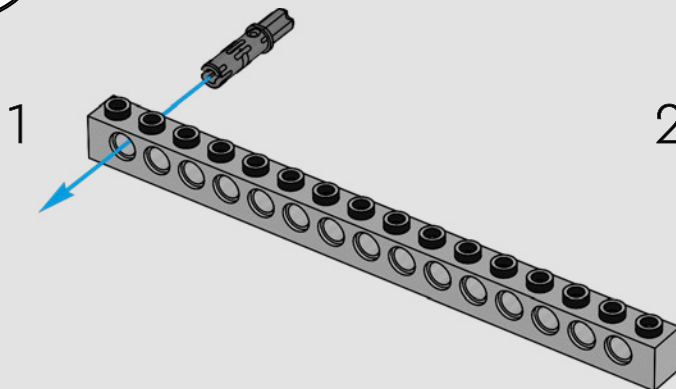

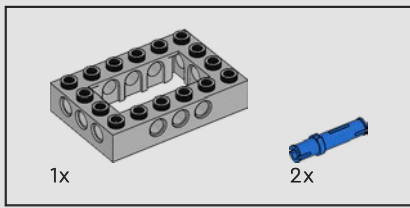

128

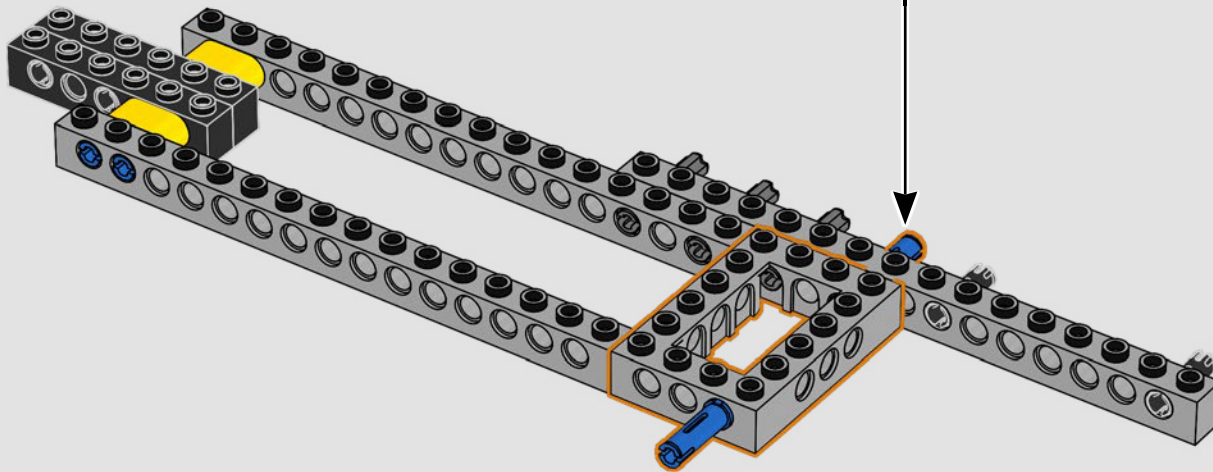
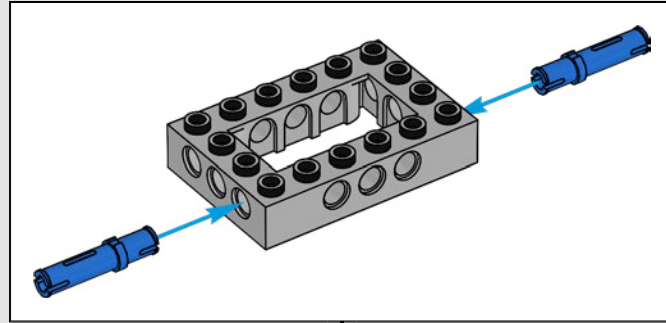

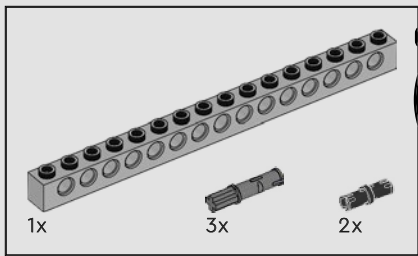

129

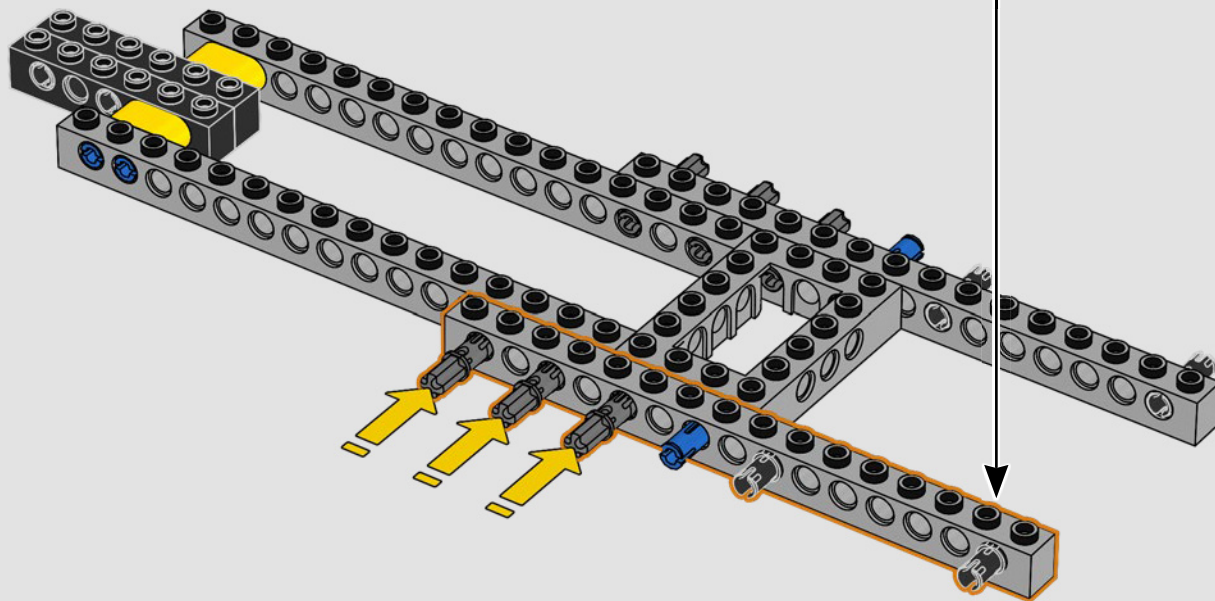
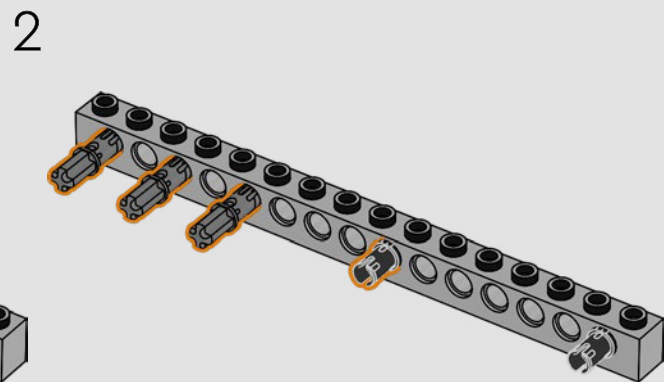
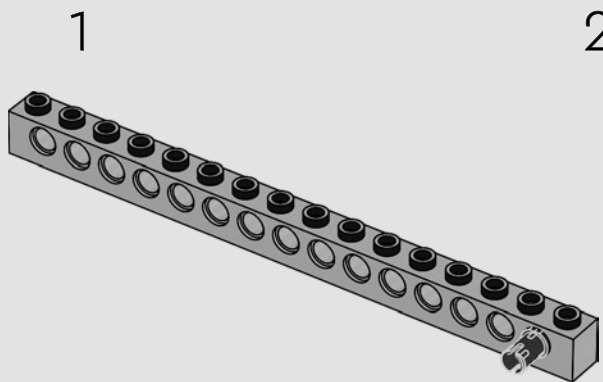

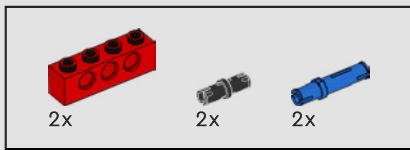

130

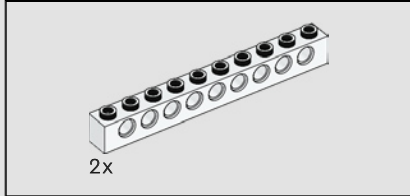
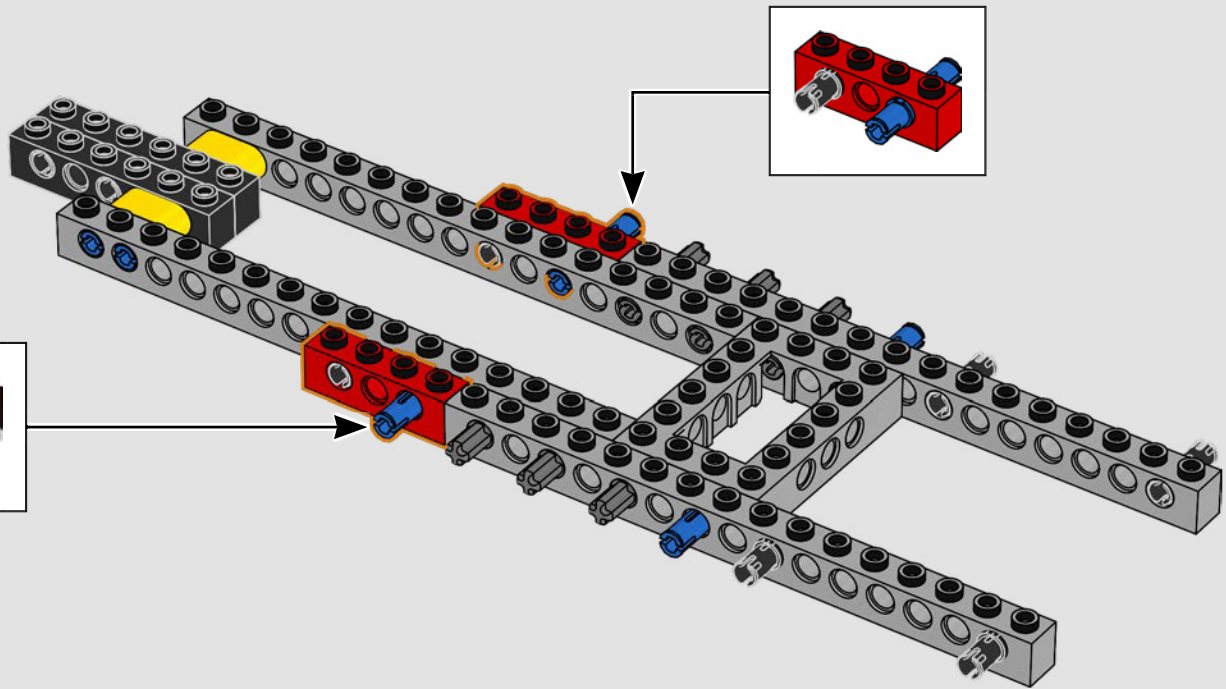
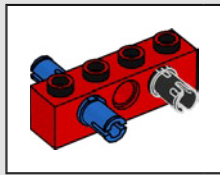

131

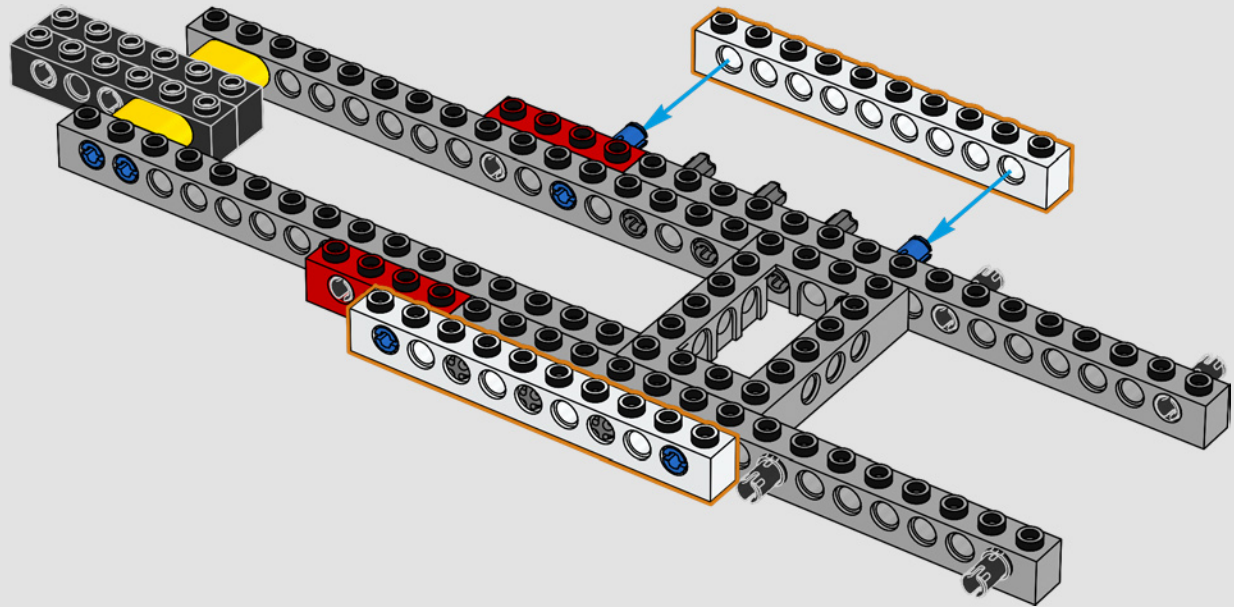

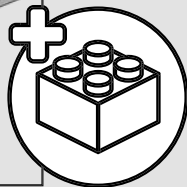
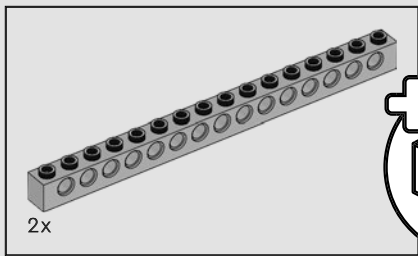

132

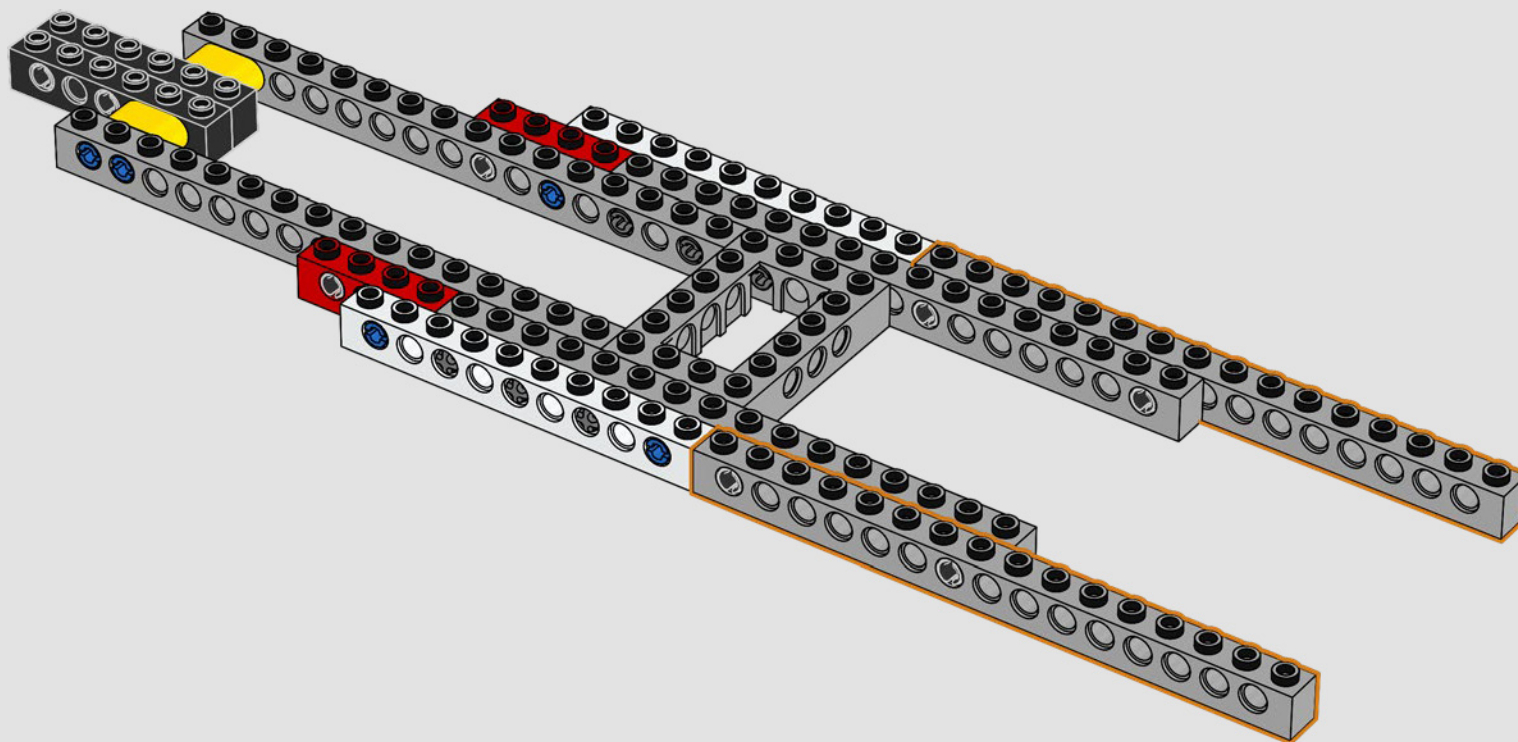

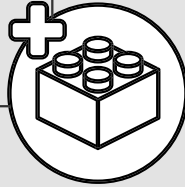
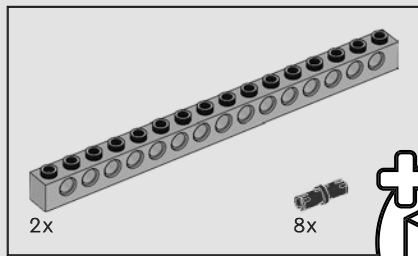

133

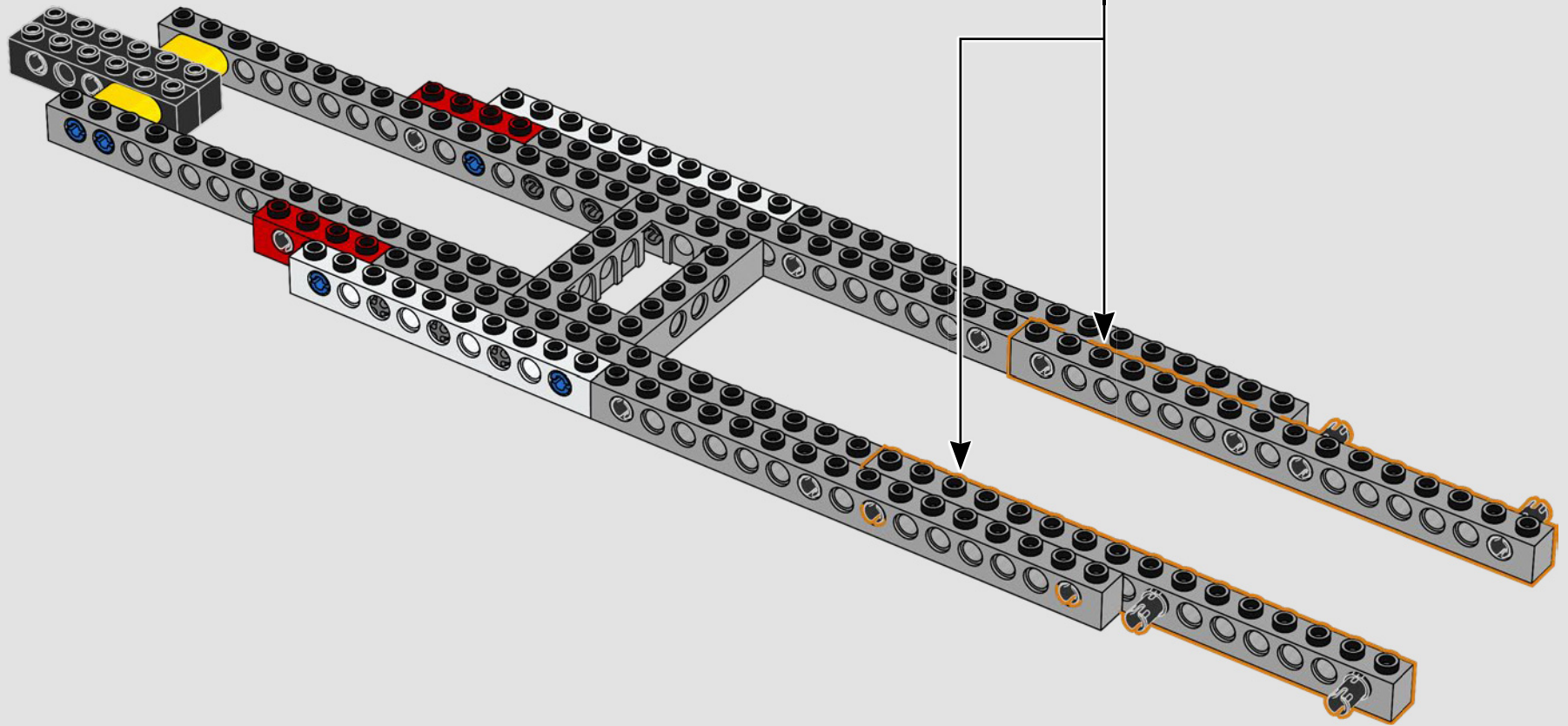
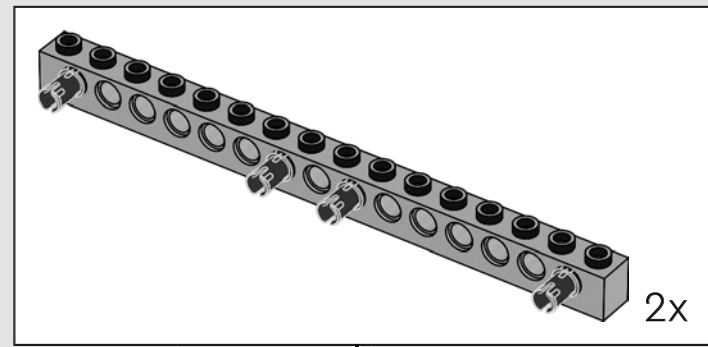

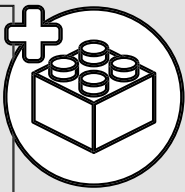
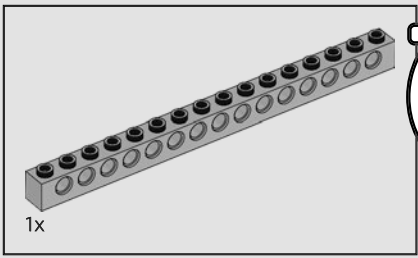

134

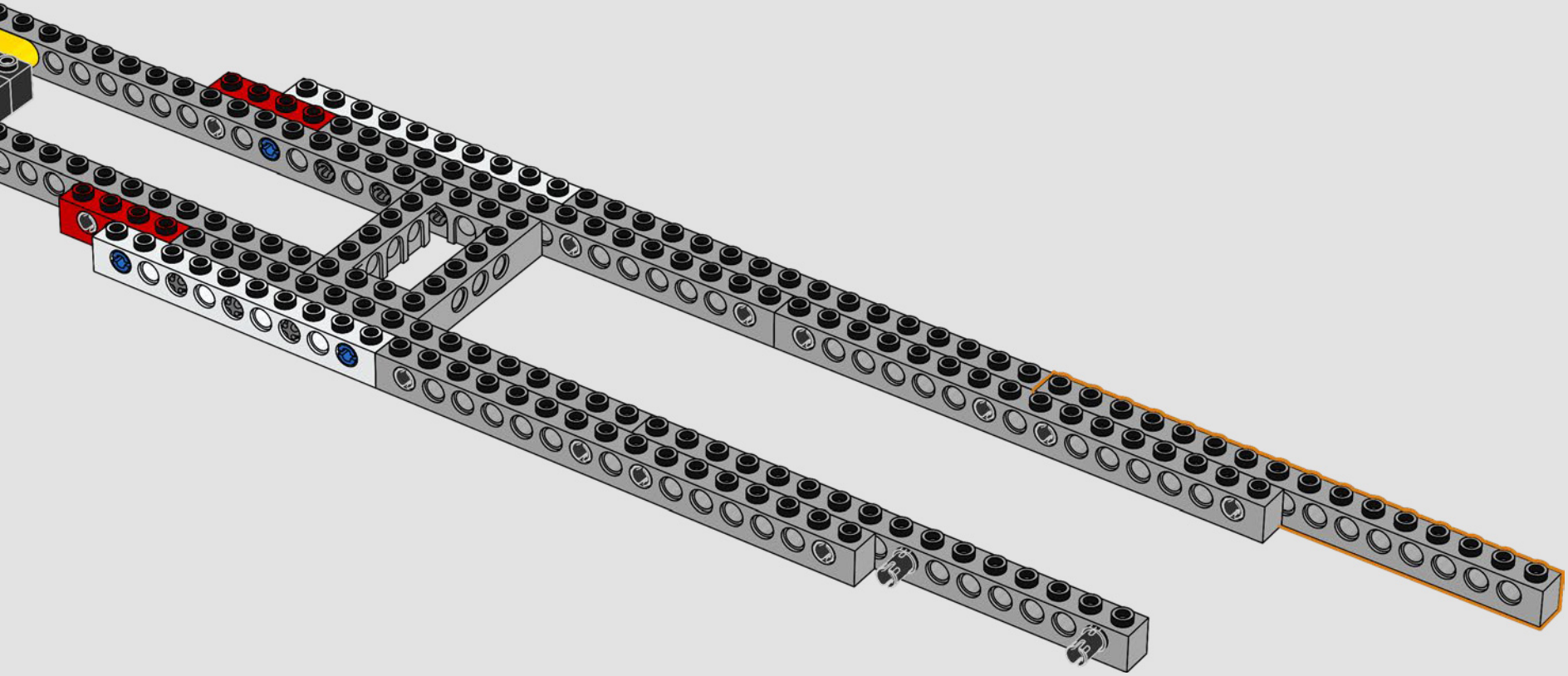

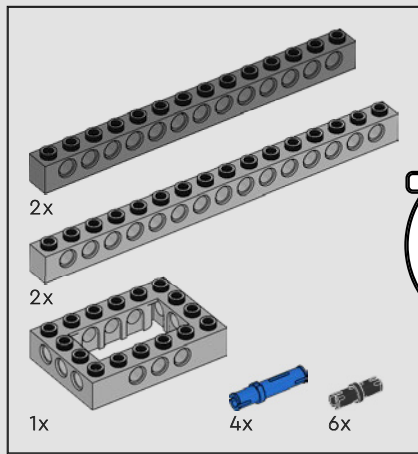

135

1

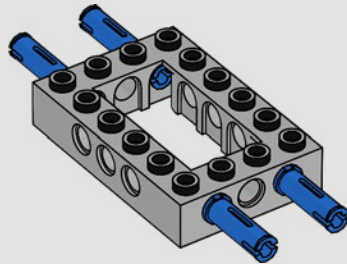

2

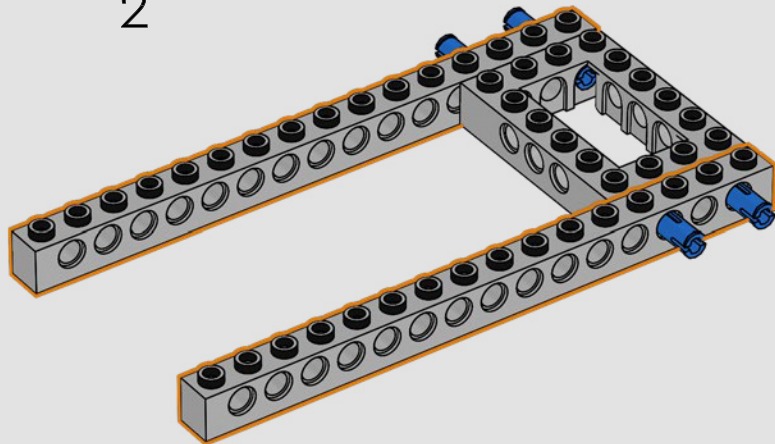

3

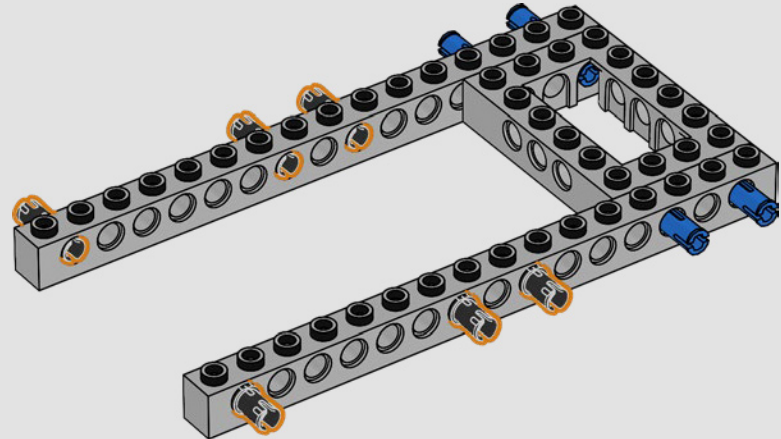

4

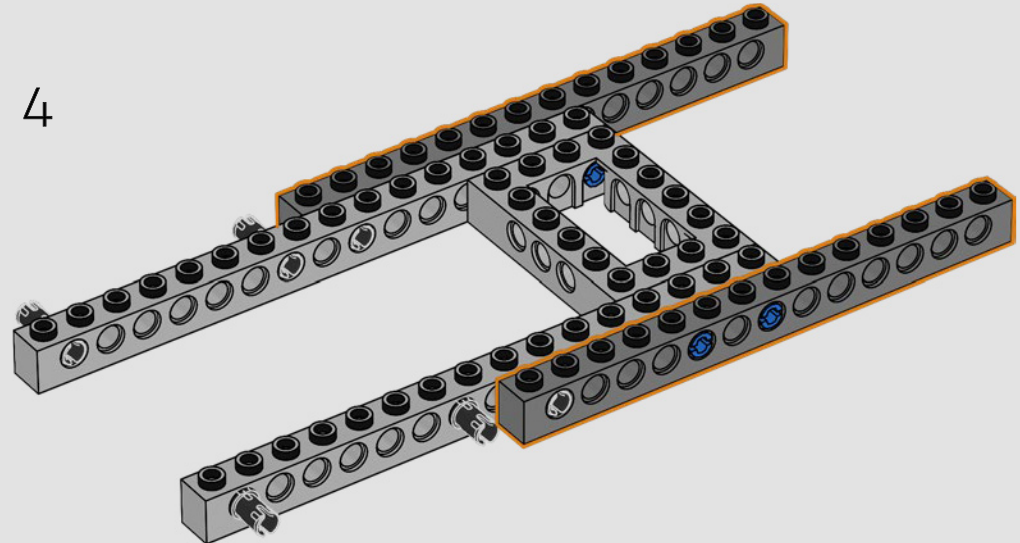

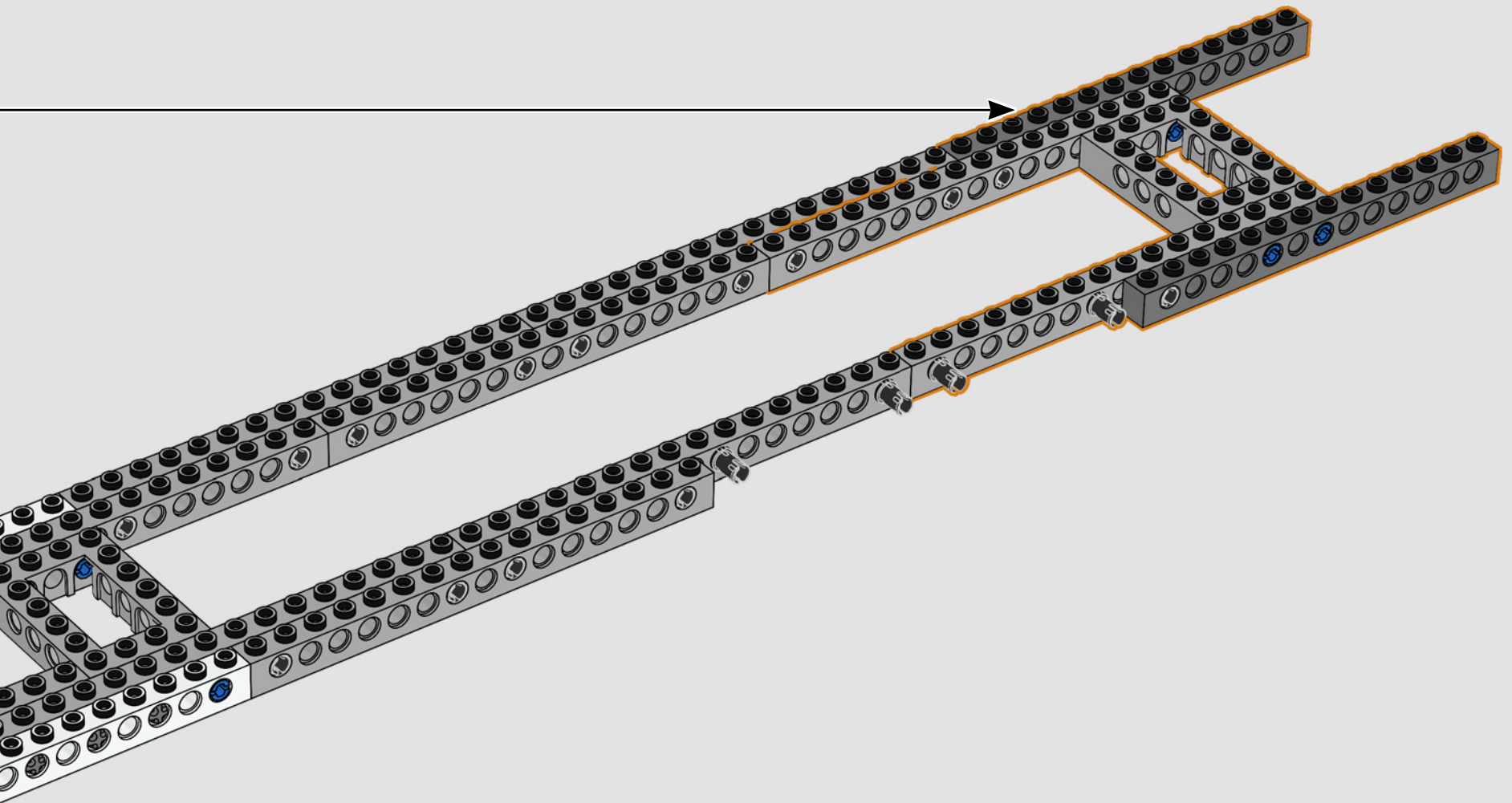

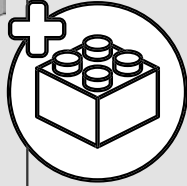
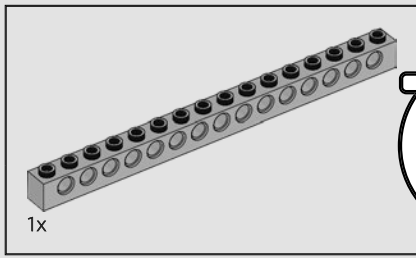

136

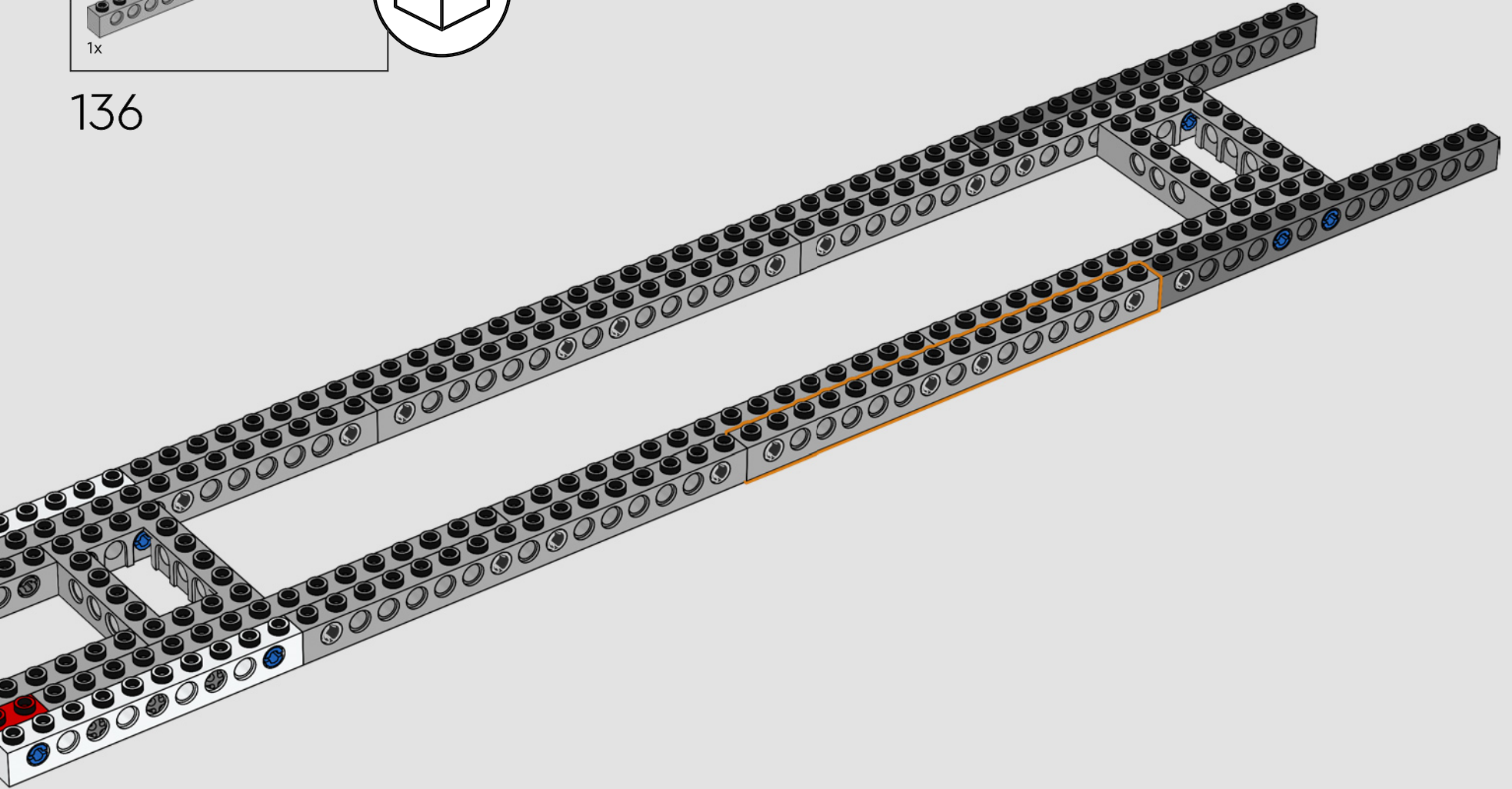

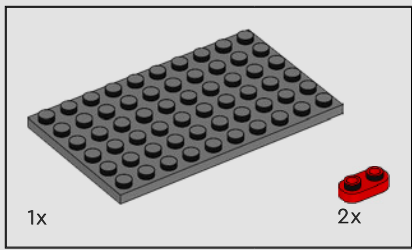

137

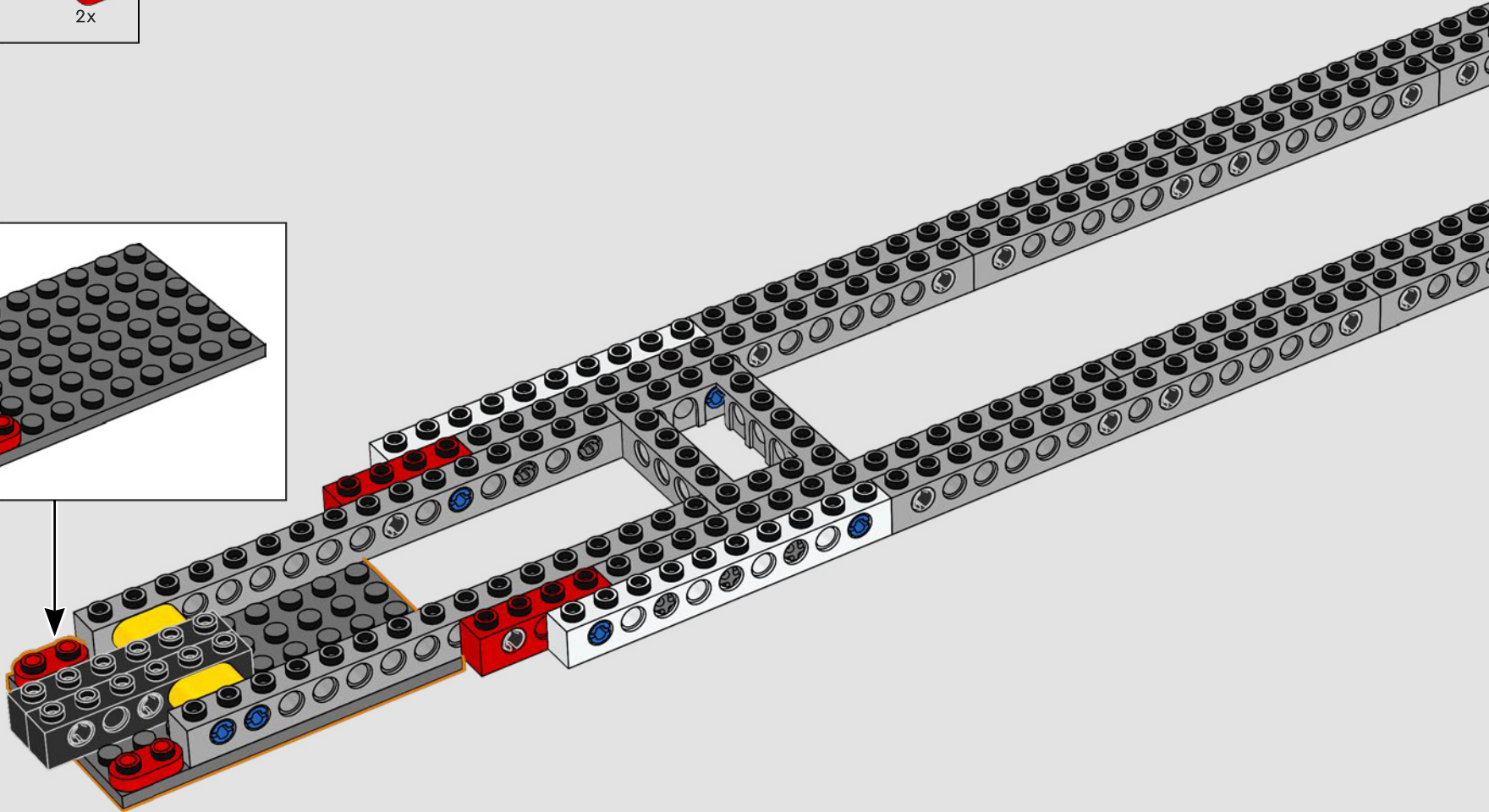
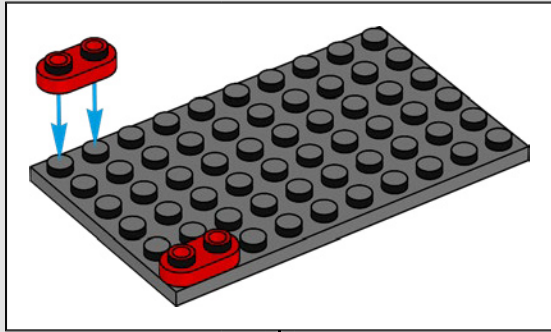

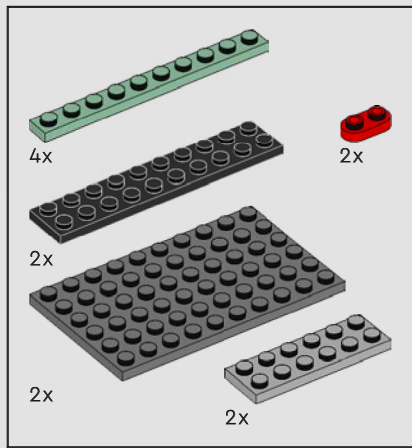

138

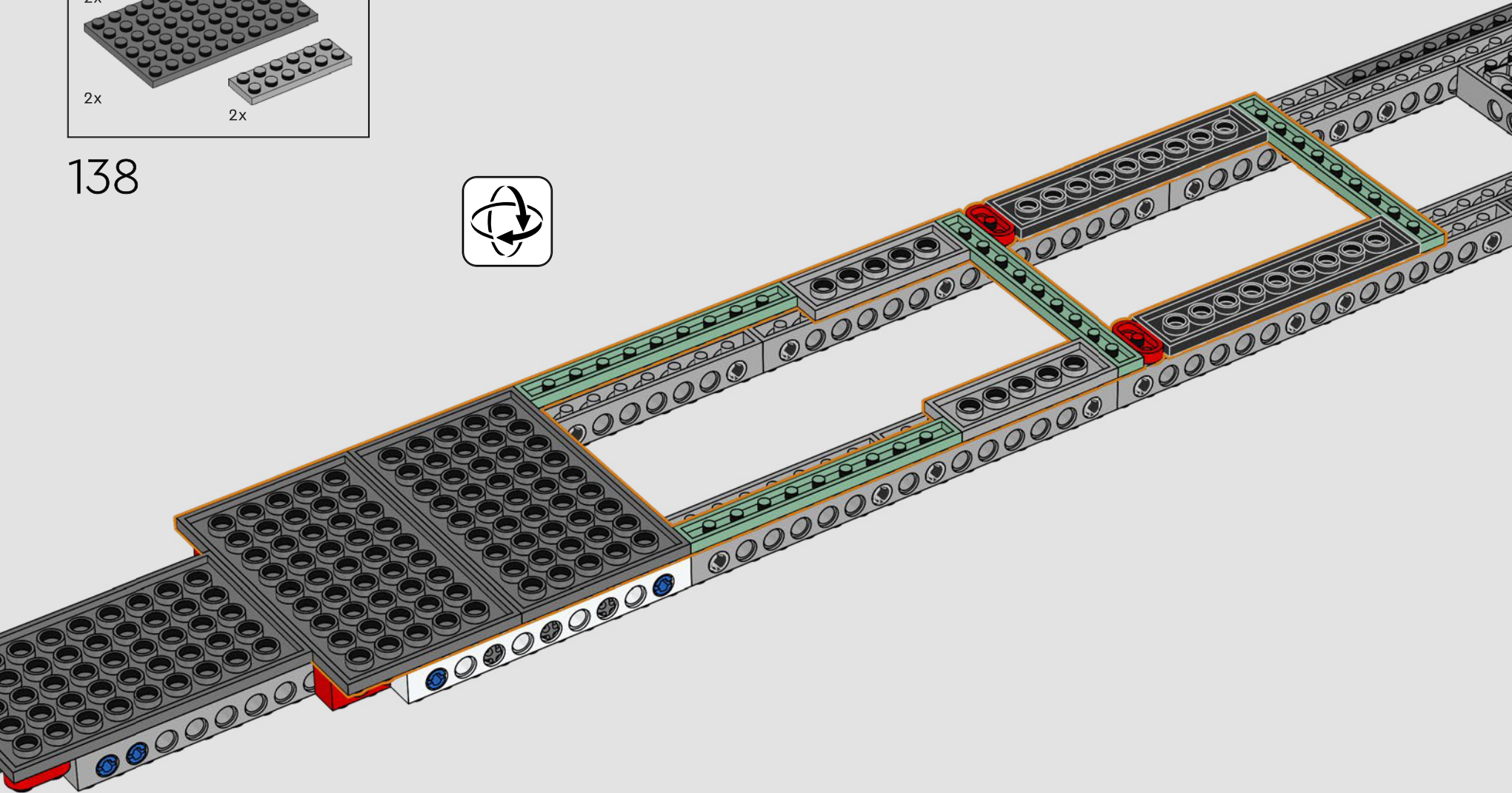
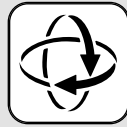

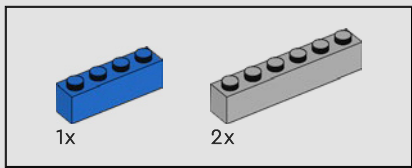

139

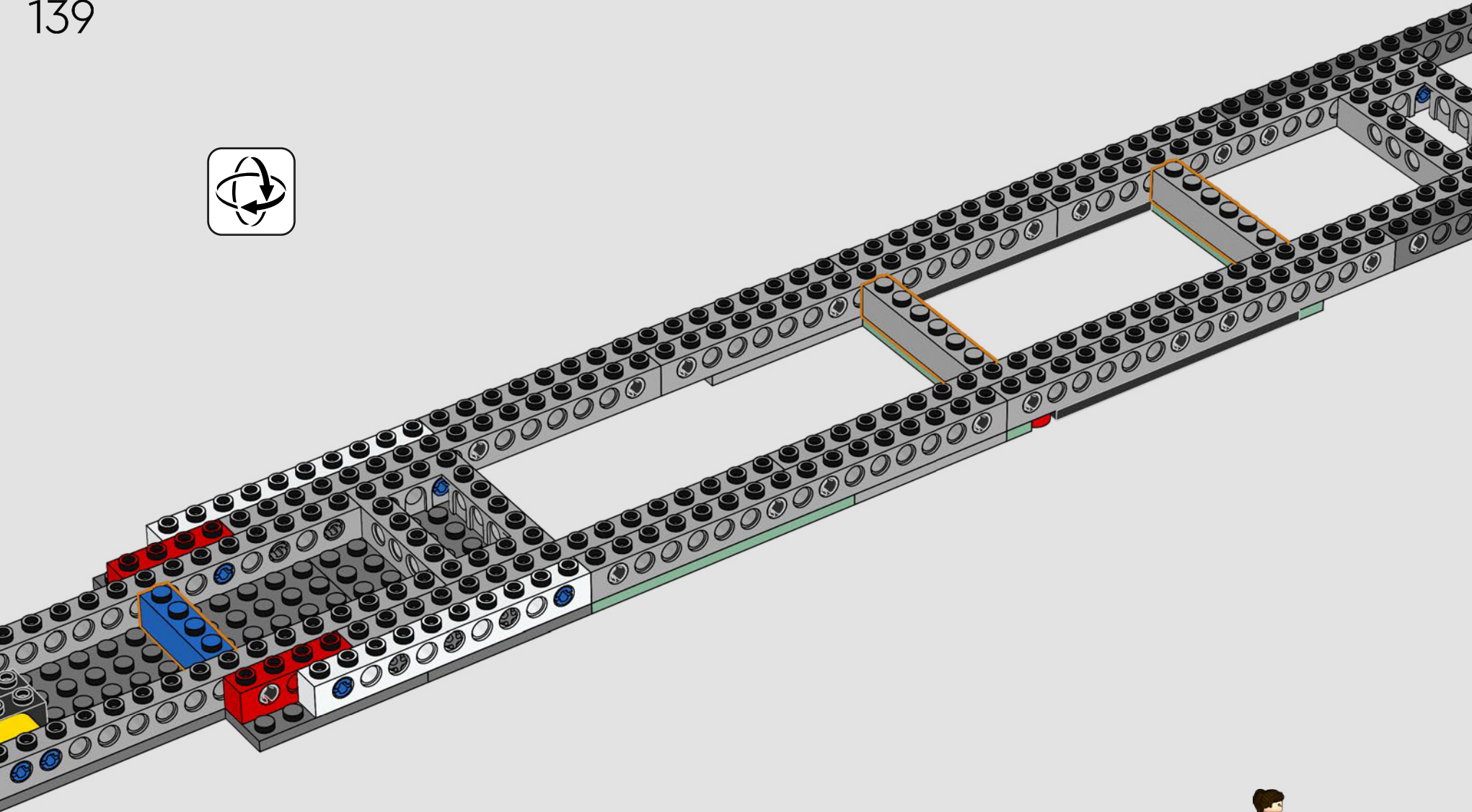

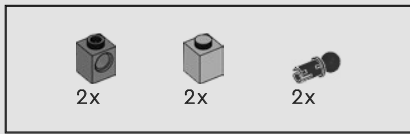

140

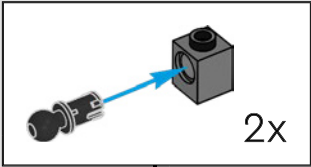
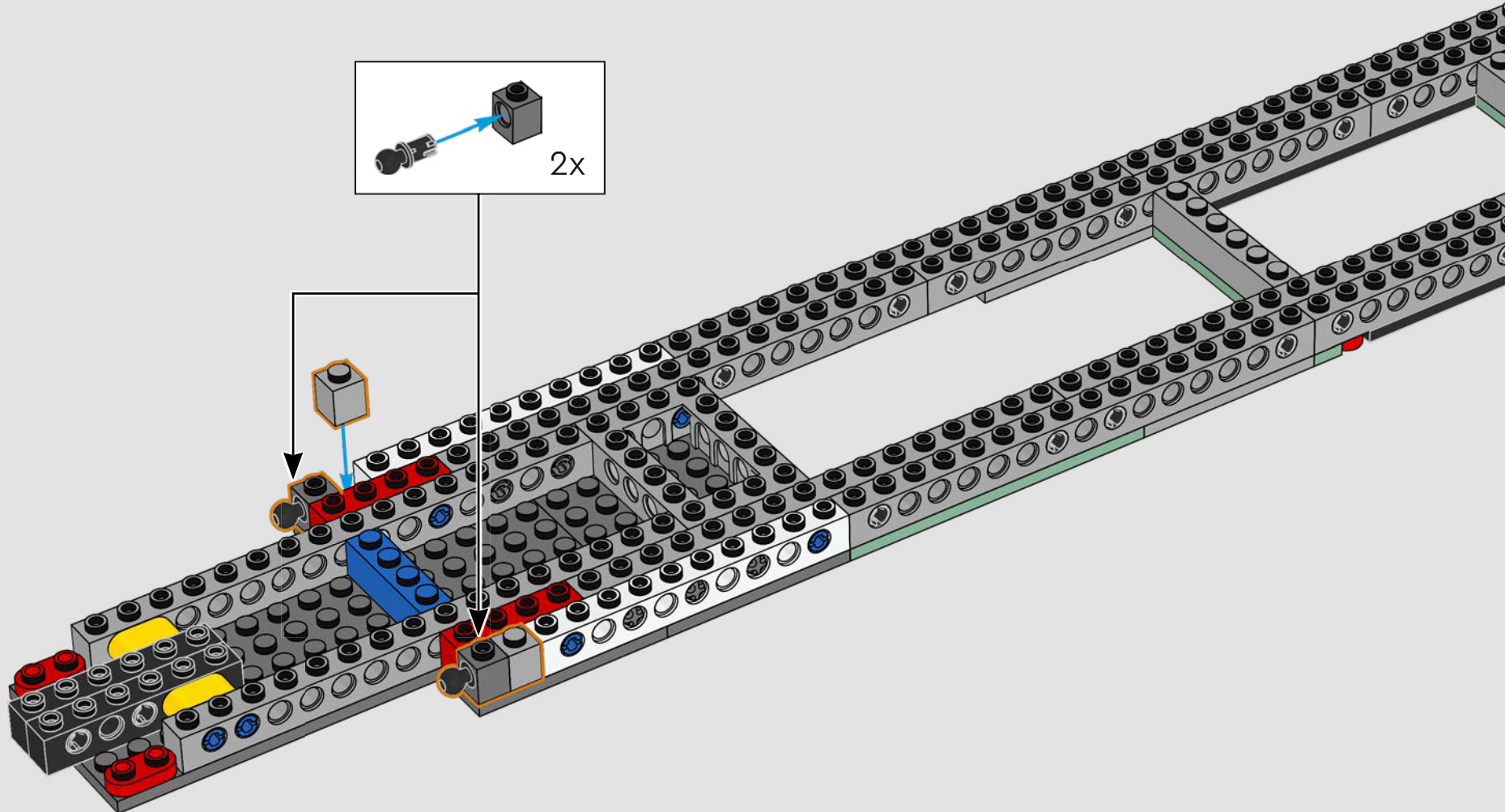



141

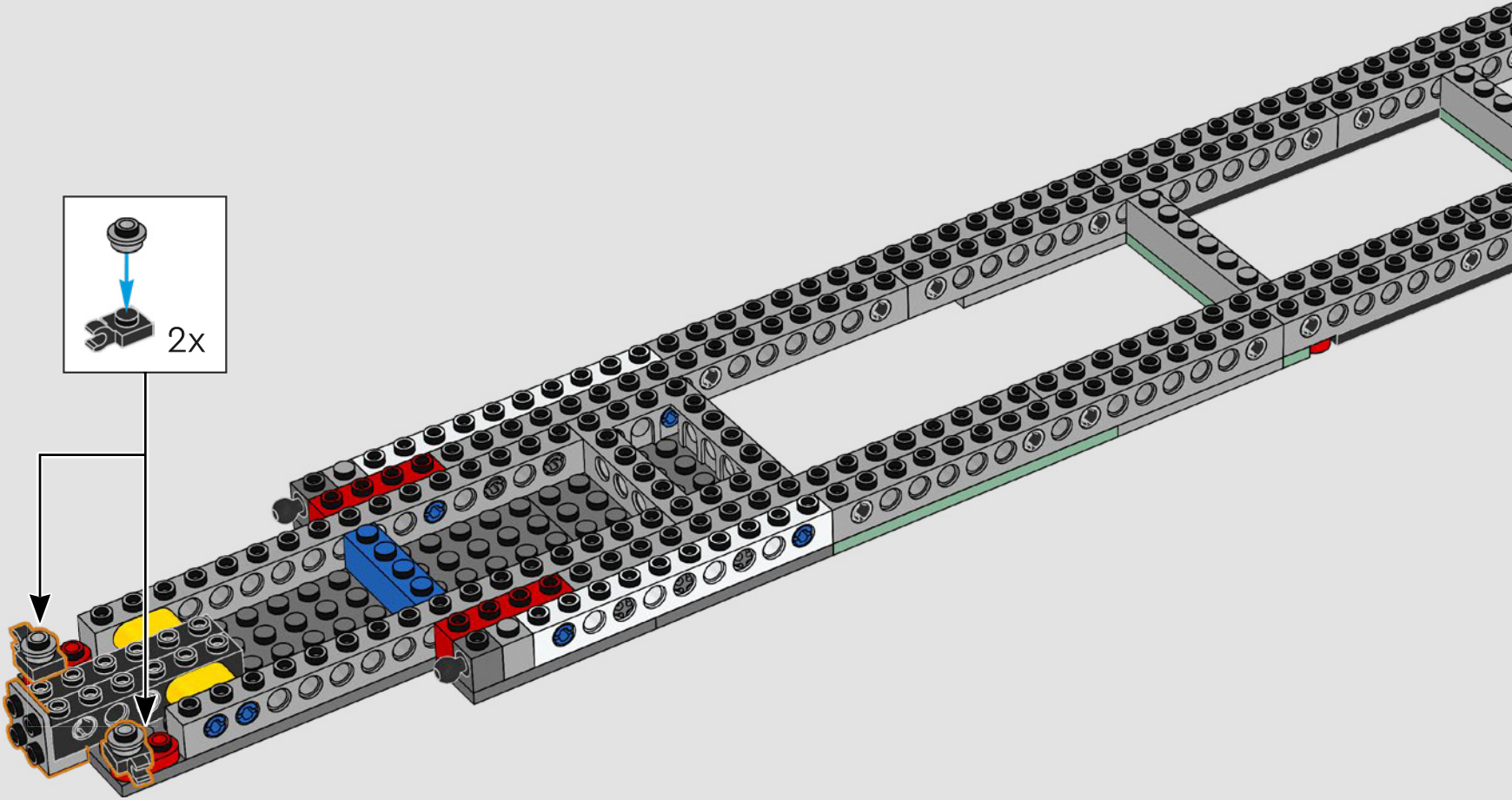

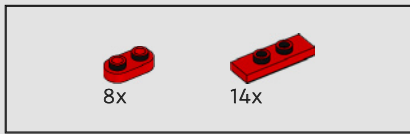

142

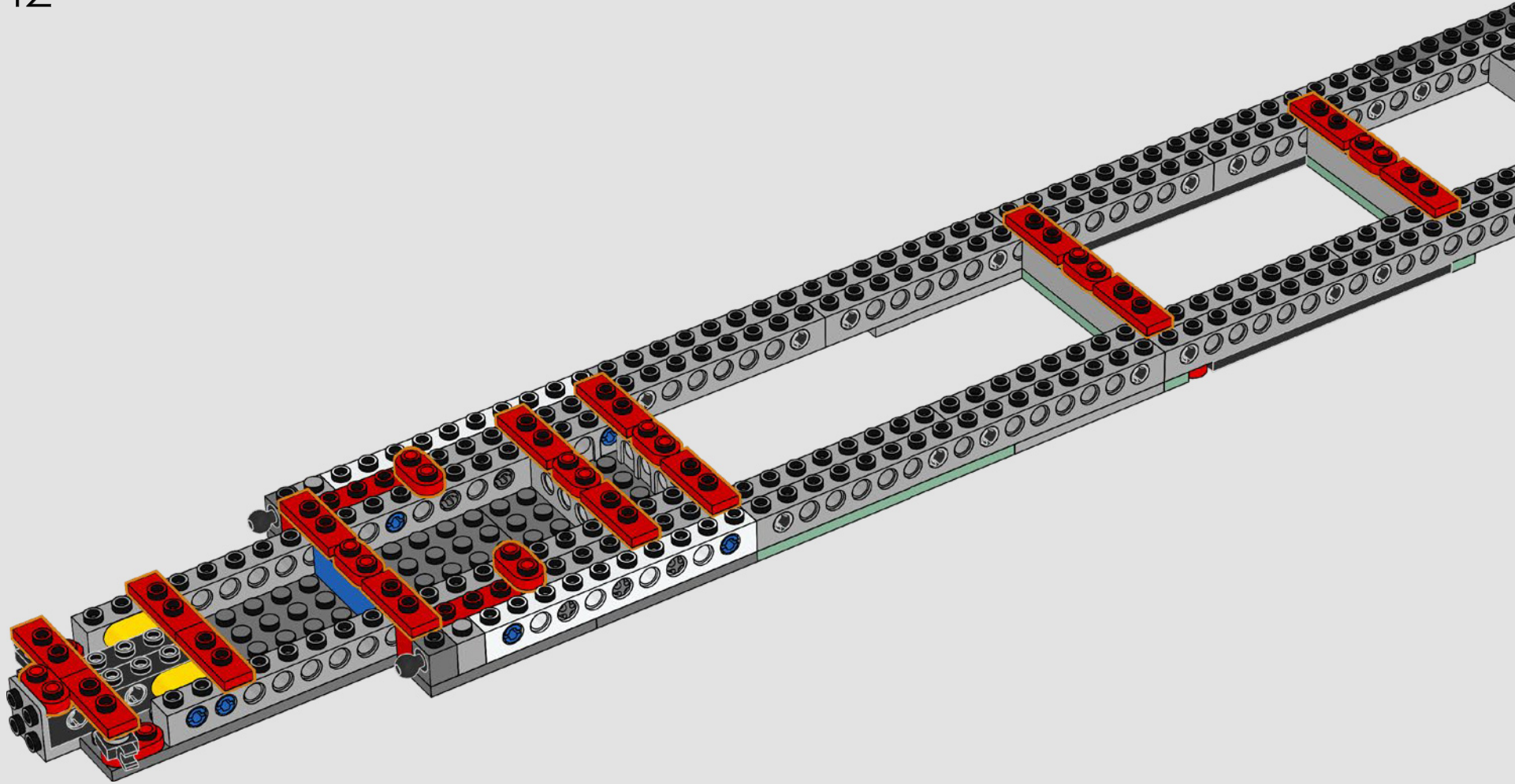

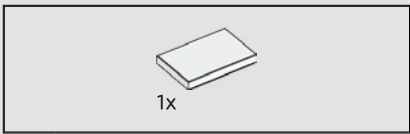

143

Hidden in the main superstructure is a LEGO® version of one of the first Marvel comics to feature The Winter Soldier on its front cover (Captain America no.11 - 2005).

Cachée dans la superstructure principale, une version LEGO® de l'une des premières bandes dessinées Marvel à présenter le Soldat de l'hiver sur sa couverture (Capitaine America no.11 - 2005).

Oculto en la superestructura principal se encuentra una versión LEGO® de uno de los primeros cómics de Marvel que presenta al Soldado del Invierno en su portada (Captain America n.º 11 [2005]).

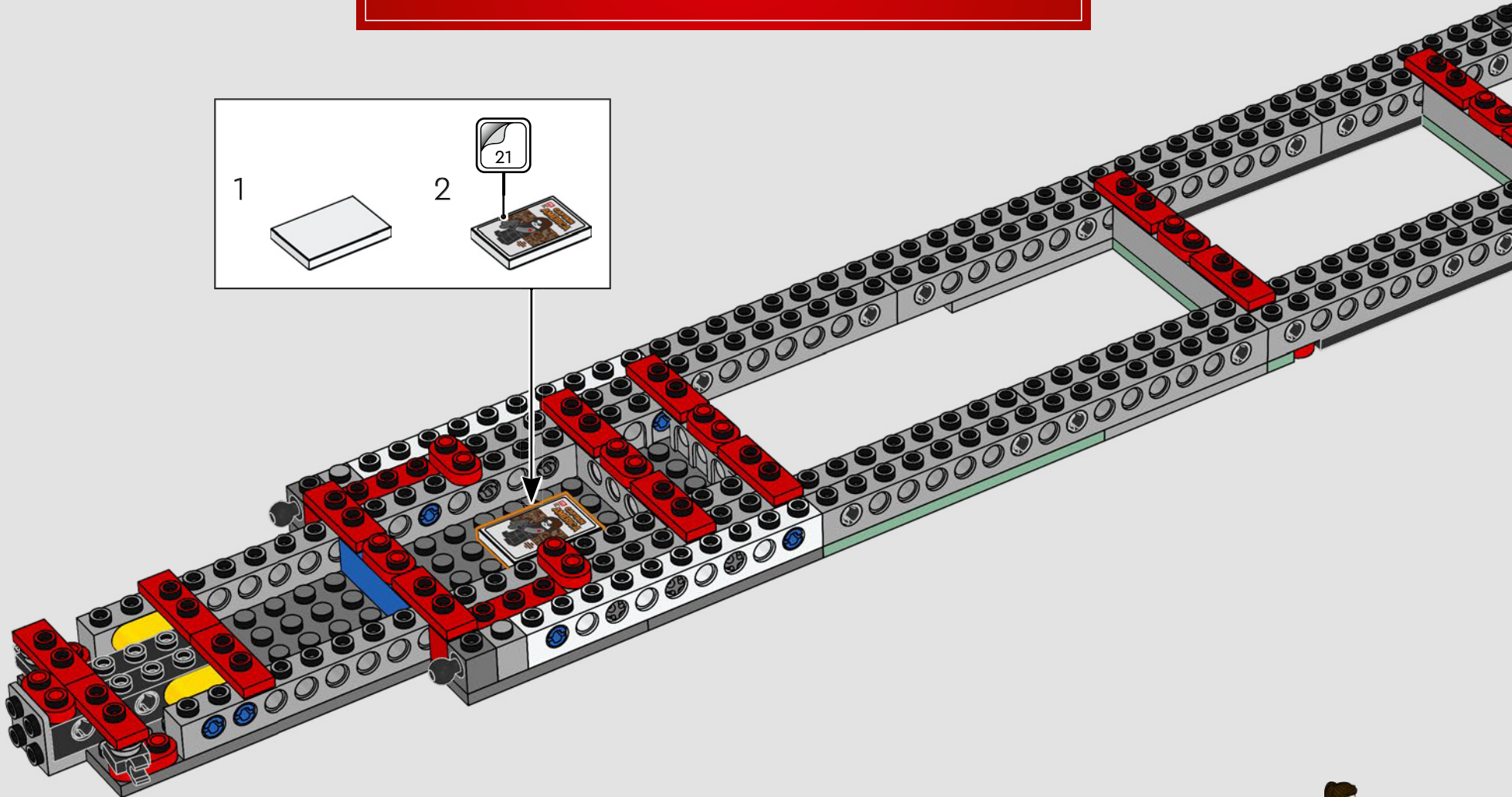
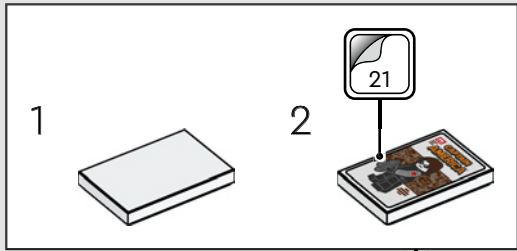

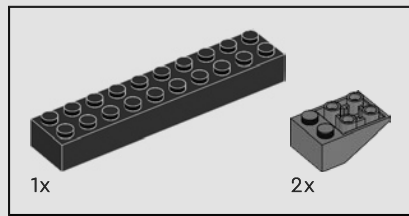

144

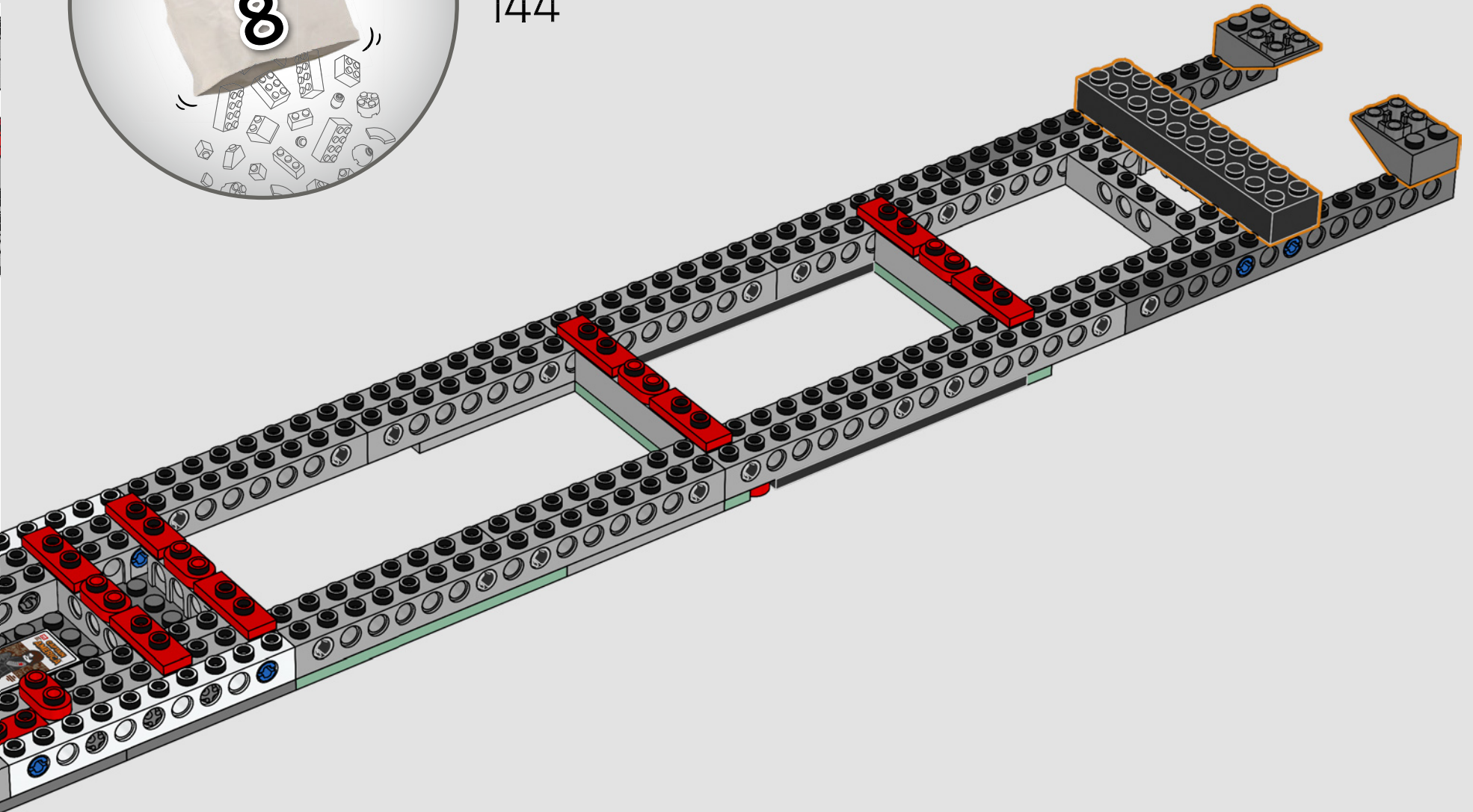

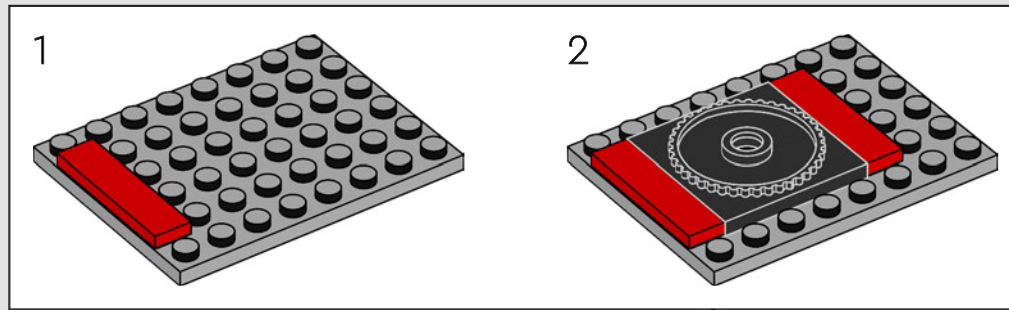
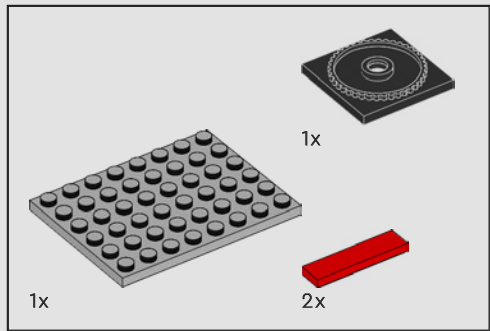

145

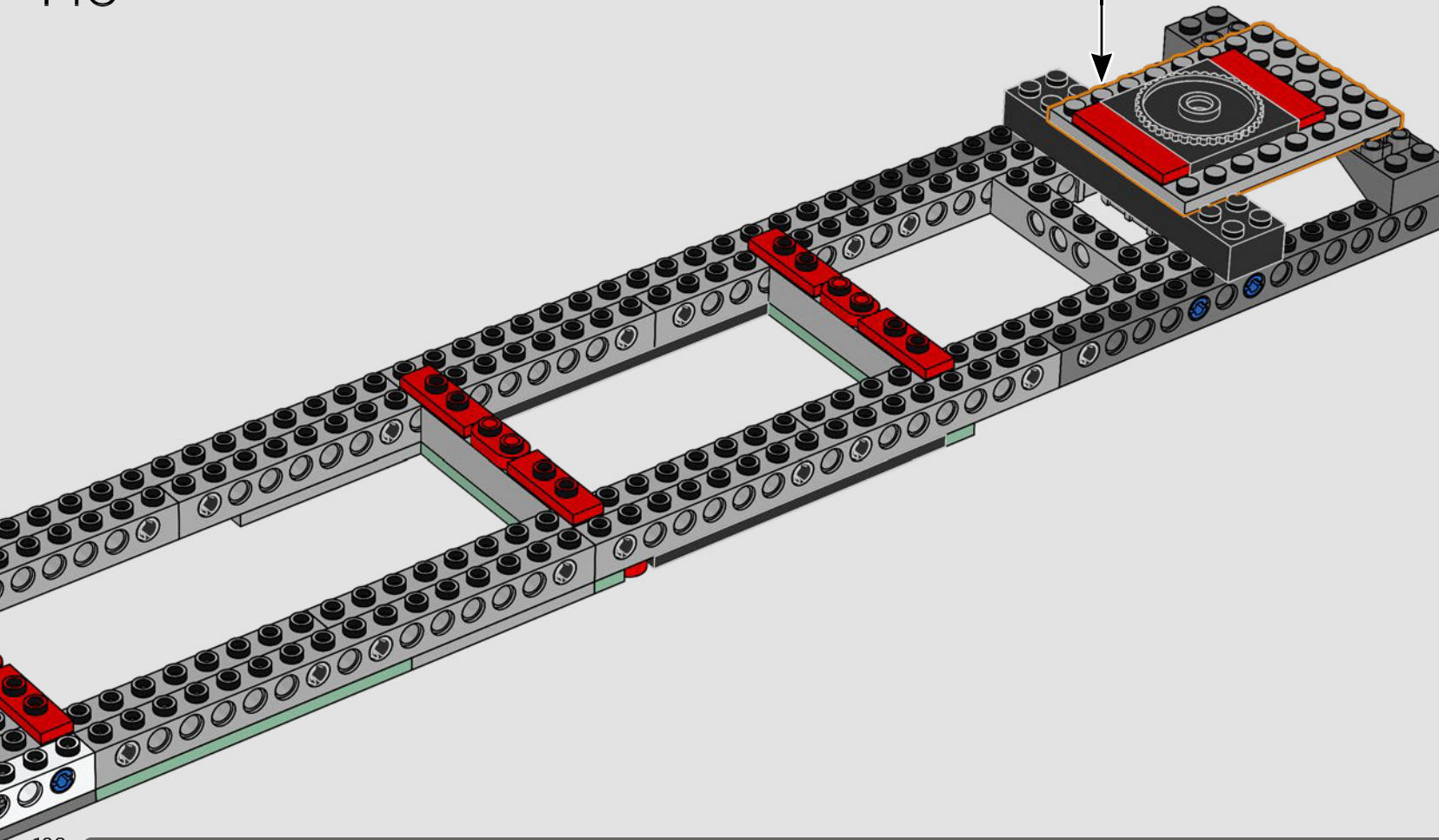

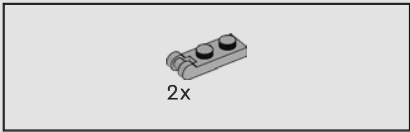

146

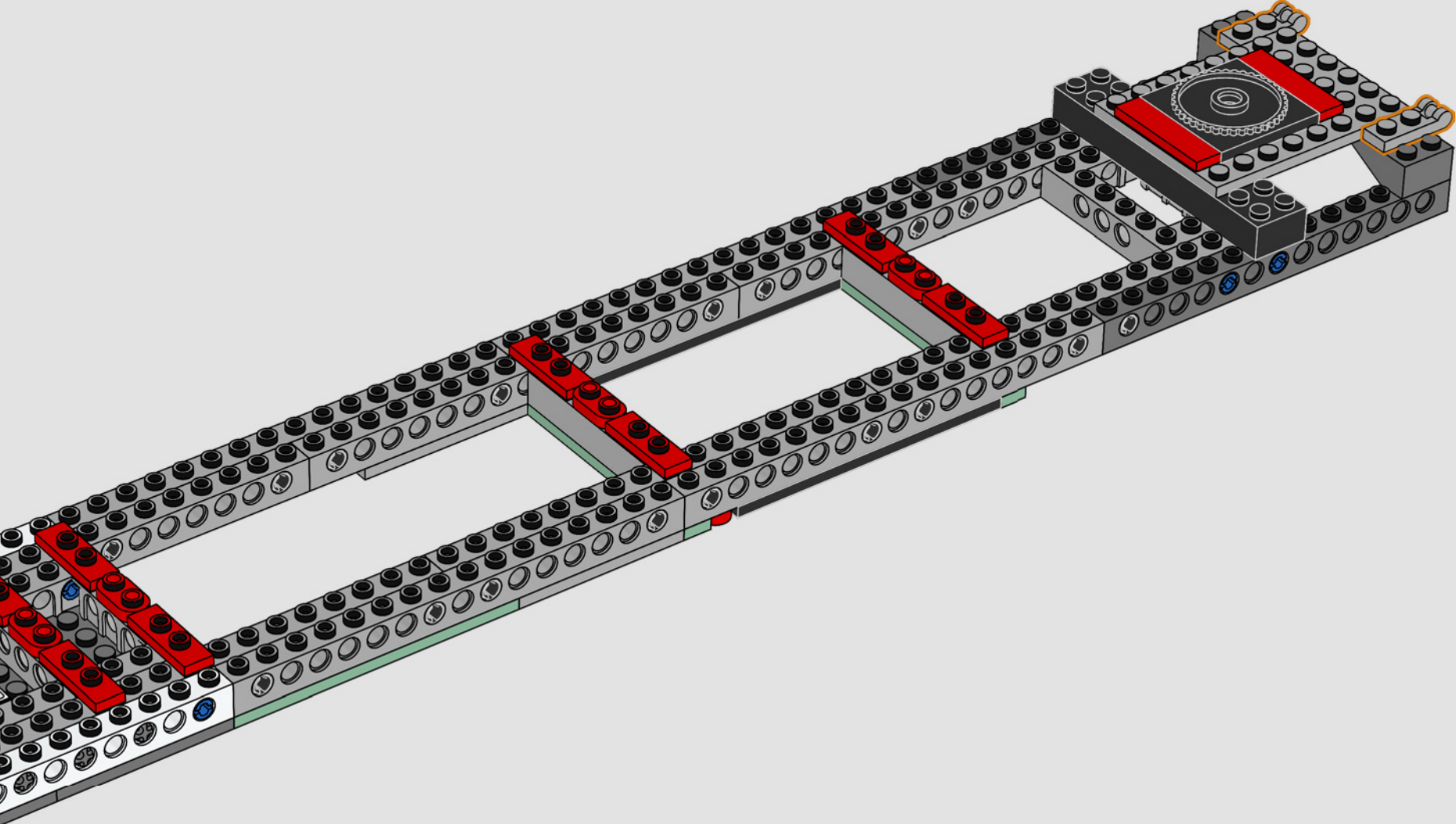

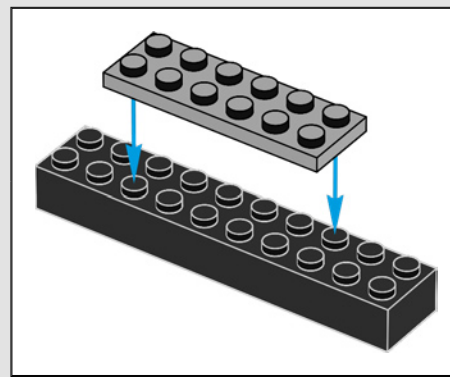
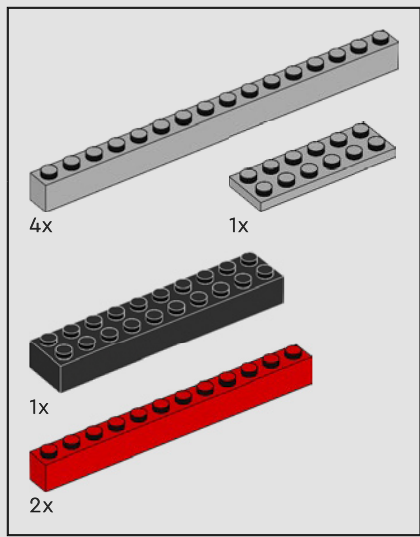

147

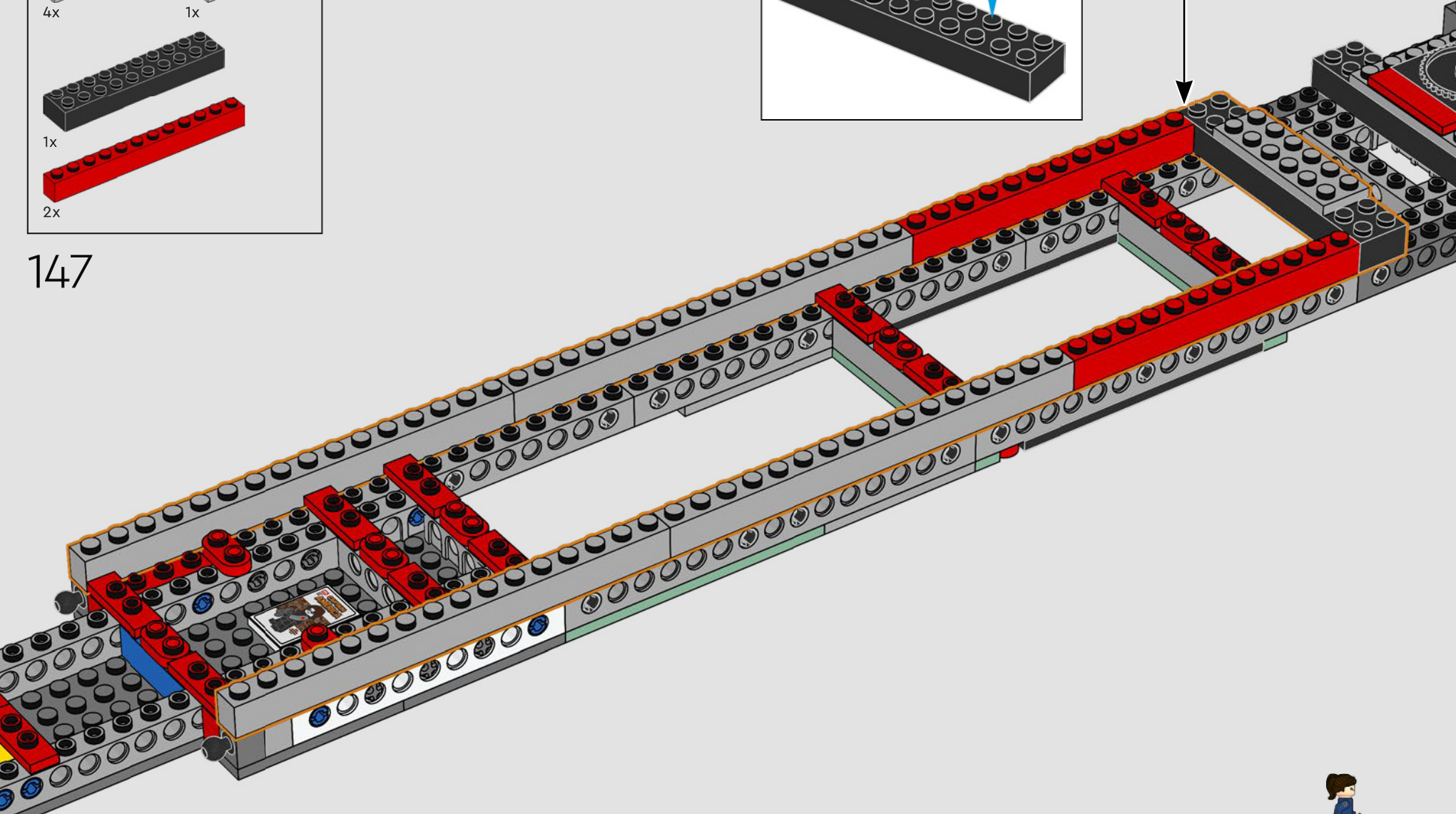

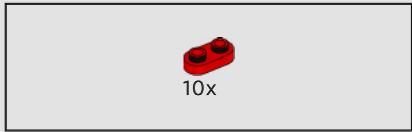

148

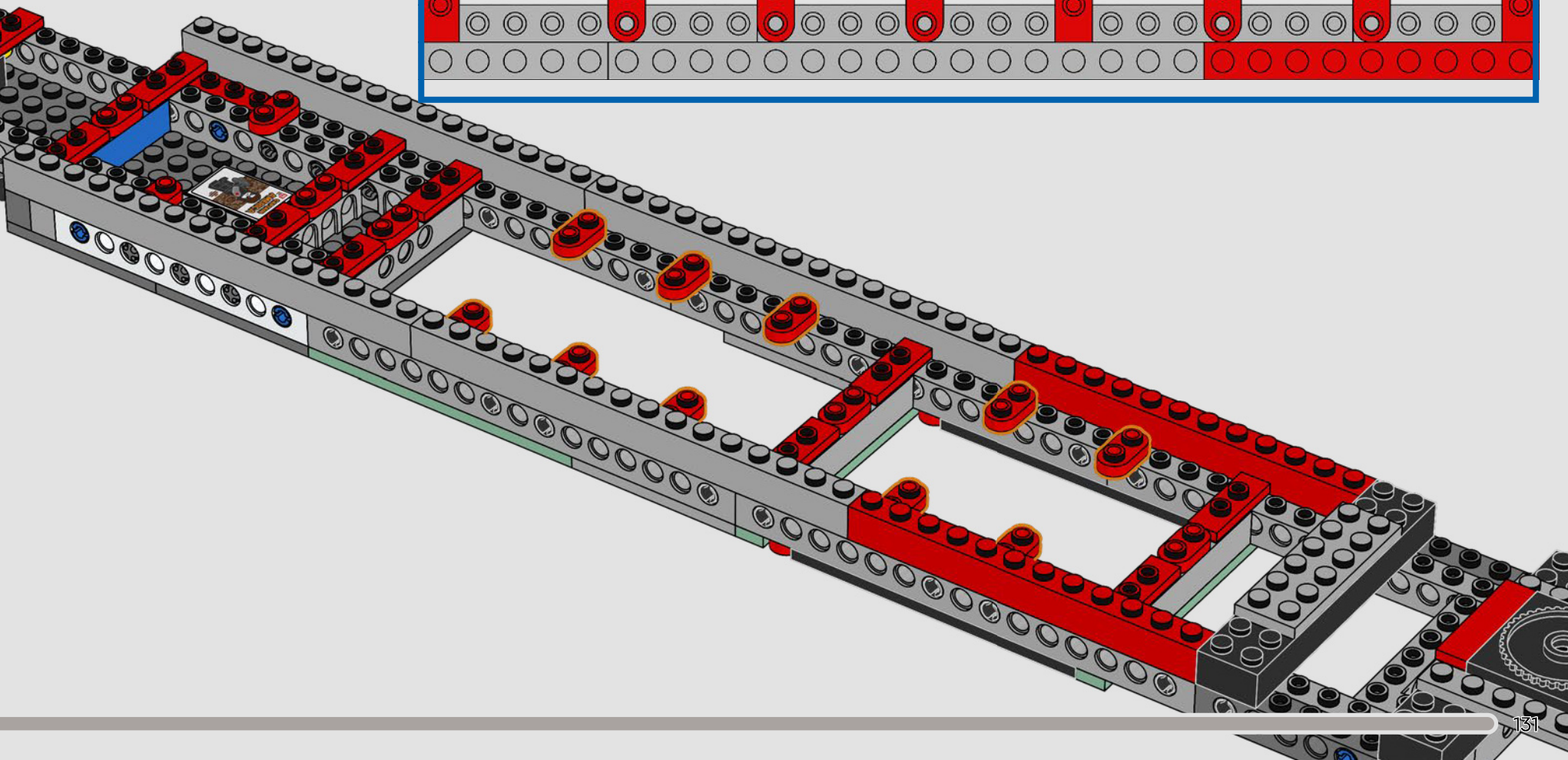
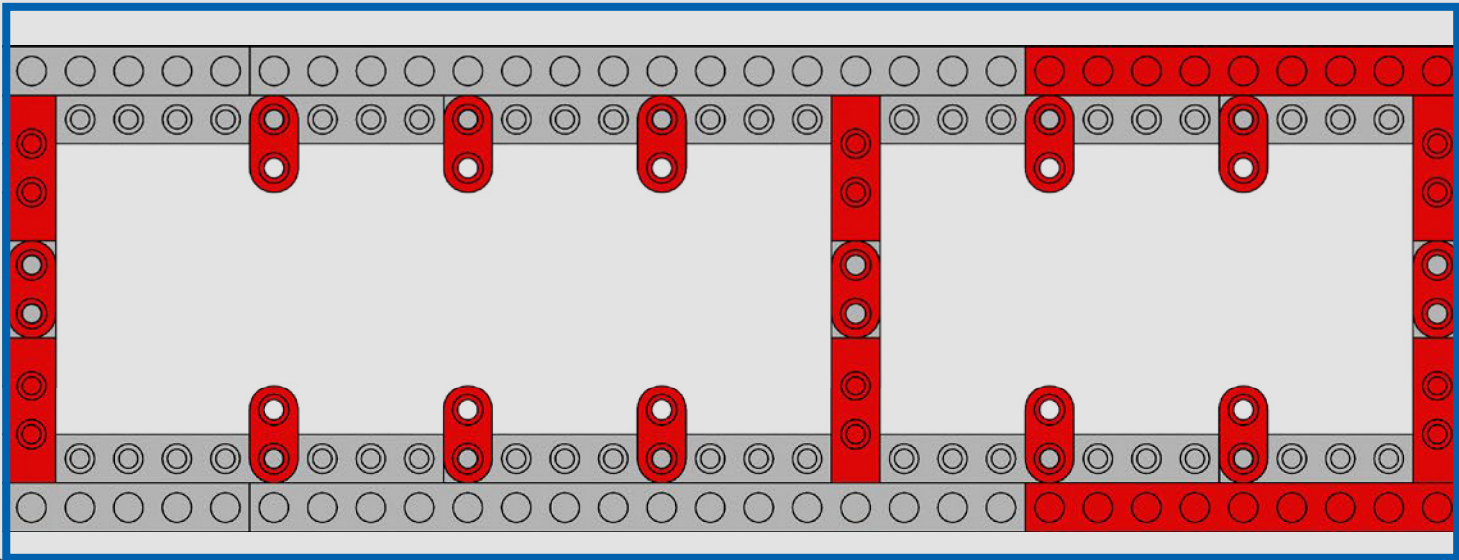

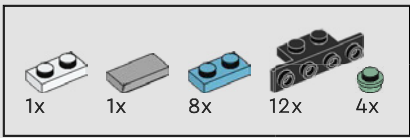

149

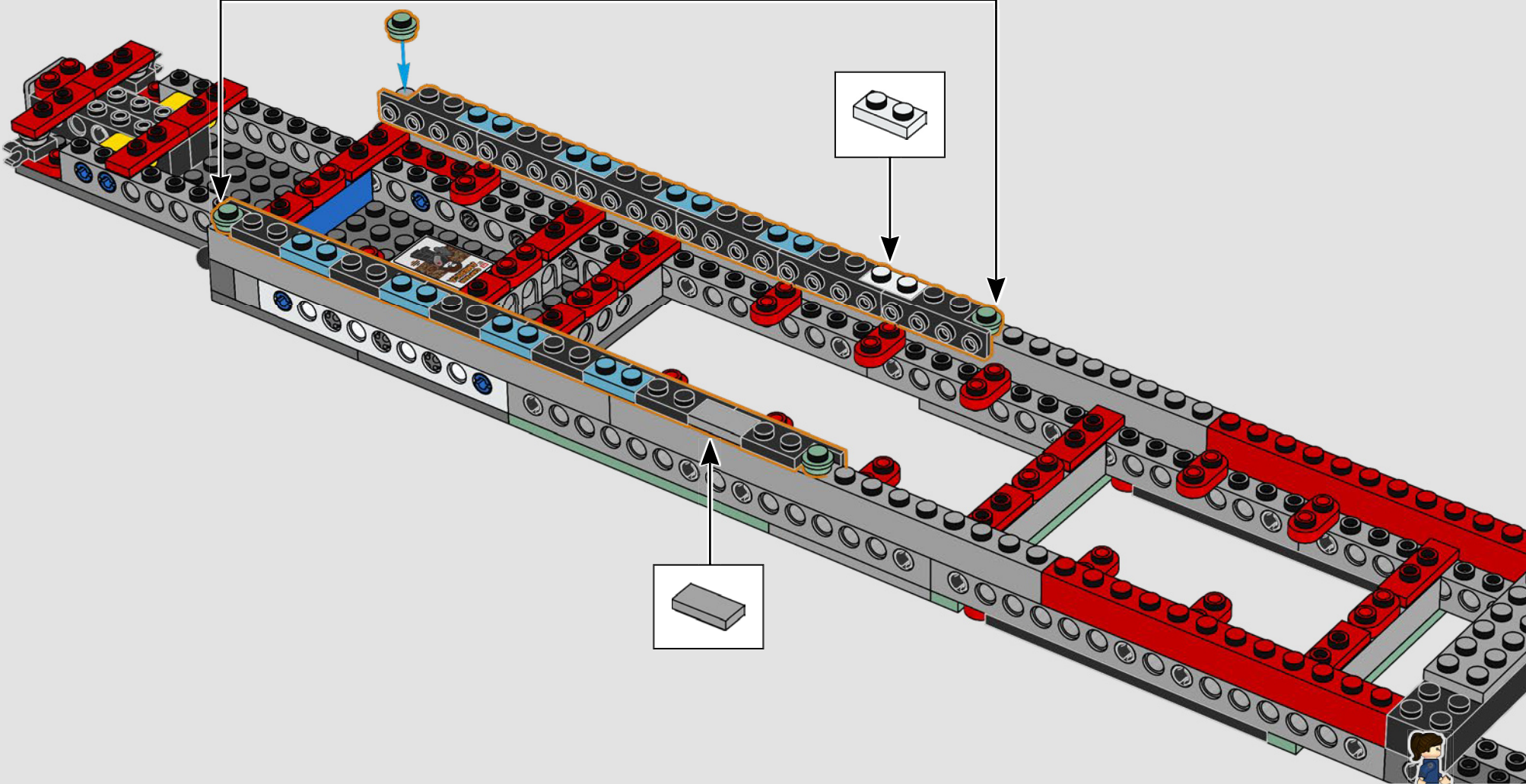
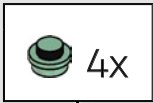

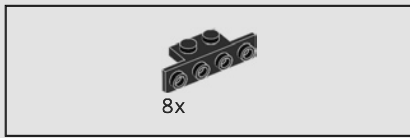

150

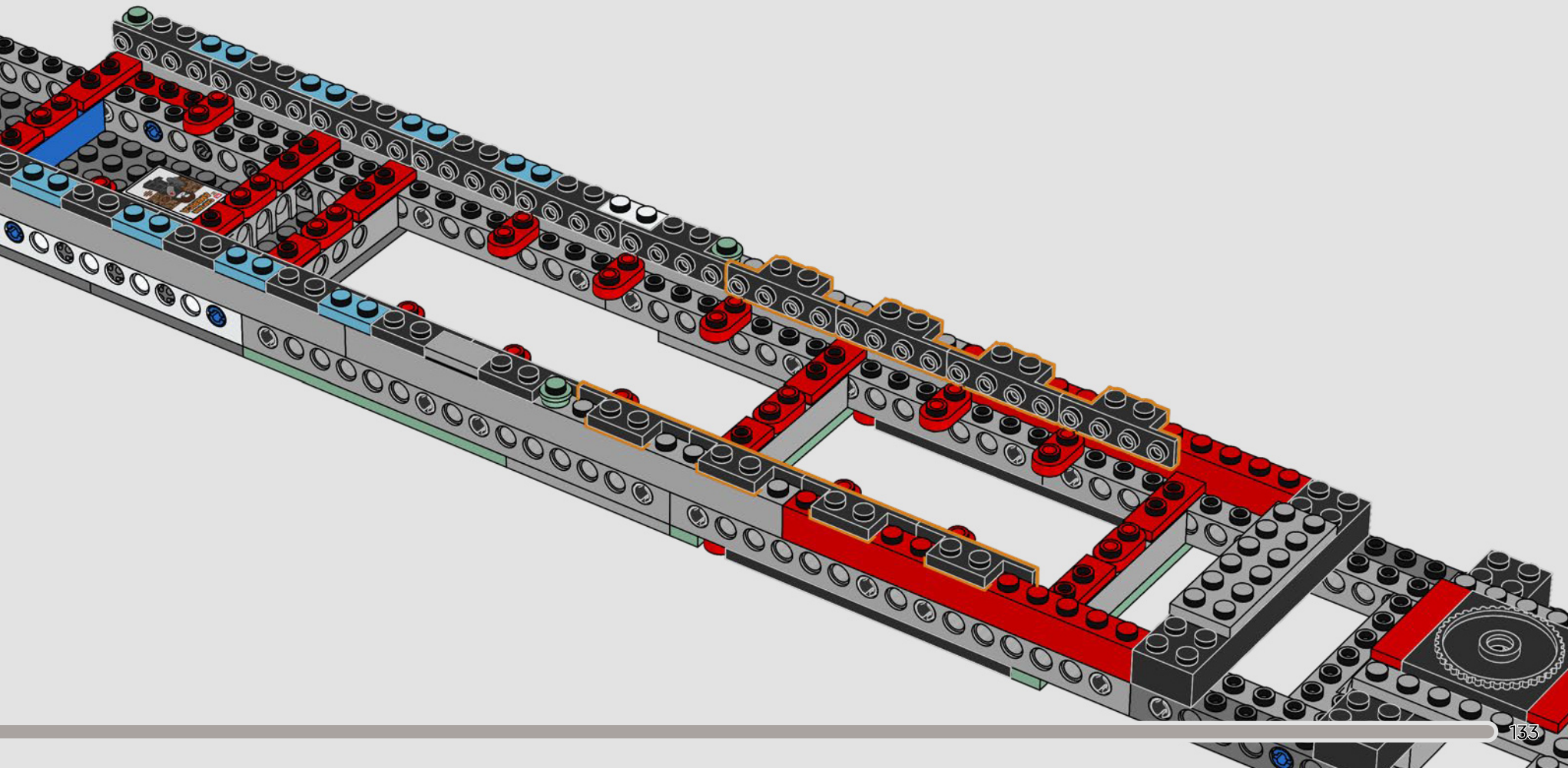

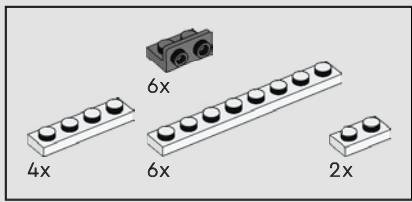

151

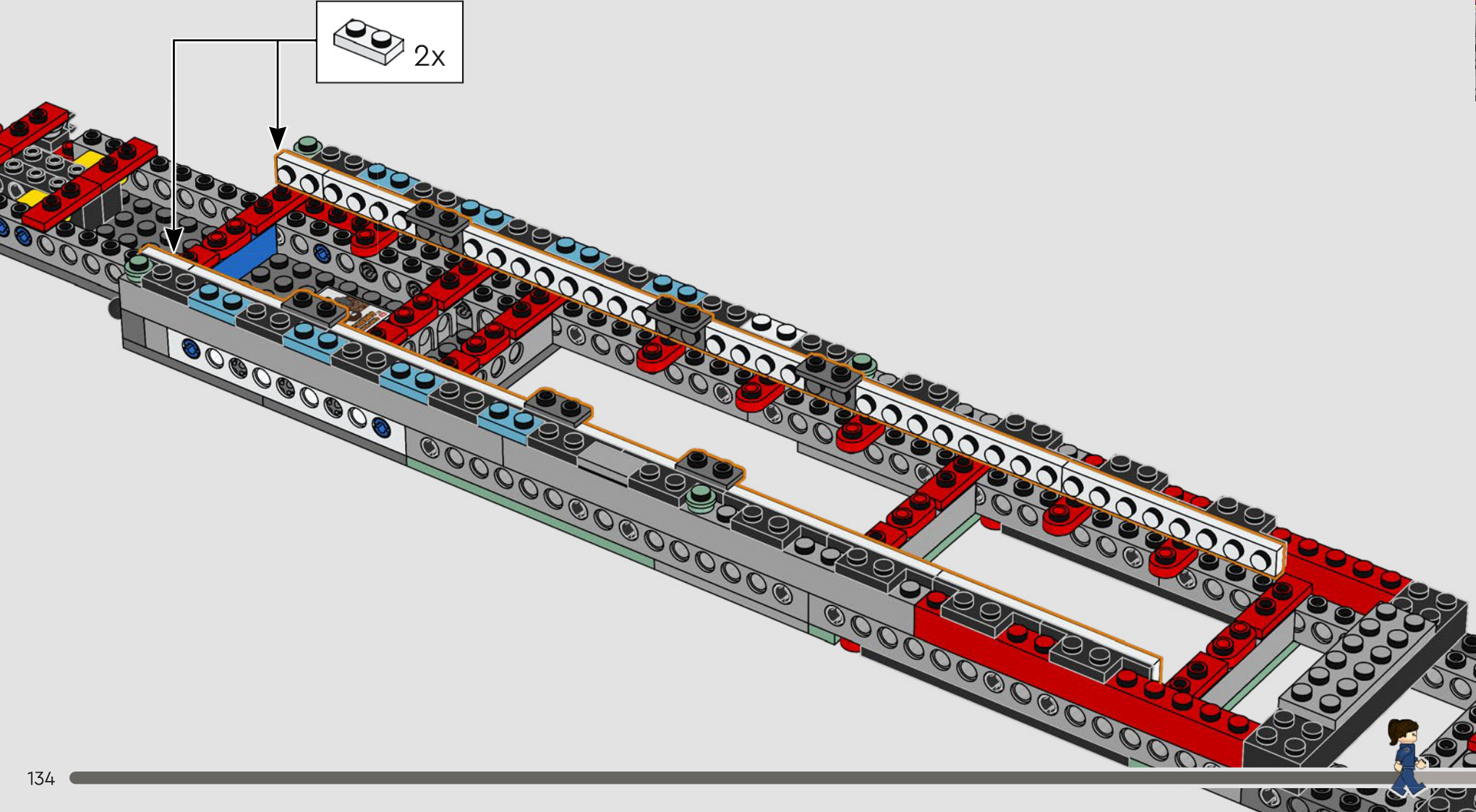
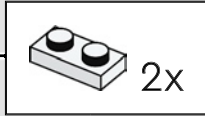

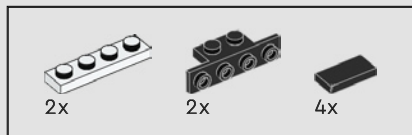

152

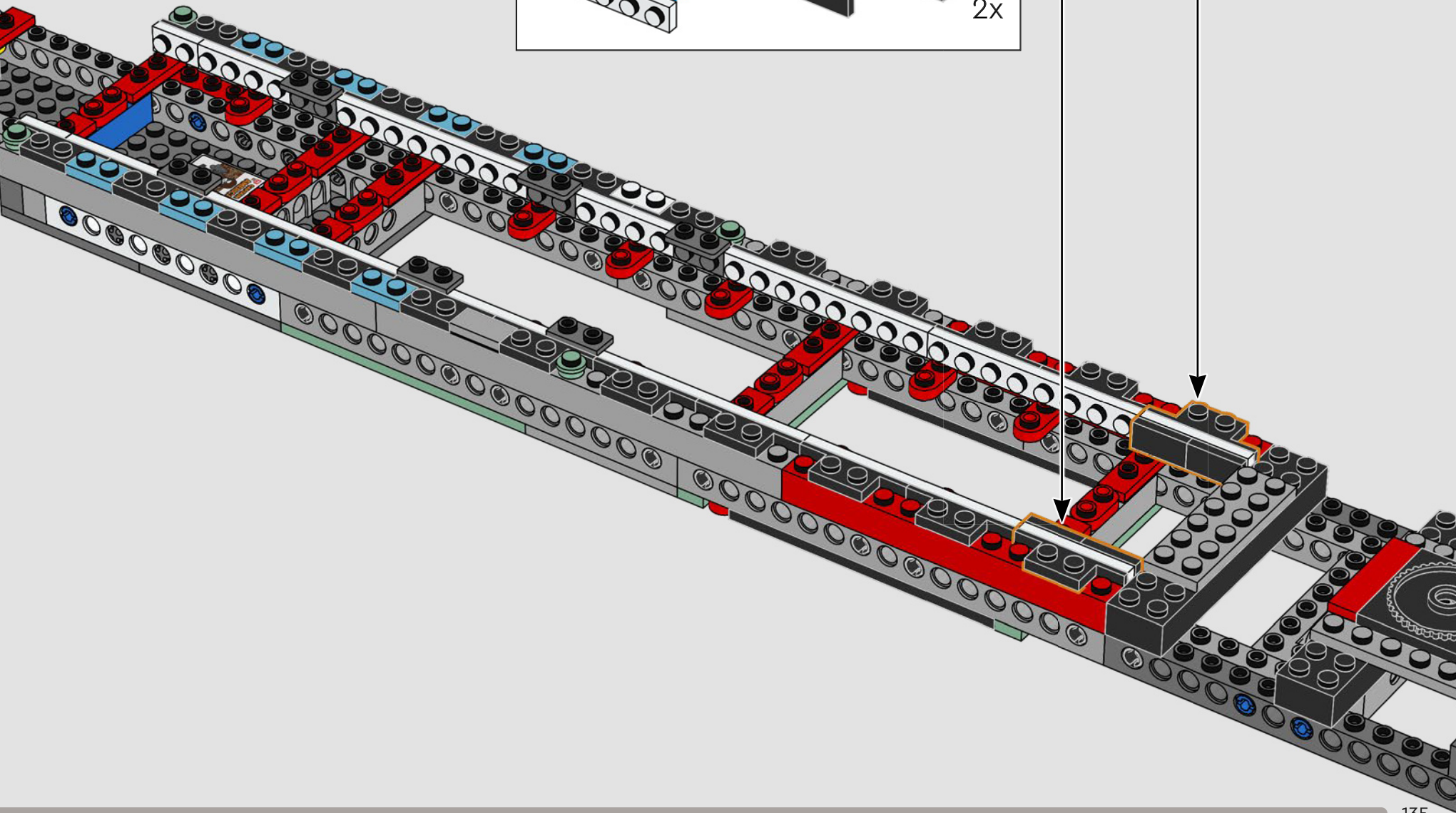
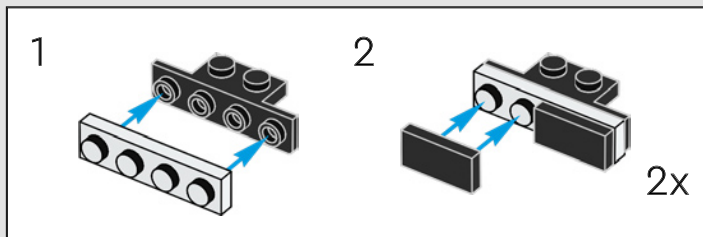

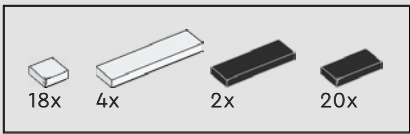

153

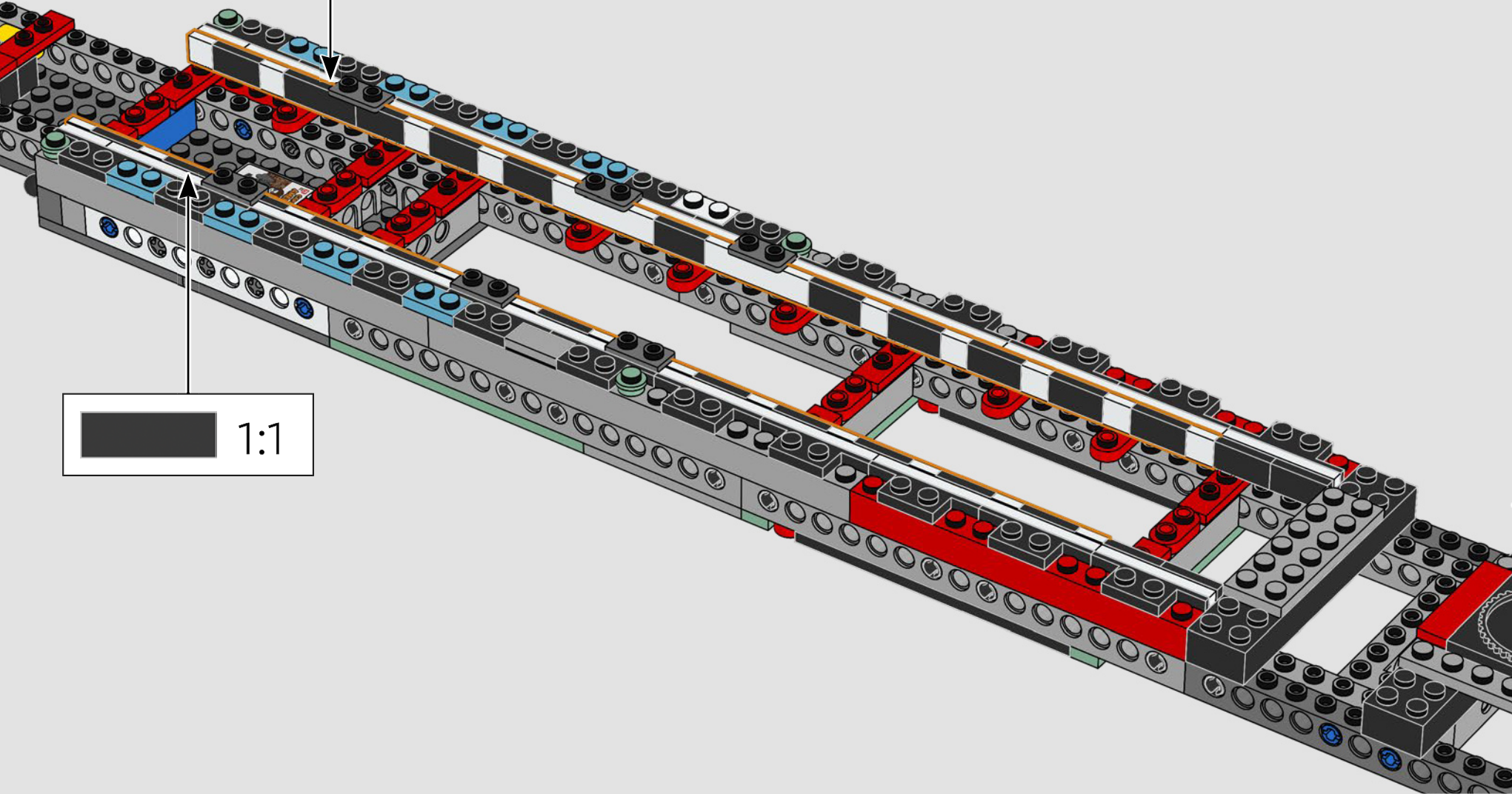

154

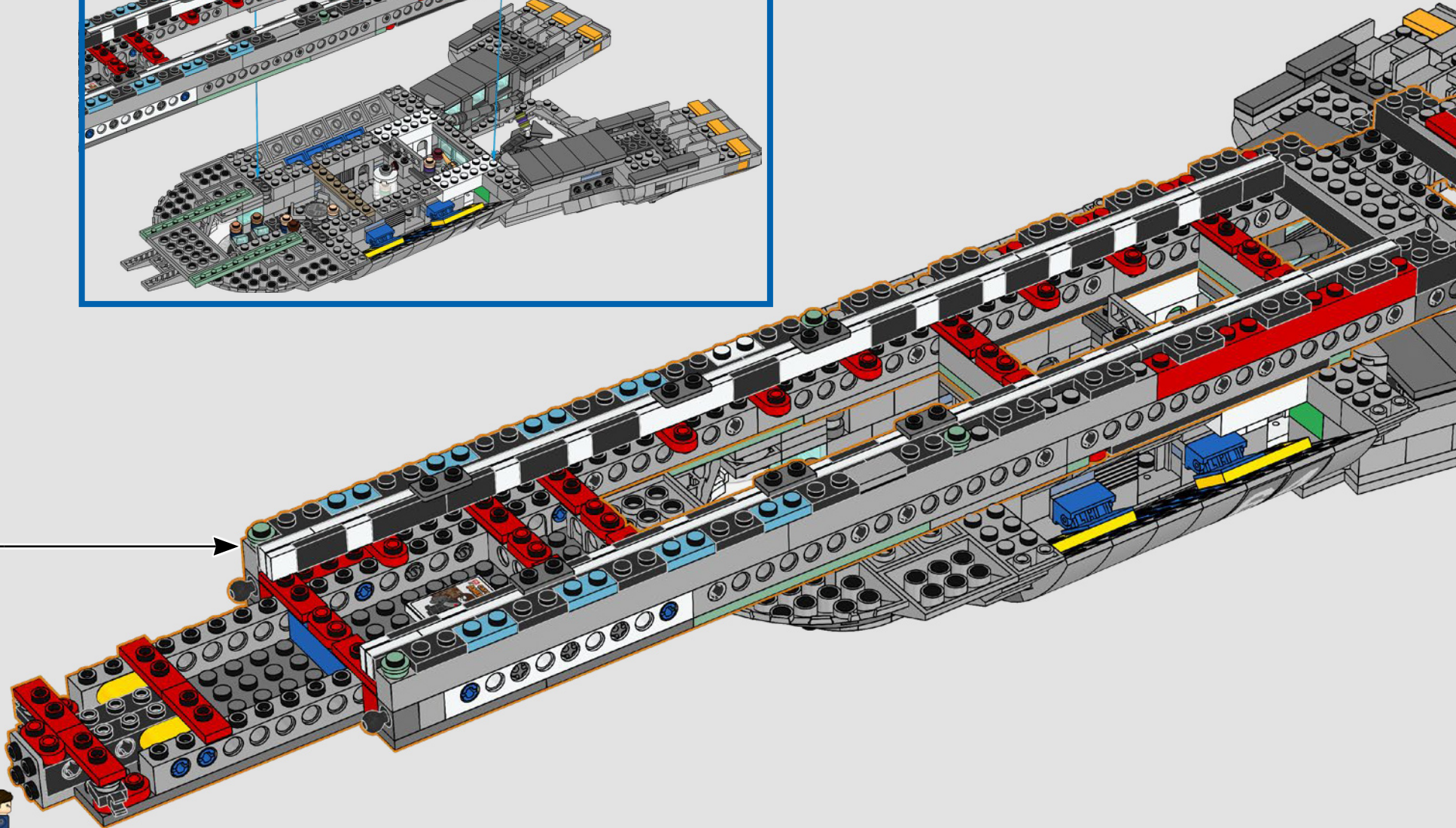
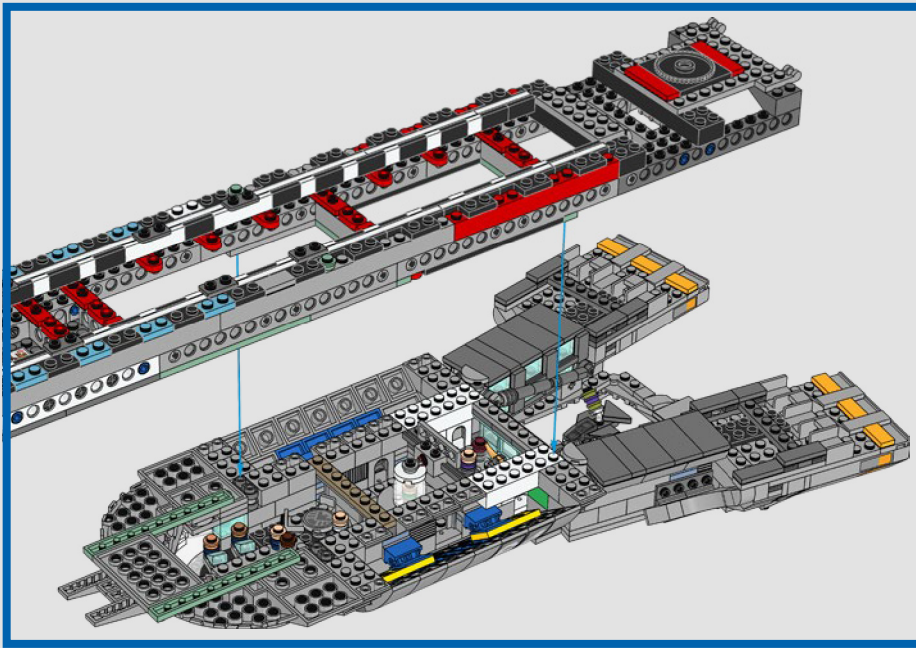

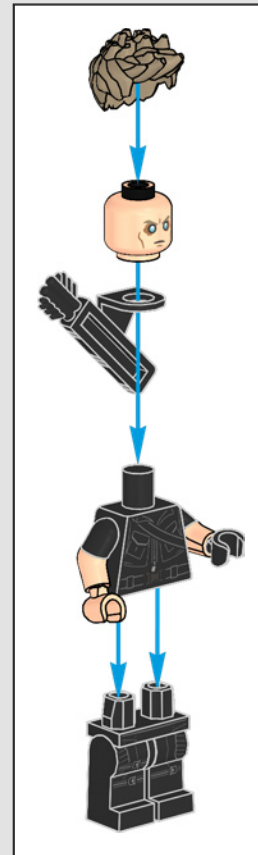

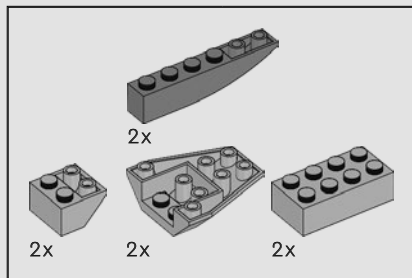

155

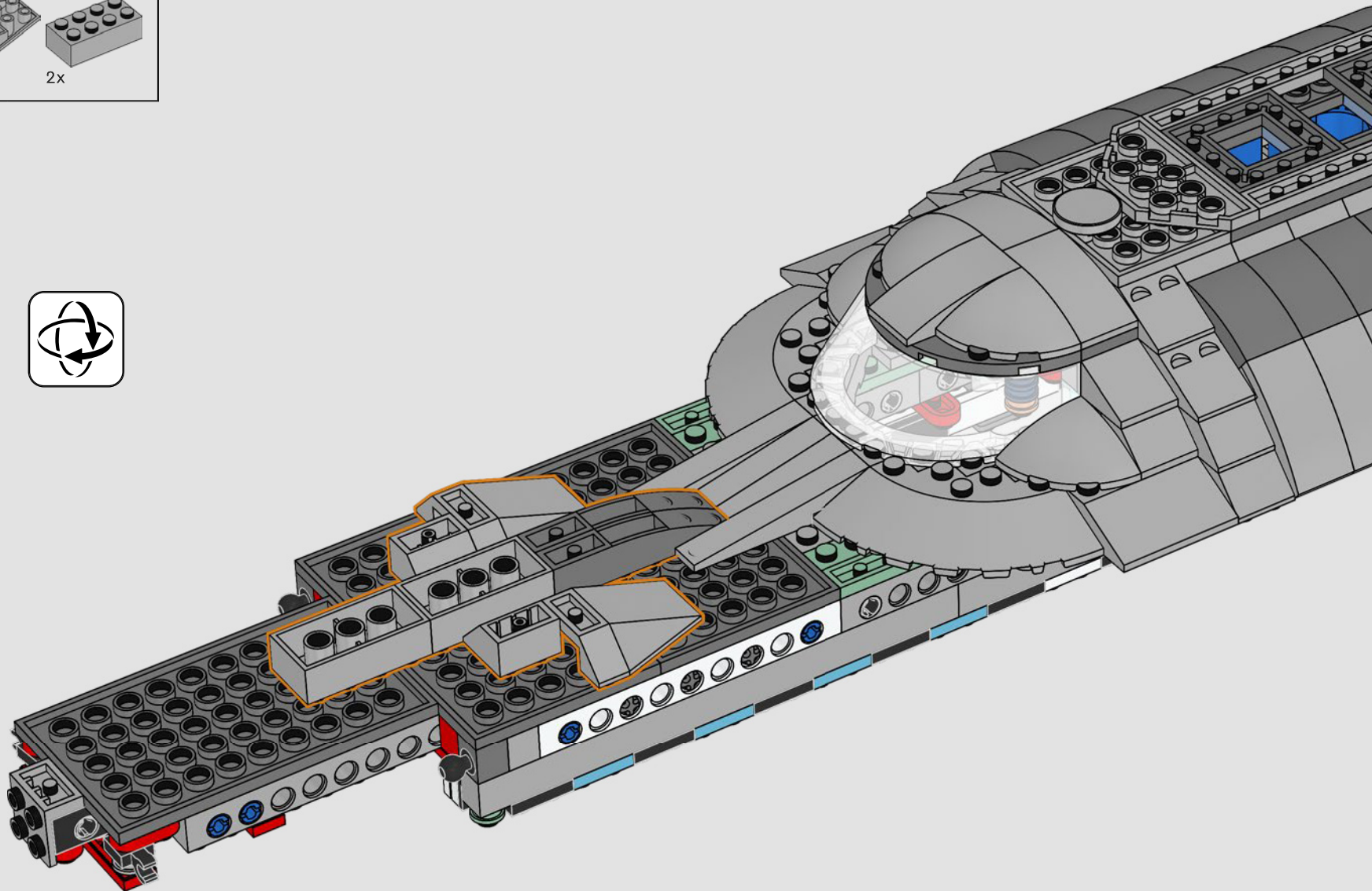

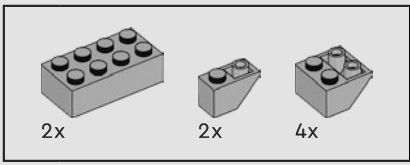

156

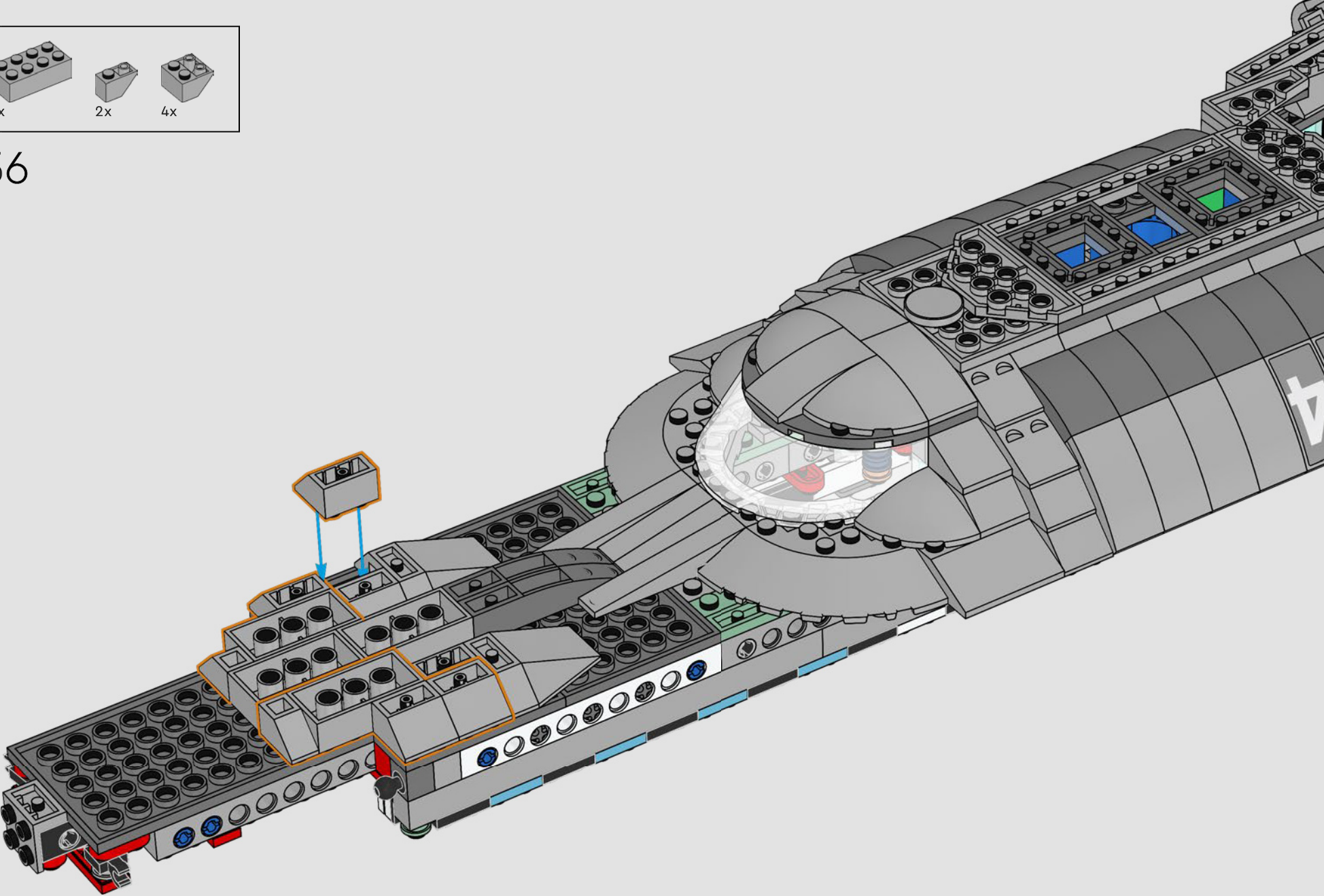

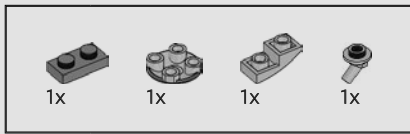

157

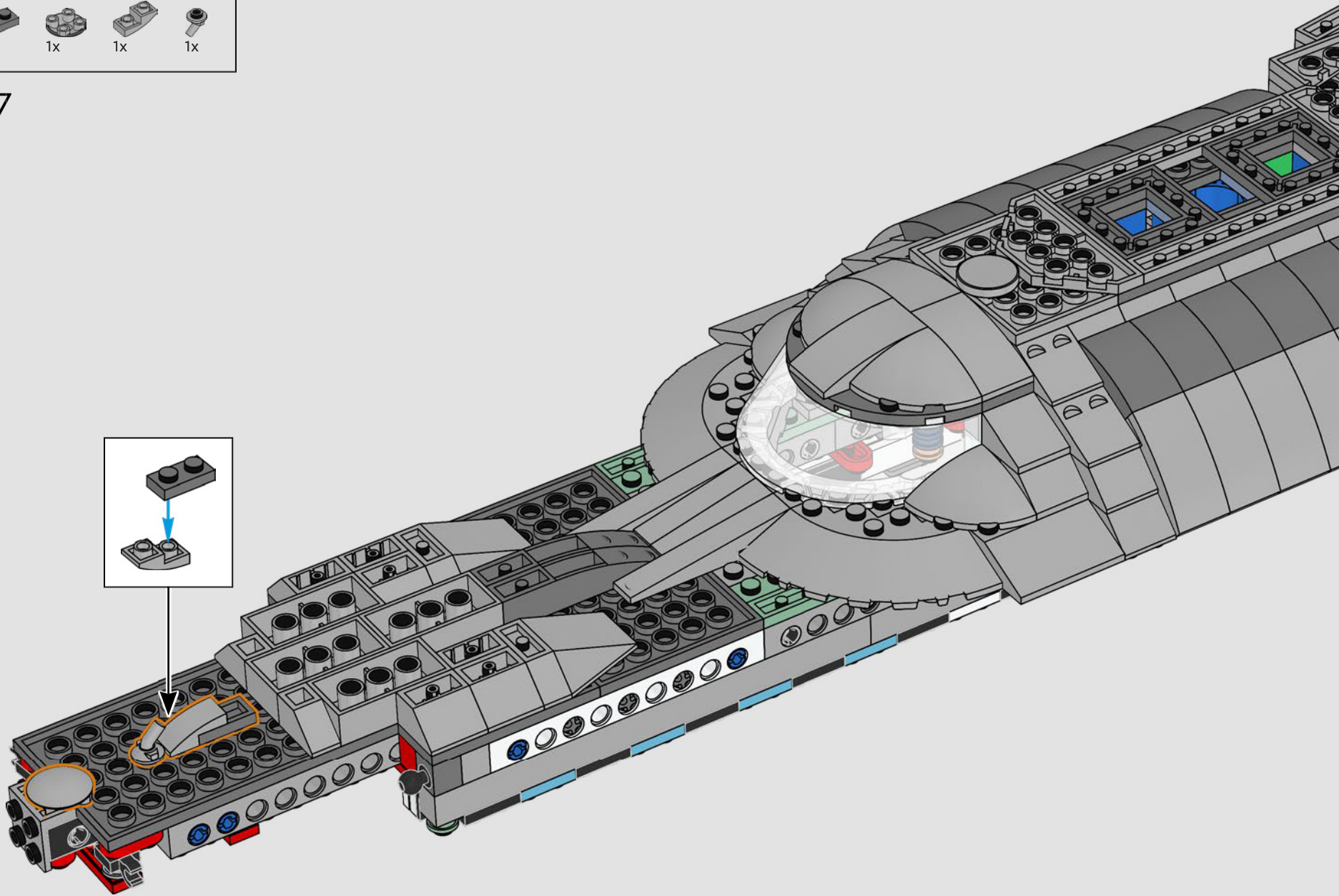

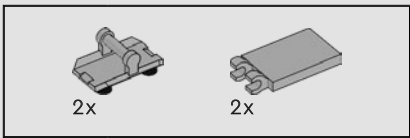

158

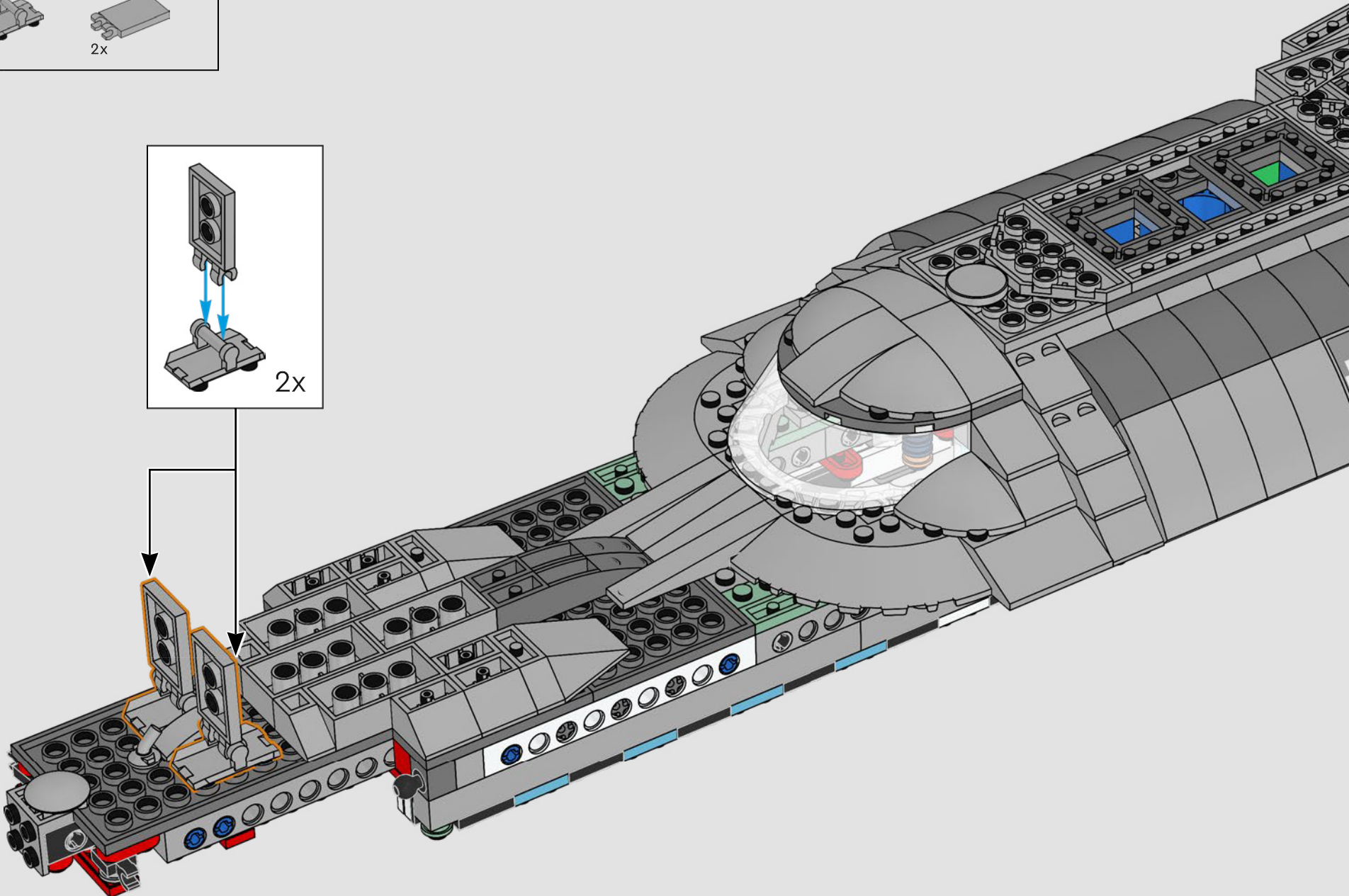
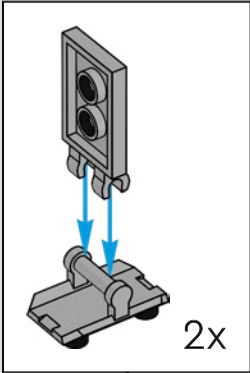

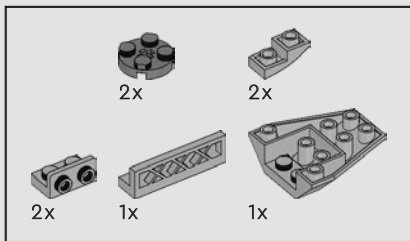

159

1

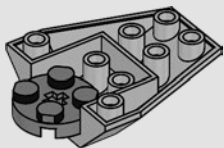

2

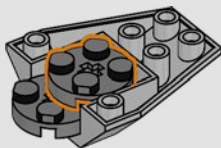

3

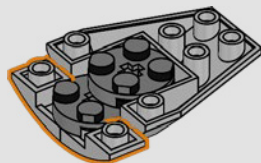

4

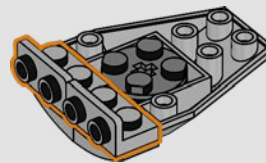

5

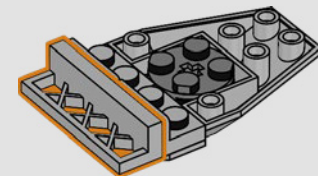

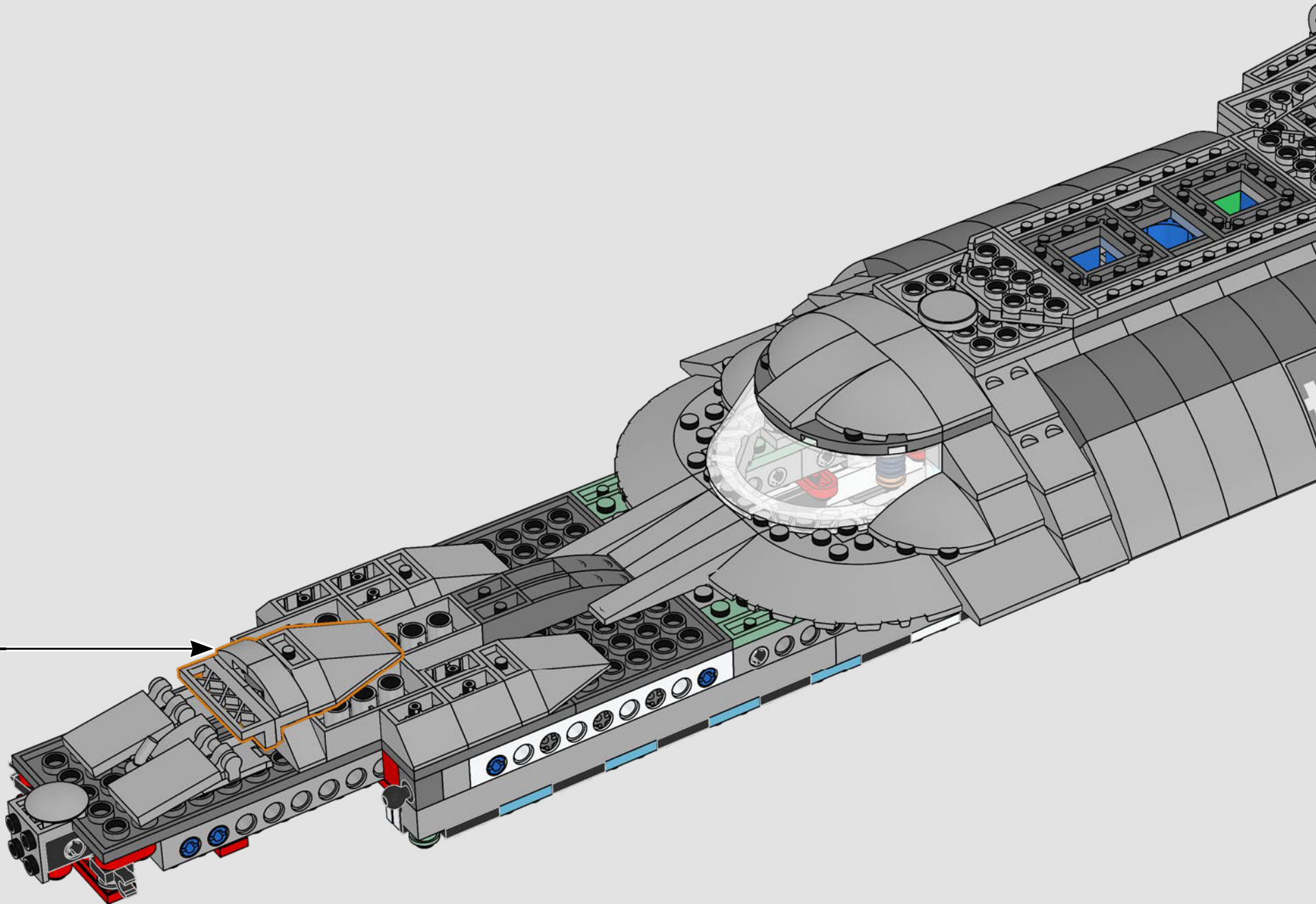

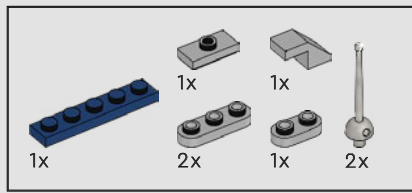

160

1

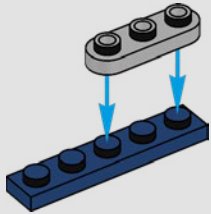

2

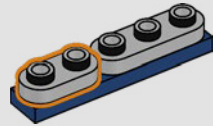

3

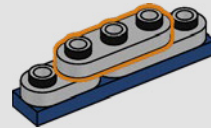

4

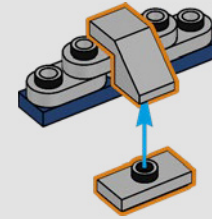

5

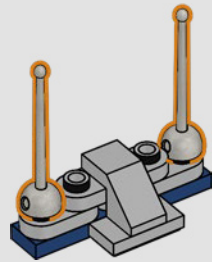

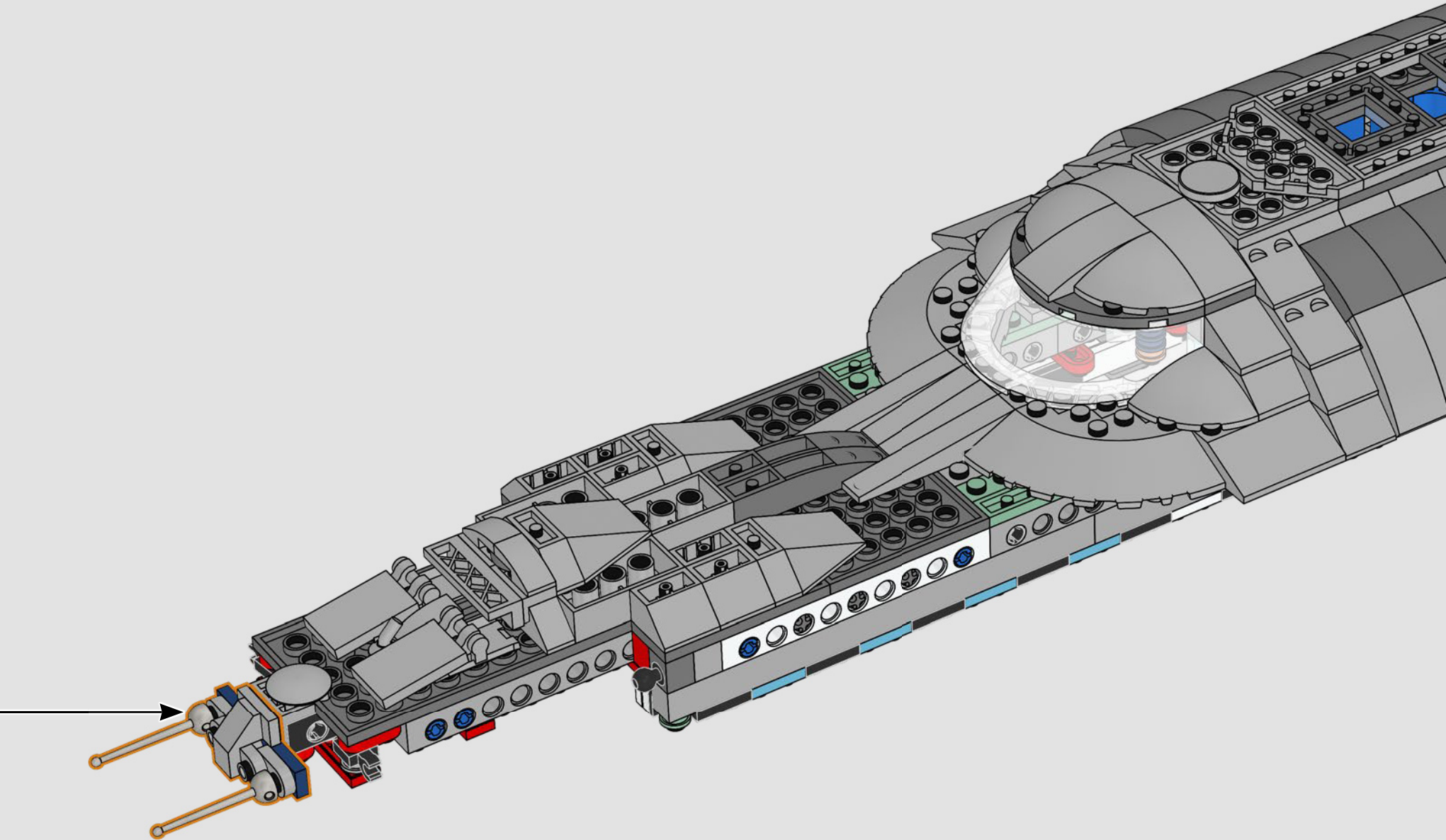

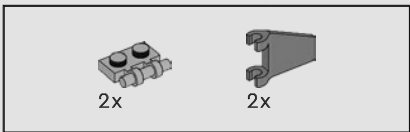

161

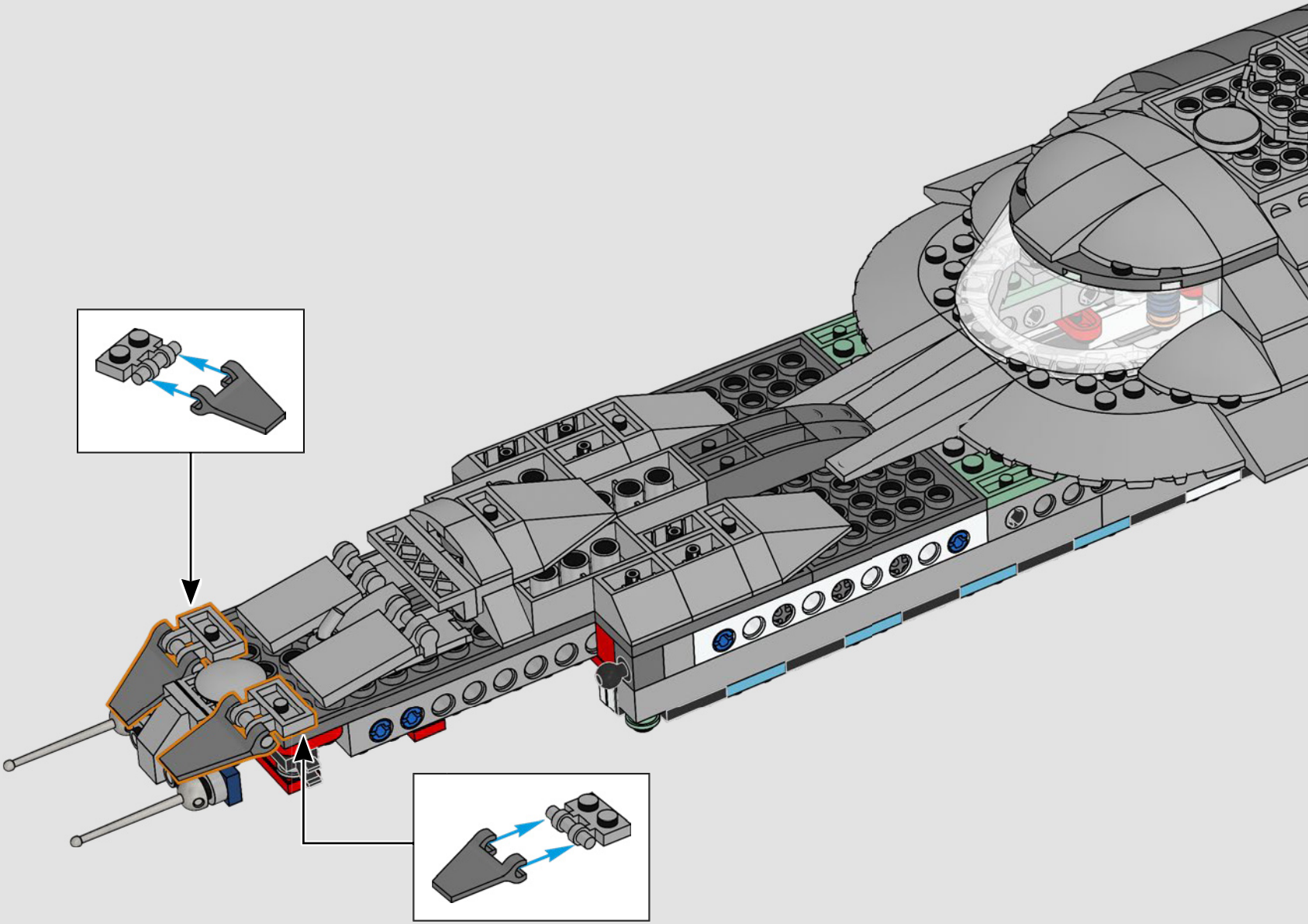

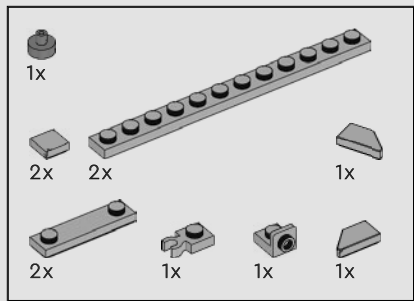

162

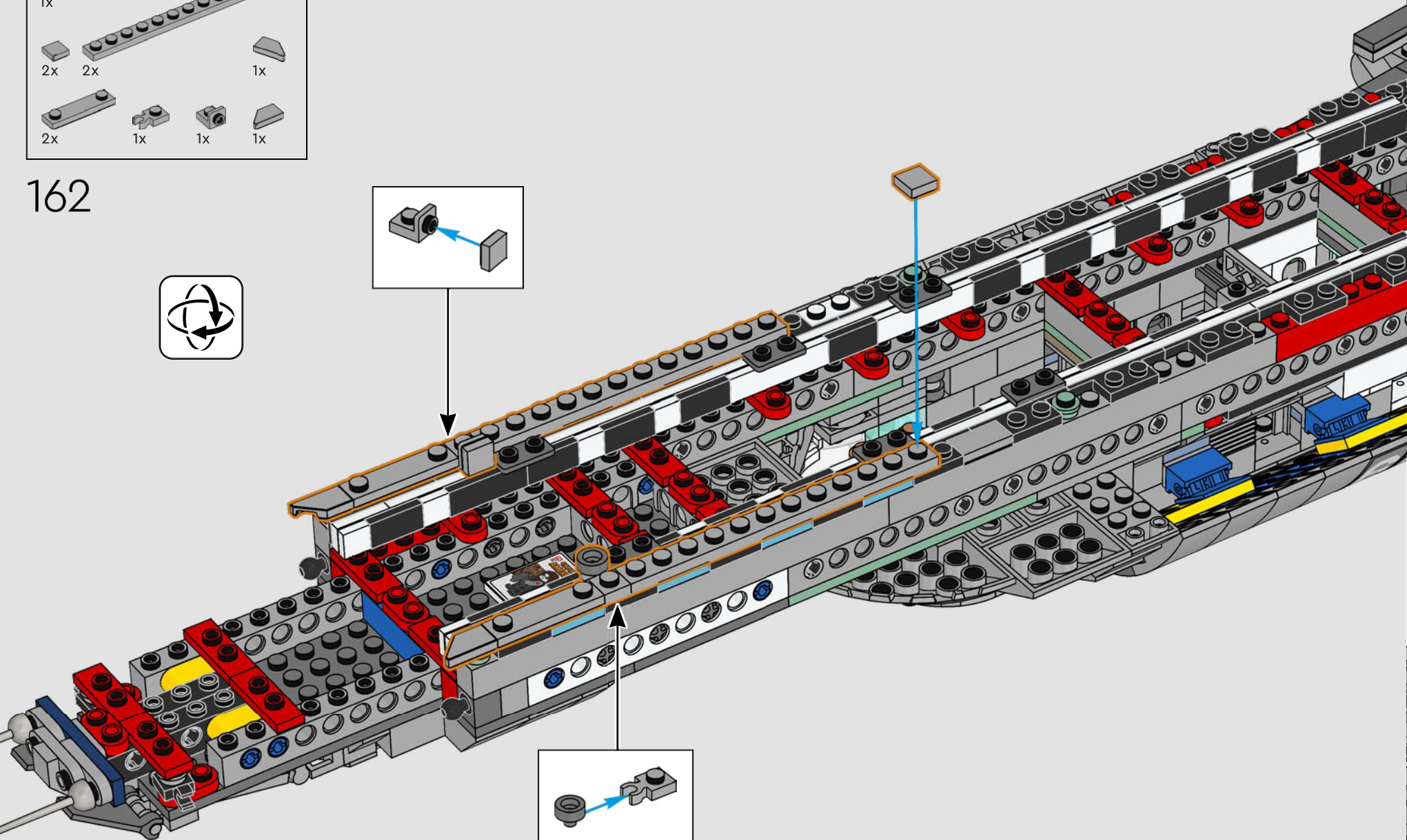
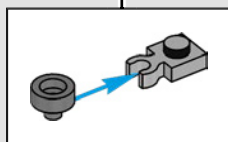
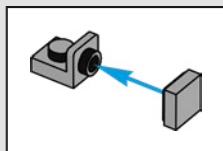

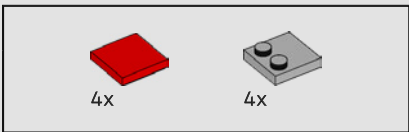

163

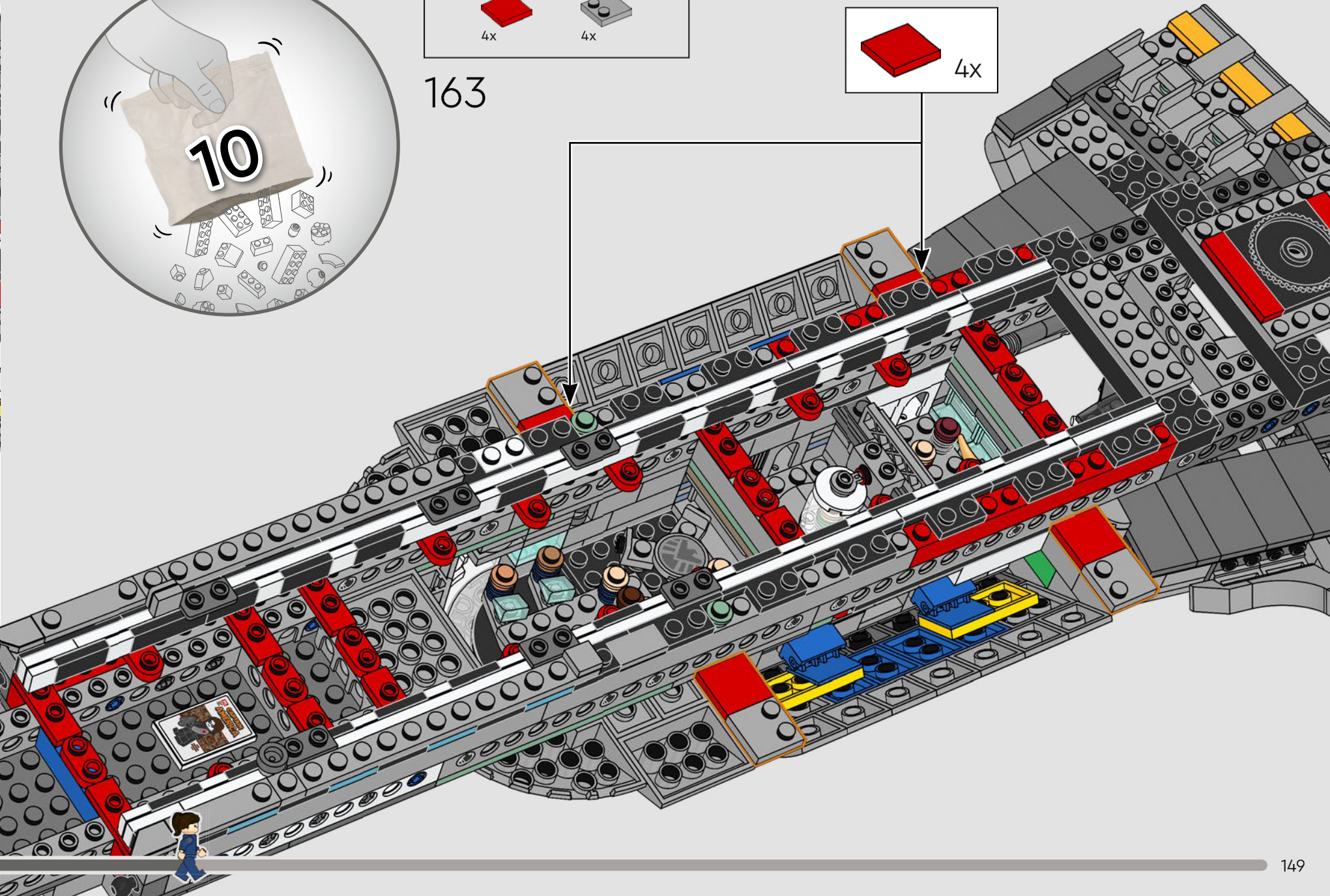
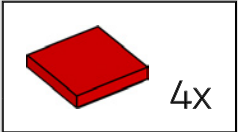

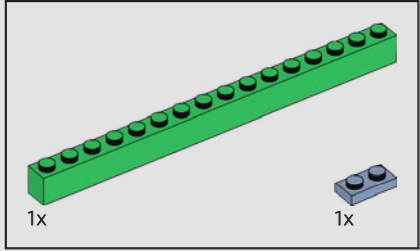
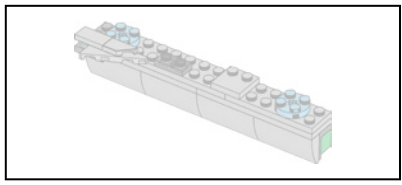

164

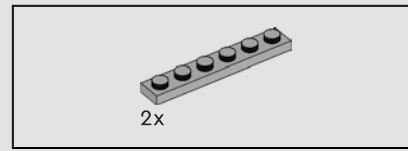
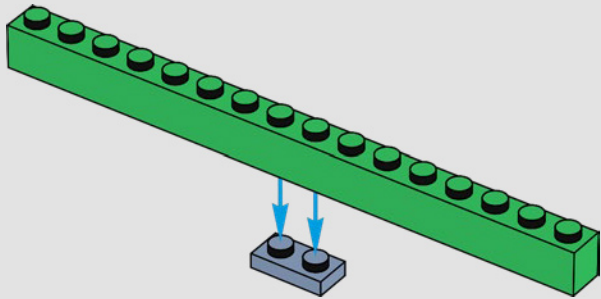

165

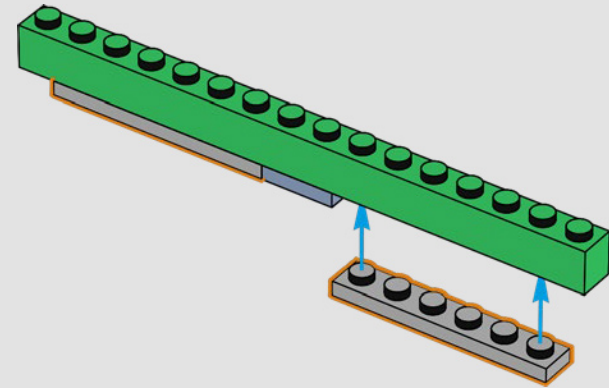

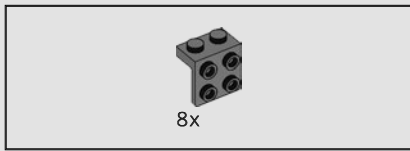

166

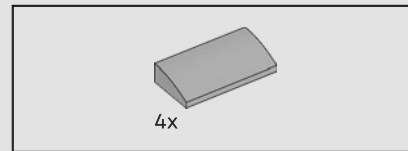
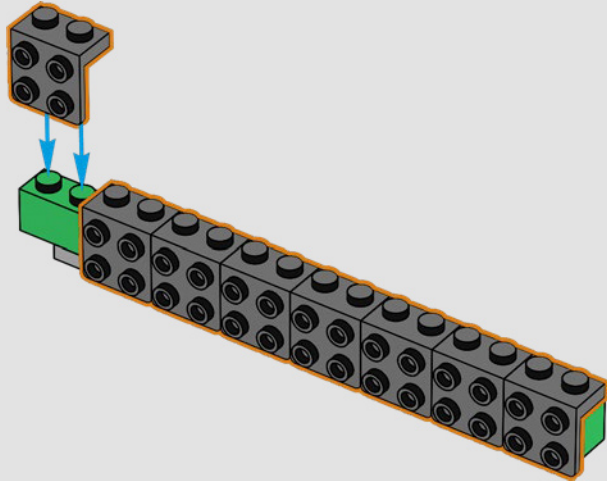

167

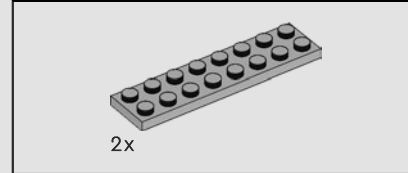
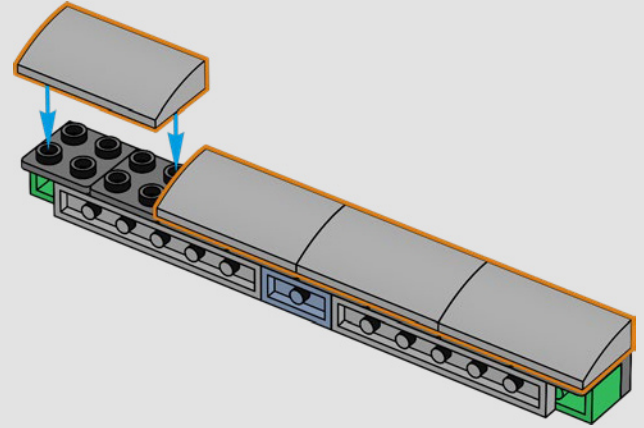
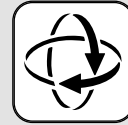

168

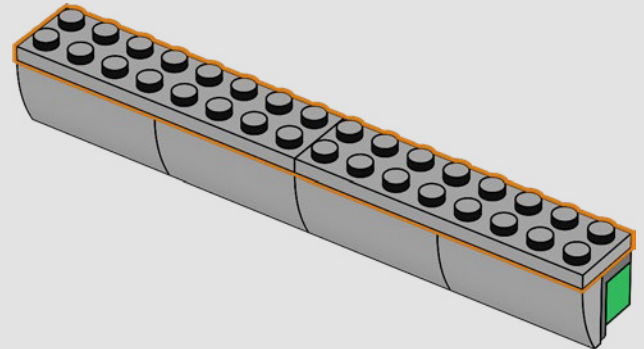
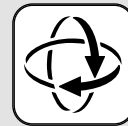

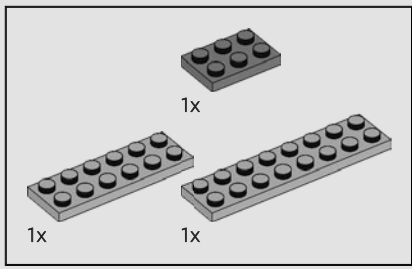

169

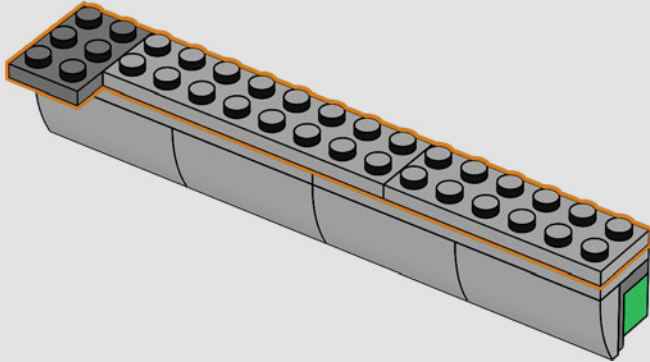

170

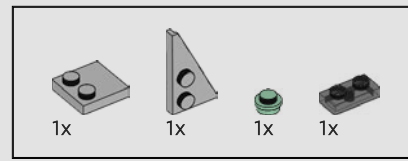
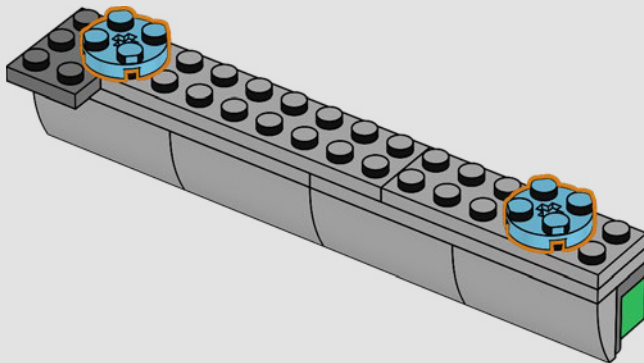

171

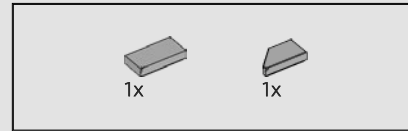
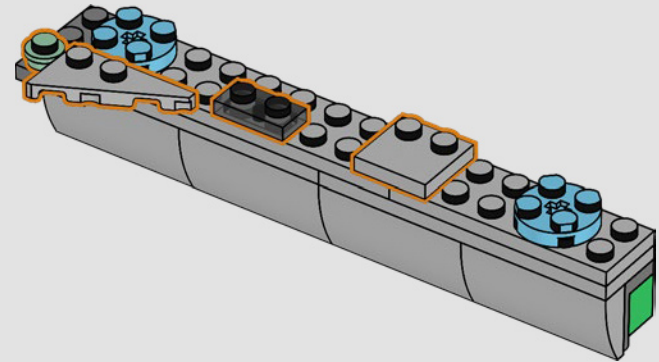

172

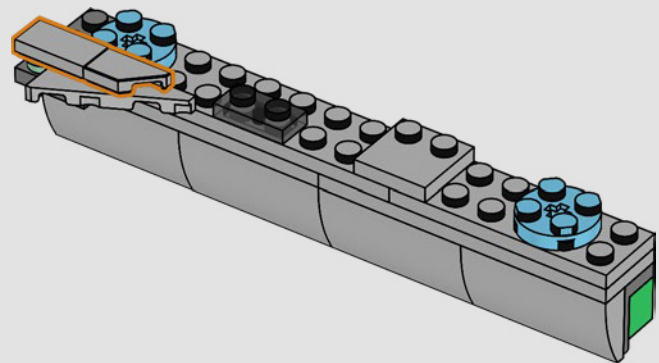

173

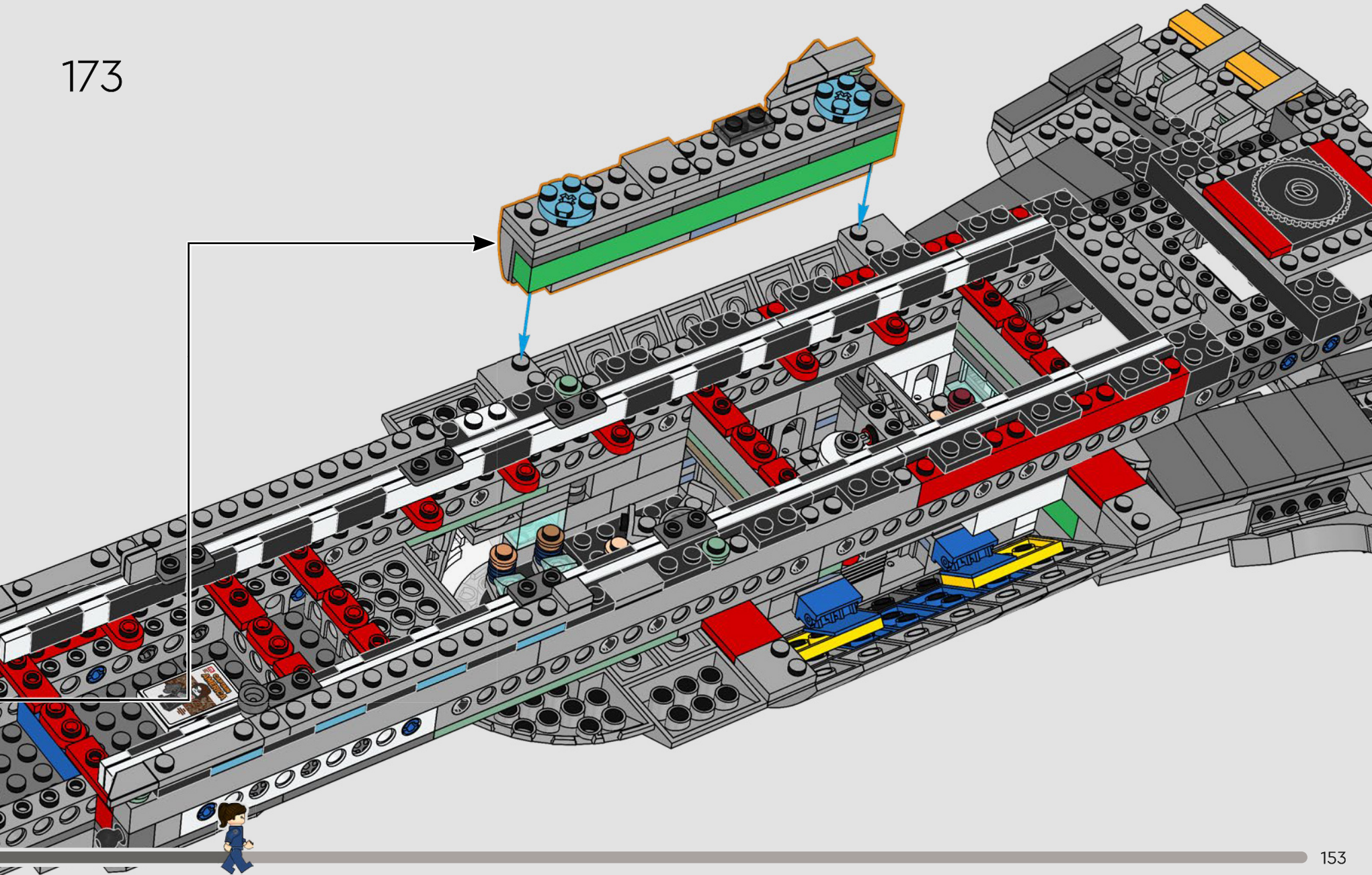

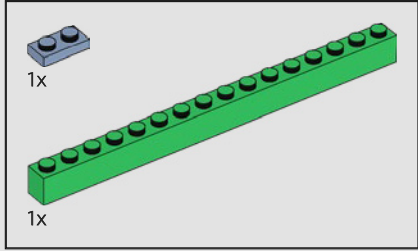
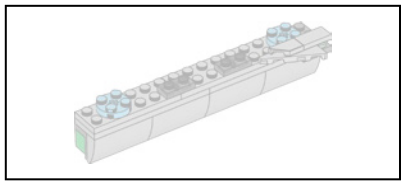

174

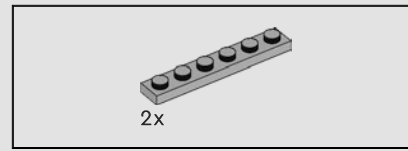
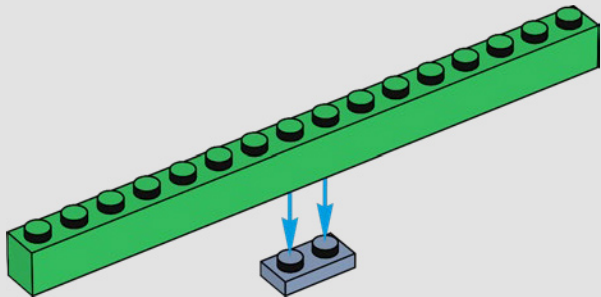

175

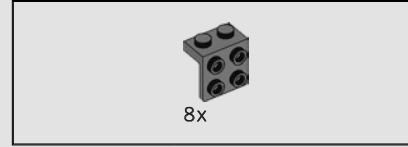
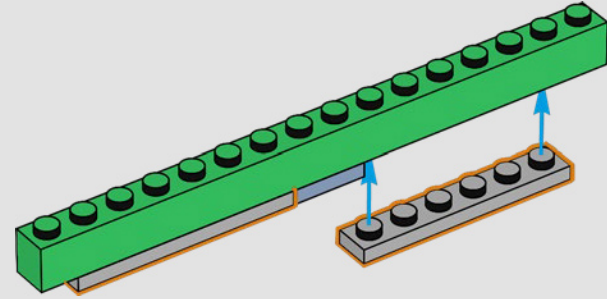

176

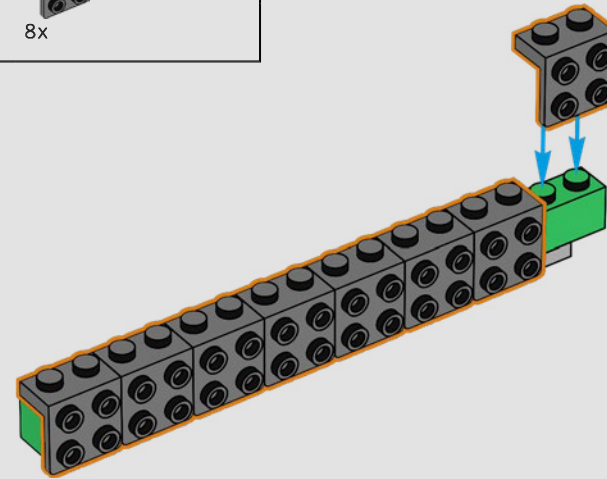

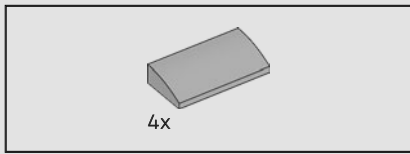

177

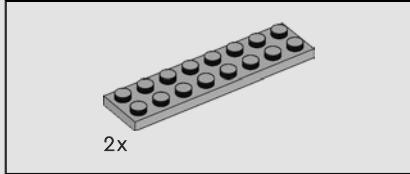
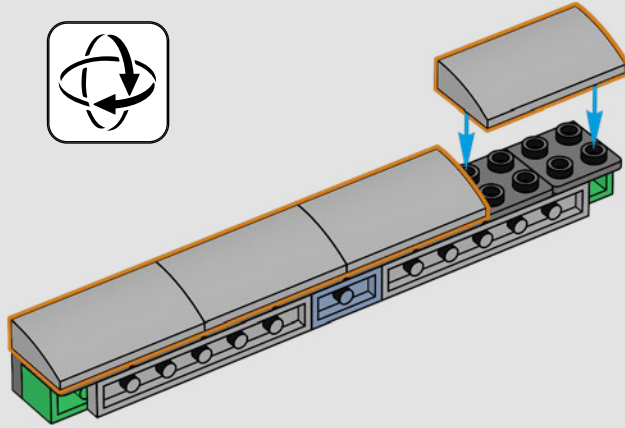

178

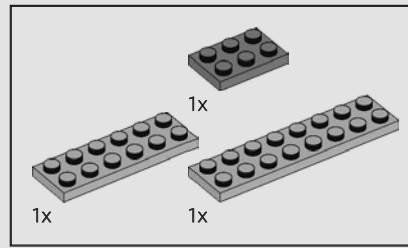
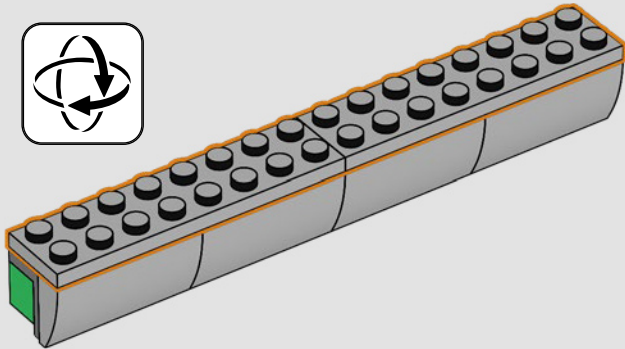

179

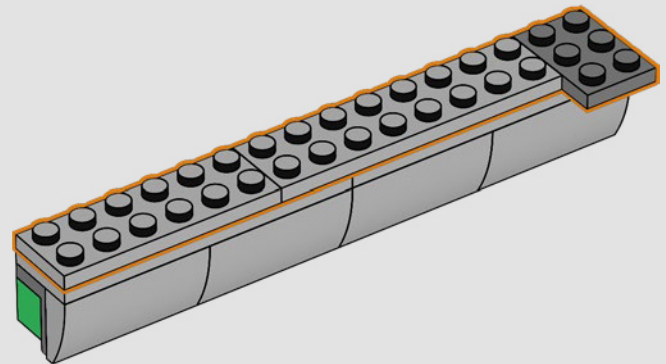



2x

180

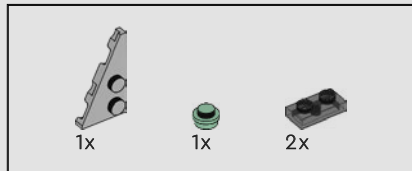
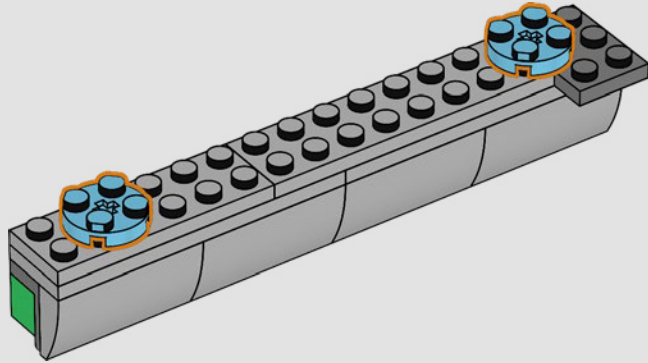

1x

1x

2x

181

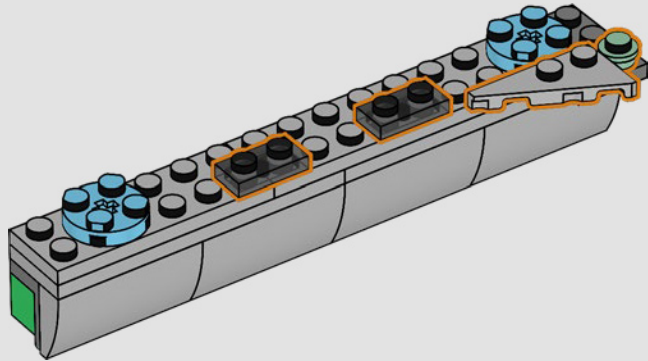

1x



1x

182

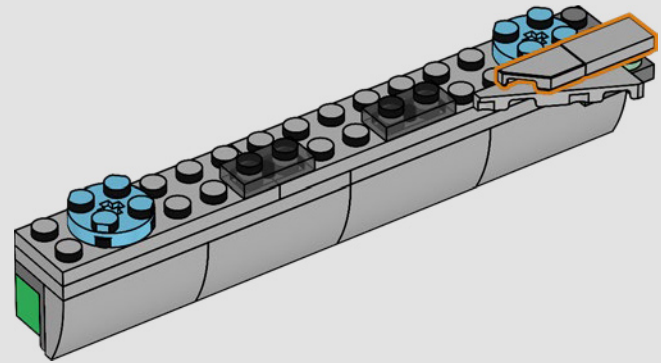

183

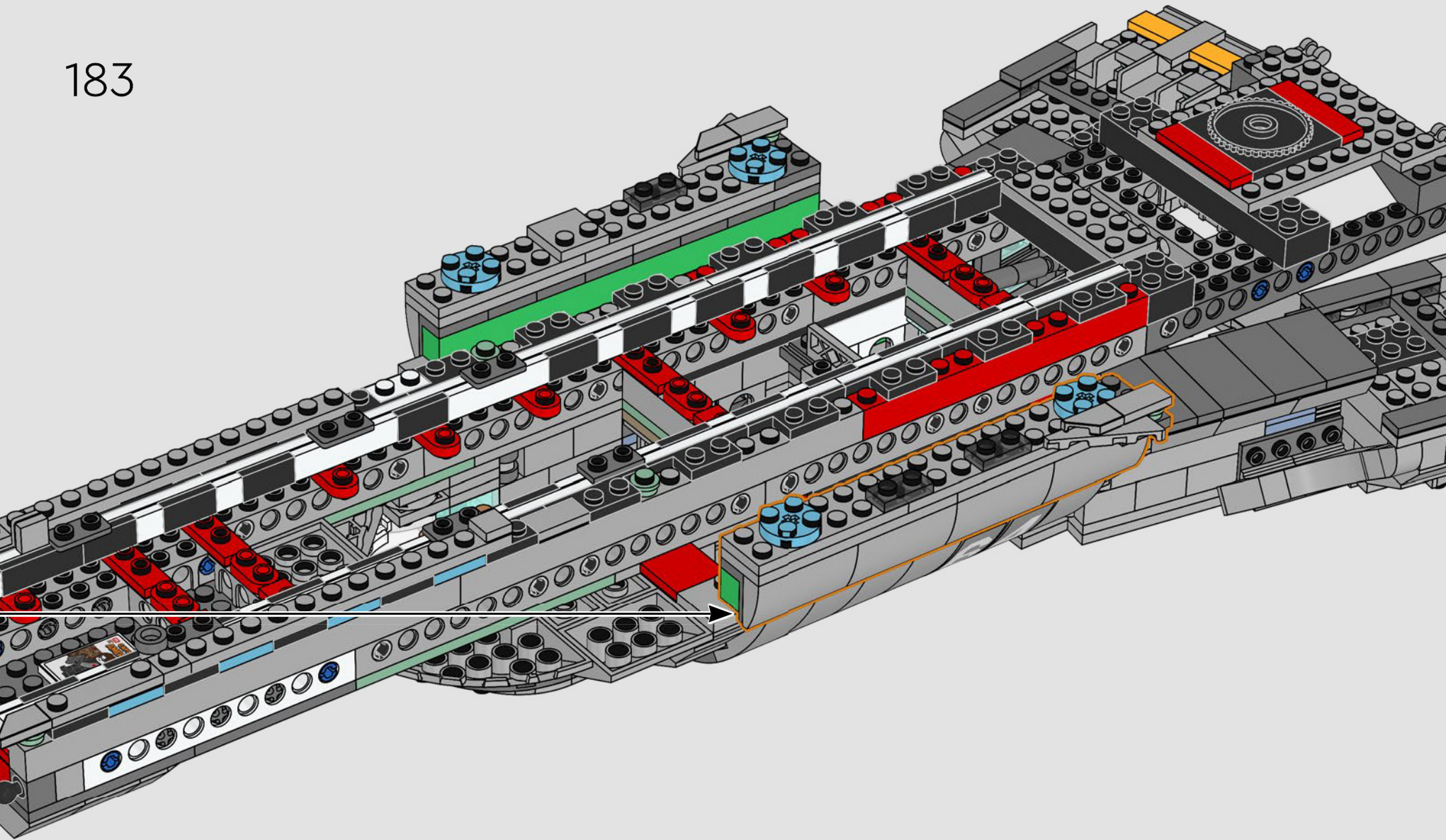

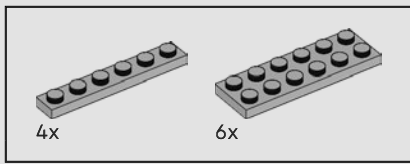

184

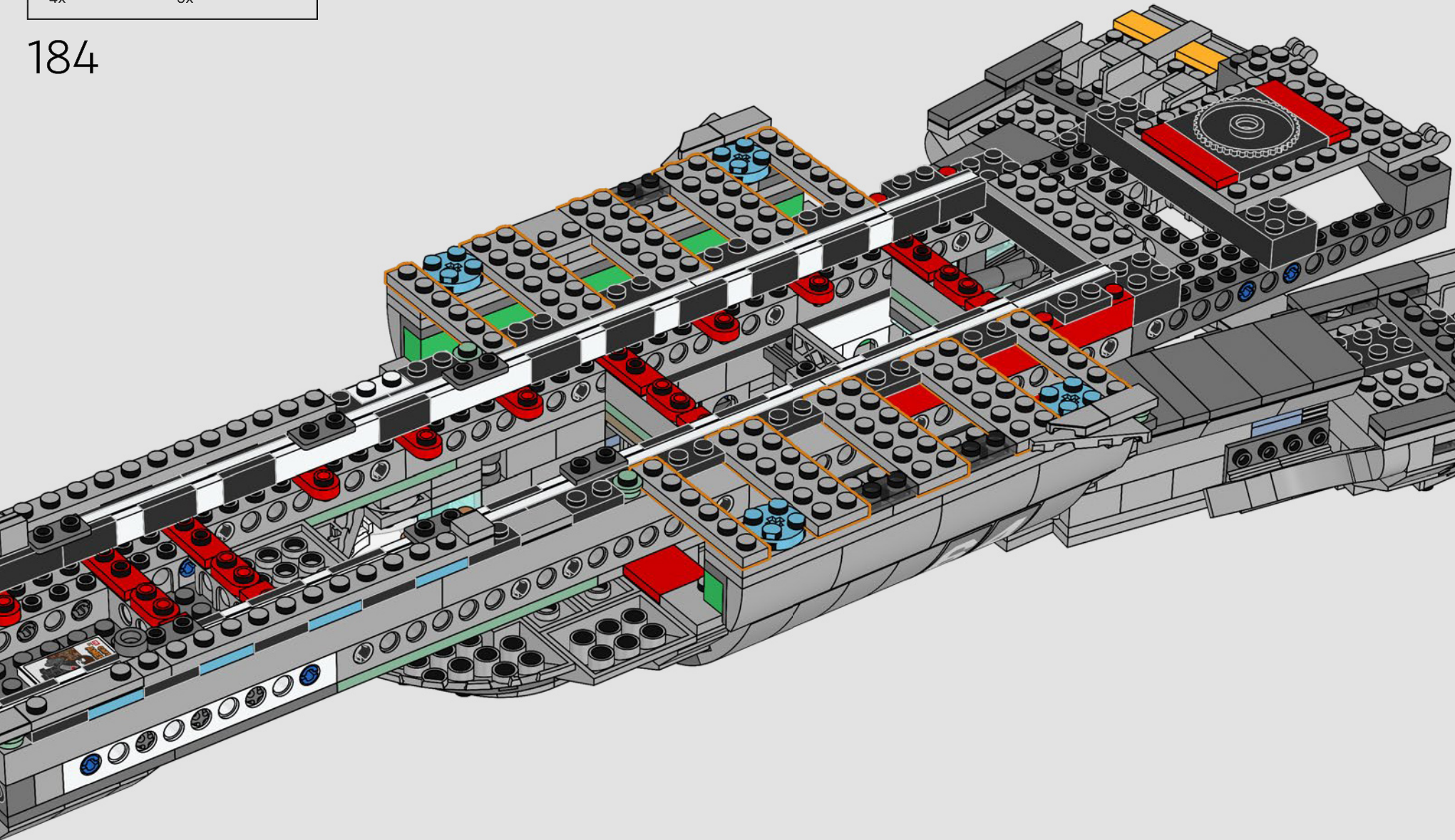

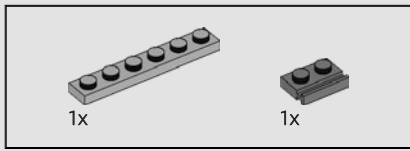

185

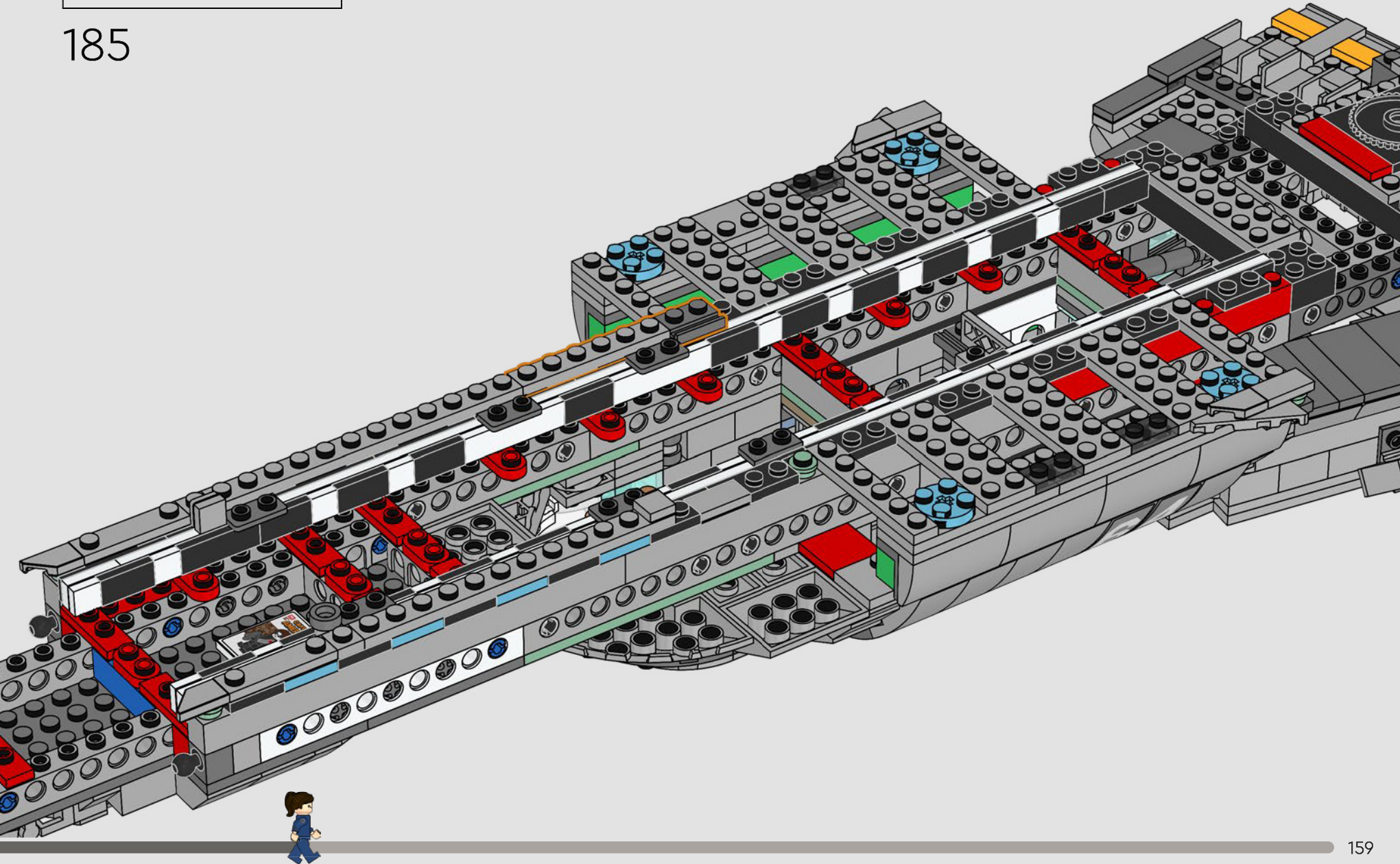

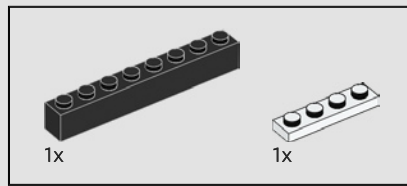

186

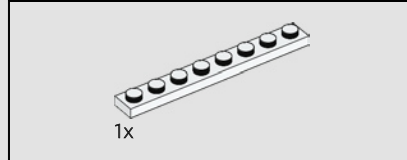
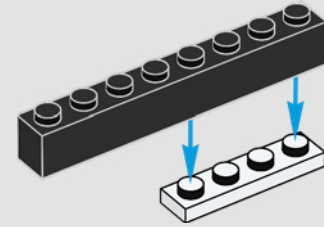

187

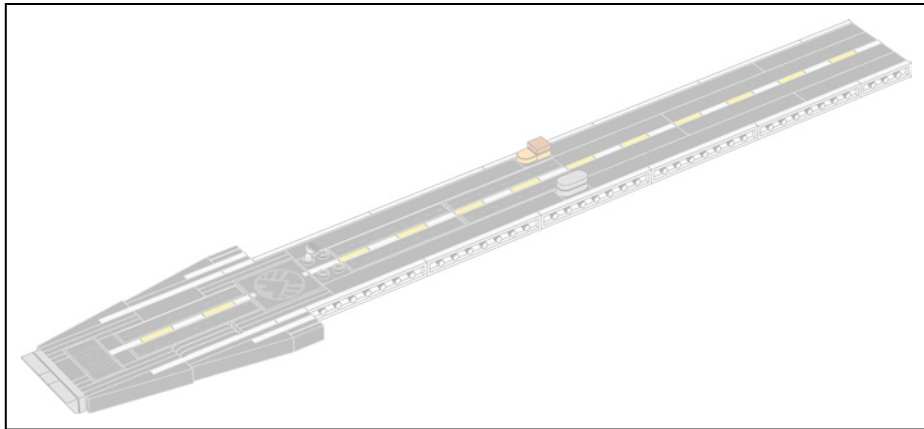
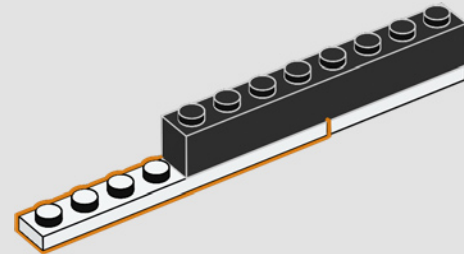

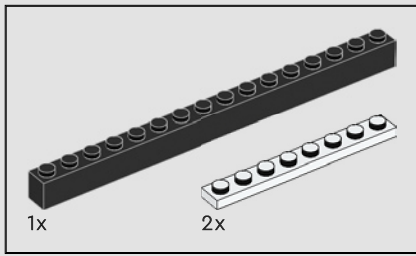

188

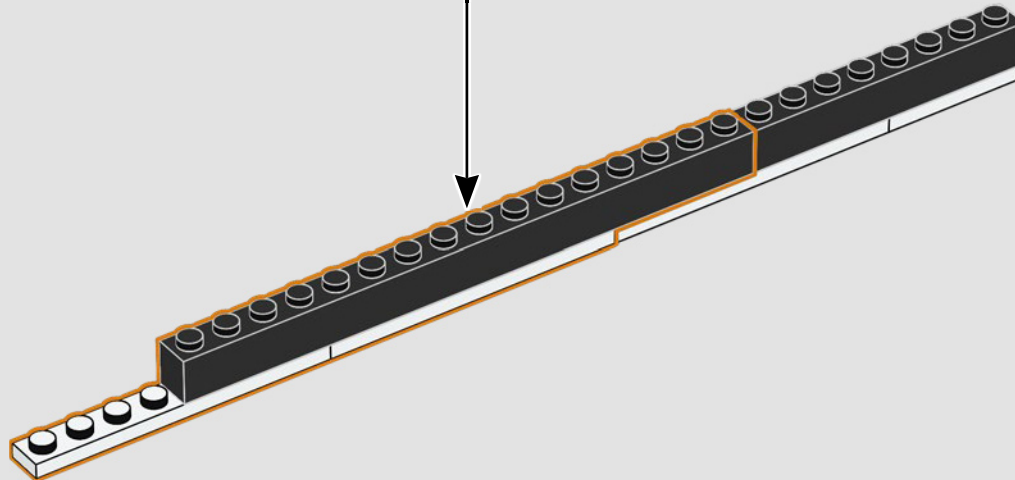
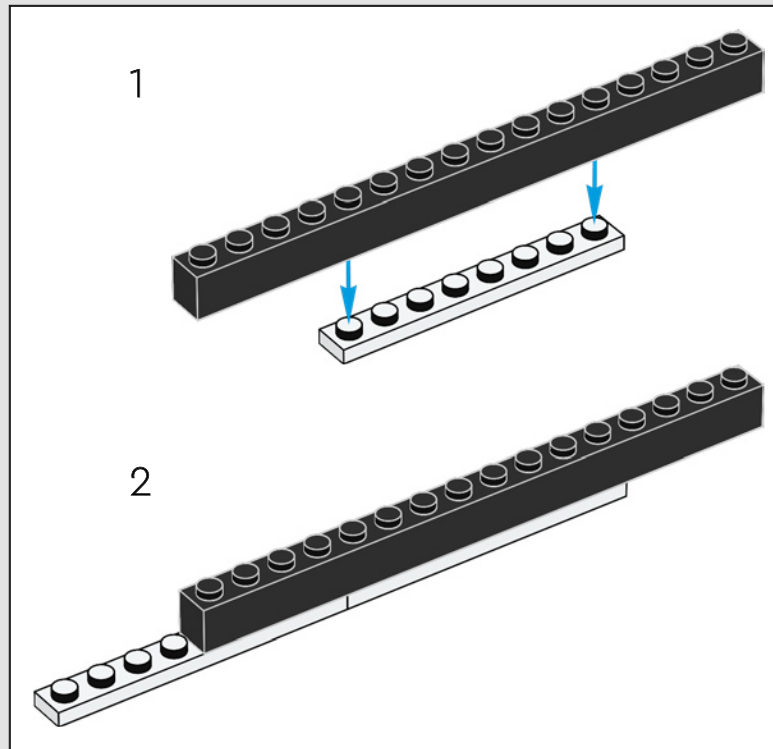

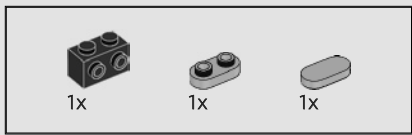

189

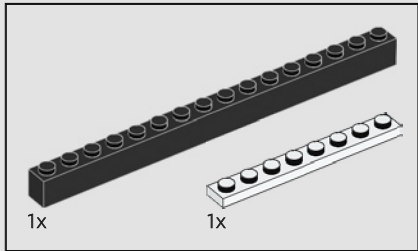
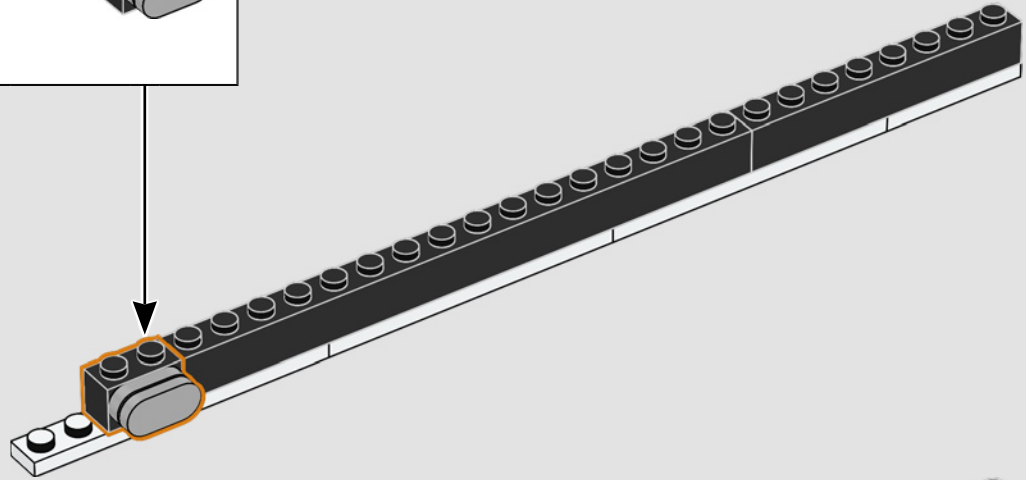
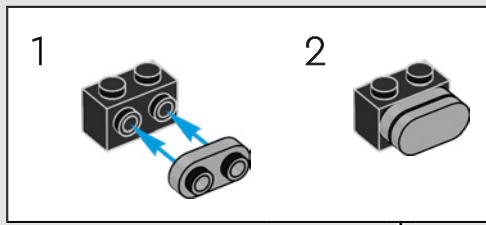

190

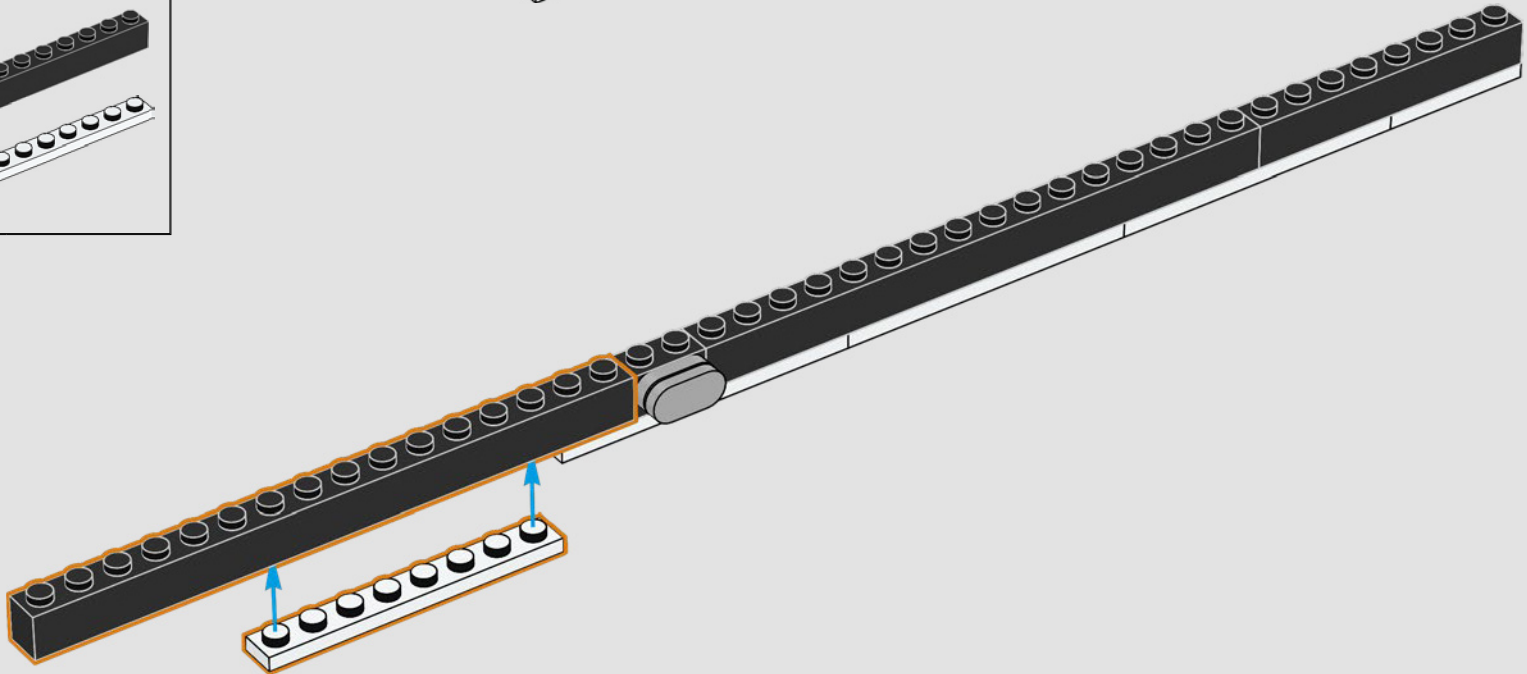

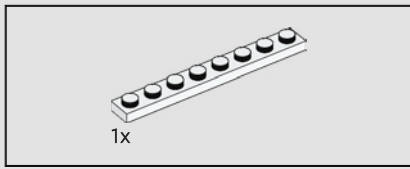

191

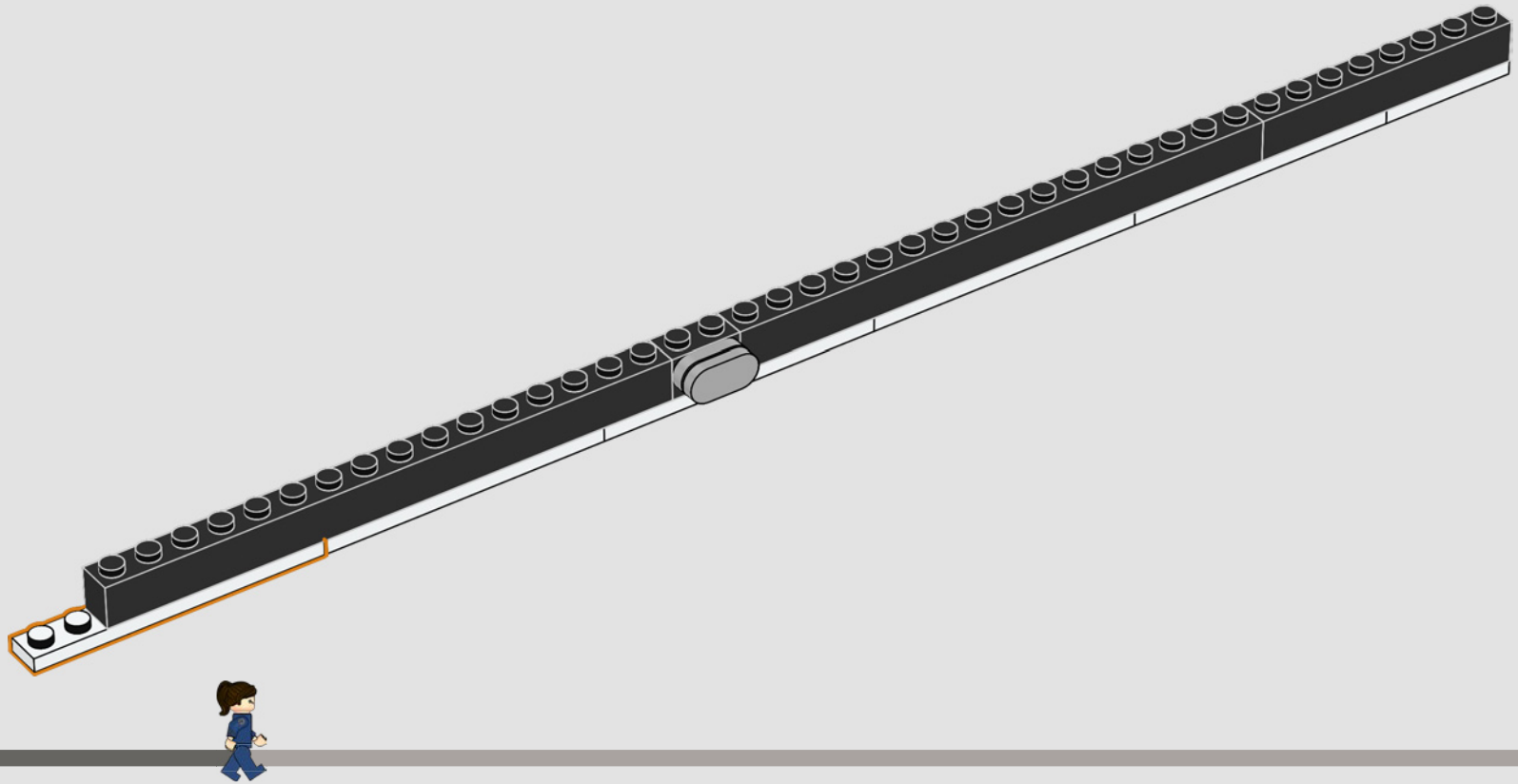

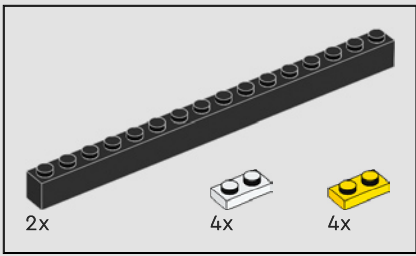

192

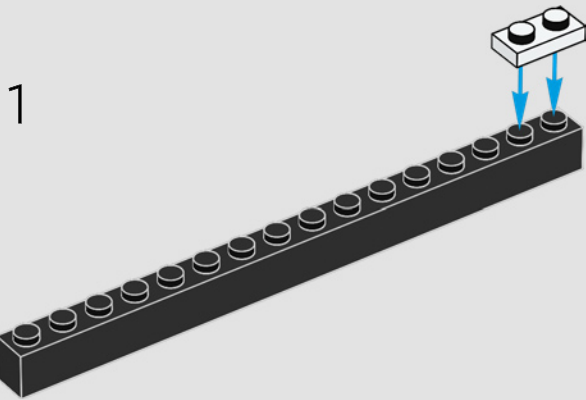

2

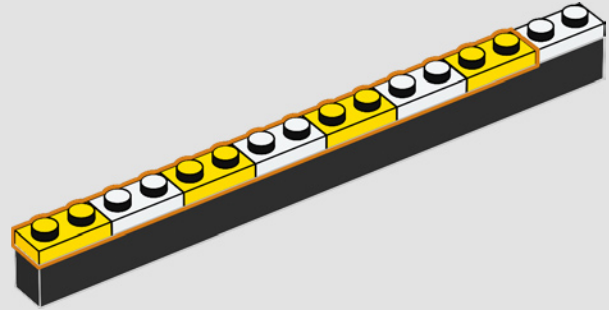

3

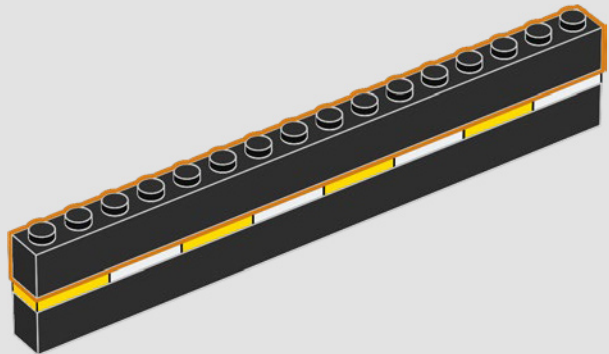

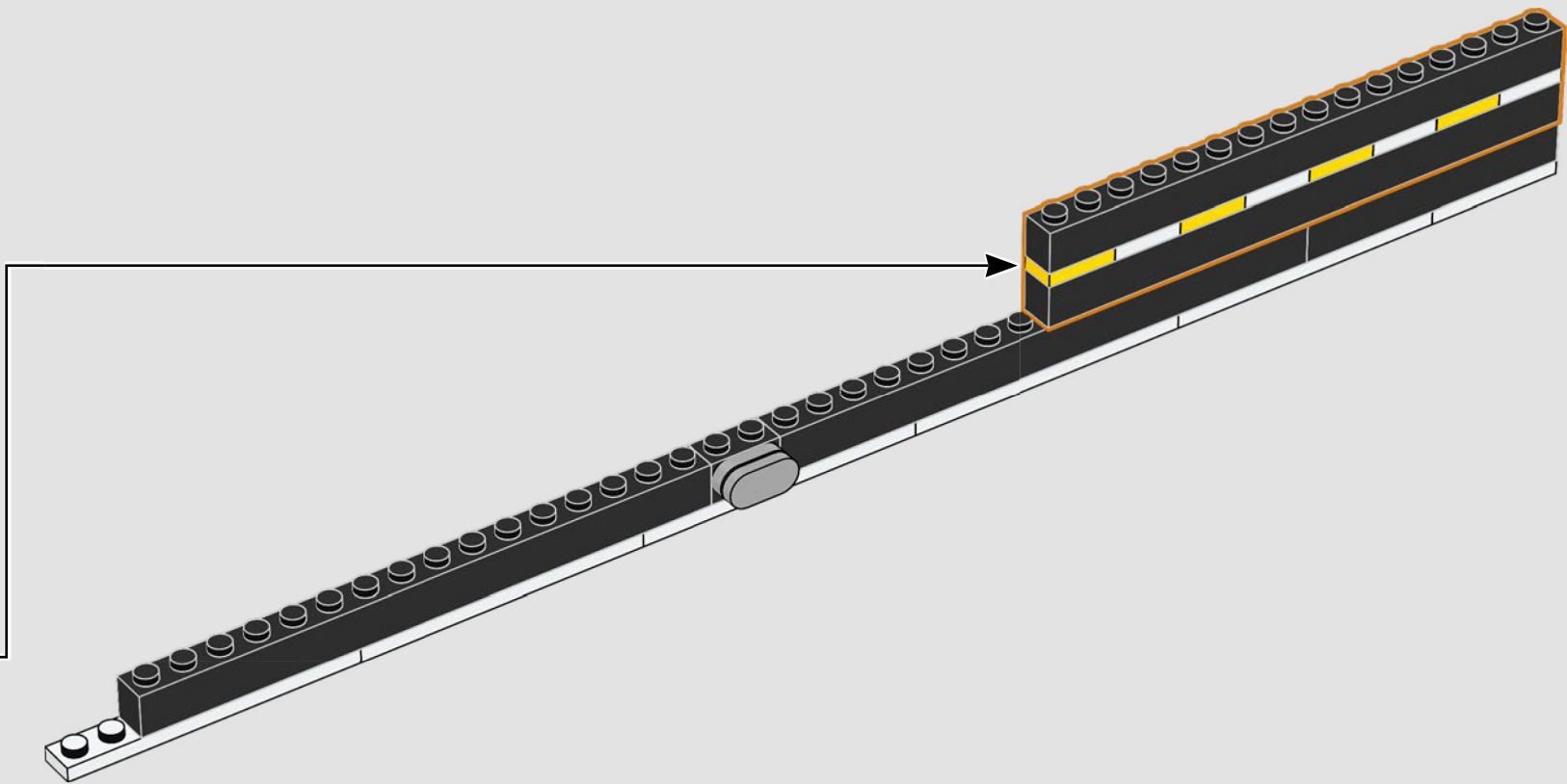

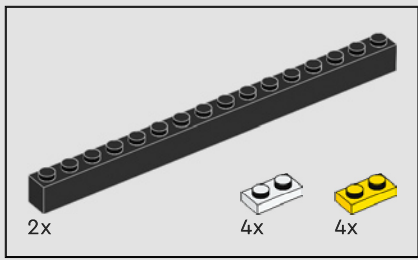

193

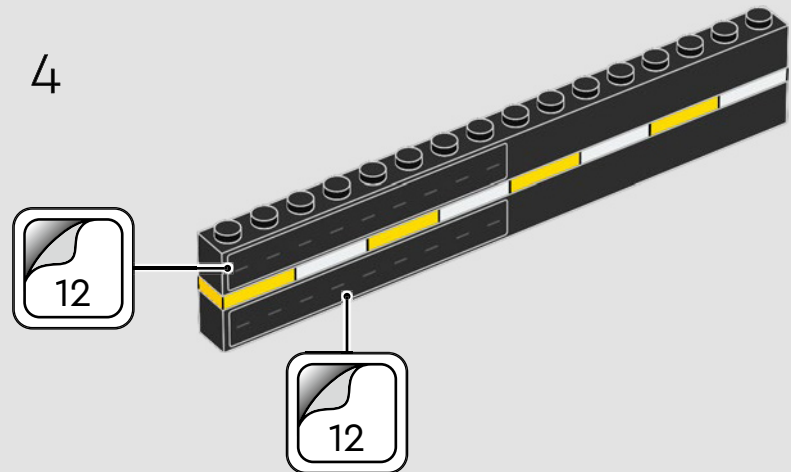
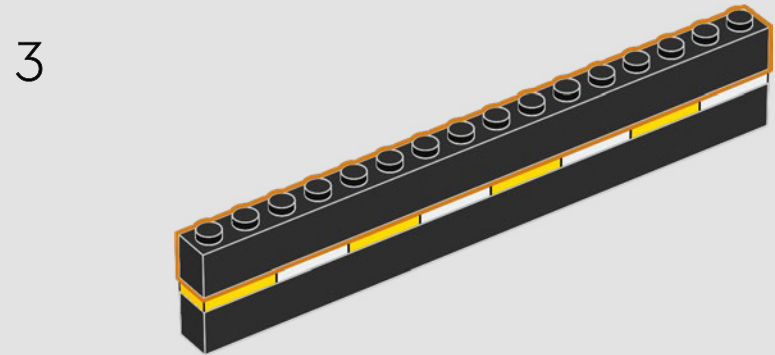
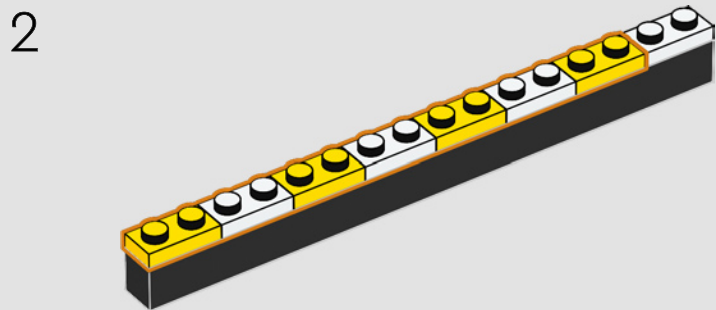
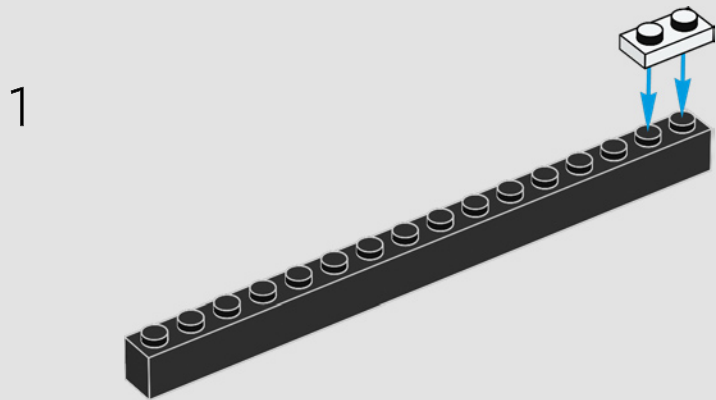

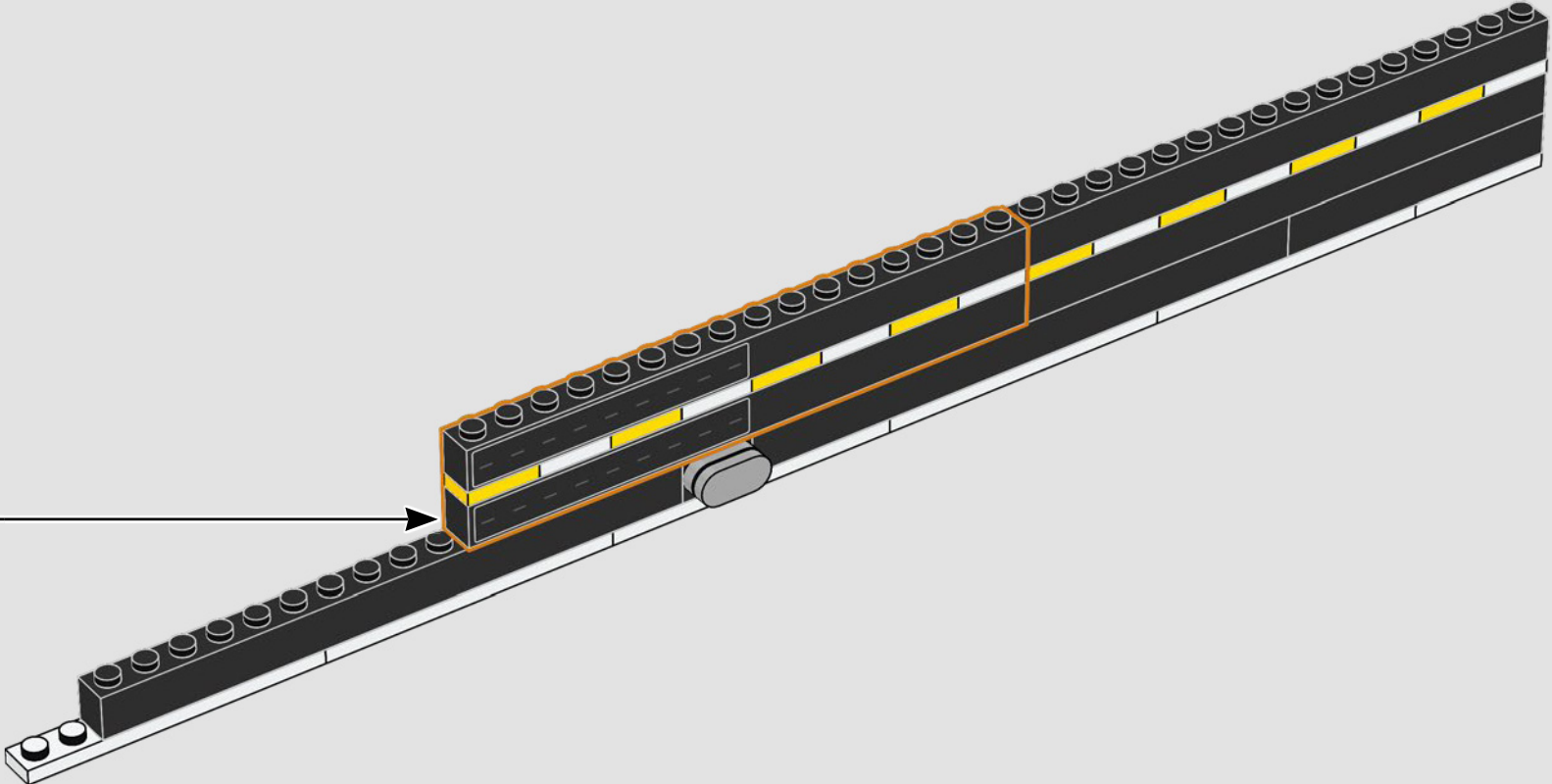

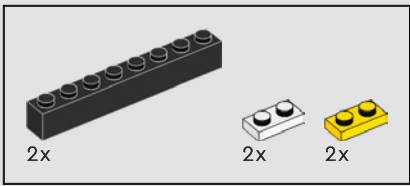

194

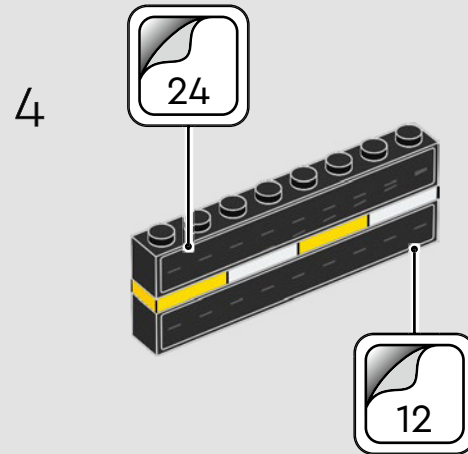
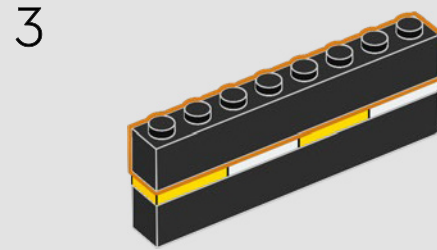
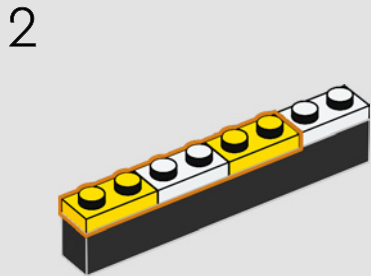
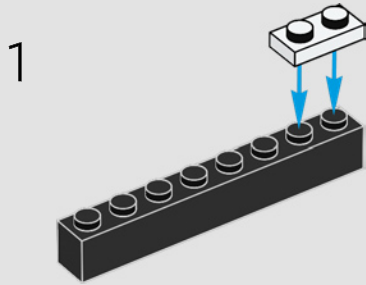

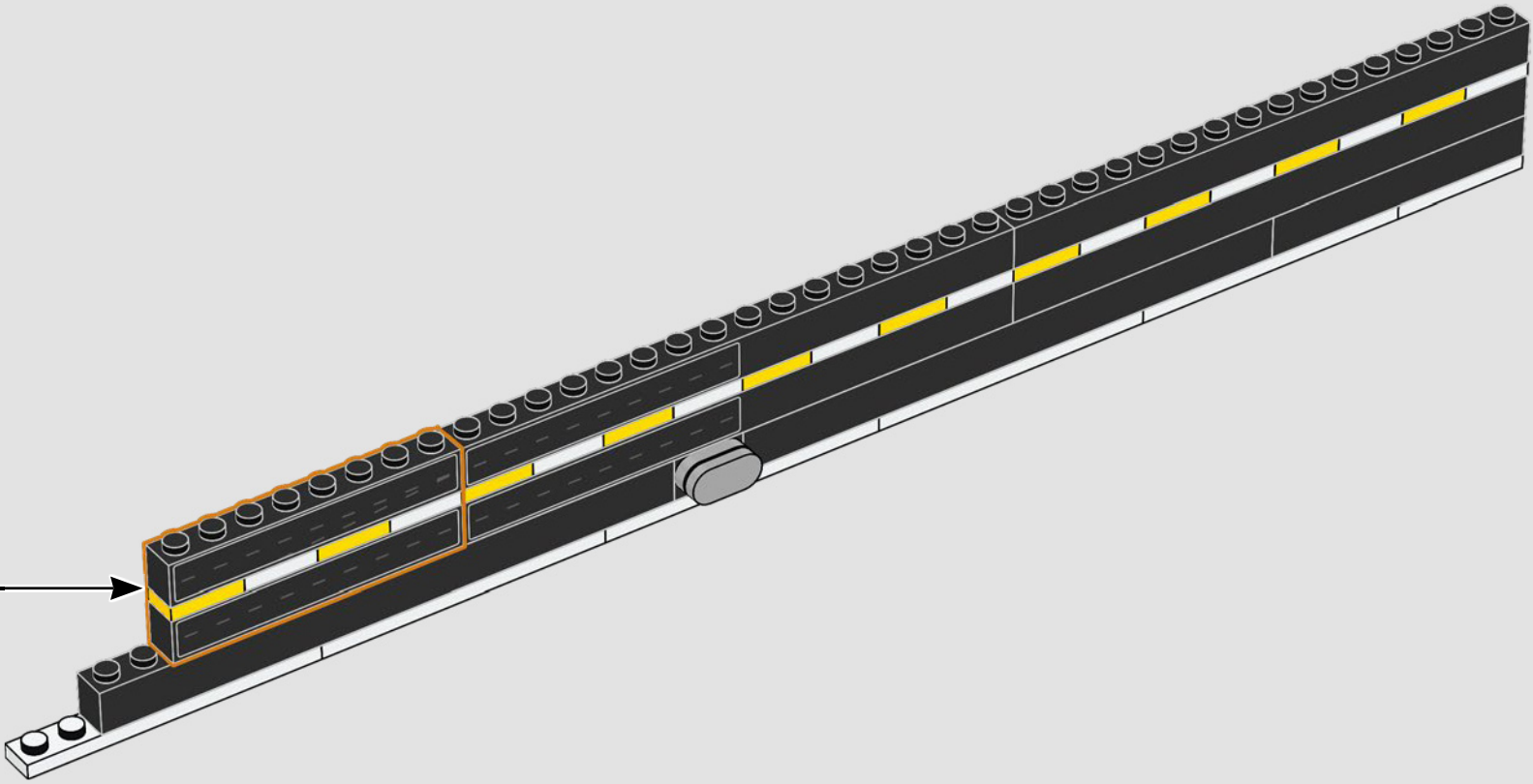

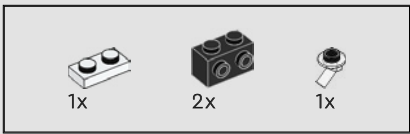

195

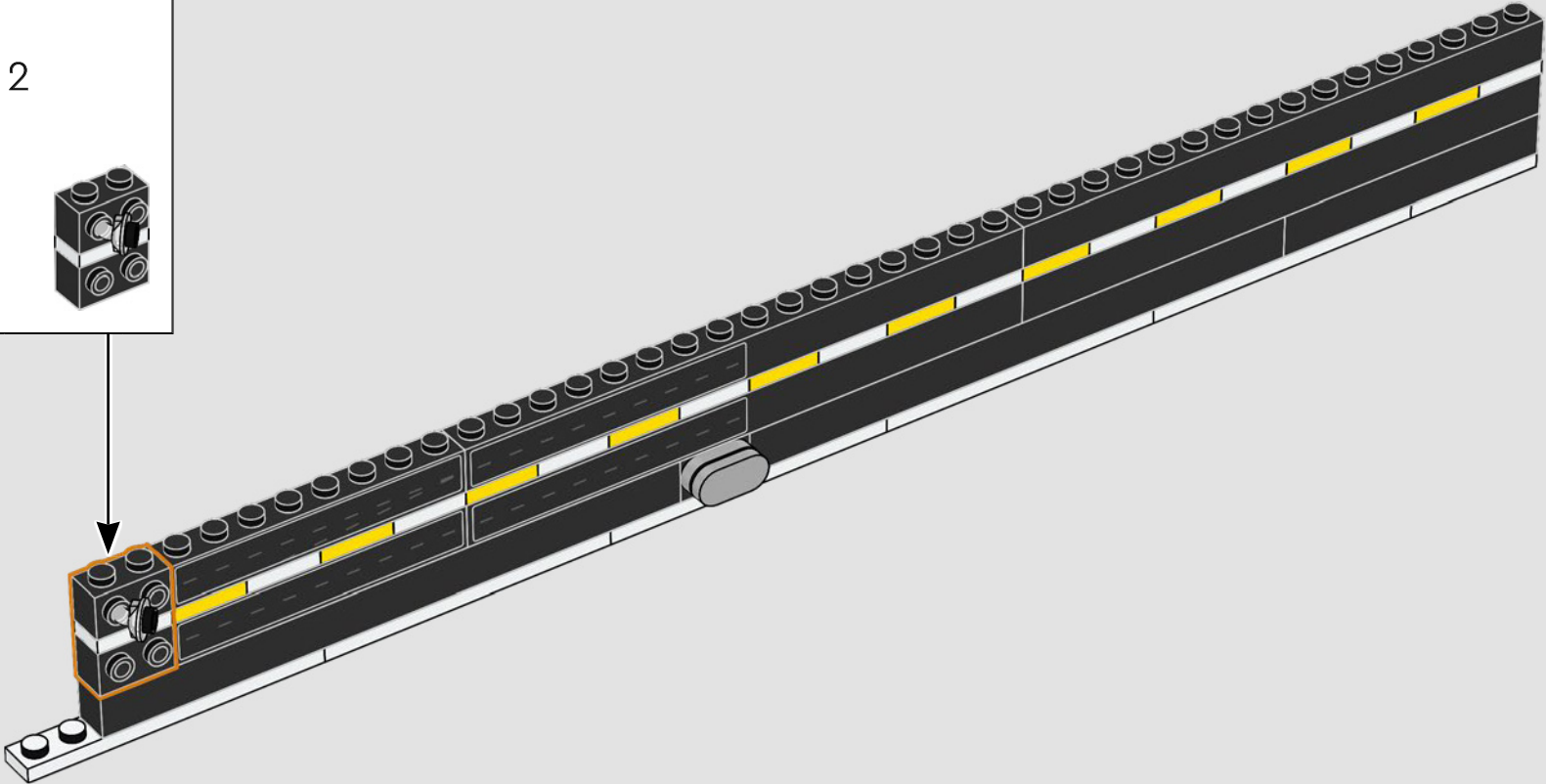
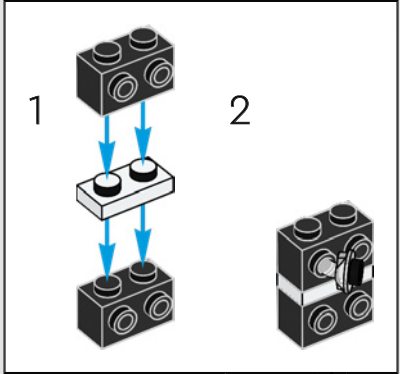

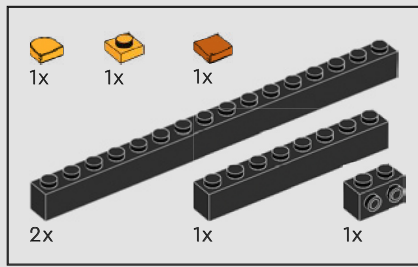

196

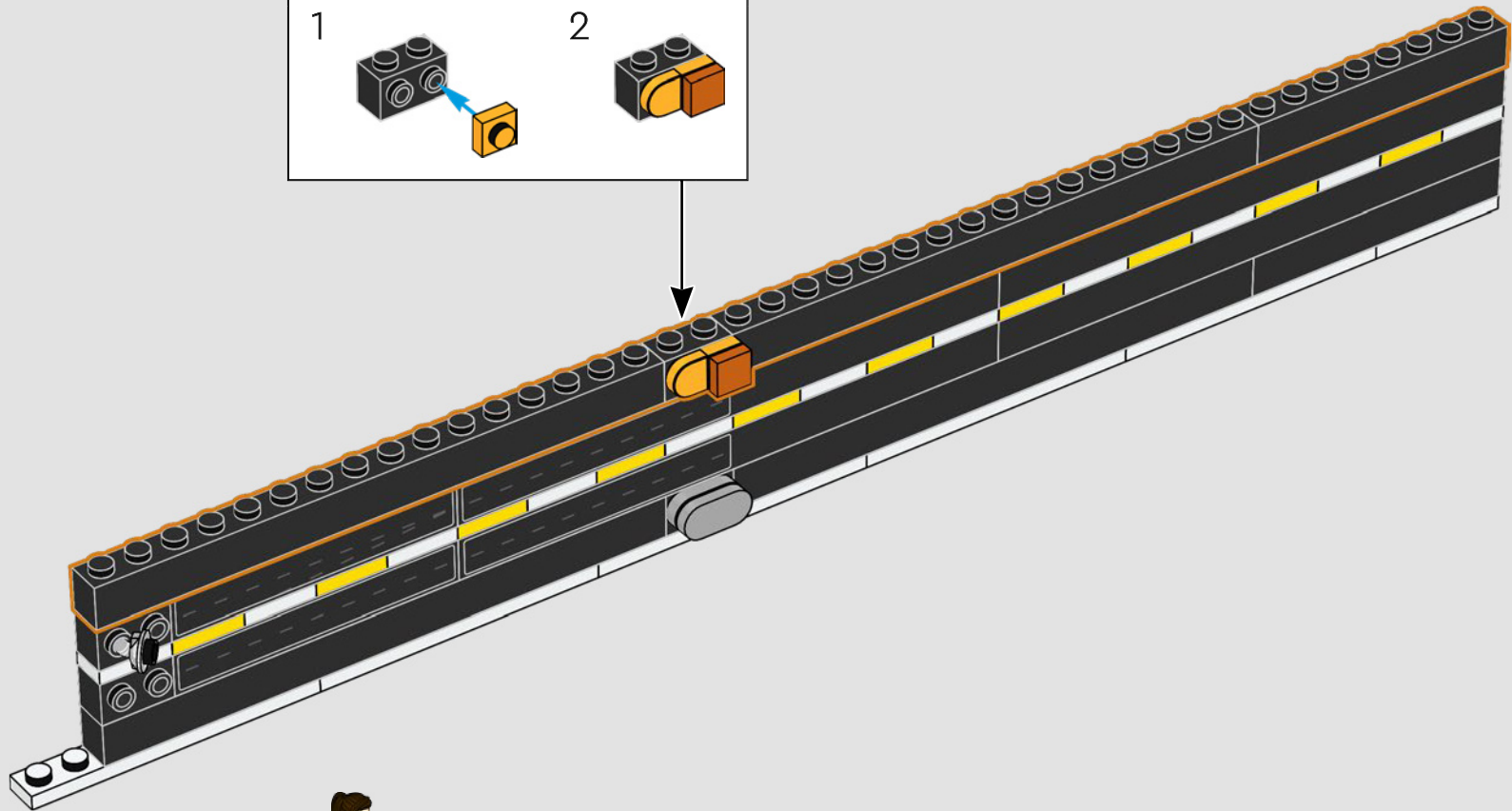
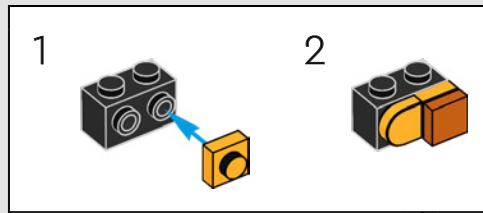

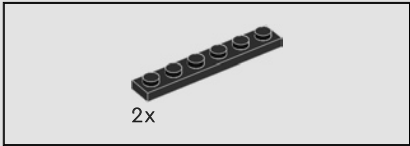
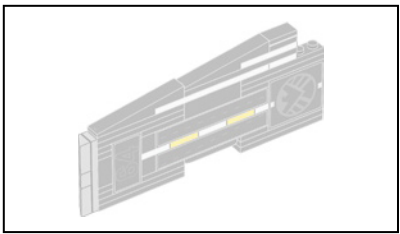

197

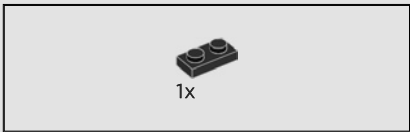
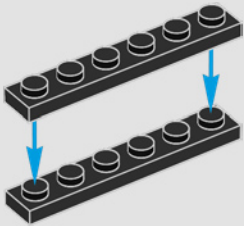

198

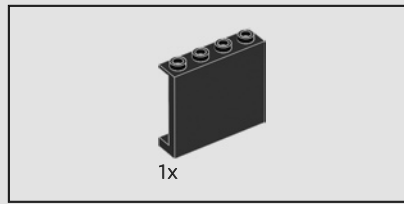
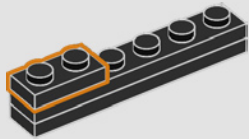

199

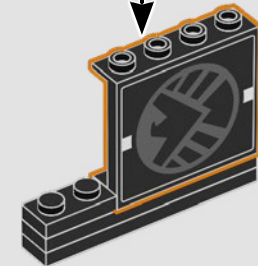
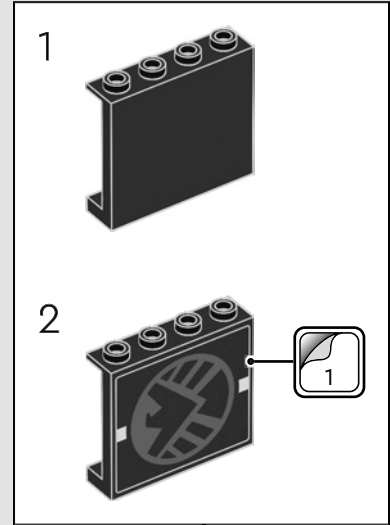

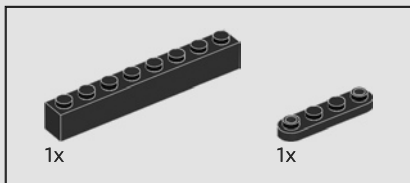

200

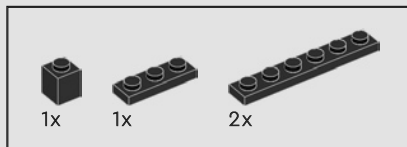
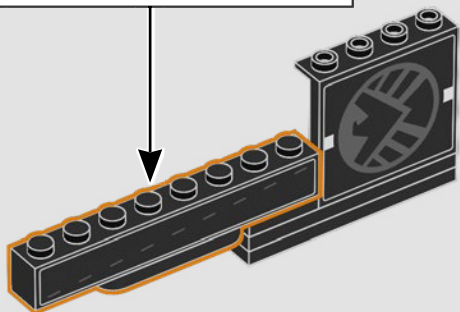
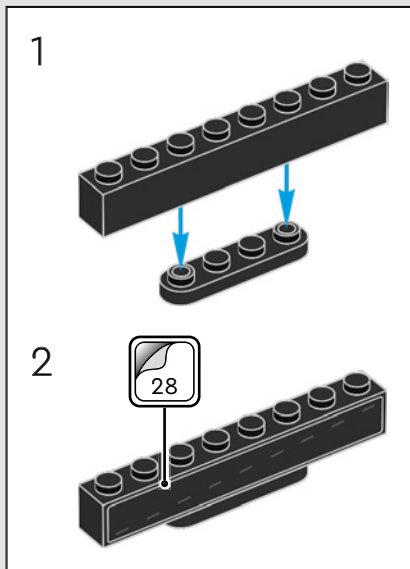

201

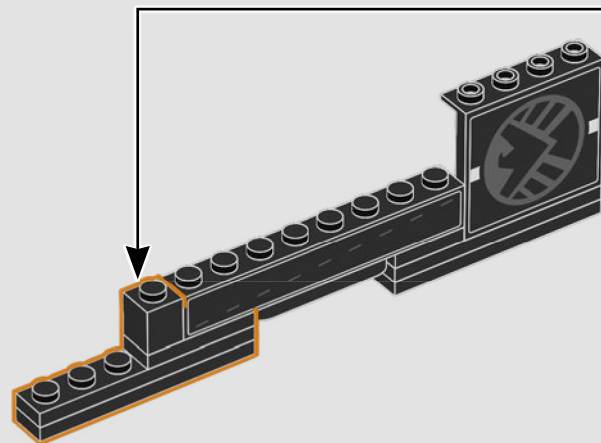
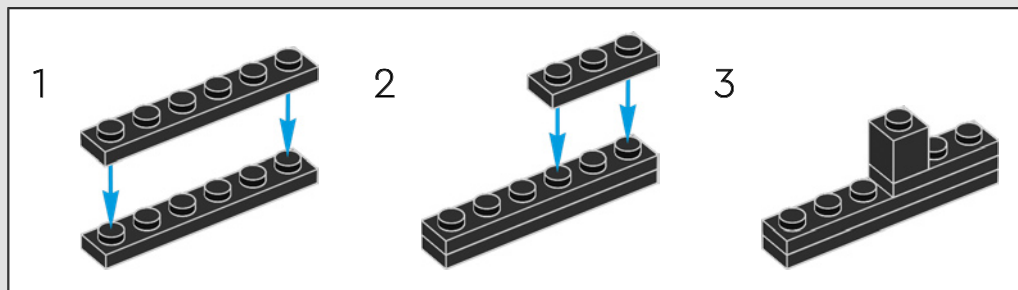



202

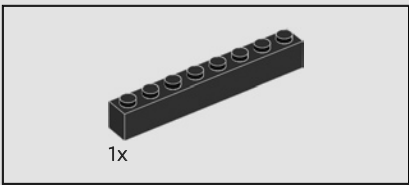
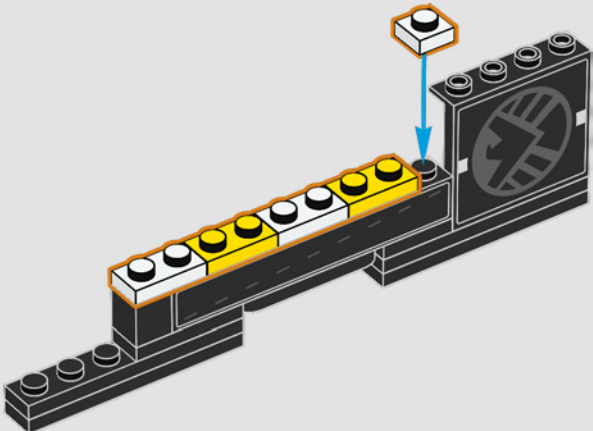

203

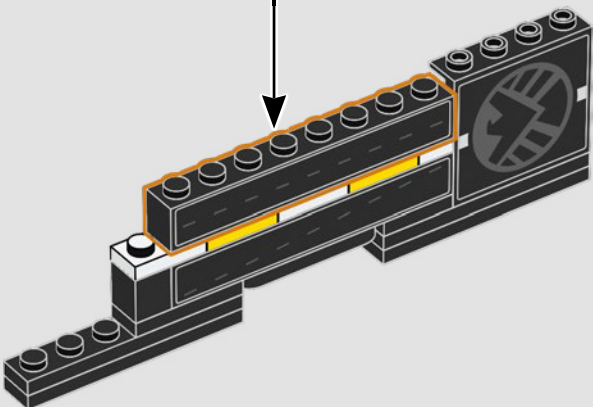
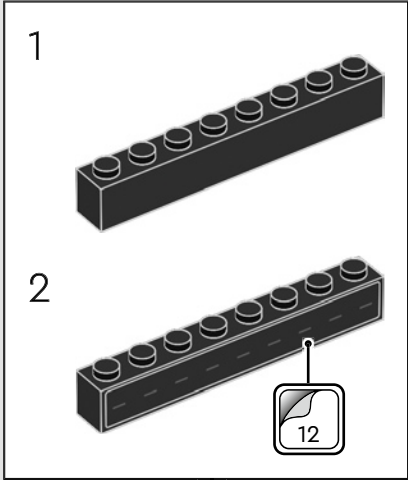



204

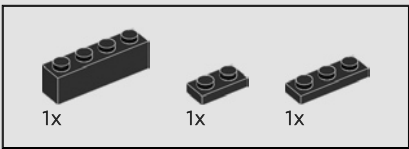
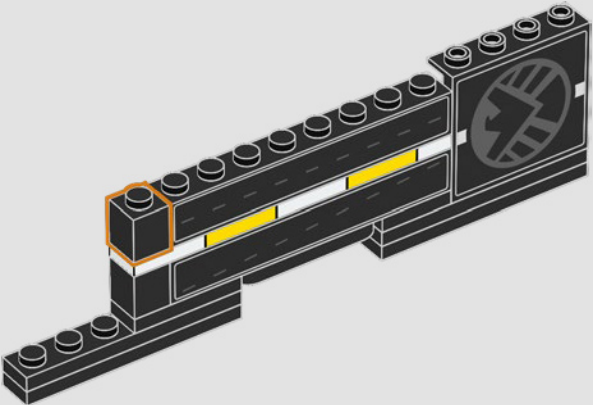

205

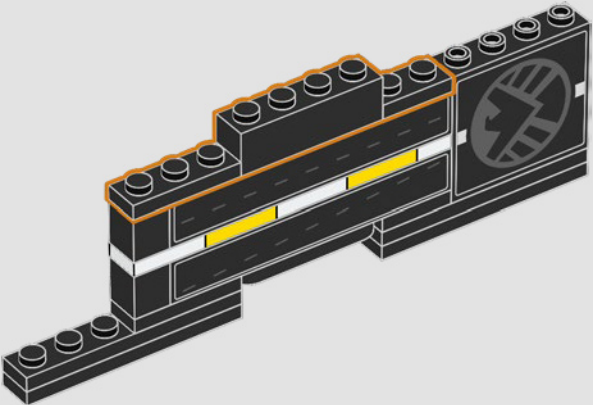

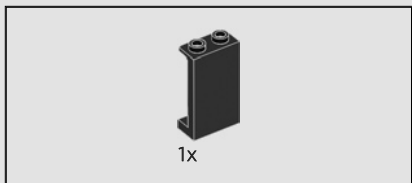

206

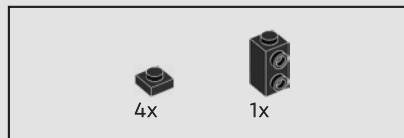
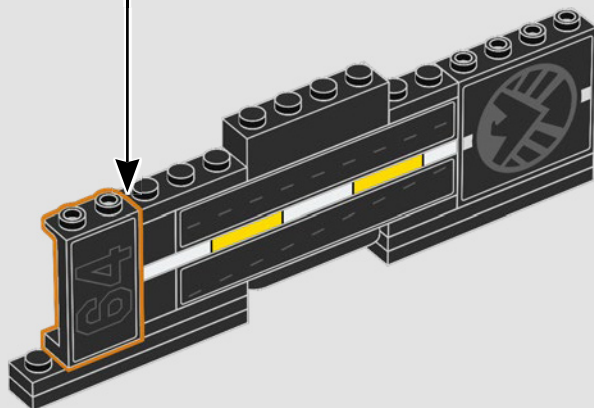
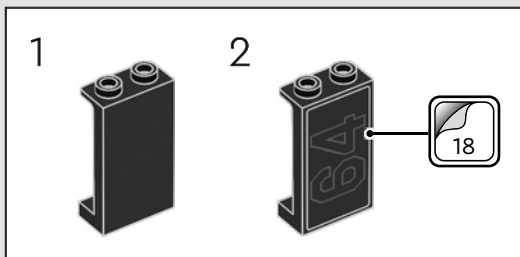

207

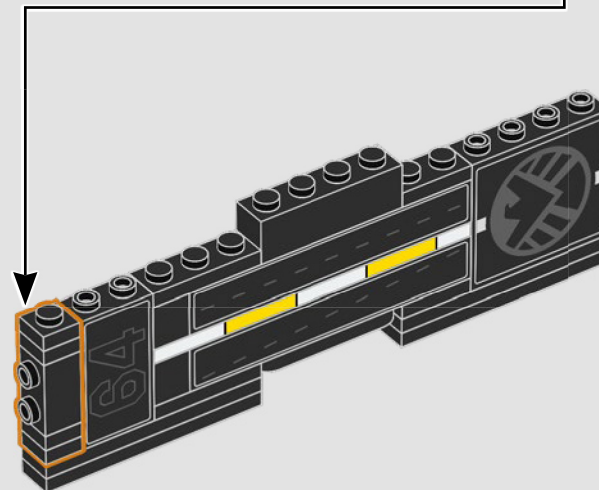
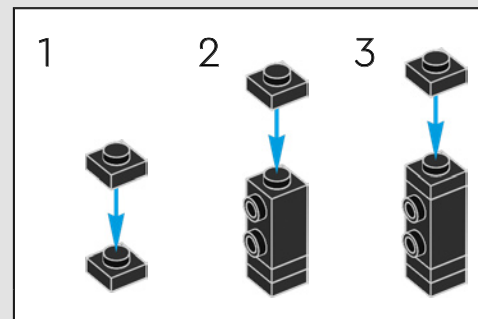

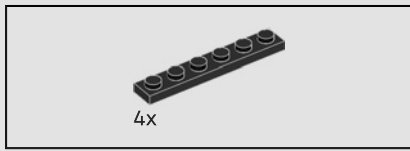

208

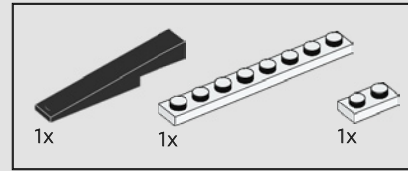
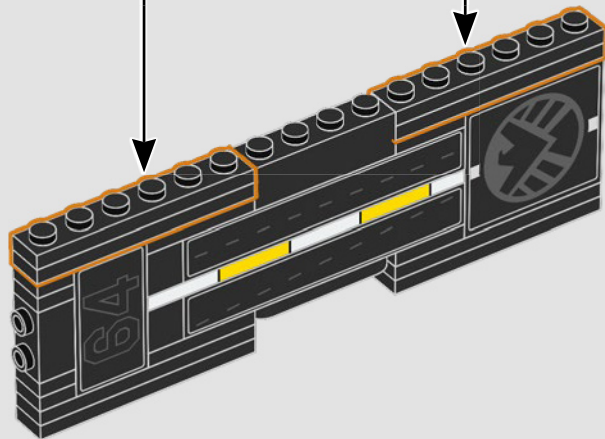
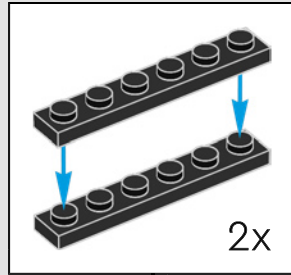

209

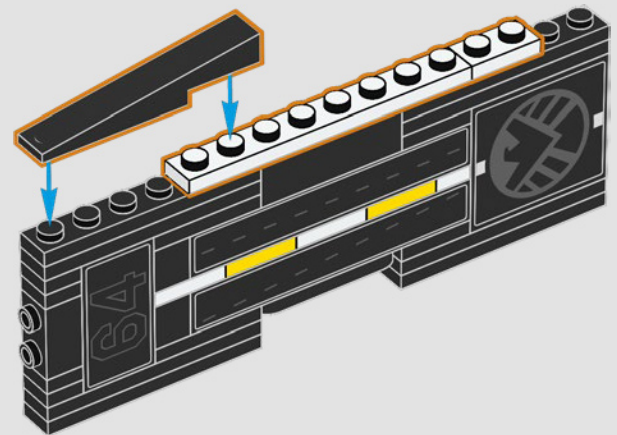

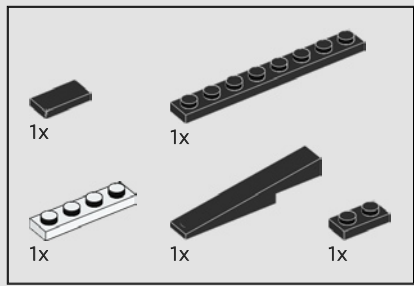

210

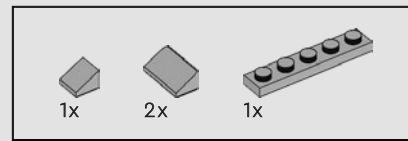
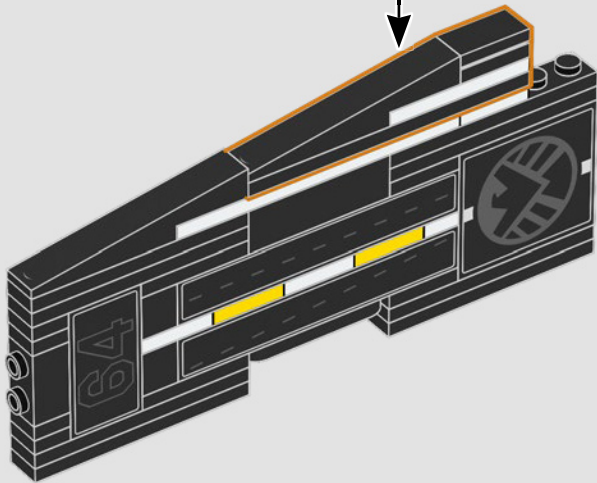
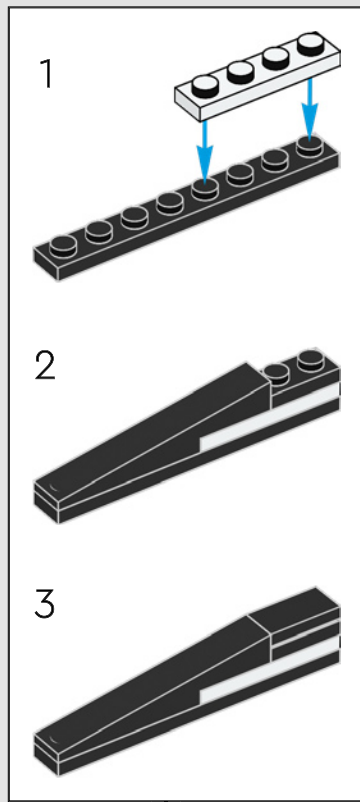

211

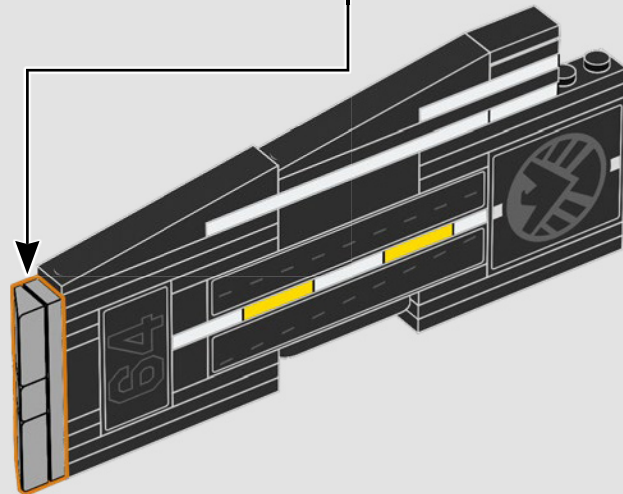
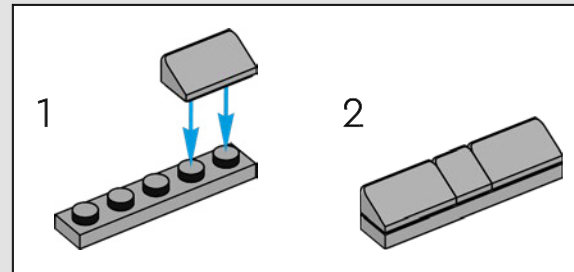

212

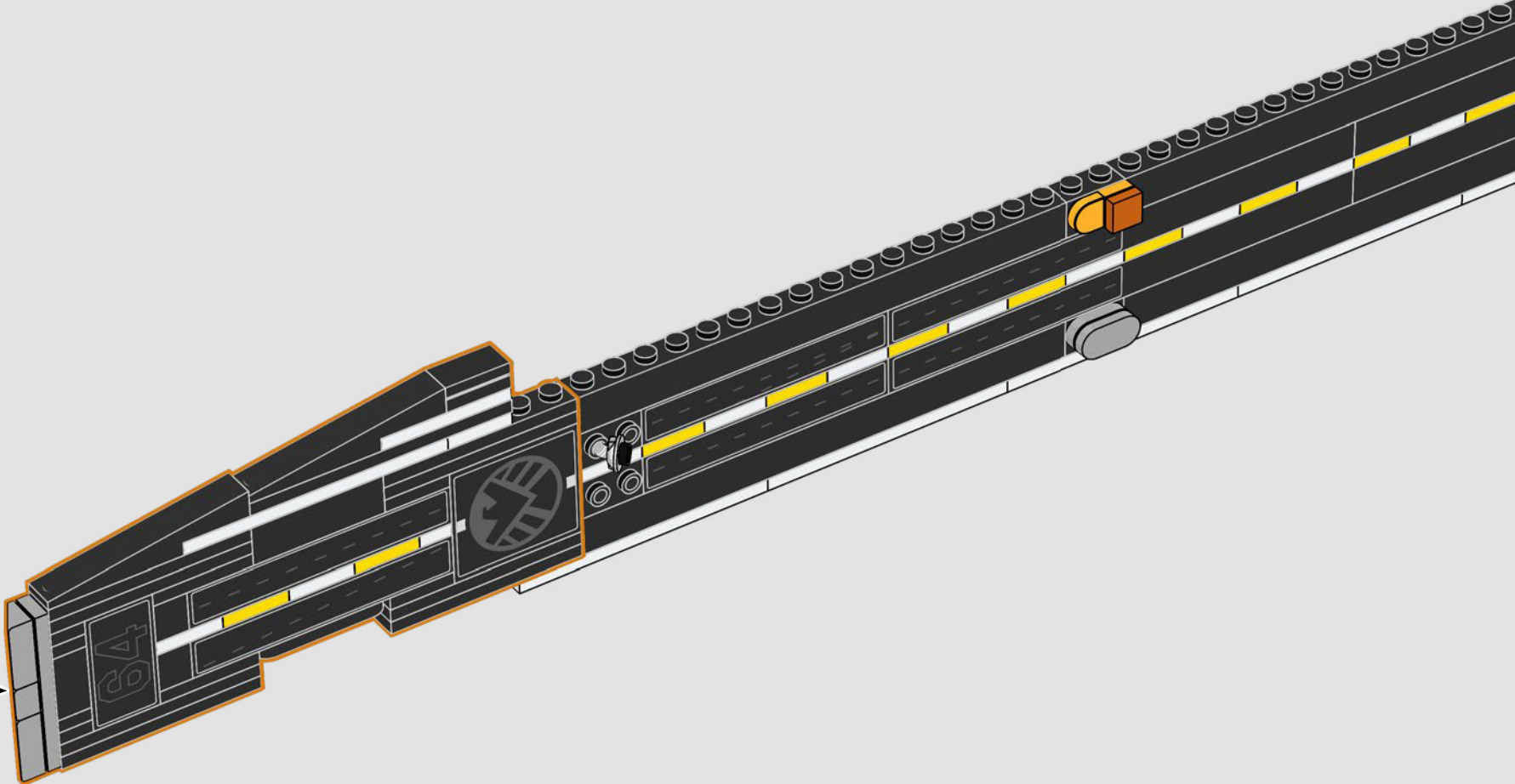

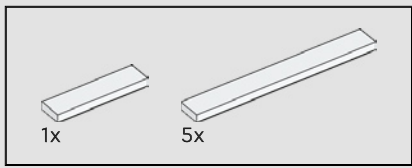

213

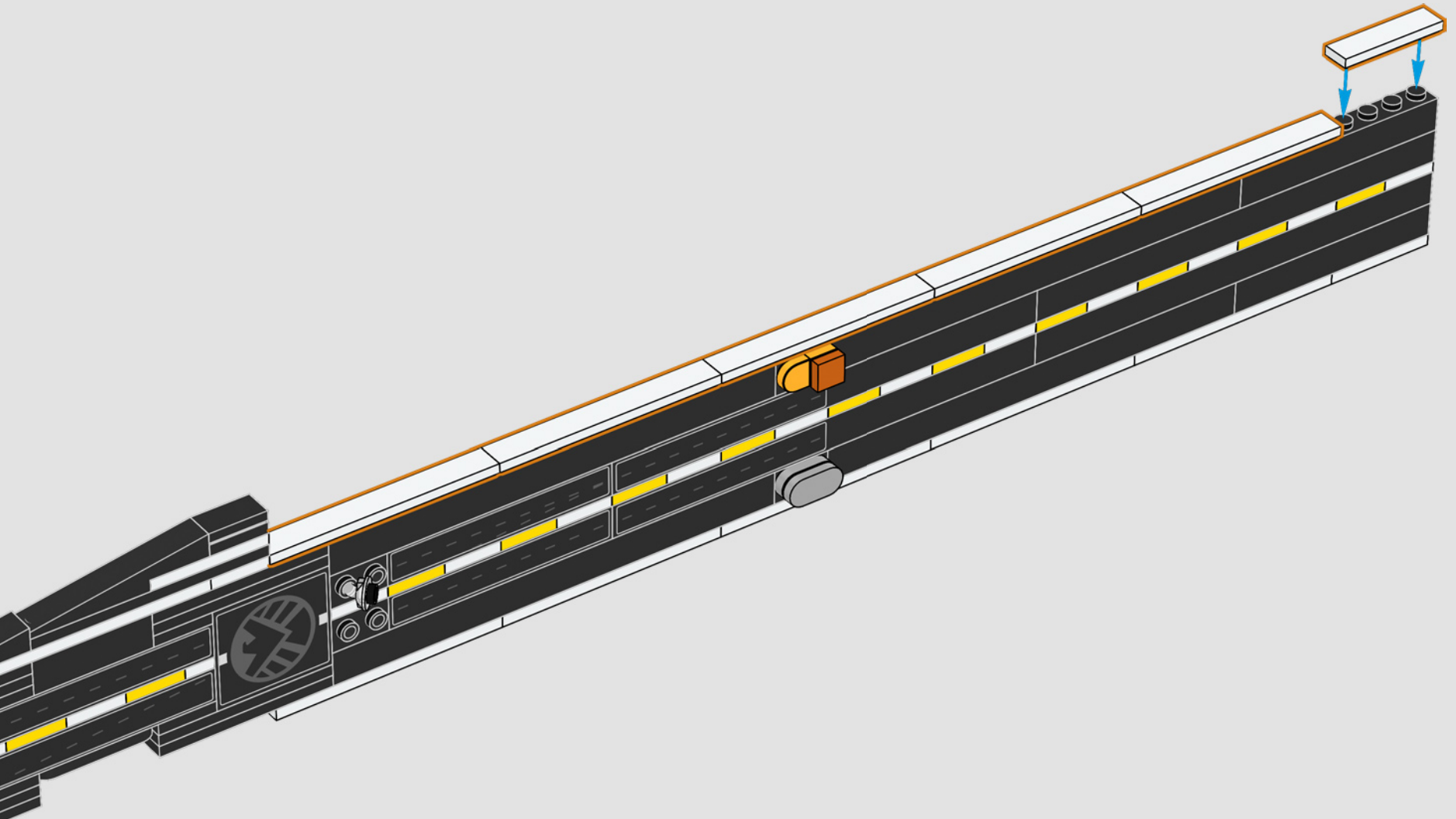

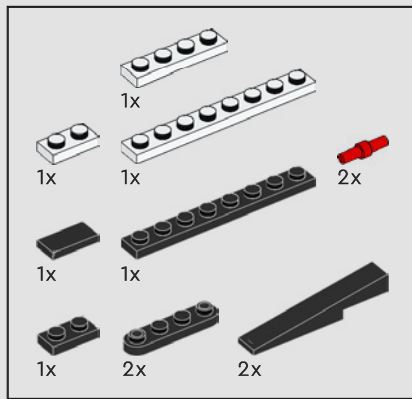

214

1

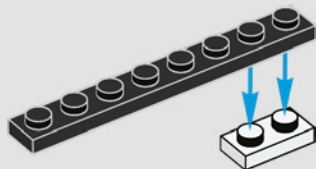

2

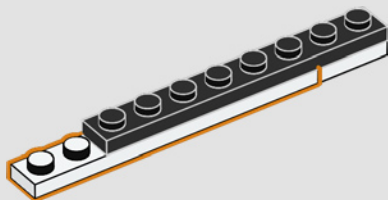

3

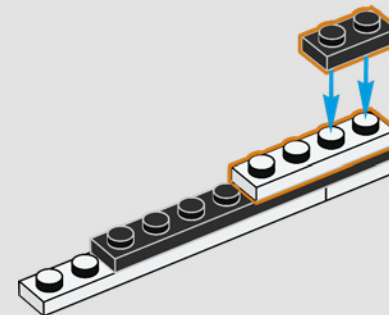

4

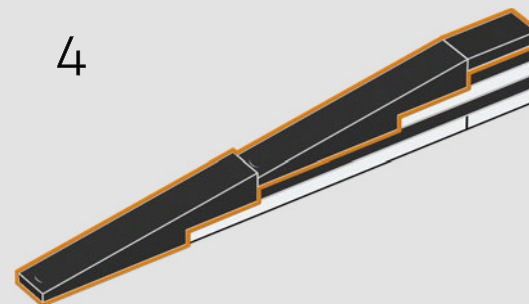

1

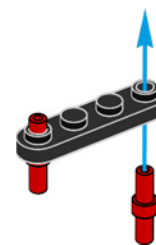

2

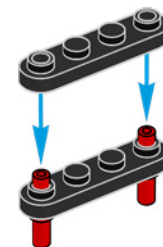

5

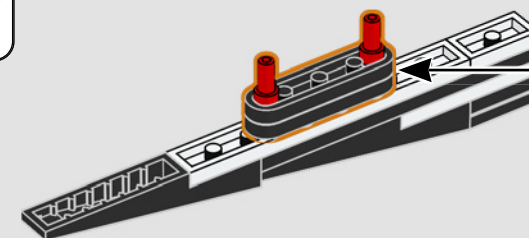

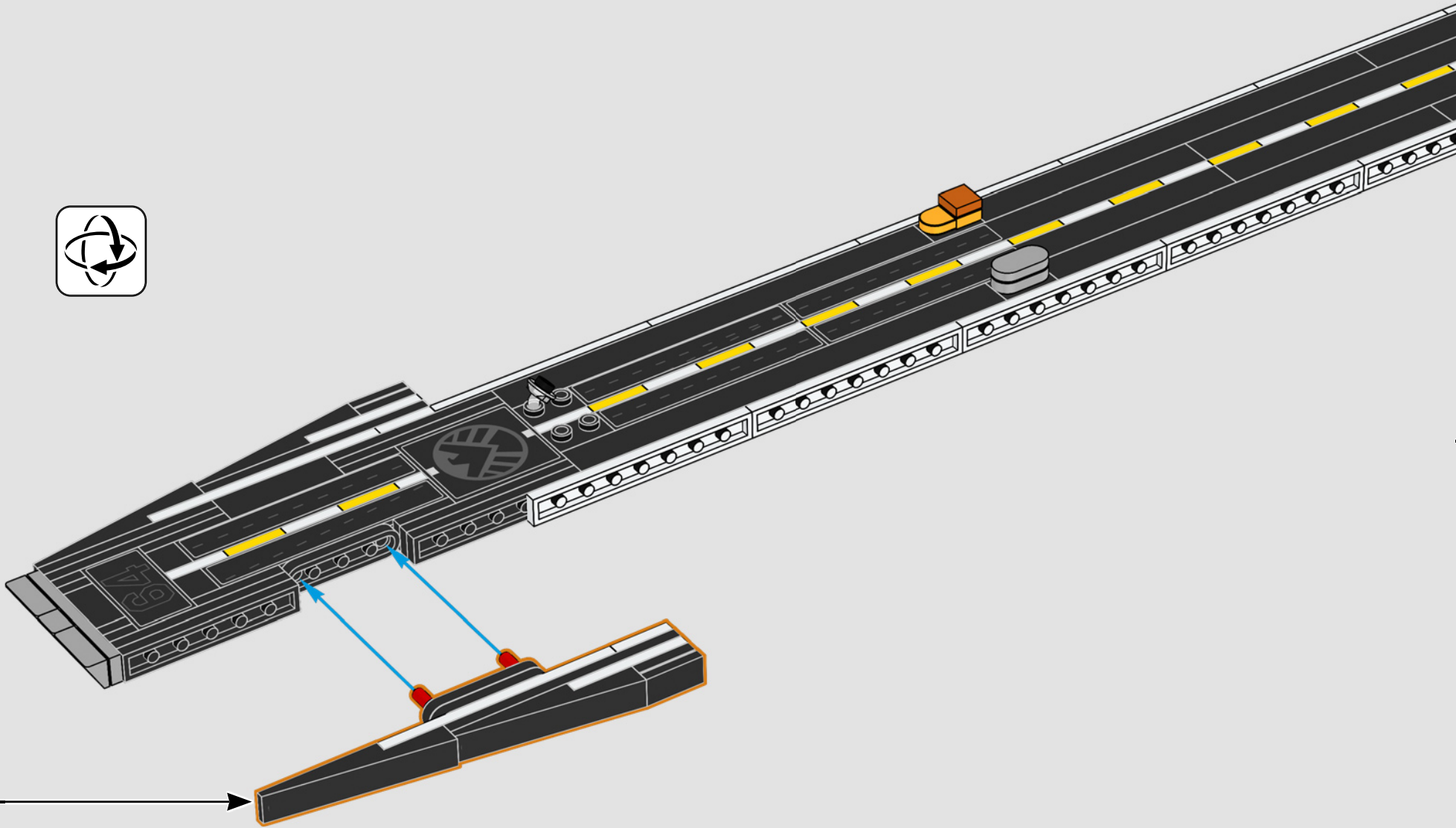

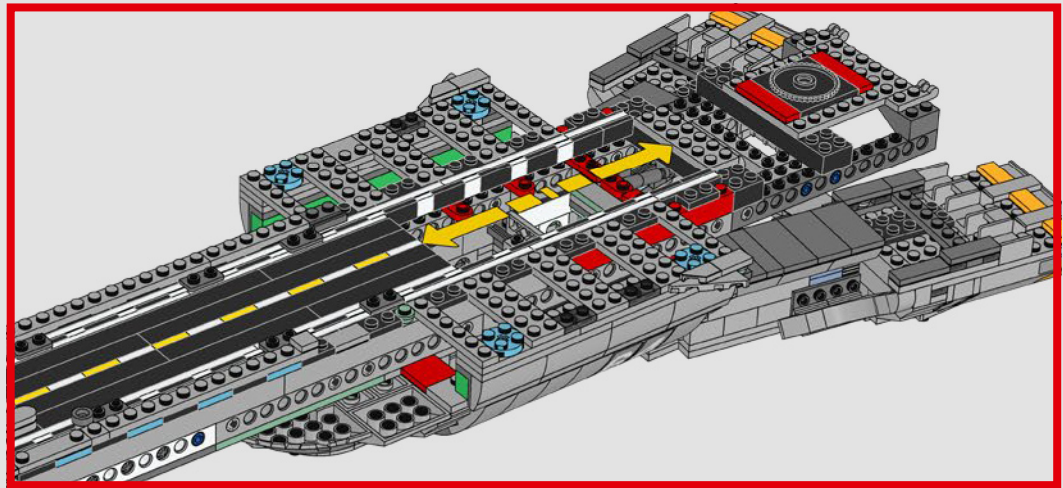
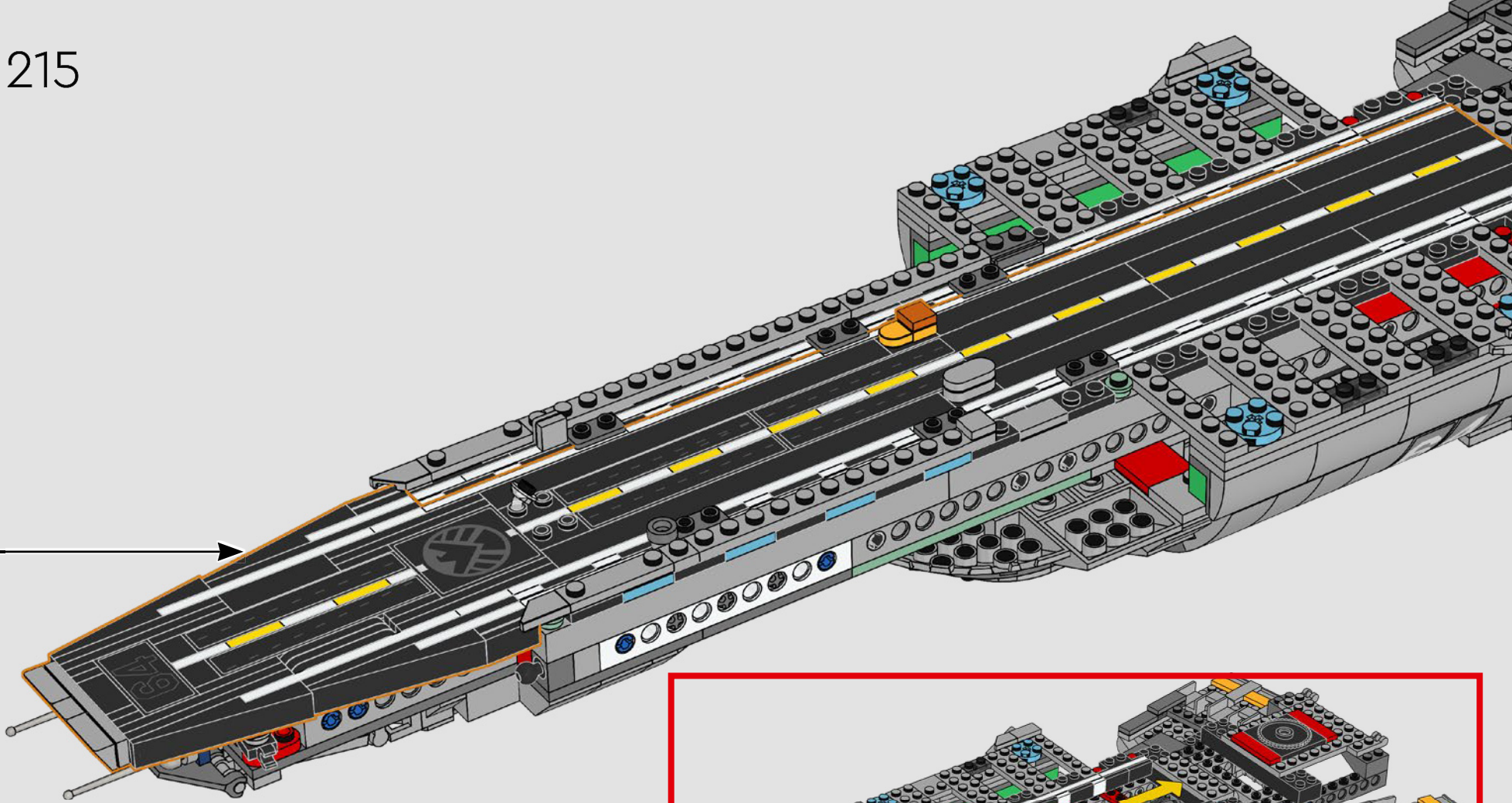

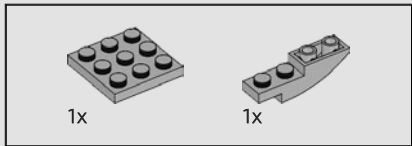
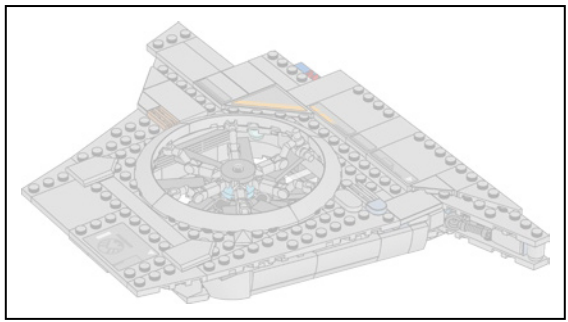

216

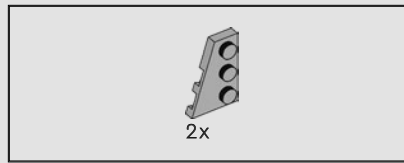
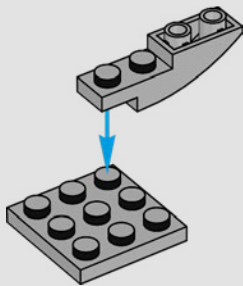

217

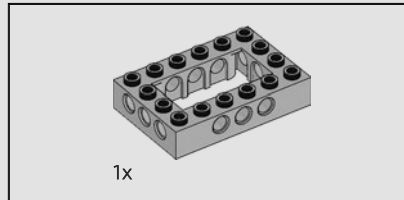
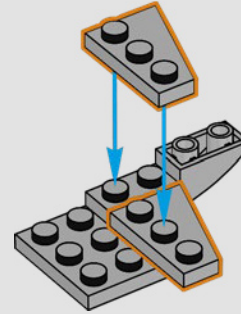

218

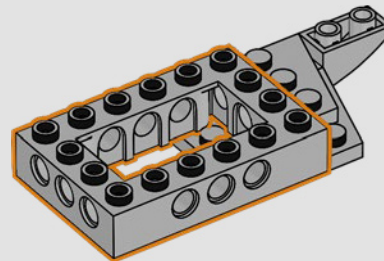

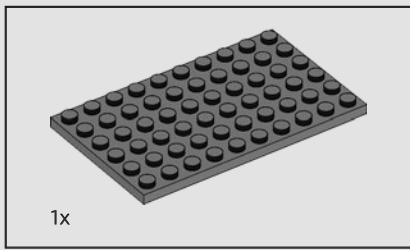

219

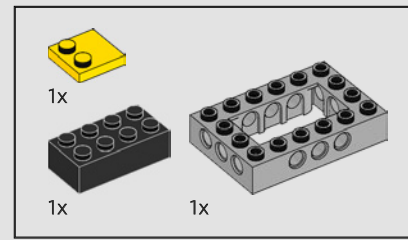
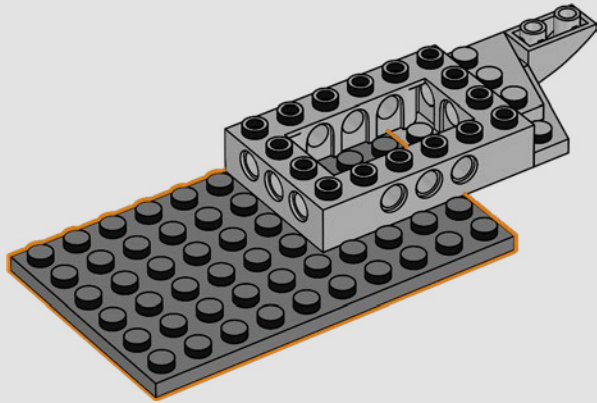

220

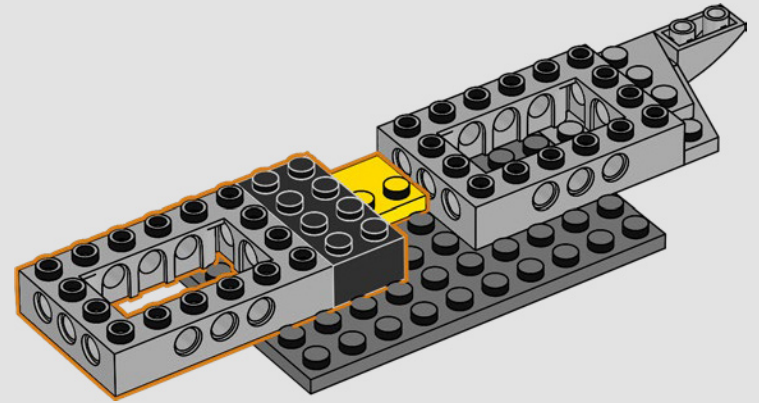

2x

221

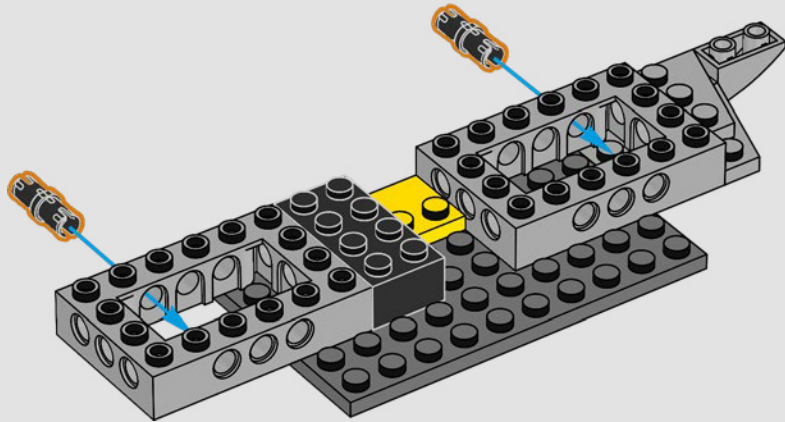

1x

222

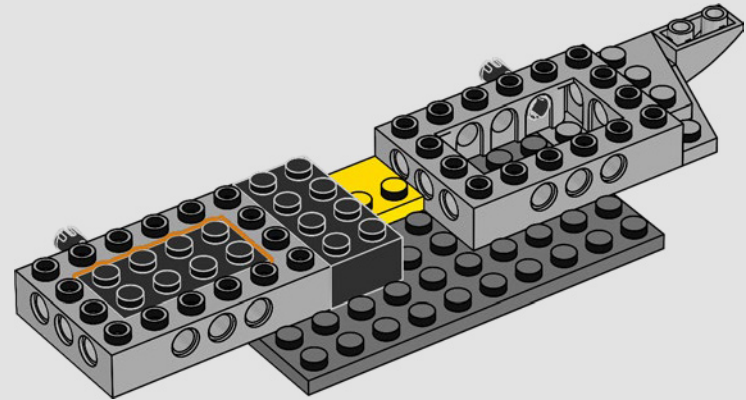

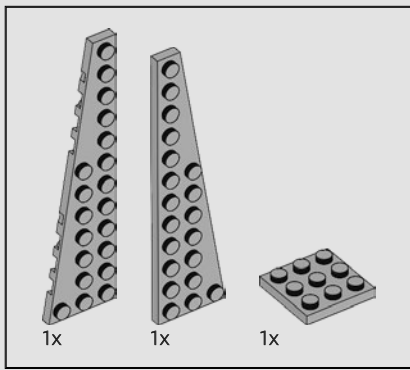

223

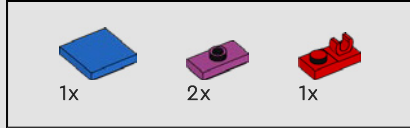
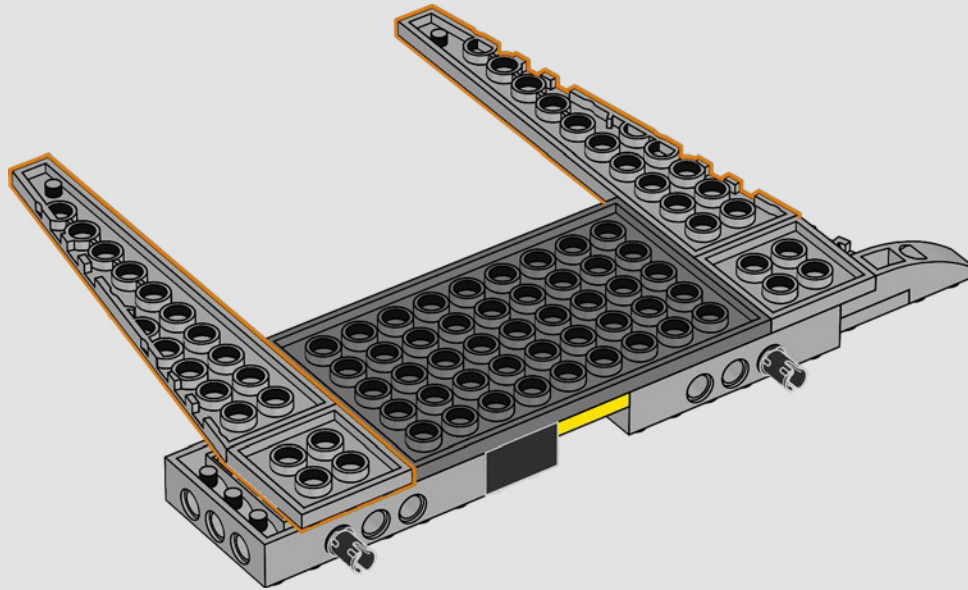

224

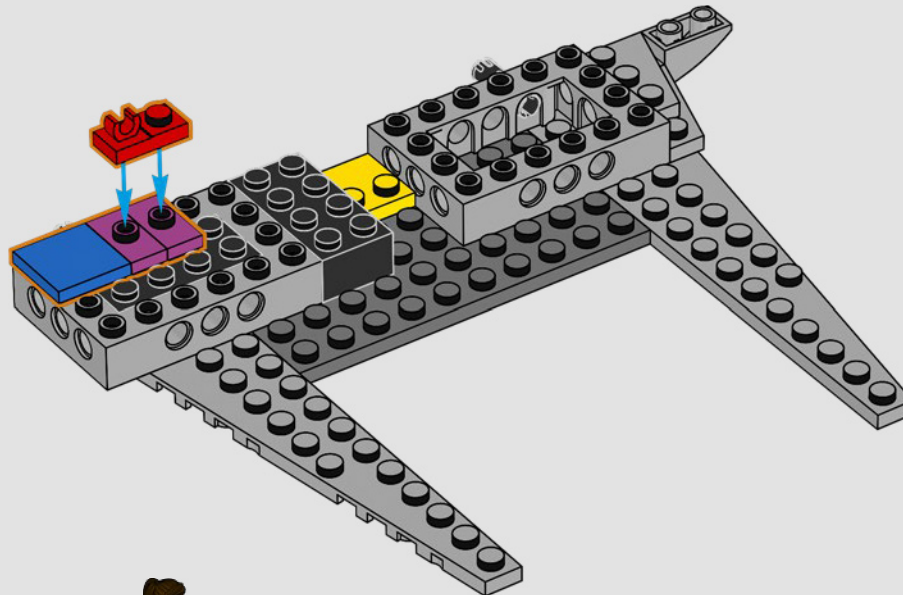
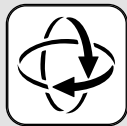



2x

225

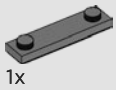
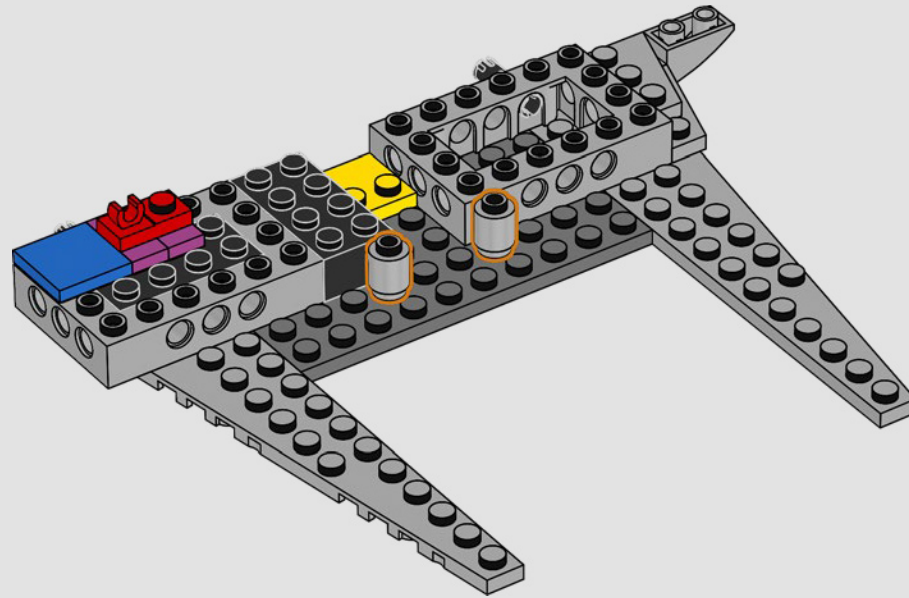

1x



2x

226

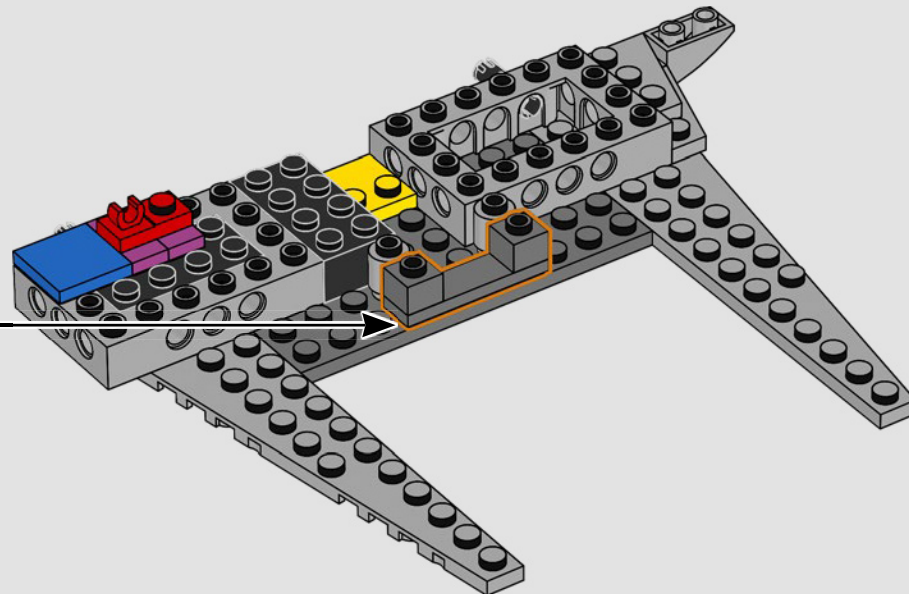
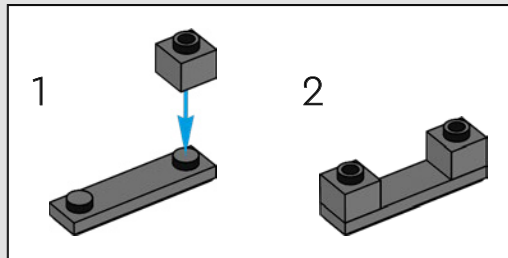

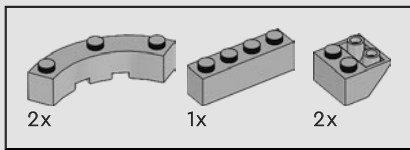

227

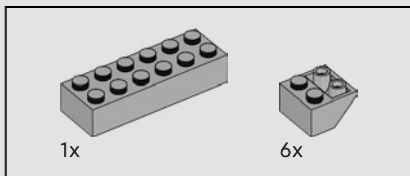
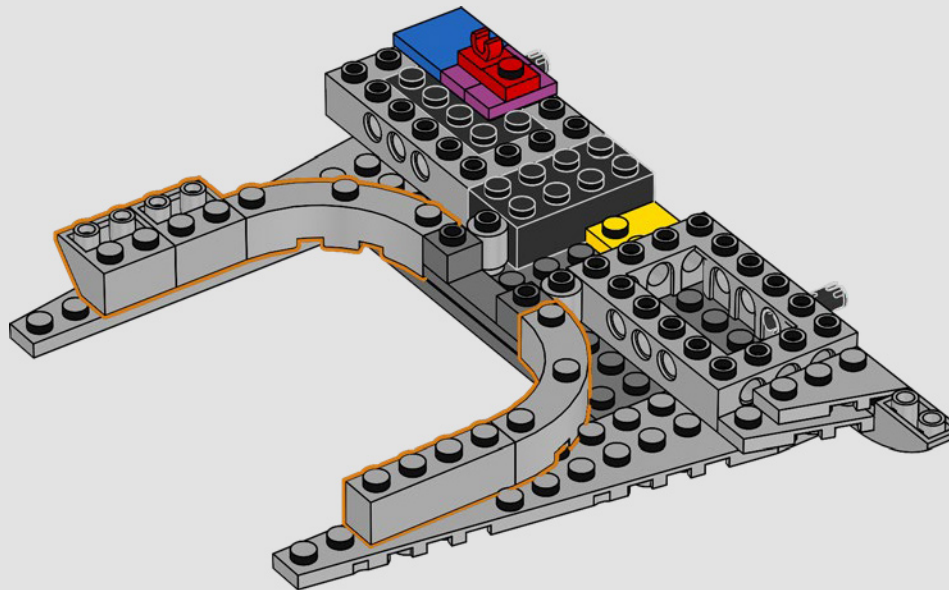

228

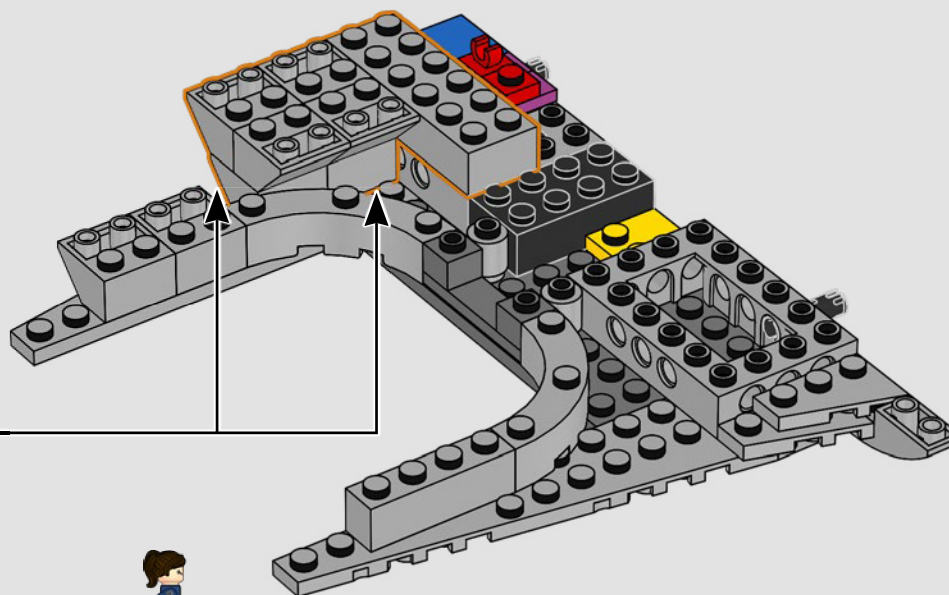
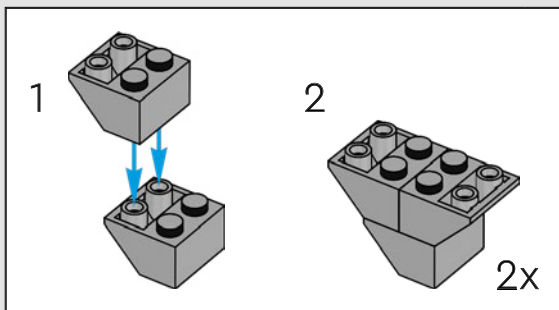

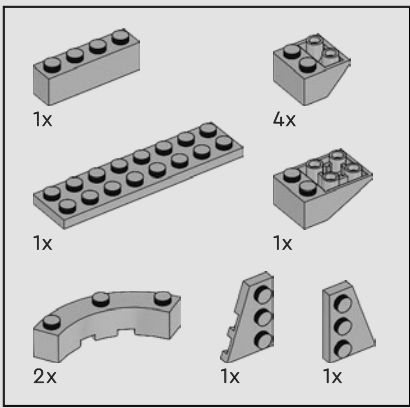

229

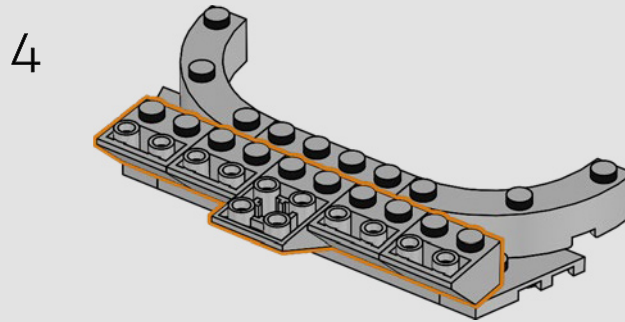
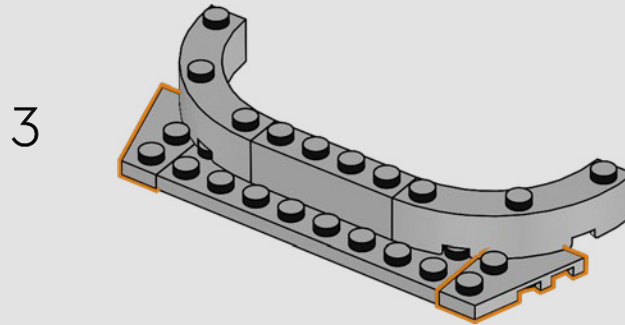
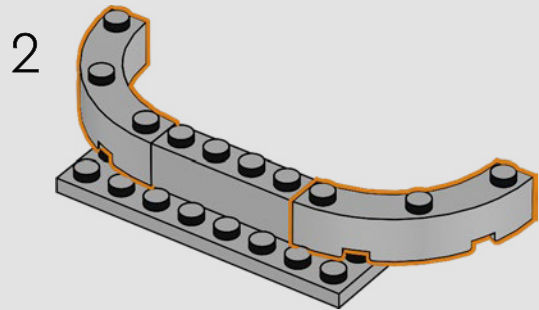
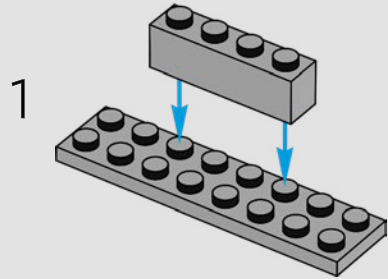

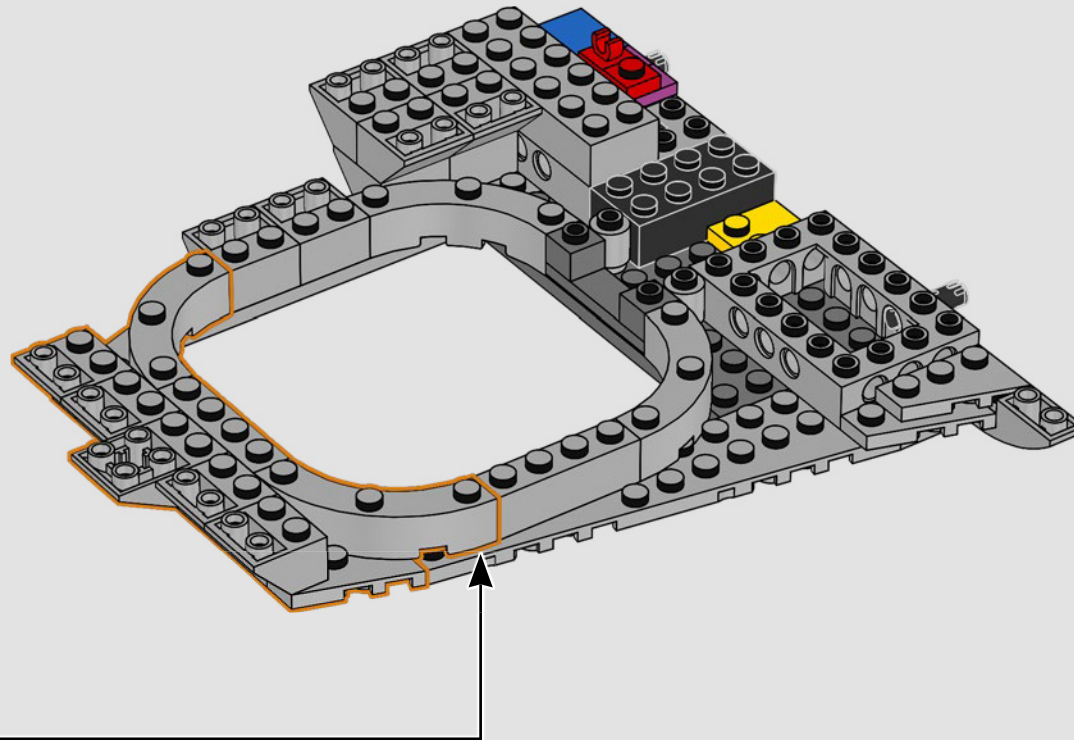

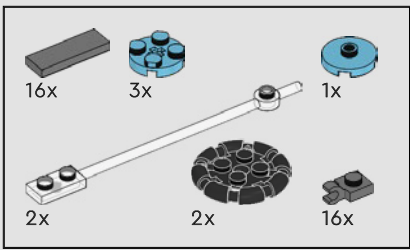

230

1

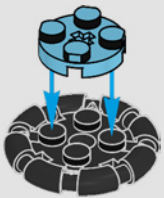

2



3

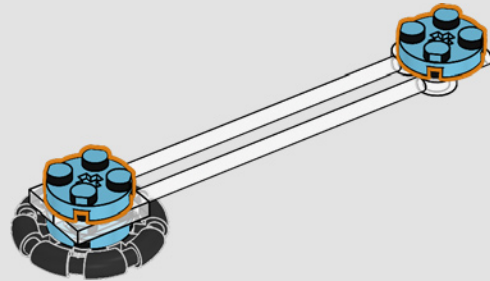

4

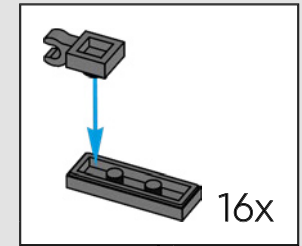
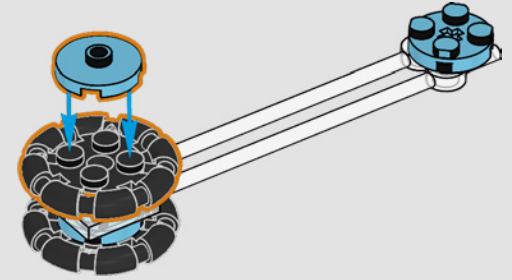

5

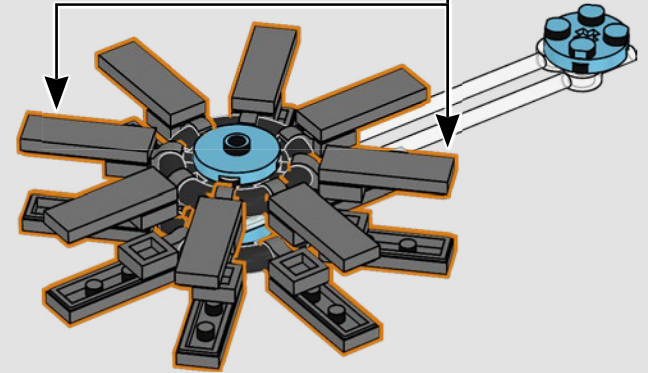

6

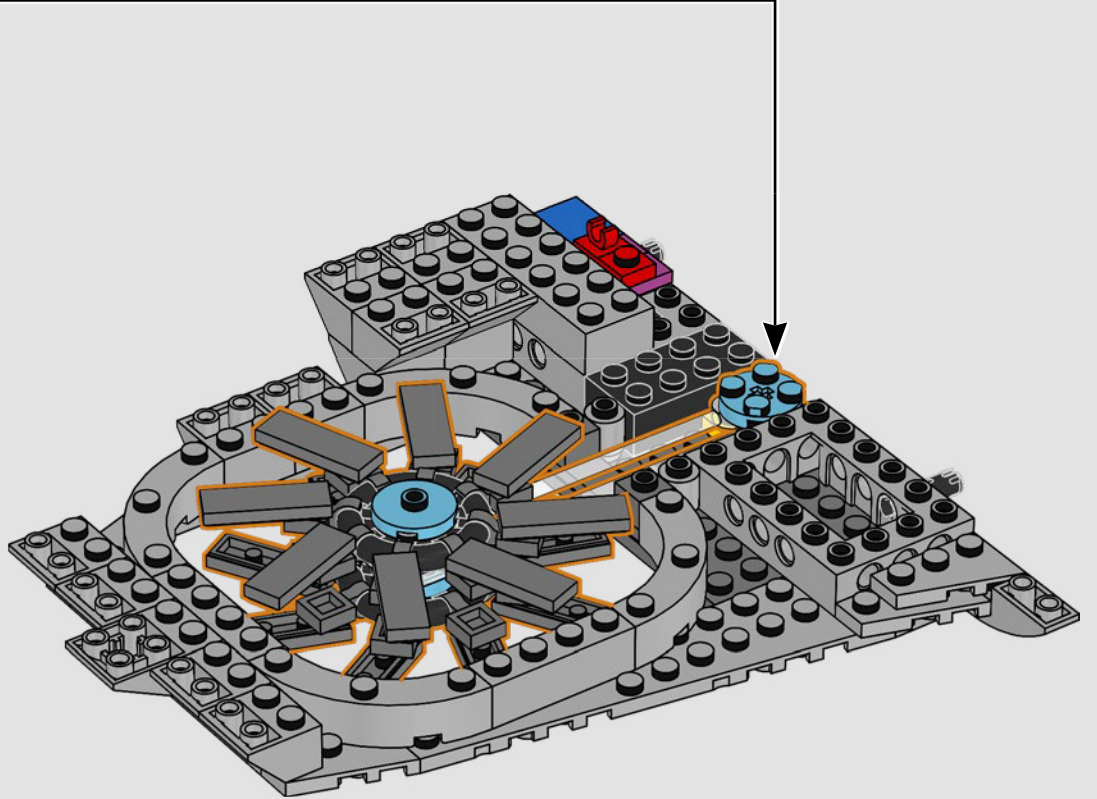
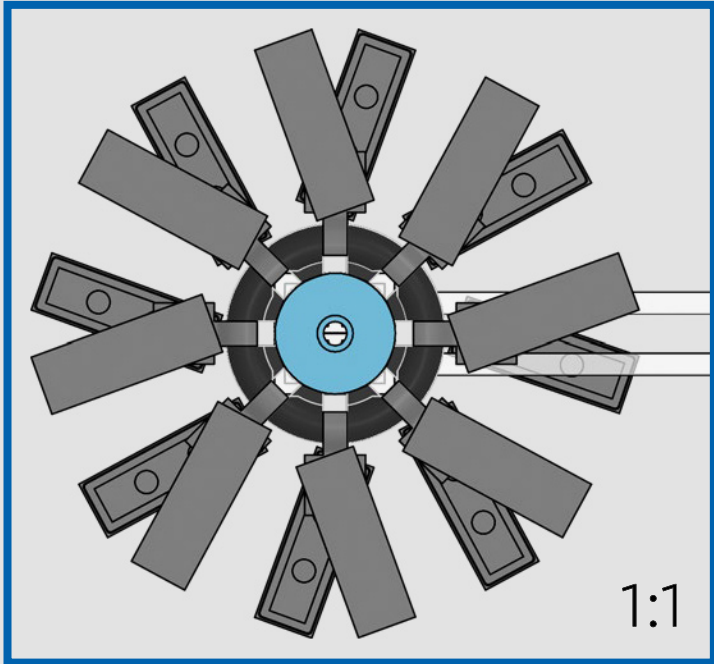
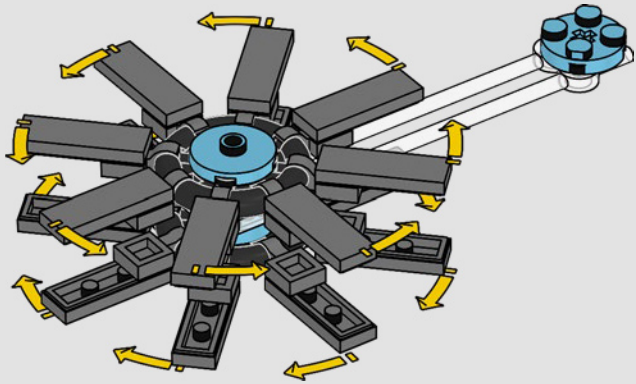



4x

231

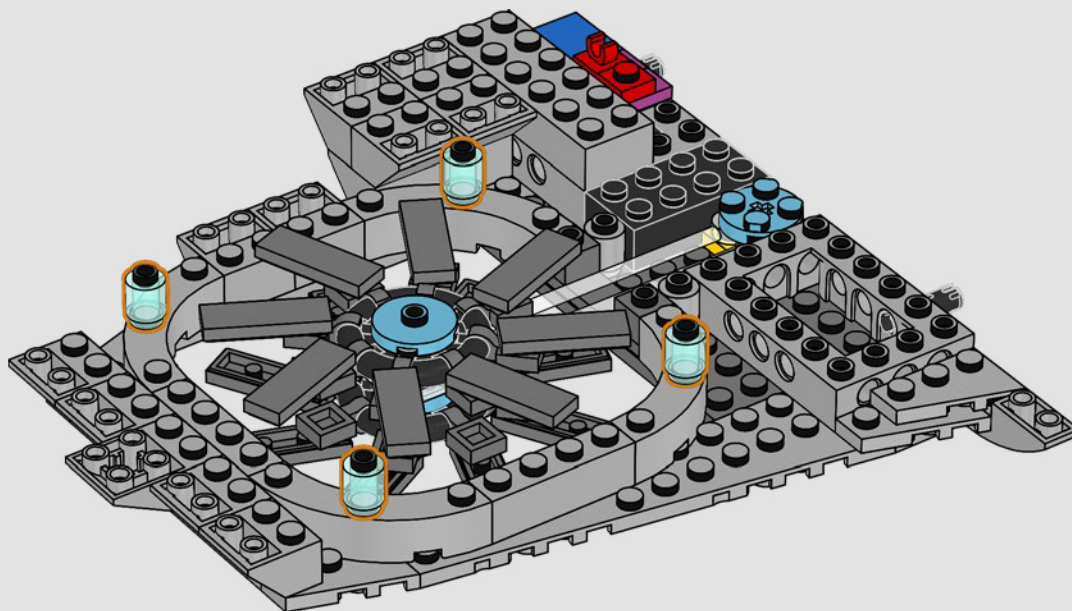

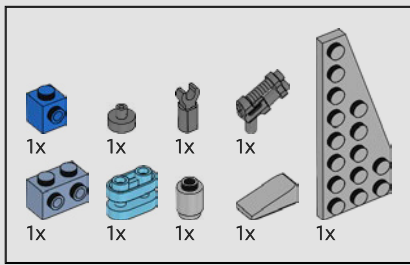

232

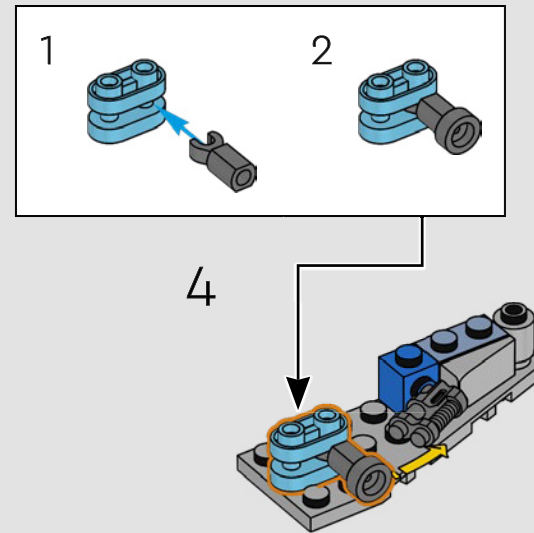
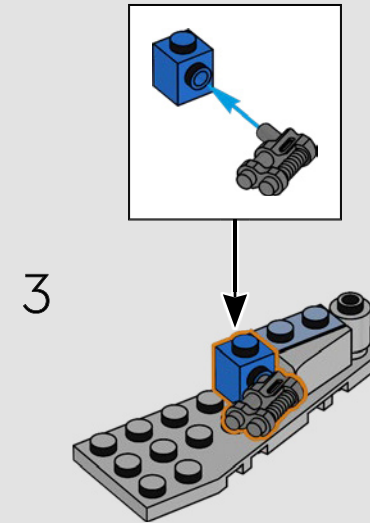
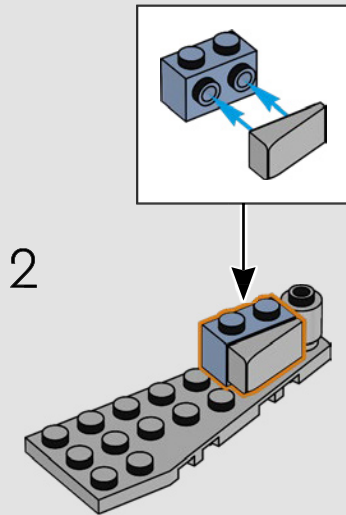
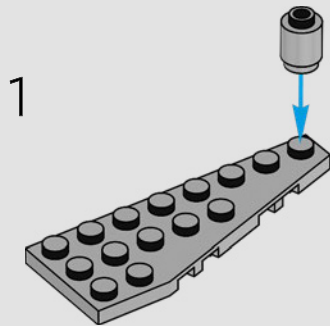

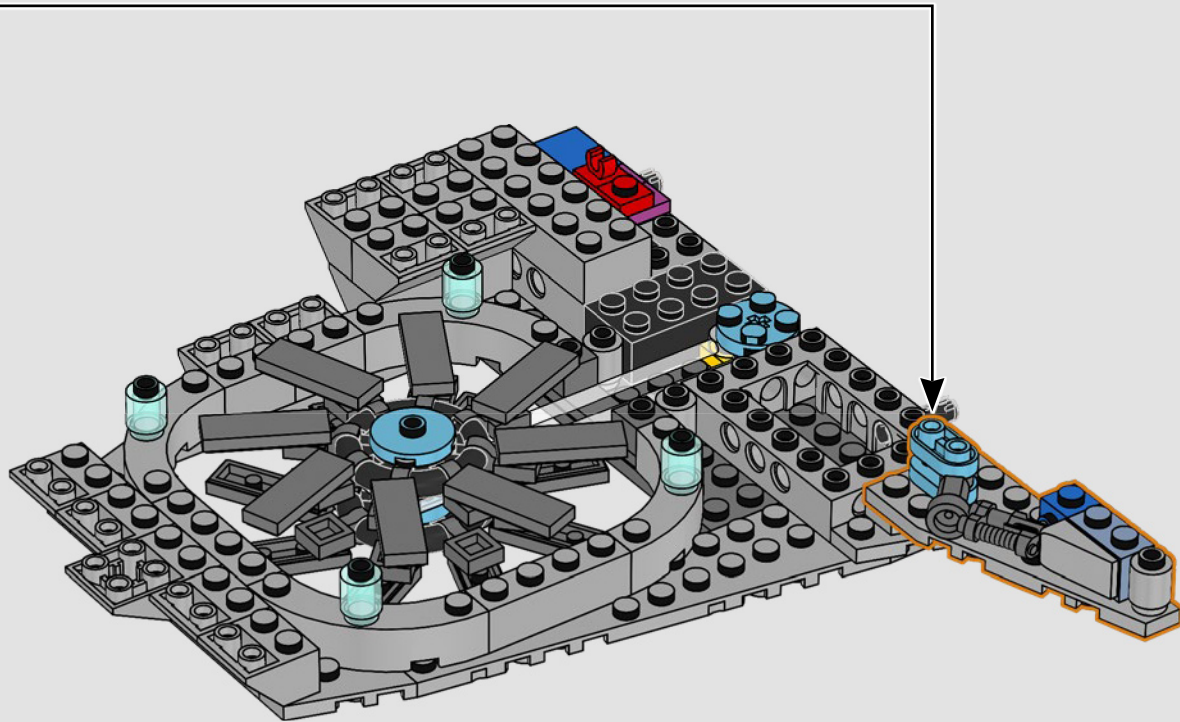

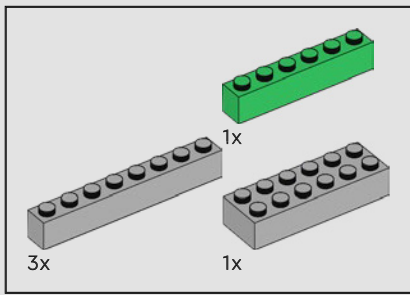

233

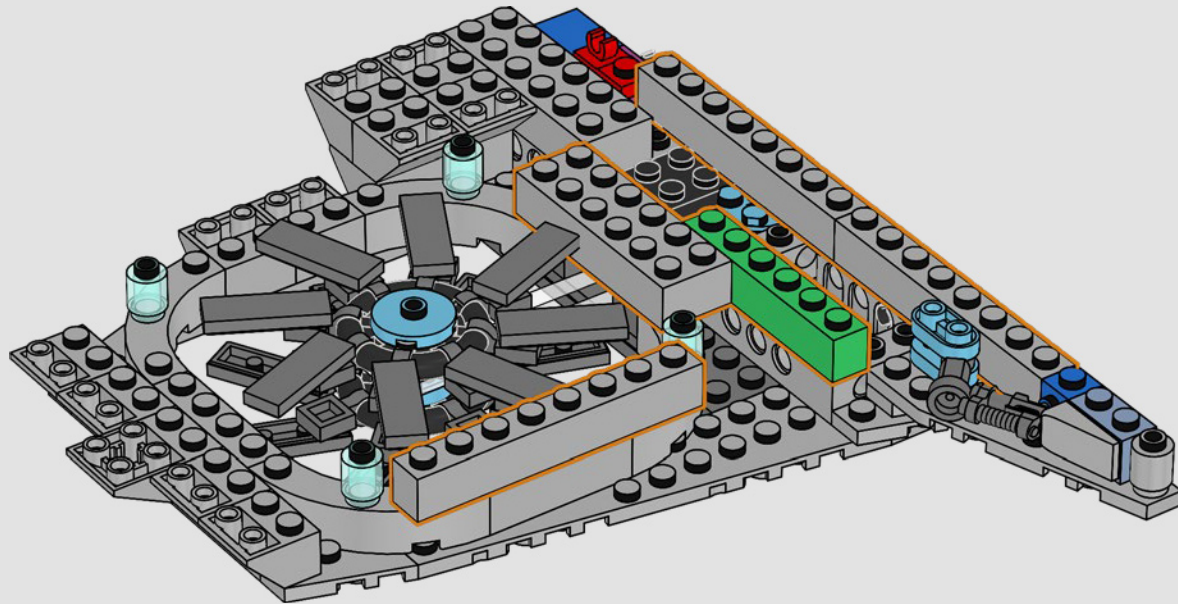

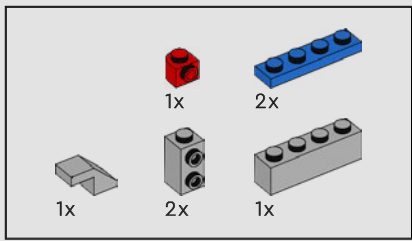

234

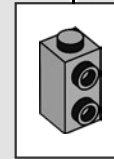
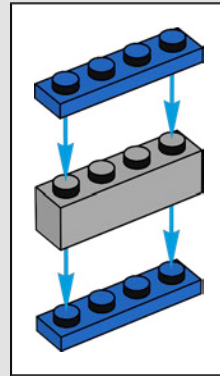
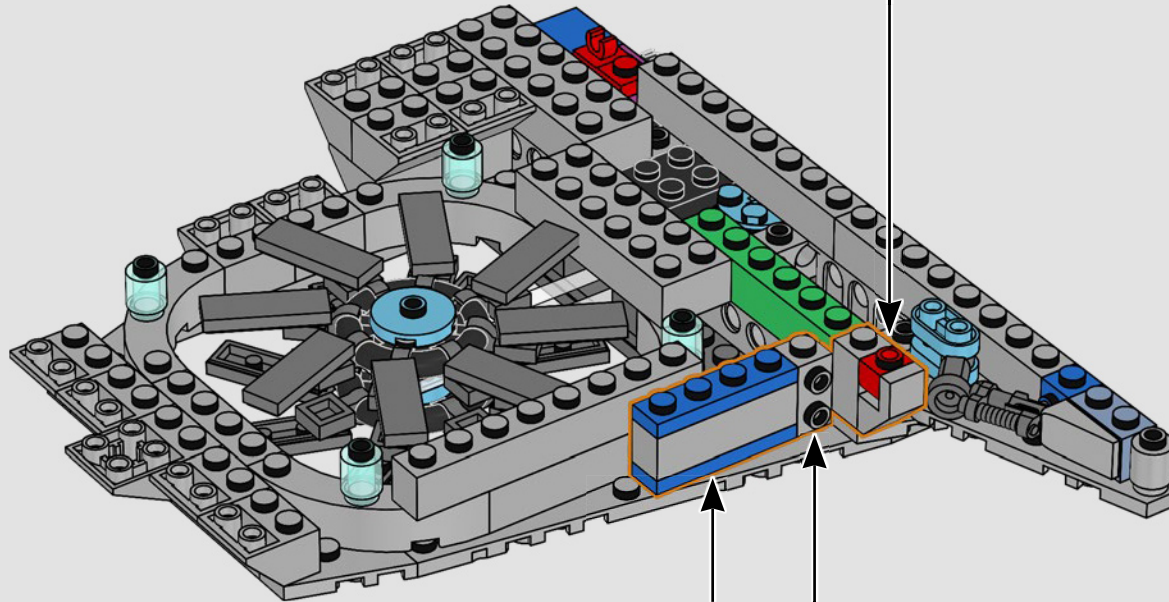
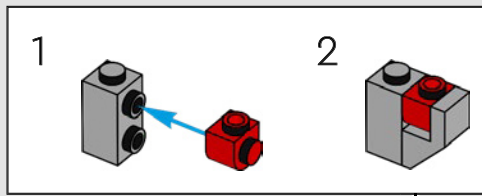

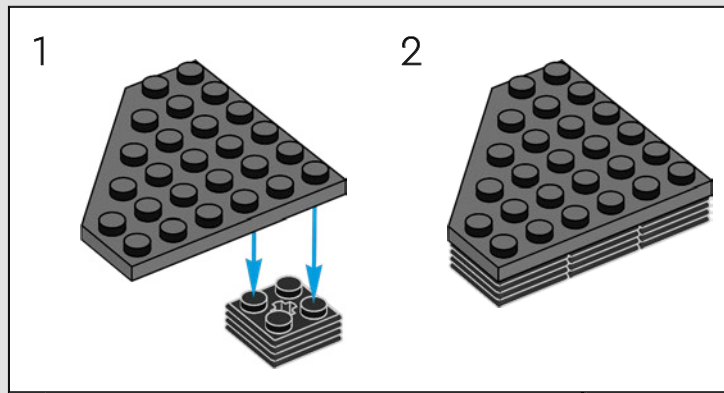
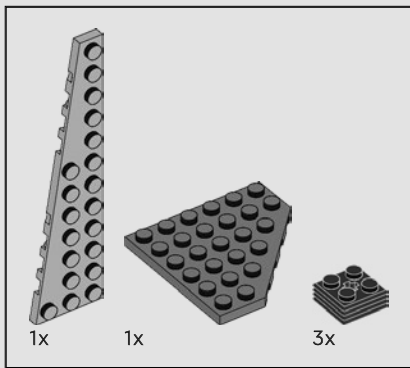

235

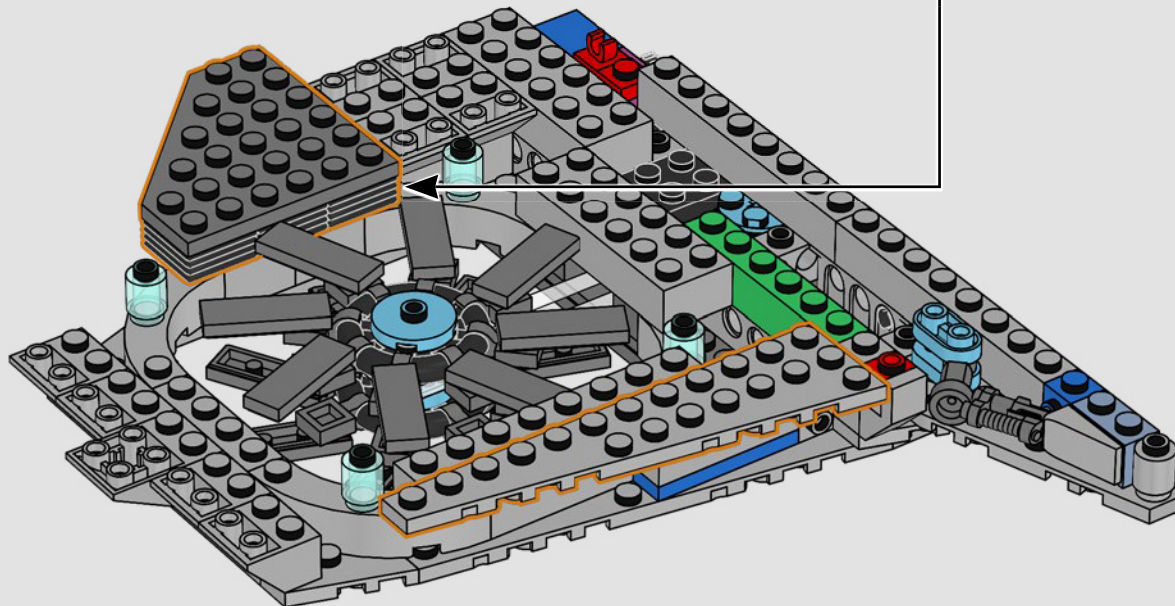

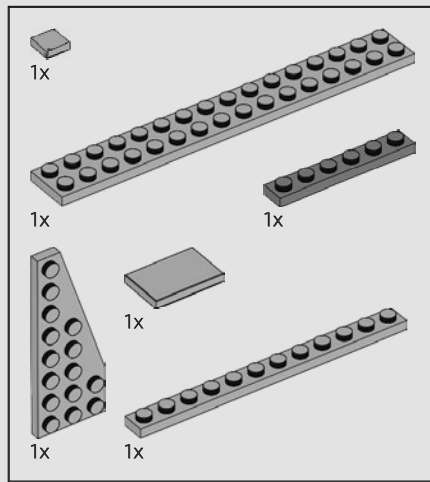

236

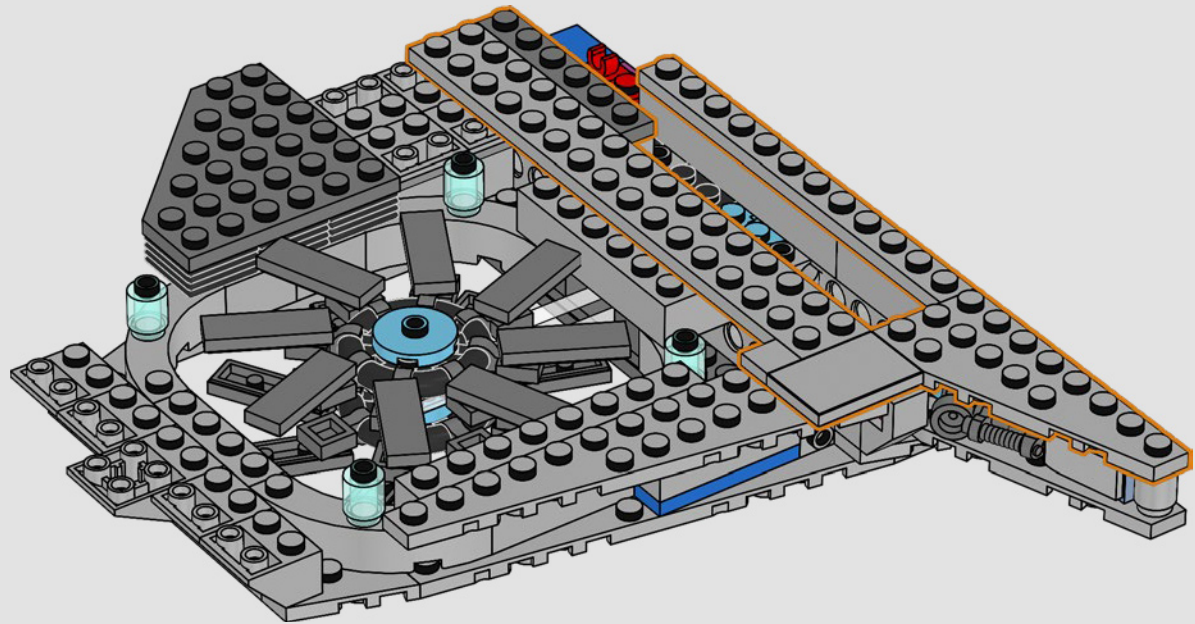

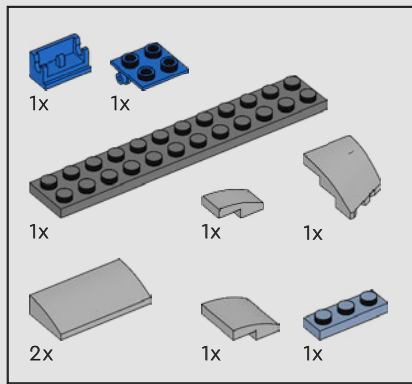

237

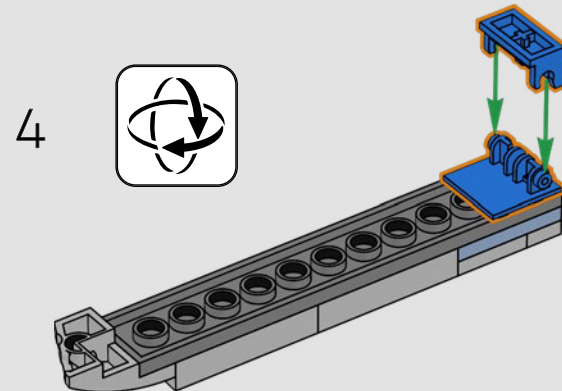
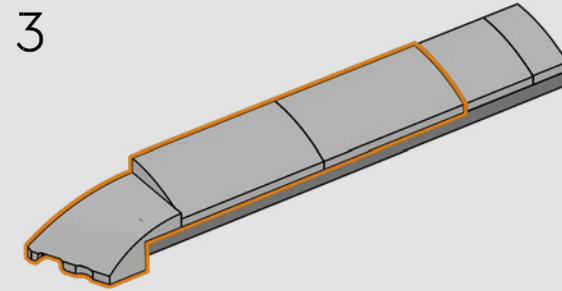
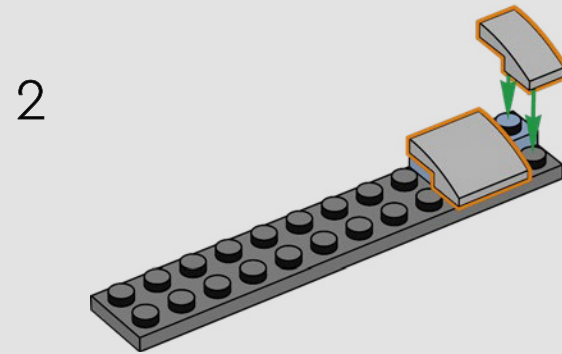
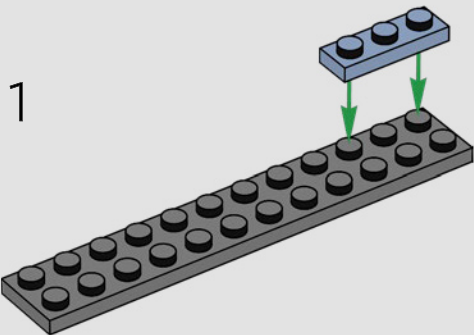

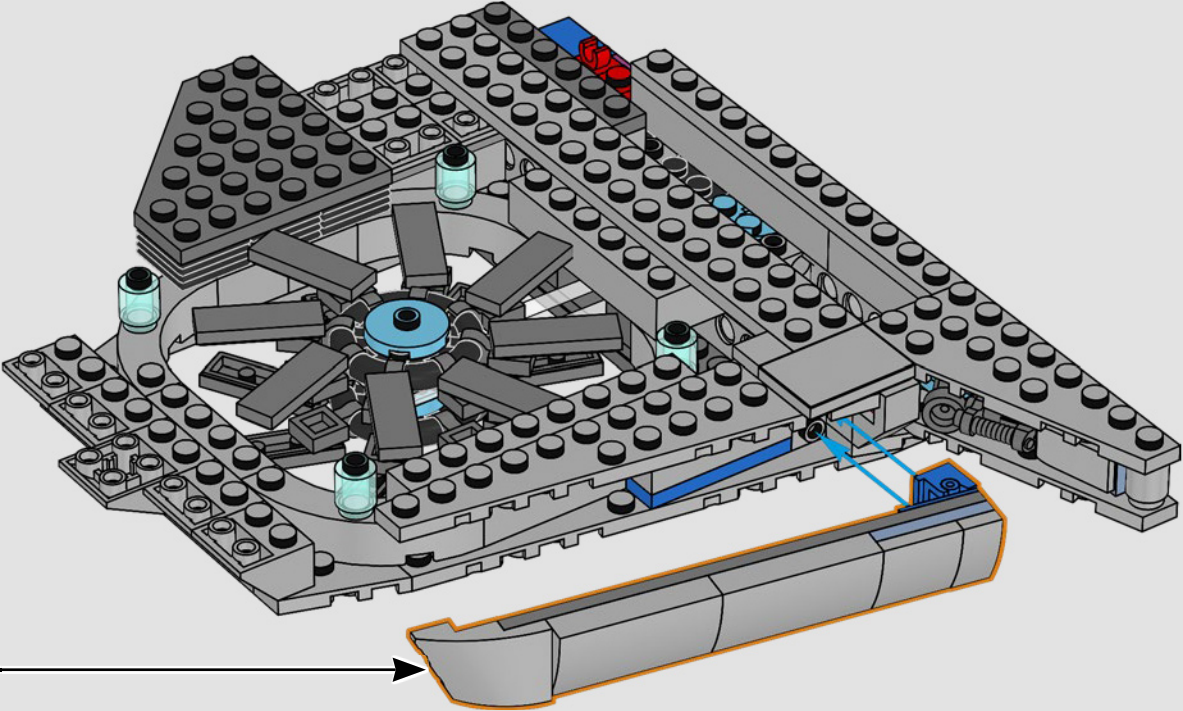

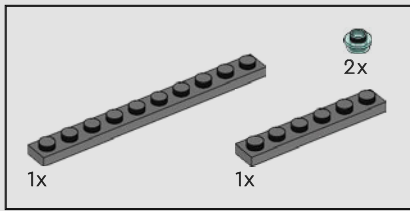

238

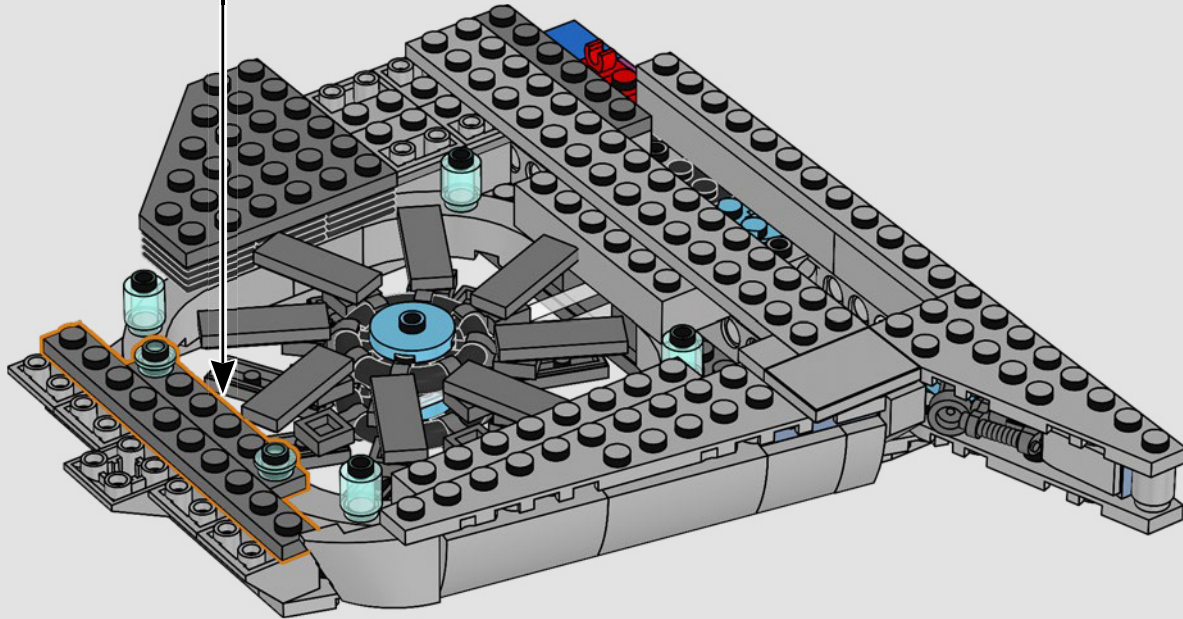
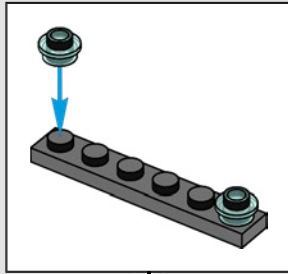

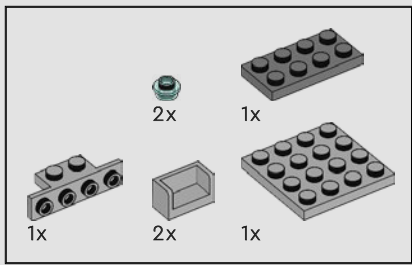

239

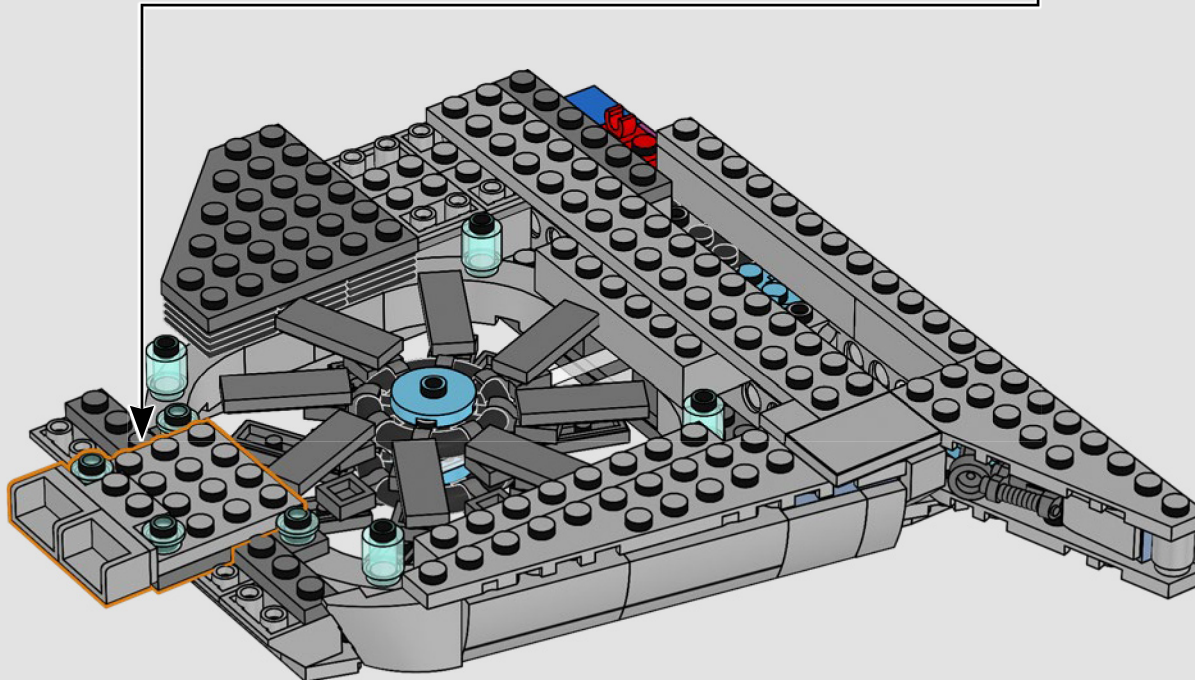
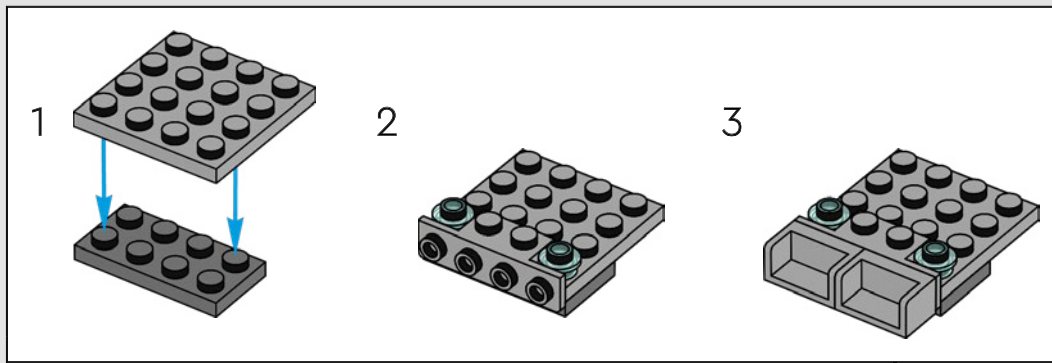

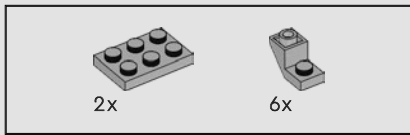

240

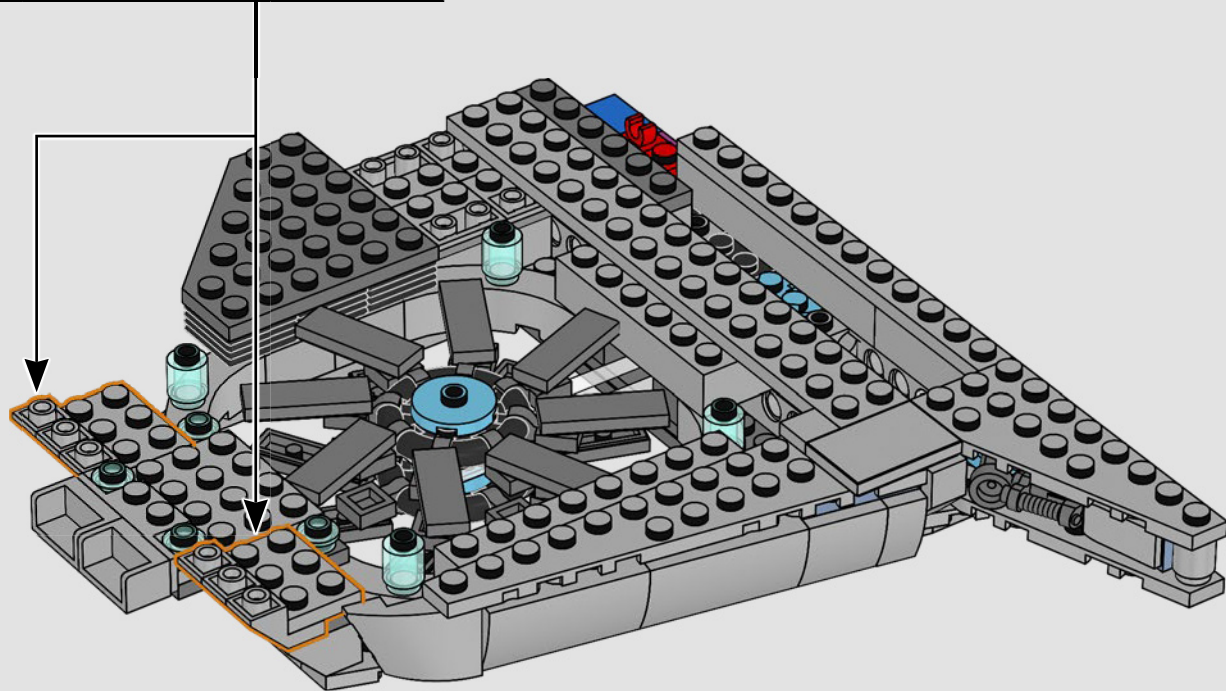
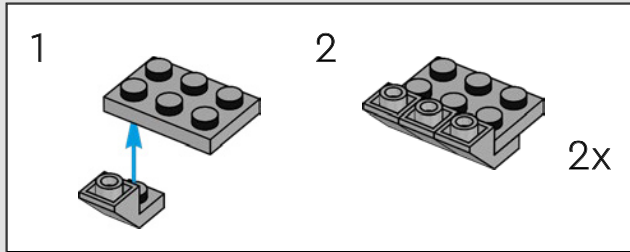

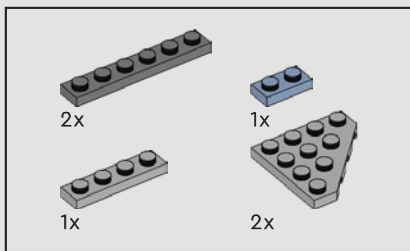

241

1

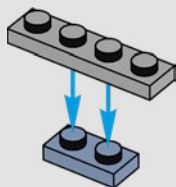

2

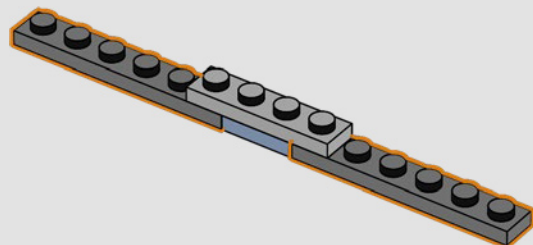

3

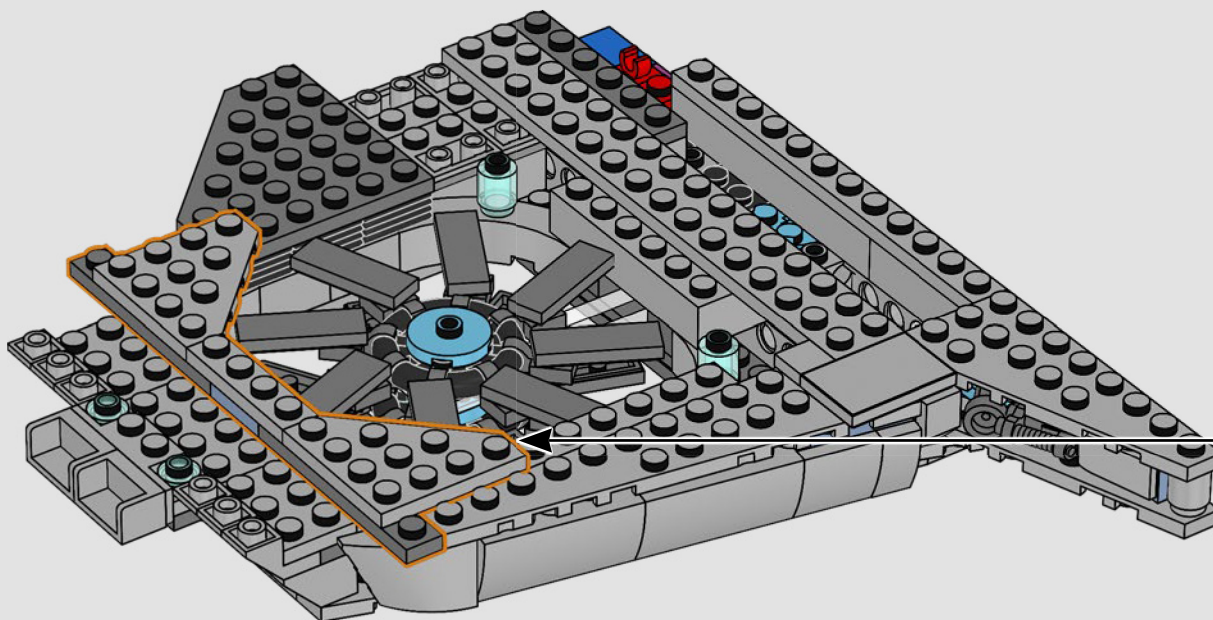
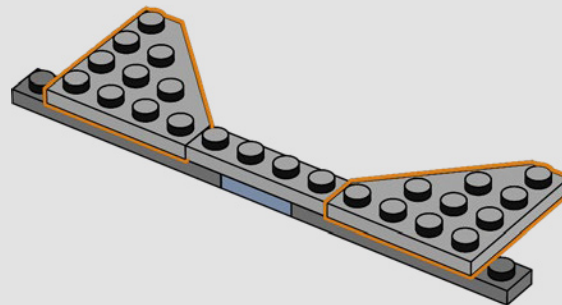

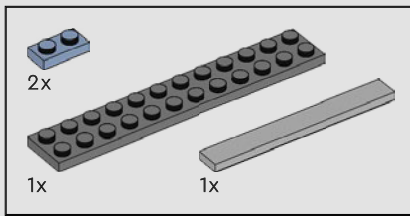

242

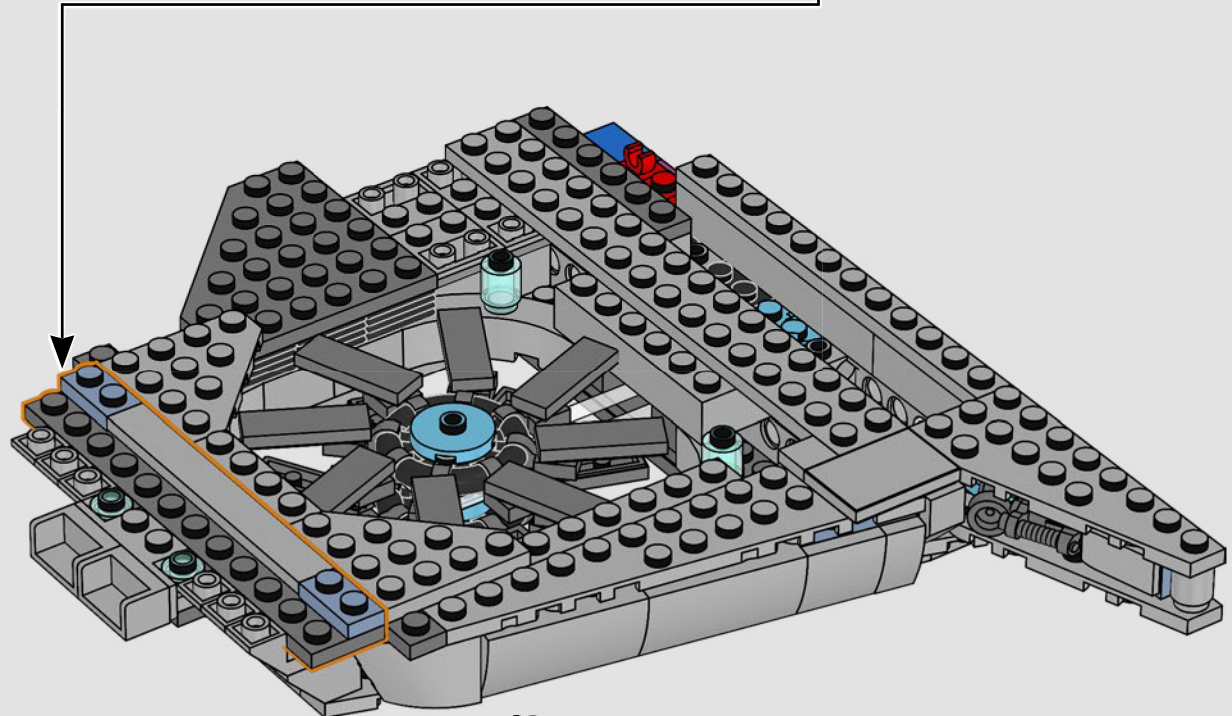
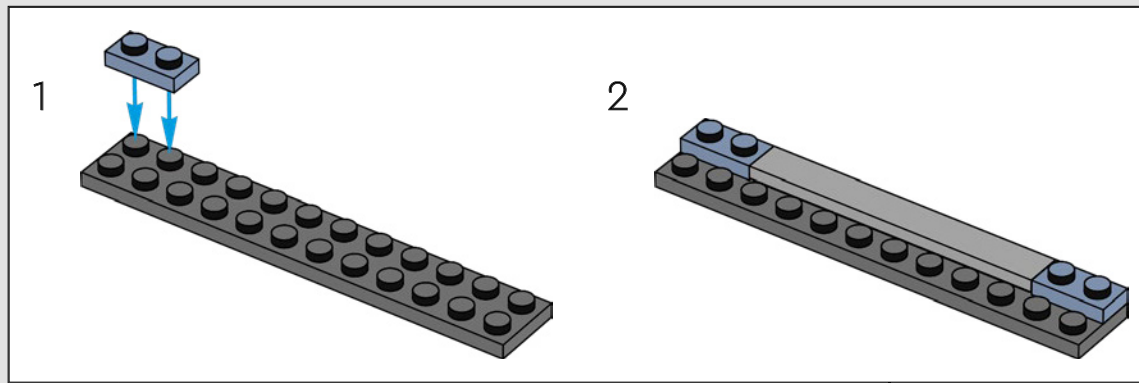

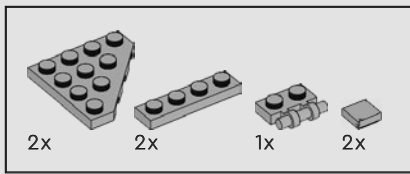

243

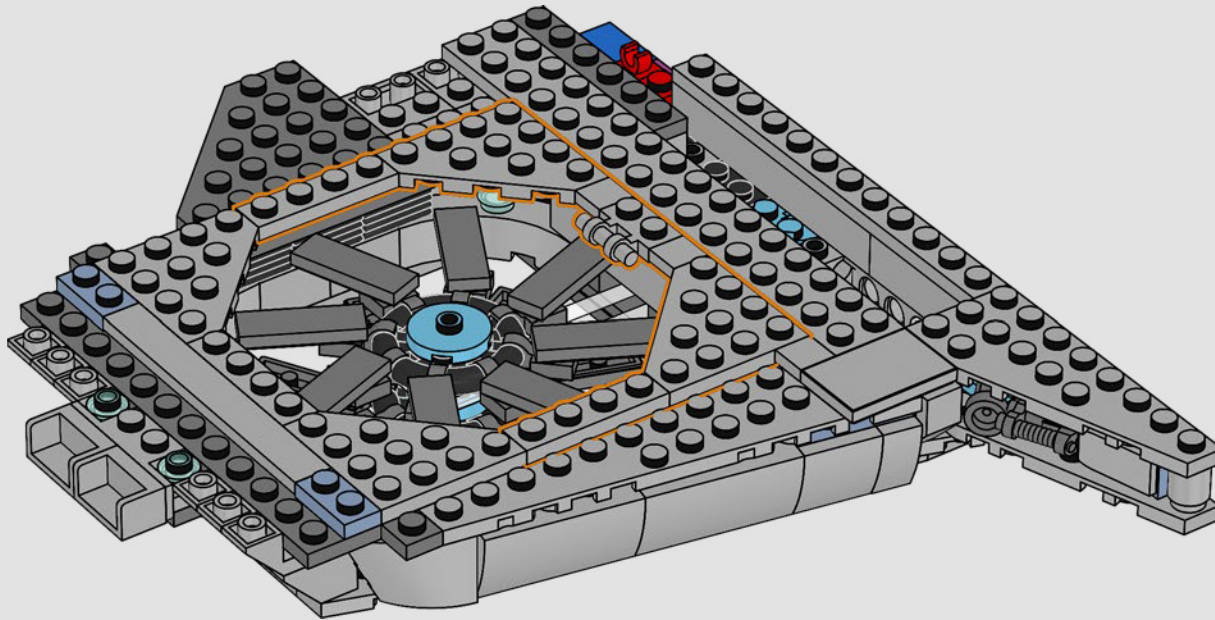

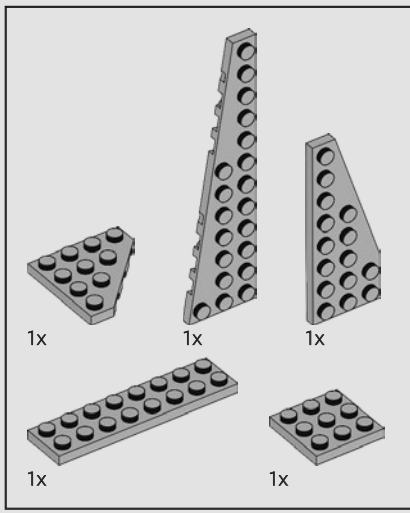

244

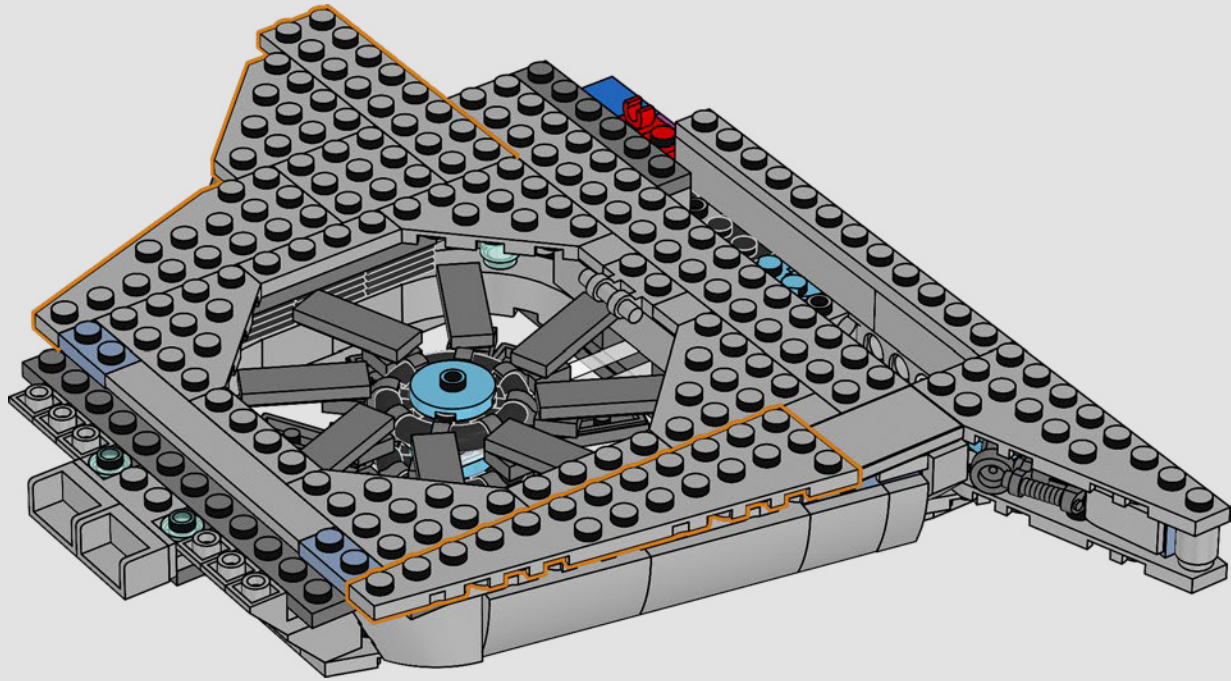

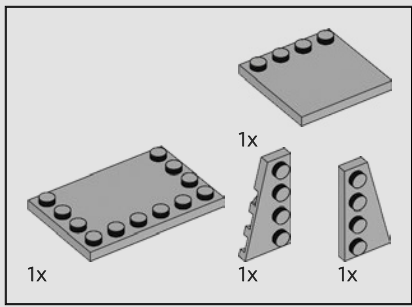

245

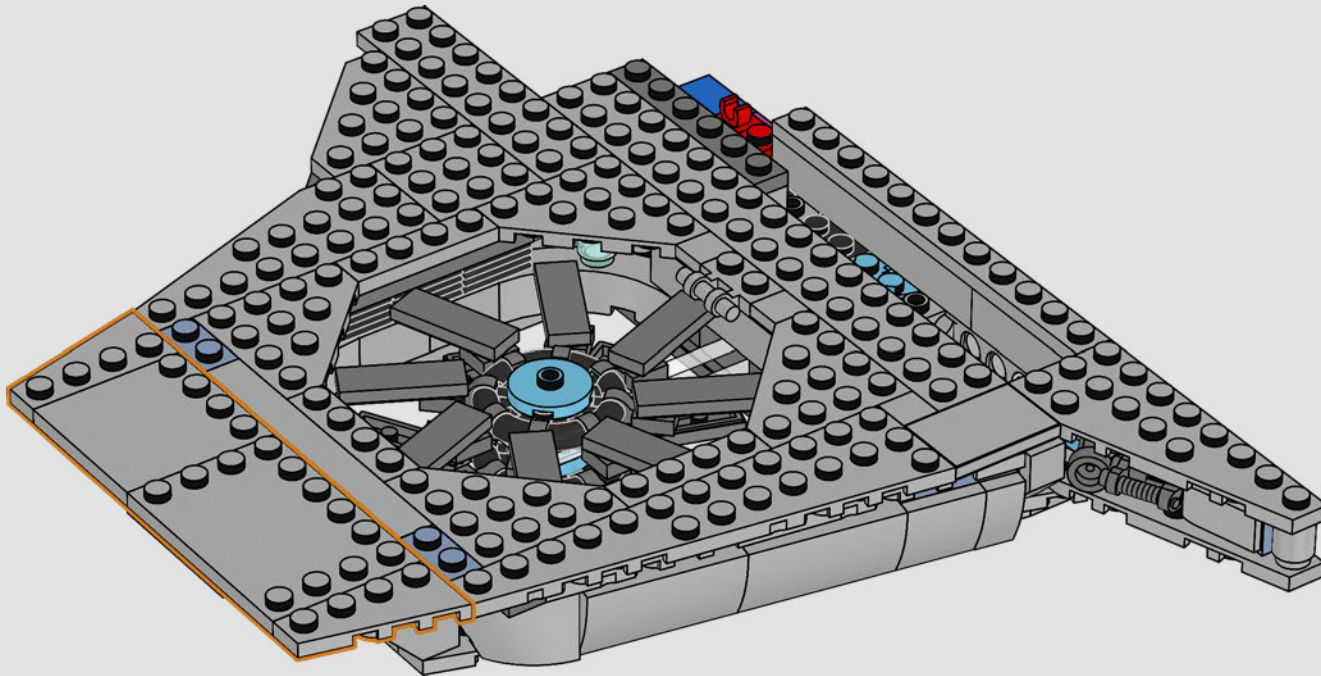

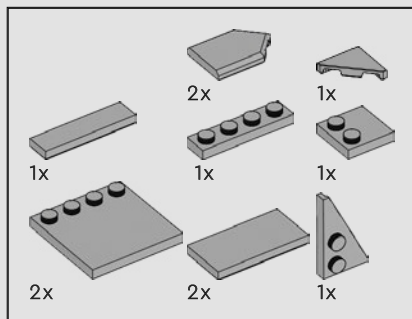

246

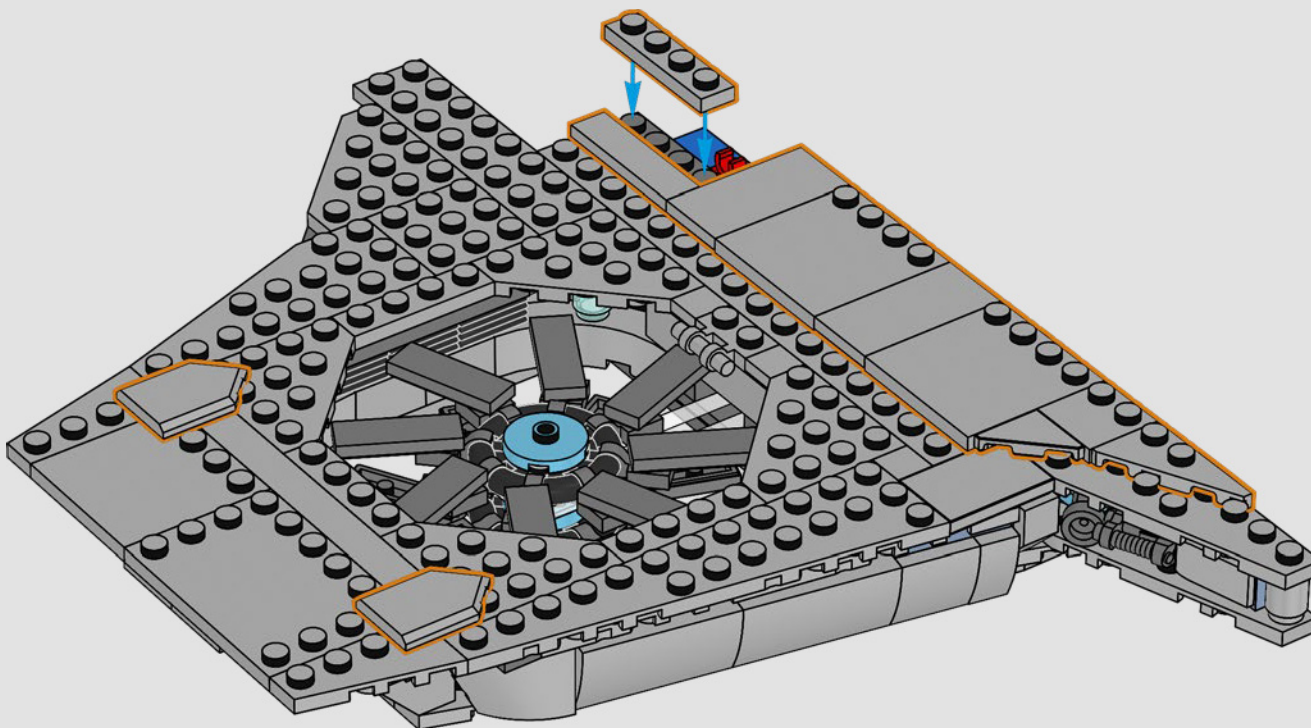

247

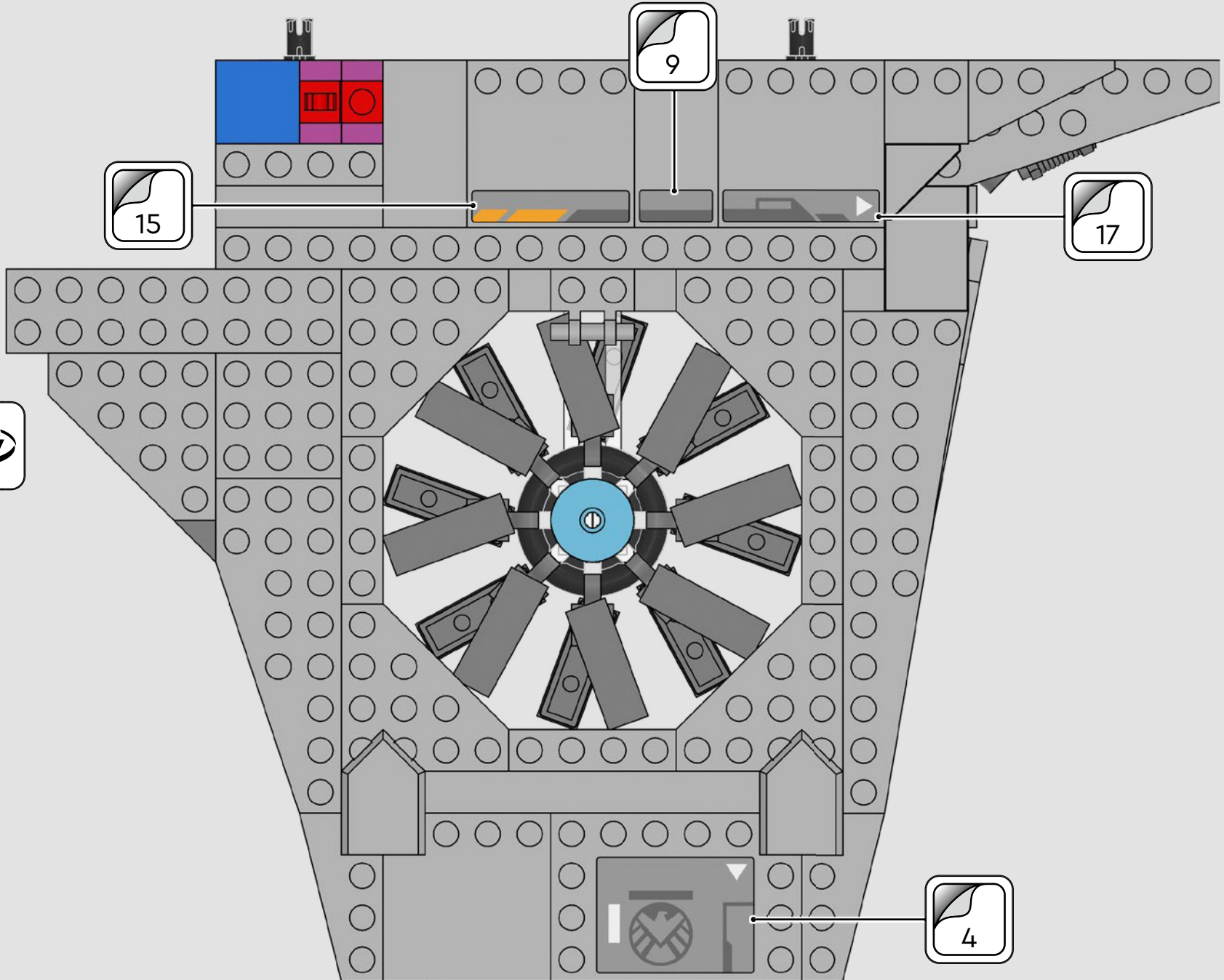
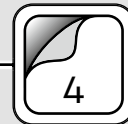
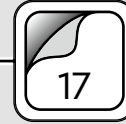

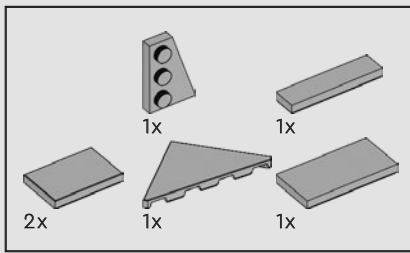

248

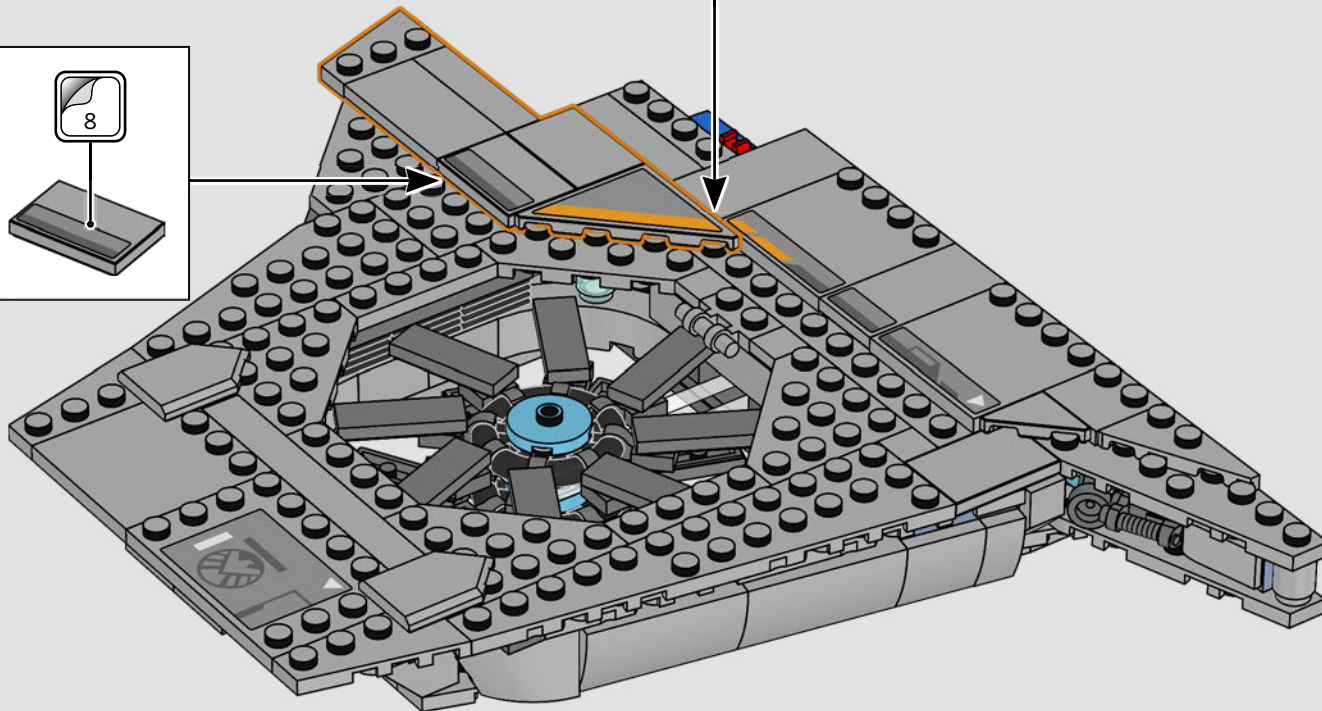
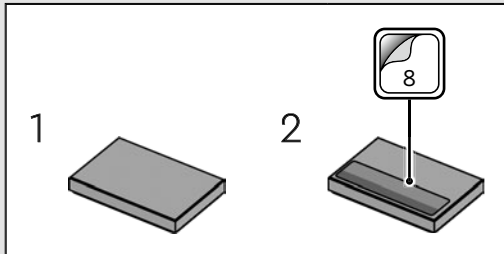
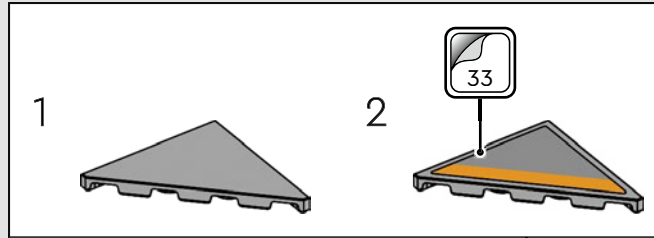

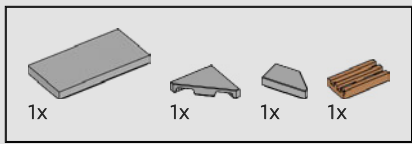

249

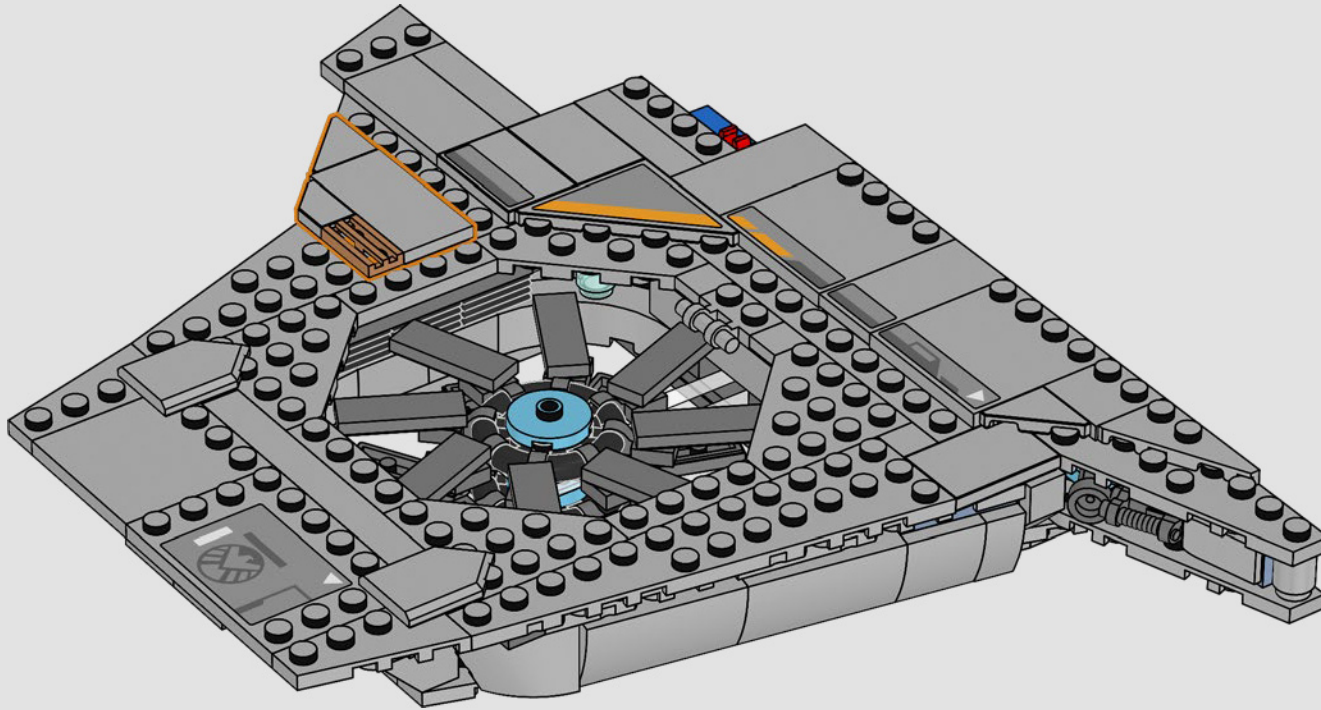

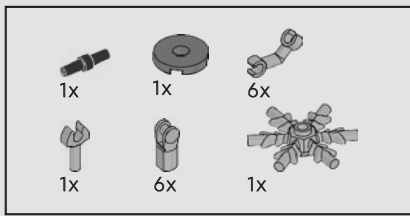

250

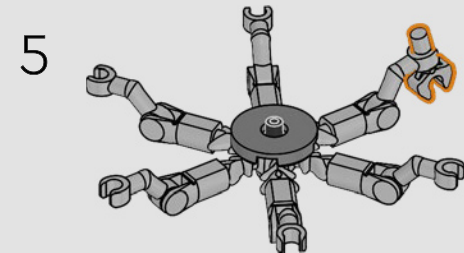
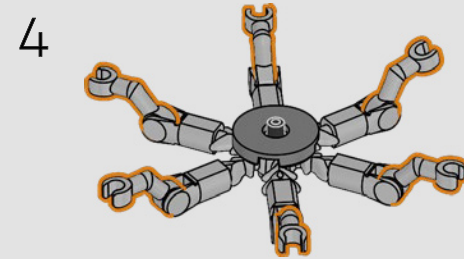
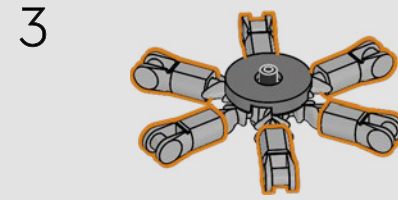
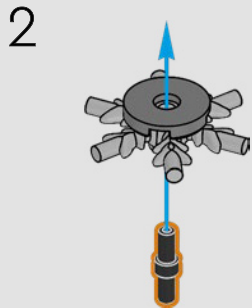
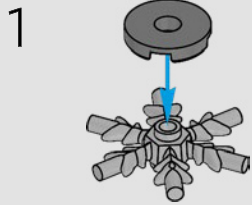

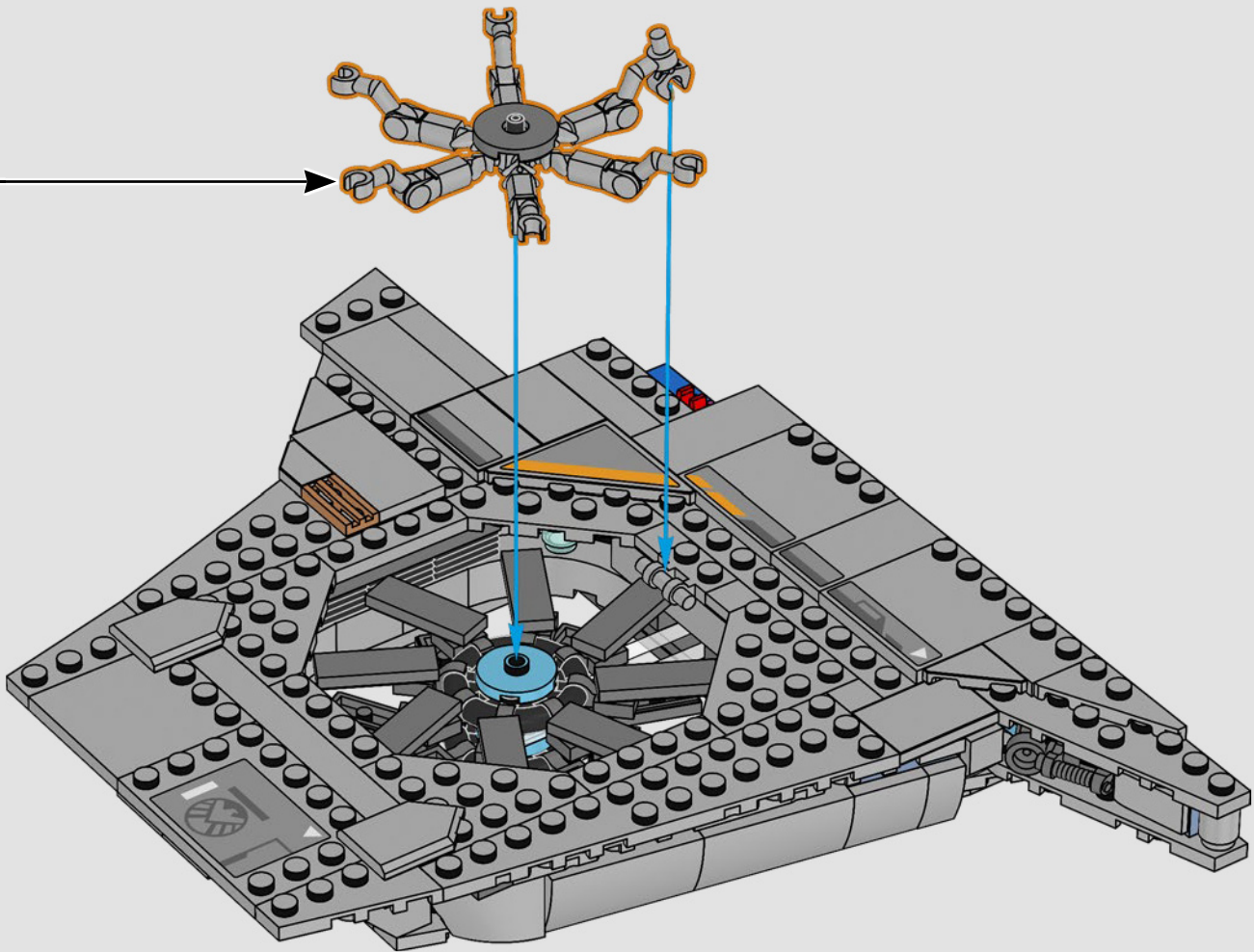

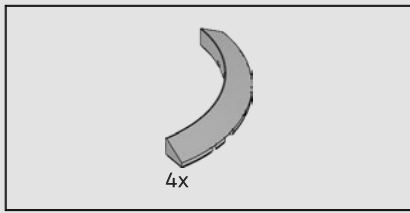

251

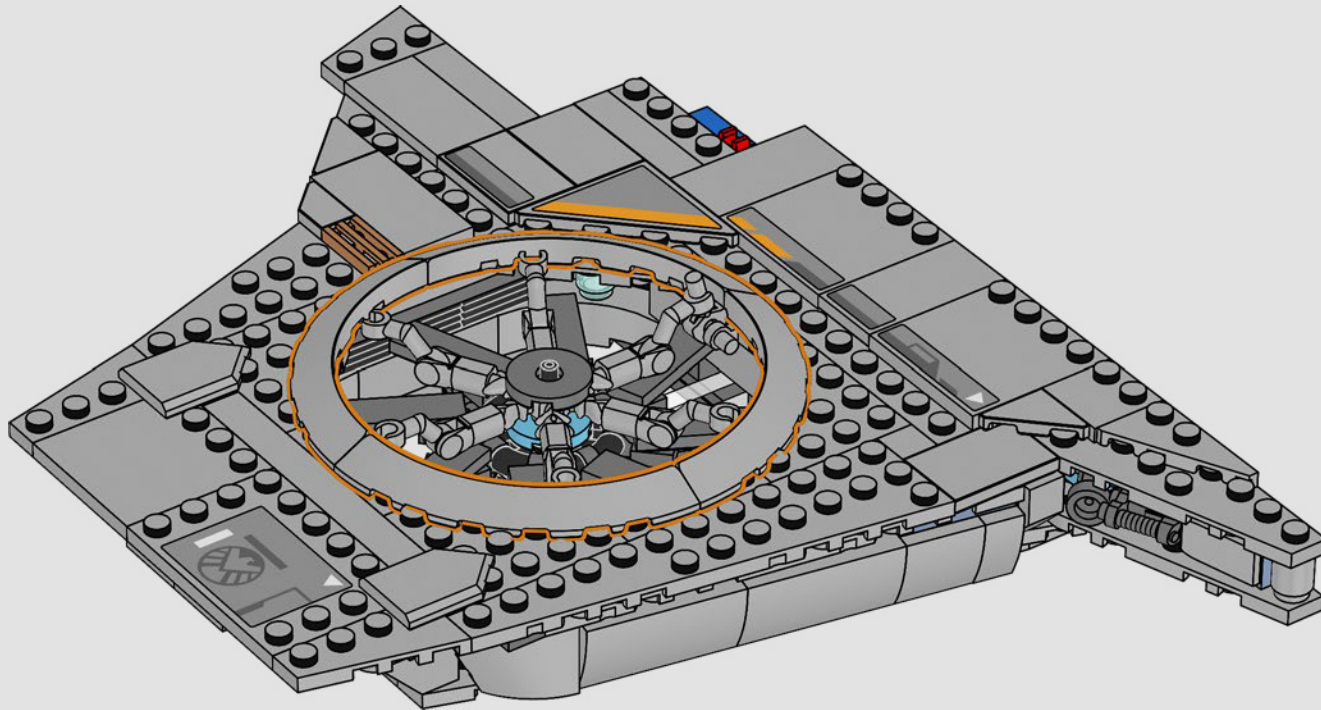

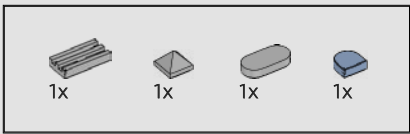

252

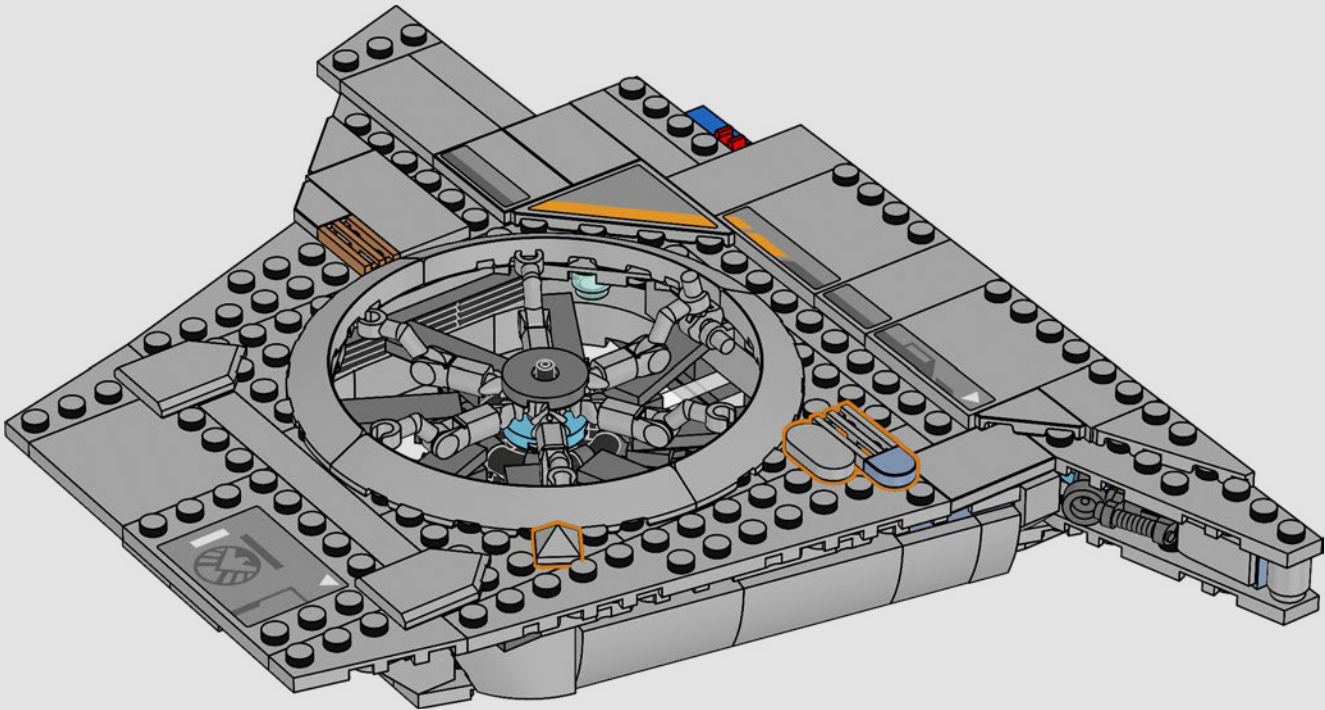

253

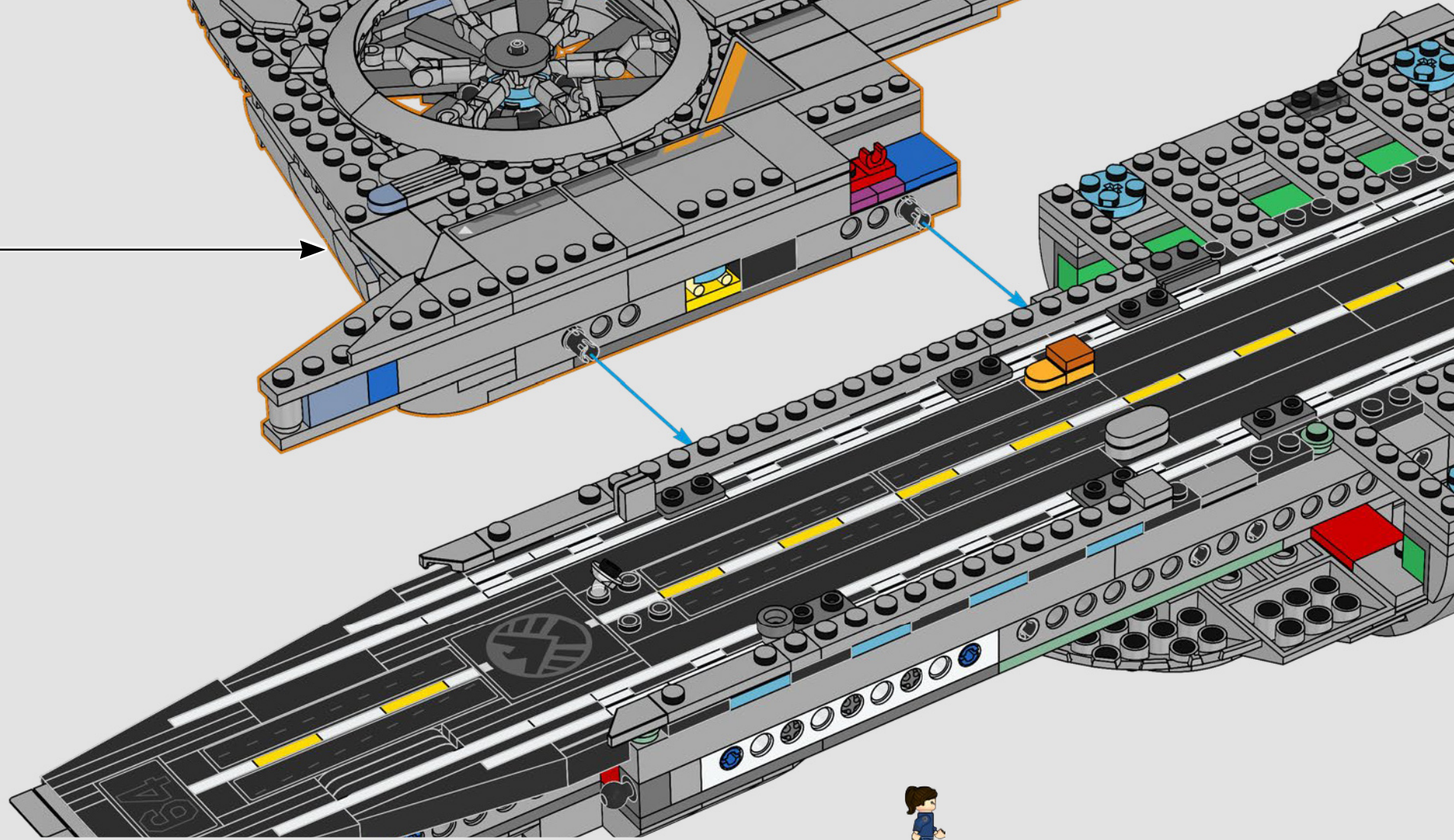
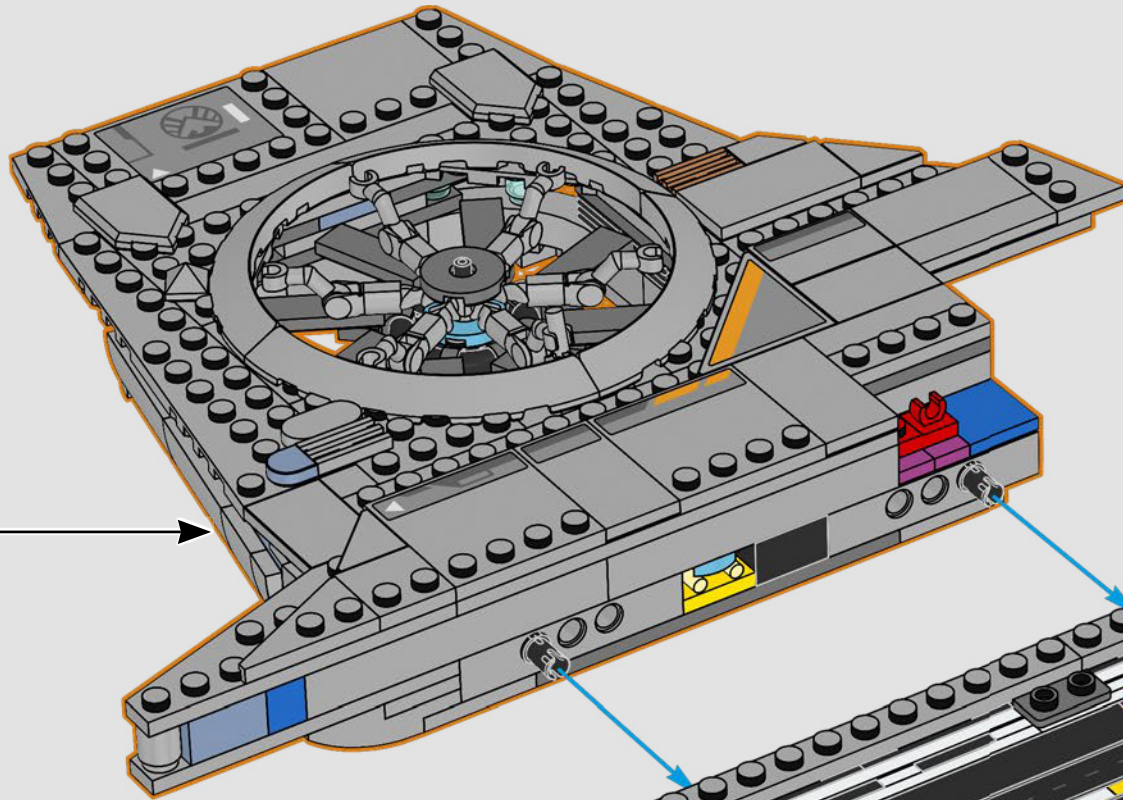

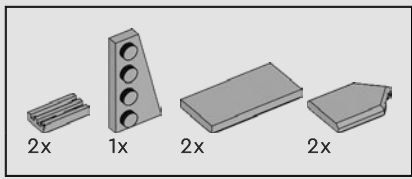

254

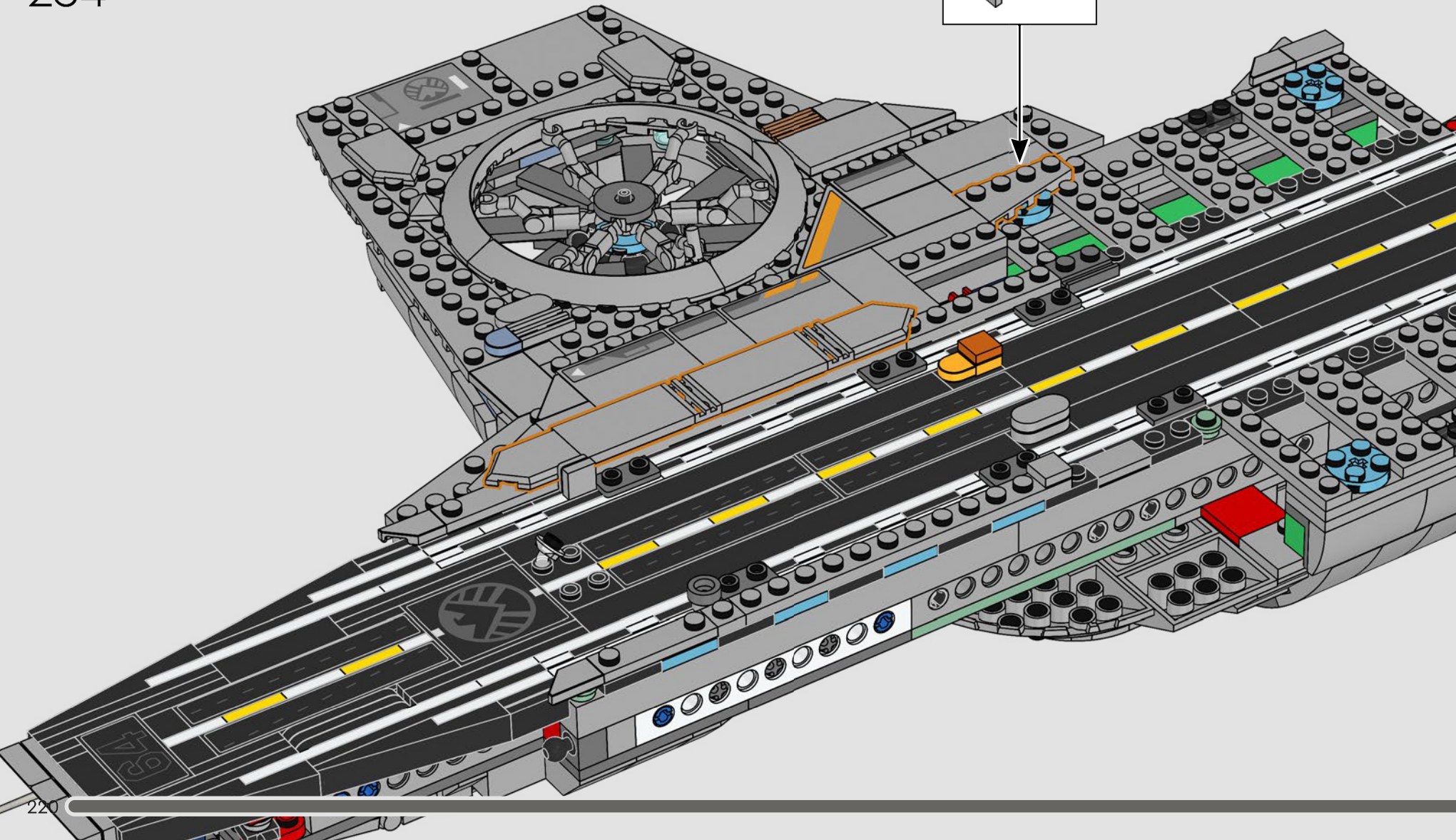
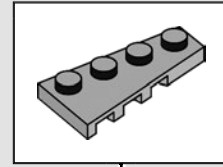



255

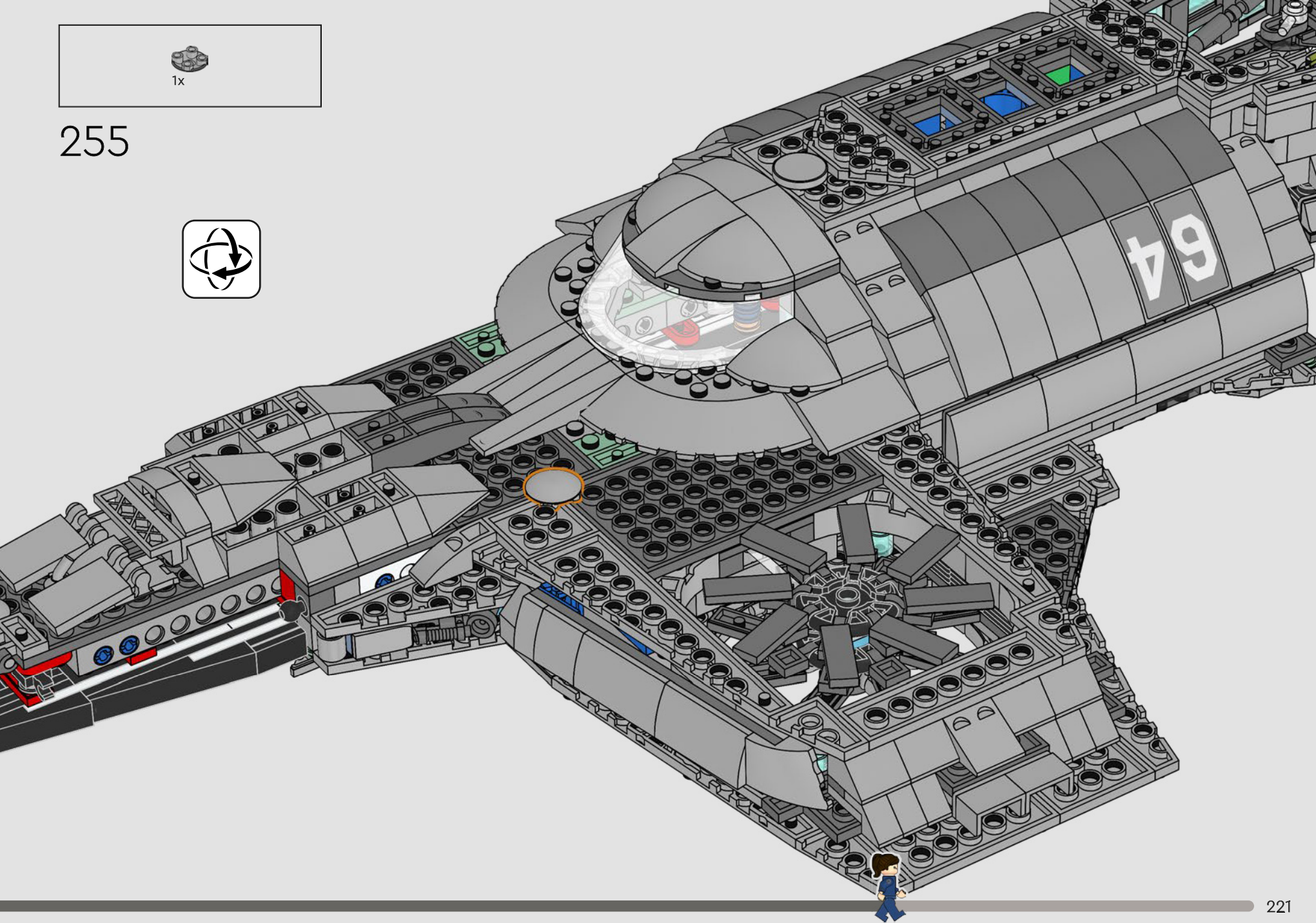

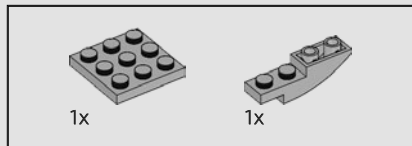
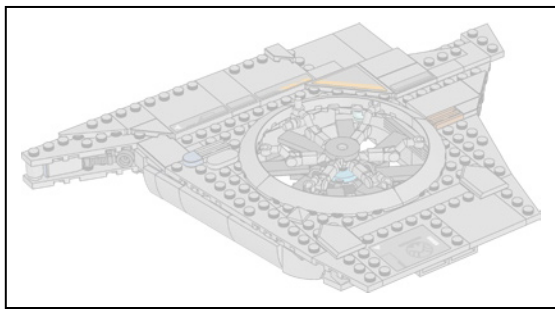

256

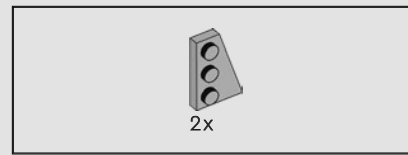
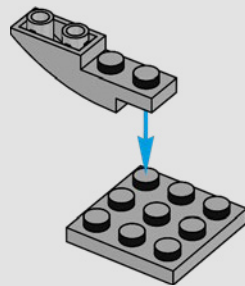

257

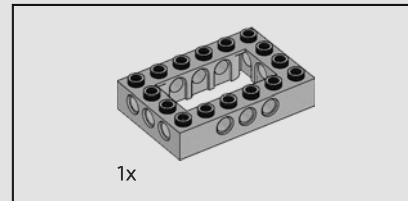
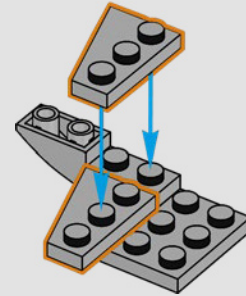

258

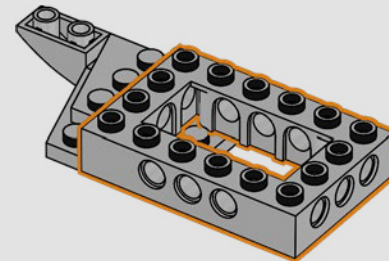

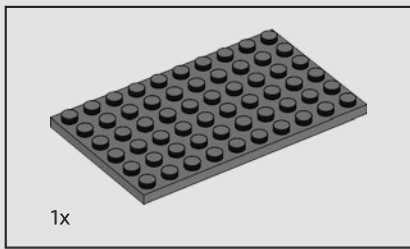

259

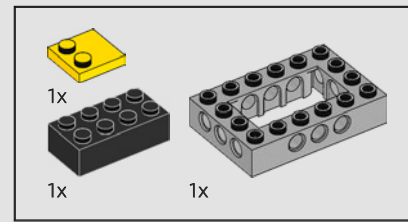
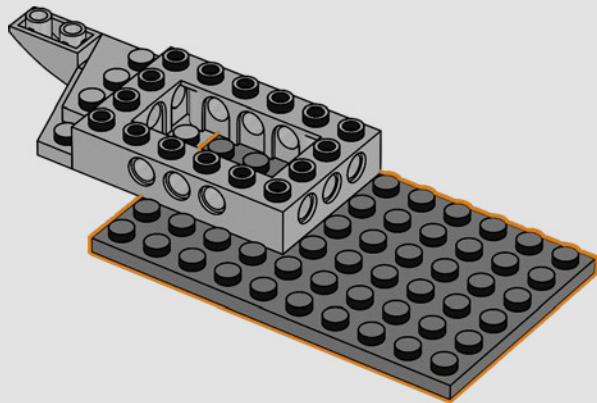

260

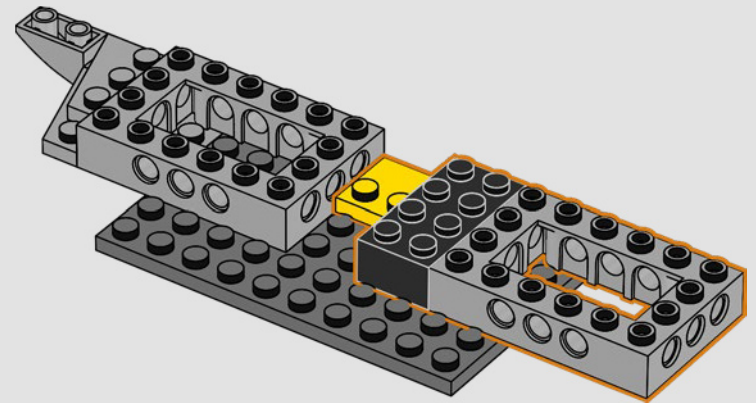



2x

261

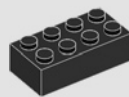
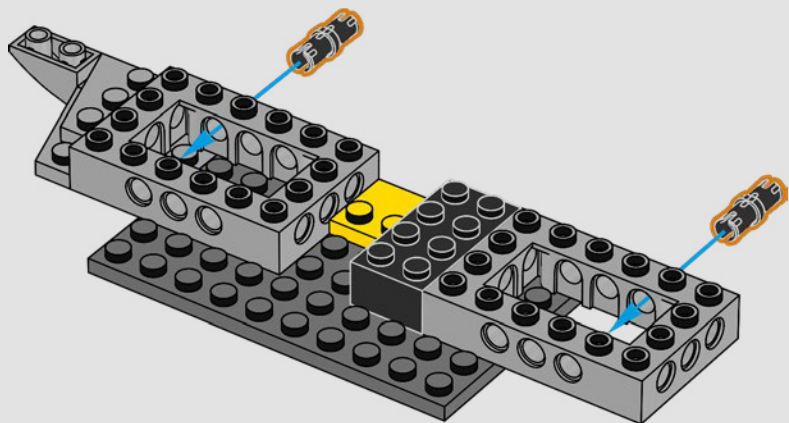

1x

262

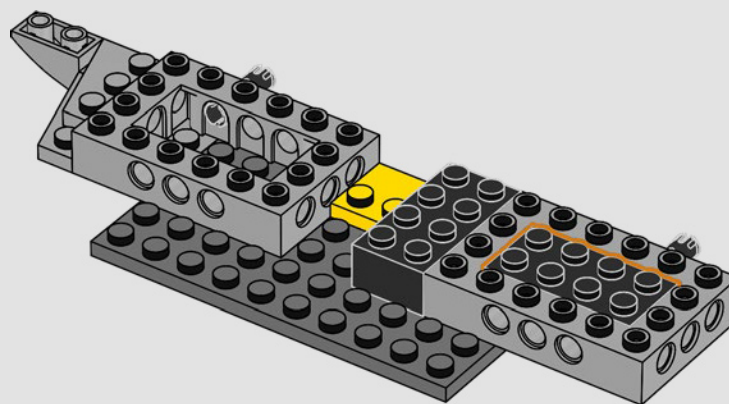

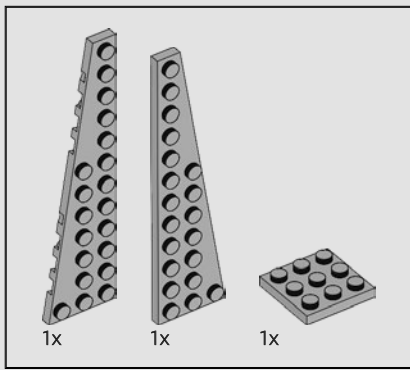

263

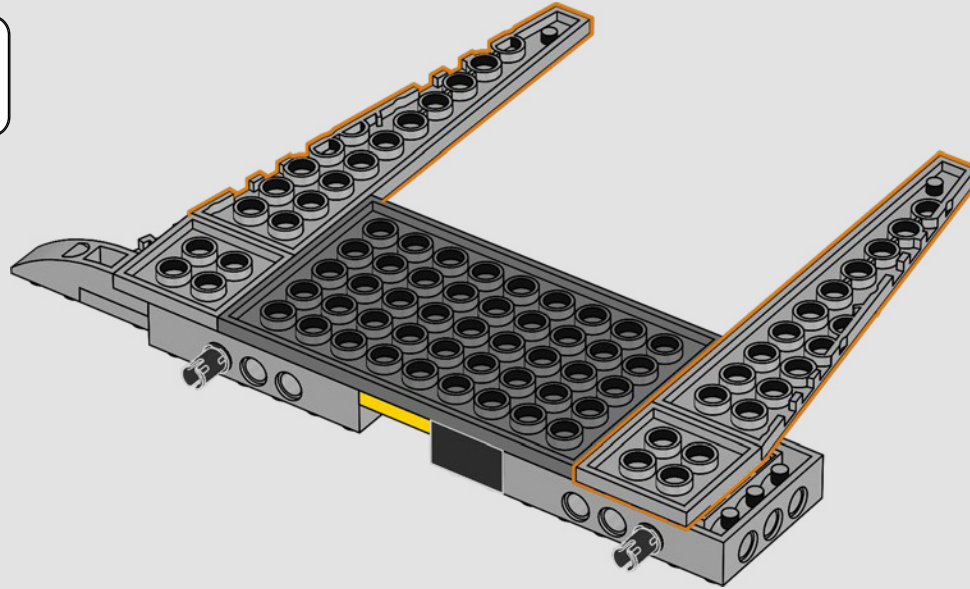



2x

264

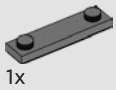
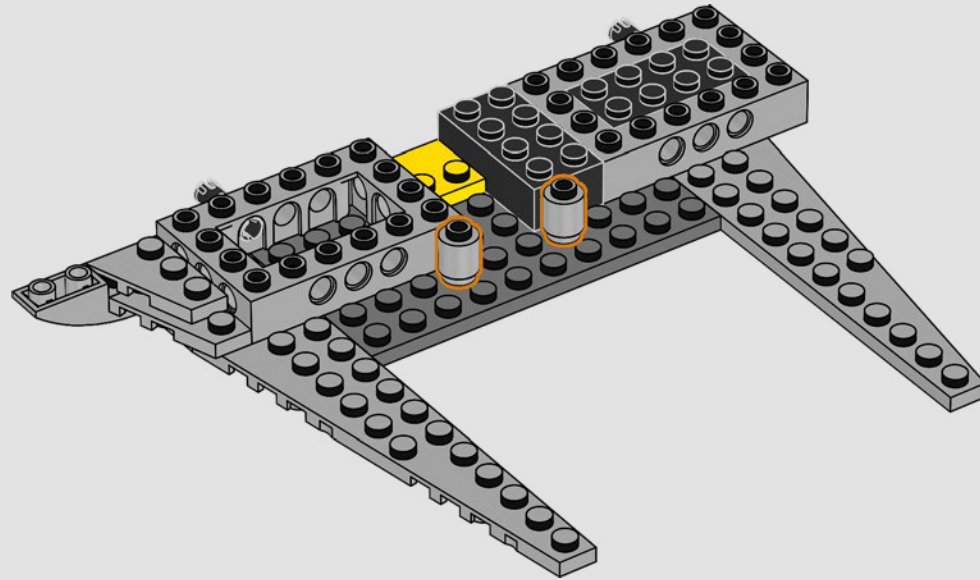

1x



2x

265

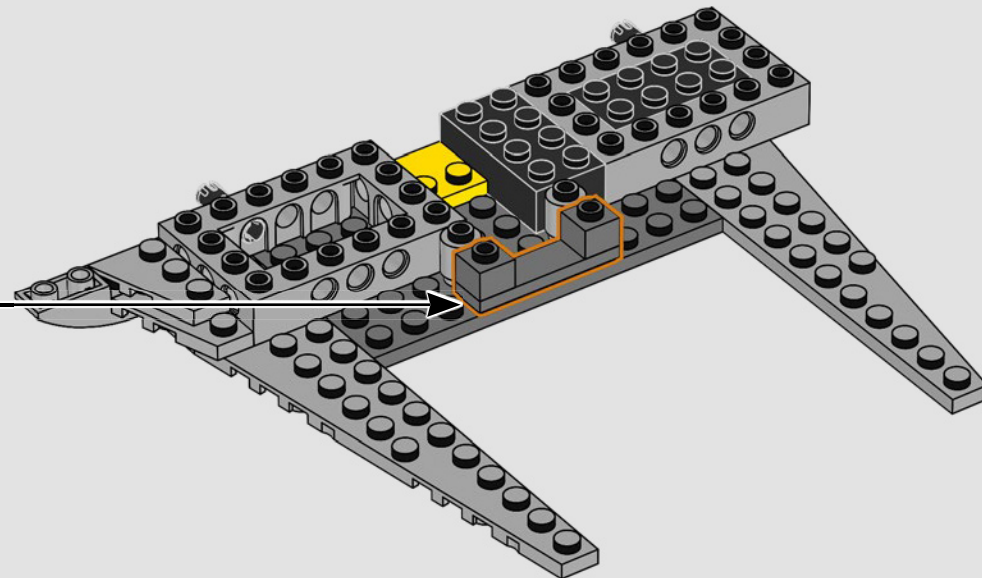
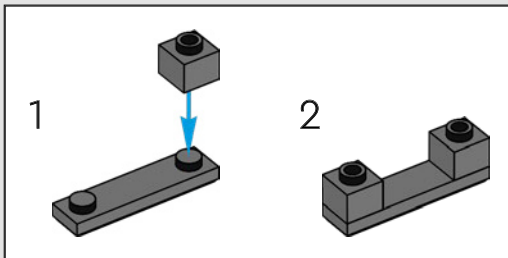

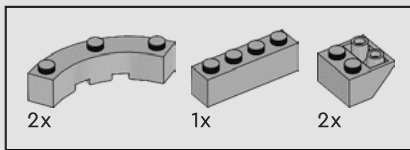

266

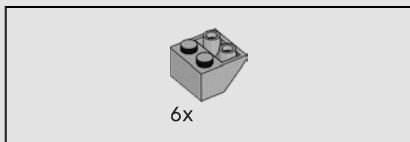
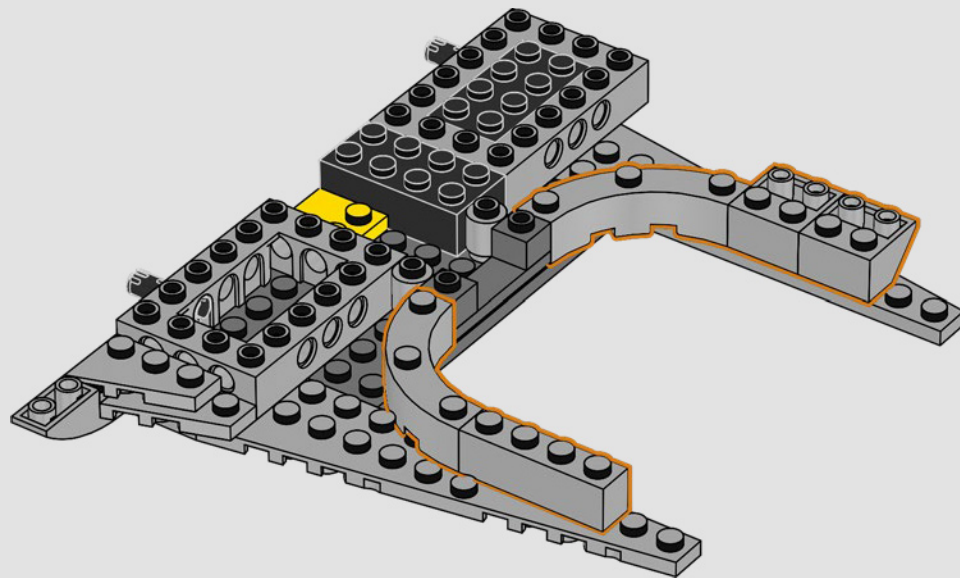

267

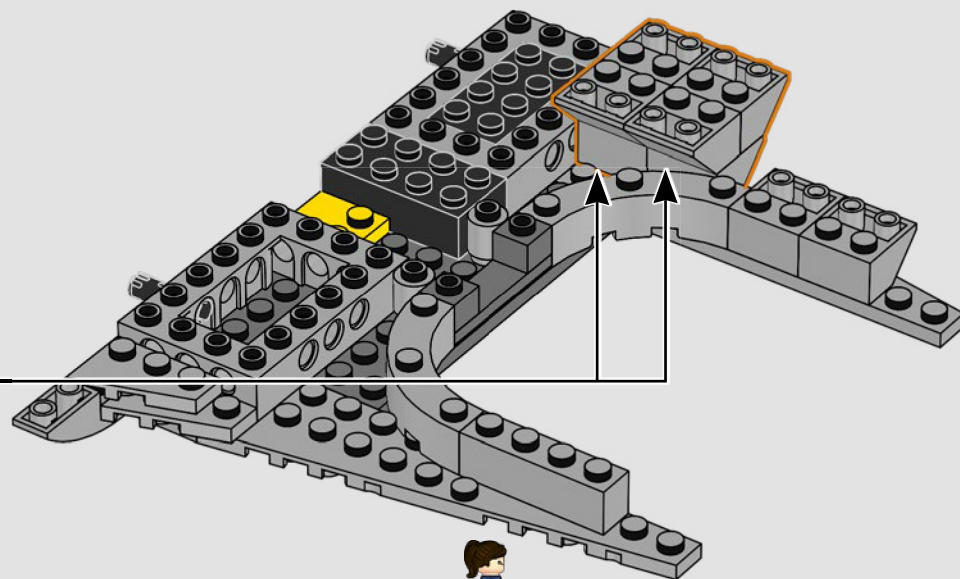
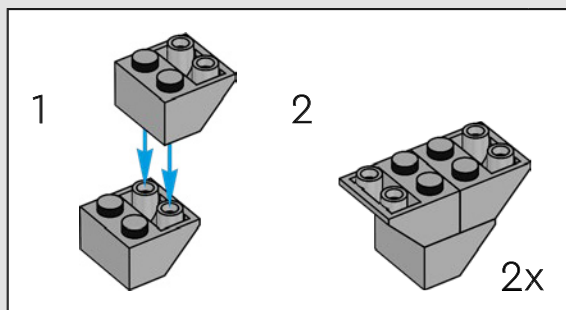

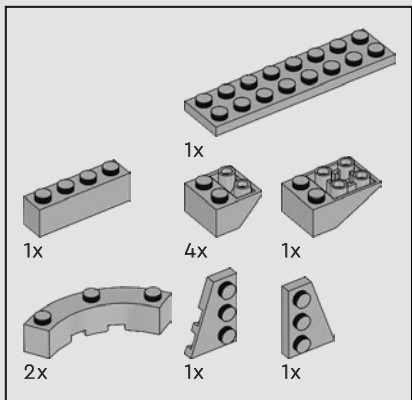

268

1

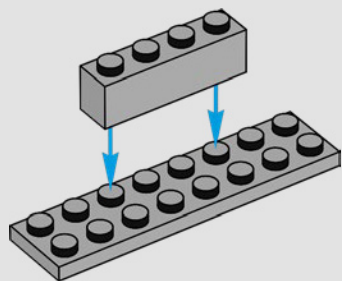

2

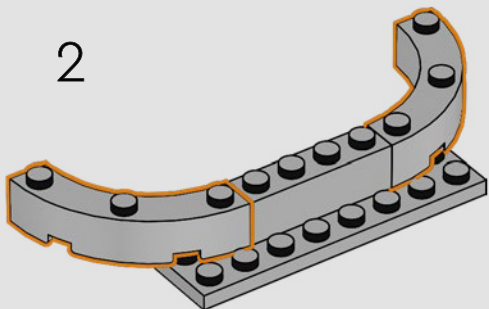

3

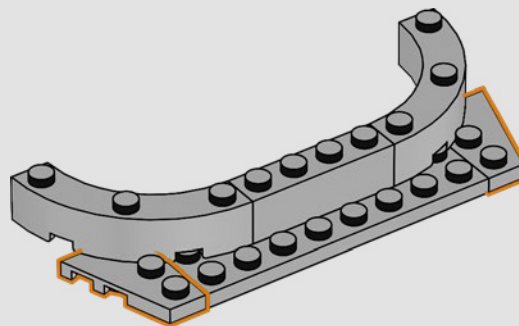

4

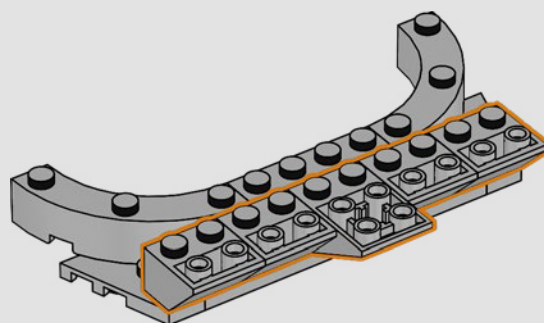

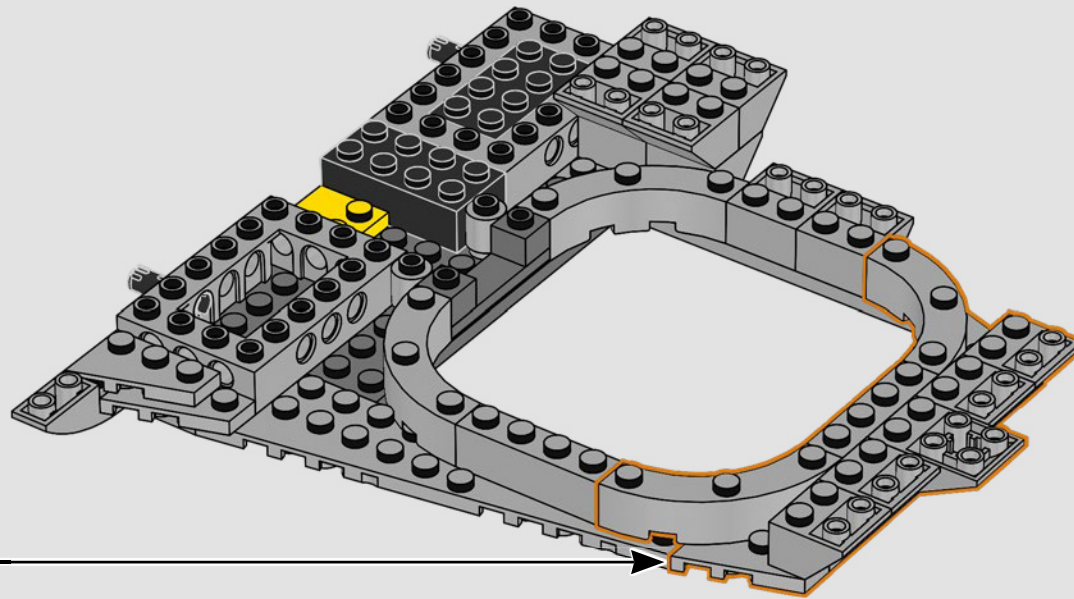

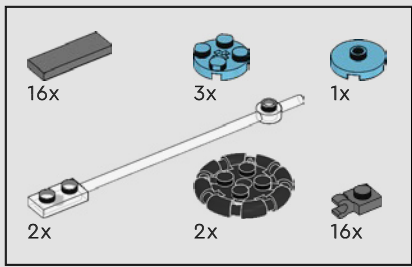

269

1

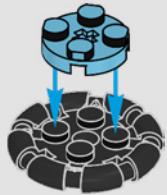

2

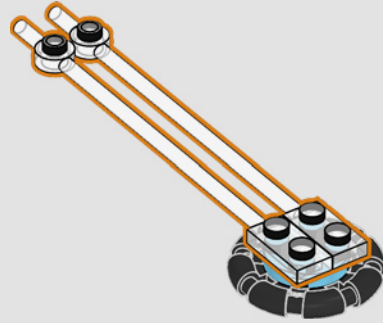

3

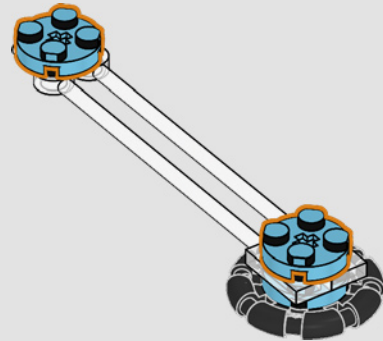

4

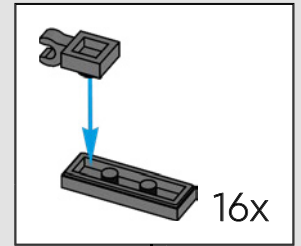
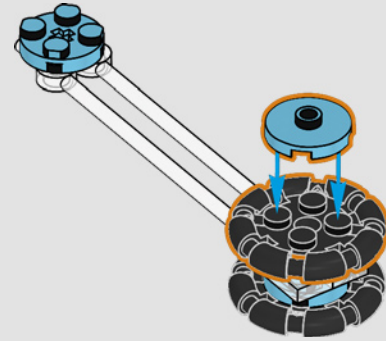

5

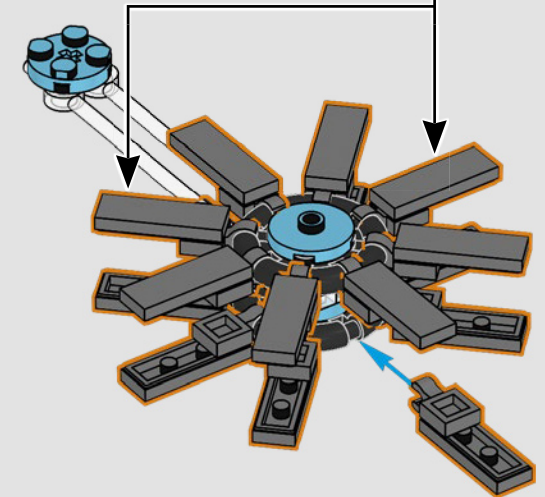

6

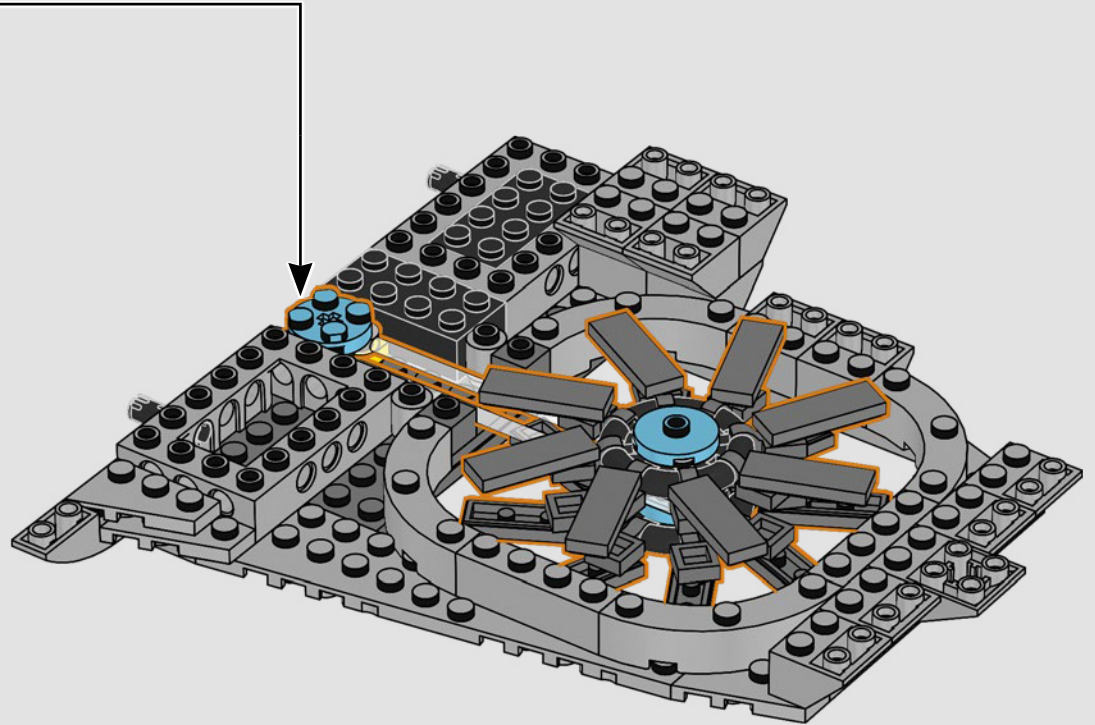
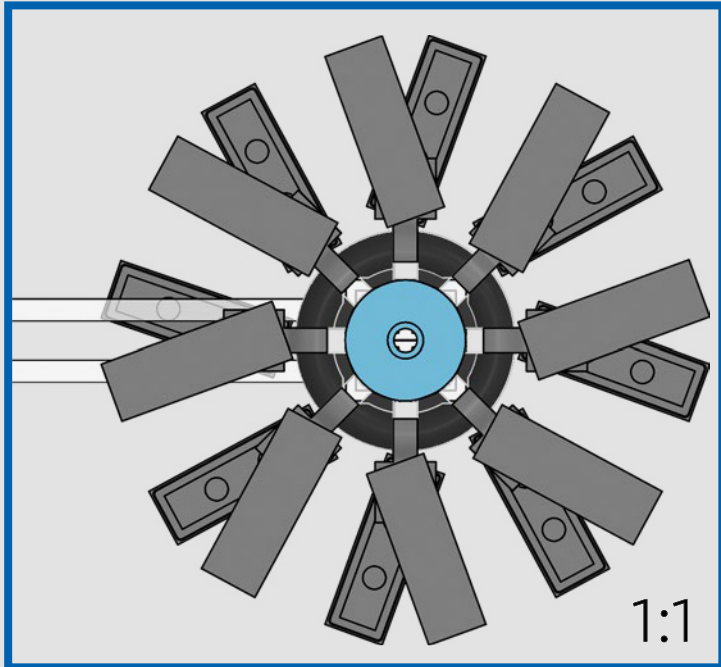
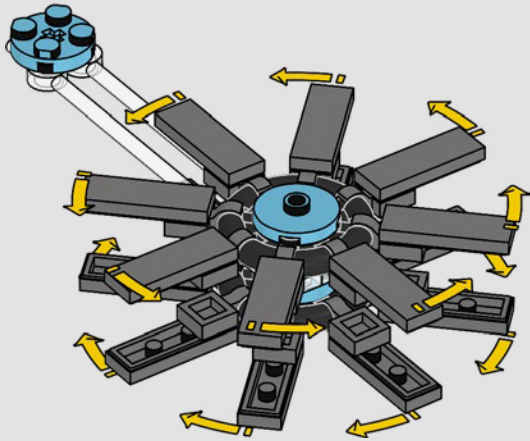



4x

270

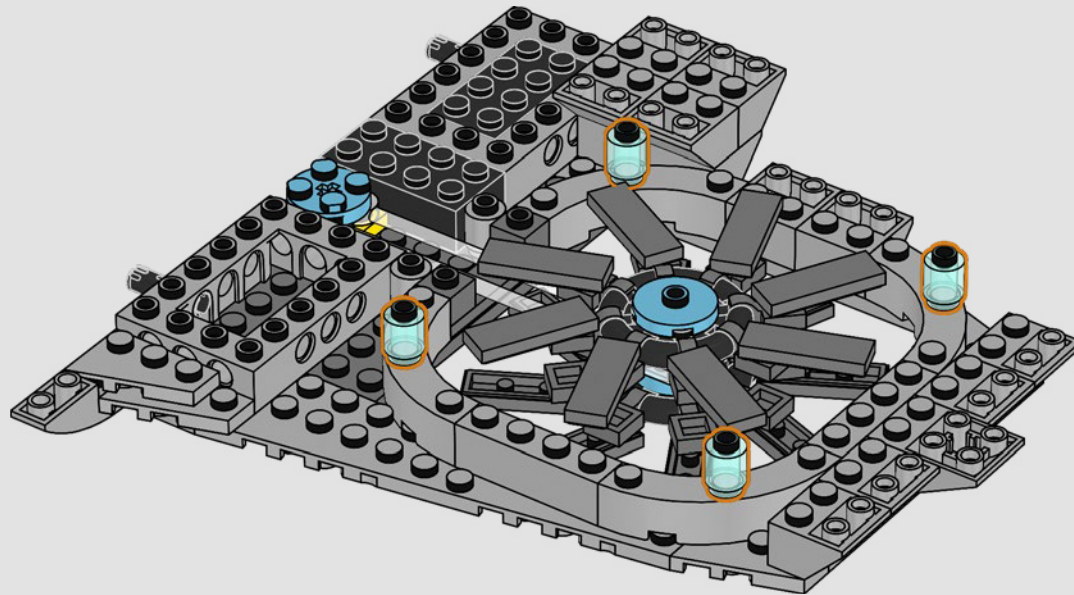

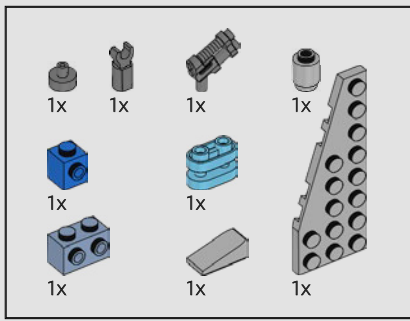

271

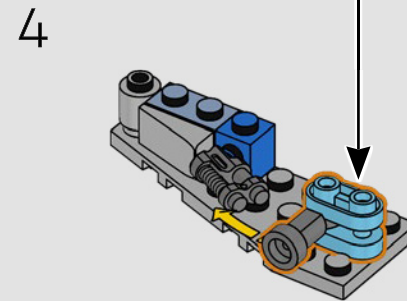
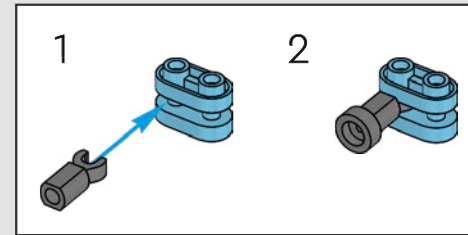
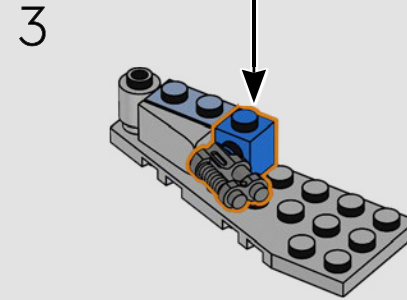
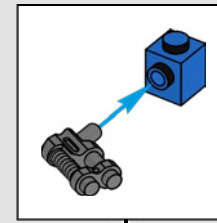
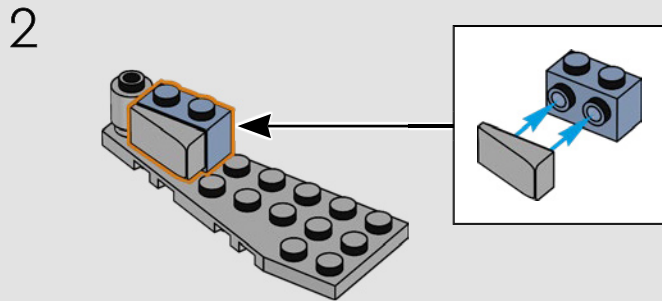
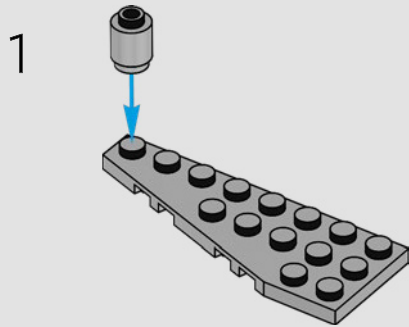

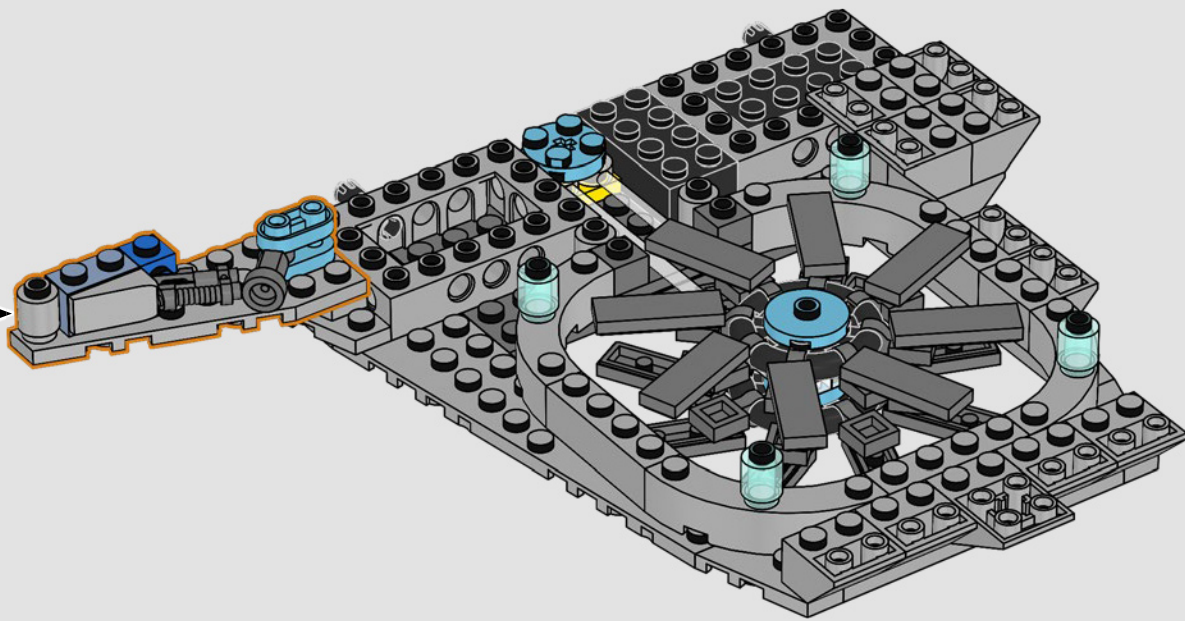

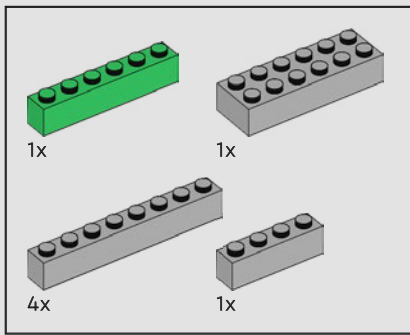

272

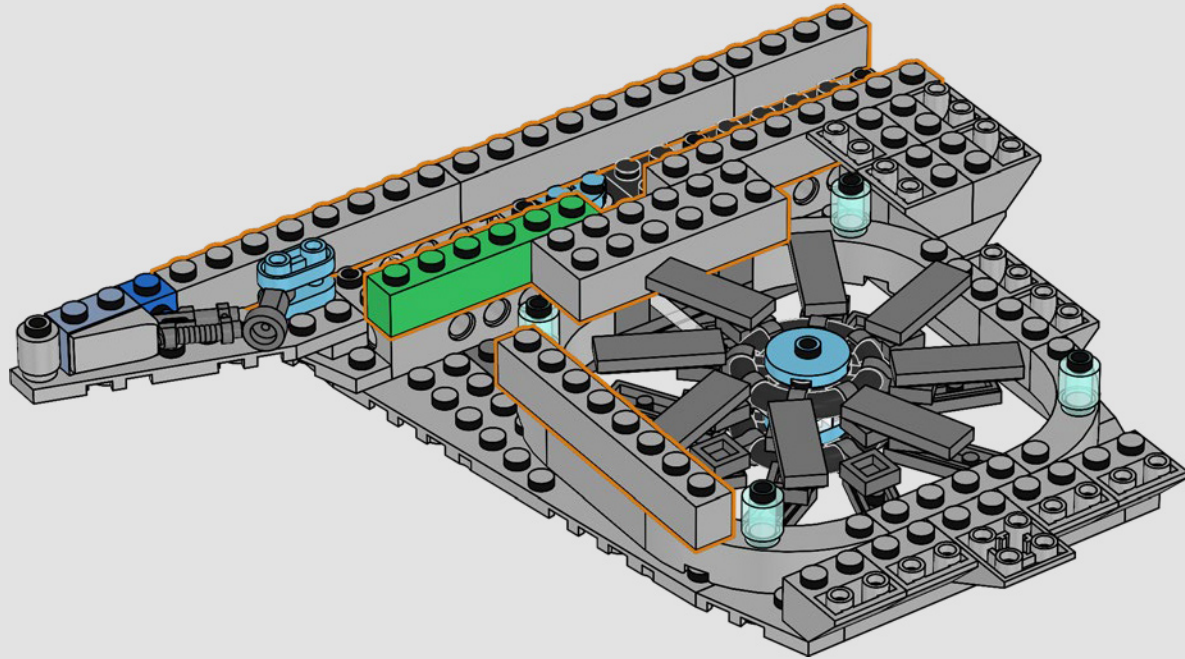

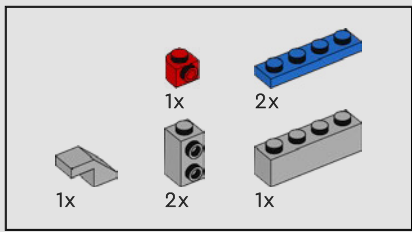

273

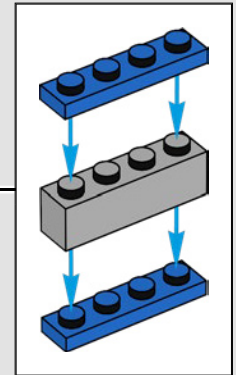
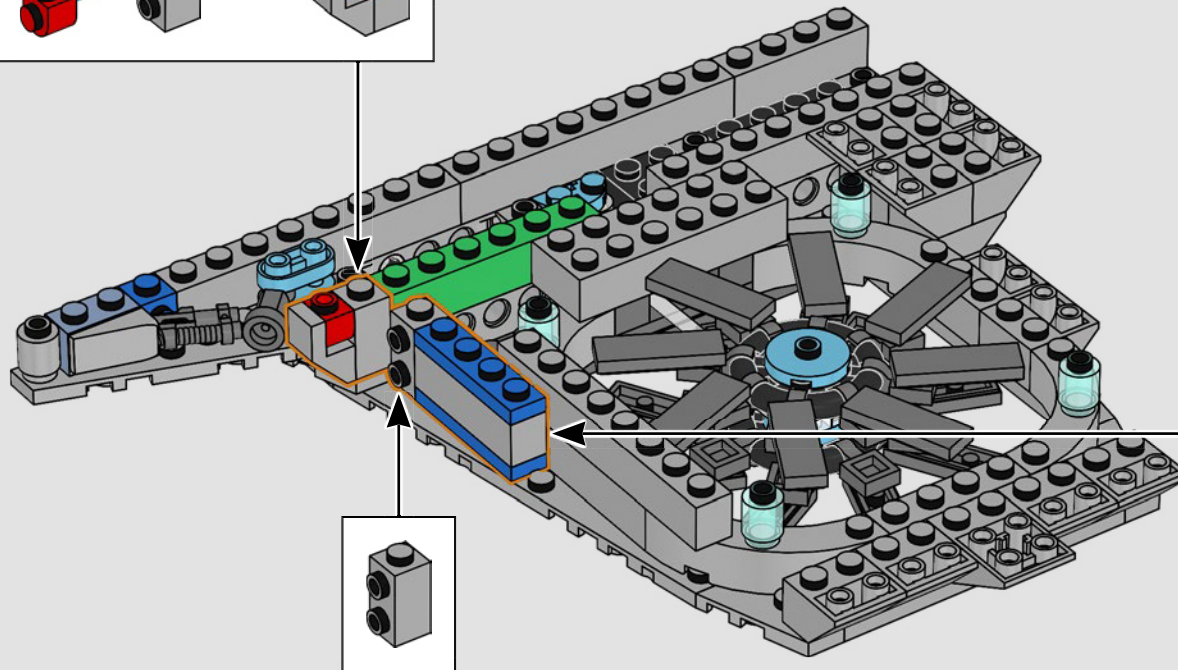
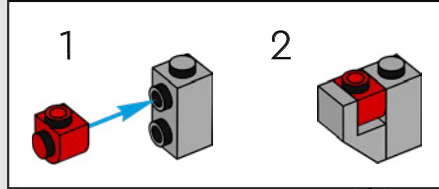

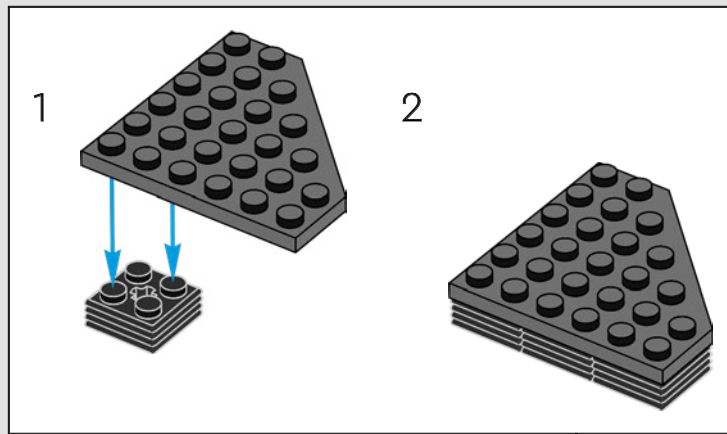
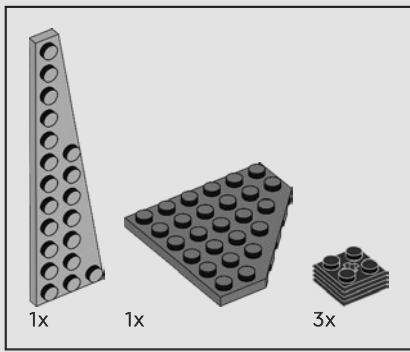

274

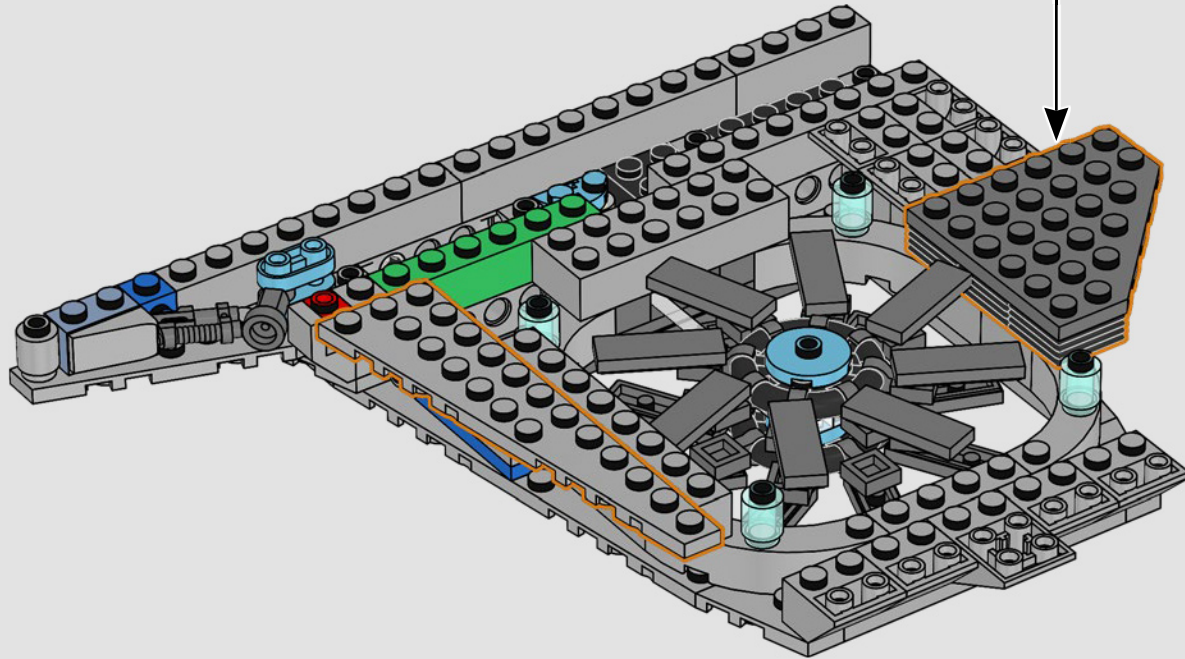

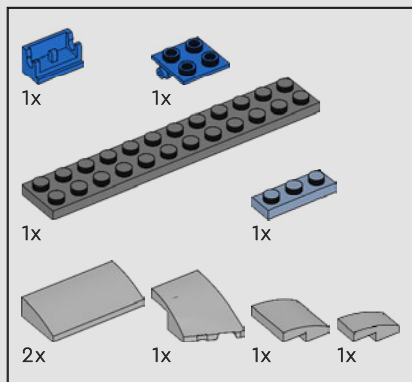

276

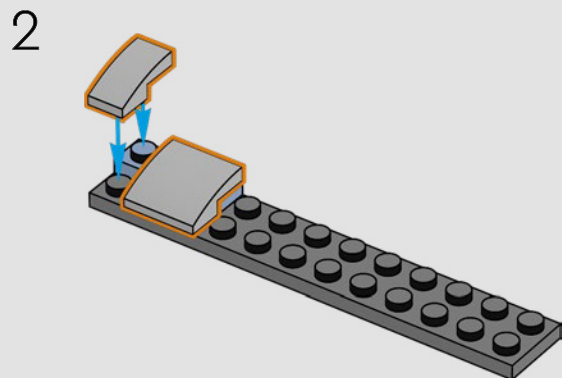
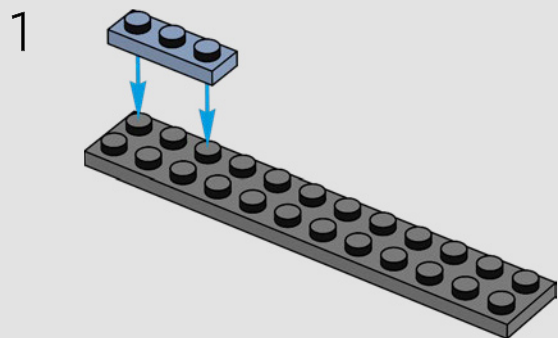

3

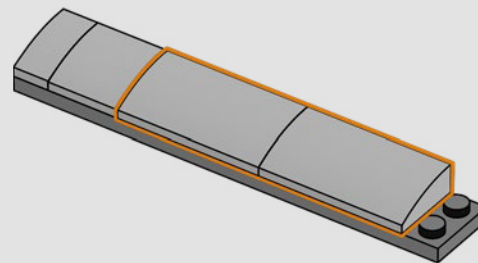

4

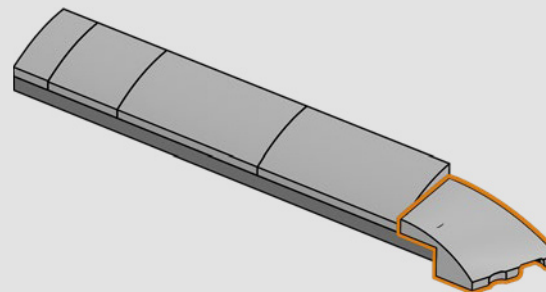

5

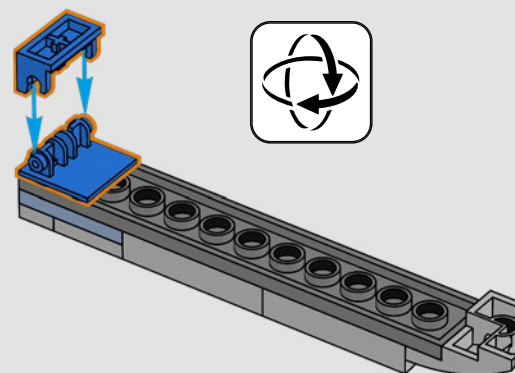

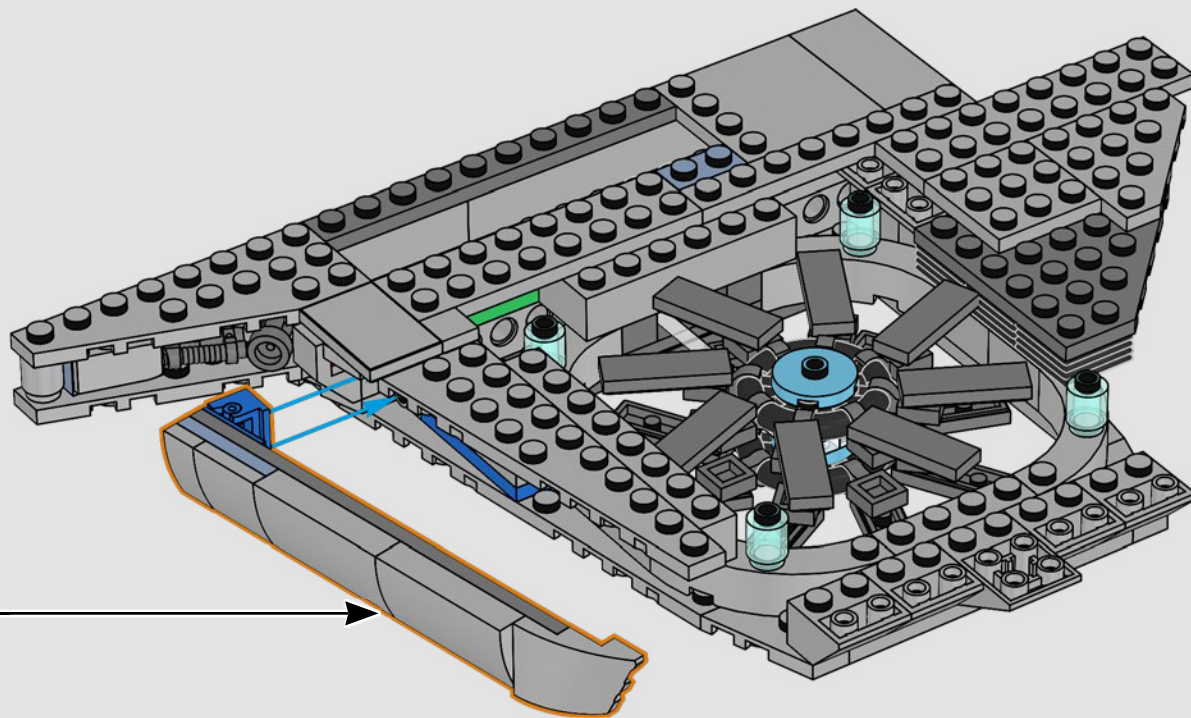

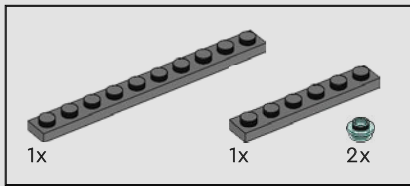

277

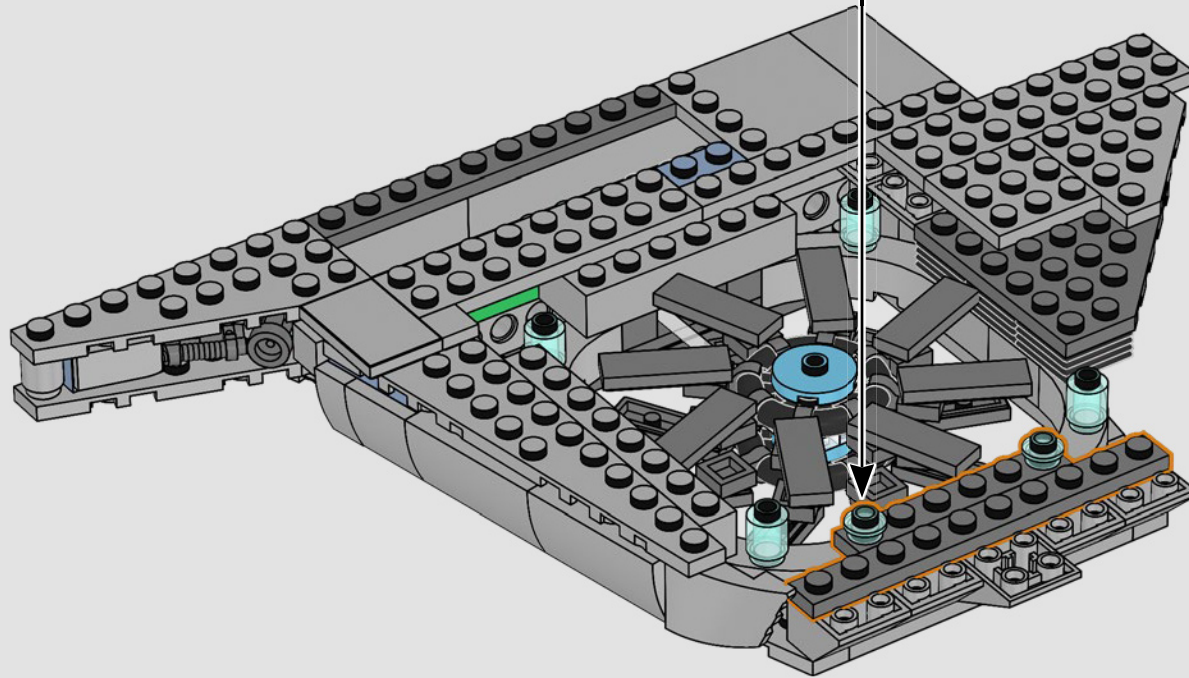
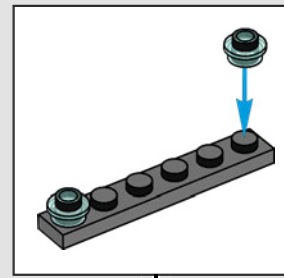

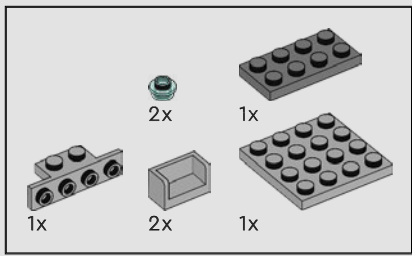

278

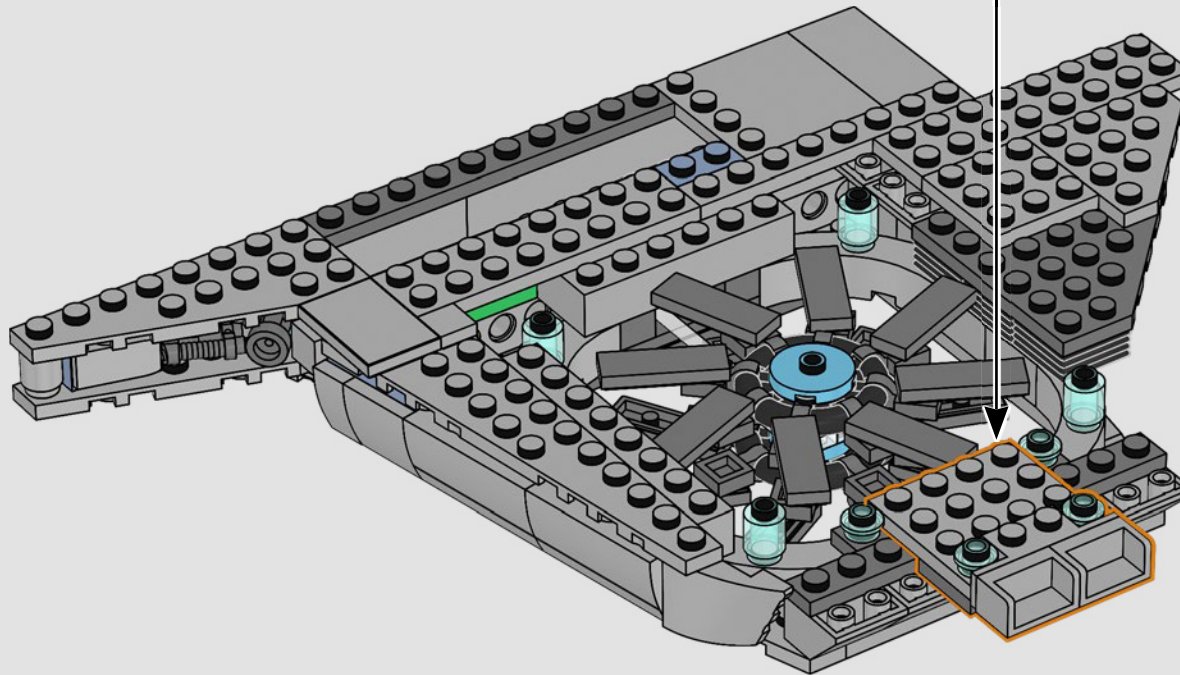
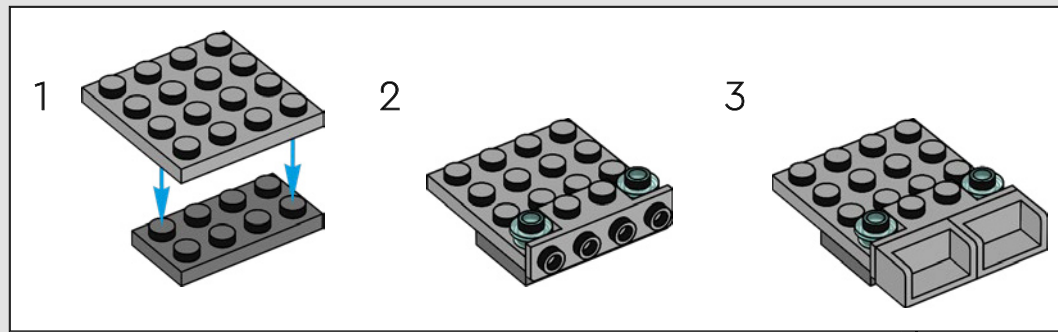

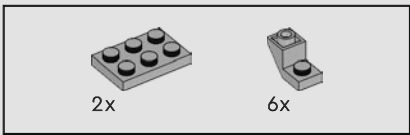

279

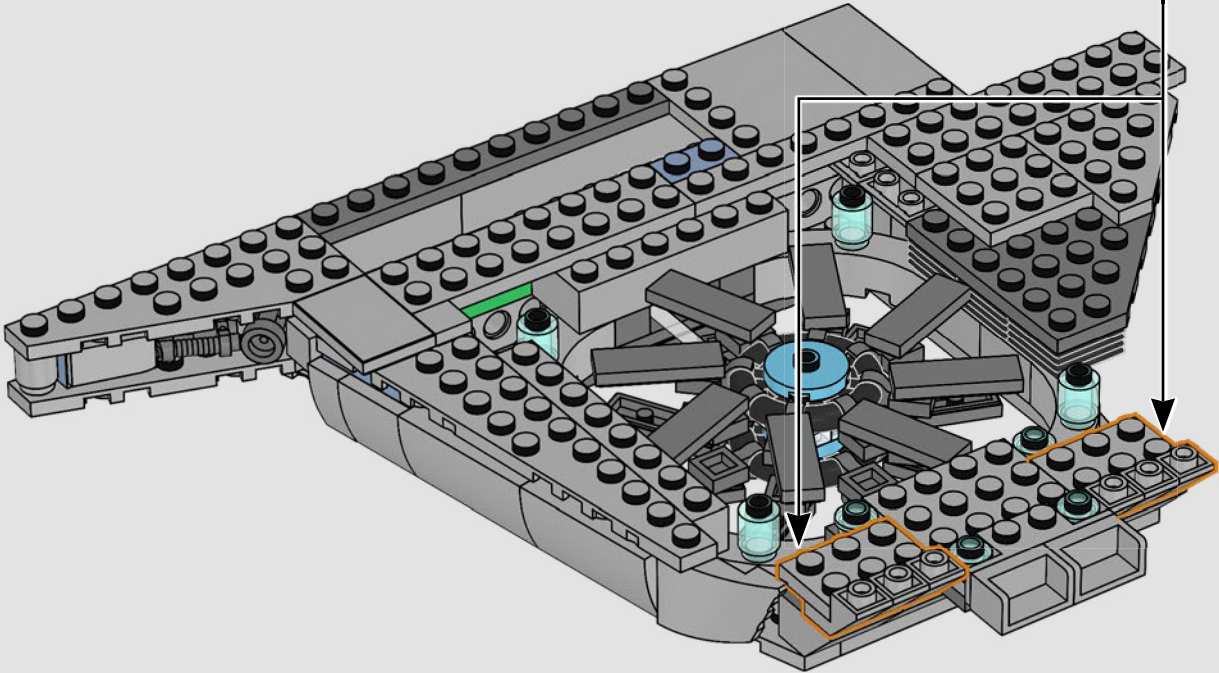
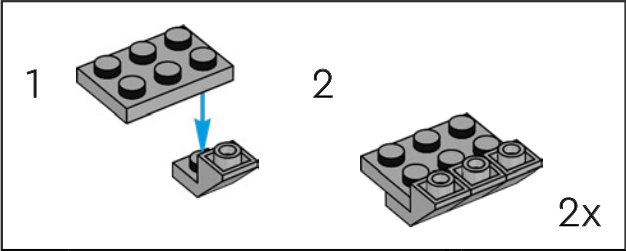

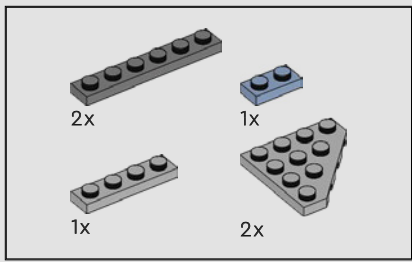

280

1

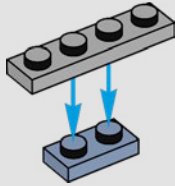

2

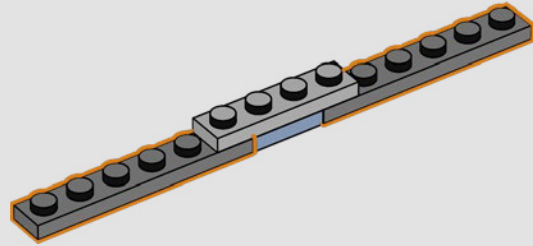

3

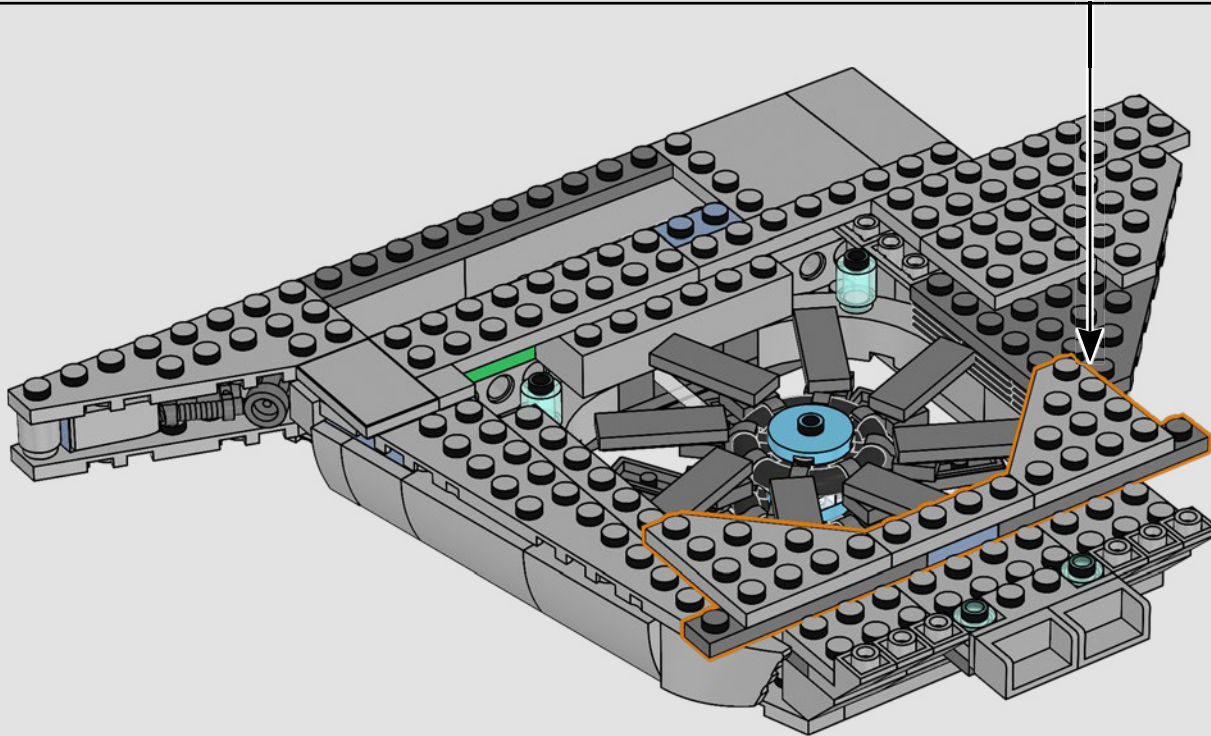
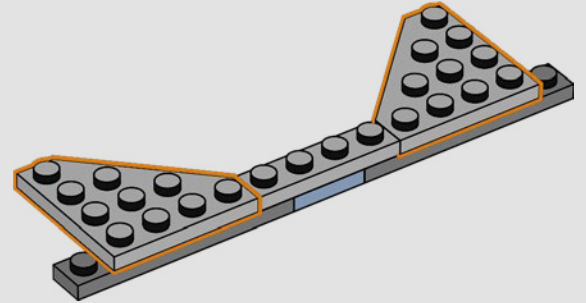

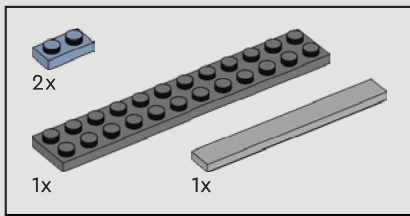

281

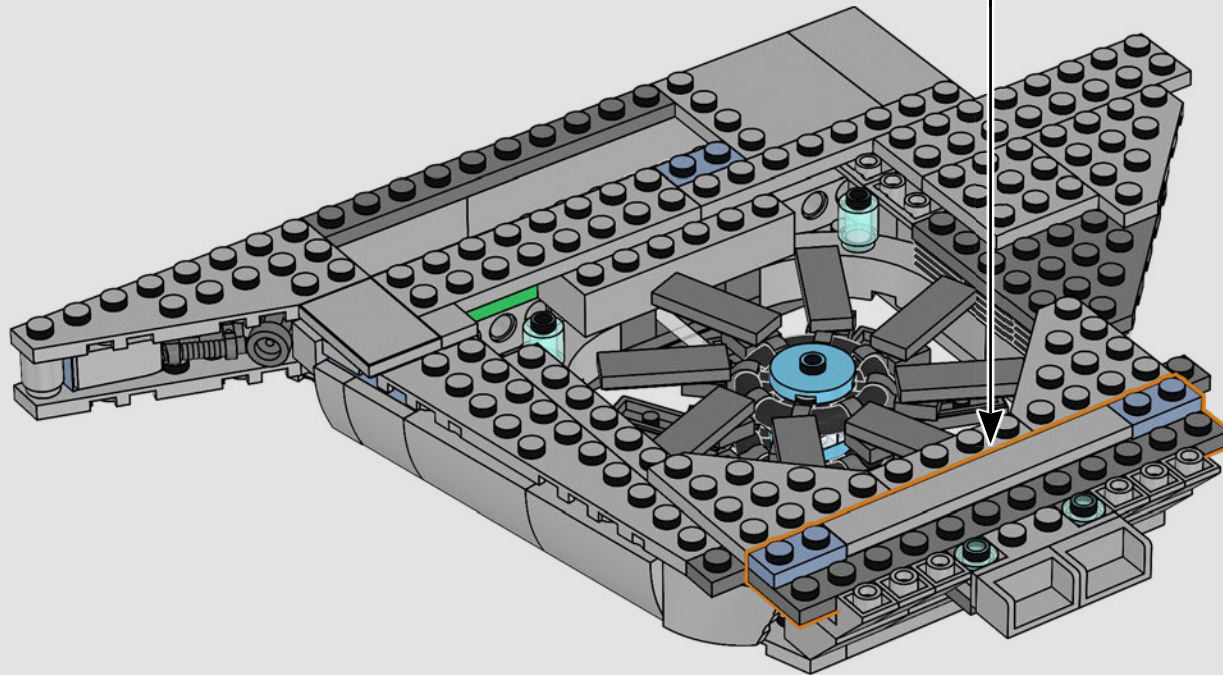
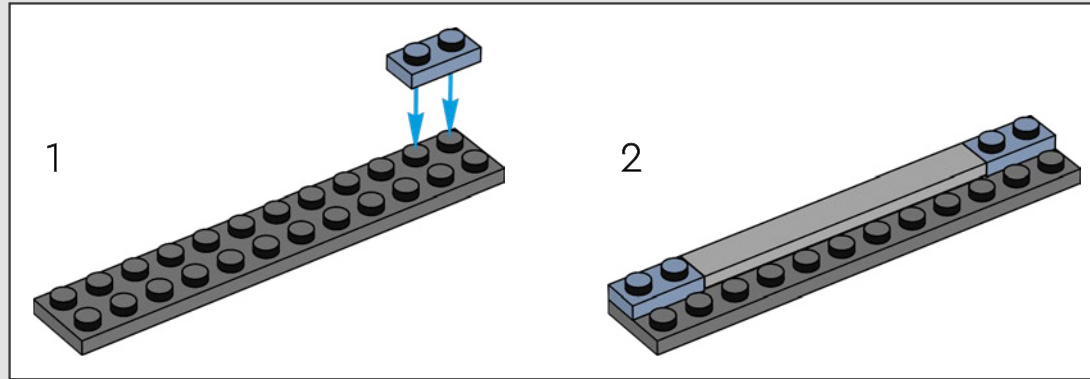

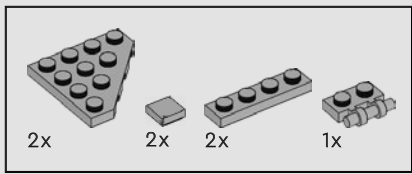

282

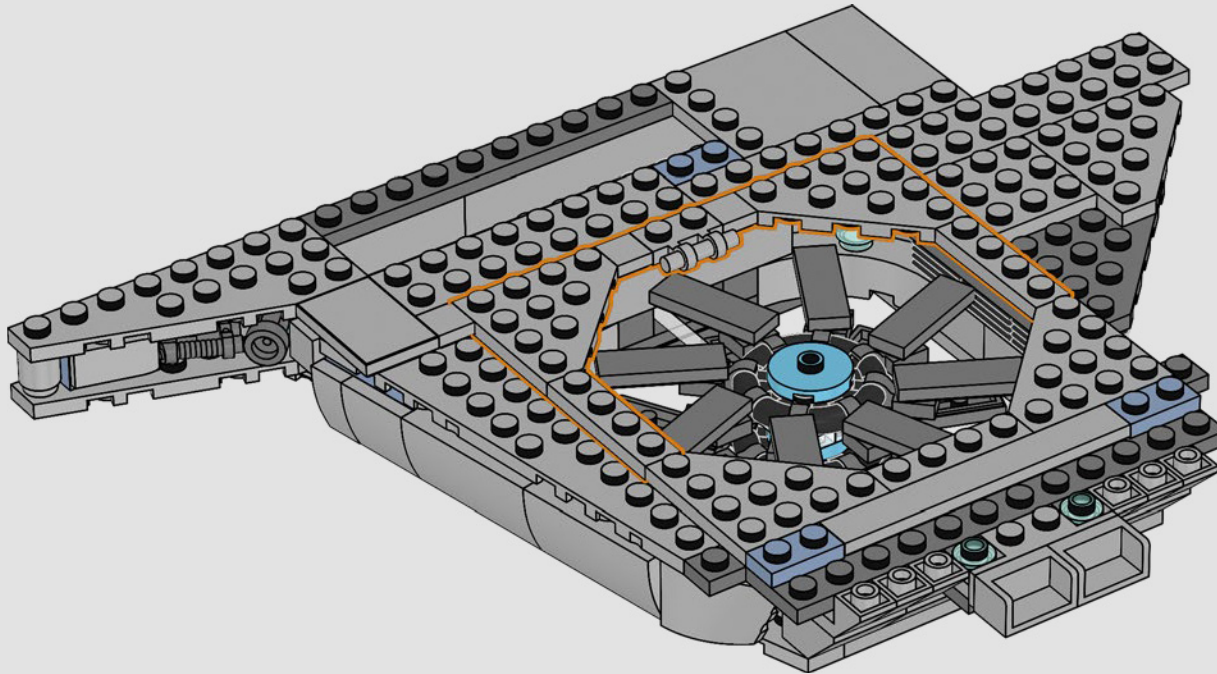

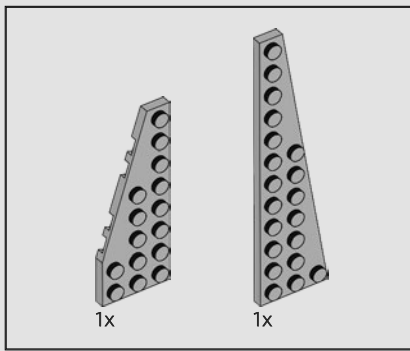

283

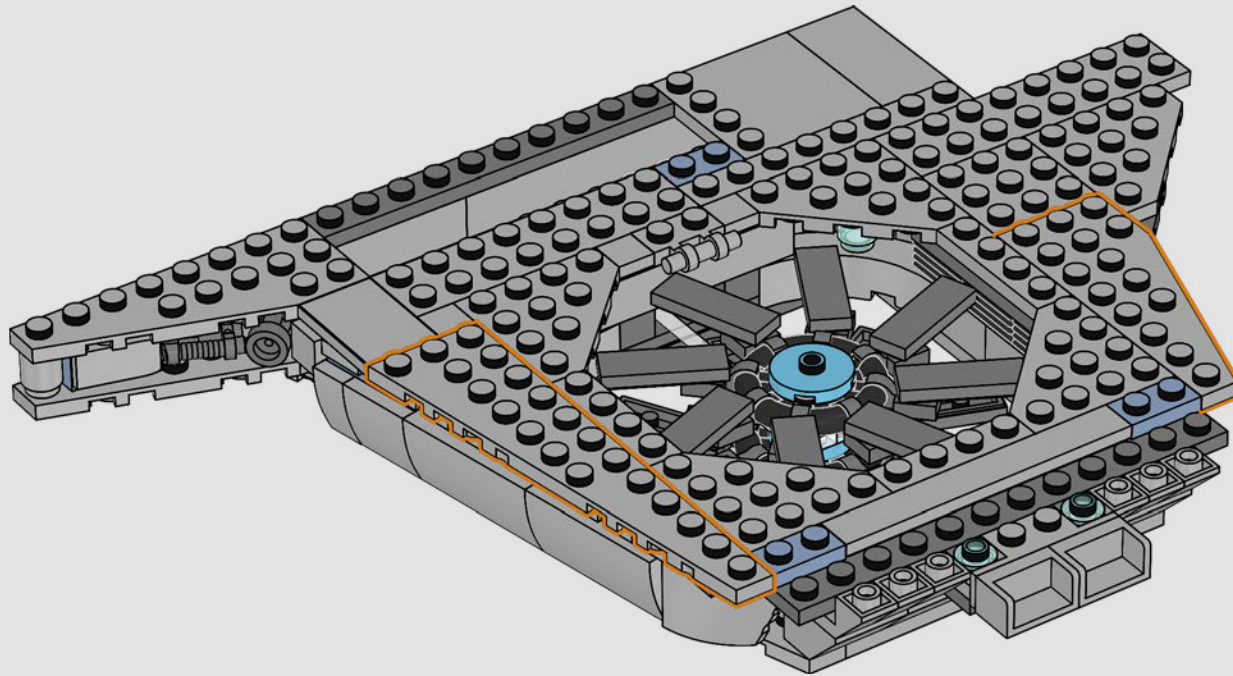

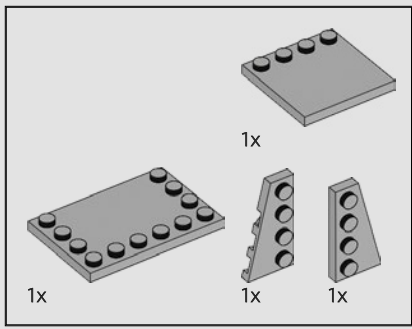

284

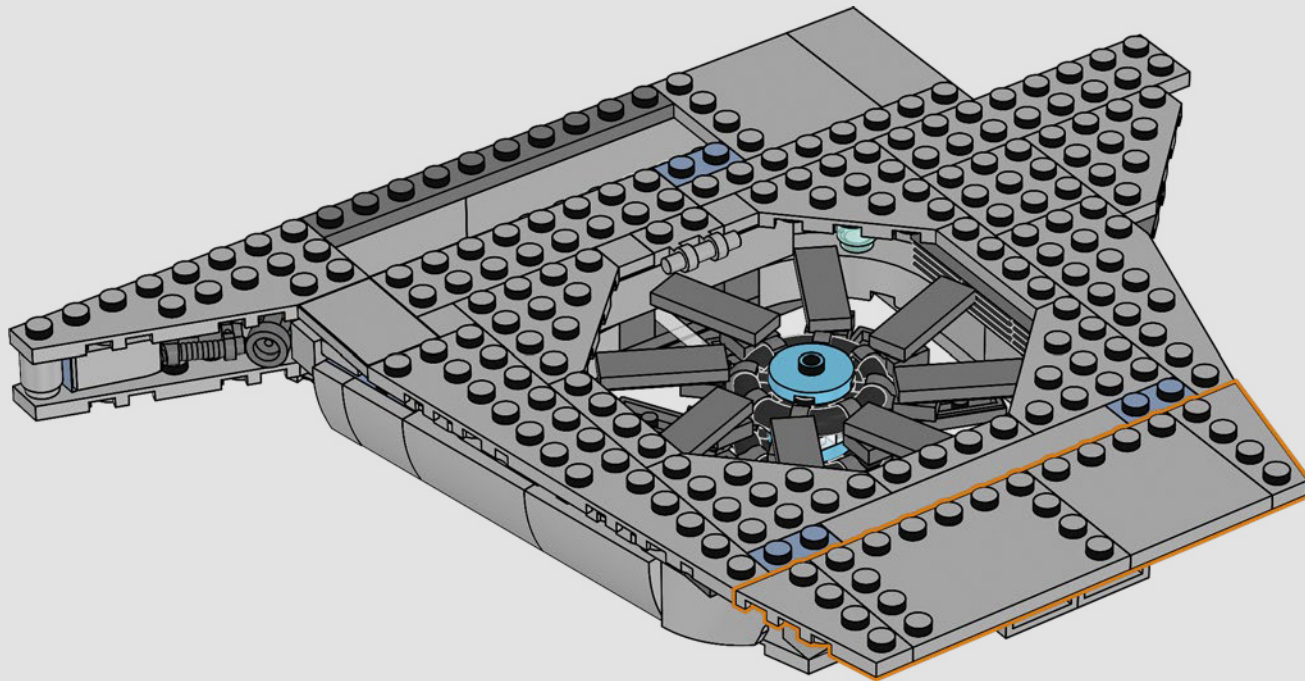

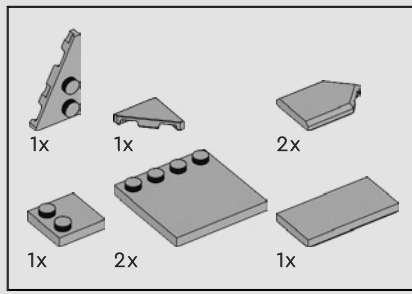

285

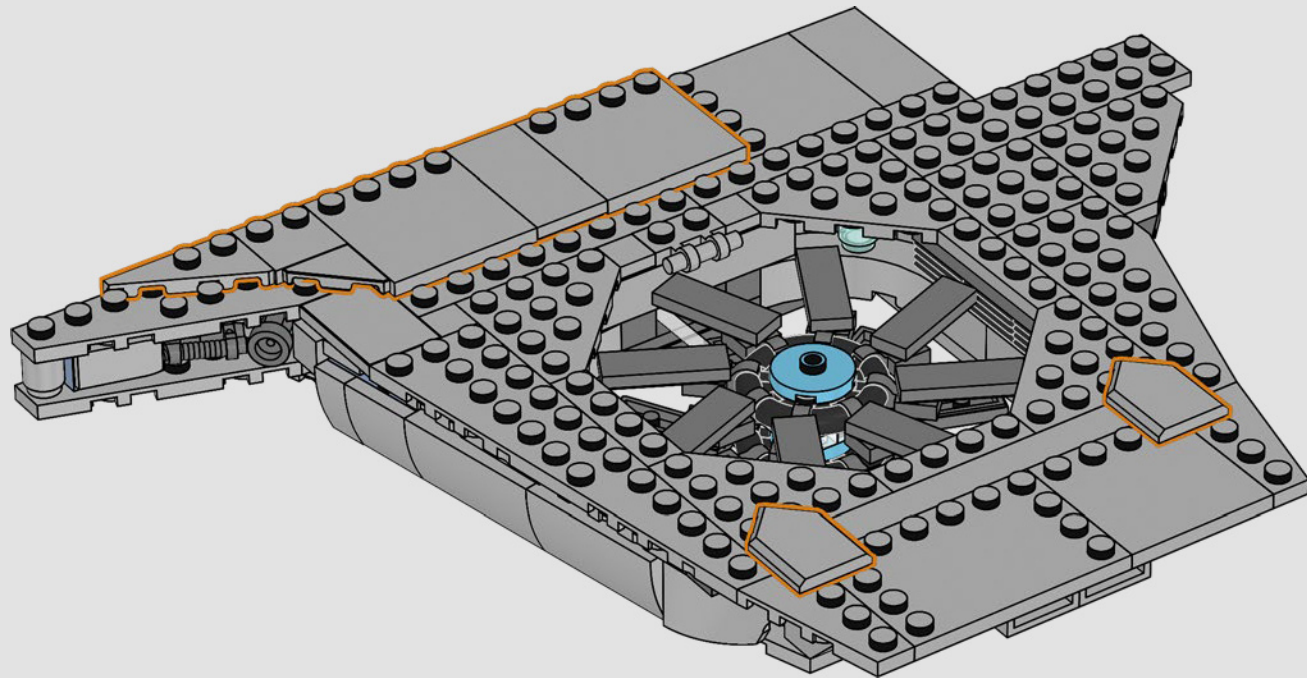

286

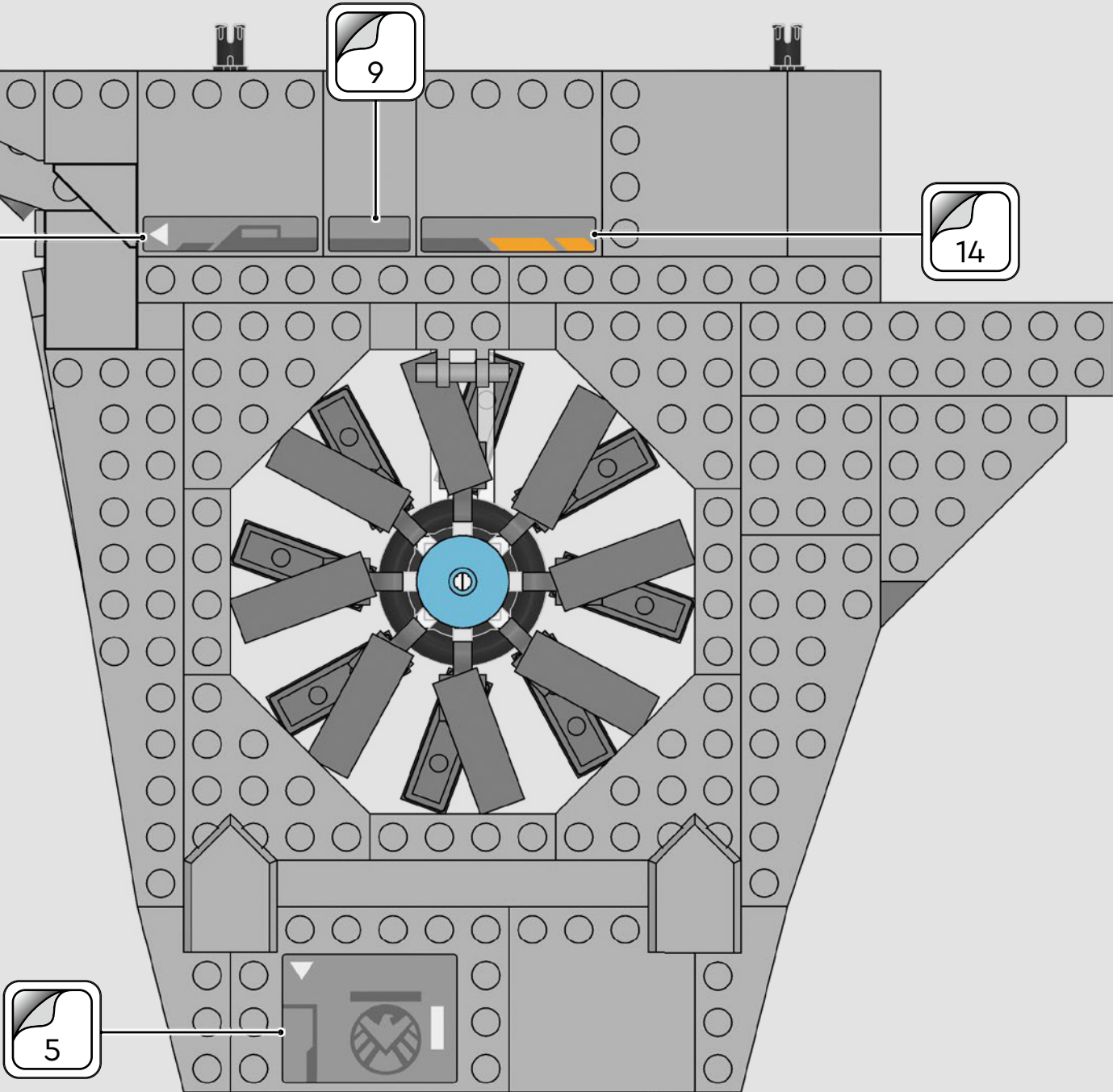
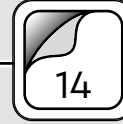

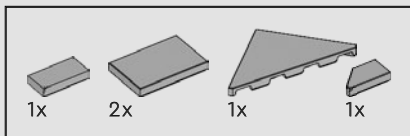

287

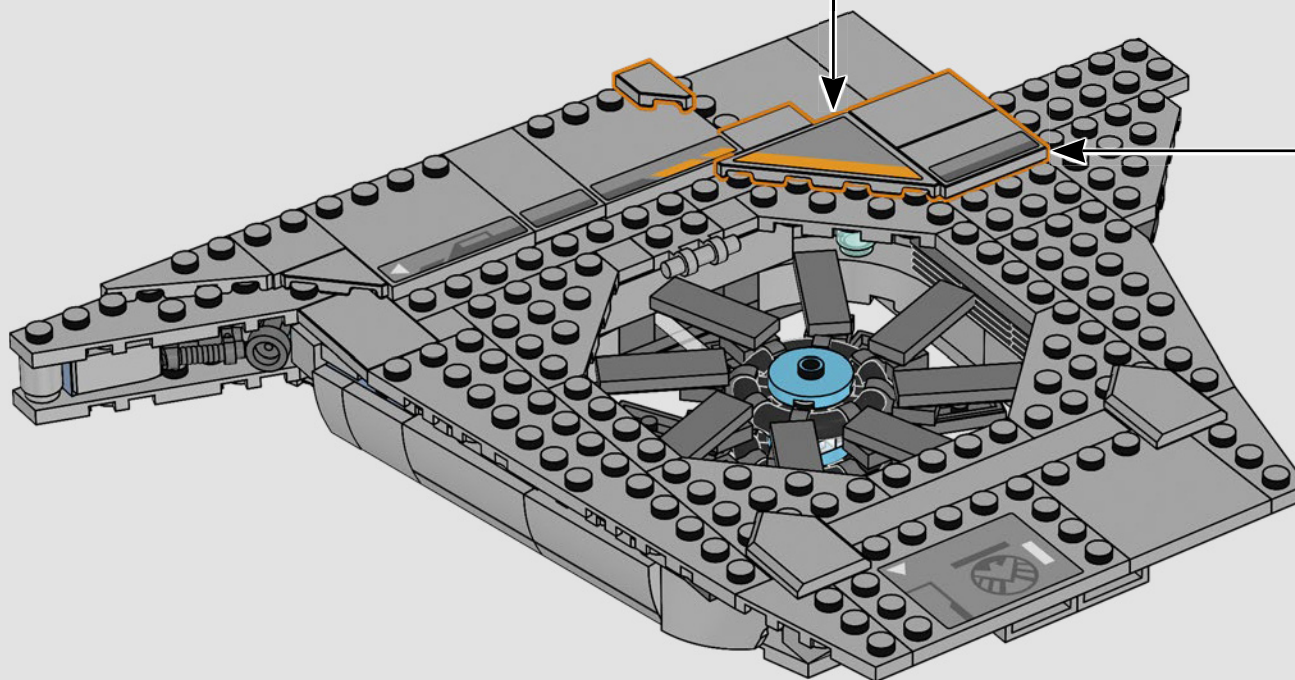
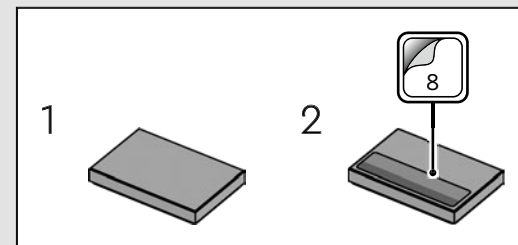
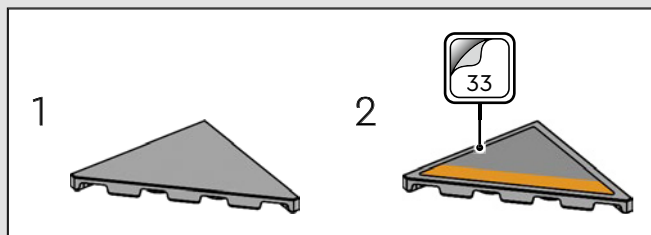

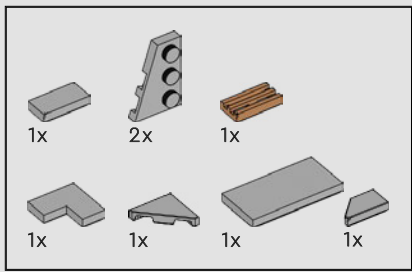

288

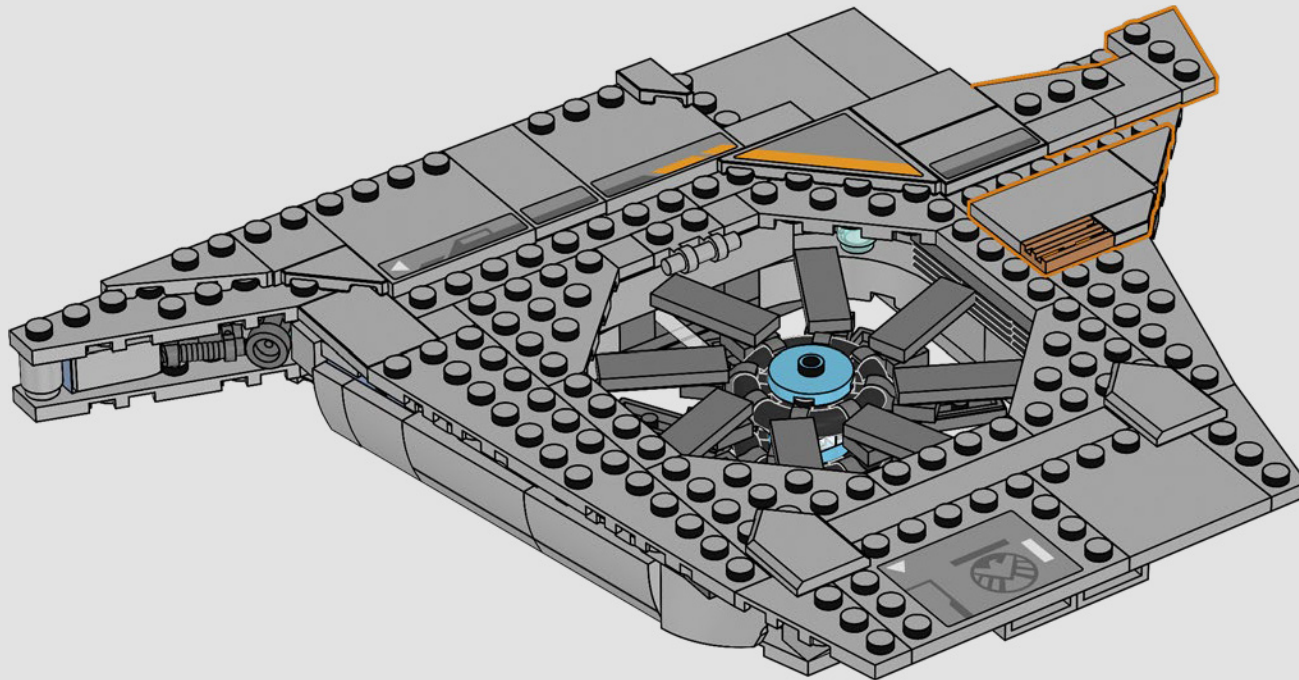

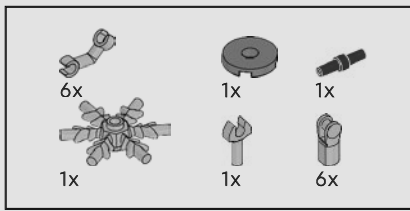

289

1

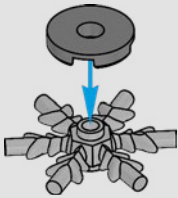

2

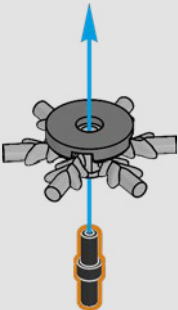

3

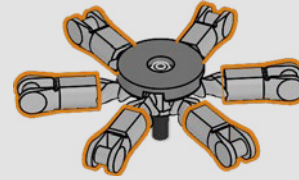

4

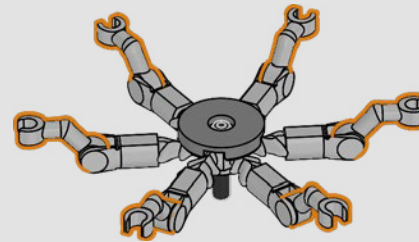

5

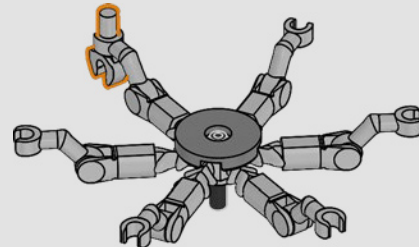

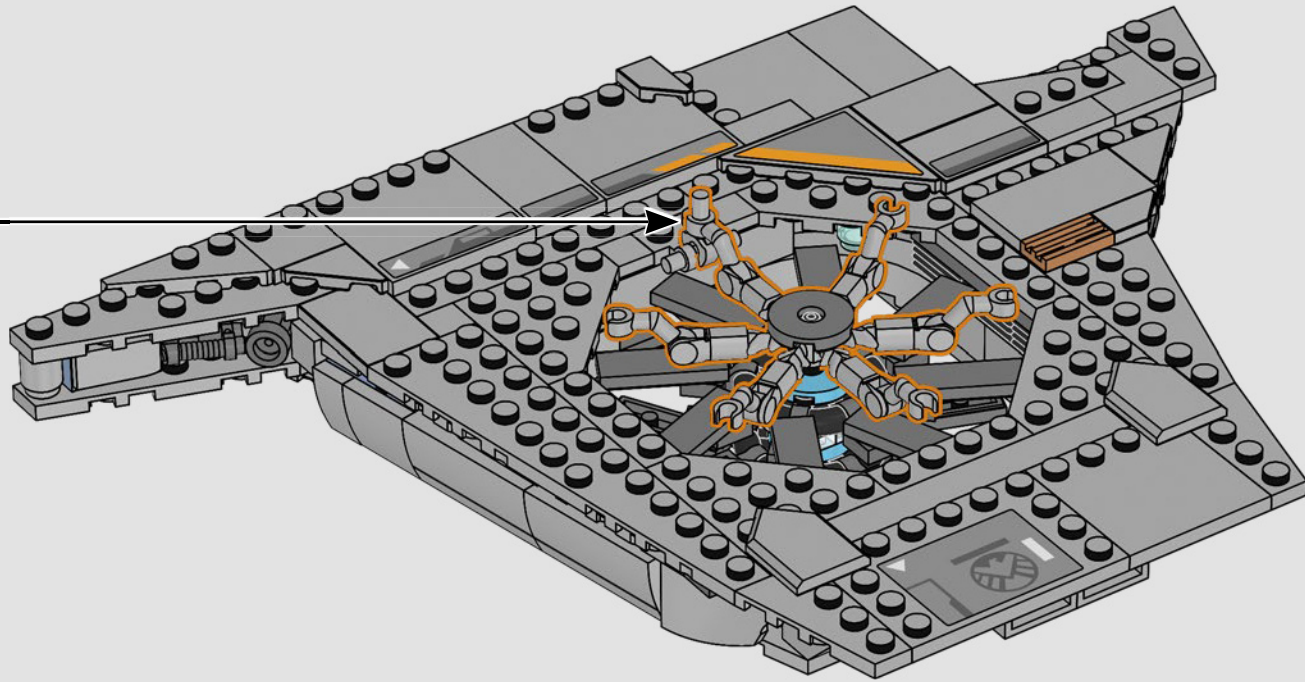

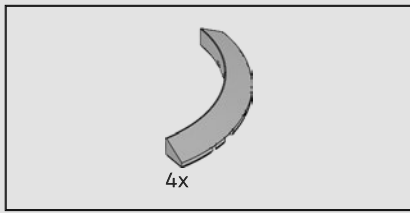

290

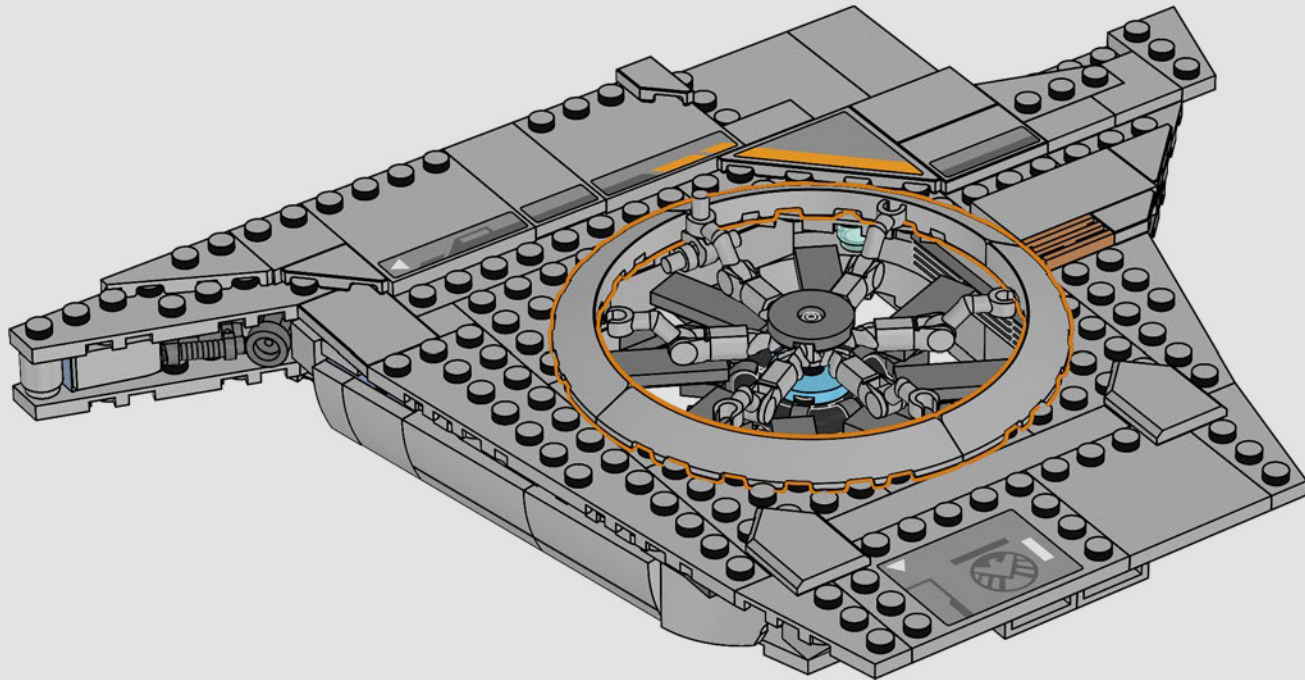

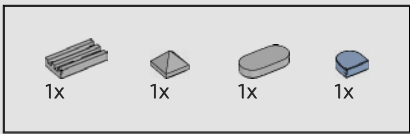

291

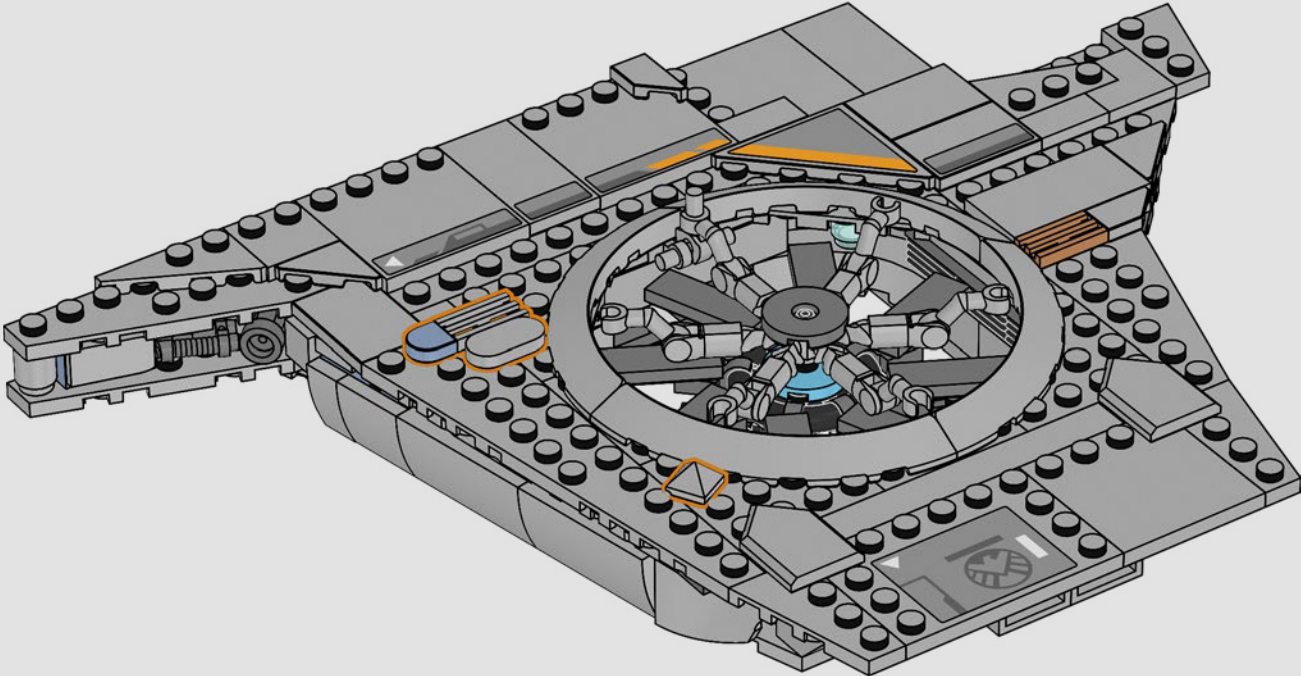

292

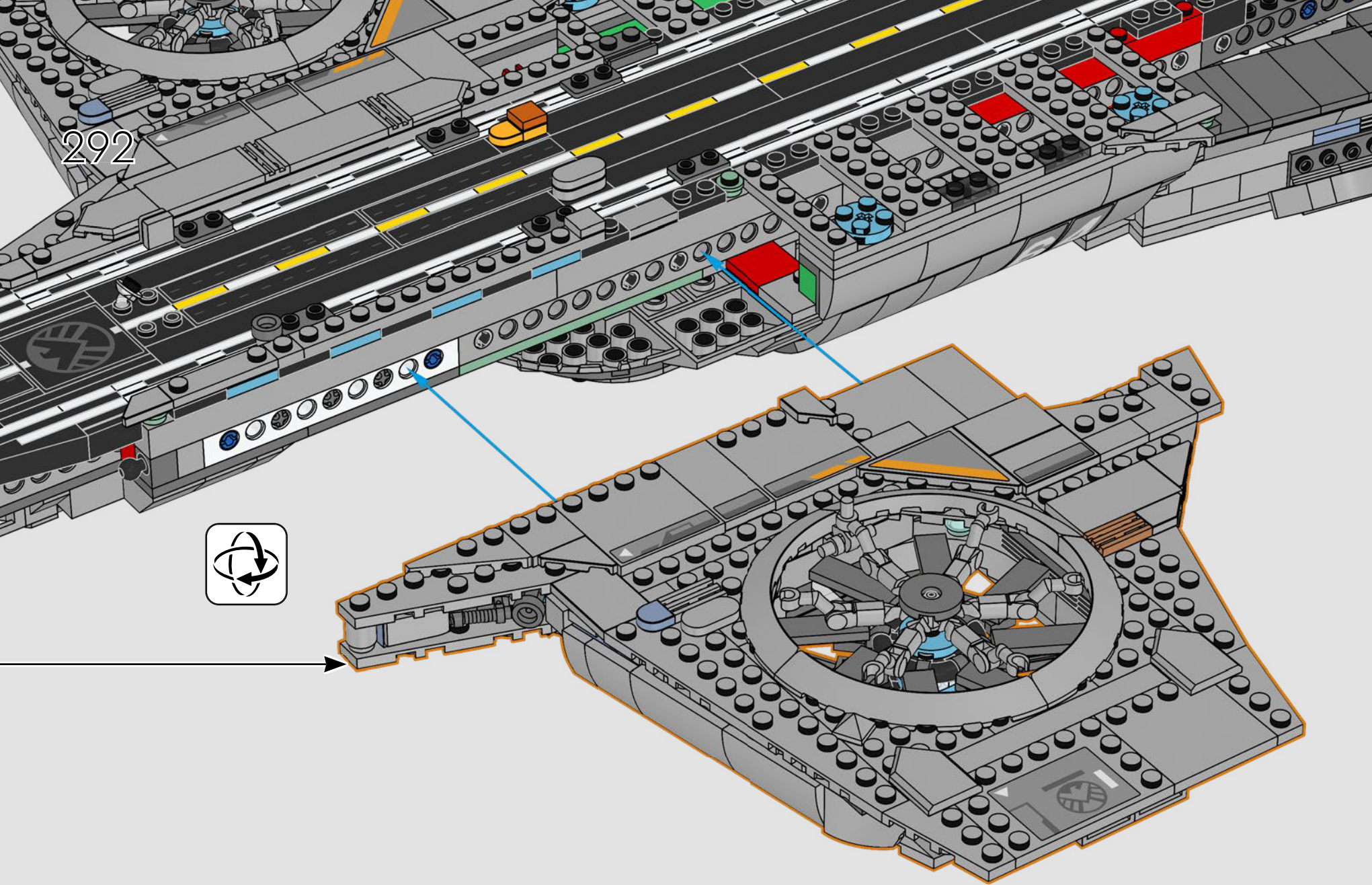

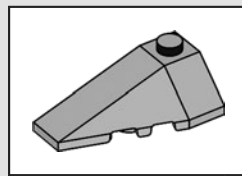
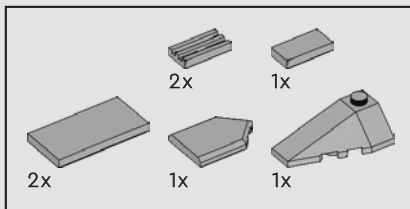

293

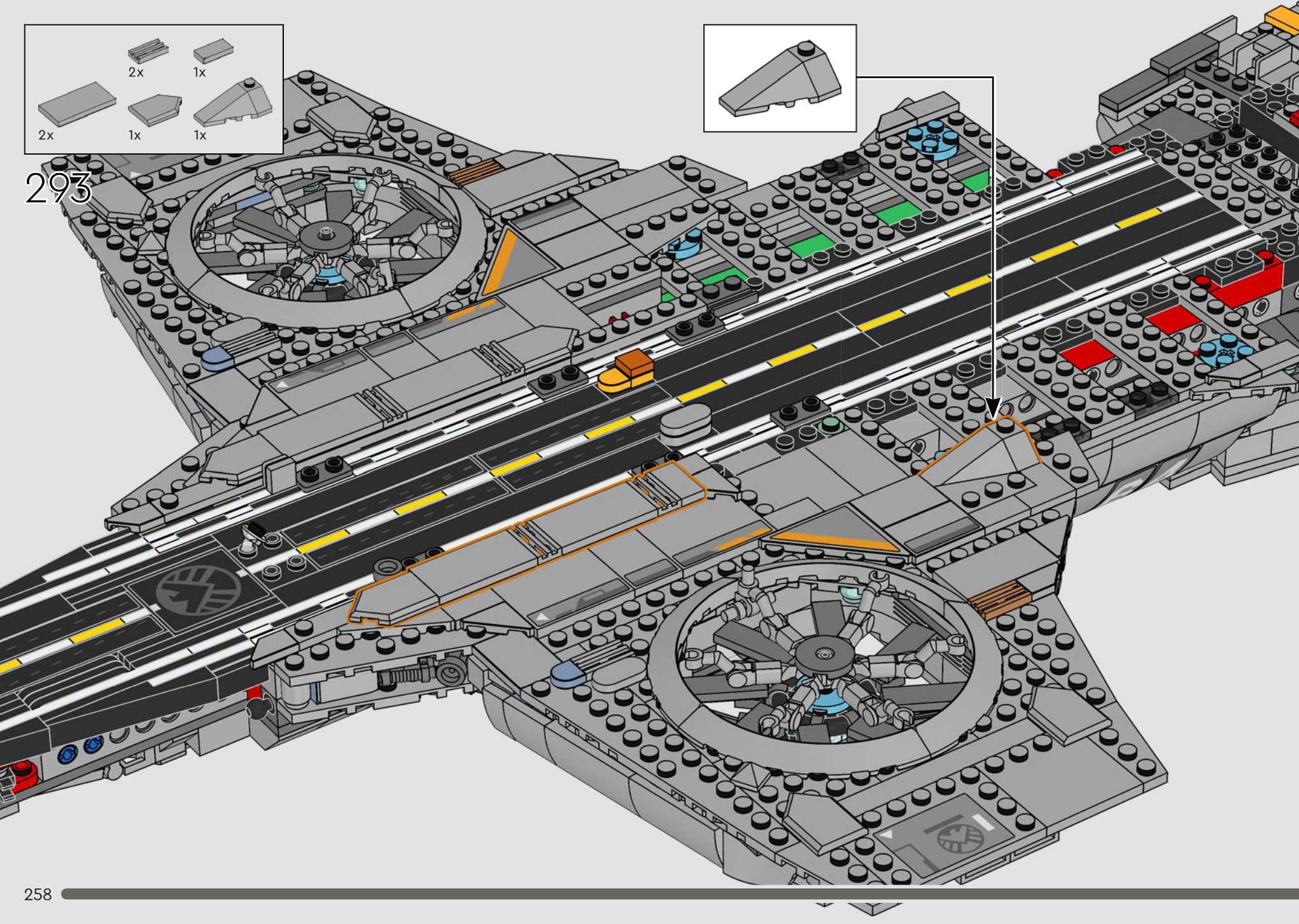

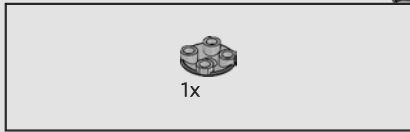

294

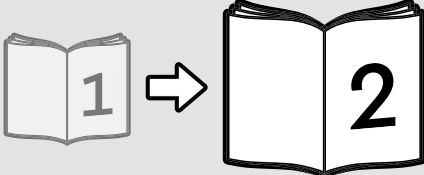
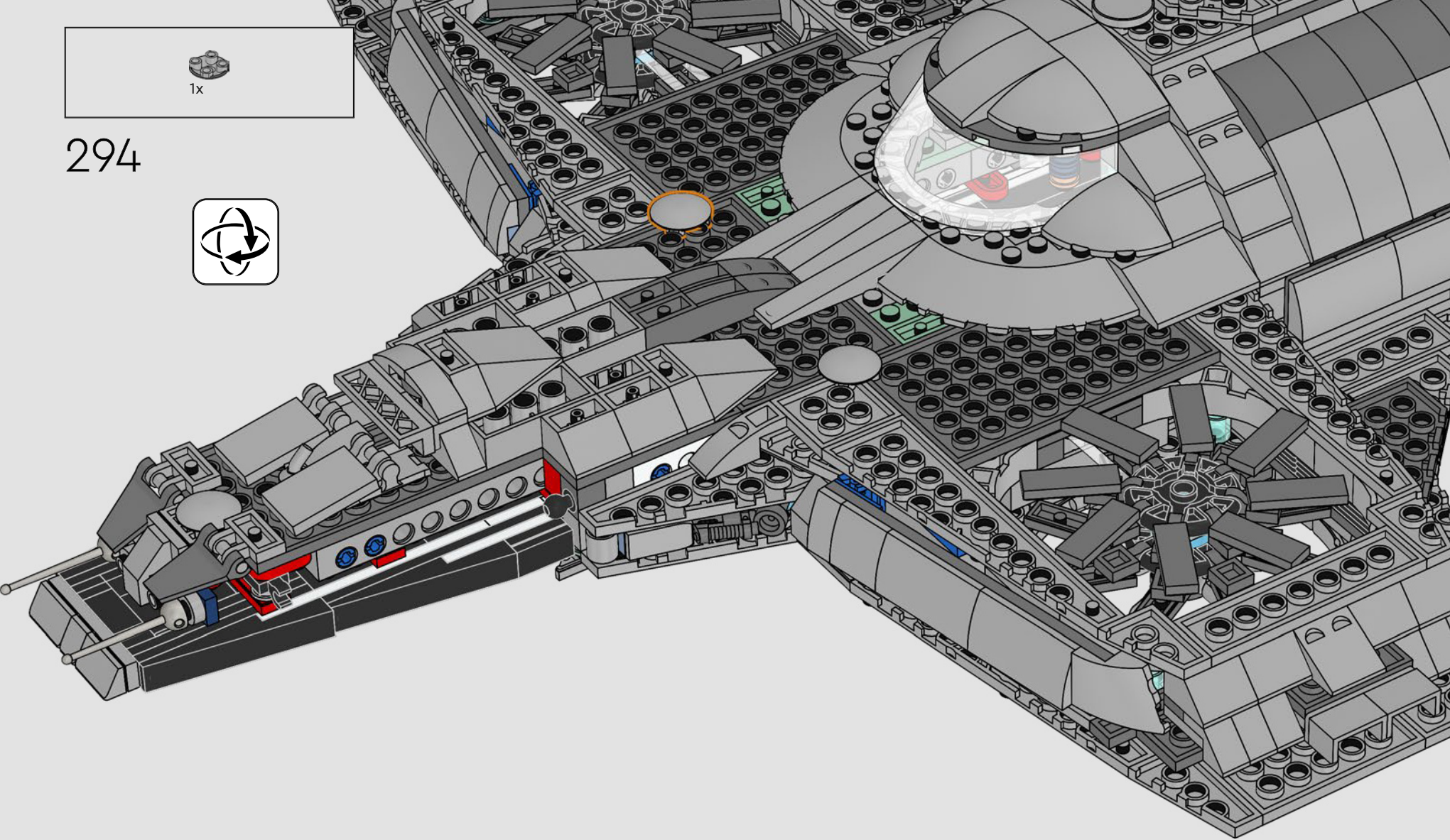



LEGO and the LEGO logo are trademarks of the/son des marques de commerce du/son marcas registradas de LEGO Group.
©2026 The LEGO Group.

© MARVEL

 6649846