



Harry Potter

76462



3

4

5



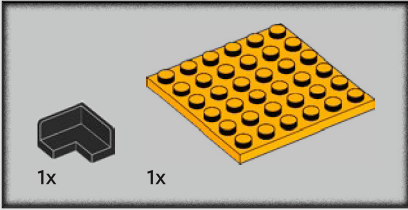
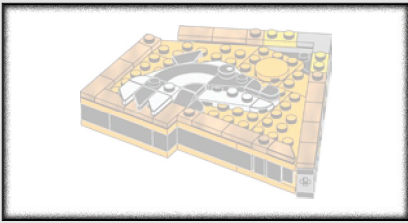

1

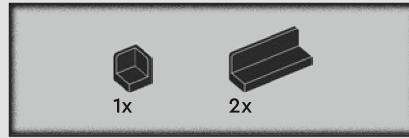
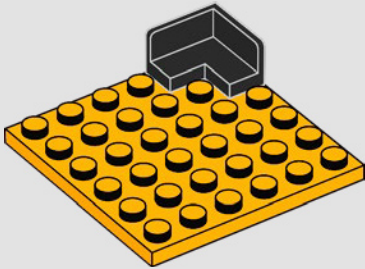

2

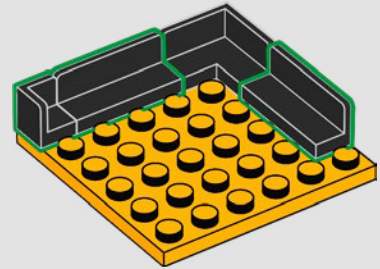

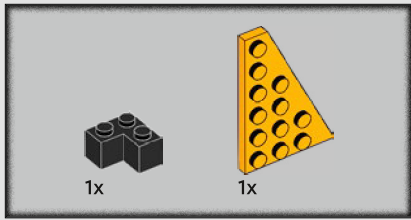

3

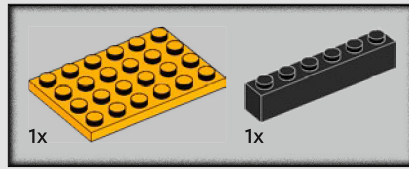
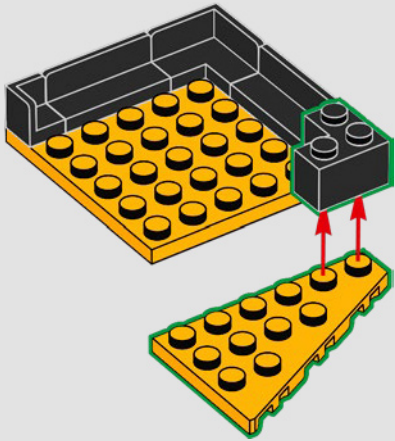

4

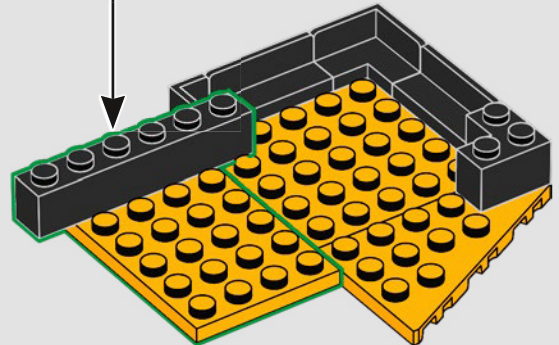
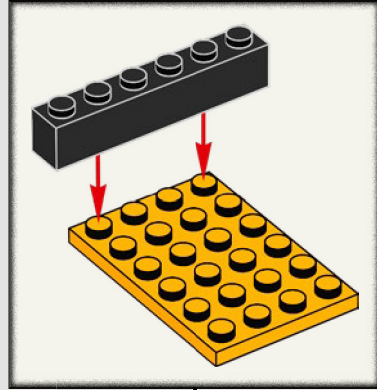

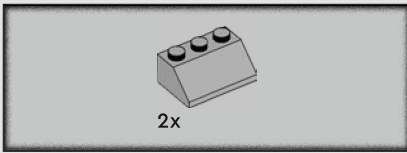

5

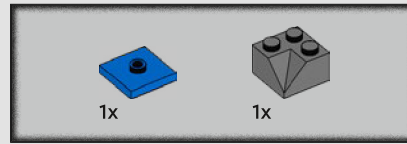
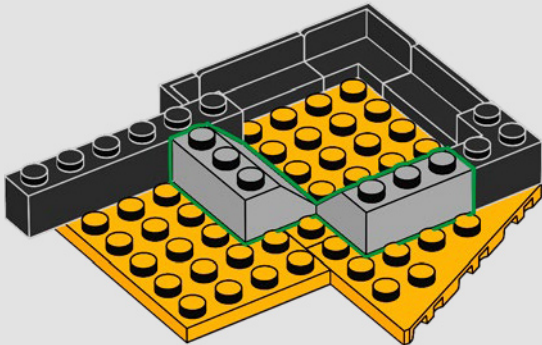

6

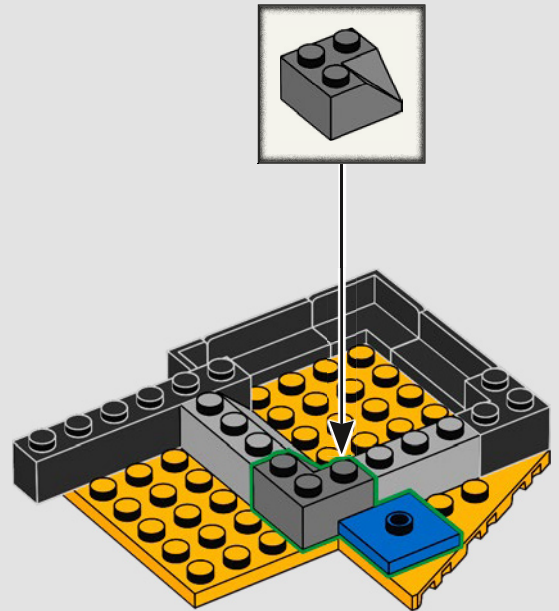

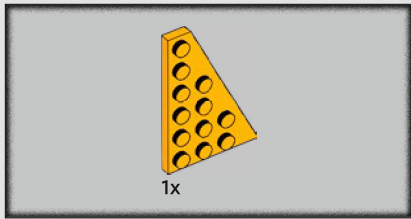

7

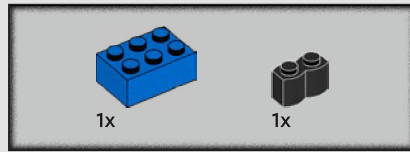
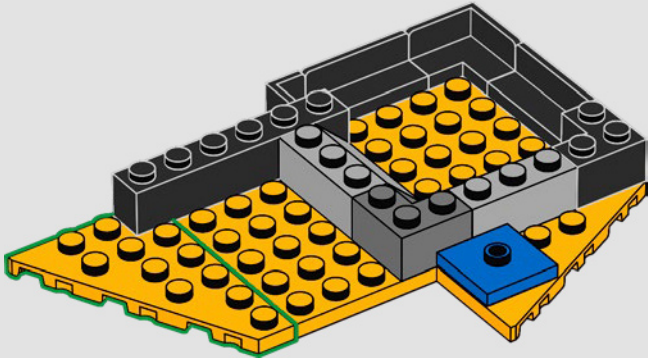

8

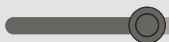
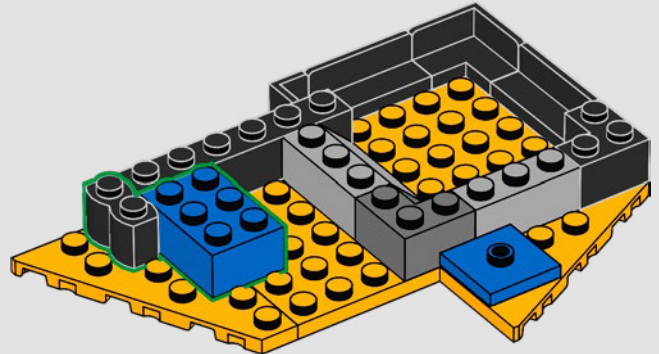

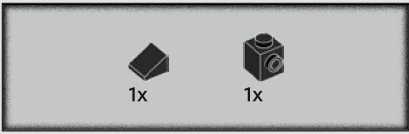

9

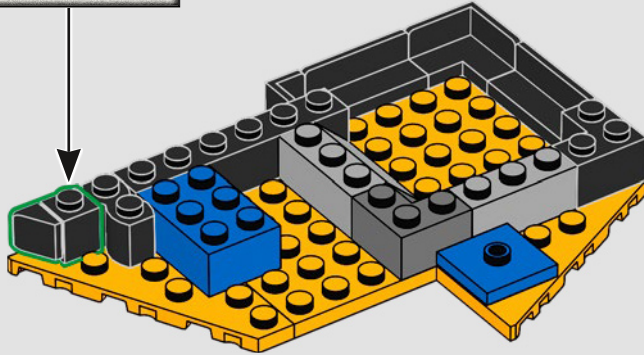
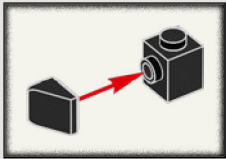

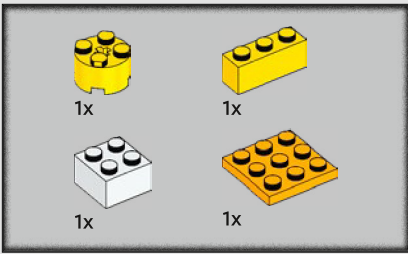

10

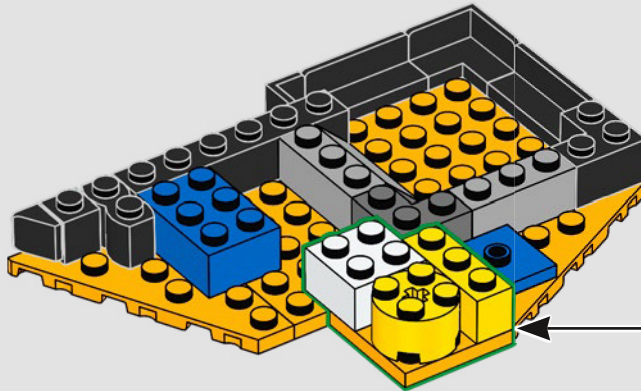
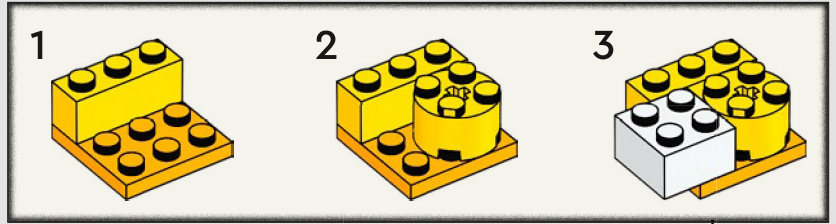

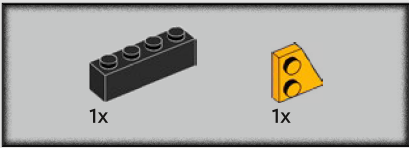

11

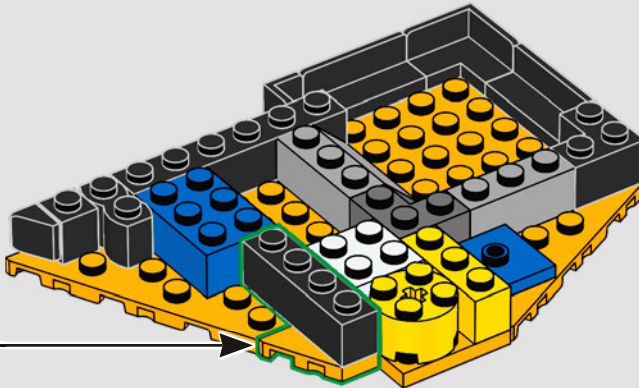
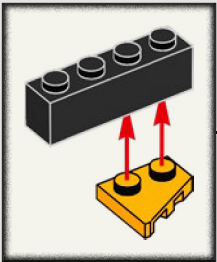

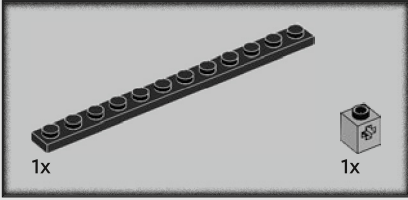
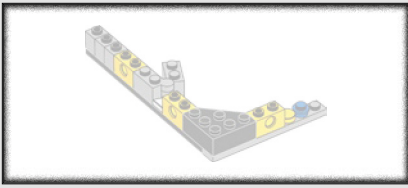

12

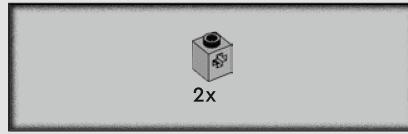
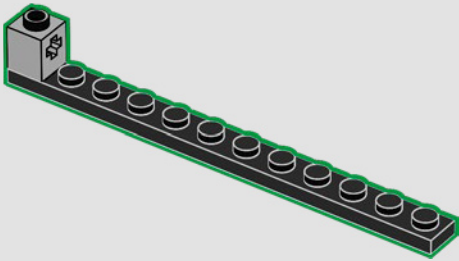

13

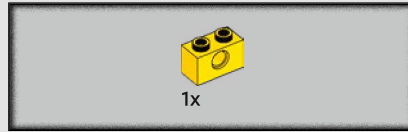
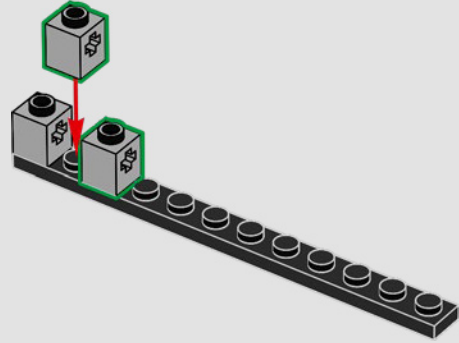

14

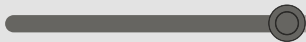
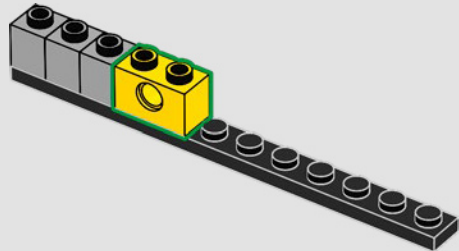

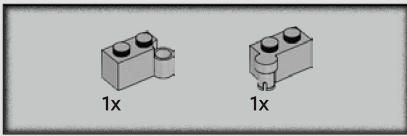

15

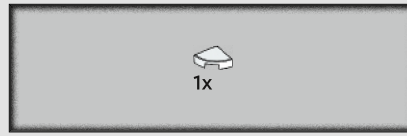
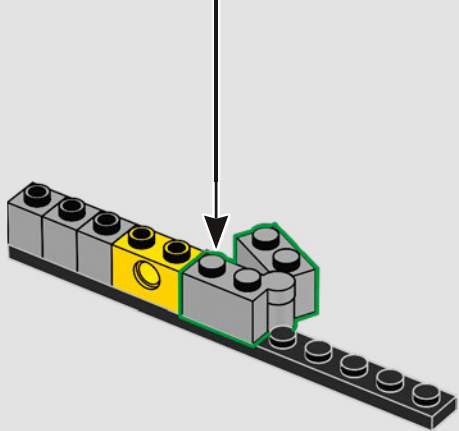
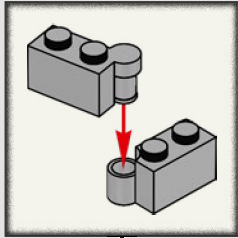

16

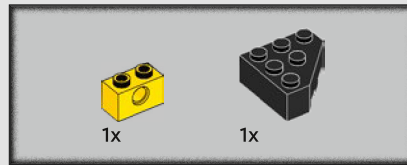
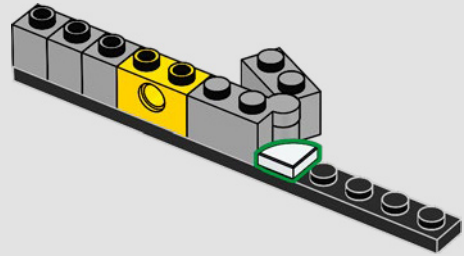

17

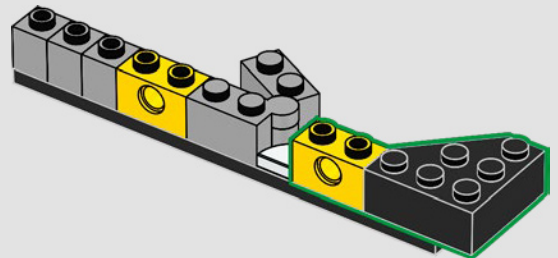

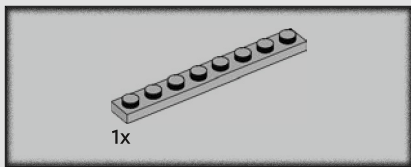

18

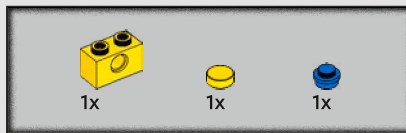
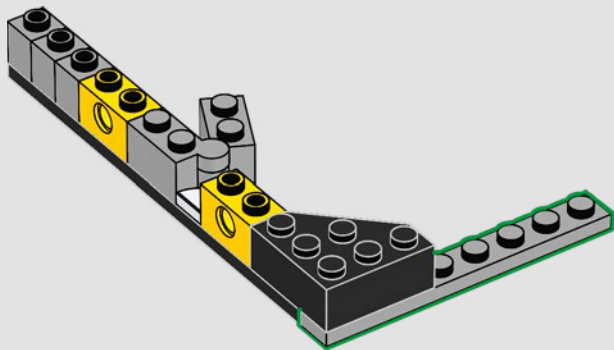

19

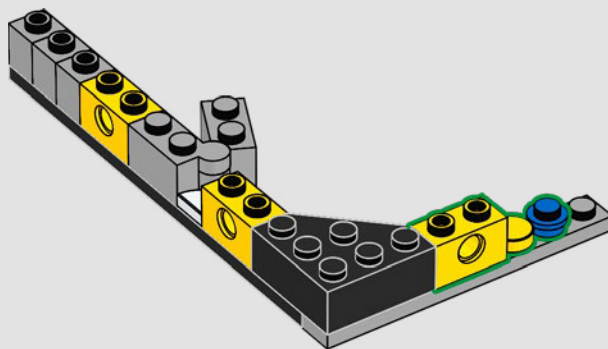

20

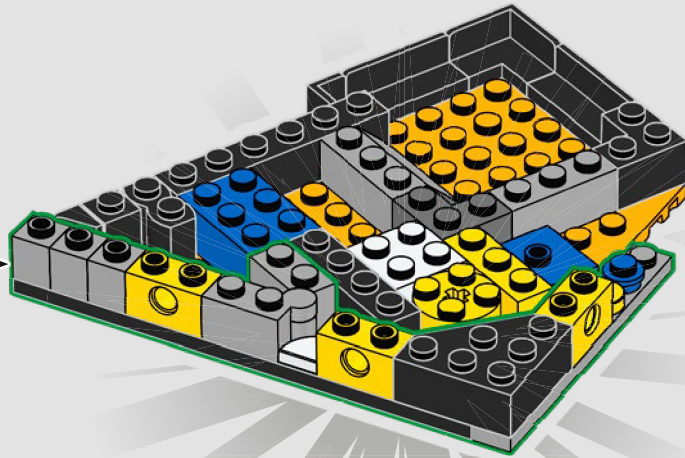

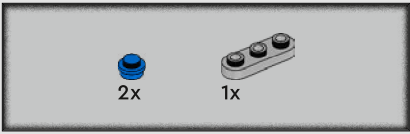

21

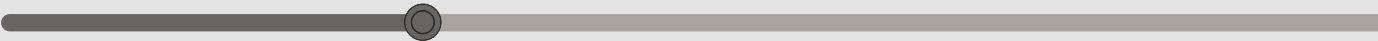
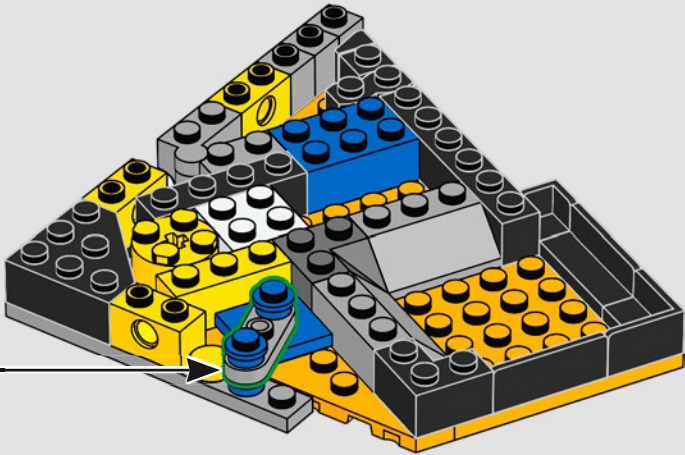
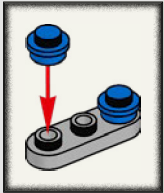

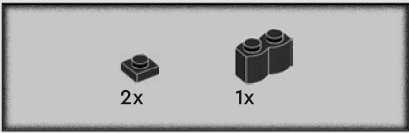

22

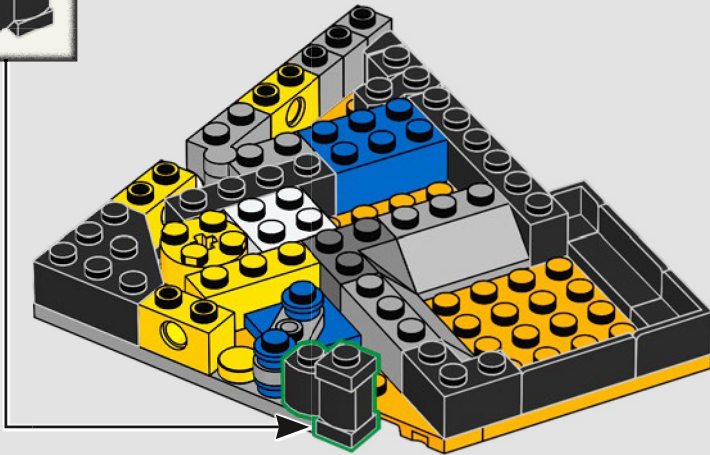
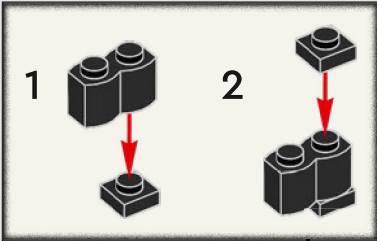

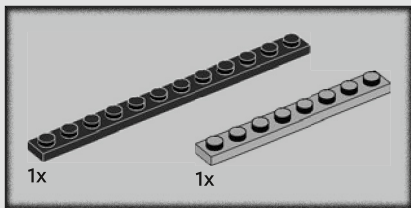

23

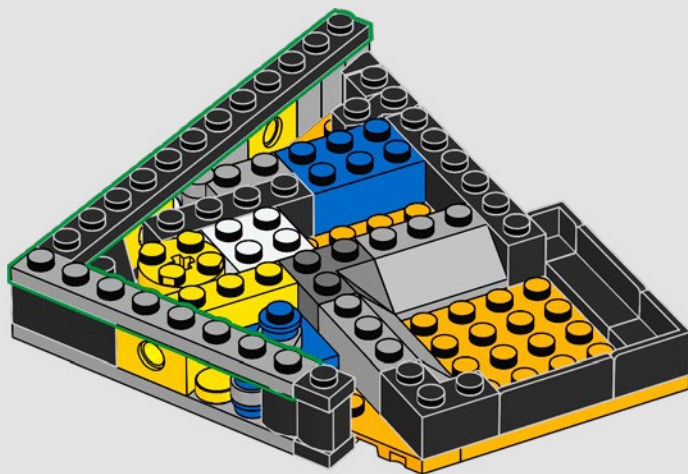

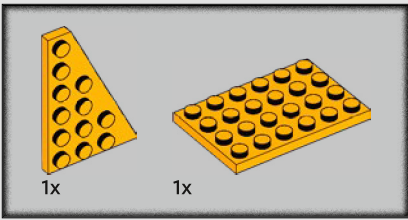

24

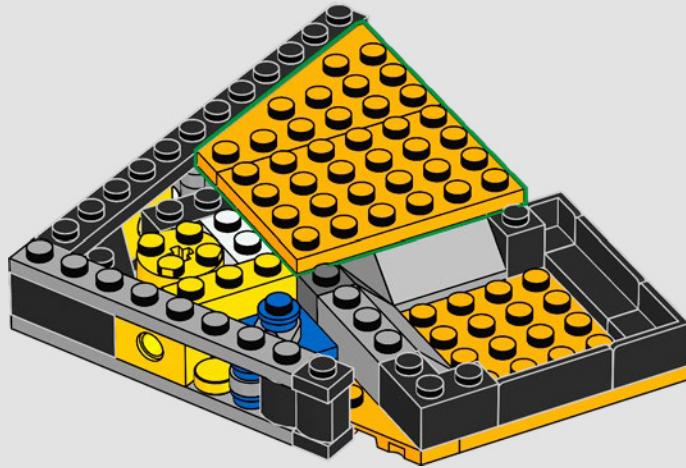

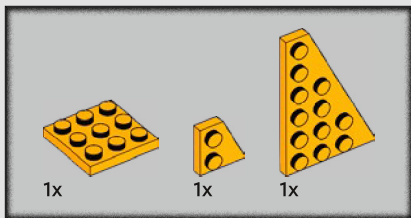

25

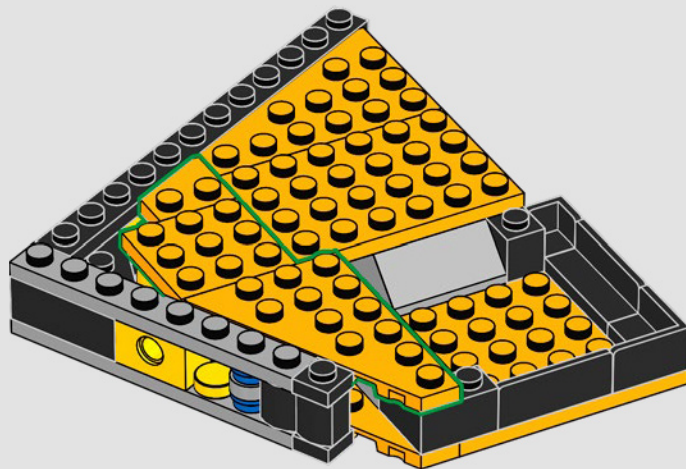

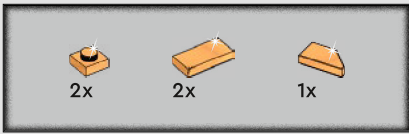

26

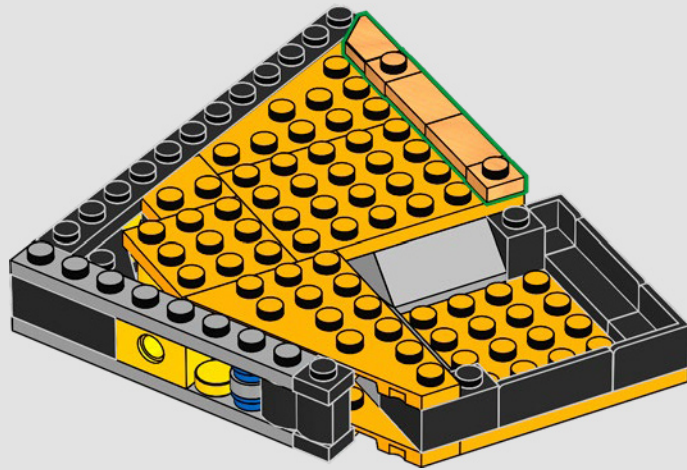

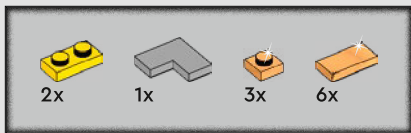

27

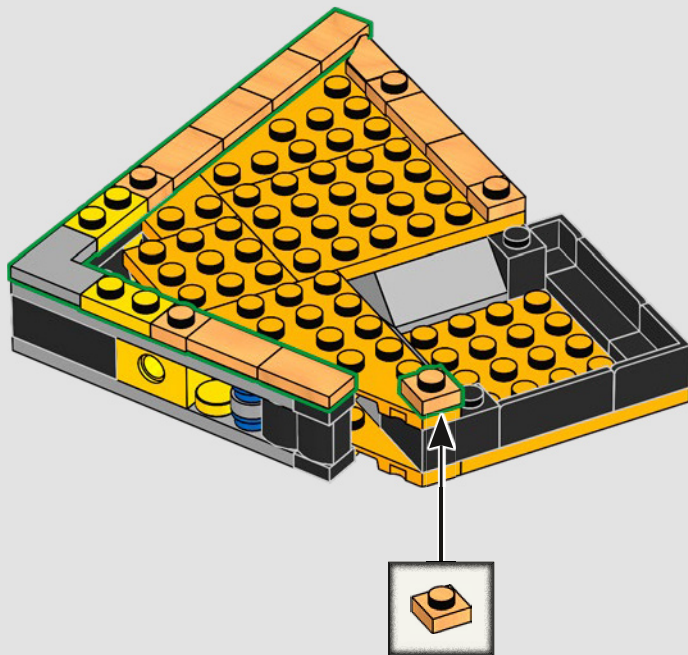

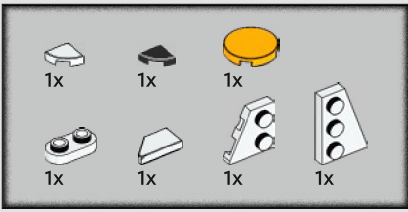

28

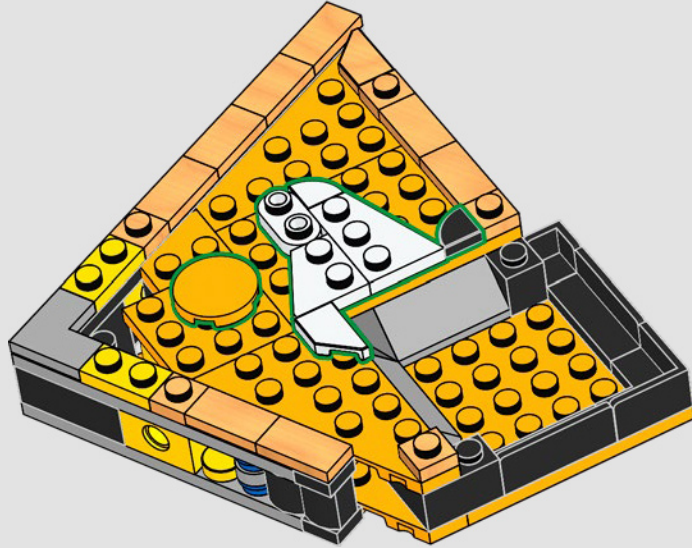



29

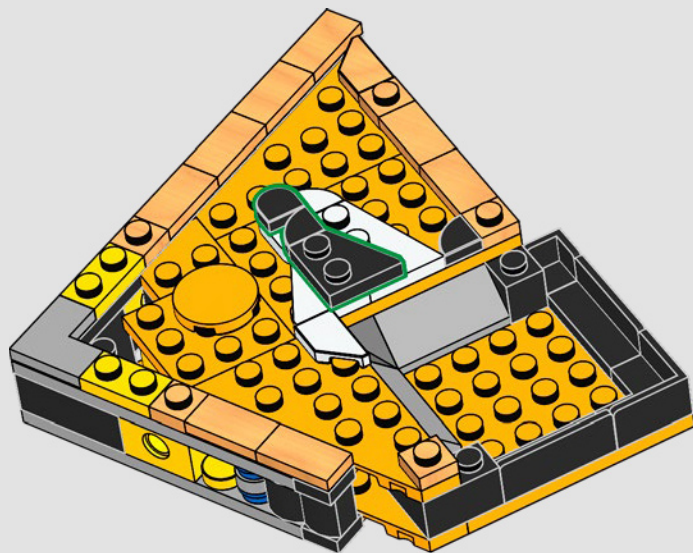



1x

30

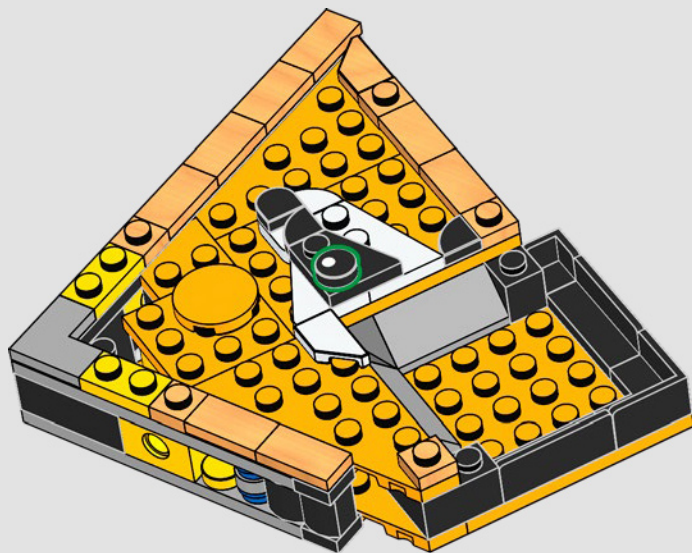

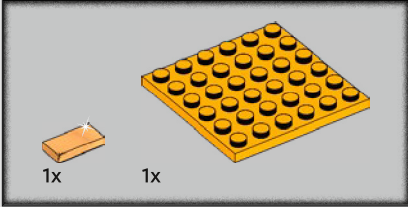
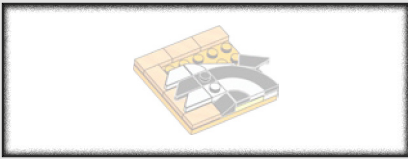

31

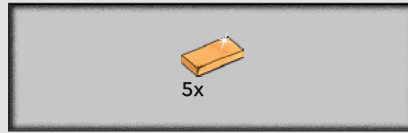
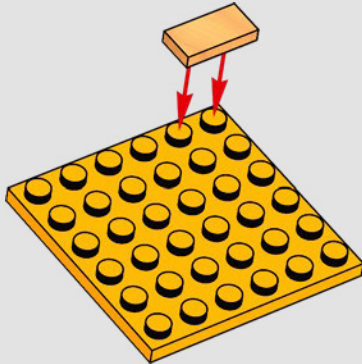

32

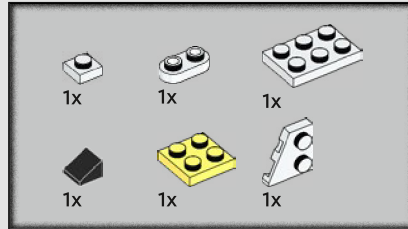
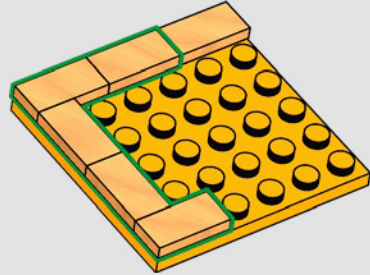

33

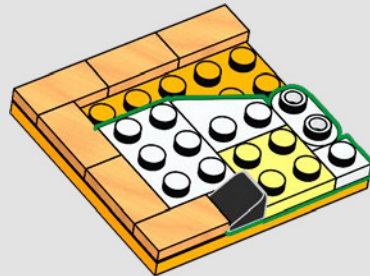

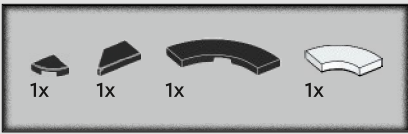

34

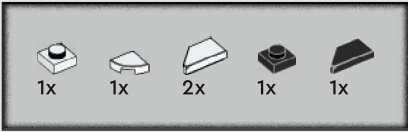
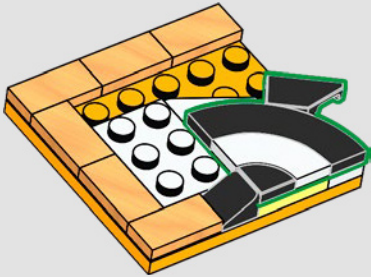

35



36

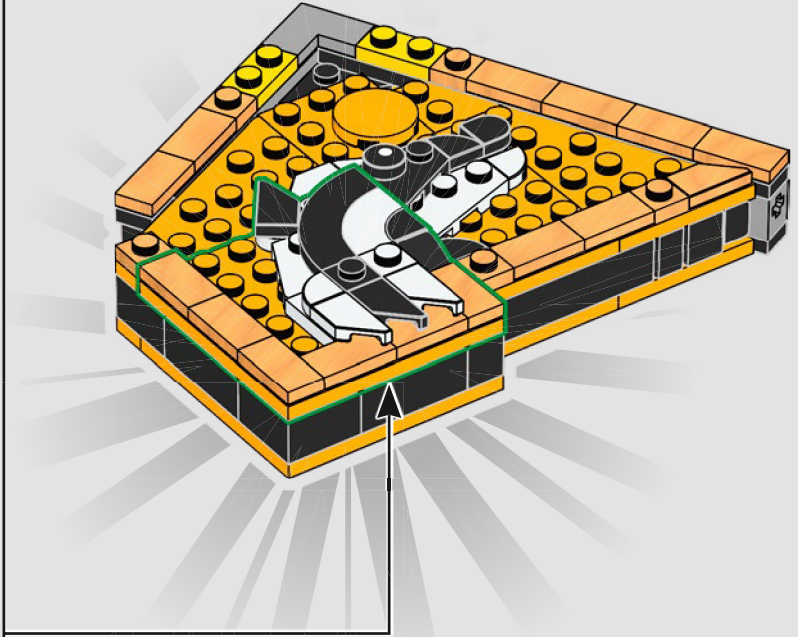
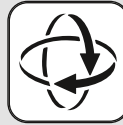



37

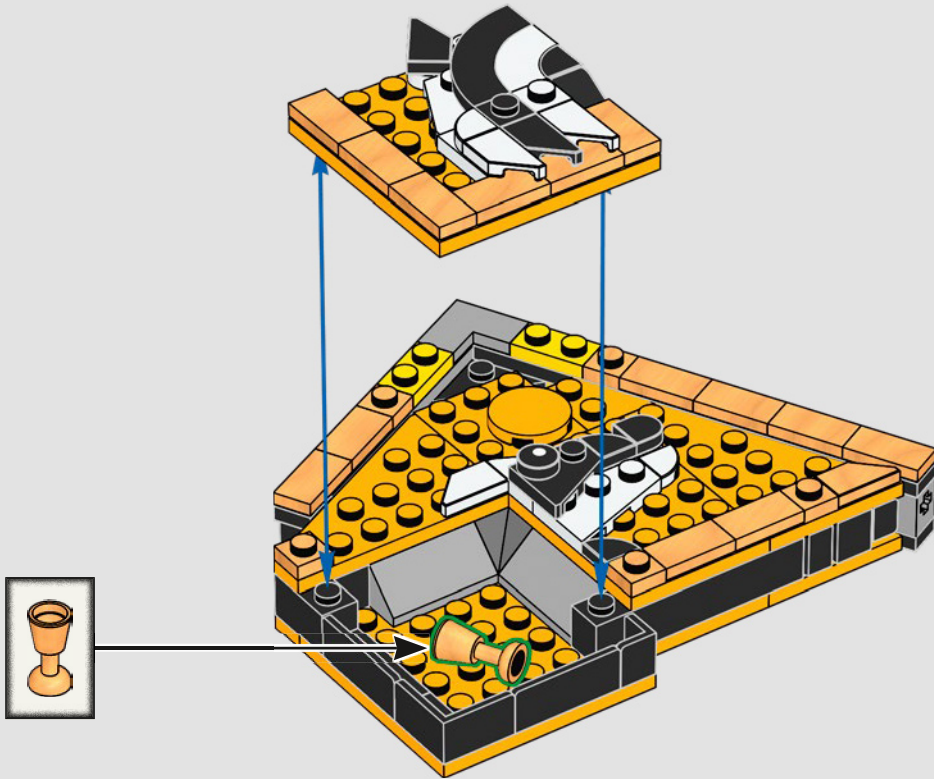

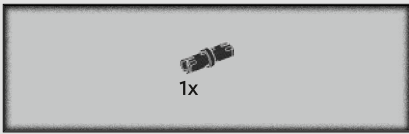

38

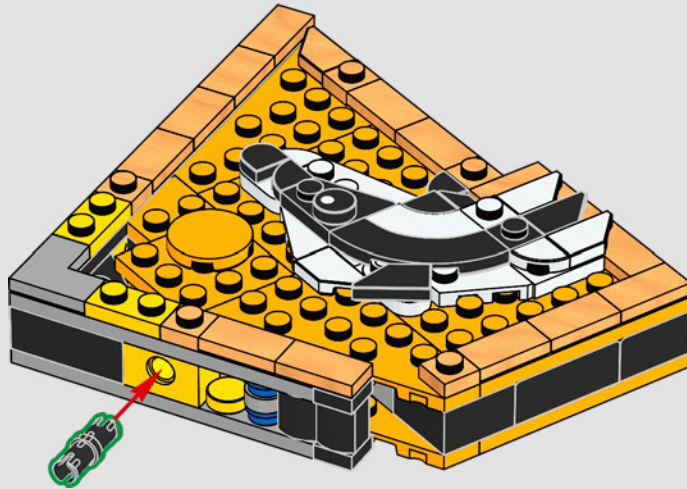



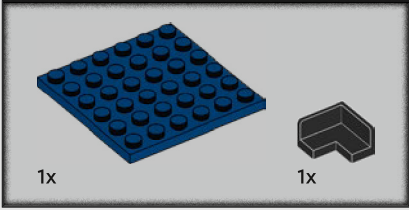
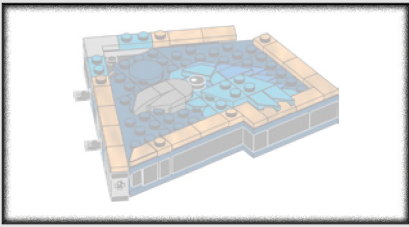

1

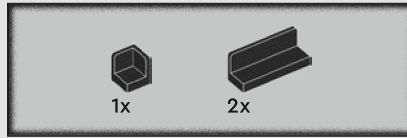
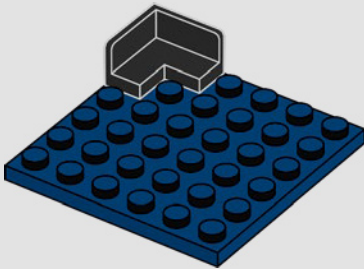

2

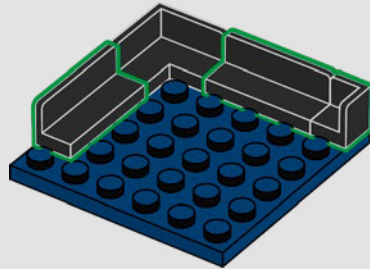

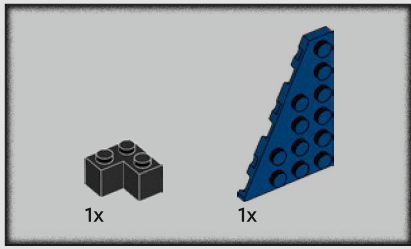

3

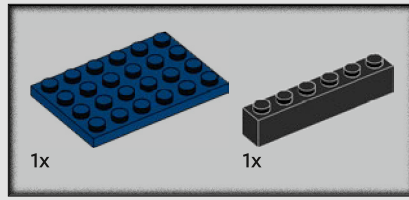
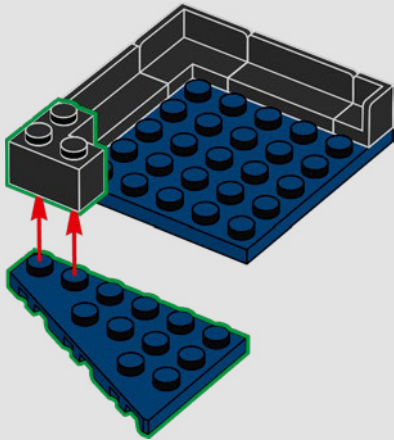

4

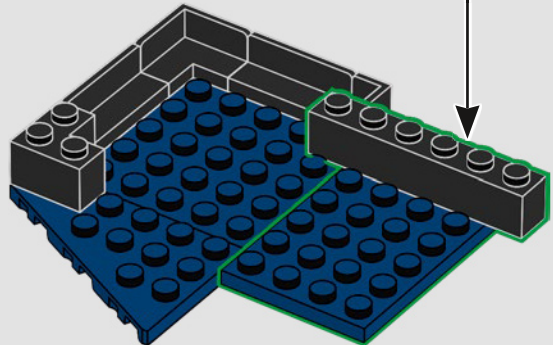
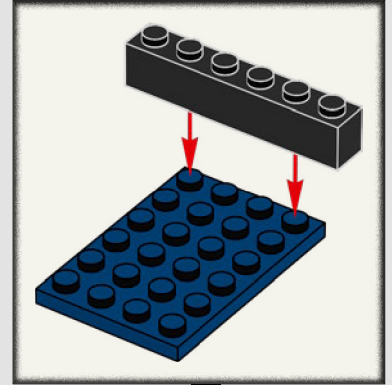

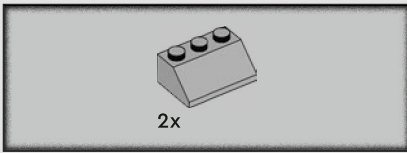

5

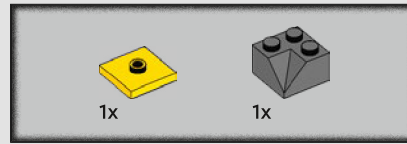
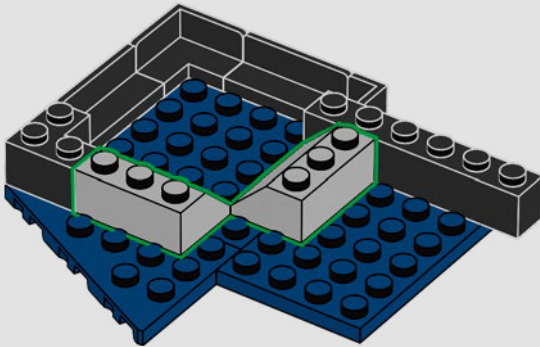

6

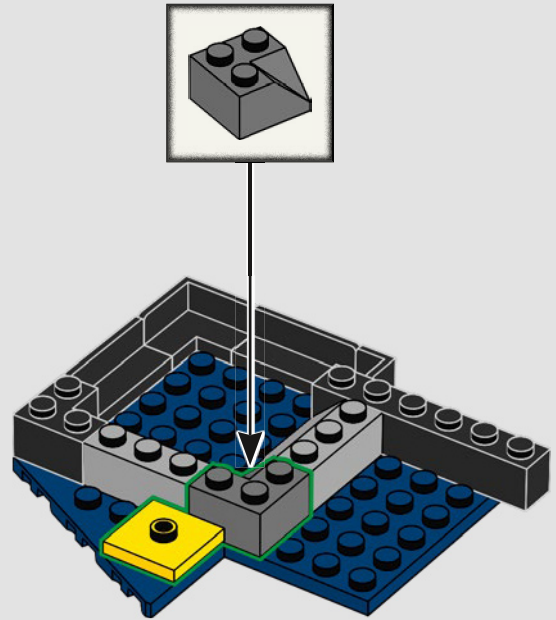

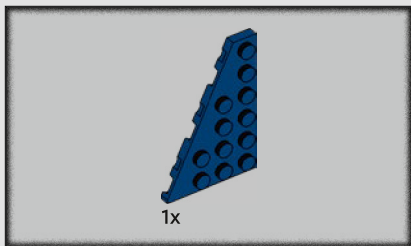

7

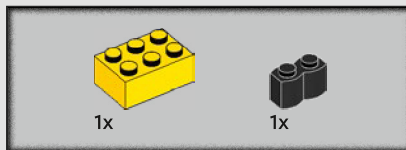
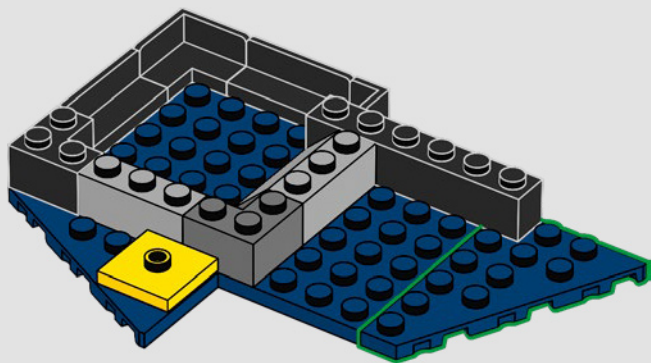

8

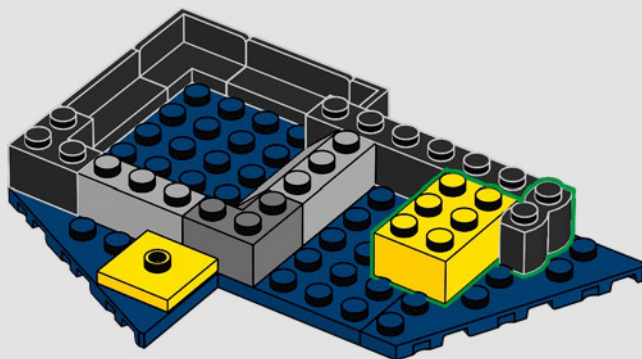

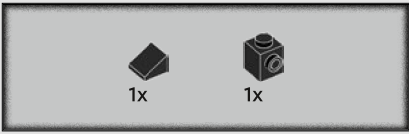

9

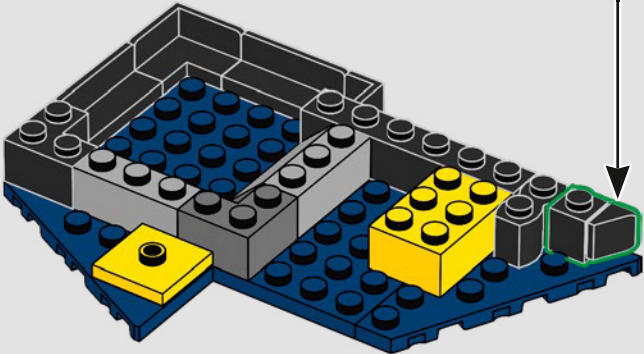
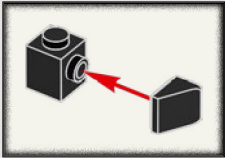

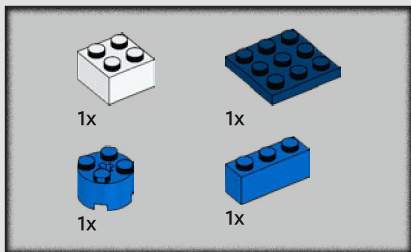

10

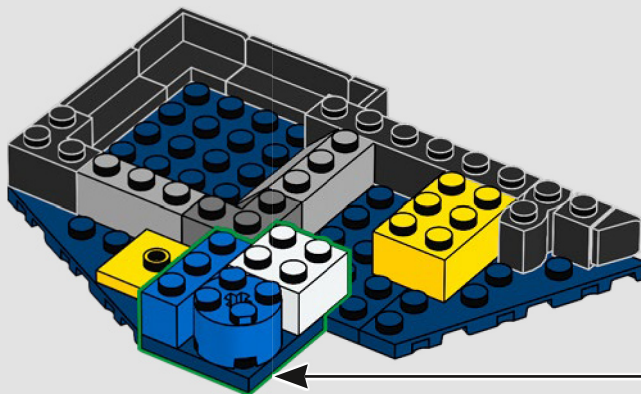
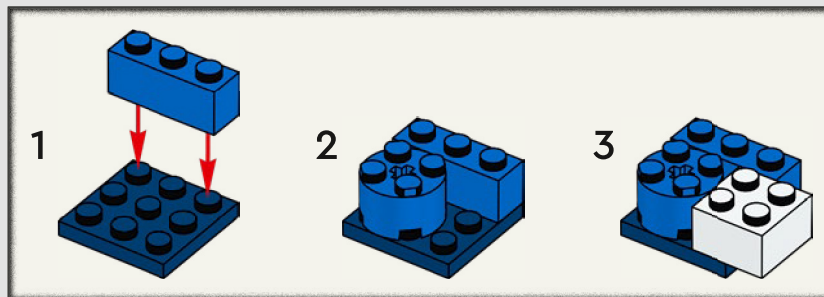

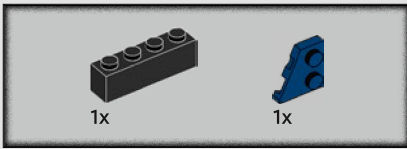

11

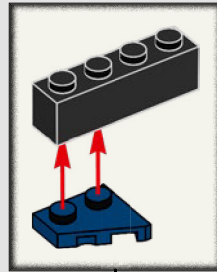
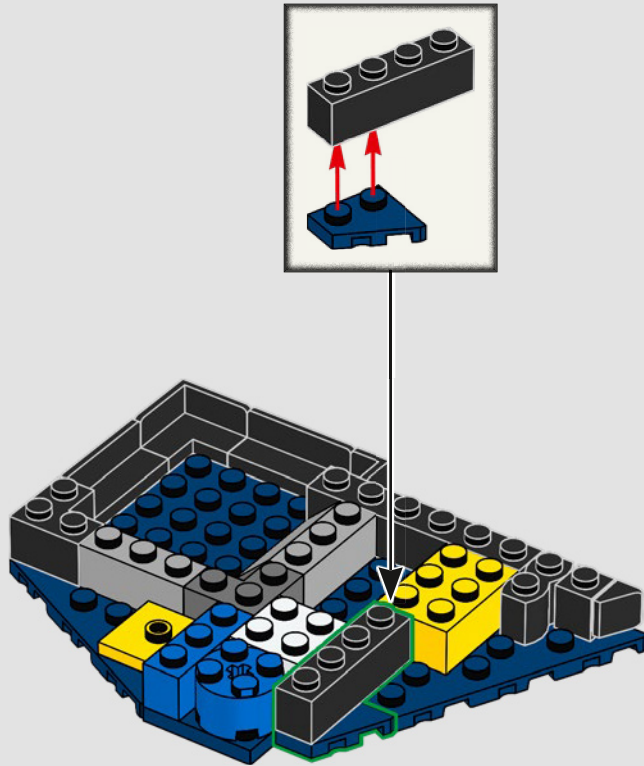

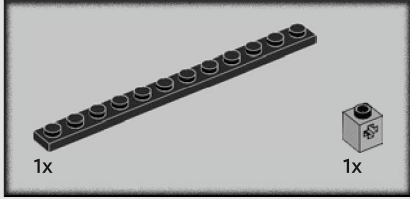
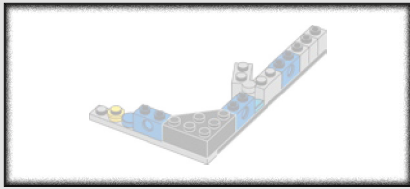

12

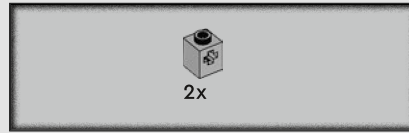
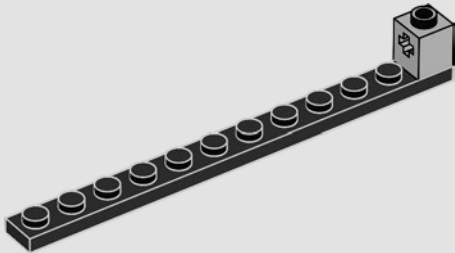

13

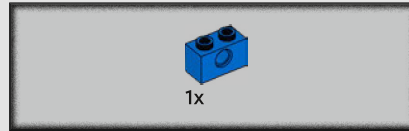
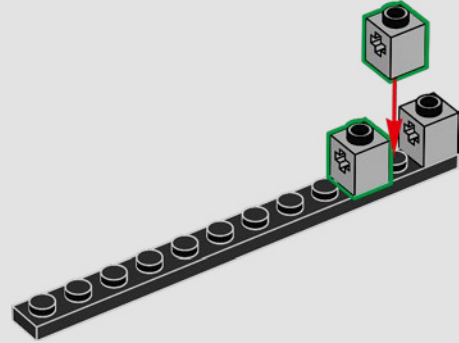

14

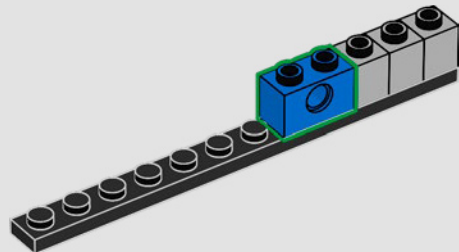

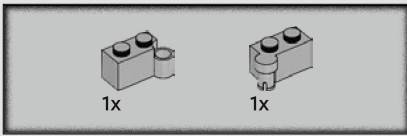

15

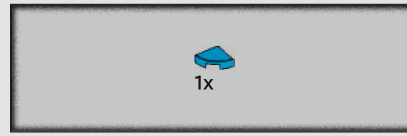
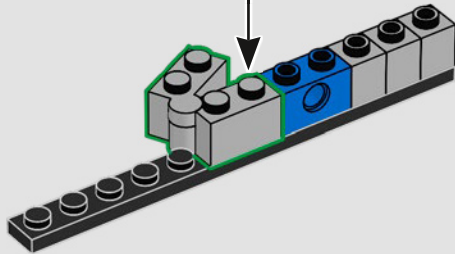
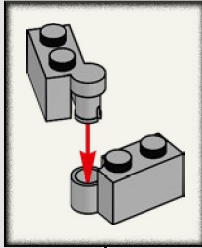

16

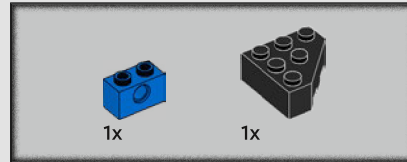
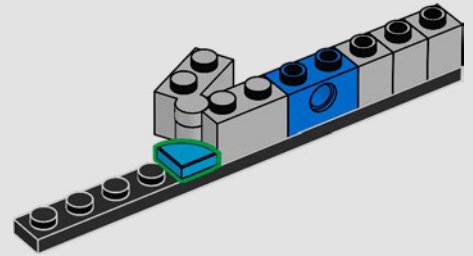

17

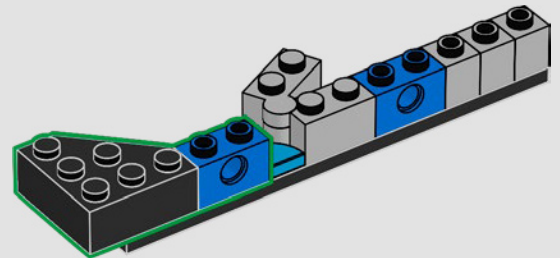

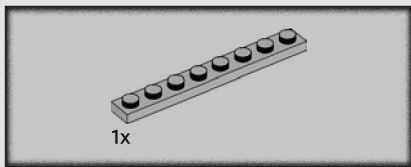

18

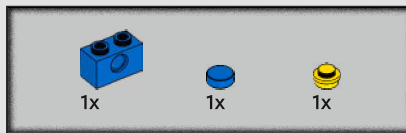
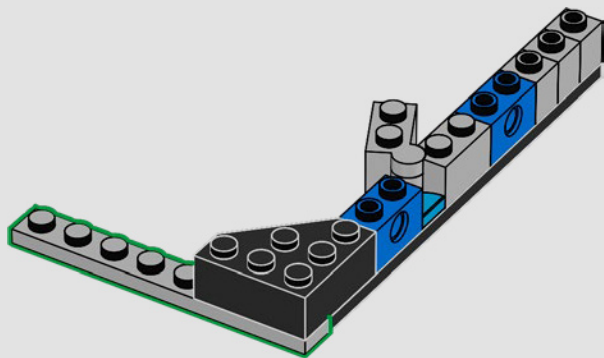

19

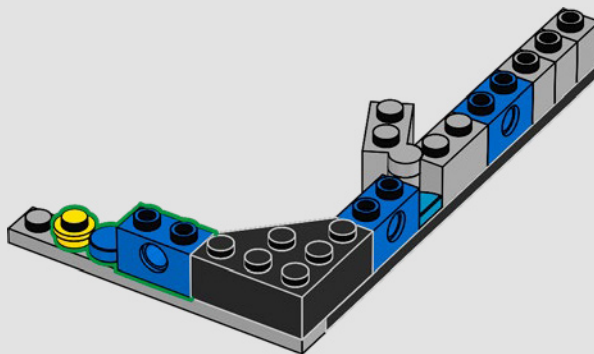

20

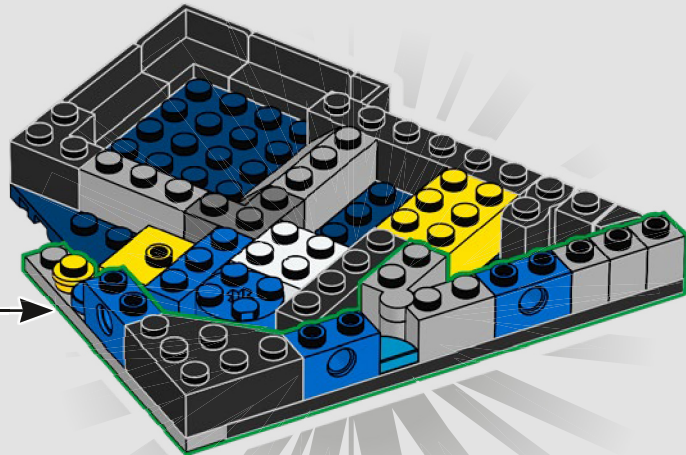

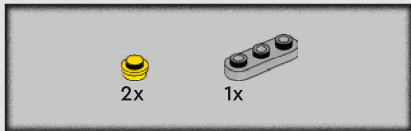

21

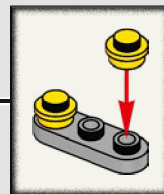
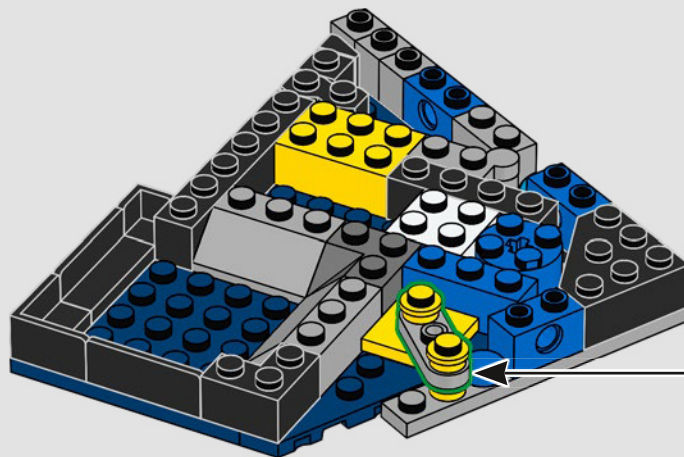

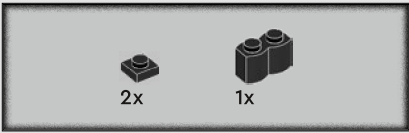

22

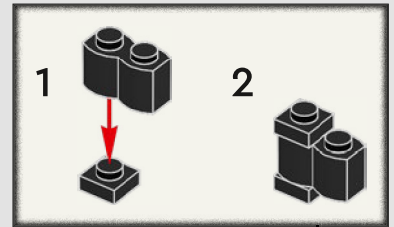
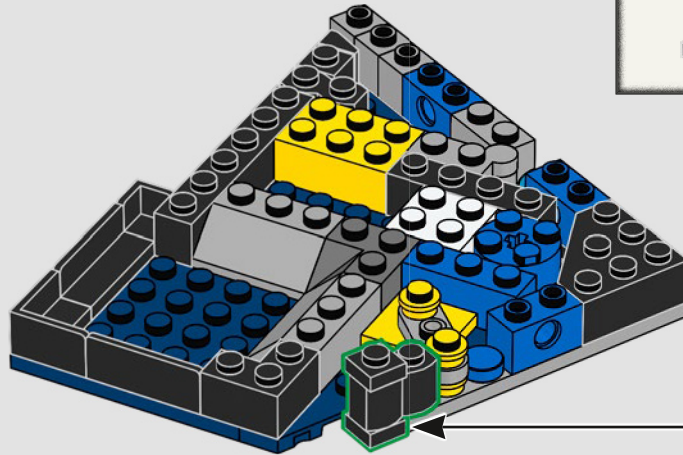

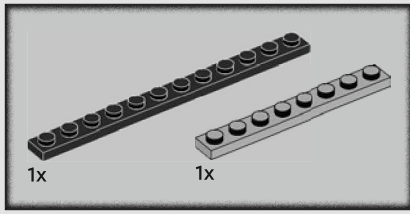

23

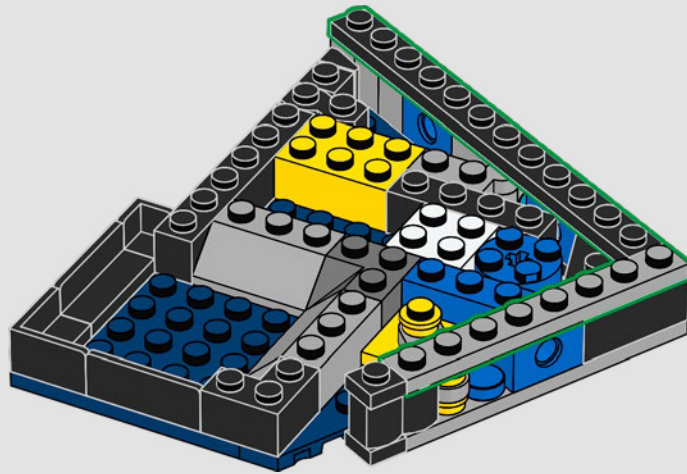

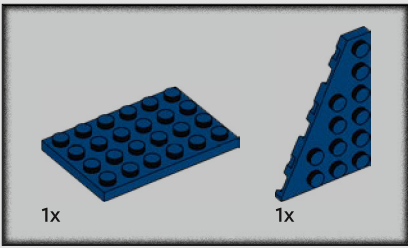

24

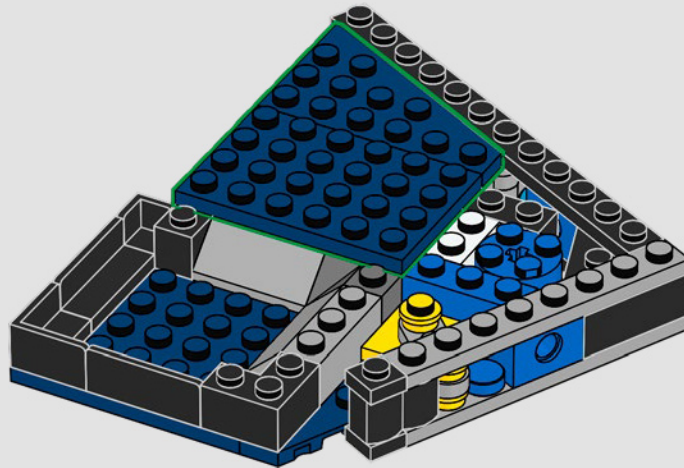

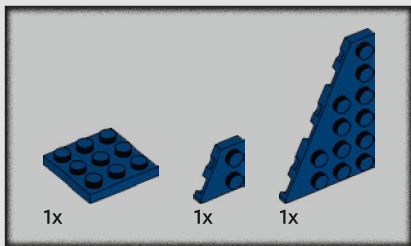

25

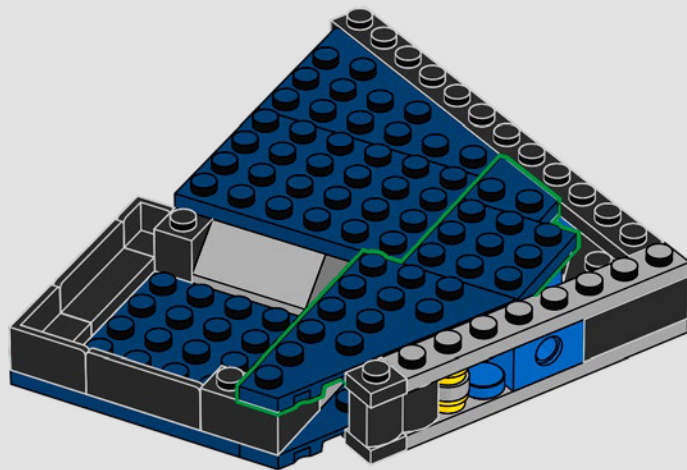

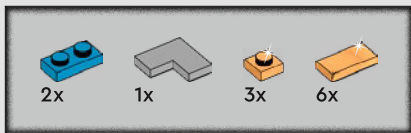

27

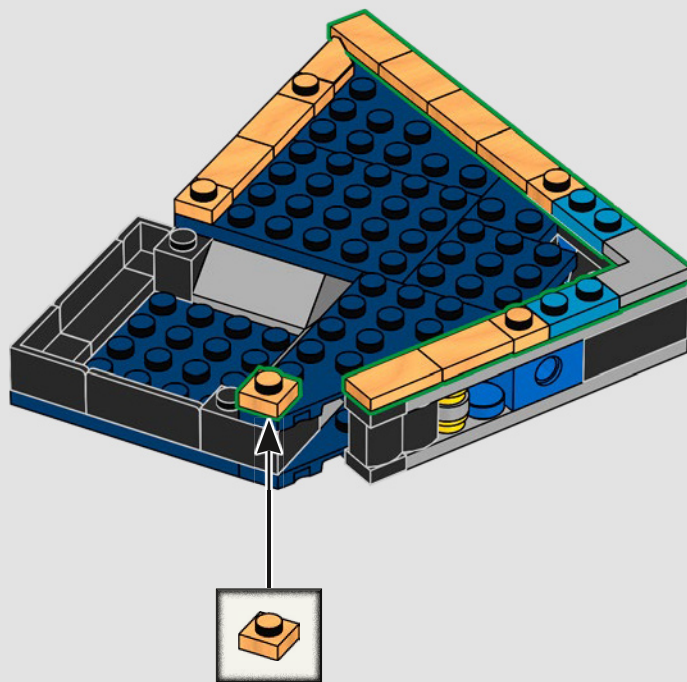

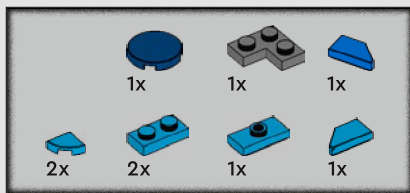

28

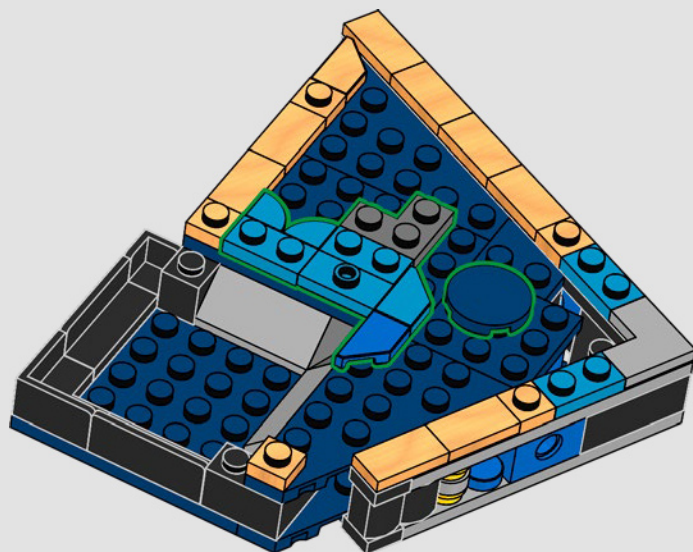

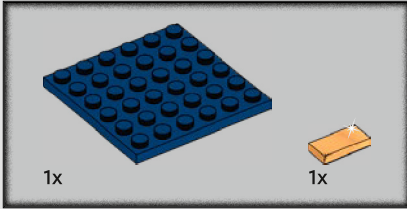
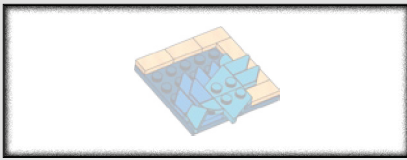

30

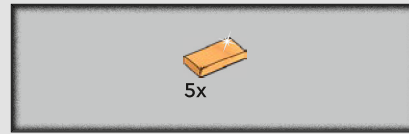
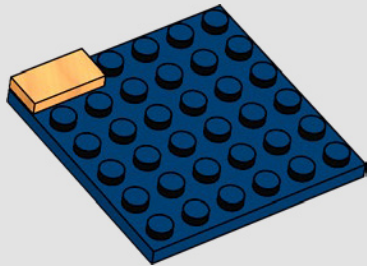

31

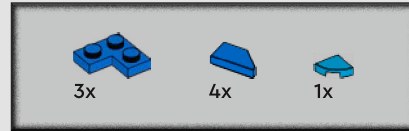
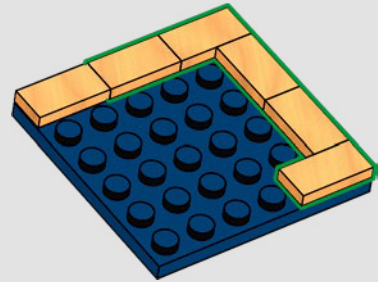

32

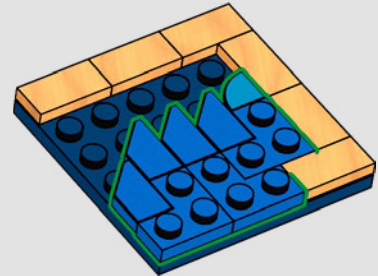

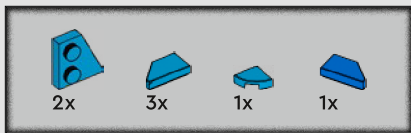

33

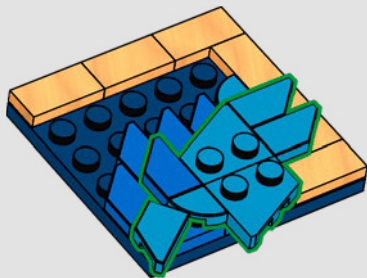

34

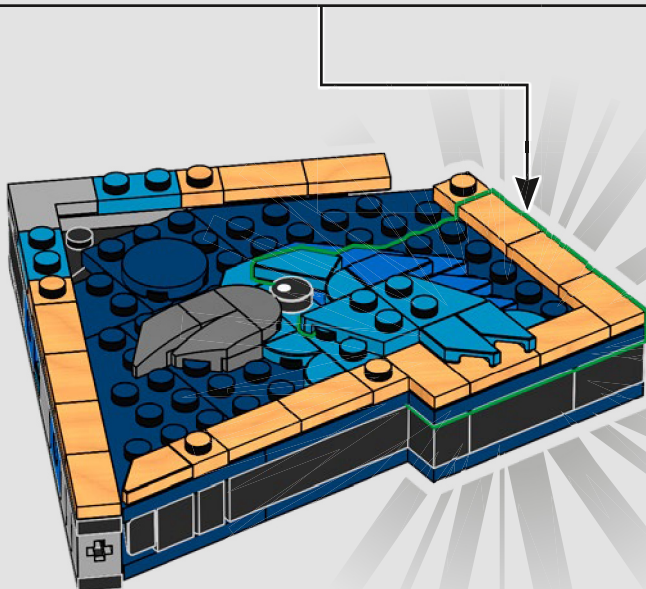

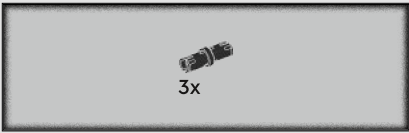

35

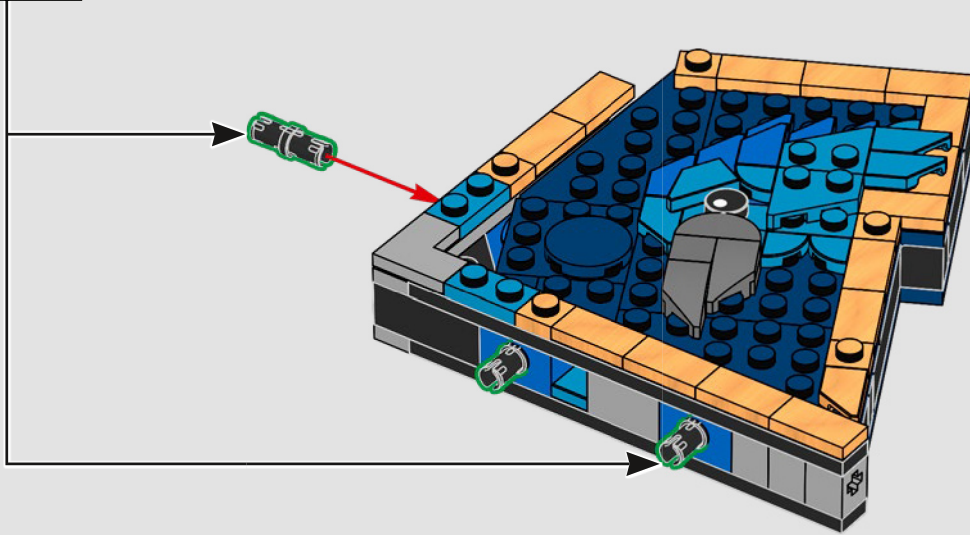



36

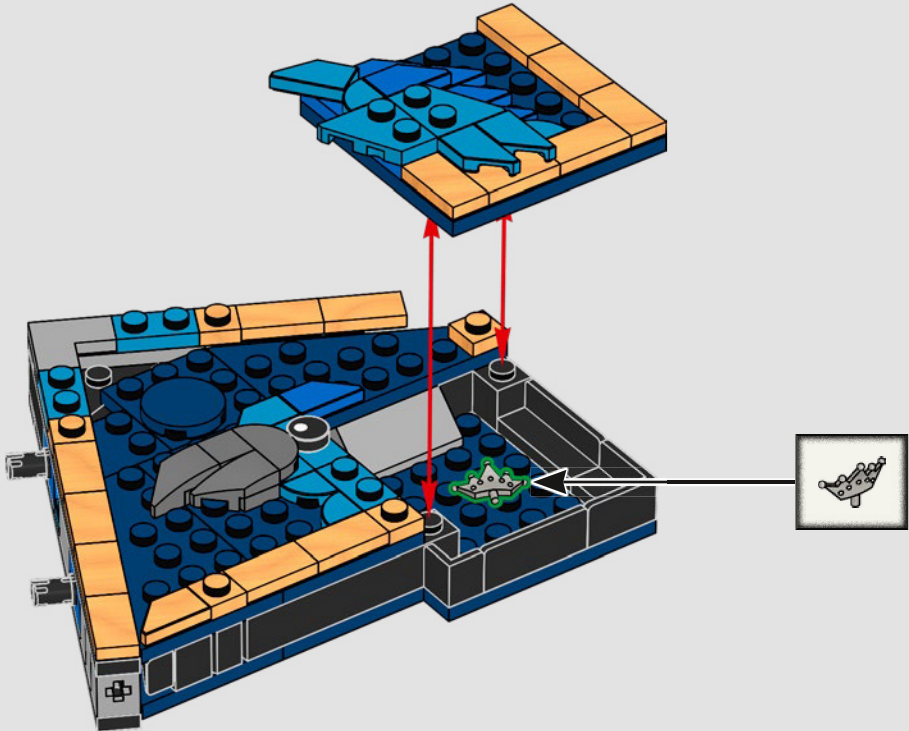

37

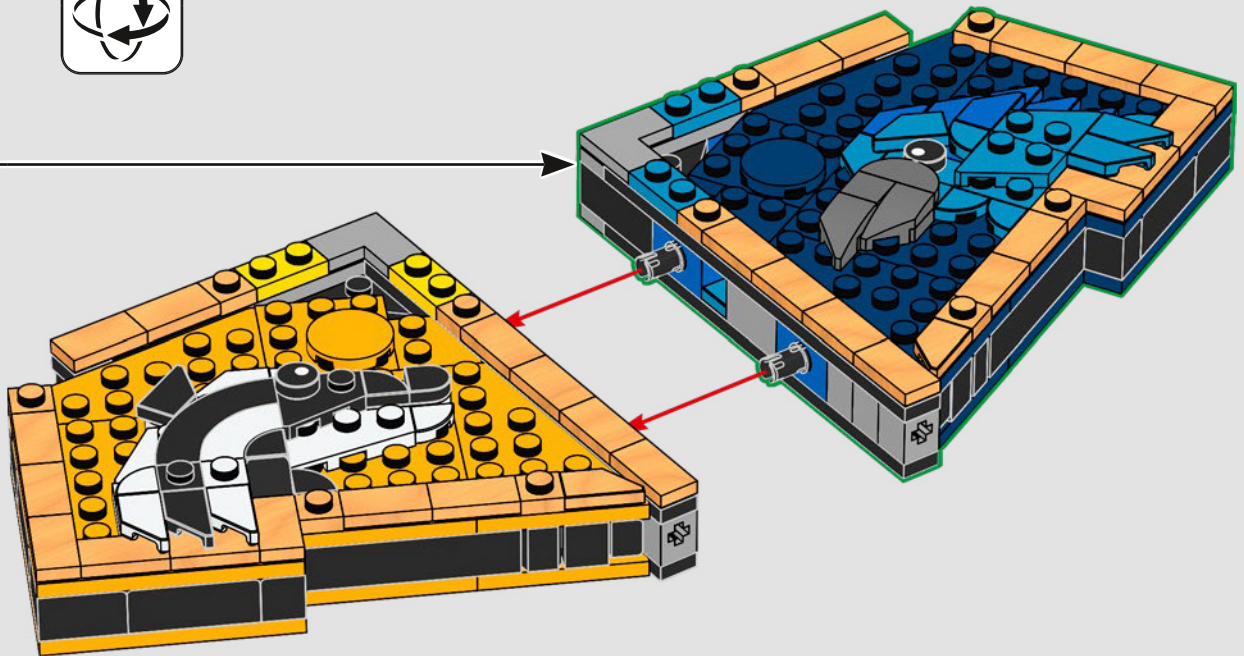

38

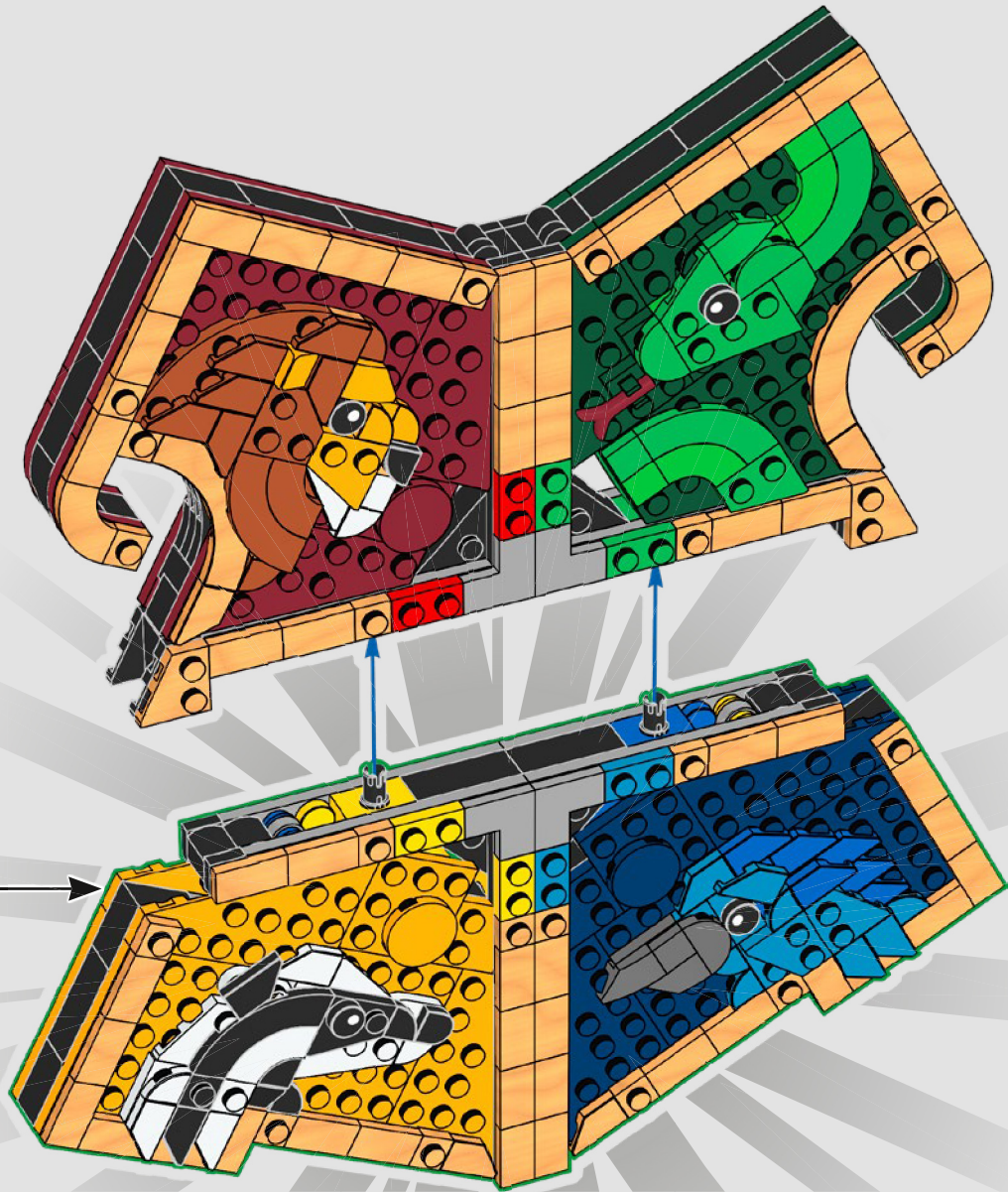



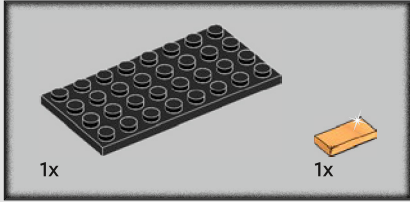
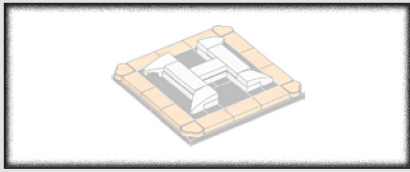

1

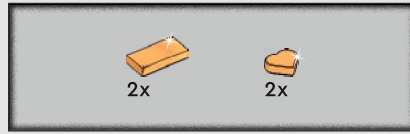
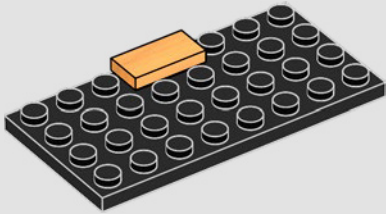

2

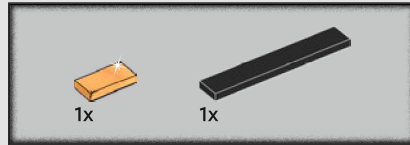
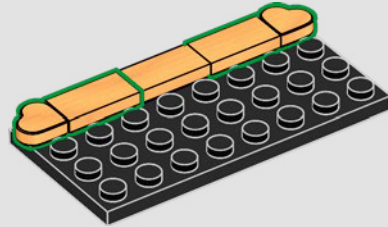

3

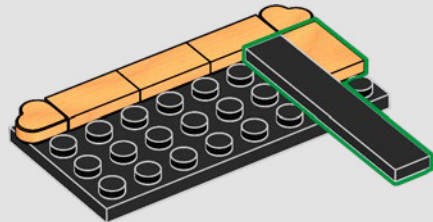

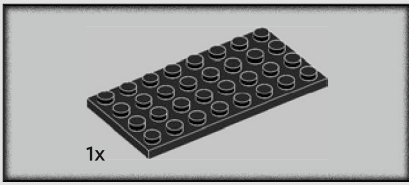

4

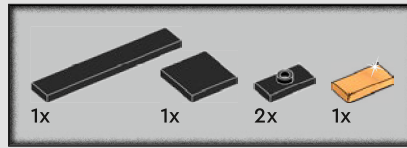
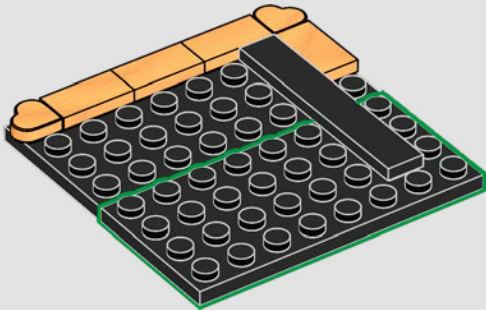

5

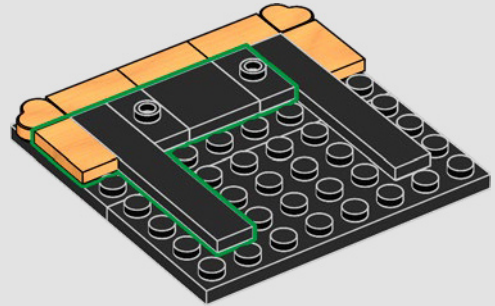

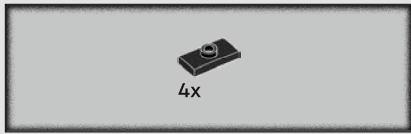

6

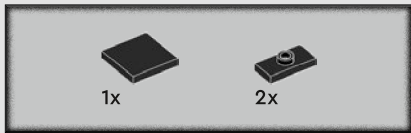
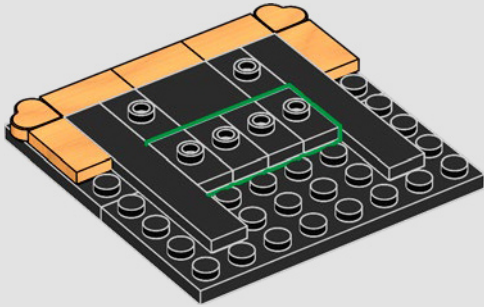

7

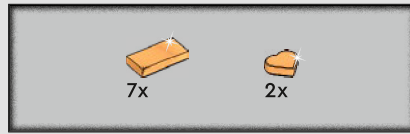
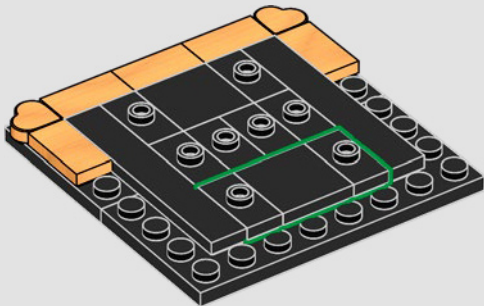

8

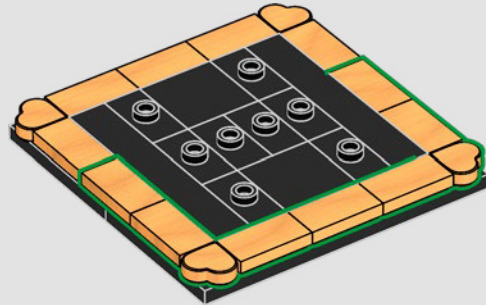

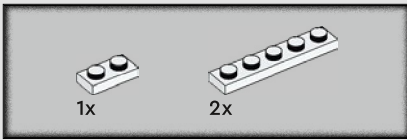

9

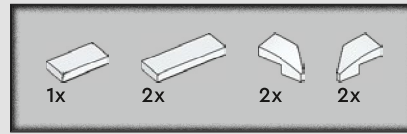
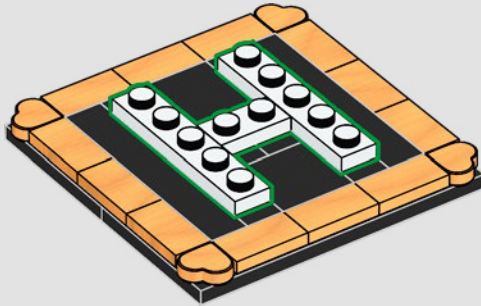

10

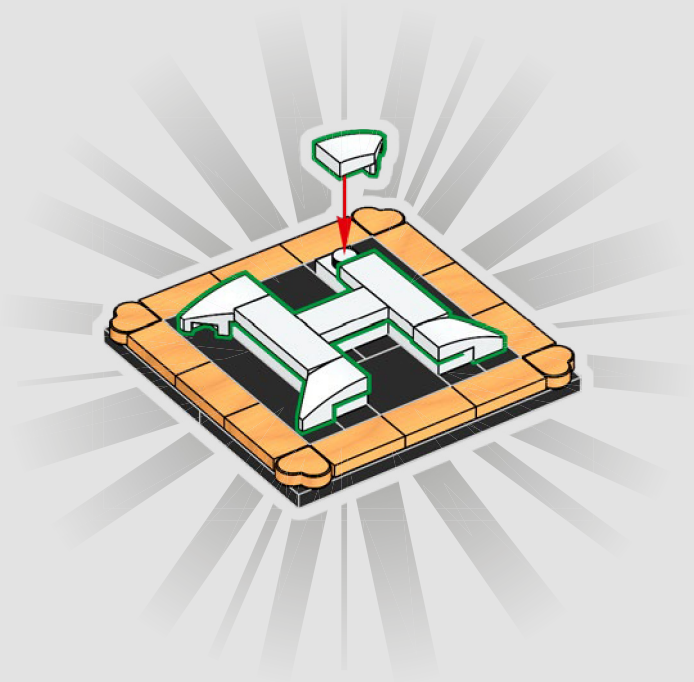

11

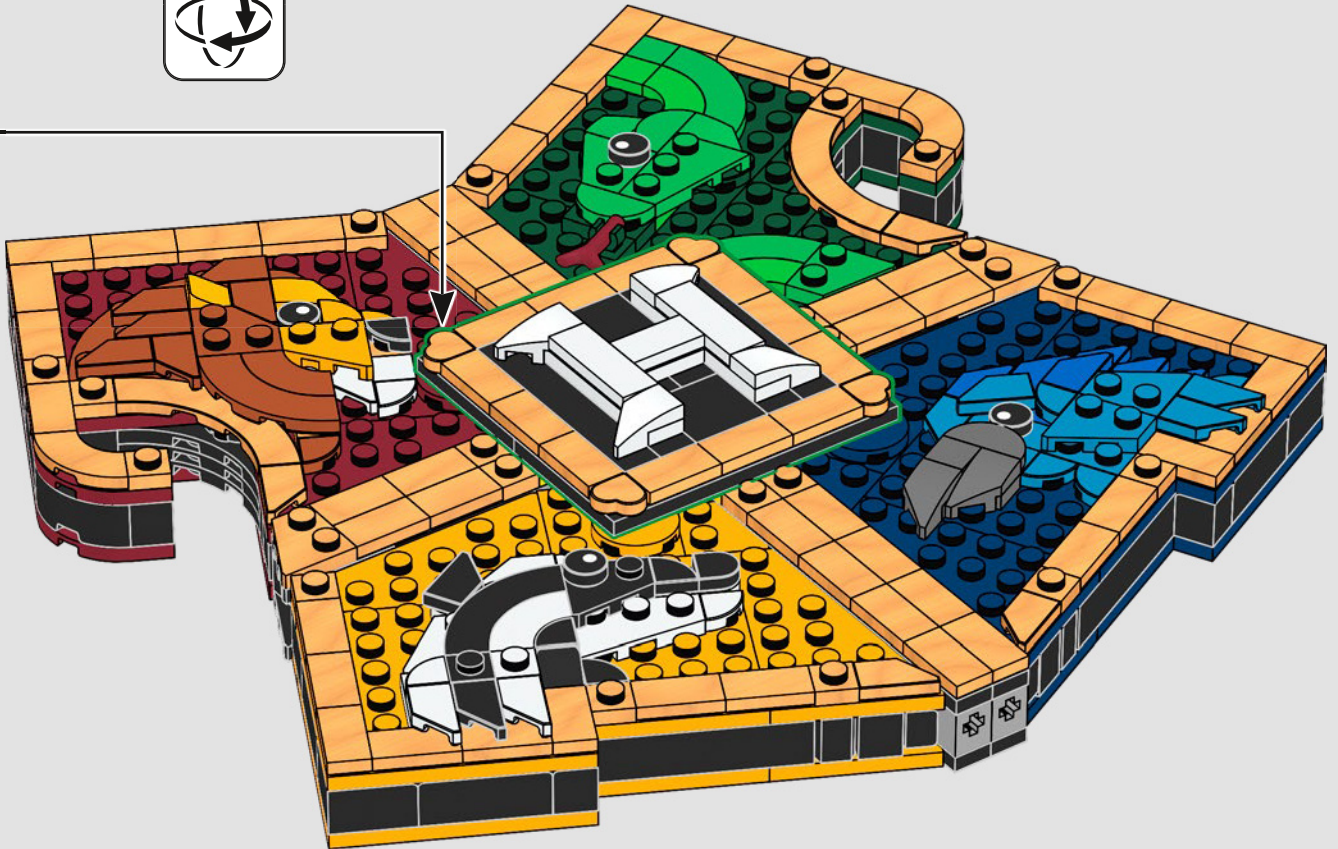

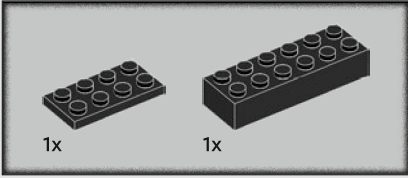
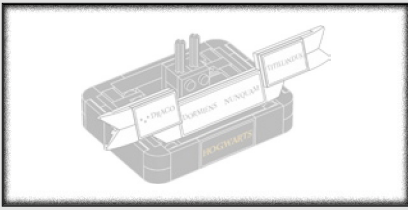

12

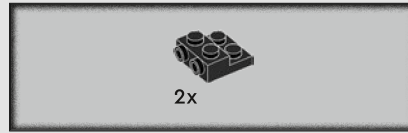
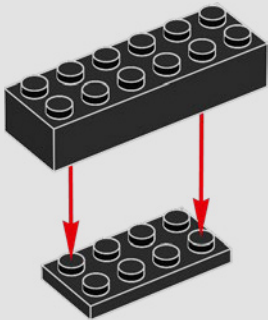

13

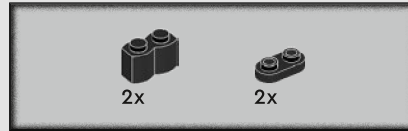
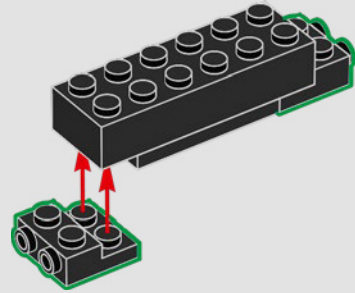

14

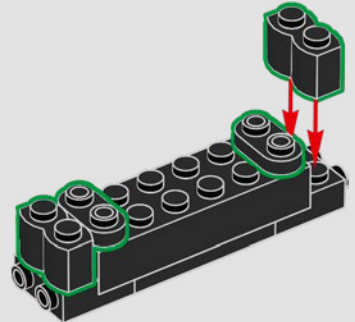

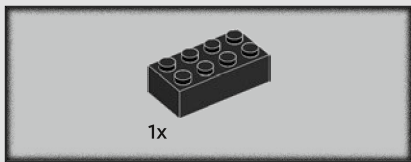

15

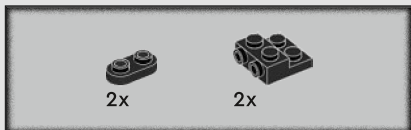
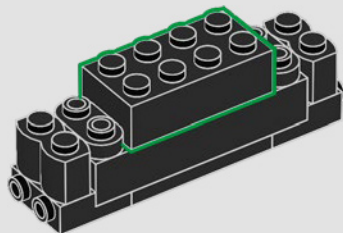

16

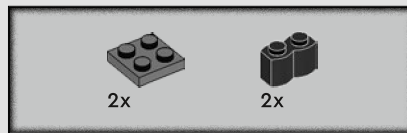
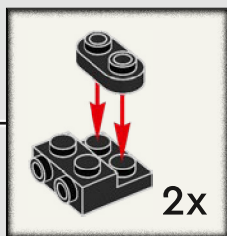
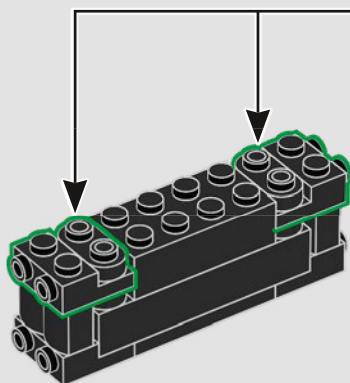

17

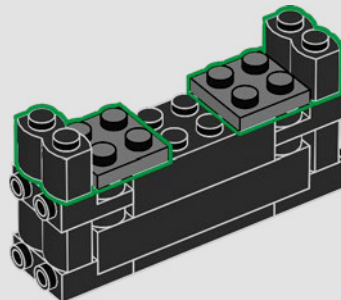

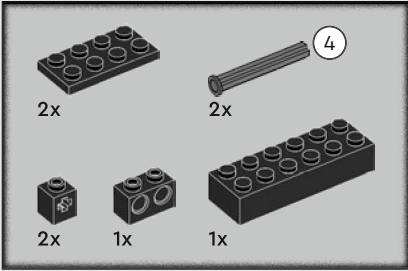
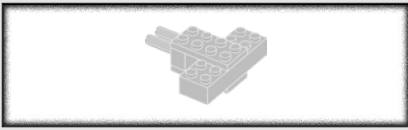

18

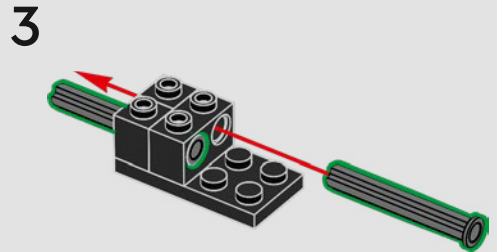
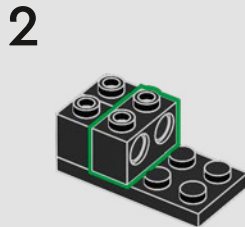
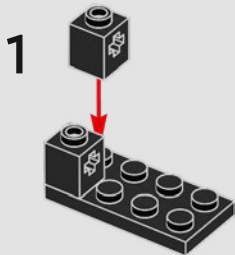

4

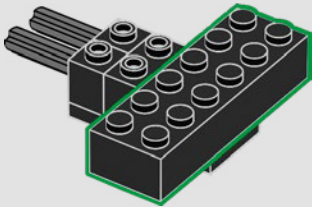

5

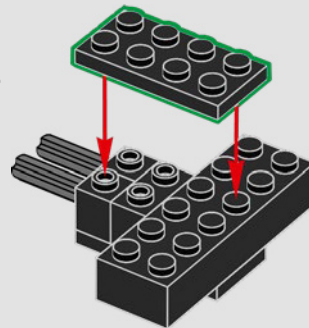

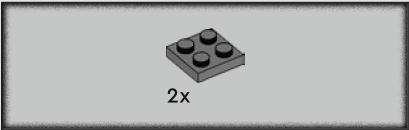

19

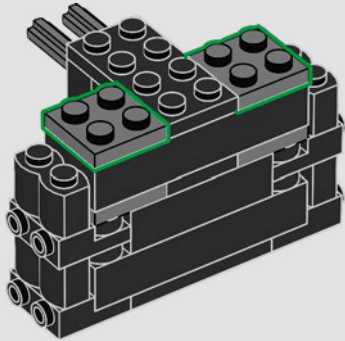
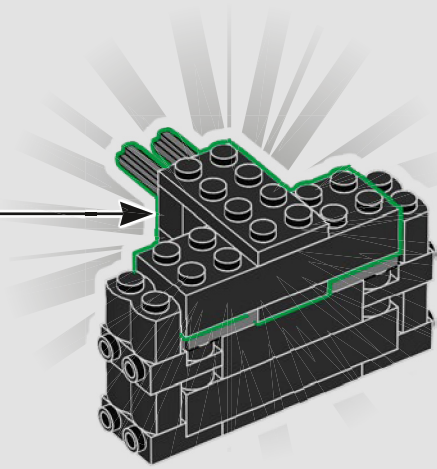

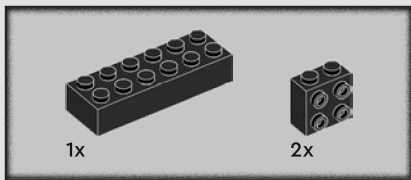

20

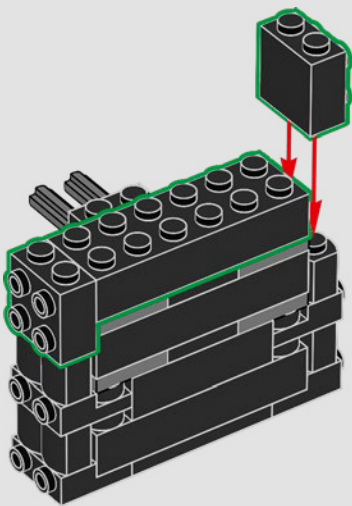

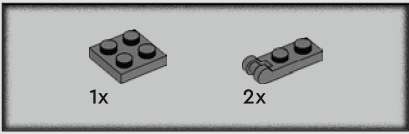

21

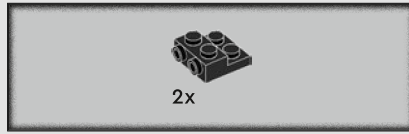
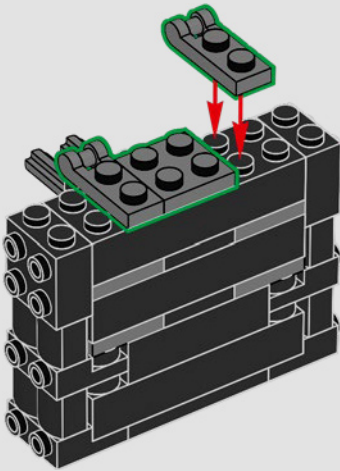

22

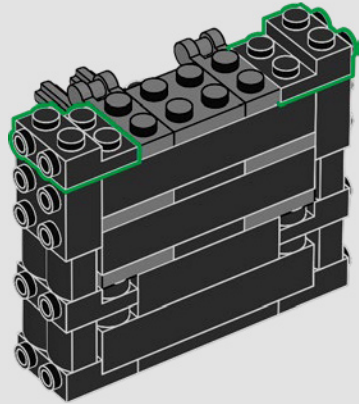

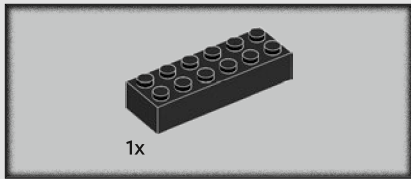

23

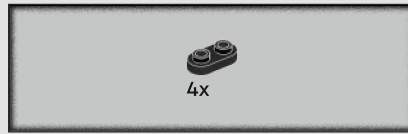
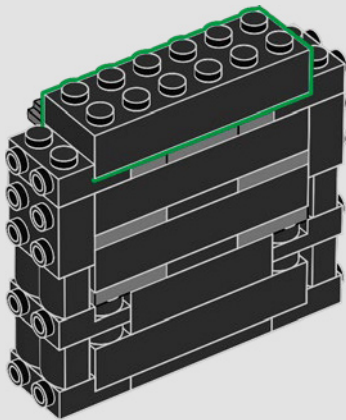

24

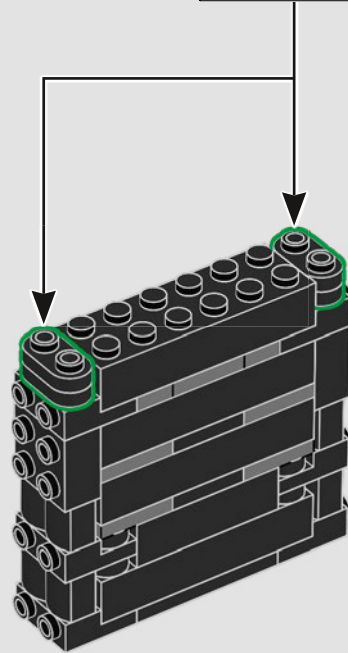
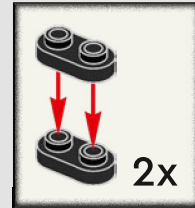

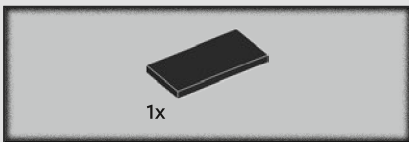

25

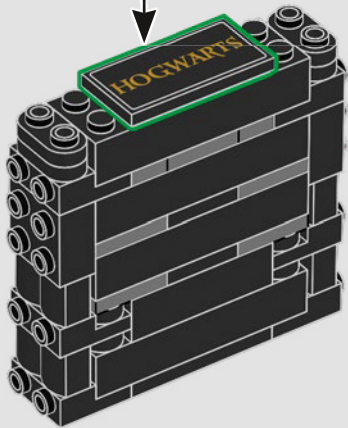
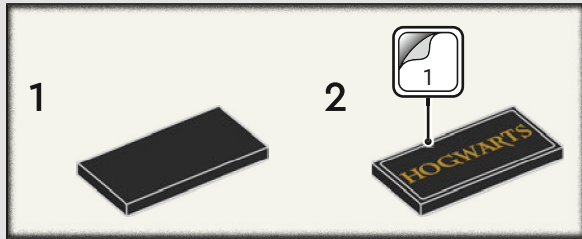

26

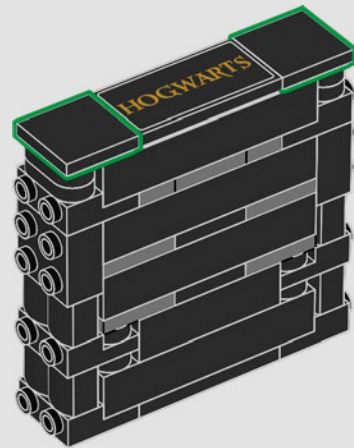

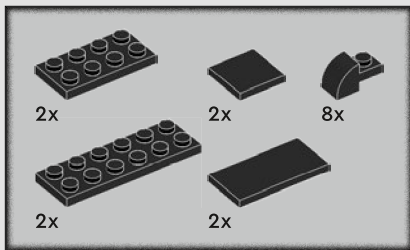

27

1

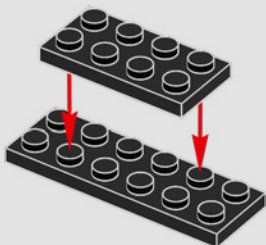

2

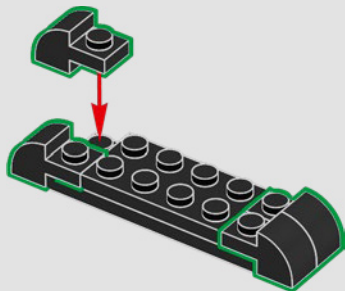

3

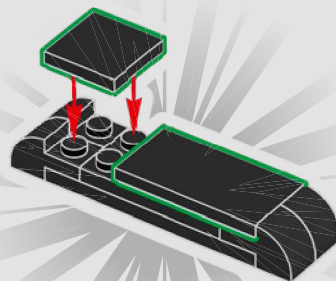

2x

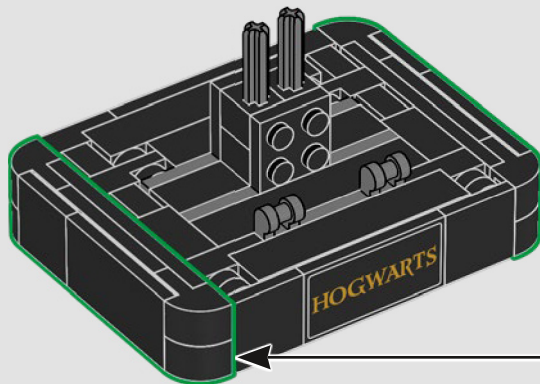



28

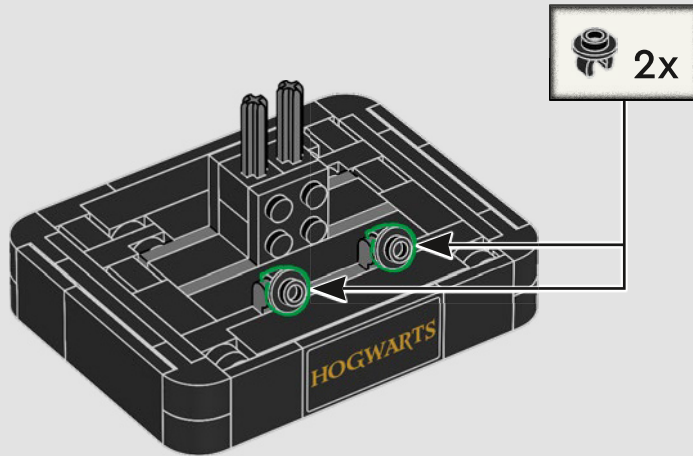

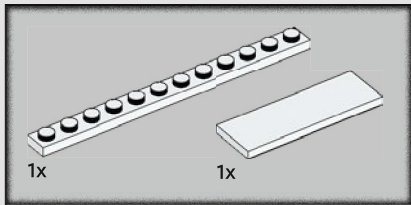
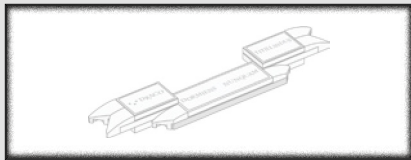

29

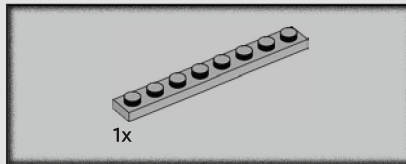
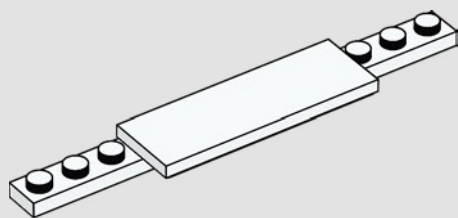

30

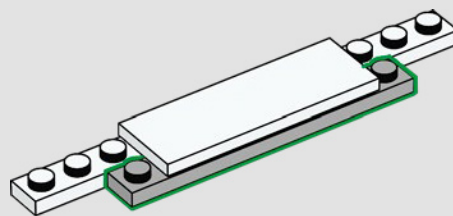

31

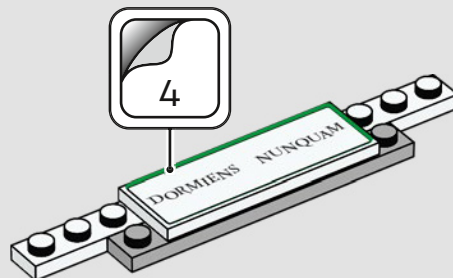

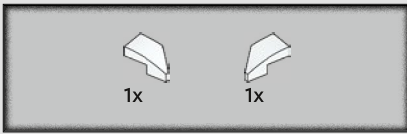

32

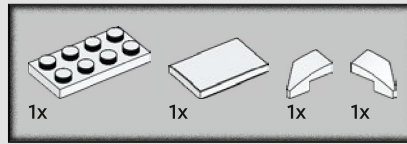
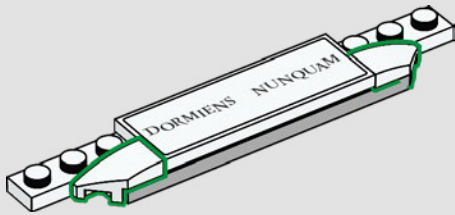

33

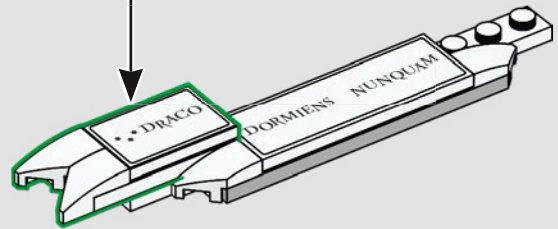
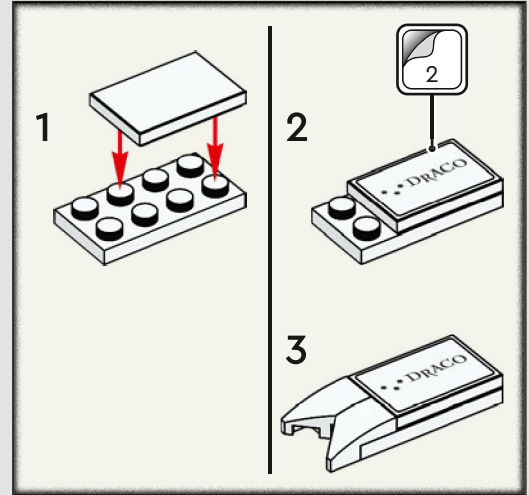

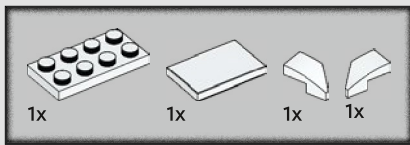

34

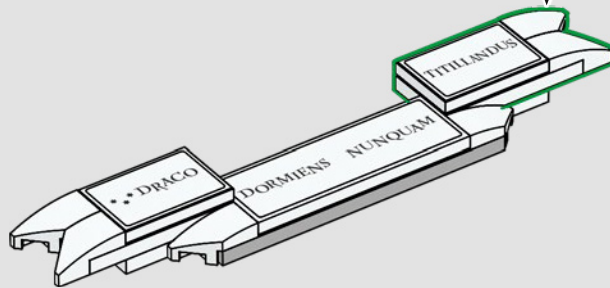
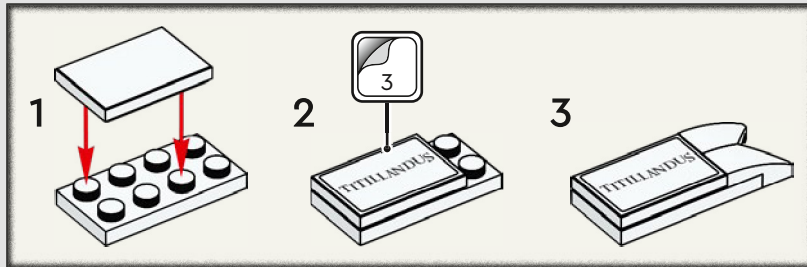

35

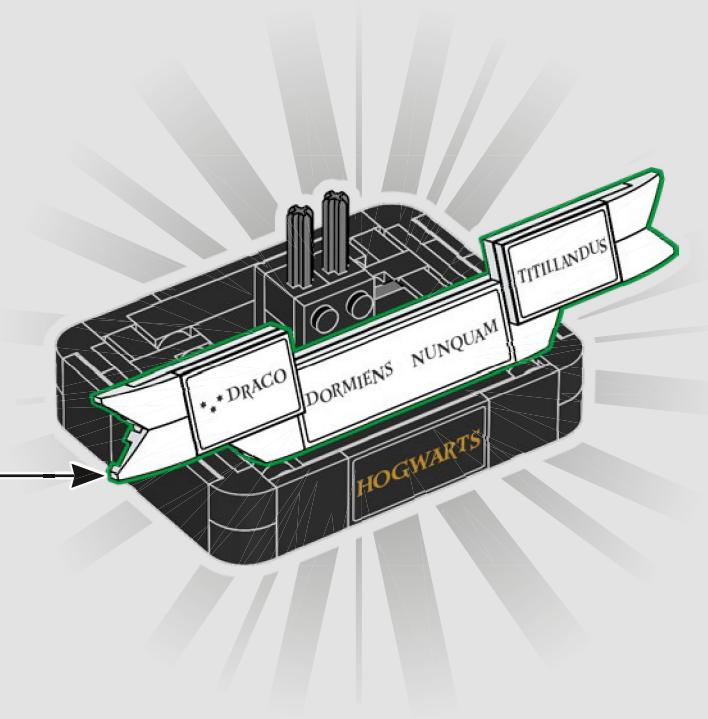

36

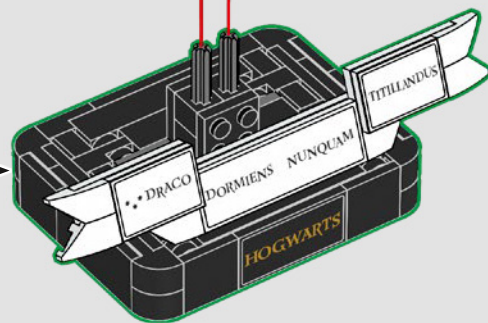
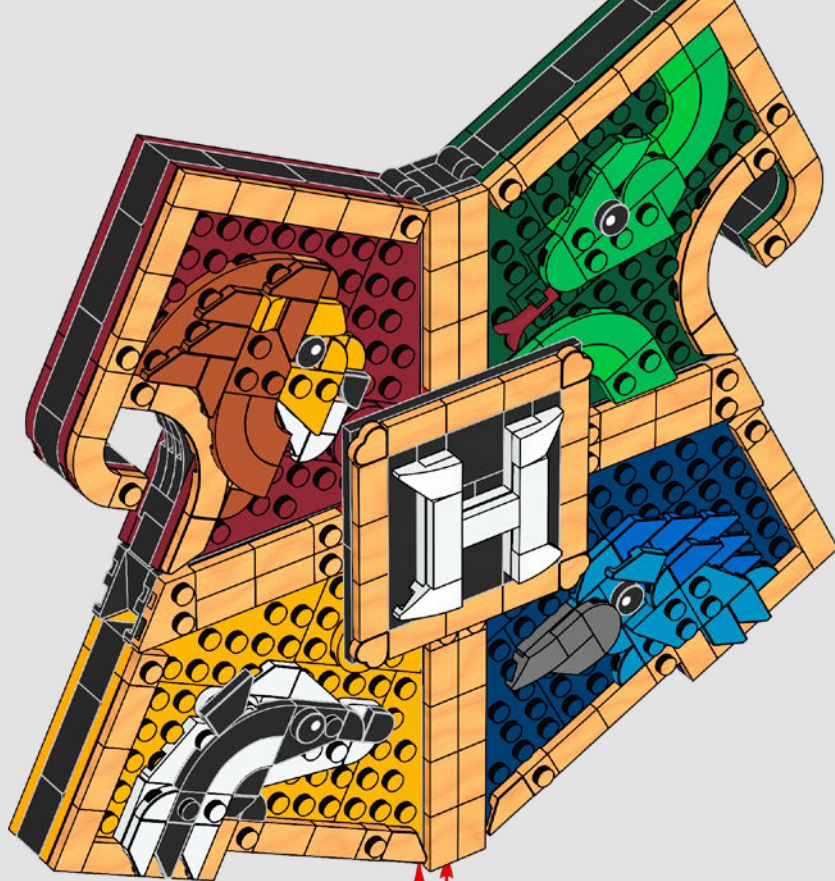





Harry Potter™

Build the most detailed Hogwarts™ Castle
Baue das detailreiche Schloss Hogwarts™
Construisez le château de Poudlard le plus détaillé
Costruisci il Castello di Hogwarts™ più dettagliato di sempre
Construye el Castillo de Hogwarts™ más detallado
Construa o mais detalhado Castelo de Hogwarts™

拼搭精美的霍格沃茨™城堡

Zbuduj najbardziej szczegółowy zamek Hogwarts™
Postavte si ten najdetailnejší Bradavický hrad
Postavte si najdetailnejši Rokfortský hrad
Építsd meg a legrészletgazdagabb Roxfort™ kastélyt!
Побудуйте найдетальніший замок Гогворте
Construieste cel mai detaliat Castel Hogwarts™
Постройте най-детальніша версія на замка Хогворте
Uzbūvē visdetalizētāko Cūkkārpas pili
Pane kokku kõige üksikasjalikum Sigatüika™ loss
Sukonstruokite nepaprastai detalią Hogwartso pilį
En detaylı Hogwarts™ Şatosunu inşa et

Each set sold separately and available for different periods of time / Jedes Set ist separat und in unterschiedlichen Zeiträumen erhältlich. / Chaque set est vendu séparément et sera disponible à des périodes différentes. / Ogni set è venduto separatamente ed è disponibile per periodi di tempo diversi. / Cada set se vende por separado y está disponible durante un cierto periodo de tiempo. / Os sets são vendidos separadamente e estão disponíveis por diferentes períodos de tempo. / 每款套装于不同时间段单独出售。 / Zestawy są sprzedawane osobno i są dostępne w różnym czasie / Každá stavebnice se prodává samostatně a je k dispozici v různých časových obdobích / Každá stavebnica sa predáva samostatne a je k dispozícii v rôznych časových obdobiach / Minden egyes készlet külön-külön és más-más időszakban kapható. / Кожен набір продається окремо і доступний протягом різних періодів часу / Seturile se vând separat și sunt disponibile pentru perioade diferite de timp / Всеки комплект се продава отделно и е наличен за различен период от време. / Katrs komplekts tiek pārdots atsevišķi, un to pieejamības periodi atšķiras. / Kõik komplektid on müügil eraldi ja saadaval erinevates ajavahemikes. / Kiekvienas rinkinys parduodamas atskirai ir tik ribotą laiką / Her set ayrı satılır ve farklı sürelerde mevcuttur



76435



76445



76463



Build the most detailed
HOGWARTS™ CASTLE



76454



76473



76447



Collectable PATRONUSES



76464



76460



76473



76463



25
YEARS OF
MAGIC

76475



76467



76471



76478

25 Years of Magic / 25 Jahre Magie / 25 ans de magie / 25 anni di Magia /
 25 Años de Magia / 25 Anos de Magia / 25 年魔法 / 25 lat magii /
 25 let kouzel / 25 rokov kúziel / A varázslat 25 éve / 25 rokov magii /
 25 de ani de magie / 25 години магия / 25 magijos gadi / 25 aastat maagiat /
 25 magijos metai / Sihirdi 25 Yil

Each set sold separately and available for different periods of time / Jedes Set ist separat und in unterschiedlichen Zeiträumen erhältlich. / Chaque set est vendu séparément et sera disponible à des périodes différentes. / Ogni set è venduto separatamente ed è disponibile per periodi di tempo diversi. / Cada set se vende por separado y está disponible durante un cierto periodo de tiempo. / Os sets são vendidos separadamente e estão disponíveis por diferentes períodos de tempo. / 每款套装于不同时间段单独出售。 / Zestawy są sprzedawane osobno i są dostępne w różnym czasie. / Každá stavebnice se prodává samostatně a je k dispozici v různých časových obdobích / Každá stavebnica sa predáva samostatne a je k dispozícii v rôznych časových obdobiach / Minden egyes készlet külön-külön és más-más időszakra kapható. / Кожен набір продається окремо і доступний протягом різних періодів часу / Seturile se vând separat și sunt disponibile pentru perioade diferite de timp / Всеки комплект се продава отделно и е наличен за различен период от време. / Kats komplekts tiek pārdots atsevišķi, un to pieejamības periodi atšķiras. / Koik komplektid on müügil eraldi ja saadaval erinevates ajavahemikes. / Kiekvienas rinkinys parduodamas atskirai ir tik ribotą laiką / Her set ayrı satılır ve farklı sürelerde mevcuttur

Collectable Patronuses / Patronusse zum Sammeln / Des Patronus à collectionner / Patronus collezionabili / Patronus coleccionables / Patronus colecționáveis / 具有收藏价值的守护神 / Patronusy do kolekcjonowania / Sběratelné patronůsk / Zberateľské patronusy / Gyűjthető patronusok / Колекційні патронуси / Figurine Patronus de colecție / Колекционерски фигури на покровители / Kolekciónerjaimi ajsztávji / Kogutavad Patronused / Kolekcijniai Gyűnejai / Koleksiyonluk Patronuslar

4x 6172366	2x 6156667	1x 6498729	1x 6284575	2x 6539387	8x 6092585	1x 6434275
1x 307001	1x 302101	64x 6107197	3x 614123	2x 300526	2x 6344999	5x 302026
2x 302401	2x 302001	2x 6173654	6x 6535148	2x 4106347	4x 4121966	1x 300126
5x 6213880	2x 302001	2x 6458180	1x 614323	2x 4558954	2x 383126	3x 4560182
3x 6510140	2x 6350399	1x 6597903	3x 370023	3x 4504382	6x 306826	2x 663626
5x 6213881	1x 6332042	1x 6503228	1x 6126049	5x 302426	4x 235726	2x 300926
2x 6132203	1x 4514842	1x 6284577	3x 242023	2x 6510139	4x 6344005	6x 6208787
2x 6210272	2x 6060800	3x 614124	1x 362223	2x 6141554	2x 4567436	4x 4181144
1x 4179874	1x 4505990	1x 614324	1x 300223	3x 6141556	6x 6469445	2x 379526
1x 302301	4x 6301811	2x 302324	2x 6534180	8x 6210270	4x 4159550	4x 447726
1x 306901	24x 6069887	3x 370024	4x 6284072	6x 6279875	4x 362226	2x 303526
1x 6217875	2x 6508086	1x 6126050	1x 6256435	12x 4644456	4x 6382491	2x 4514845
2x 300301	2x 6508101	1x 362224	2x 6344819	1x 3200026	10x 6382491	
1x 6172674	2x 6510211	1x 362224	5x 6172383	2x 6275806	2x 301026	
2x 4558168	1x 6498728	1x 300224	2x 407026	8x 6542614		

1x 4210848
1x 6204667
1x 6204668
1x 6510078
5x 4211094
4x 6477380
1x 4210635
2x 4521187
2x 6083620
3x 614121
2x 302321
3x 370021
1x 303921
1x 6126048
1x 300121

4

4x 6228968
7x 6553758
1x 6228840
1x 6340042
1x 6468066
1x 6489202
3x 4569058
2x 4558593
2x 6290602
1x 6385276
2x 6172375
2x 6382958
2x 6510079
1x 6385279
1x 4621946
2x 302328

3x 6230235
1x 6389692
1x 303928
2x 6584861
1x 6141590
1x 4106356
2x 6224384
1x 6299536
4x 6528790
2x 6135597
2x 6037887
2x 6106692

5x 6199887
4x 6551378
2x 6145418
4x 4653988
1x 6151671
3x 6315608
3x 6055169
1x 6348061
1x 6013102
4x 6605066
2x 6020923
2x 6605067
2x 6253283
2x 6605068

1x 6131589
2x 6214457
1x 6023173
1x 6289747
1x 6296241
2x 6328059
1x 6028736
4x 6605069
1x 6097503
2x 6294582
2x 6605070
2x 6504997

1x 6605930
2x 4539114
1x 6264149
1x 6551408
2x 4539061
2x 6383988
4x 6605065
2x 4618986
2x 6028115

1x 6316265
6x 6336539
1x 6225246
2x 6327412
2x 4211461
4x 6446028
4x 6065824
4x 4211773
9x 4211425



 [LEGO.com/service](https://www.LEGO.com/service)

YOU COULD **WIN**



Scan this QR code or go to **LEGO.COM/PRODUCTFEEDBACK** and give us your short feedback about this LEGO® set for a chance to win a cool LEGO prize.

Terms and Conditions apply*

EN: YOU COULD WIN. Terms and Conditions apply* **DE: Du könntest GEWINNEN.** Es gelten die Teilnahmebedingungen* **FR: TU POURRAIS GAGNER.** Des conditions s'appliquent* **IT: Potresti VINCERE tu.** Termini e condizioni sono applicabili* **ES: PUEDES GANAR.** Aplican términos y condiciones* **PT: PODERÁ GANHAR.** Aplicam-se Termos e Condições* **ZH: 轻松获奖. 条款和条件适用*** **PL: Szansa na WYGRANĄ.** Obowiązuje regulamin* **CS: Máte šanci VYHRÁT.** Platí všeobecné smluvní podmínky* **SK: Máte šancu VYHRÁŤ.** Platia všeobecné zmluvné podmienky* **HU: TE IS NYERHETSZ!** Felhasználási feltételek érvényesek* **UA: ВИ МОЖЕТЕ ВИГРАТИ.** Застосовуються загальні положення та умови* **RO: Ai putea CÂȘTIGA.** Se aplică termeni și condiții* **BG: Можете да СПЕЧЕЛИТЕ.** Има определени правила и условия* **LV: Tu vari LAIMĒT.** Ir spēkā noteikumi un nosacījumi.* **ET: Sul on võimalus VÕITA.** Kehtivad tingimused* **LT: Jūs galite LAIMĖTI.** Taikomos sąlygos* **TR: KAZANABİLİRSİN.** Şartlar ve Koşullar geçerlidir*

*[LEGO.com/productfeedback-terms](https://www.lego.com/productfeedback-terms)