



Friends

42693



LEGO® Builder



LEGO.com/sustainable-packaging



FR
DONNEZ
OU
RECYCLEZ



ASSOCIATION

OU



MAGASIN

OU



DÉCHÈTERIE

Adresses sur quefairedemesdechets.fr

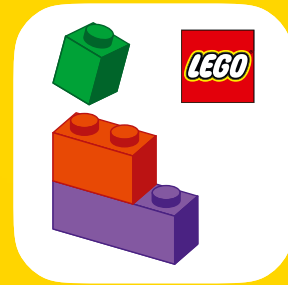

LEGO® Builder



BUILDER



Apple and the Apple logo are trademarks of Apple Inc., registered in the U.S. and other countries and regions. App Store is a service mark of Apple Inc. Google Play and the Google Play logo are trademarks of Google LLC. Tencent and the Tencent logo are trademarks of Tencent Inc.

[LEGO.com/devicecheck](https://www.lego.com/devicecheck)

EN Ask parents' permission before going online | **DE** Eltern um Erlaubnis bitten, bevor du online gehst | **FR** Demande l'autorisation d'un parent avant d'aller en ligne | **IT** Chiedi il permesso ai tuoi genitori prima di andare online | **ES** Pídeles permiso a tus papás antes de conectarte a Internet | **PT** Pede autorização aos teus pais antes de ficares online | **ZH** 上网前应先征得父母的同意 | **PL** Poproś rodziców o zgodę, zanim wejdiesz do Internetu | **CS** Než půjdeš na internet, požádej rodiče o svolení | **SK** Skôr než pôjdeš na internet, vypýtaj si povolenie od rodičov | **HU** Kérj szülői engedélyt, mielőtt online csatlakoznál! | **UA** Запитуйте дозволу батьків, перш ніж користуватися інтернетом | **RO** Cere permisiunea părinților înainte de a te conecta online | **BG** Поискайте разрешение от родител, преди да влезете онлайн | **LV** Pirms došanās tiešsaistē palūdz atļauju vecākiem | **ET** Enne Interneti kasutamist küsi vanematelt luba | **LT** Prieš prisijungdami prie interneto, atsiklauskite tėvų | **TR** İnternete girmeden önce anne babandan izin iste

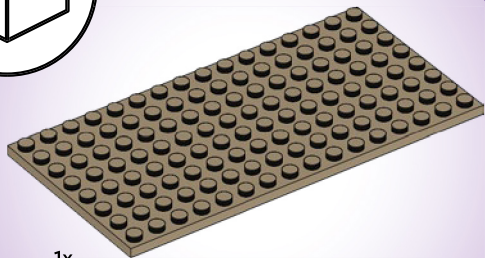
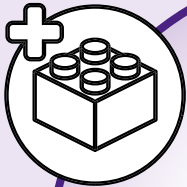

1x

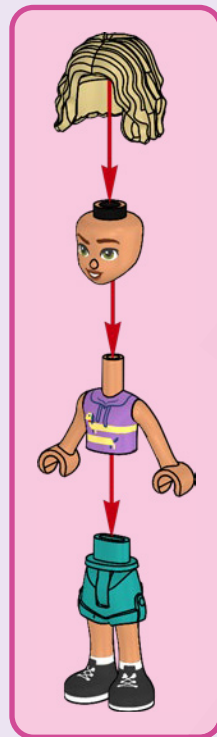

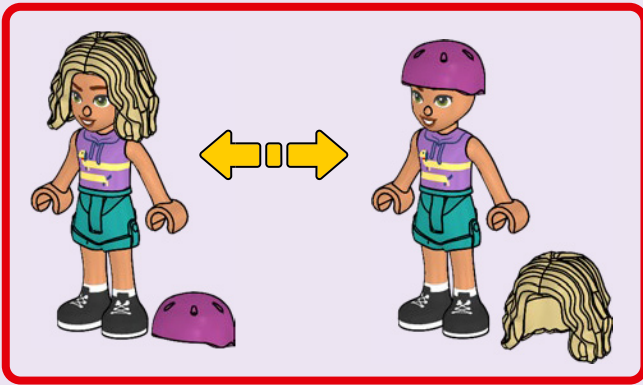

Nova



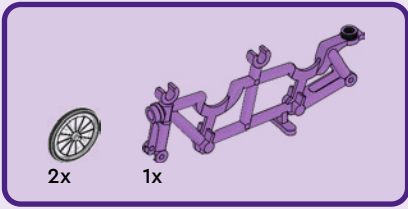

1

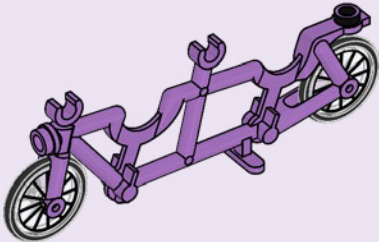

2

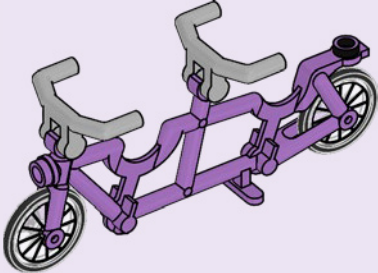

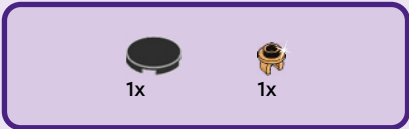

3

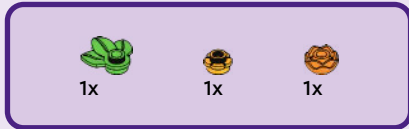
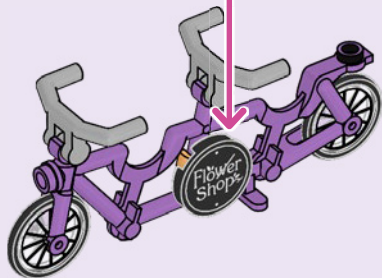
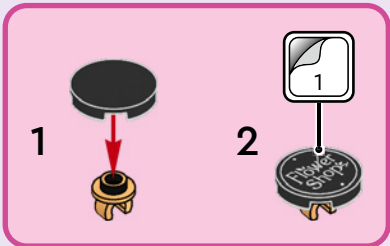

4

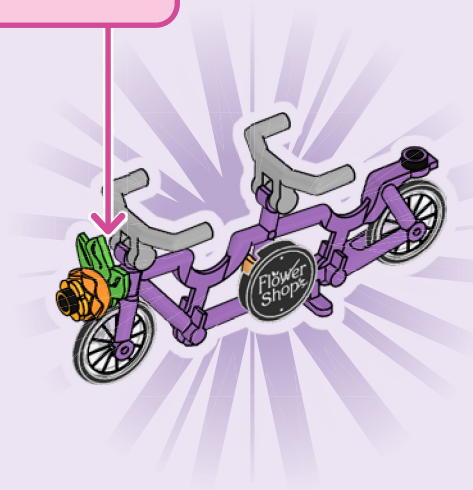
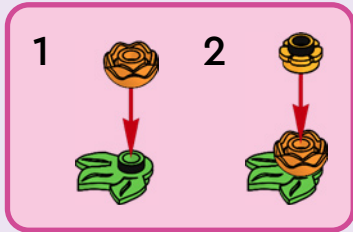

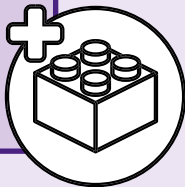
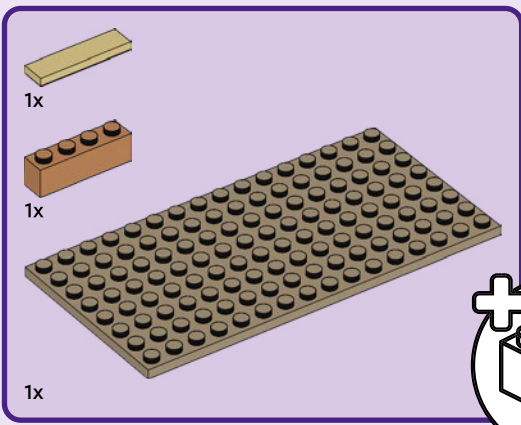

5

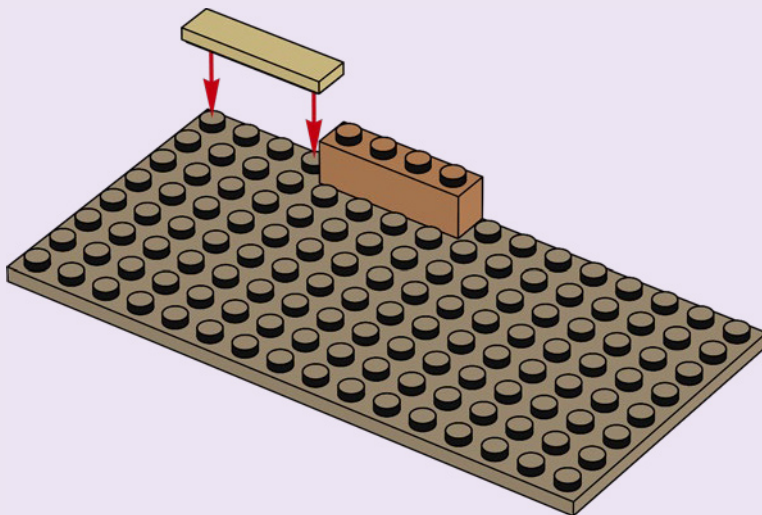

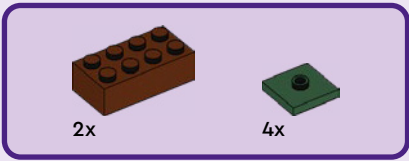

6

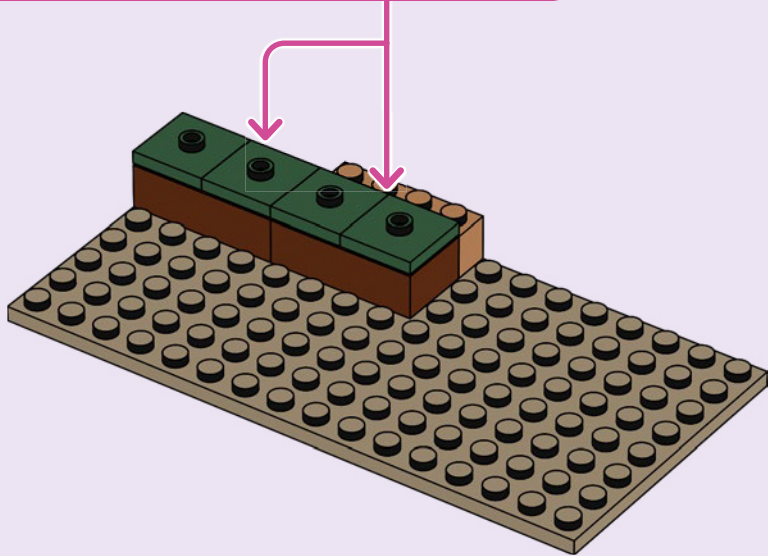
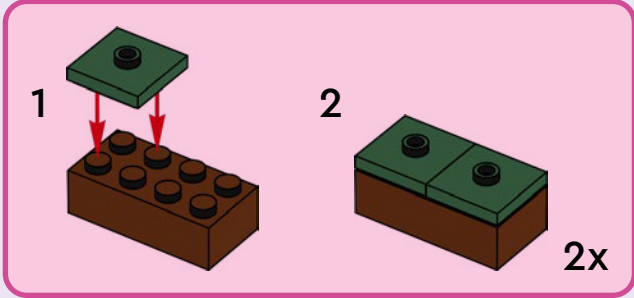

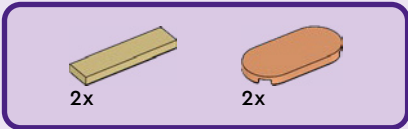

7

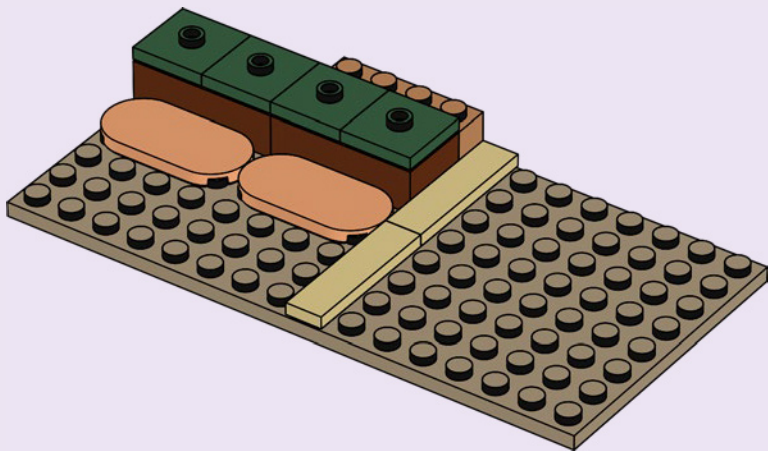

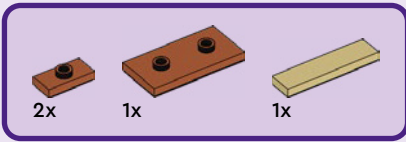

8

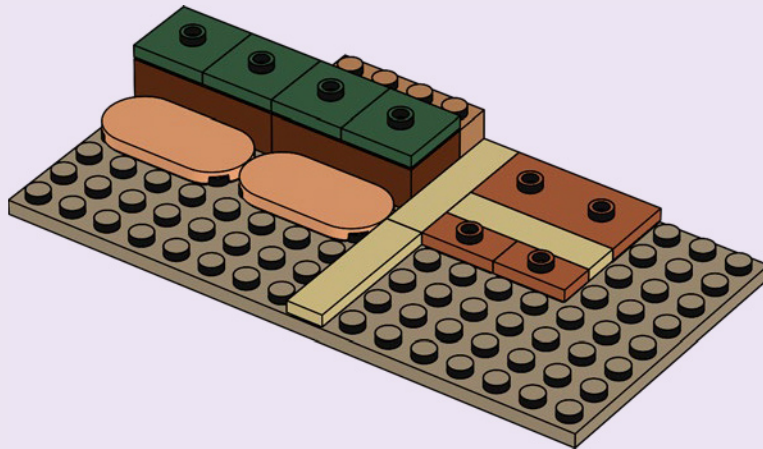

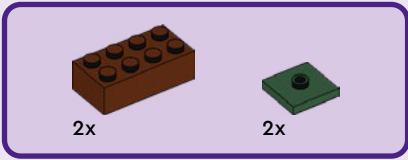

11

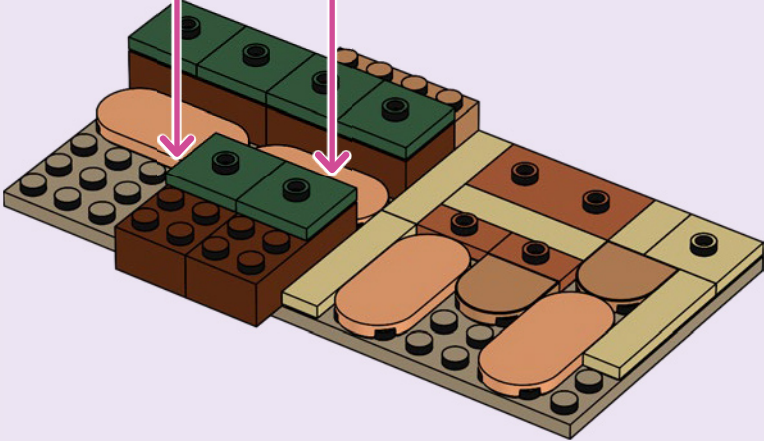
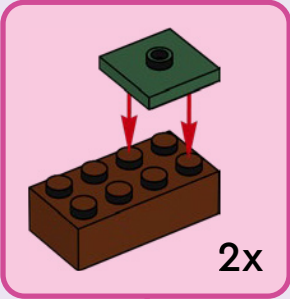

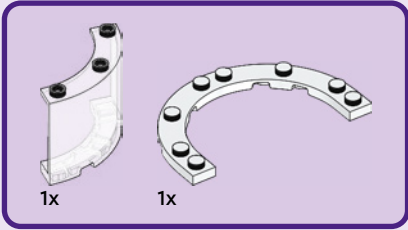
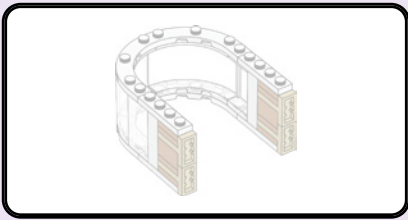

12

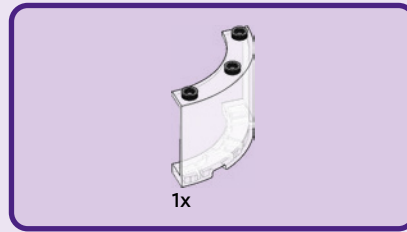
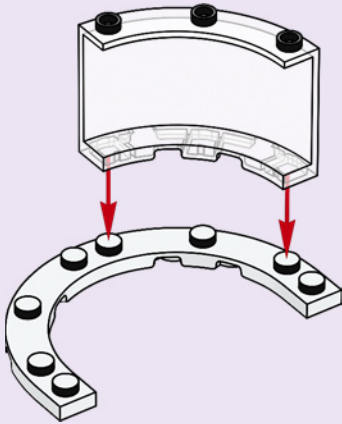

13

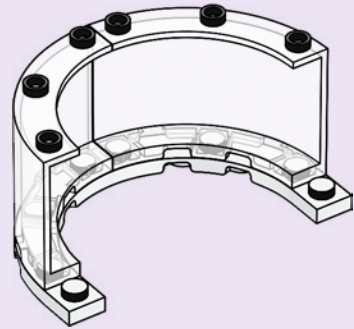

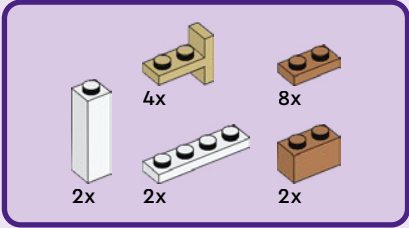
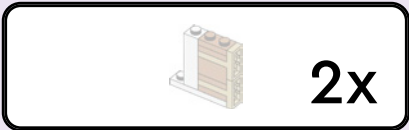

16

1

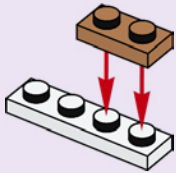

2

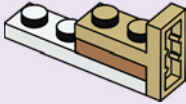

3

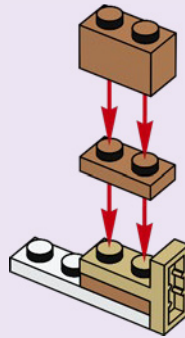

4

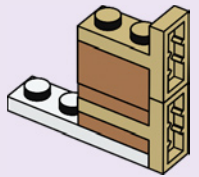

5

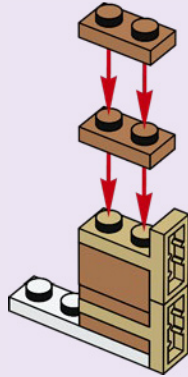

6

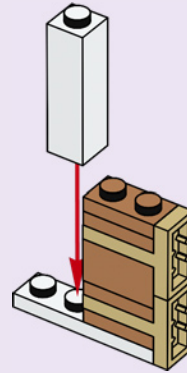

2x



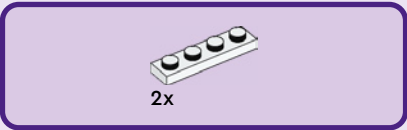

17

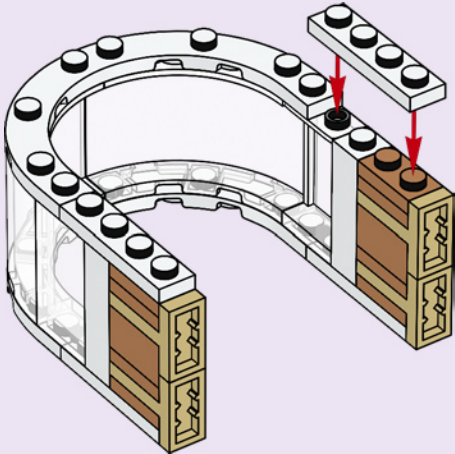
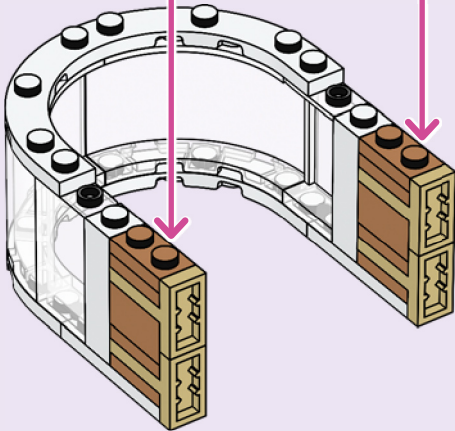

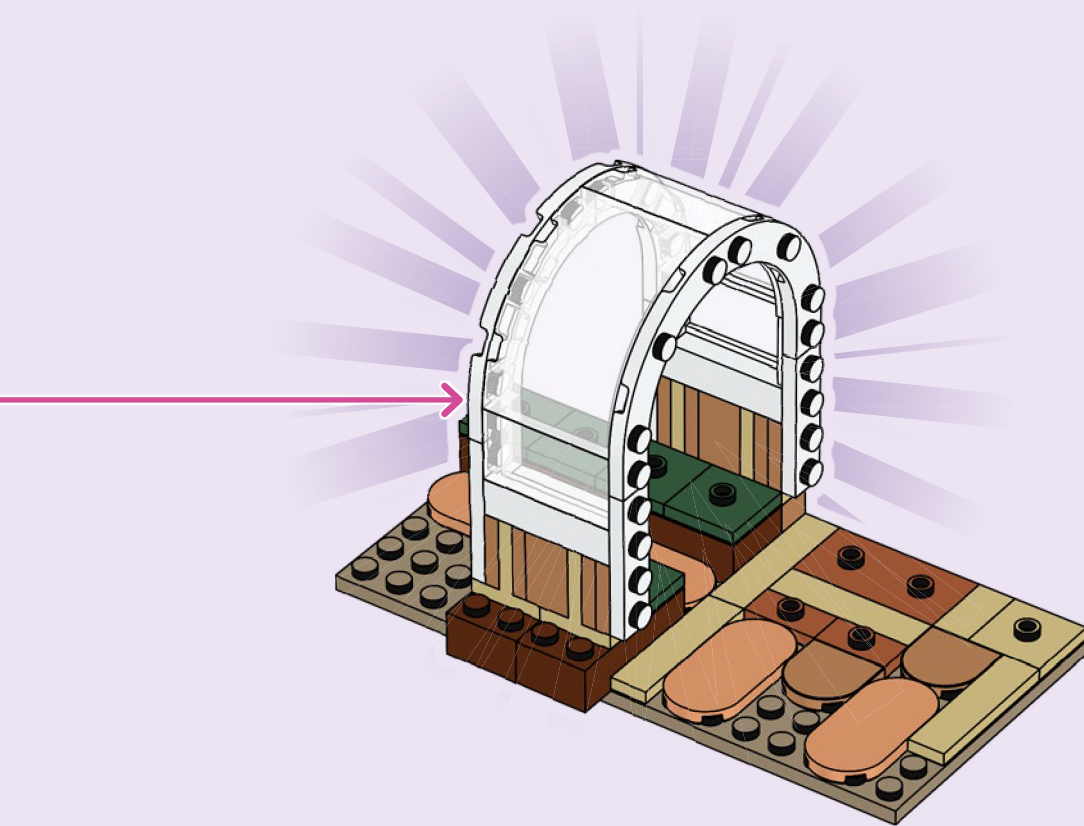

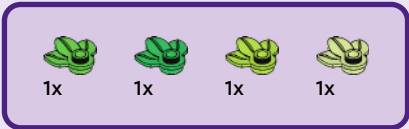

19

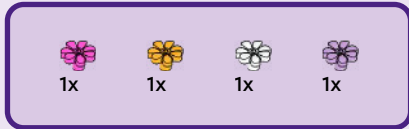
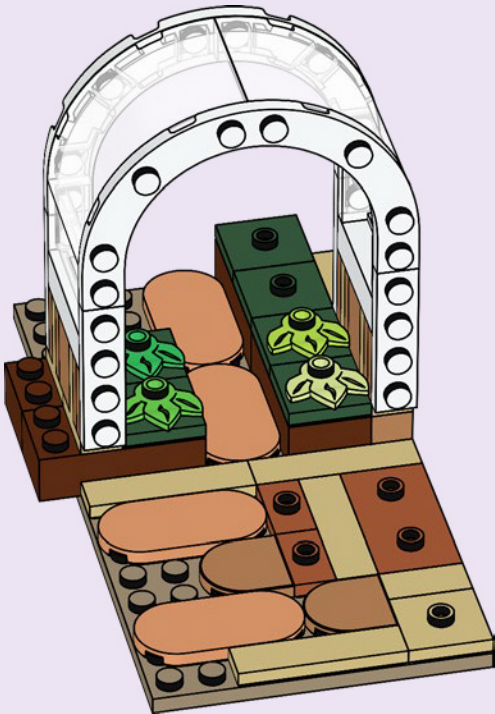

20

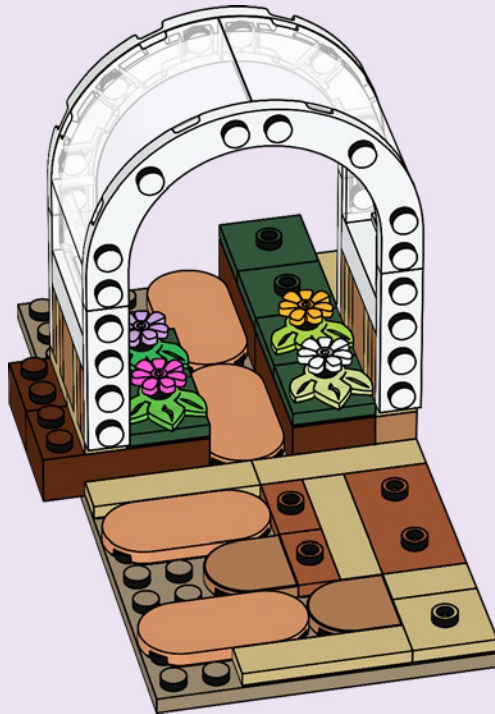

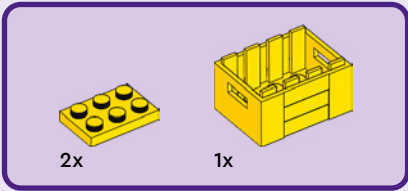

21

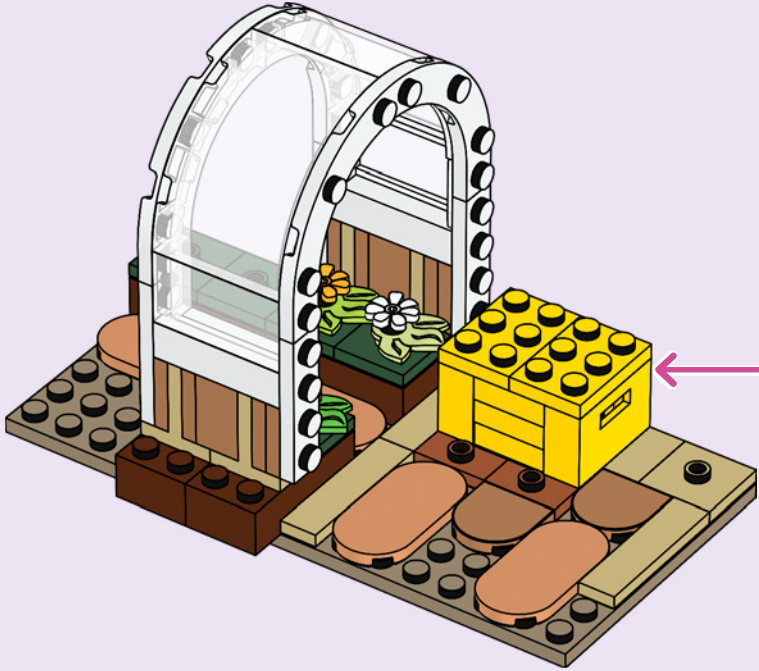
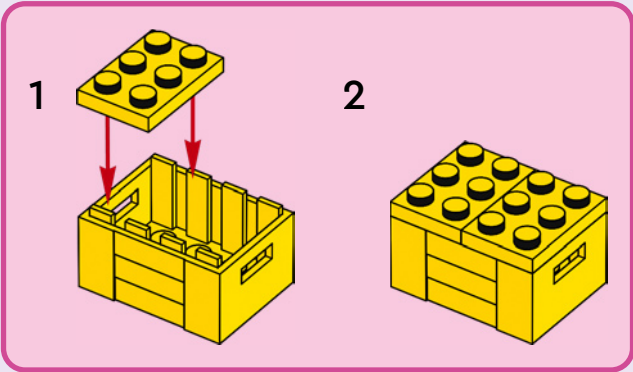



1x



1x

22

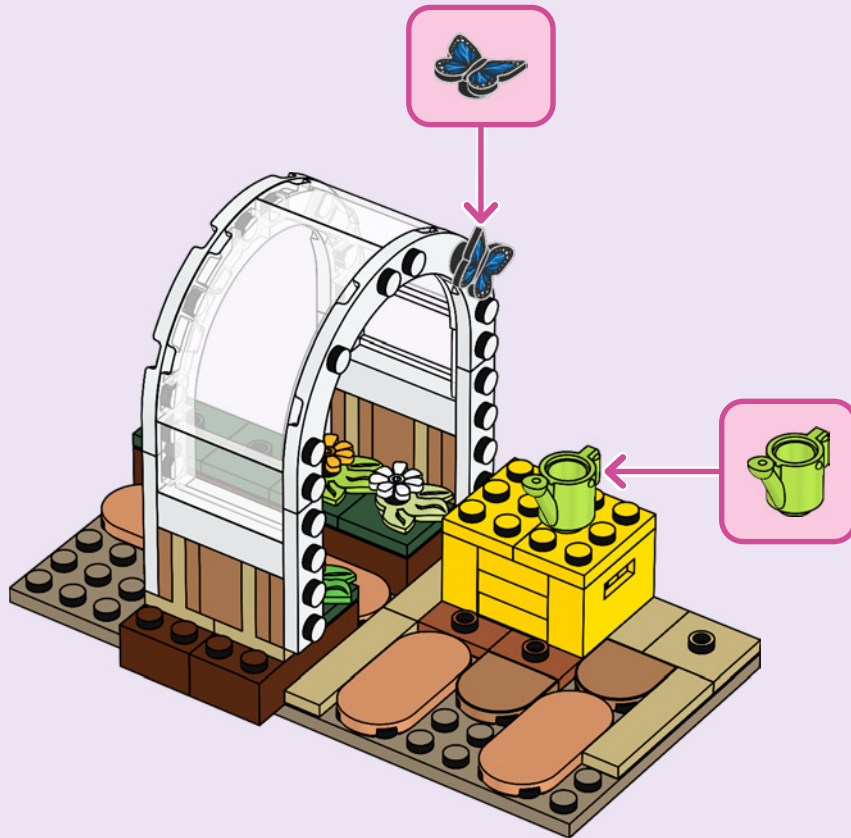



23



24



25

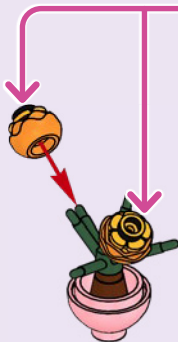

2x



26

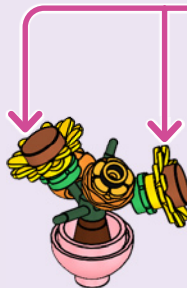

1



2



2x



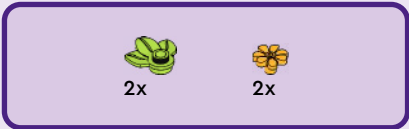

27

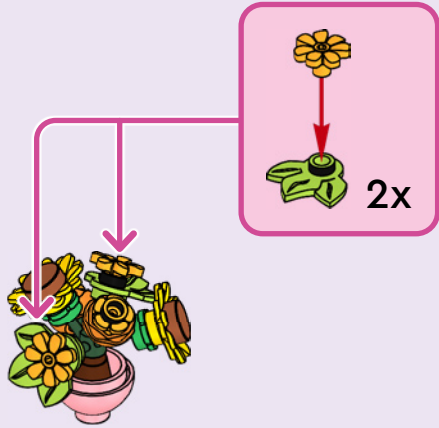

28



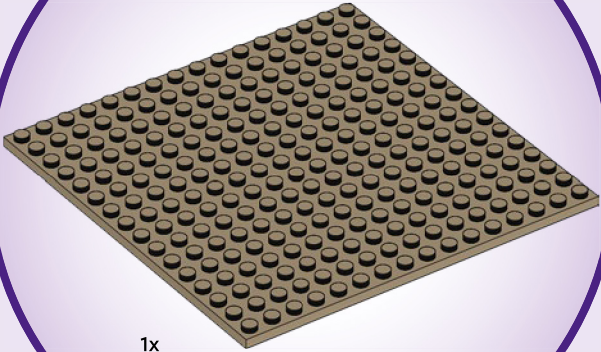
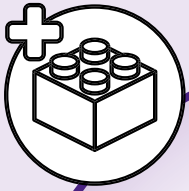

1x

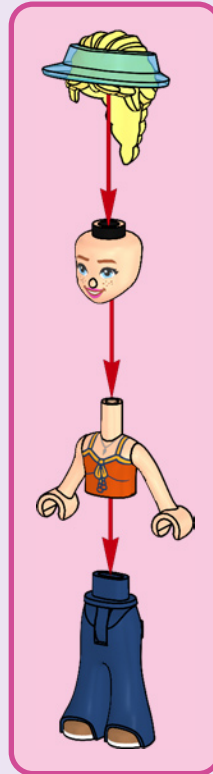
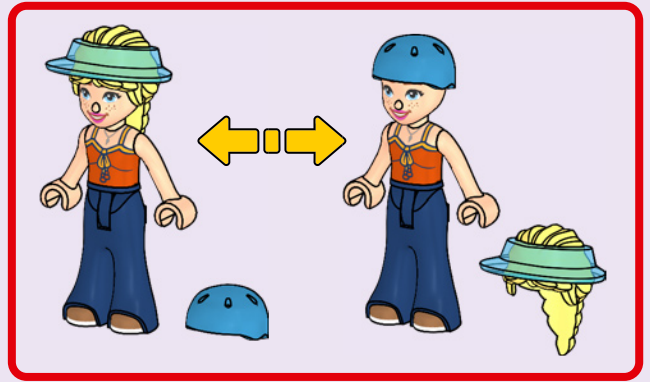

Astrid



29

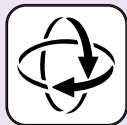

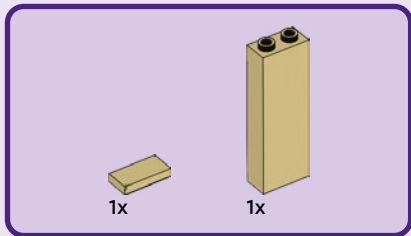

30

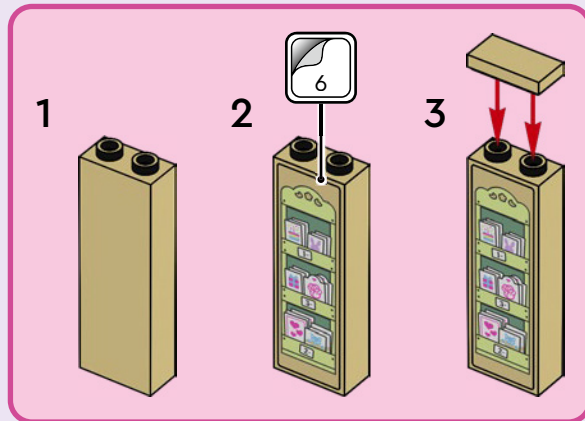

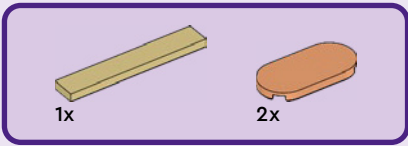

31



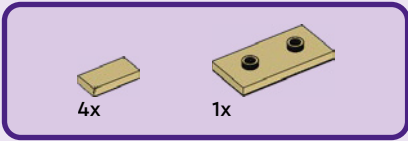

32



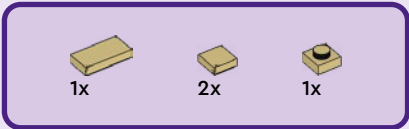

33





4x



2x

34



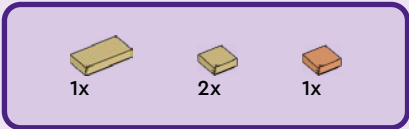

35



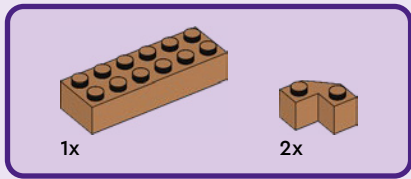

36





37

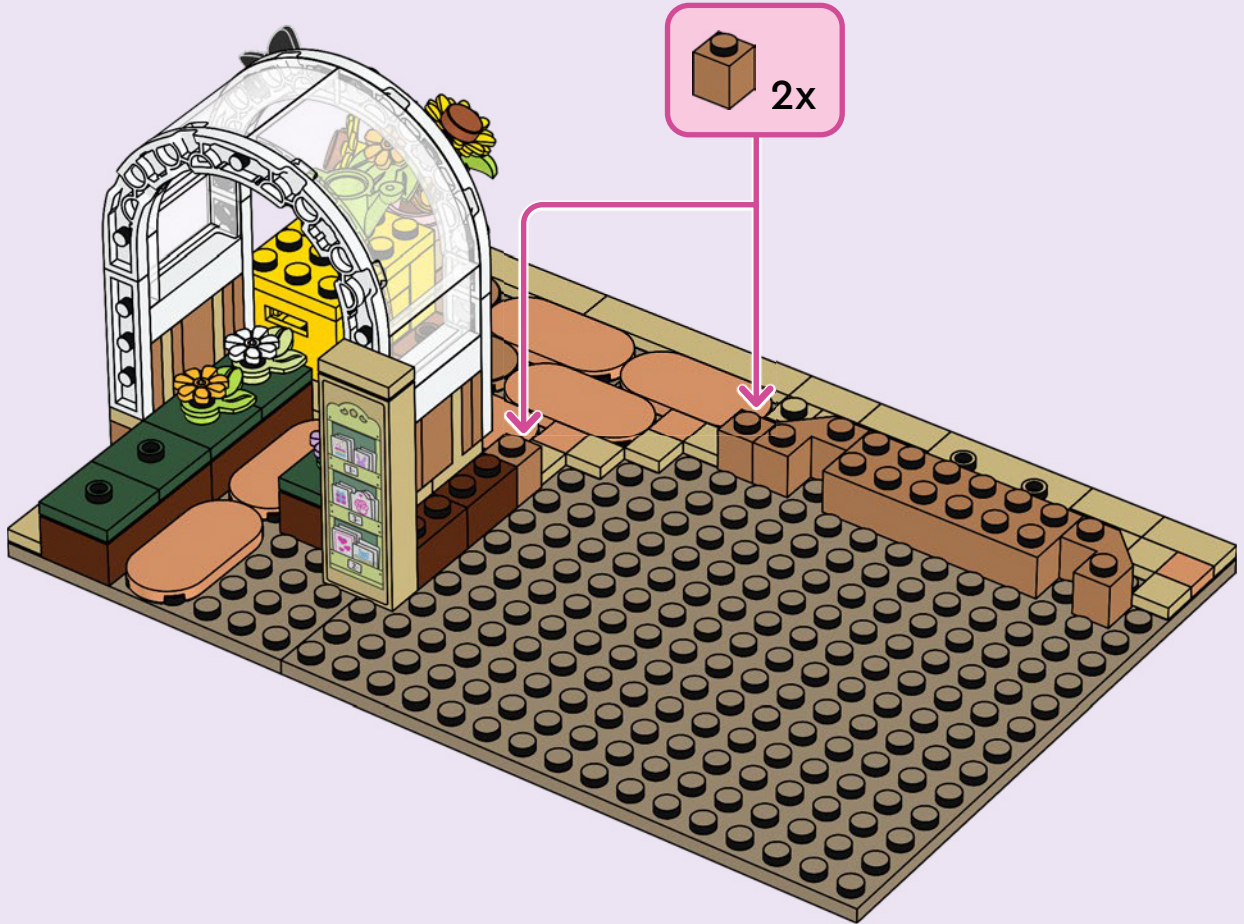



3x

38



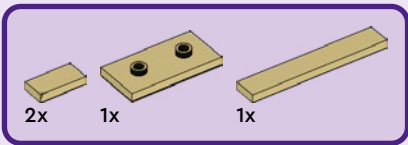

39



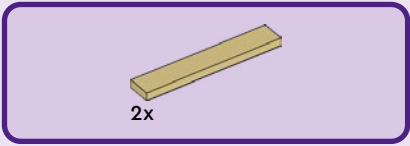

40



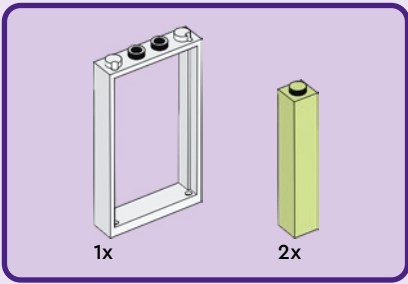

41



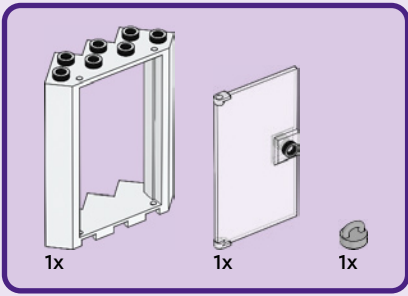

42

1

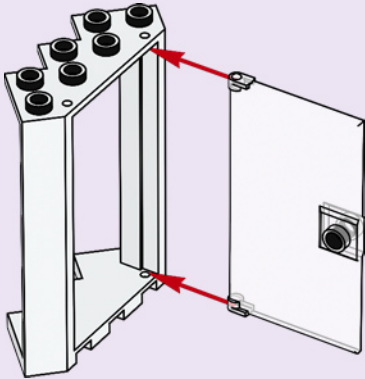

2

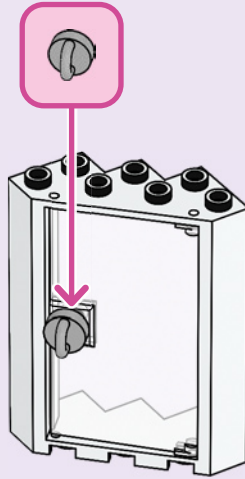

3

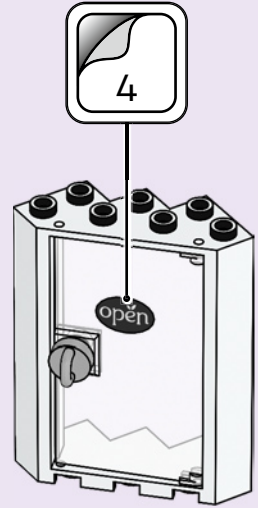

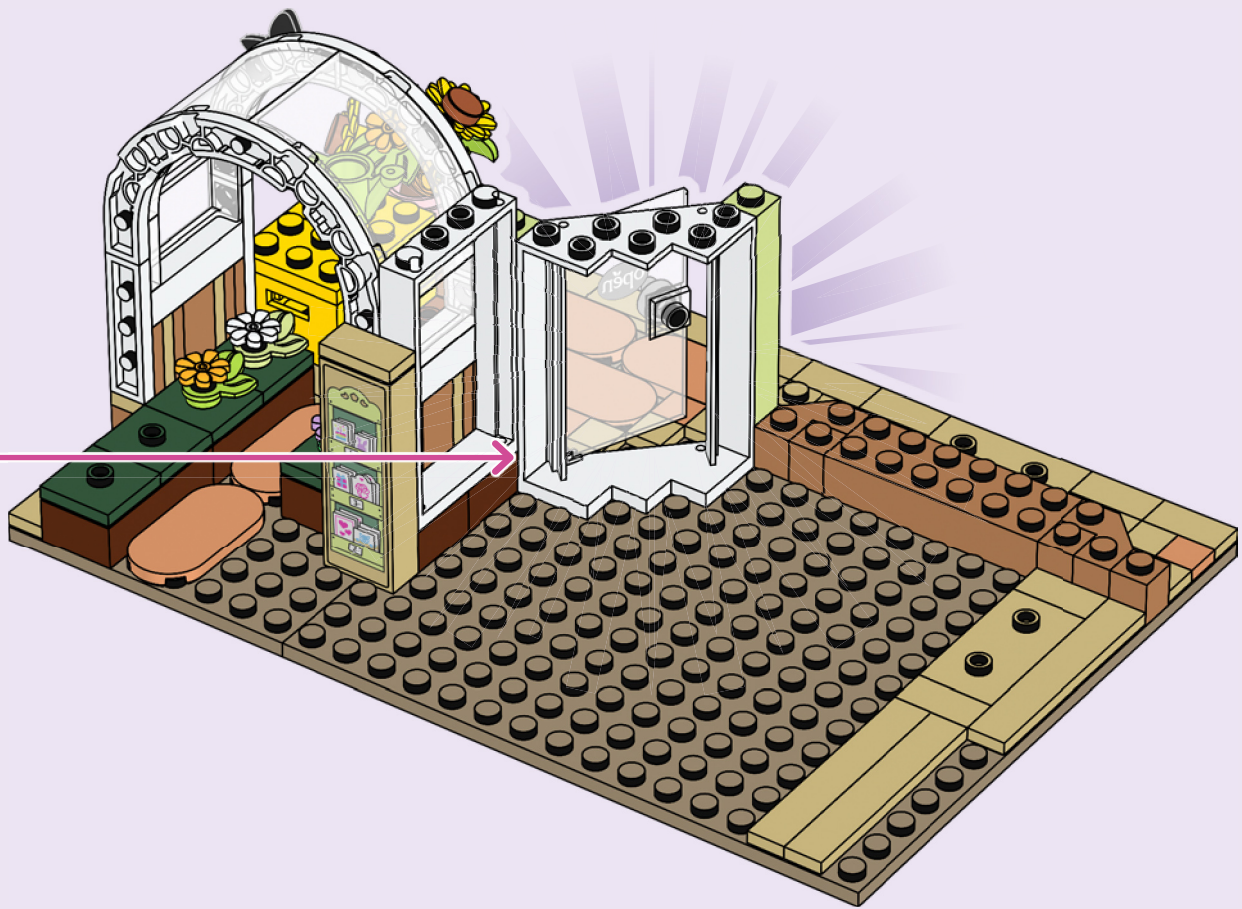



2x

43

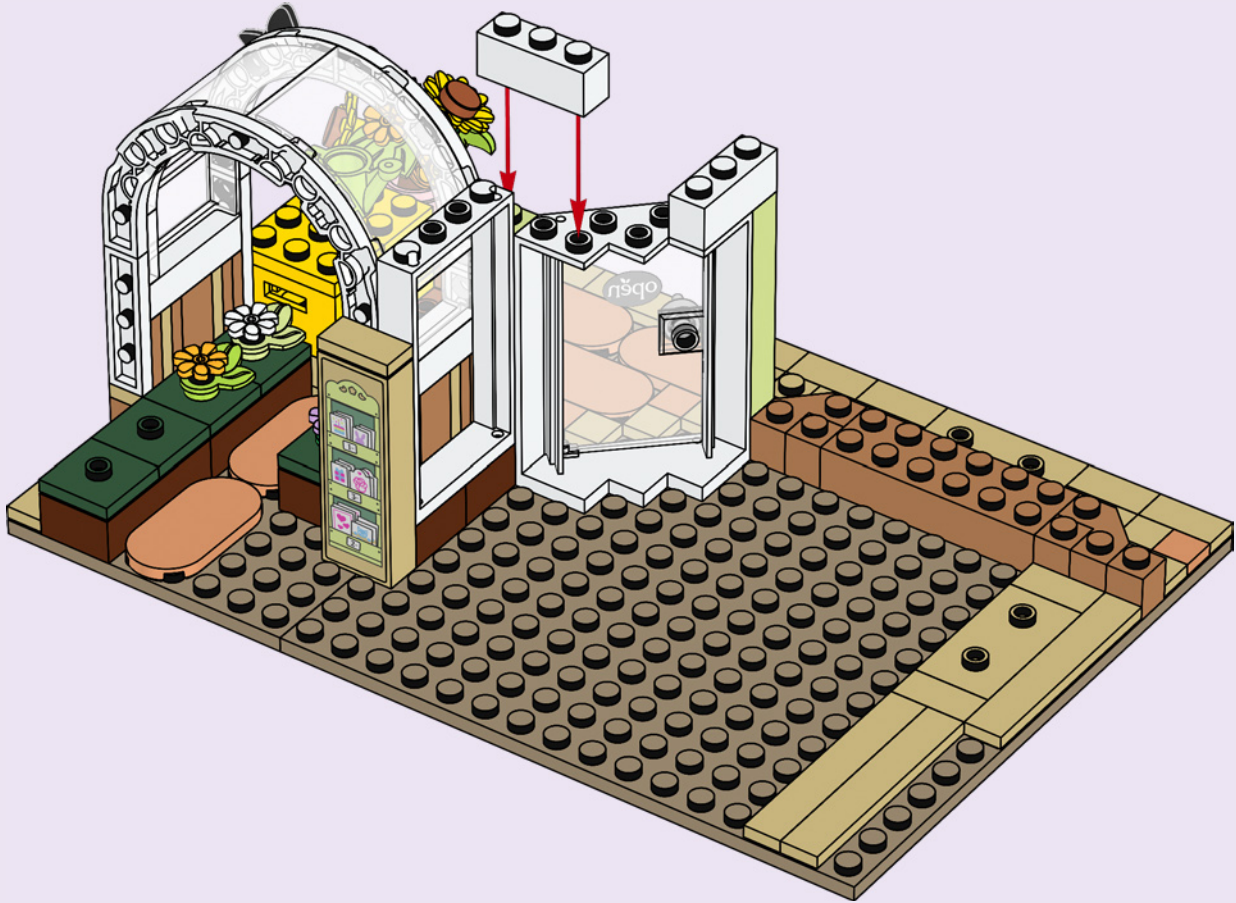



1x

44



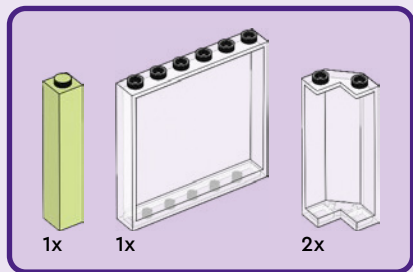

45



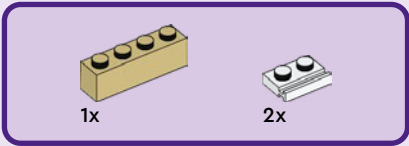

46



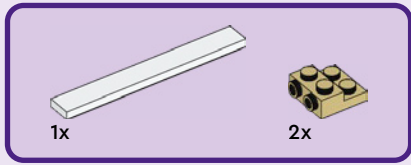

47

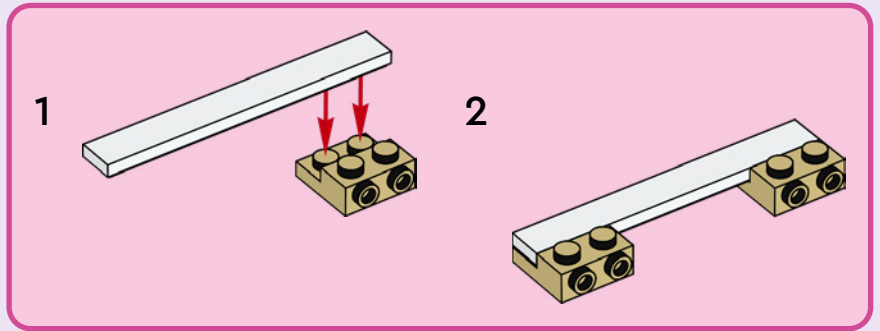



2x

48





2x

49



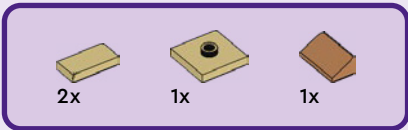

50





51

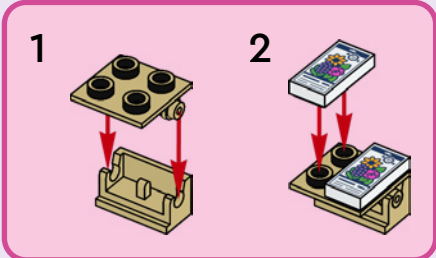



52

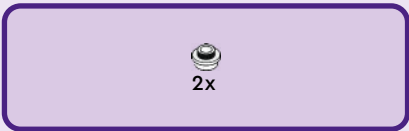
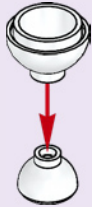

53

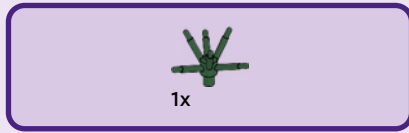
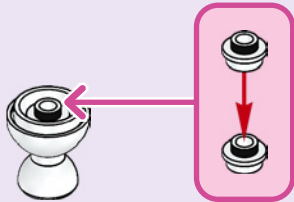

54





55

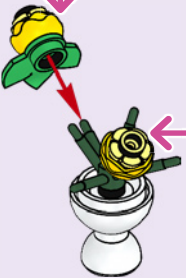
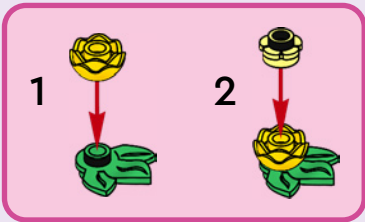

56

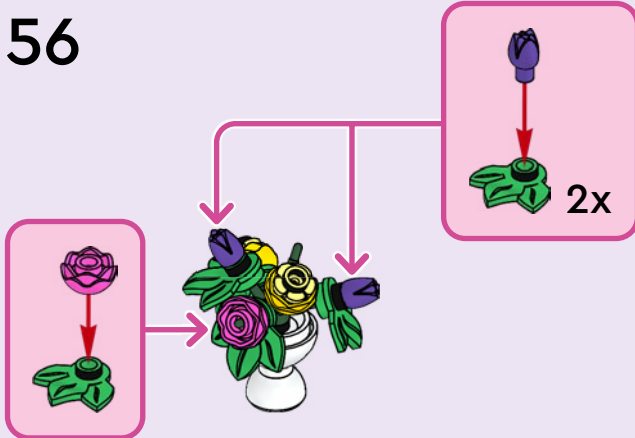

57

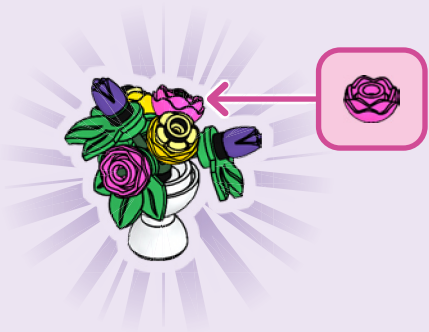

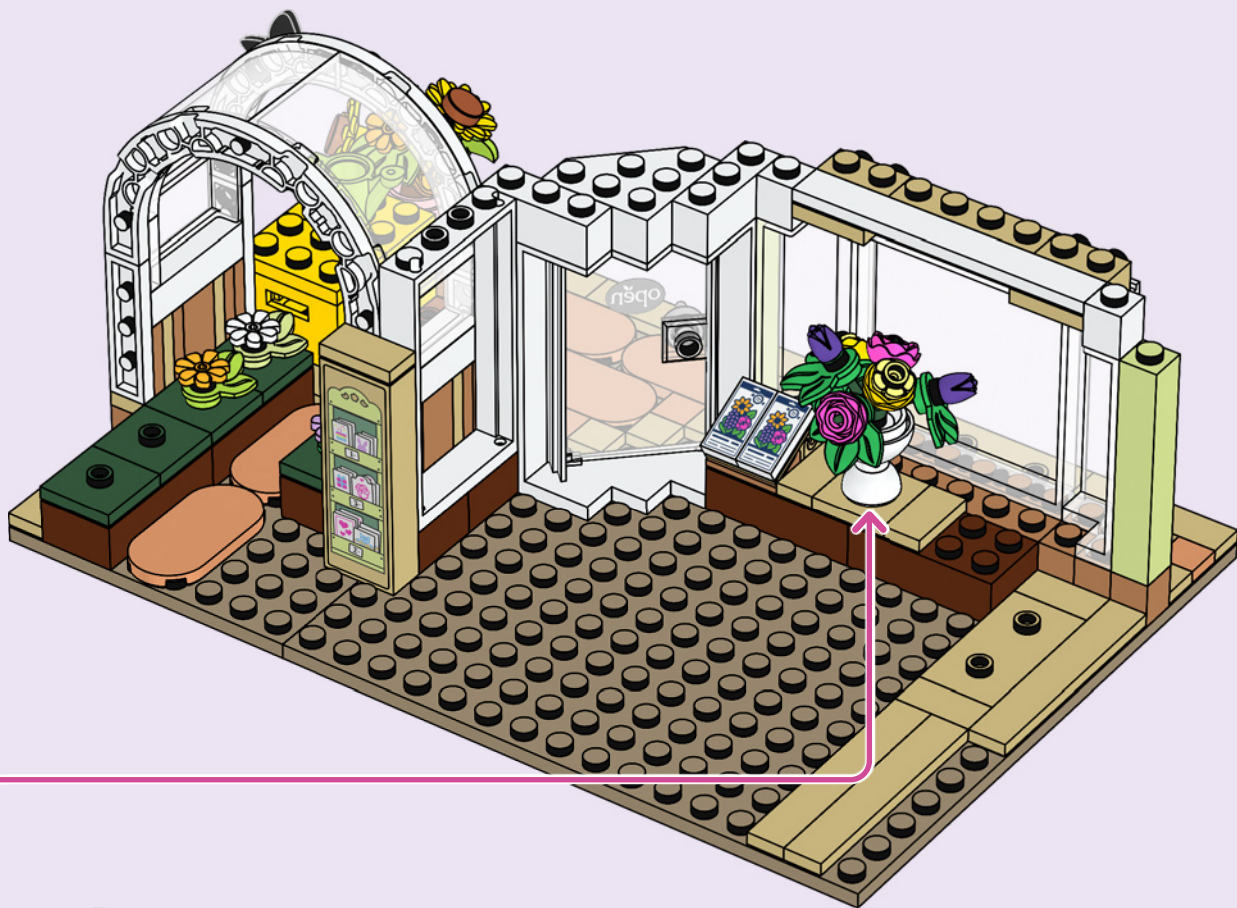



1x

59



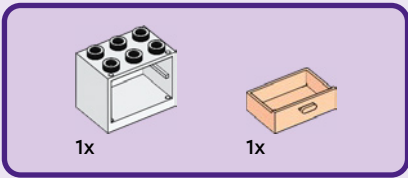

60

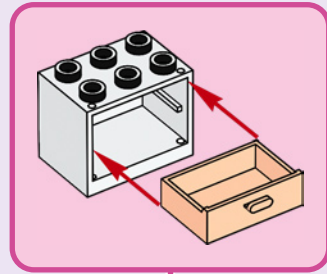

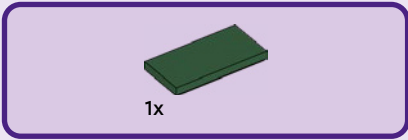

61

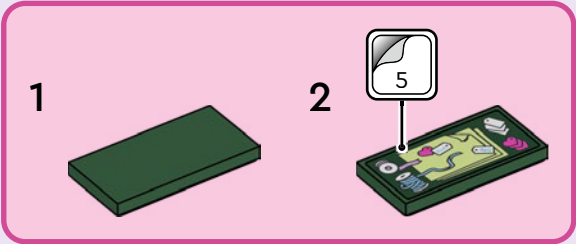

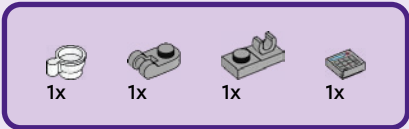

62



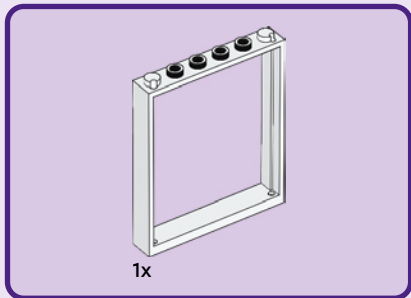

63



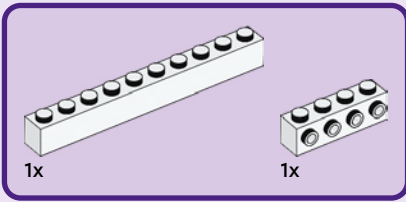

64

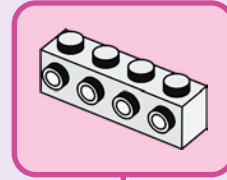

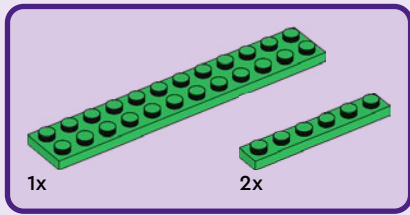

65



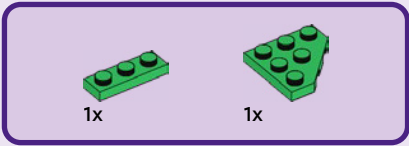

66





3x

67





1x

68



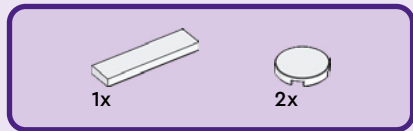

69



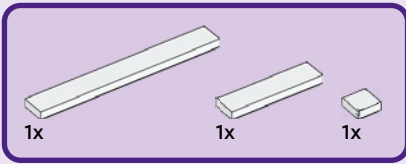

70



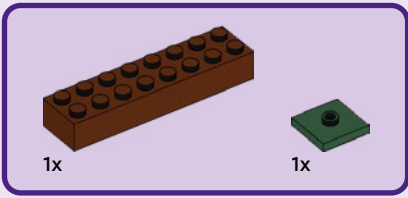

71

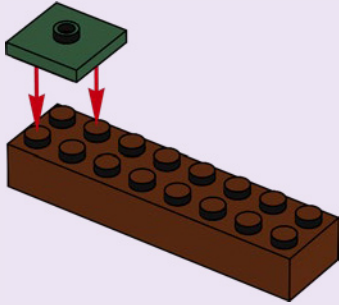

72

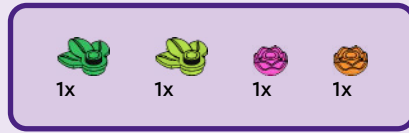
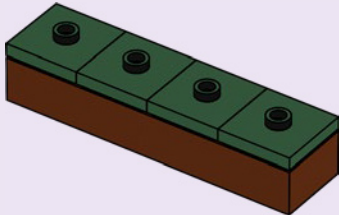

73

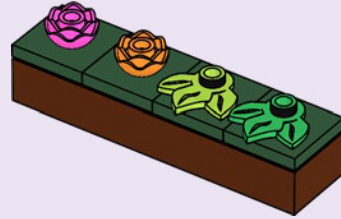

74

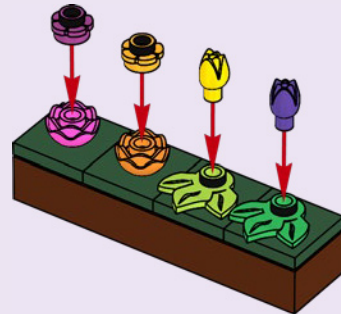

75

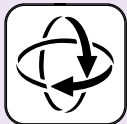

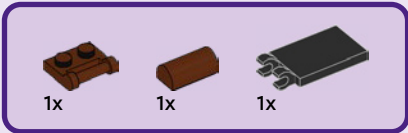



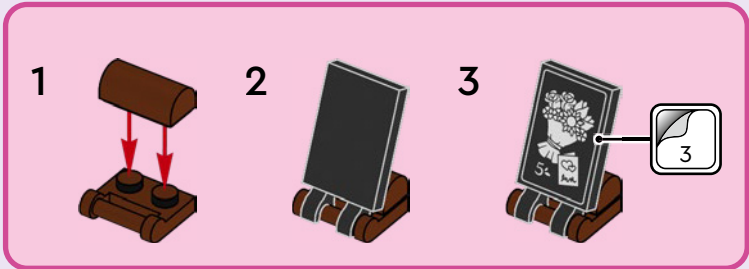

76





			
2x	2x	2x	2x

77

1 

2 

3  2x



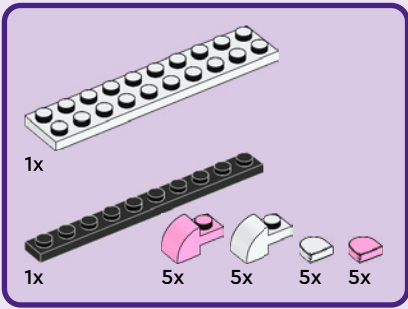

78

1

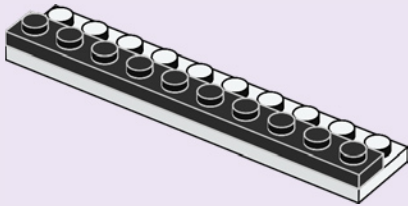

2

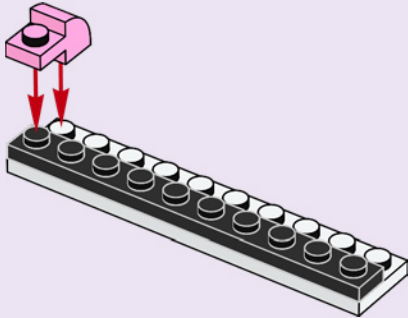

3

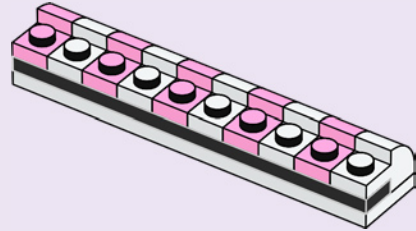

4

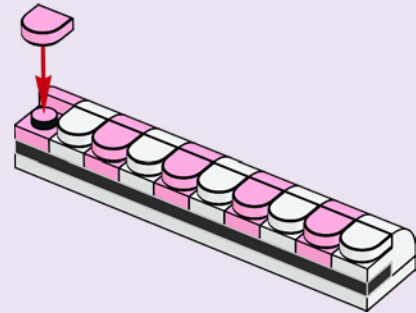

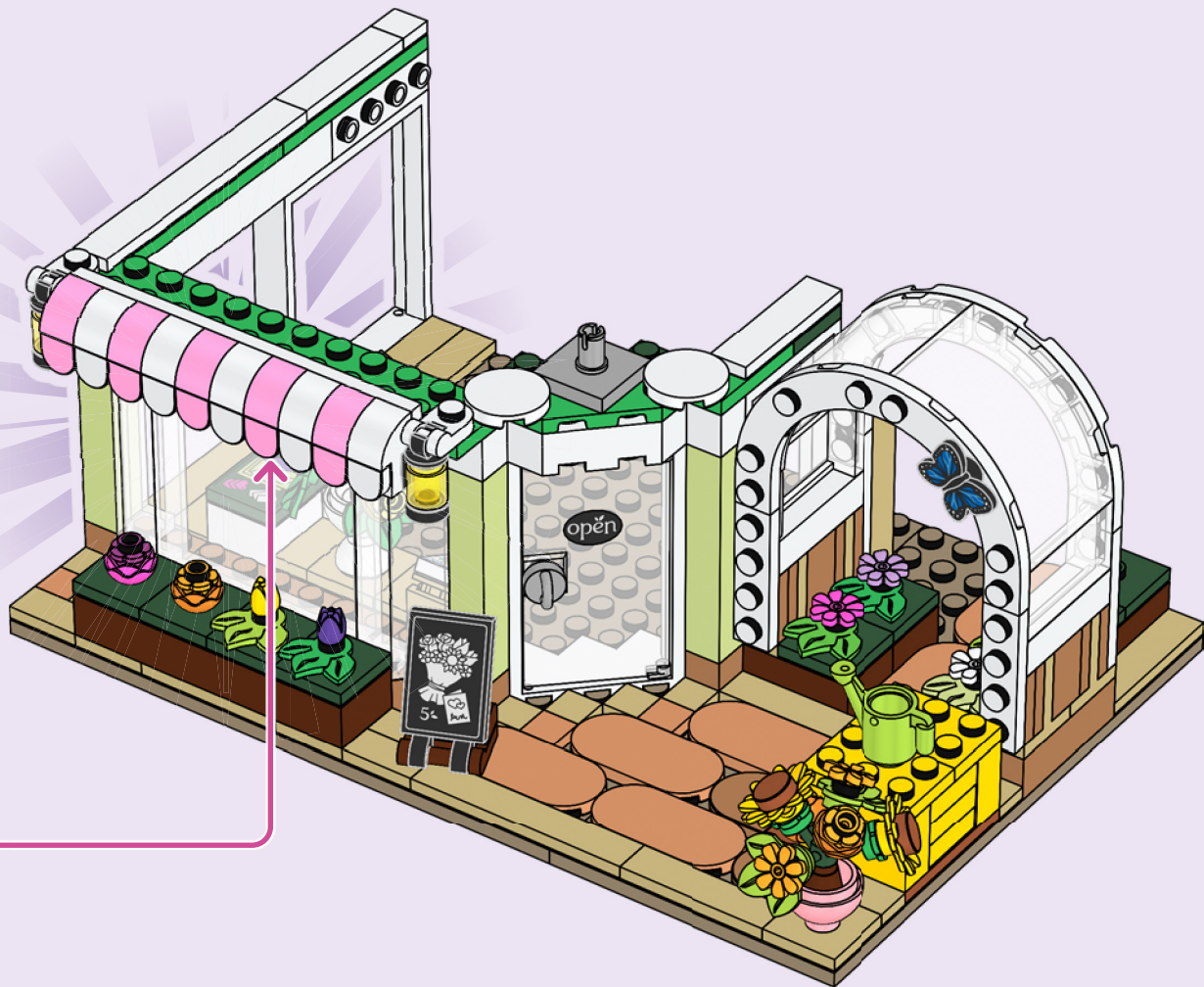



2x



2x

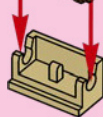

2x

79

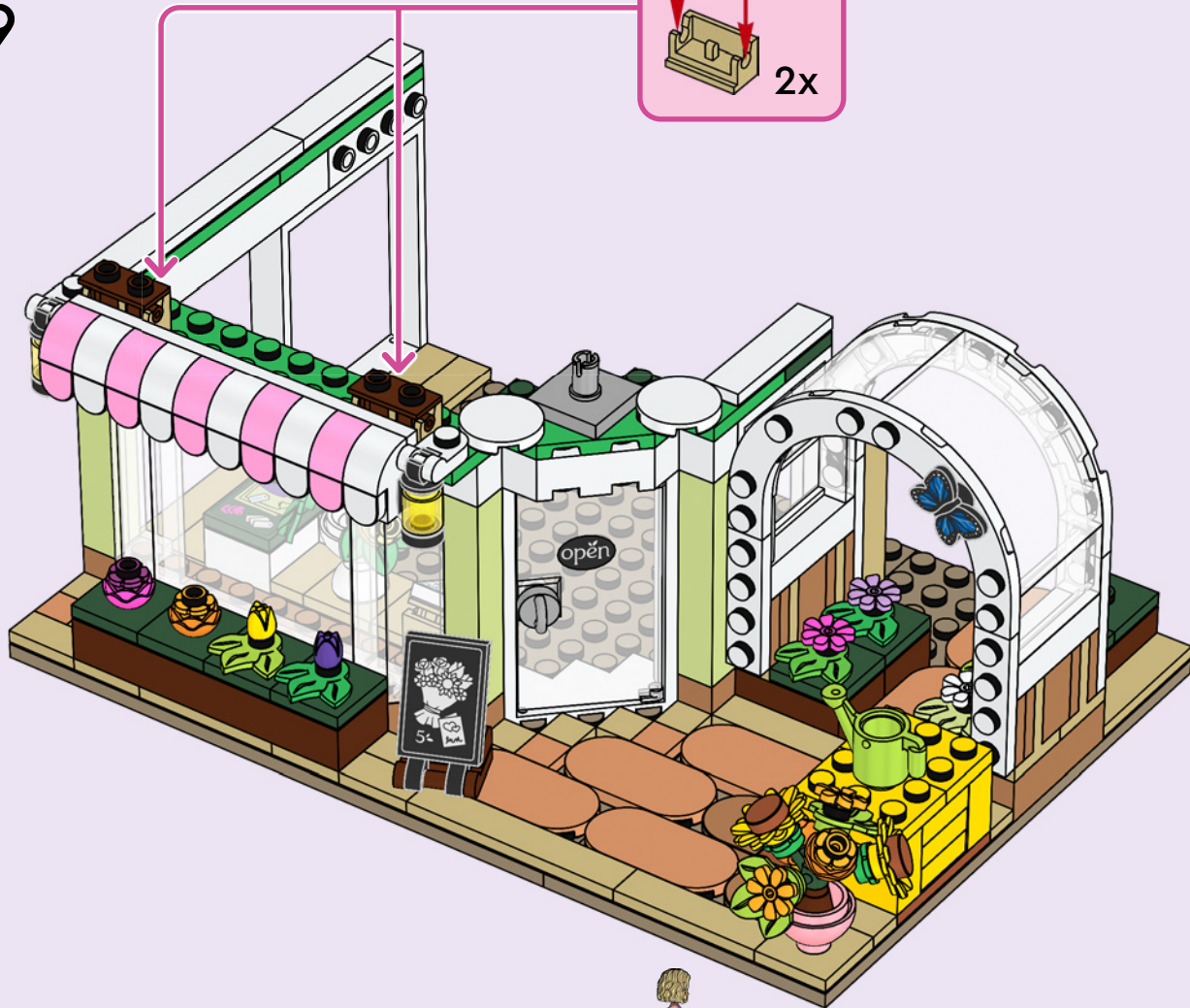

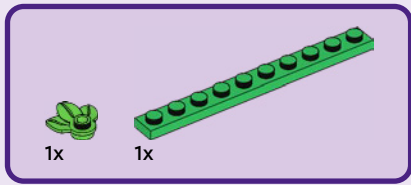

80

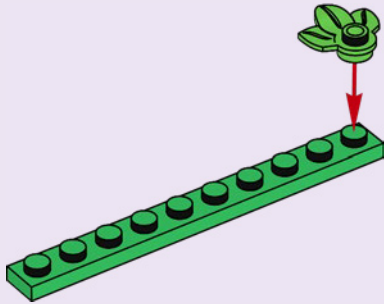

81

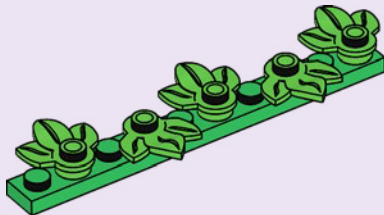

82

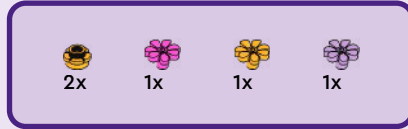
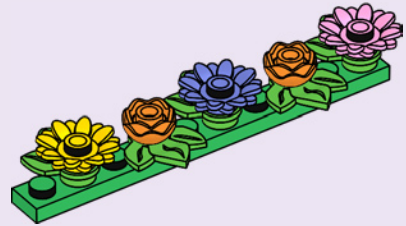

83

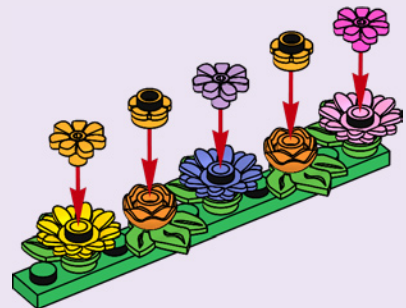

84

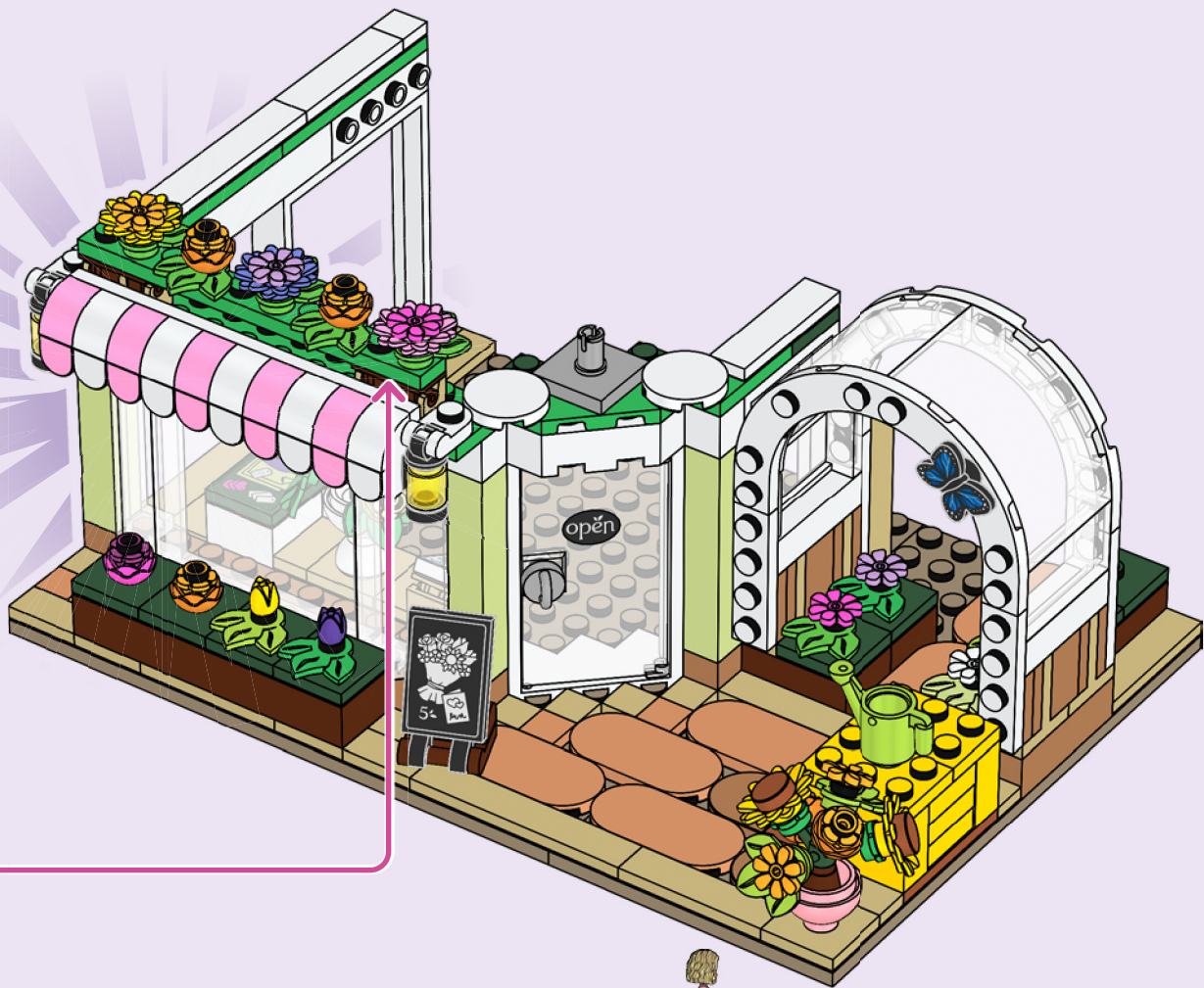

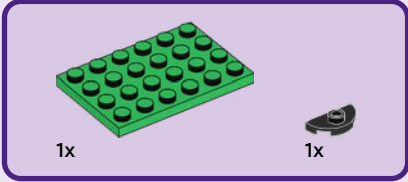

85

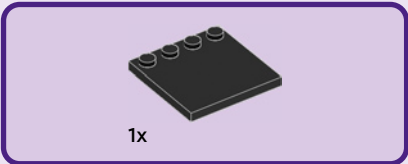
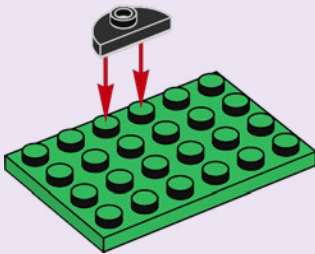

86

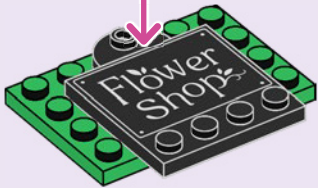
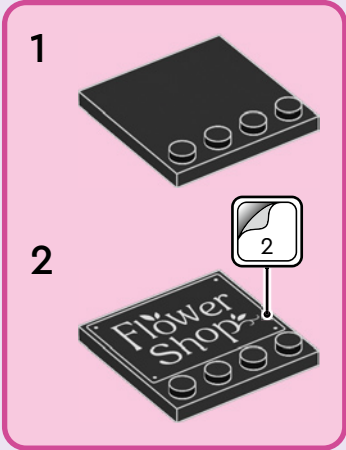

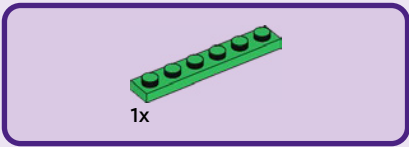

87

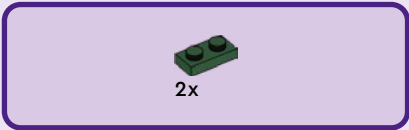
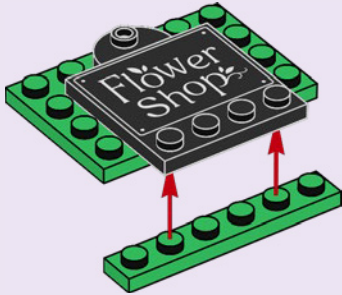

88

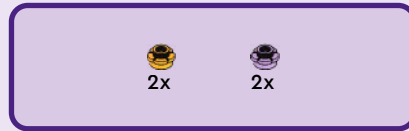
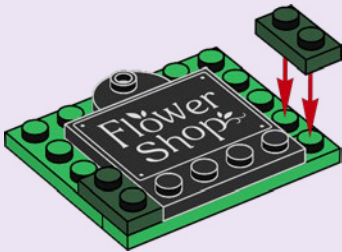

89

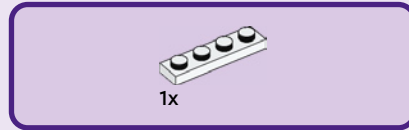
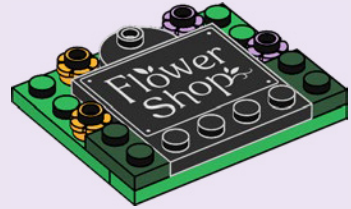

90

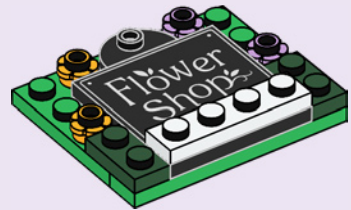

1x

1x

91

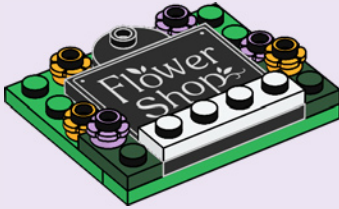

2x

1x

92

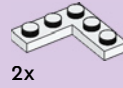
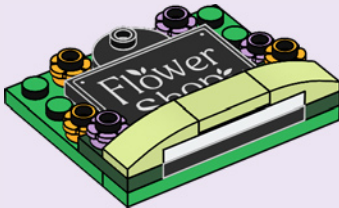

2x

93

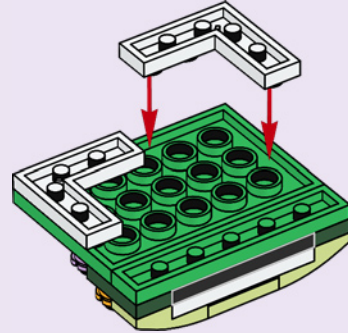
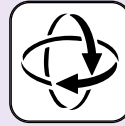

1x



1x

94

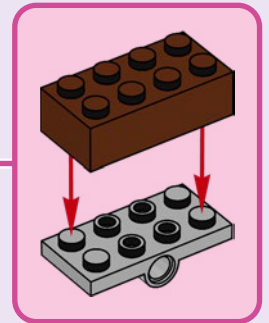
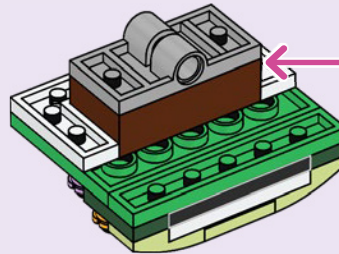



95

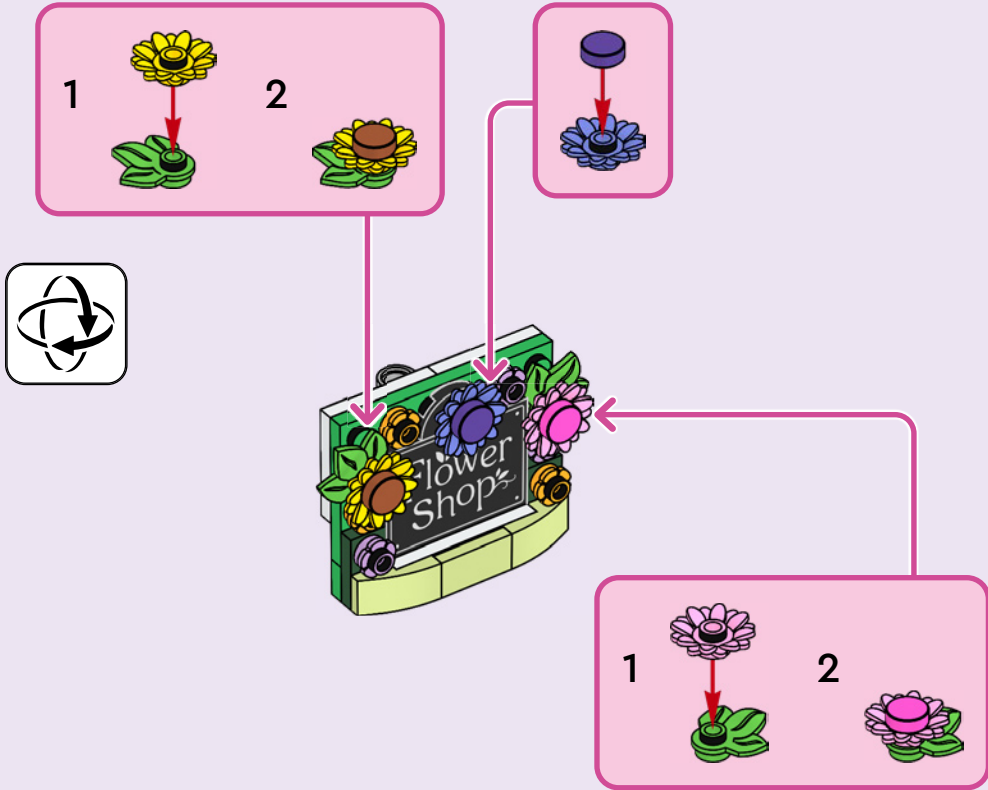



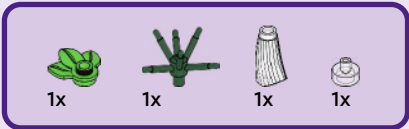

97

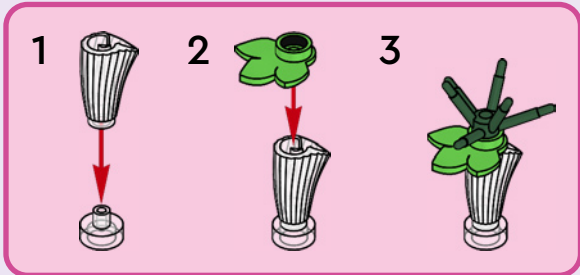

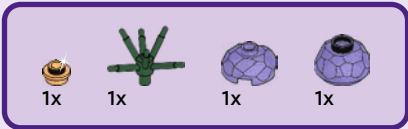

98

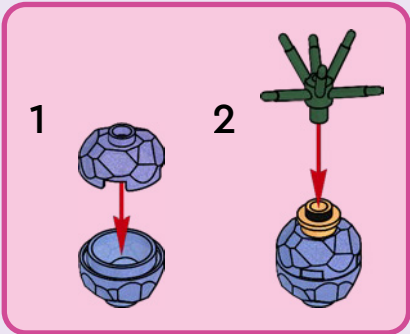

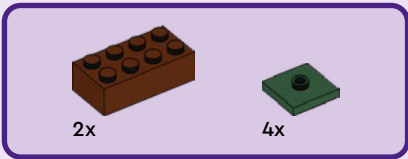

99

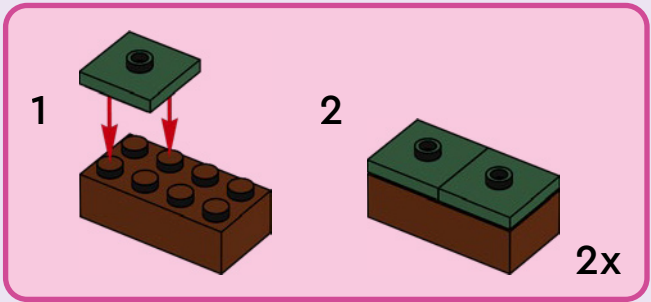

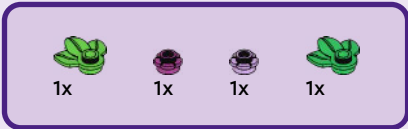

100

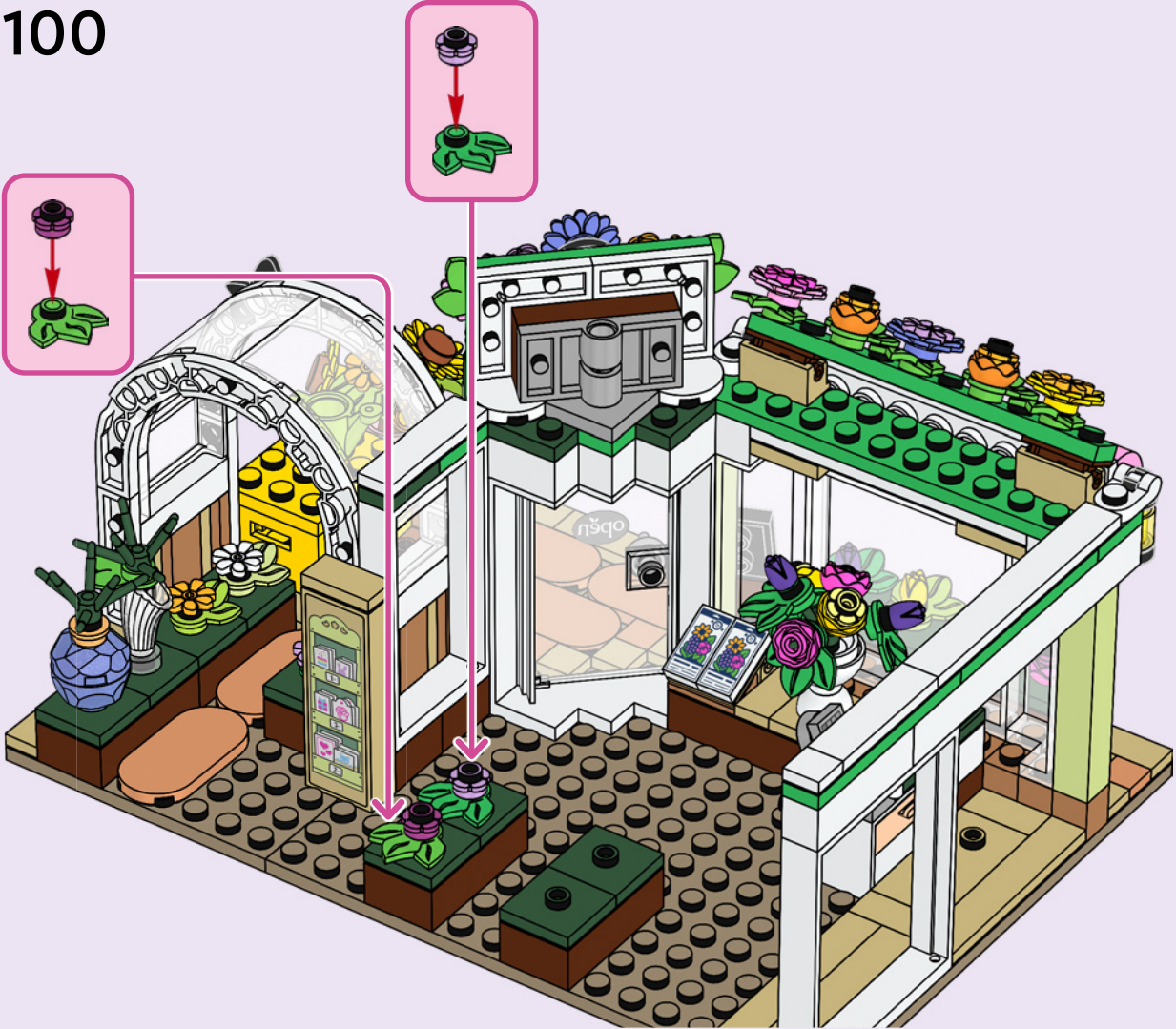

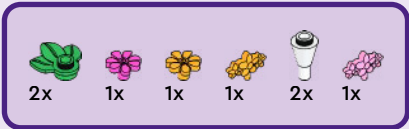

101

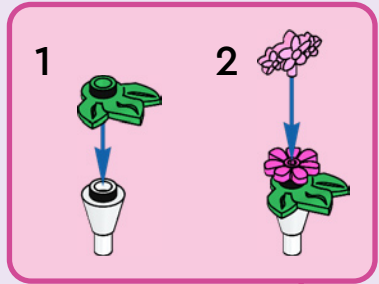
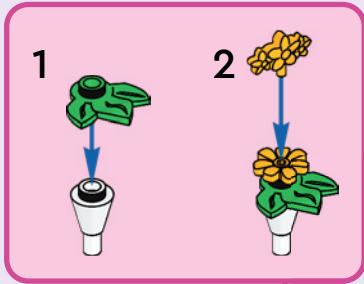

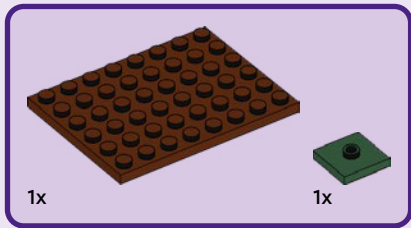

102

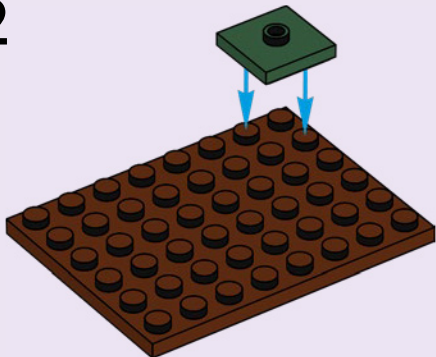

103

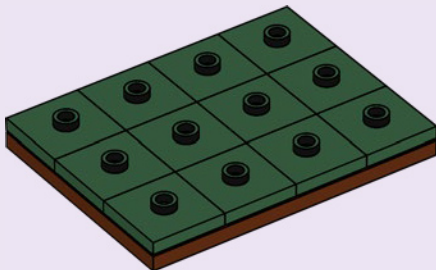

104

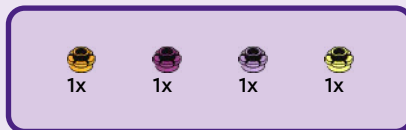
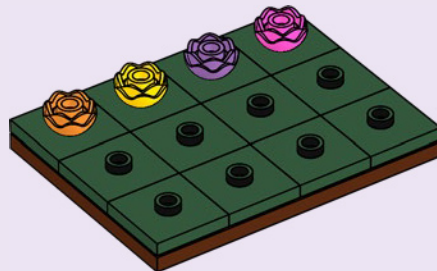

105

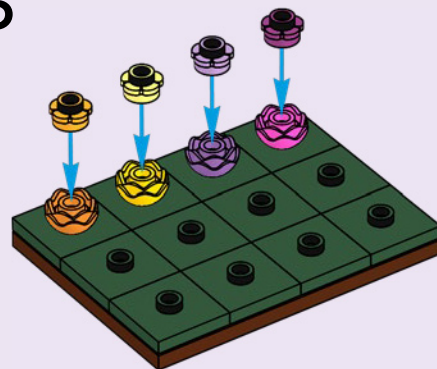

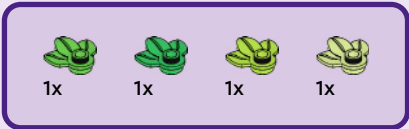

106

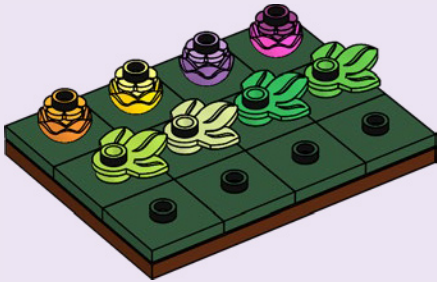

108

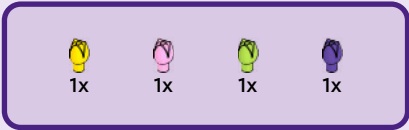

107

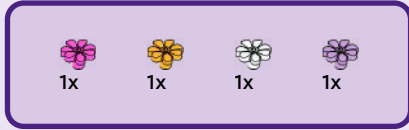
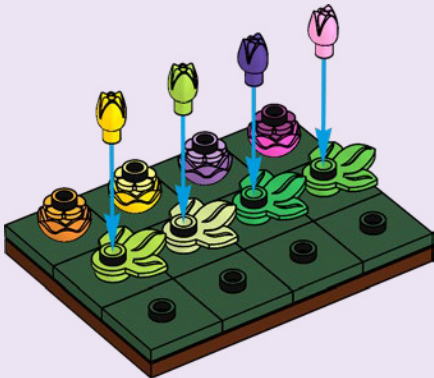

109



110



1



2



3

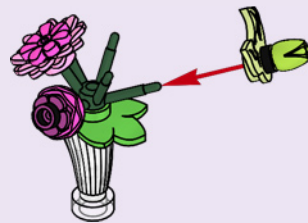





Friends

Watch
series
online



Watch series online / Schau dir die Serie online an / Regarde la série en ligne / Guarda la serie online / Mira la serie en Internet / Assistir à série online / 在线观看 / Oglądaj serial w internecie / Sleduj serial online / Pozri si serial online / Nézd a sorozatot online / Дивіться серіал онлайн / Vizionează serialul online / Глядайте серіала онлайн / Skaties seriālu tiešsaistē / Vaata sarja veebist / Žiūrėk serialą internetu / Diziyi çevrim içi izle

LEGO

Friends

42700



42704



42676



42693

42688



2x 6168642	2x 4249563	1x 6177157	3x 6174919	1x 6523460	1x 447726	2x 6092602
2x 6593092	1x 300301	1x 6177157	12x 4114026	6x 6551499	2x 6135287	1x 6288614
5x 6250591	2x 362201	1x 6256127	1x 4114064	2x 6500394	10x 6229130	1x 6507895
2x 6452532	1x 6210105	1x 6256127	4x 6453349	3x 6594861	1x 4295260	1x 6576898
1x 6221783	1x 6210105	2x 416201	2x 4565387	5x 6509767	1x 6529282	1x 6503209
2x 300501	1x 4619665	2x 416201	1x 6487881	2x 302124	1x 4107758	2x 6507949
1x 307001	1x 4143254	2x 6592326	2x 6469454	1x 6284070	3x 366628	2x 6539353
2x 6055541	2x 243101	1x 611101	1x 4113916	2x 6534180	1x 4116671	2x 6540807
1x 6235083	5x 371001	1x 383201	5x 4550324	1x 6510061	1x 6467868	1x 6514119
2x 6174937	1x 6262945	8x 4125253	2x 6294227	1x 6070695	1x 6218146	1x 6514106
1x 6050914	2x 6428165	1x 4159553	4x 4157277	1x 6435109	12x 6182261	
1x 6545156	2x 6428165	1x 6409761	1x 6416619	1x 6360129	3x 6322840	
2x 6044691			3x 6419170	1x 617926		
5x 6519988						
2x 6520142						

- 2x 6514236
- 7x 6550815
- 1x 6529813
- 5x 6286831
- 1x 6361353
- 3x 6209682
- 5x 6214235
- 1x 6138657
- 3x 6580722



- 1x 6591323

- 1x 4624163

- 1x 4613196

- 1x 6581591
- 5x 6013102
- 26x 6186827
- 4x 6398343



- 1x 6440430

- 10x 6209681

- 6x 6452531

- 1x 6567386

- 1x 4529242

- 2x 6560255

- 1x 6433392

- 1x 6236915



- 9x 4211201

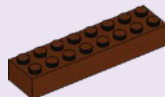

- 1x 6096701



- 1x 4223729

- 1x 6539381

- 1x 6329583

- 1x 6225246

- 1x 6326078

- 1x 6313188

- 2x 4644102

- 1x 6176242

- 1x 6322821

- 4x 6550578

- 4x 6452523

- 1x 6519672

- 5x 6258972

- 1x 6605571

- 3x 6572910

- 5x 6526031

- 3x 6426463

- 1x 6600751

- 4x 6601344

- 1x 6476247

- 1x 6581564

- 1x 6605033

- 1x 6560155

- 1x 6190252

- 1x 6520665

- 1x 6489198

- 5x 6057986

- 1x 6218358

- 8x 6218360

- 2x 4569382

- 2x 6513939

- 2x 6469952

- 1x 6223183

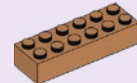

- 1x 6350413

- 1x 6225073

- 1x 6550818

- 3x 6478829

- 2x 6541652

- 1x 6566886

- 2x 6443914

- 1x 6605713

- 1x 6605712

- 1x 6584822

- 3x 6584690

- 1x 6483118

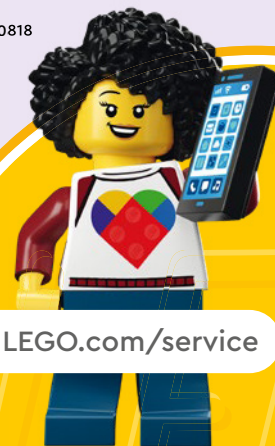

[LEGO.com/service](https://www.LEGO.com/service)

YOU COULD **WIN**



Scan this QR code or go to **LEGO.COM/PRODUCTFEEDBACK** and give us your short feedback about this LEGO® set for a chance to win a cool LEGO prize.

Terms and Conditions apply*

EN: YOU COULD WIN. Terms and Conditions apply* **DE: Du könntest GEWINNEN.** Es gelten die Teilnahmebedingungen* **FR: TU POURRAIS GAGNER.** Des conditions s'appliquent* **IT: Potresti VINCERE tu.** Termini e condizioni sono applicabili* **ES: PUEDES GANAR.** Aplican términos y condiciones* **PT: PODERÁ GANHAR.** Aplicam-se Termos e Condições* **ZH: 轻松获奖. 条款和条件适用*** **PL: Szansa na WYGRANĄ.** Obowiązuje regulamin* **CS: Máte šanci VYHRÁT.** Platí všeobecné smluvní podmínky* **SK: Máte šancu VYHRÁŤ.** Platia všeobecné zmluvné podmienky* **HU: TE IS NYERHETSZ!** Felhasználási feltételek érvényesek* **UA: ВИ МОЖЕТЕ ВИГРАТИ.** Застосовуються загальні положення та умови* **RO: Ai putea CÂȘTIGA.** Se aplică termeni și condiții* **BG: Можете да СПЕЧЕЛИТЕ.** Има определени правила и условия* **LV: Tu vari LAIMĒT.** Ir spēkā noteikumi un nosacījumi.* **ET: Sul on võimalus VÕITA.** Kehtivad tingimused* **LT: Jūs galite LAIMĖTI.** Taikomos sąlygos* **TR: KAZANABİLİRSİN.** Şartlar ve Koşullar geçerlidir*

*[LEGO.com/productfeedback-terms](https://www.lego.com/productfeedback-terms)