



11217



**WARNING: CHOKING HAZARD.**  
Toy contains small parts and a small ball.  
Not for children under 3 years.



MUM



**AVERTISSEMENT :**  
**RISQUE D'ÉTOUFFEMENT.**  
Le jouet contient des petites  
pièces ainsi qu'une petite boule.  
Il ne convient pas aux enfants  
de moins de 3 ans.



**ADVERTENCIA:**  
**PELIGRO DE ASFIXIA.**  
Juguete que contiene partes  
pequeñas y una pelota  
pequeña. No recomendado  
para niños menores de 3 años.



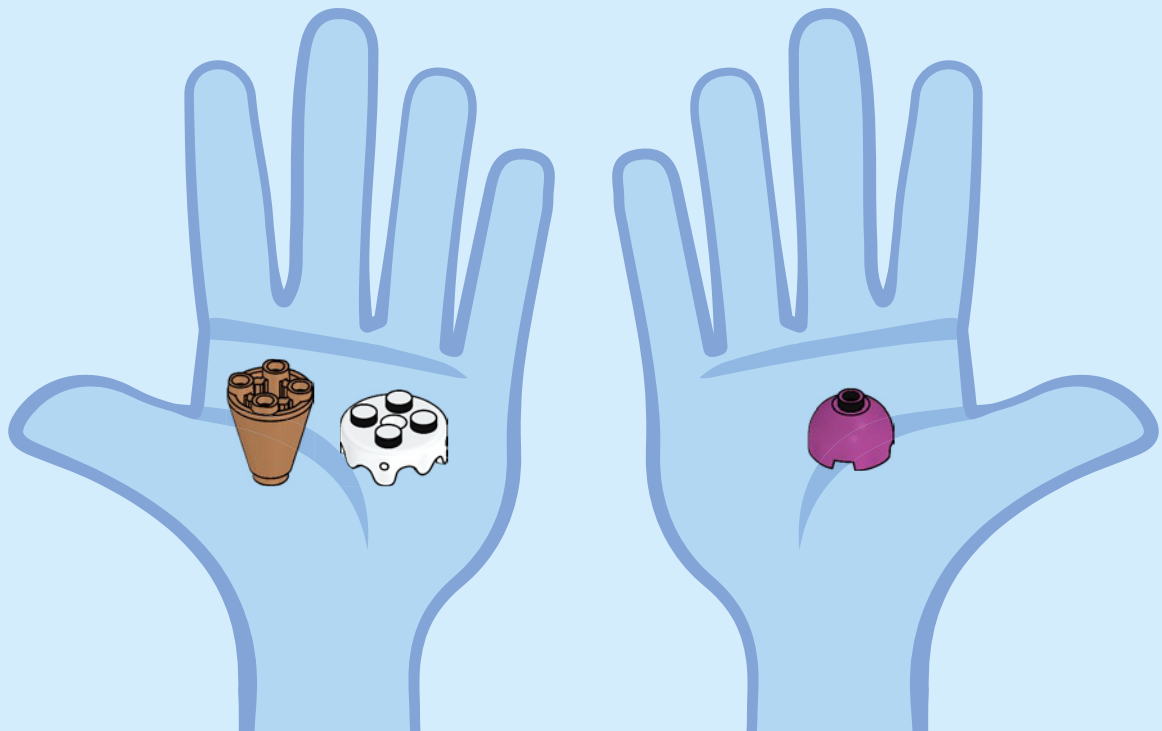



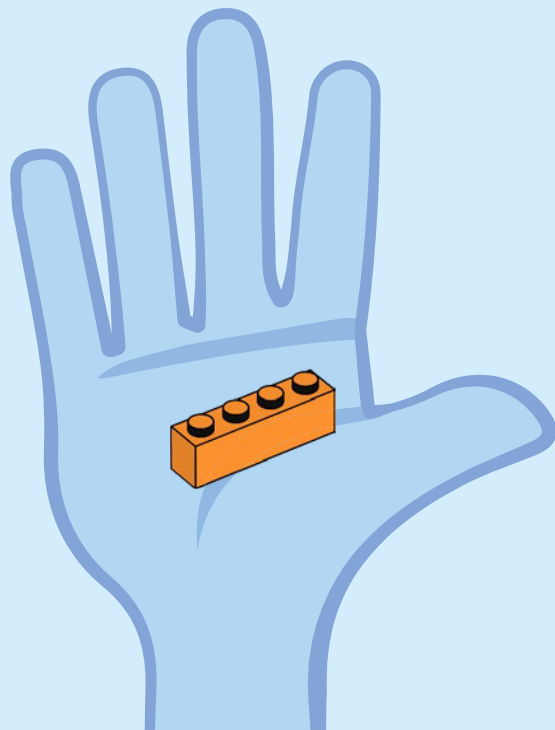
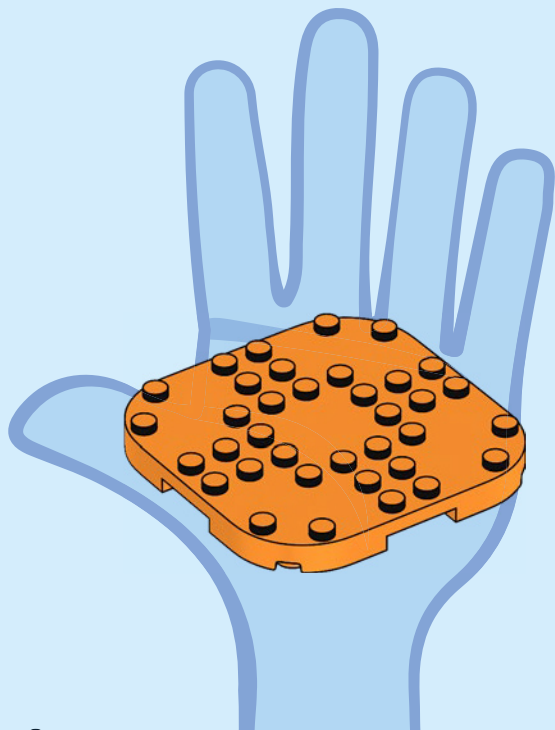

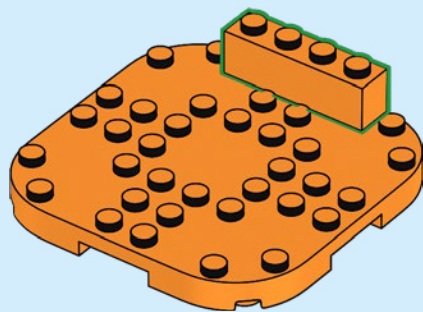
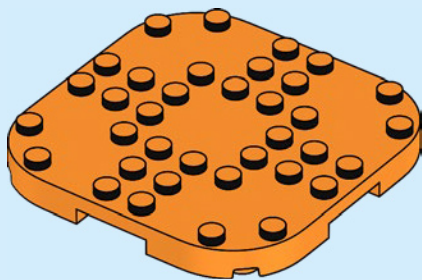

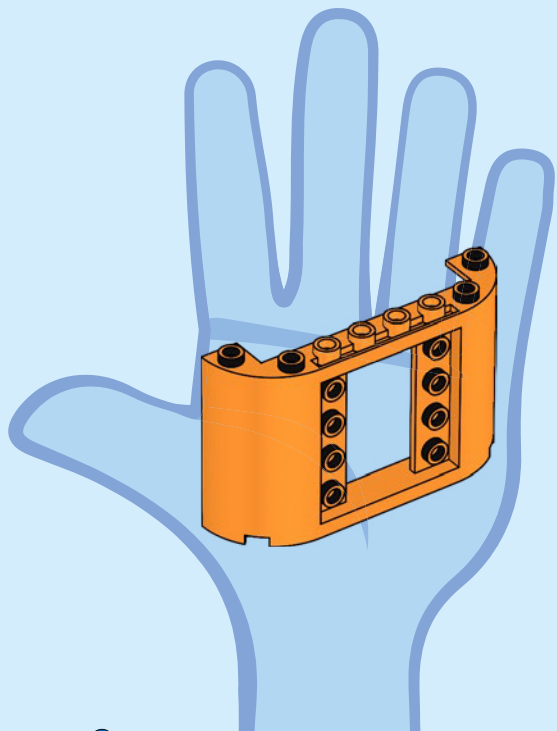

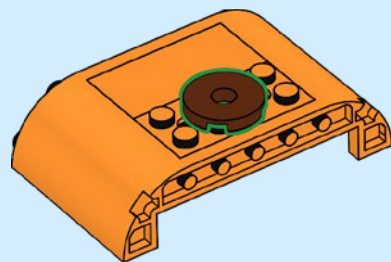
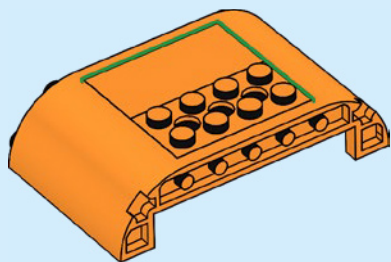
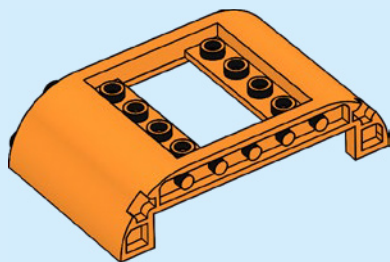

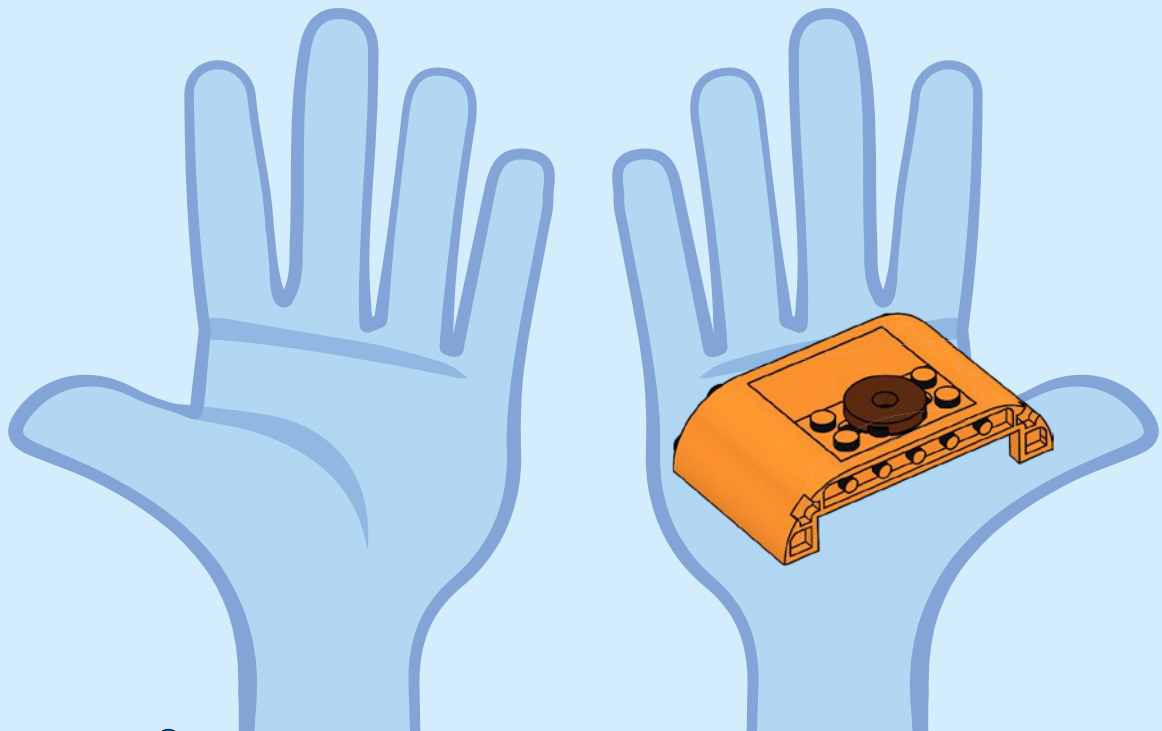

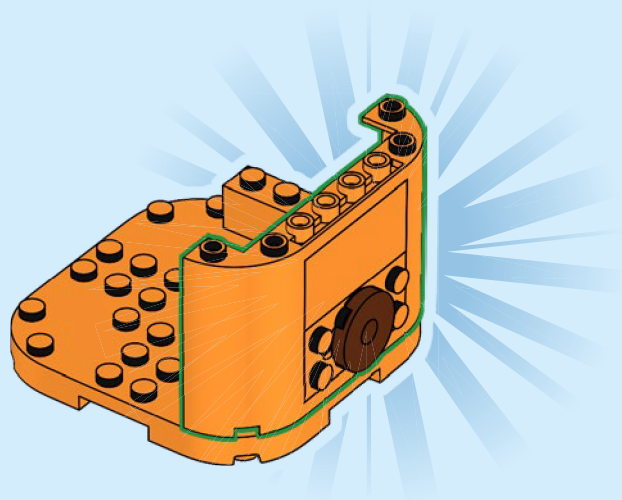

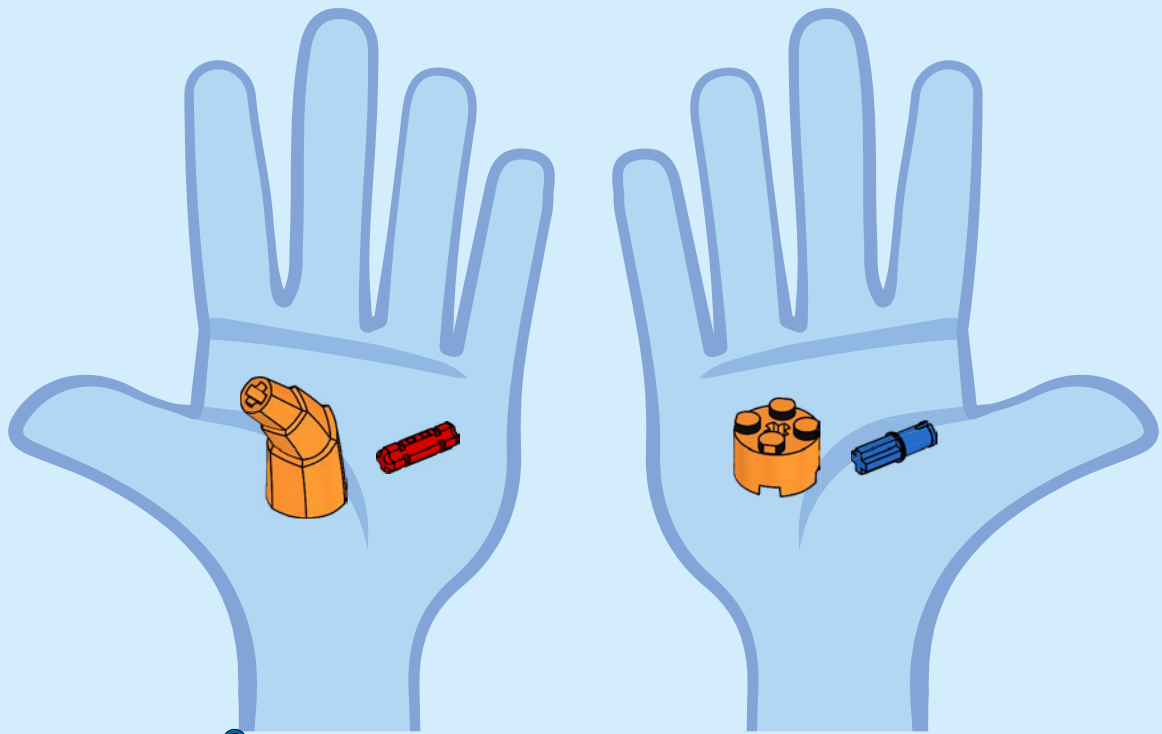

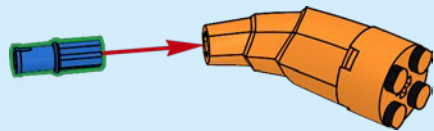
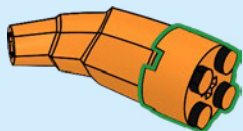
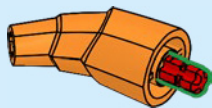
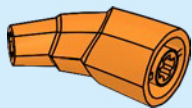

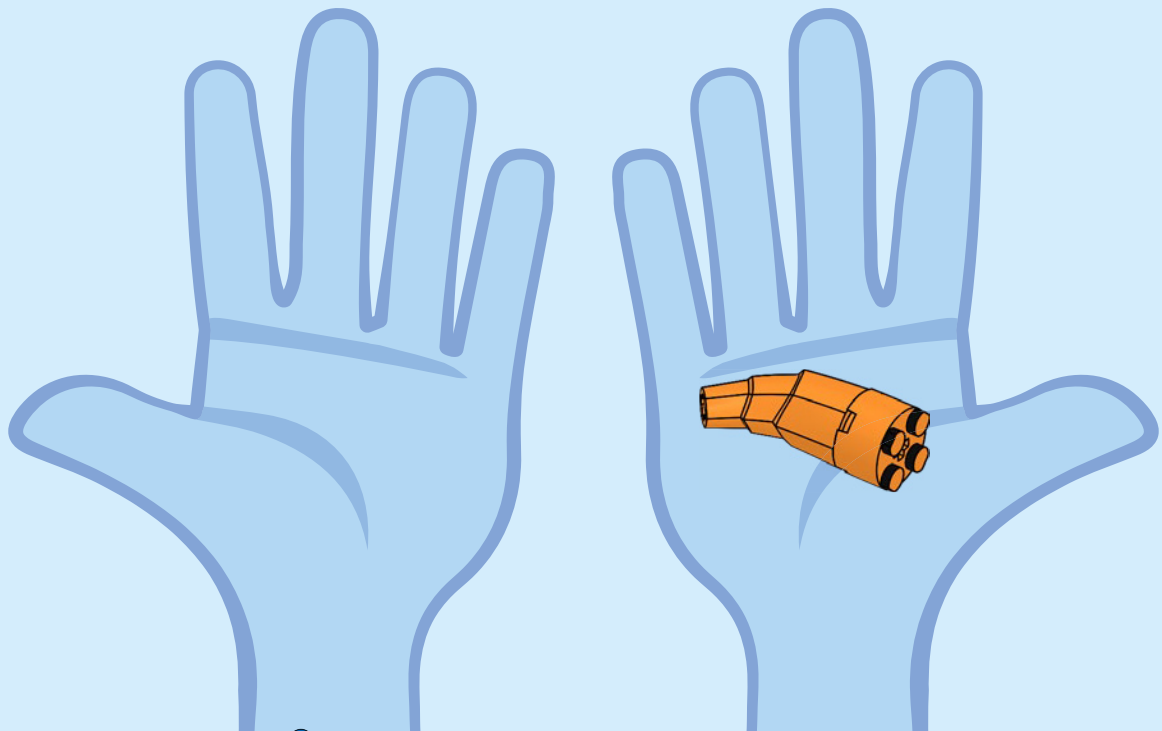

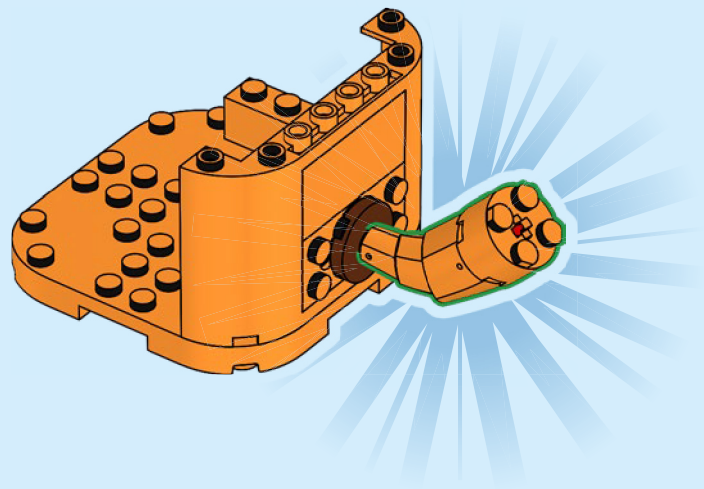

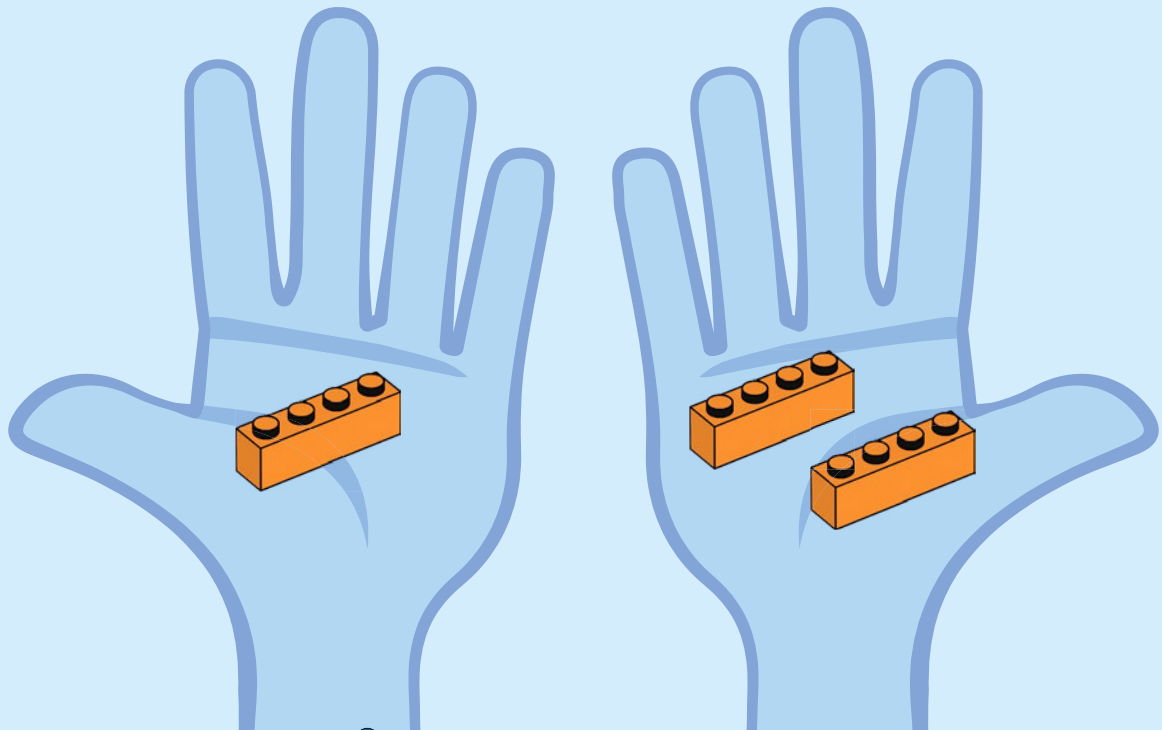

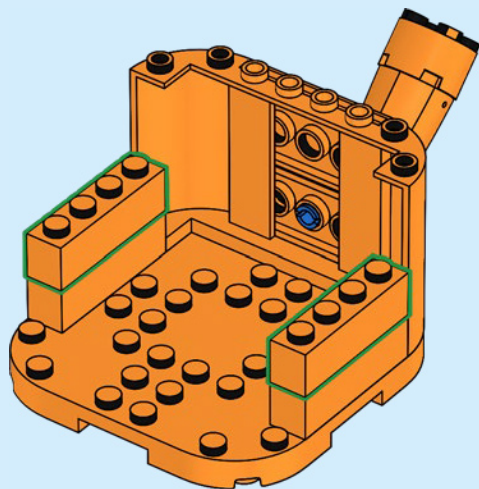
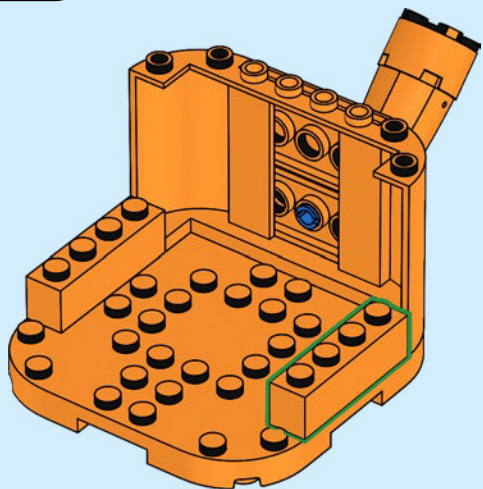

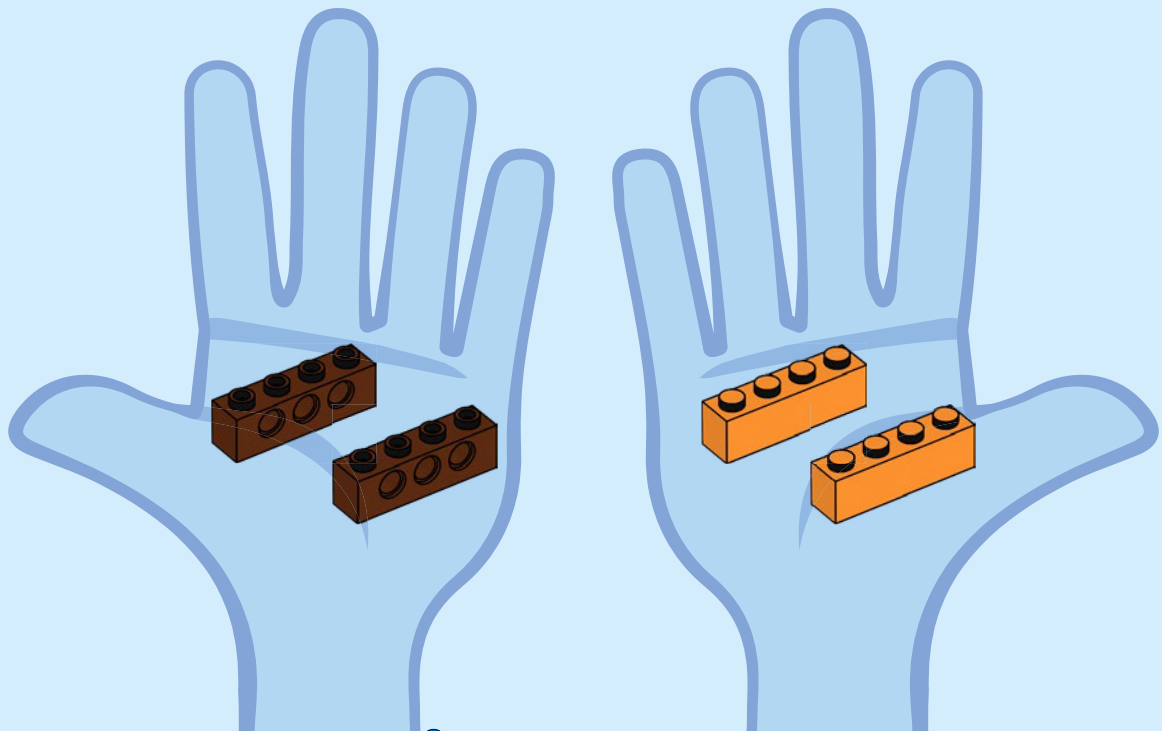

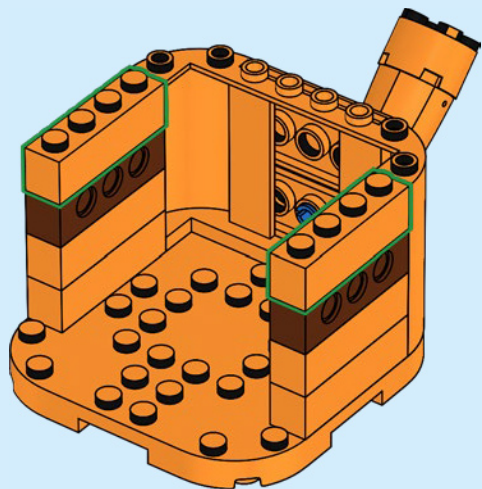
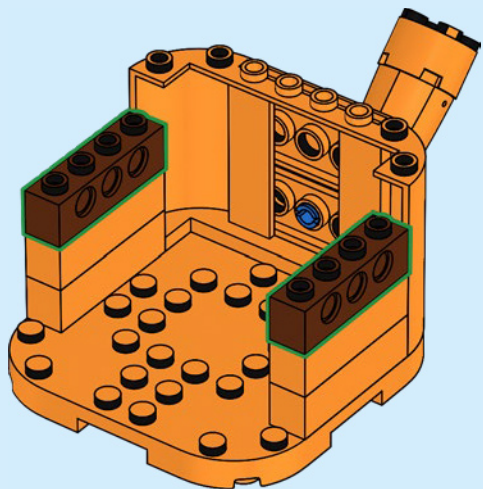



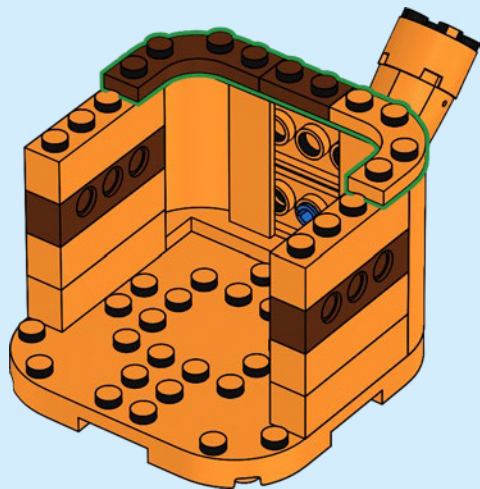

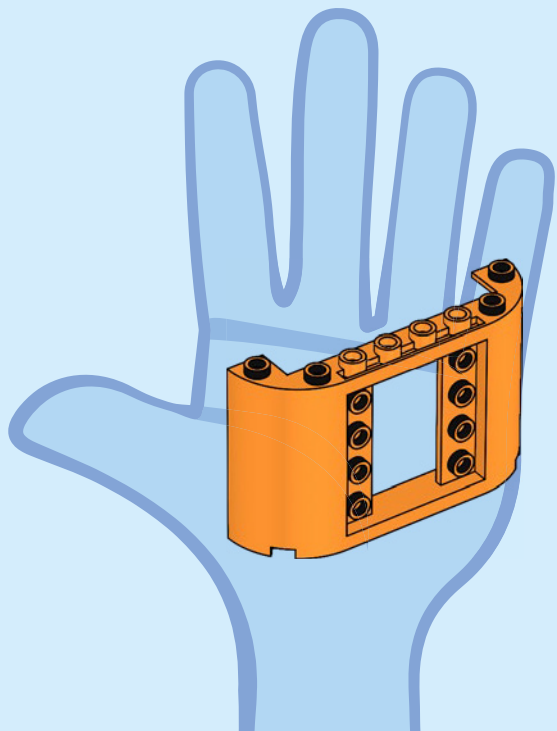

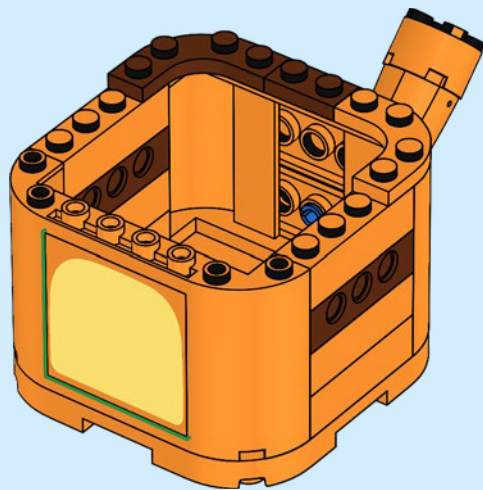
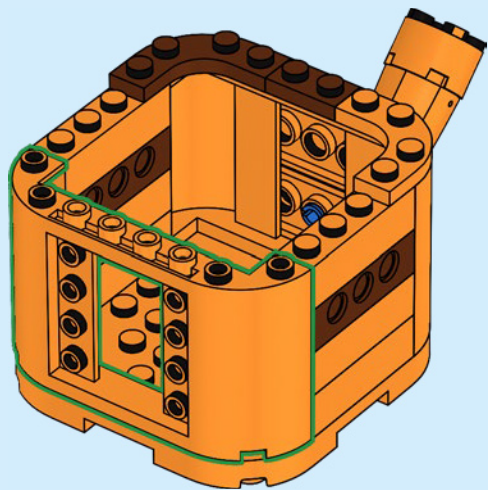



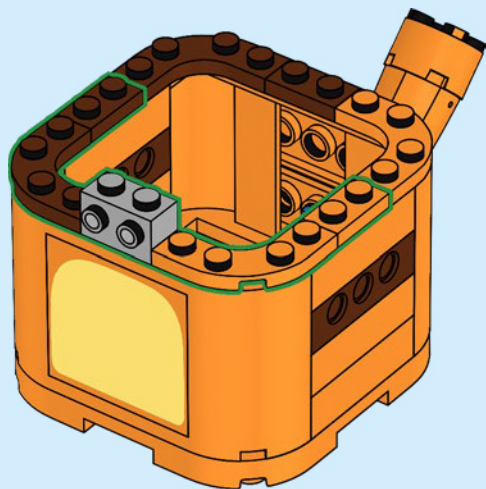

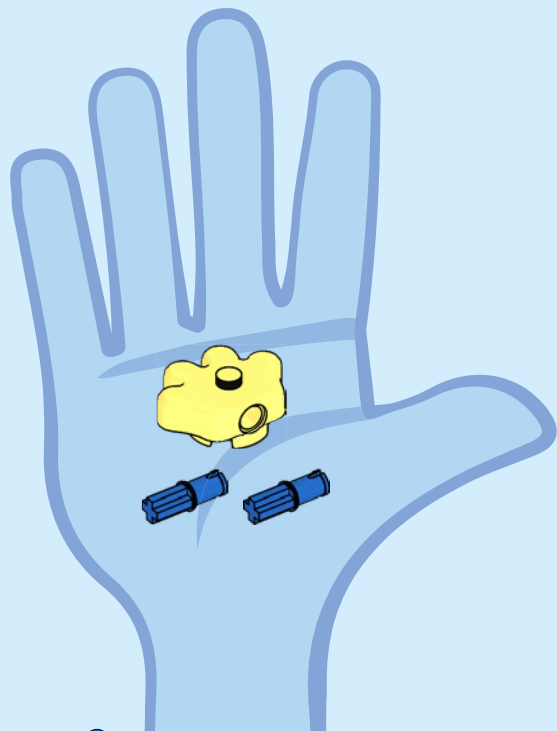

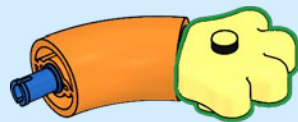
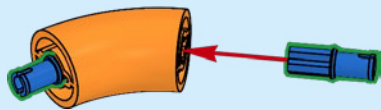
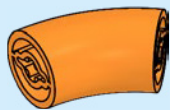

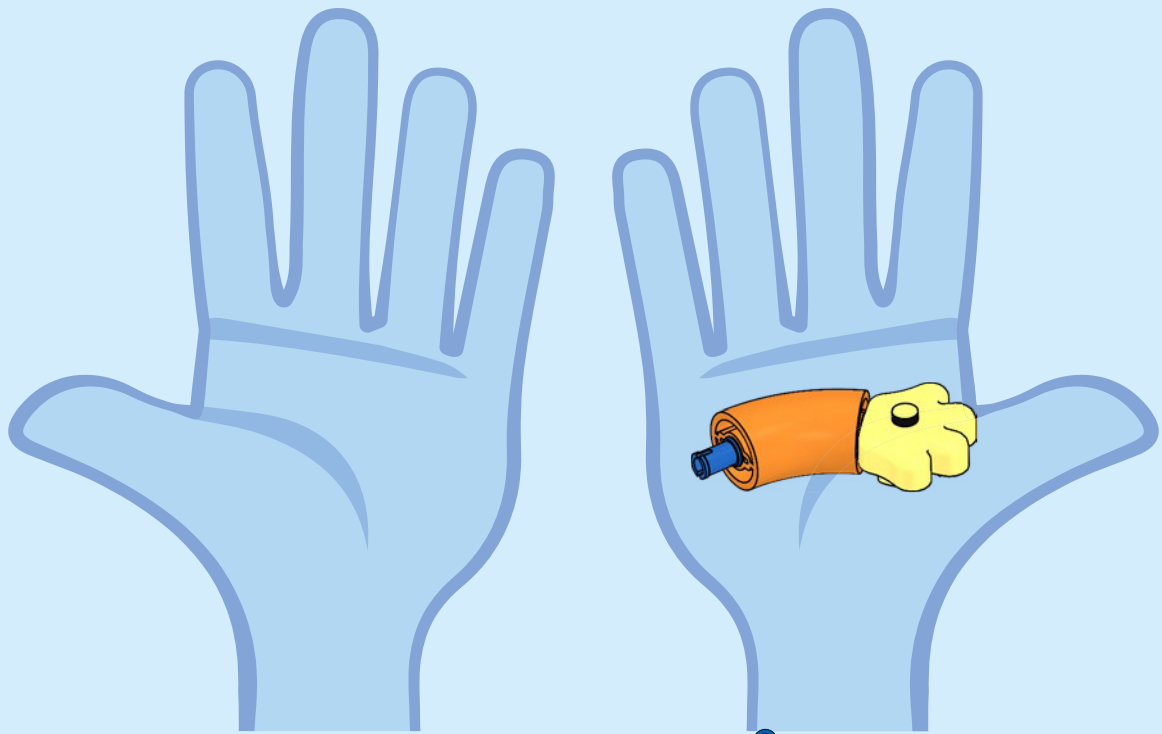

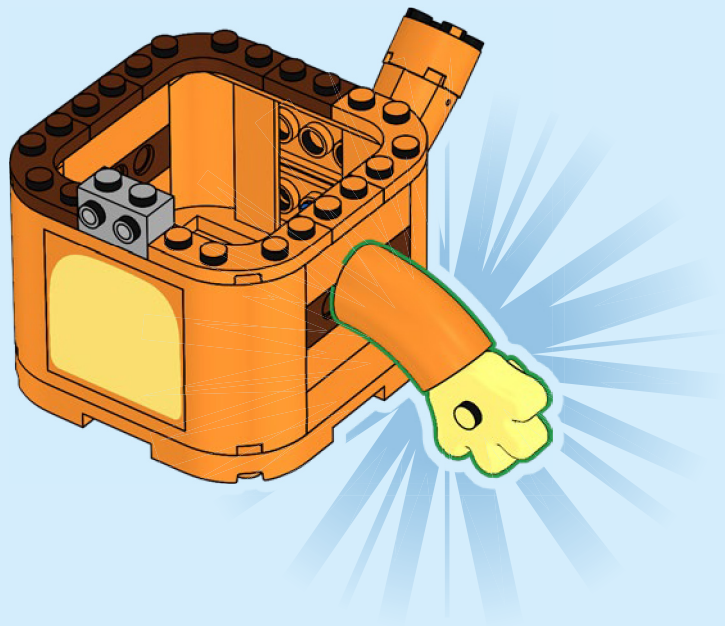

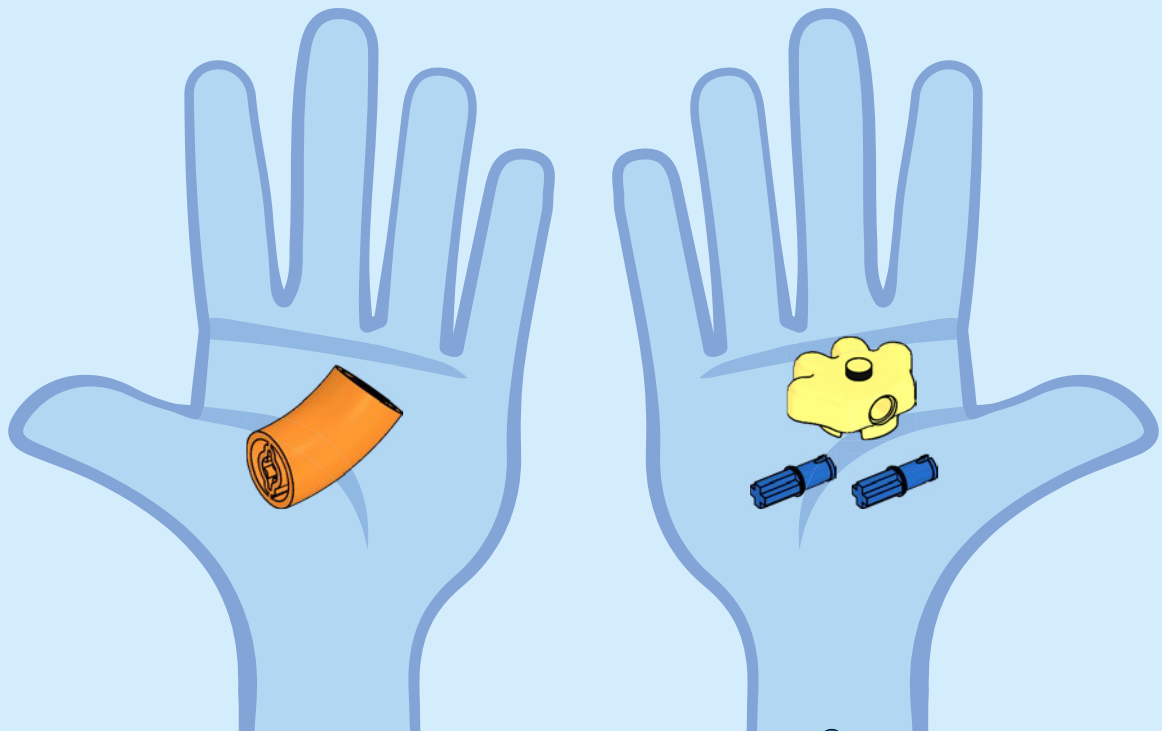

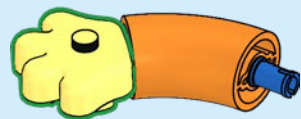
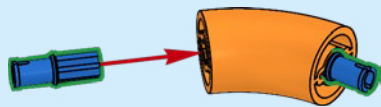

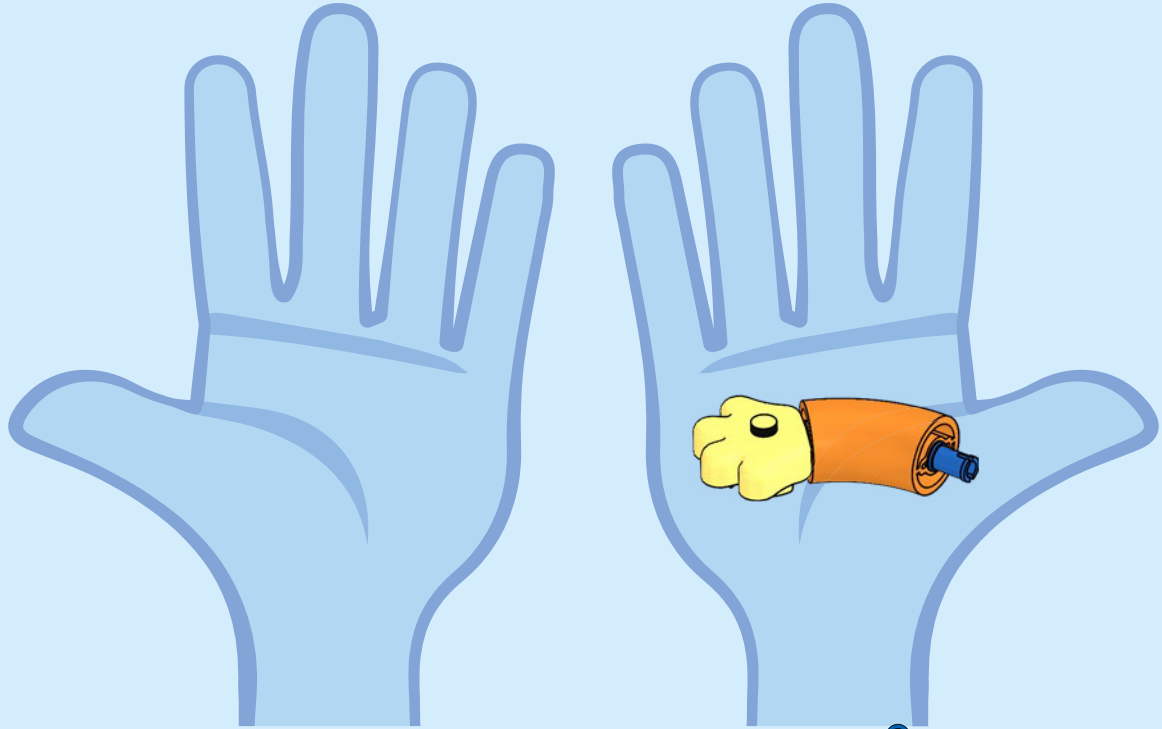

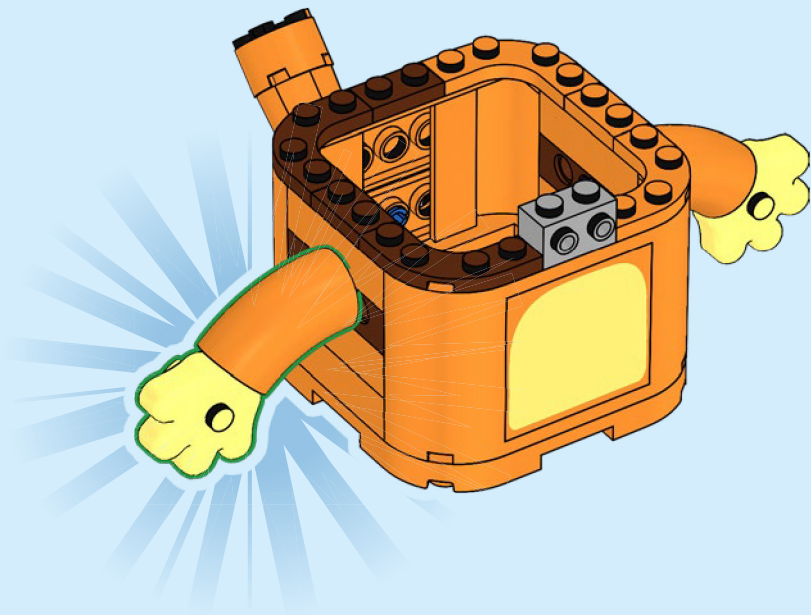

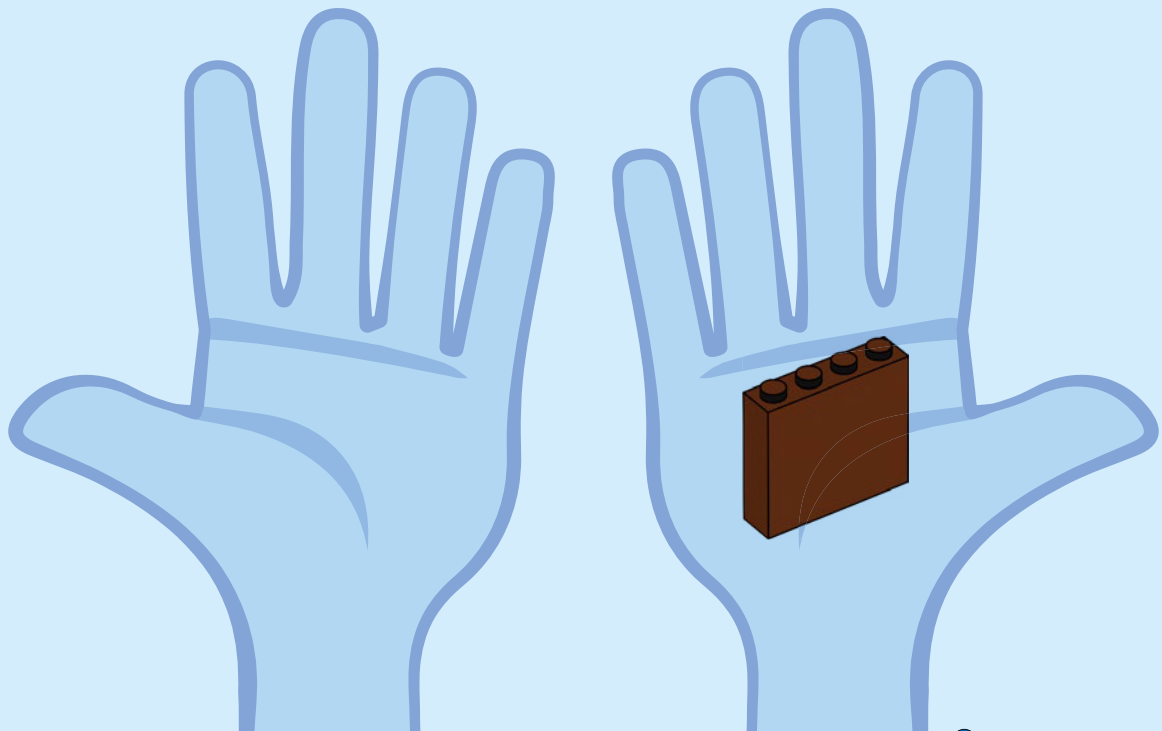

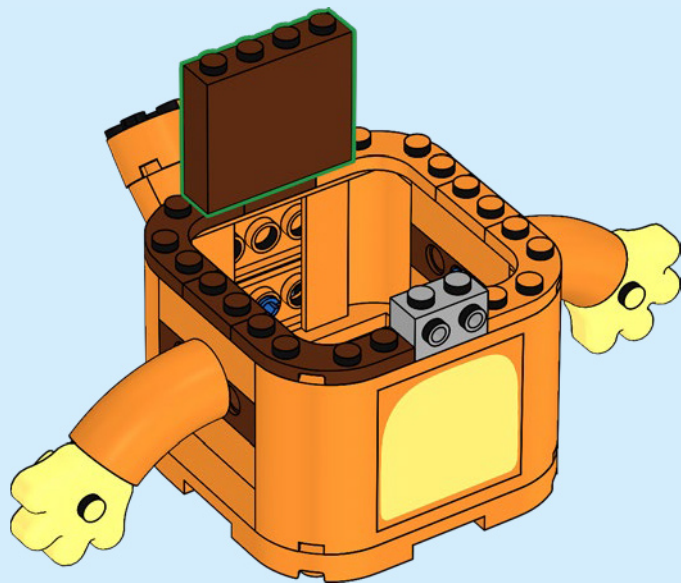

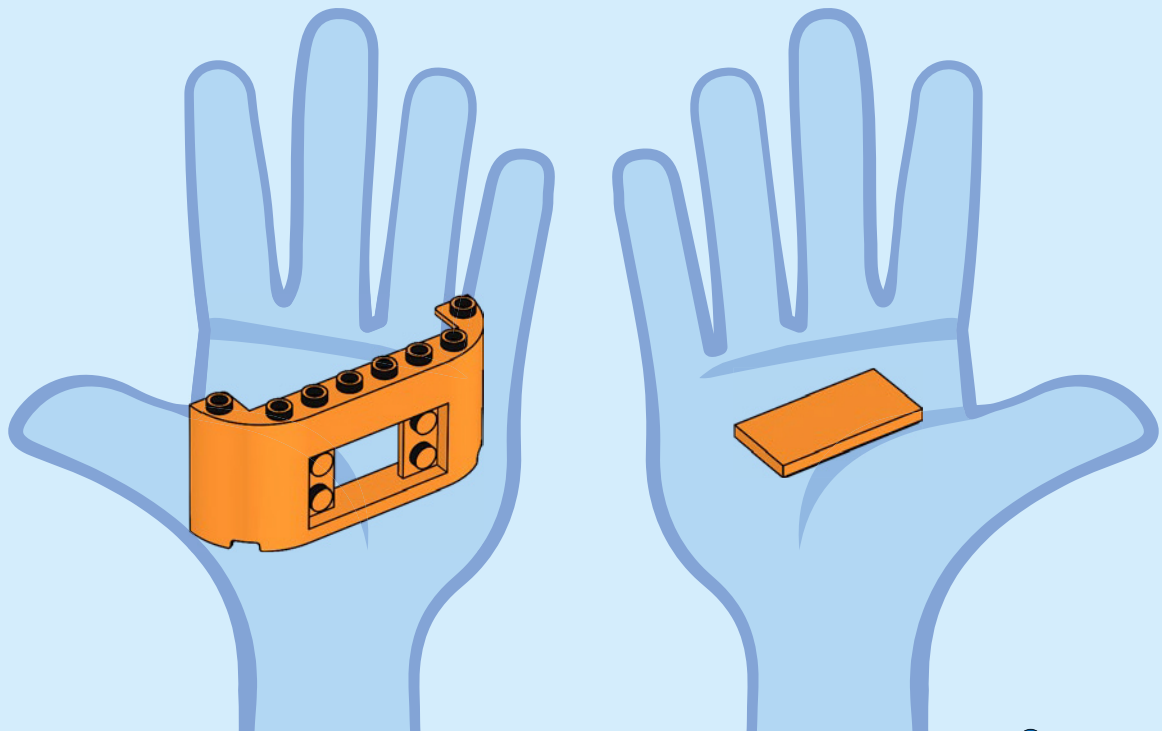

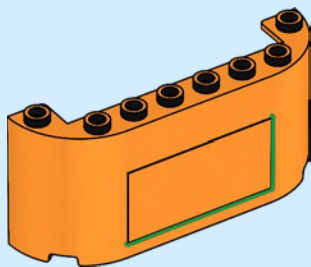
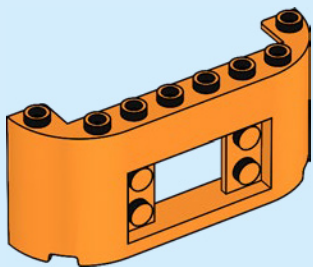

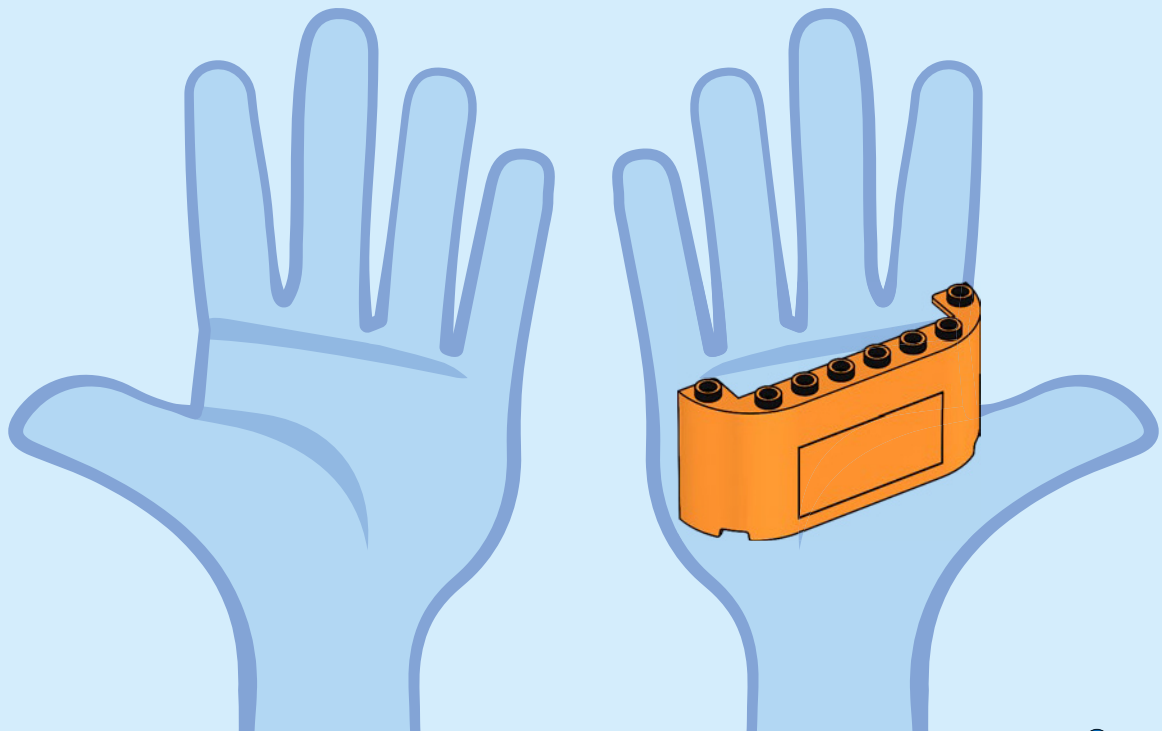

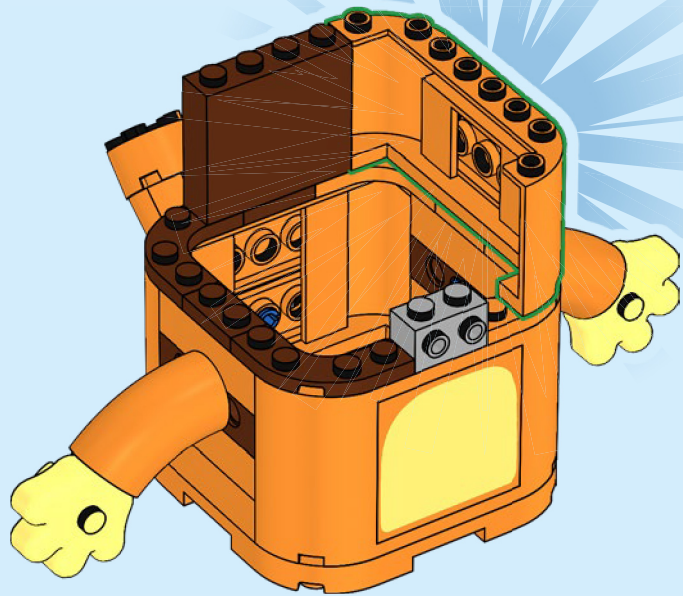

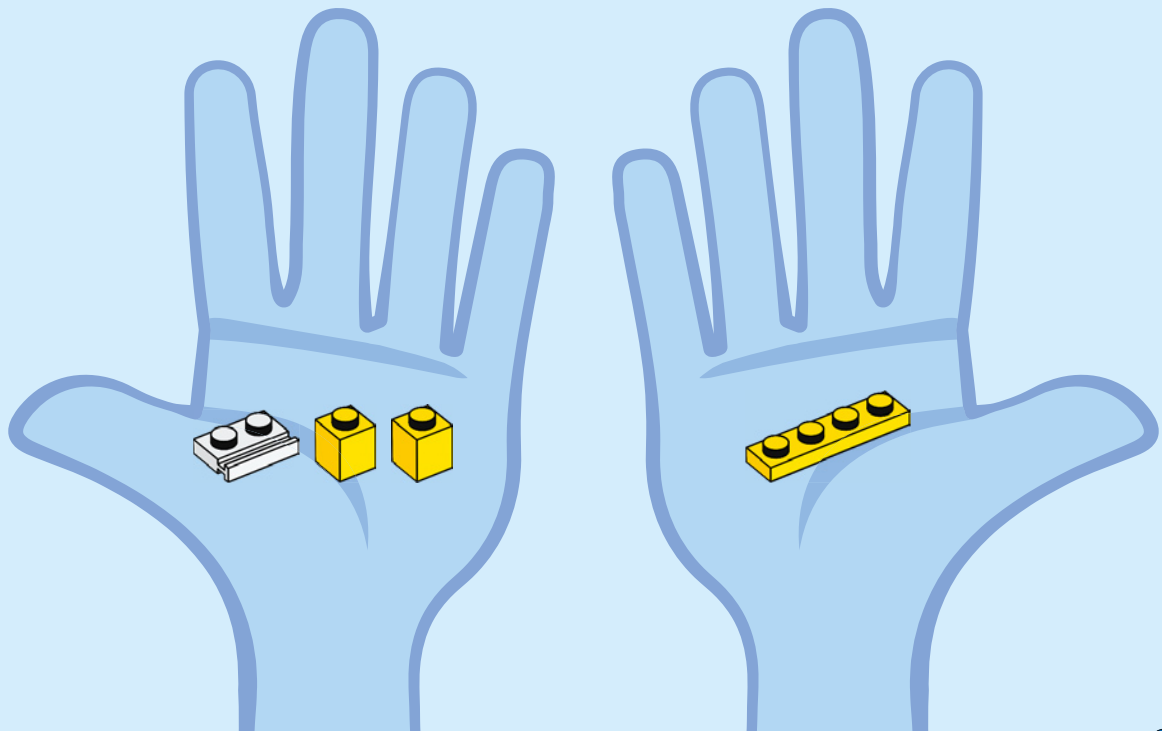

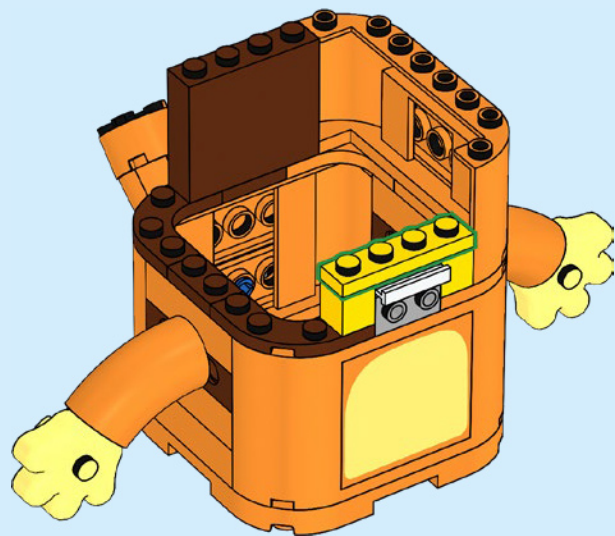
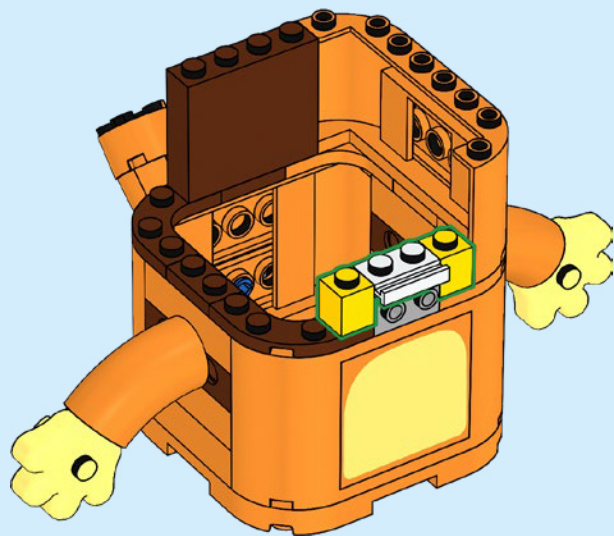

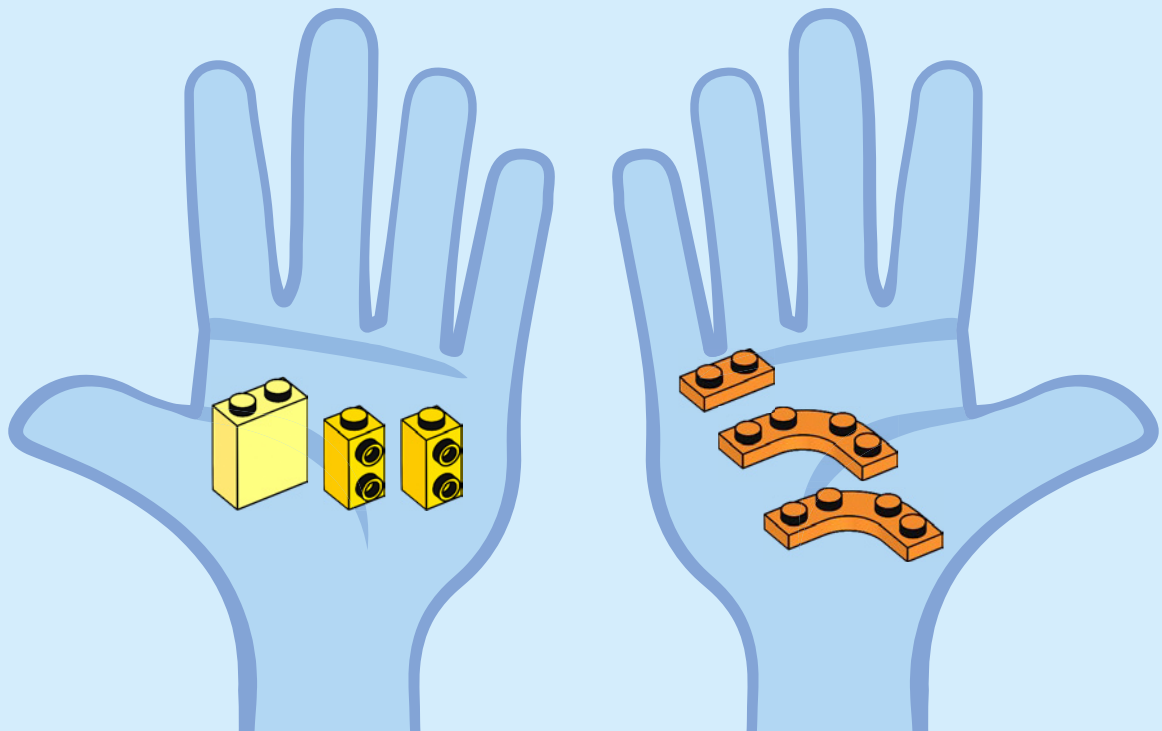

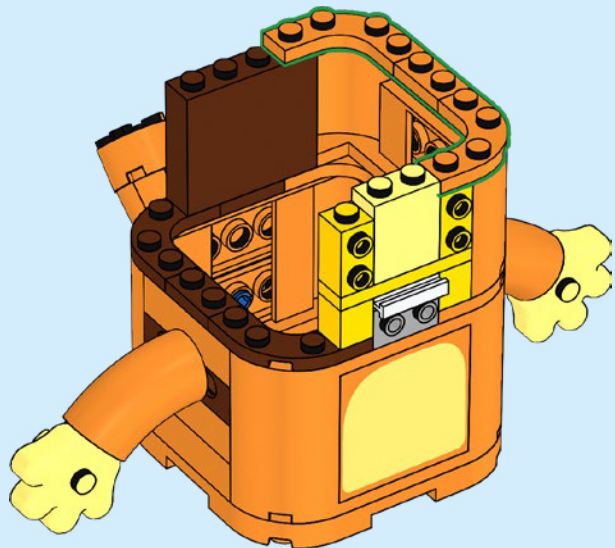
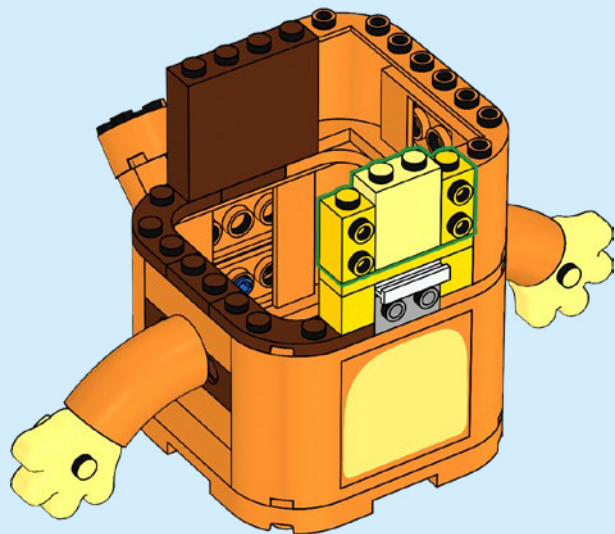

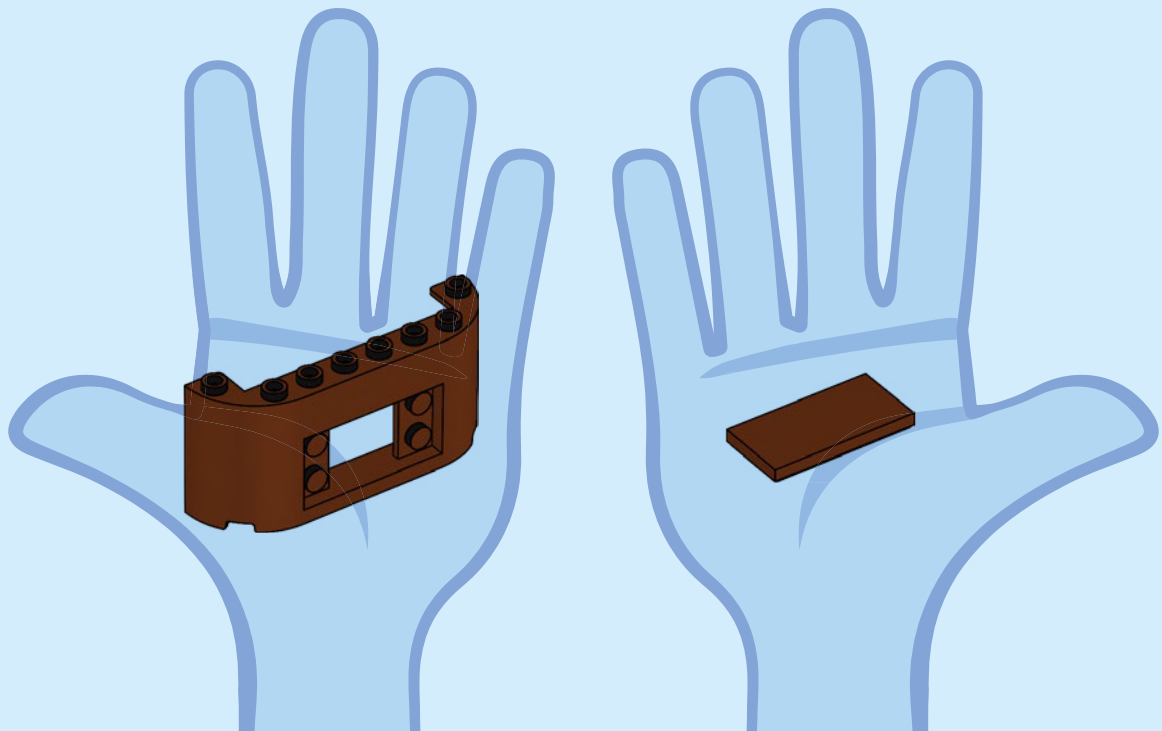

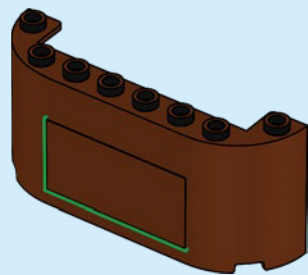
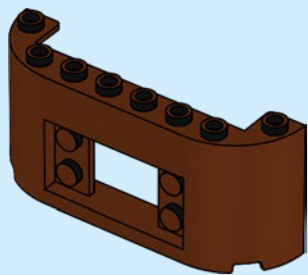

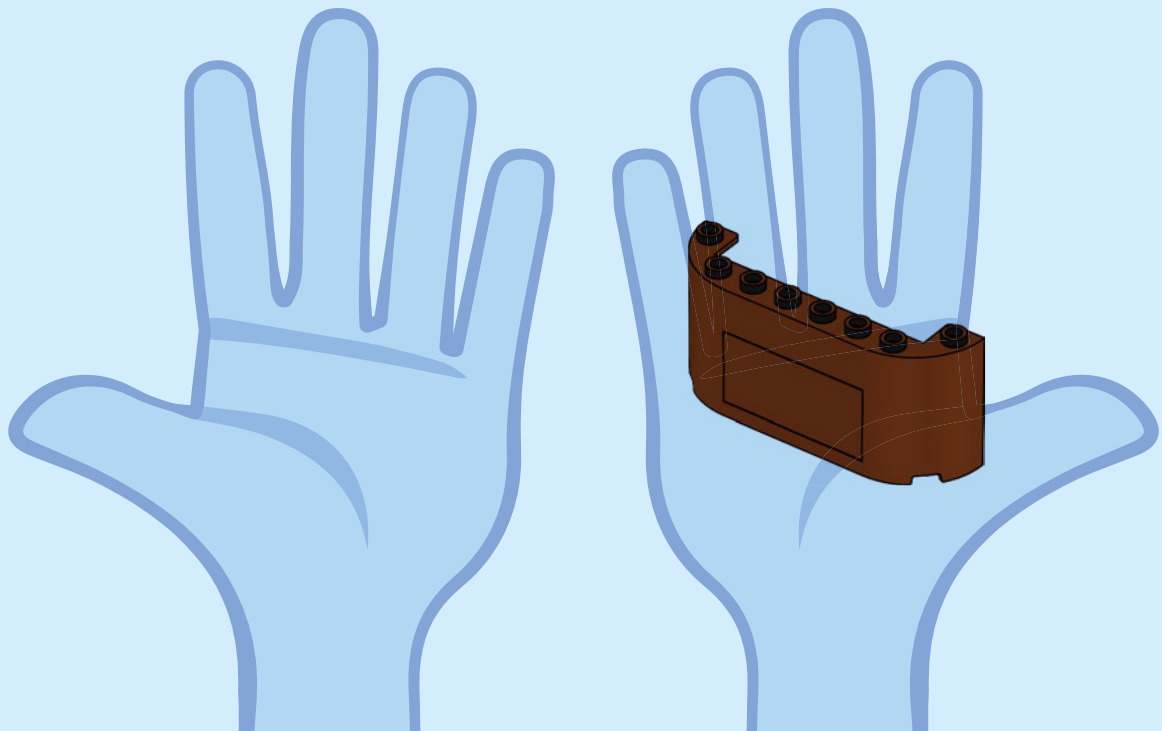

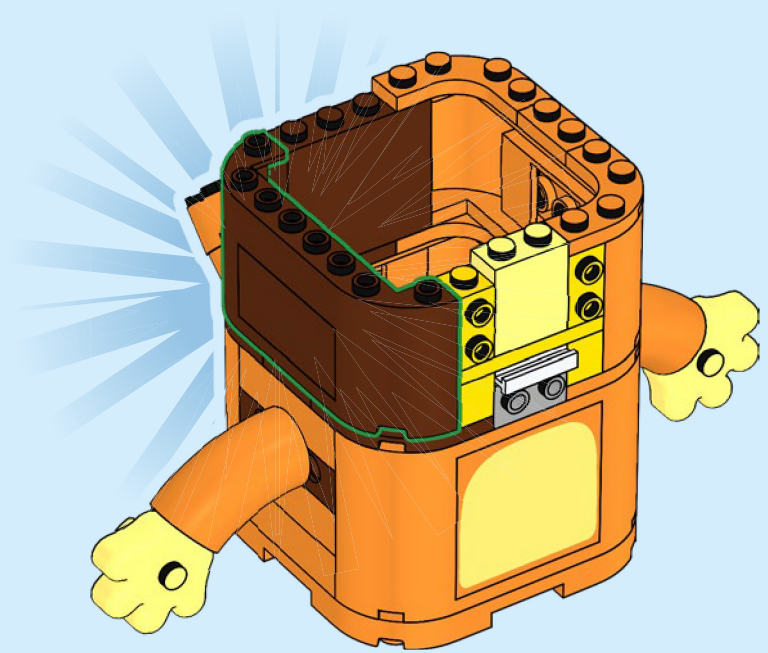

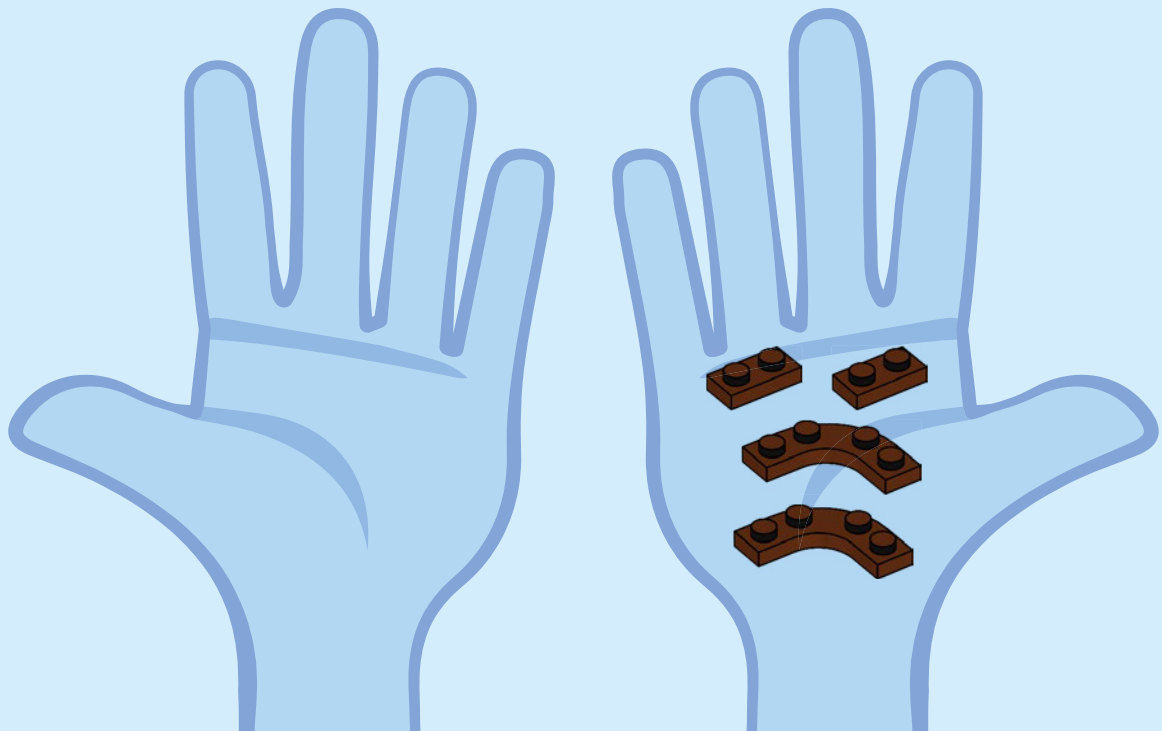

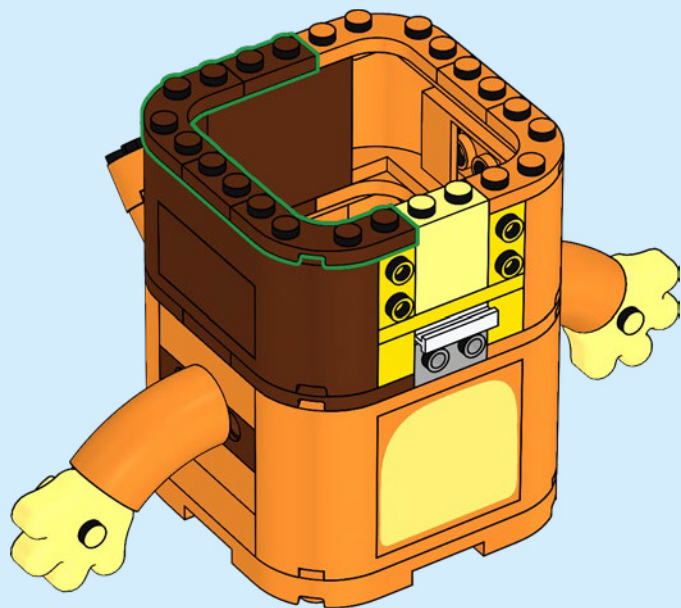

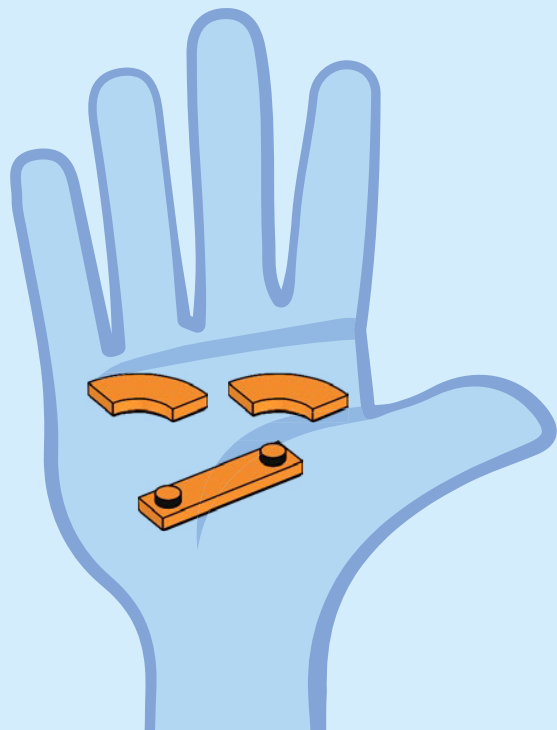

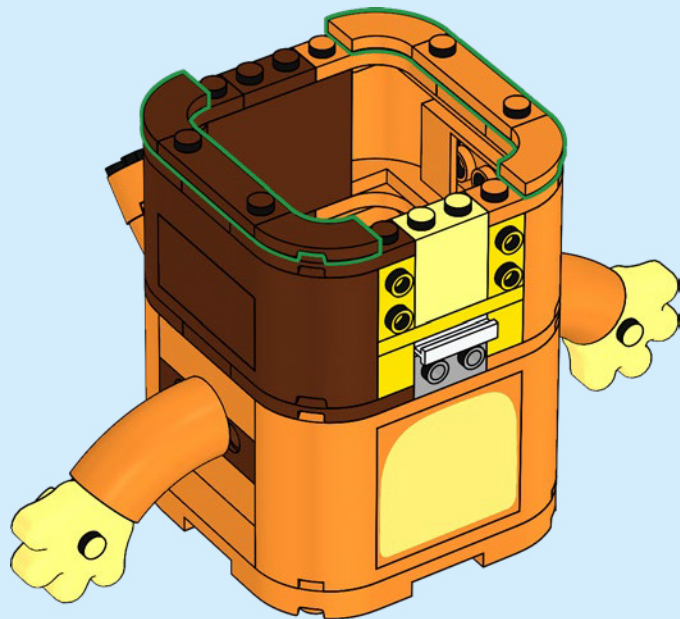

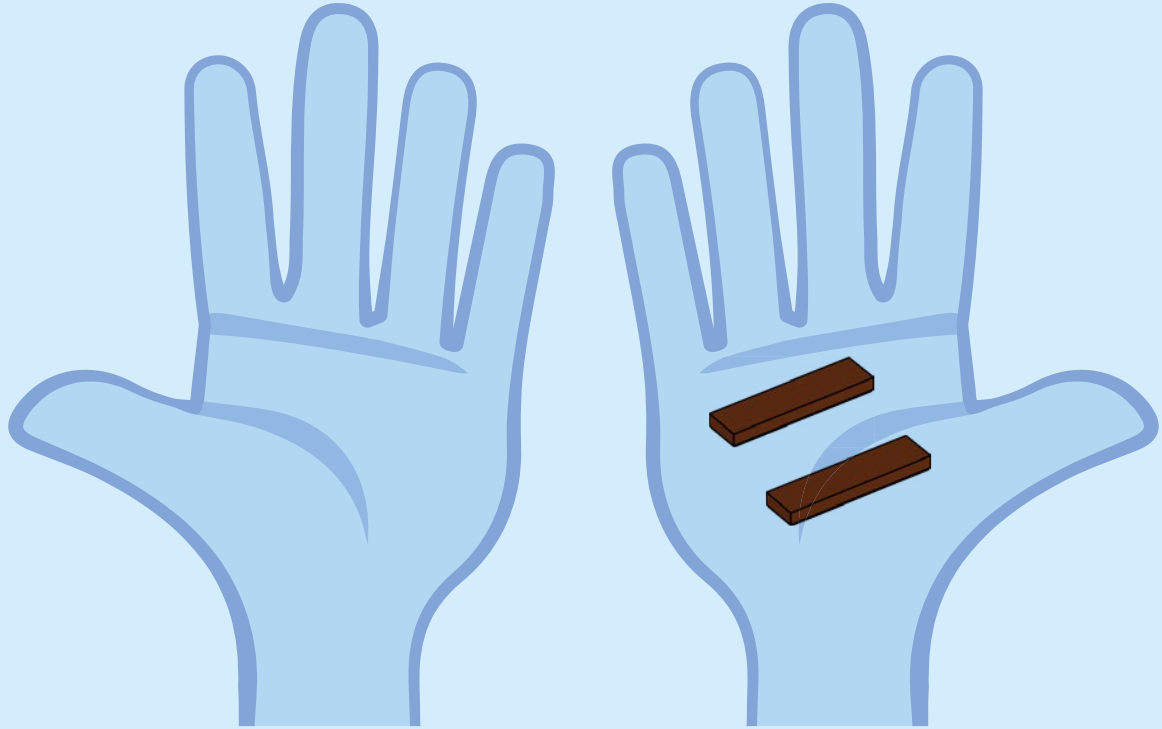

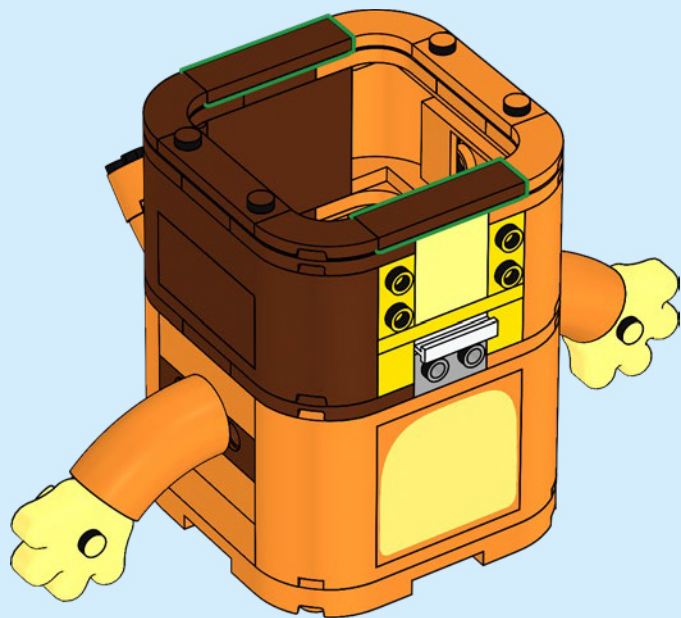

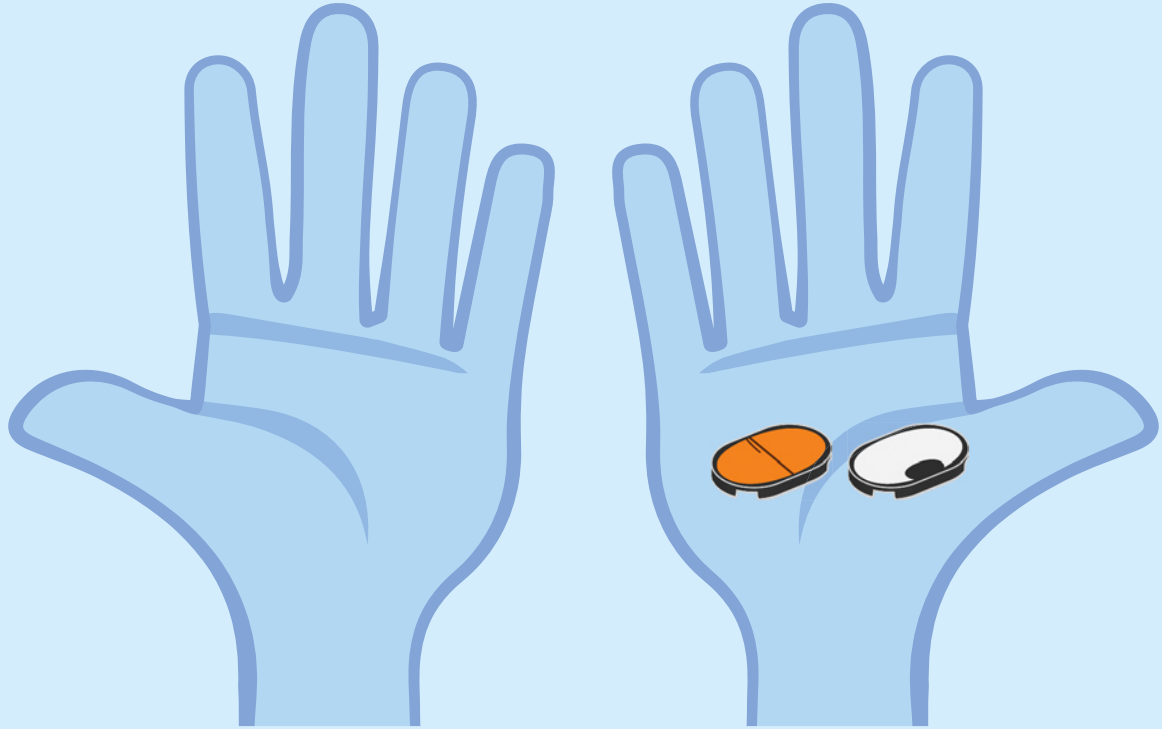

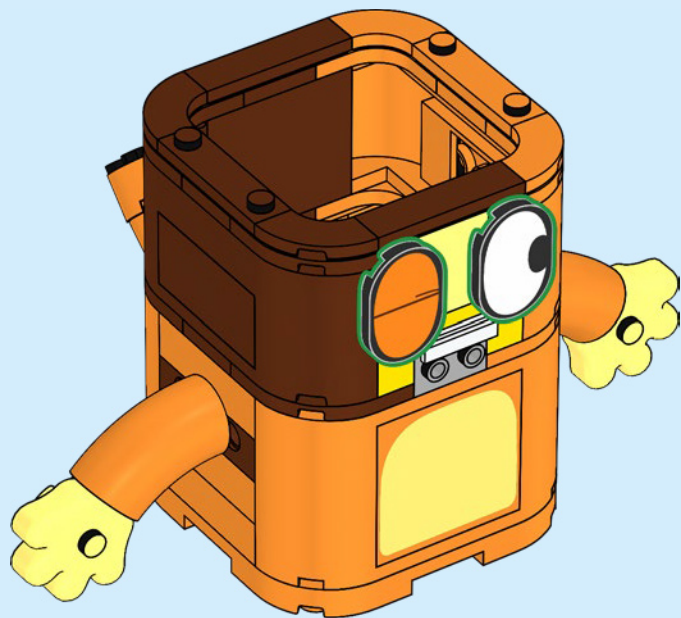

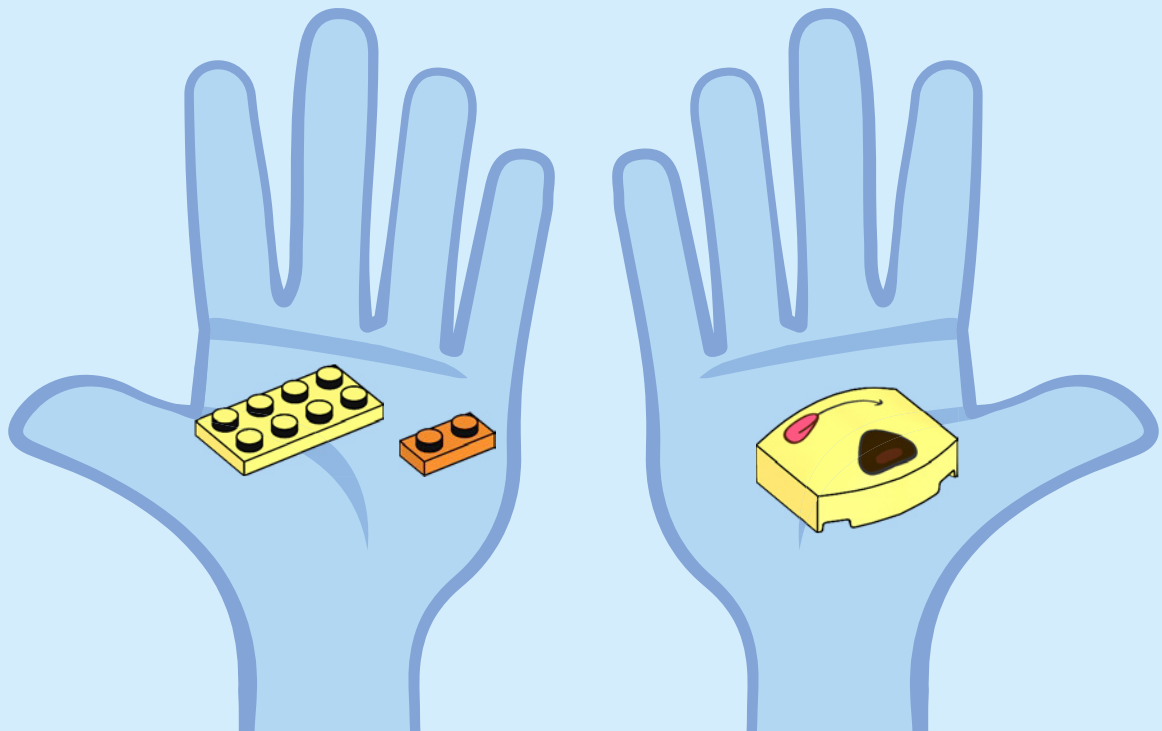

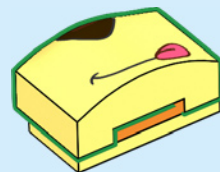
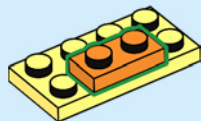
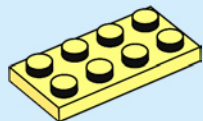

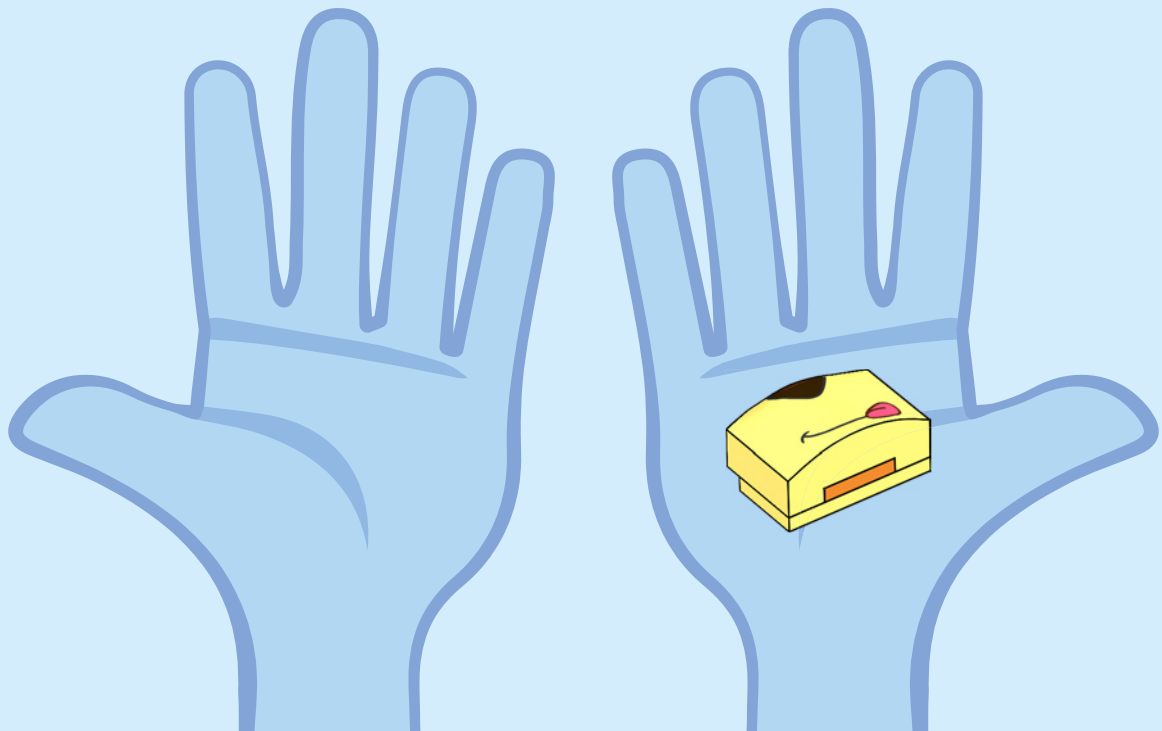

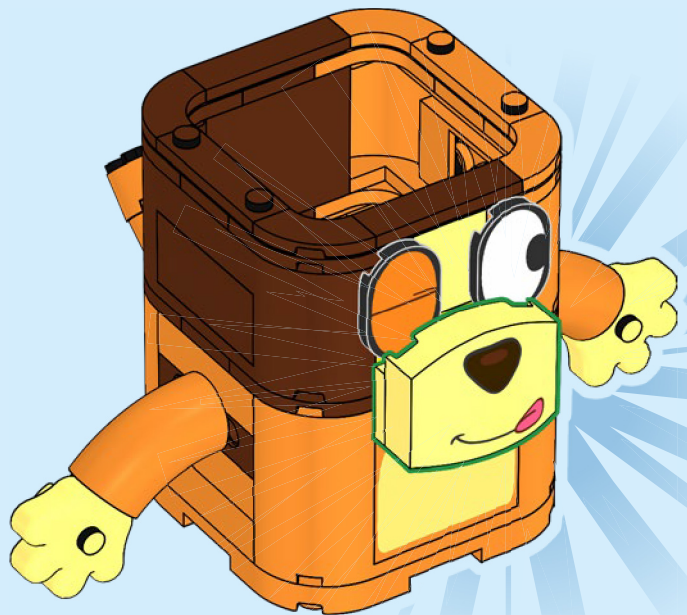

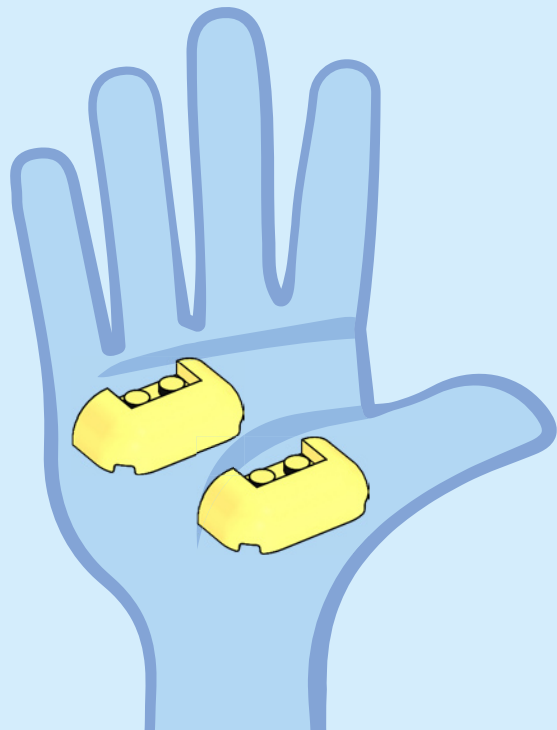
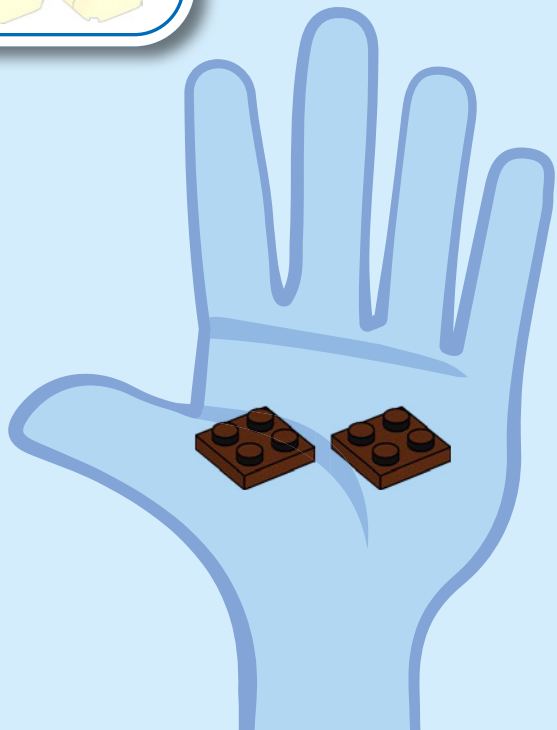
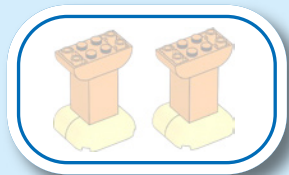



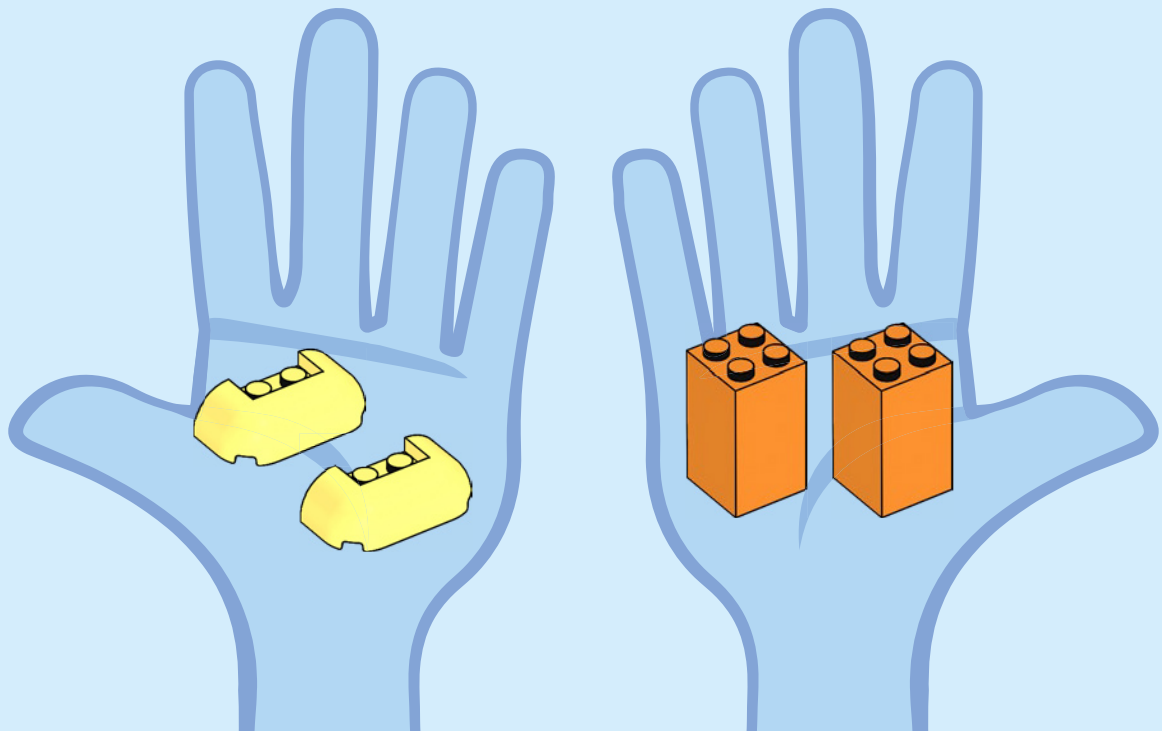

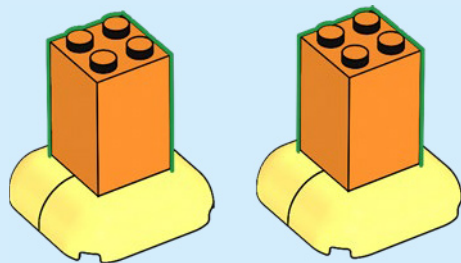
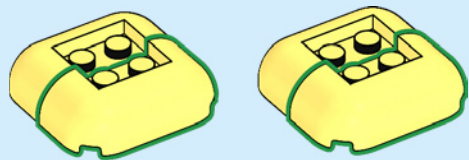

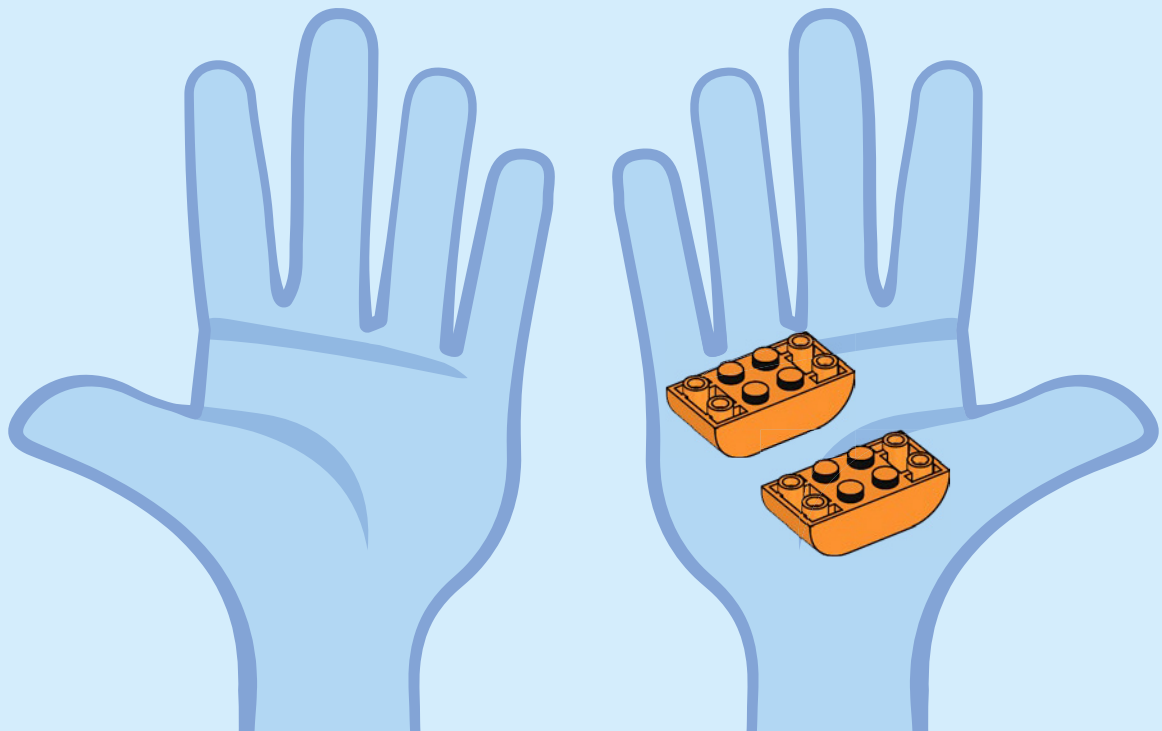

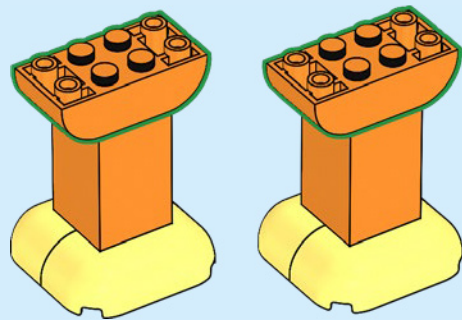

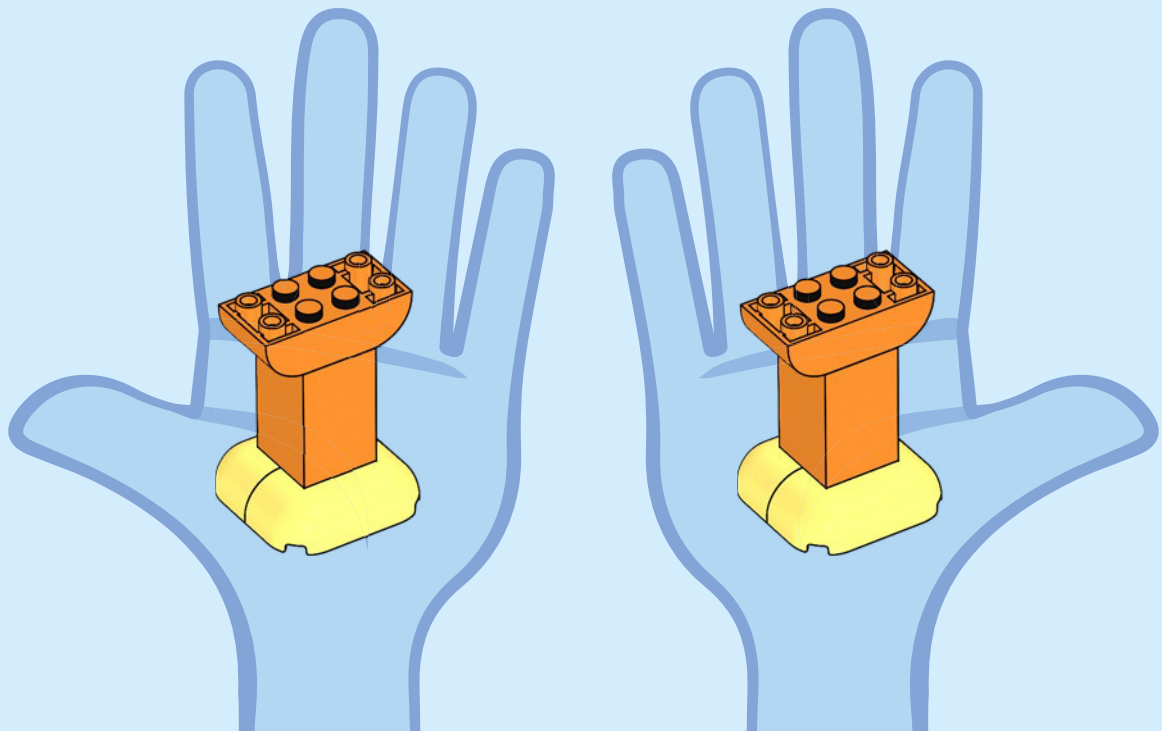

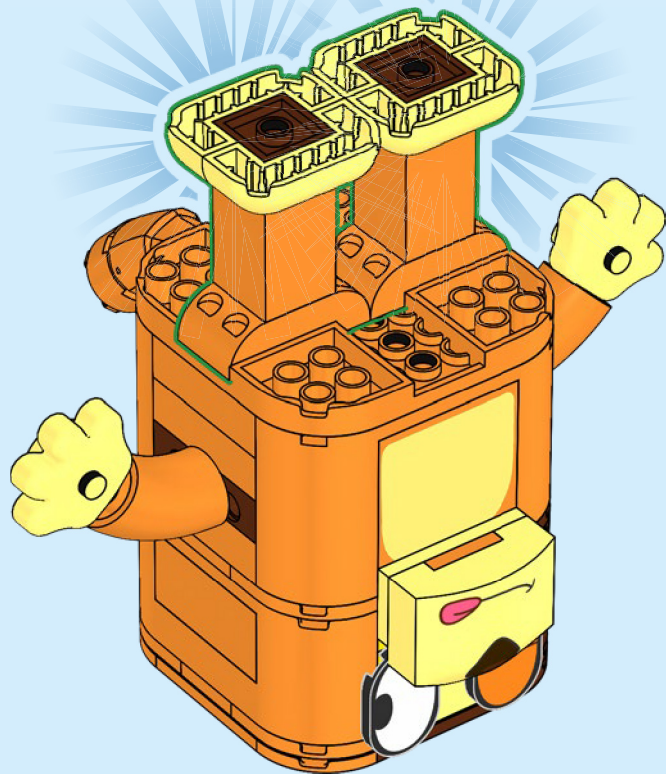

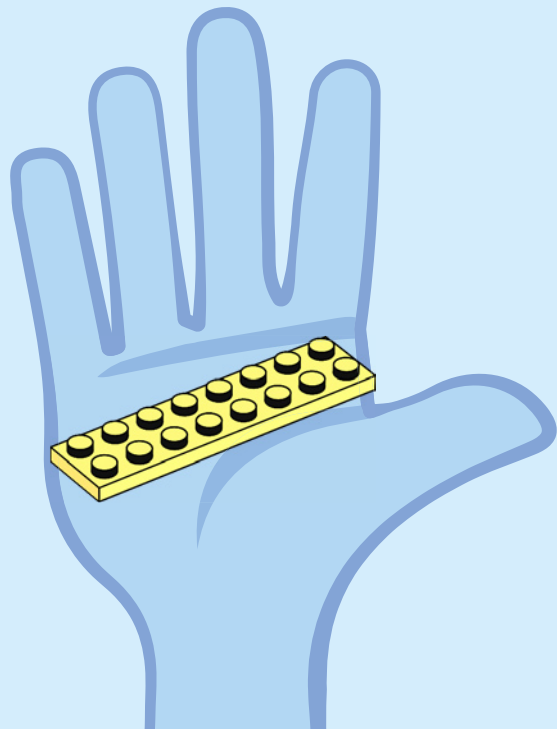
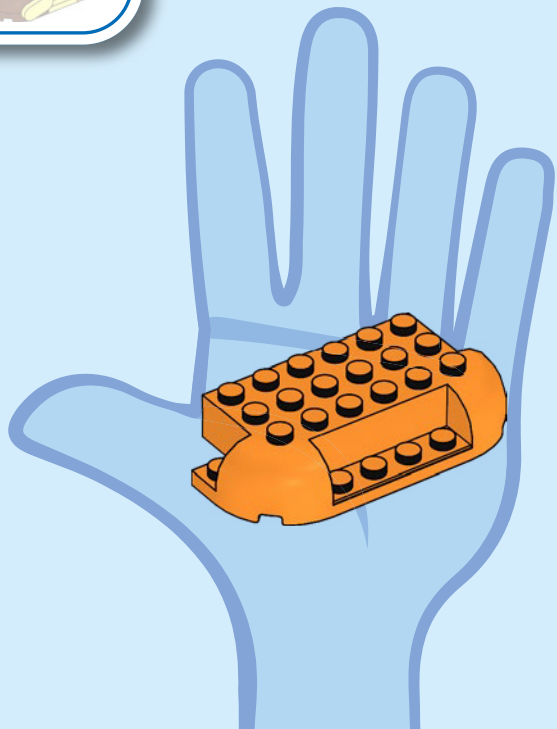

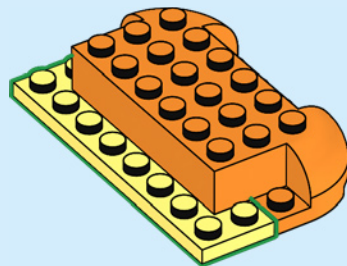
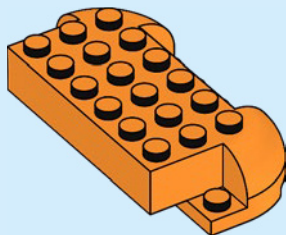

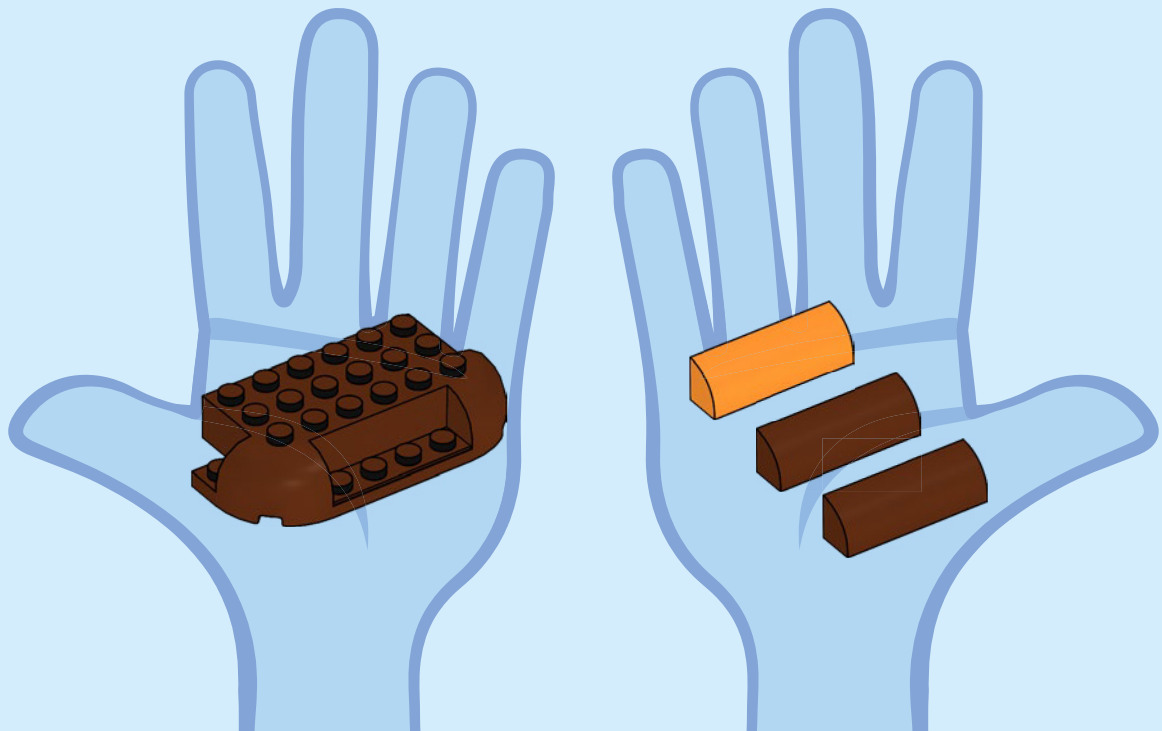

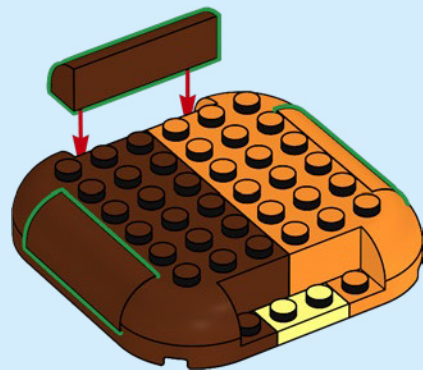
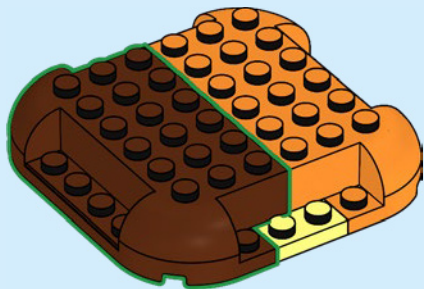

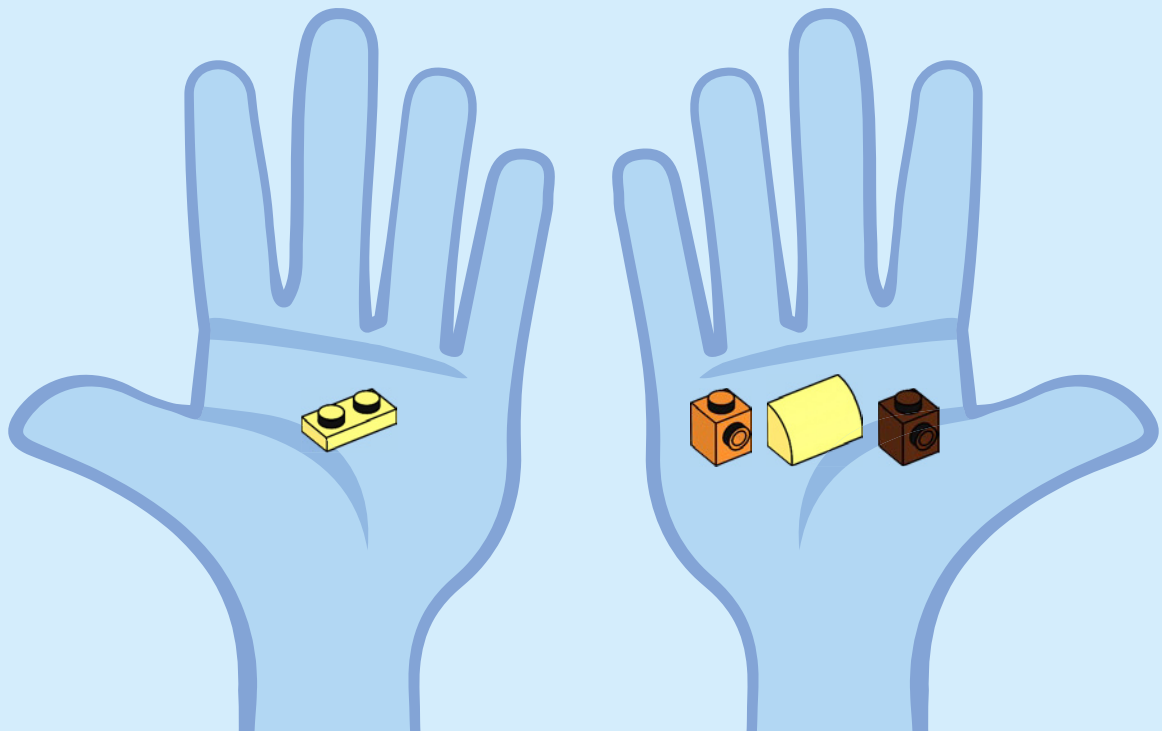

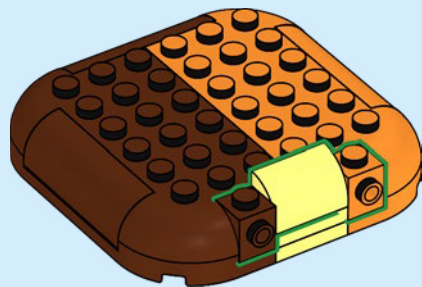
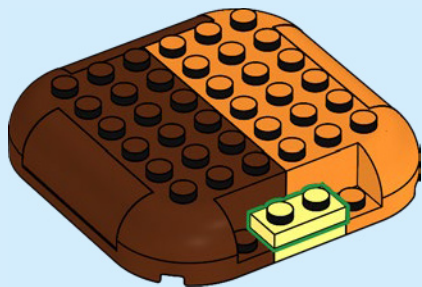

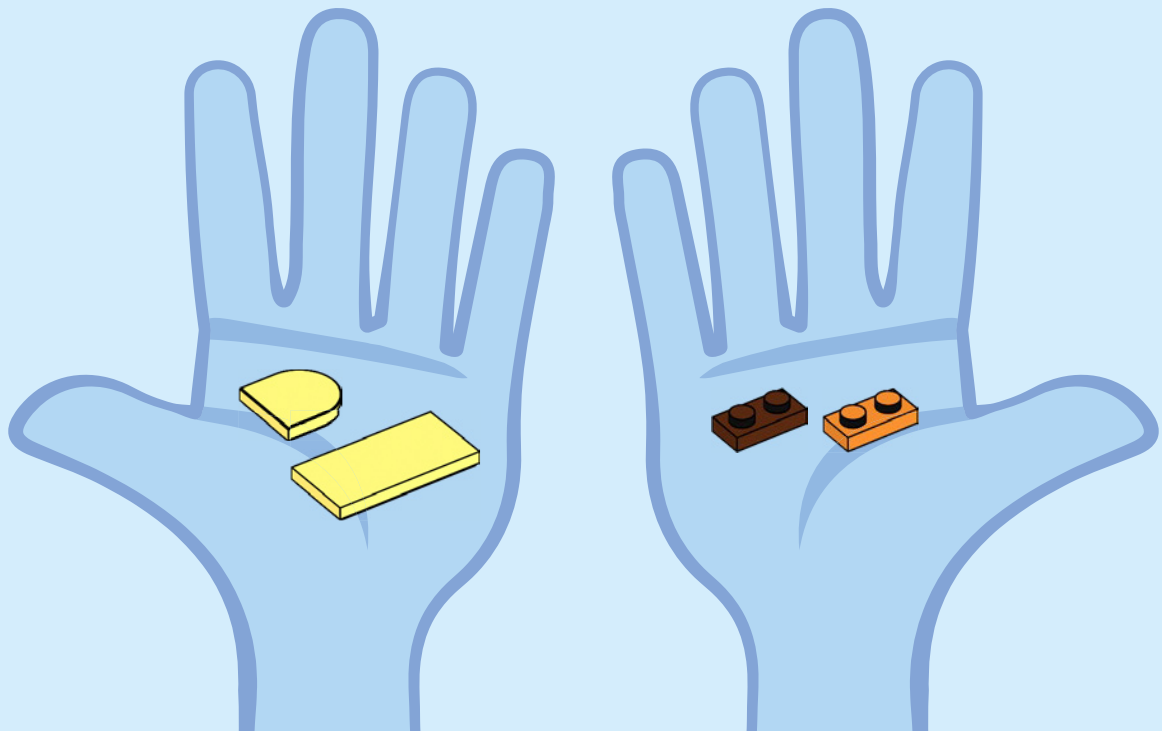

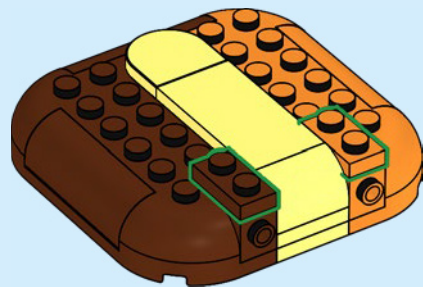
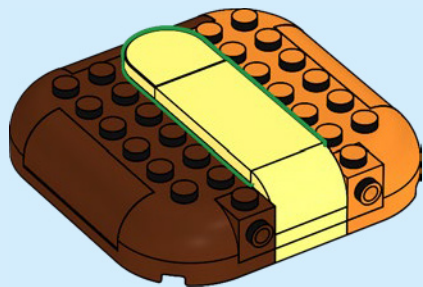

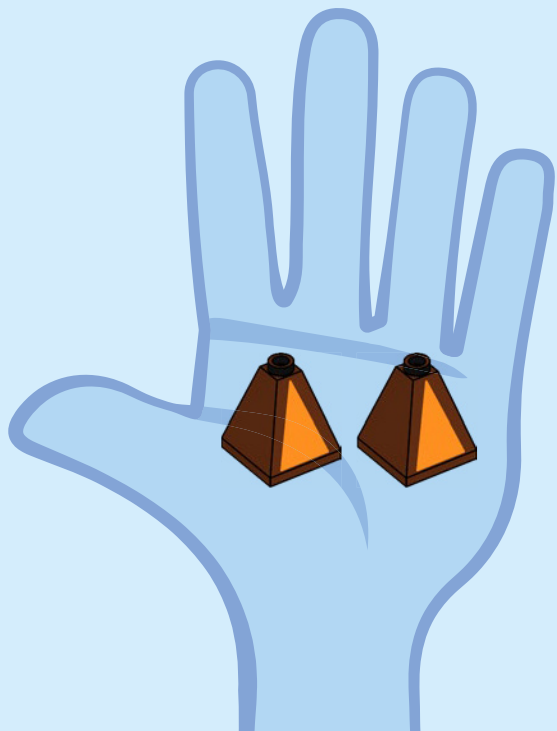

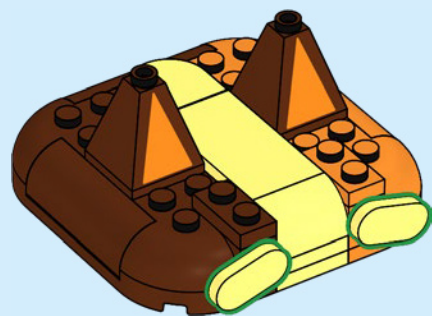
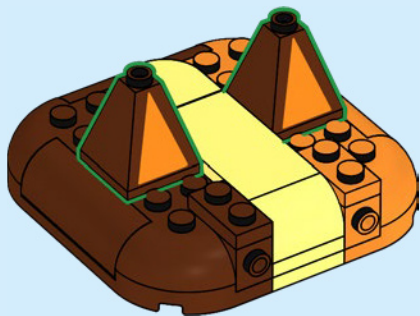

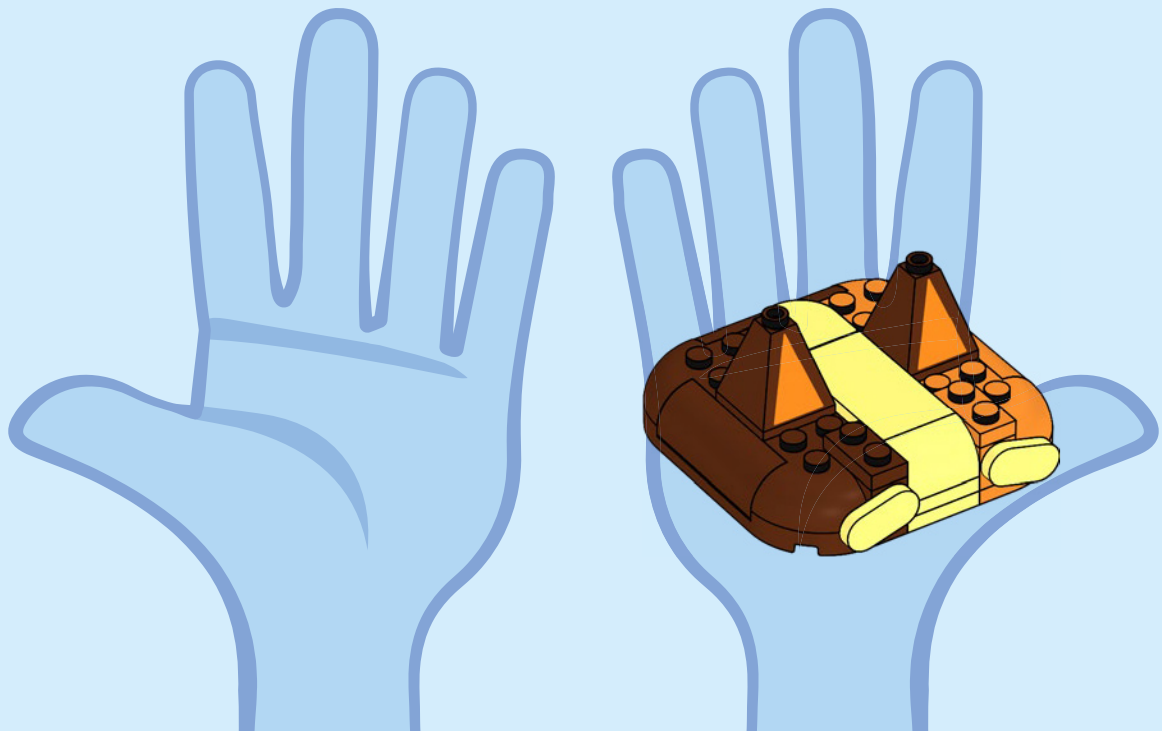



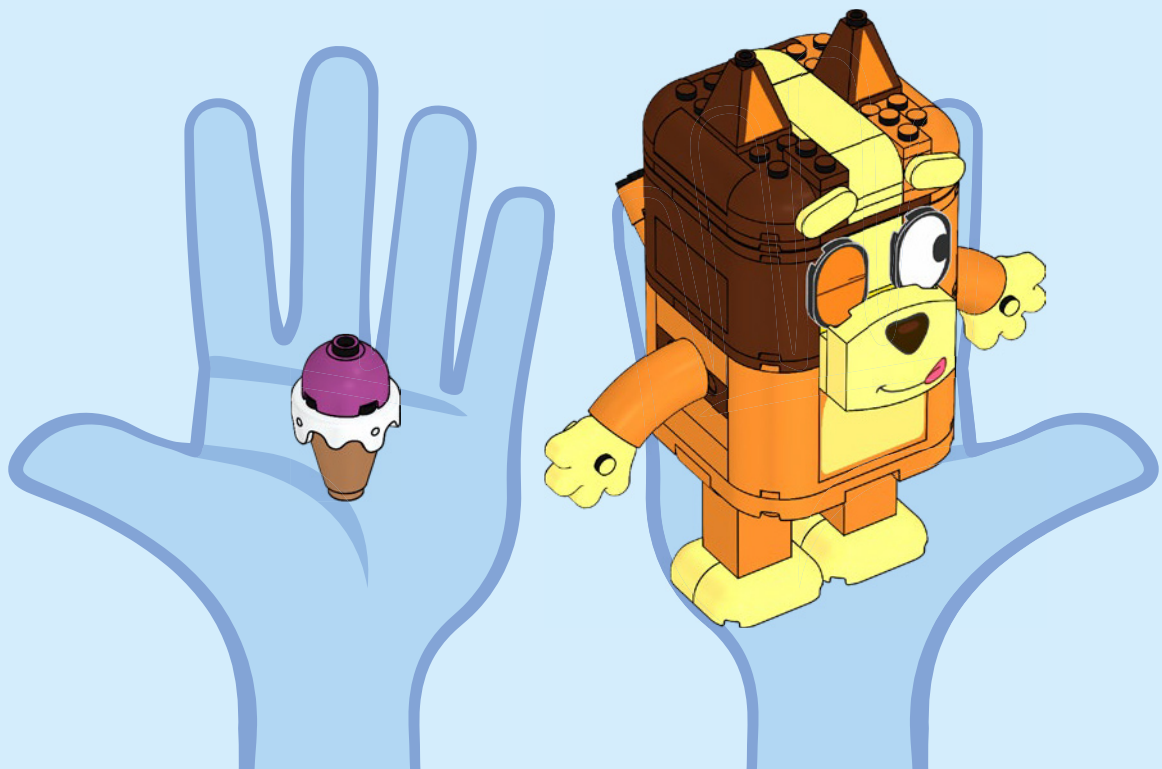



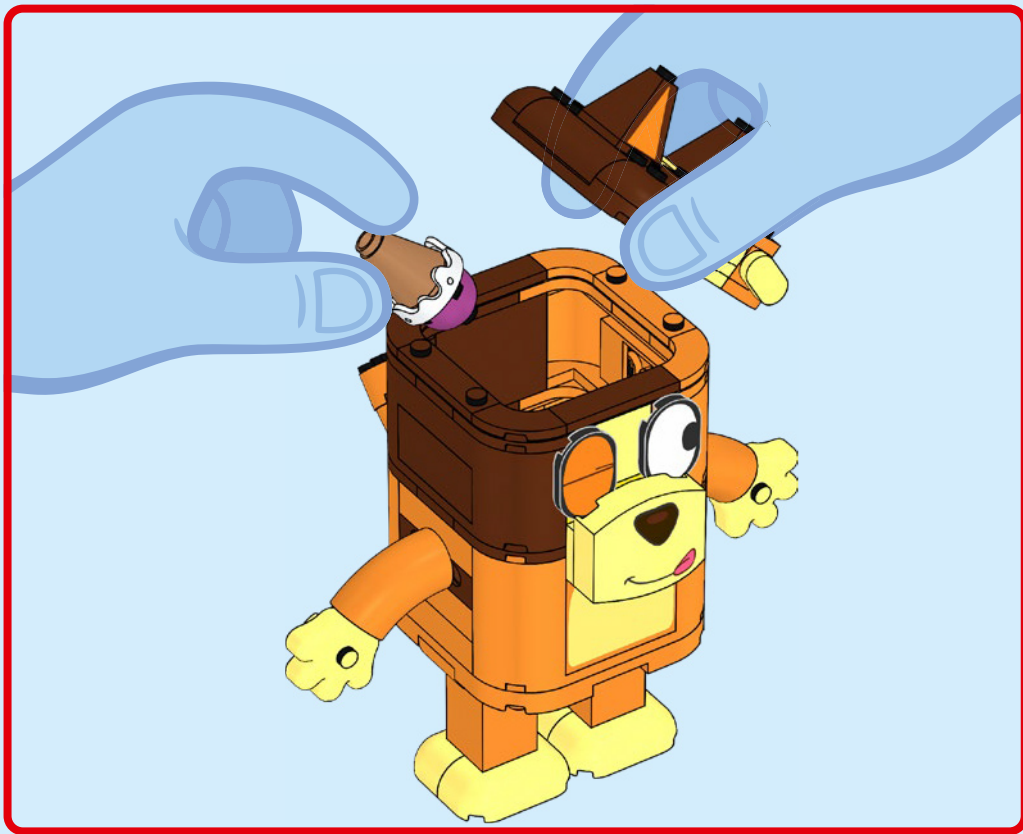

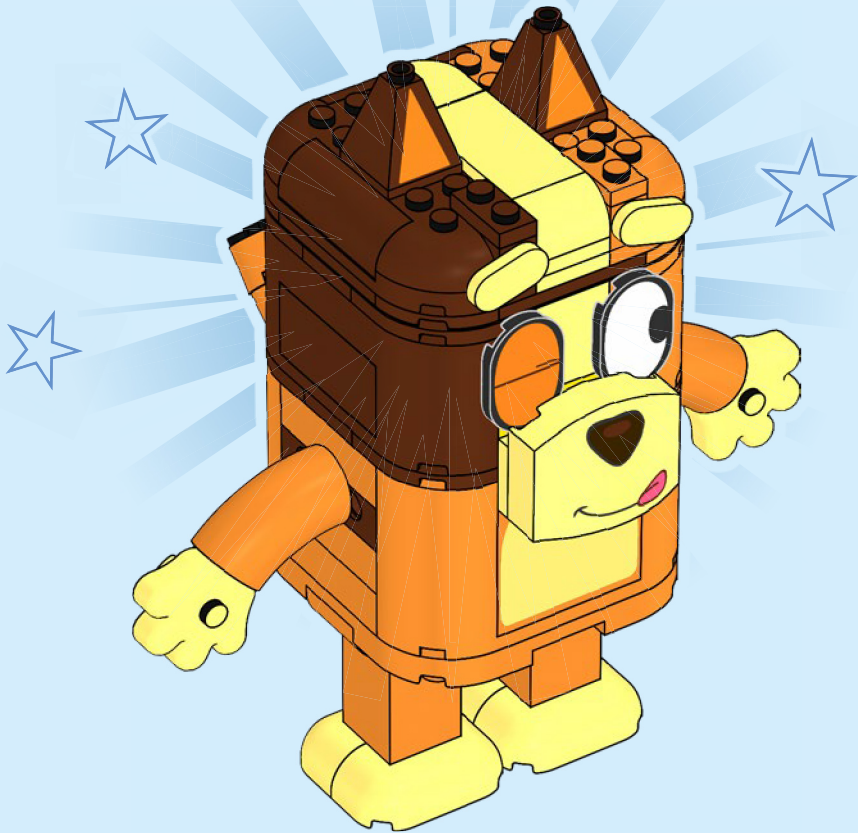

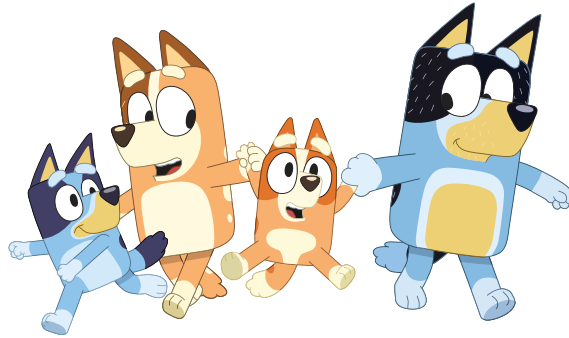

LEGO and the LEGO logo are trademarks of the/sont des marques de commerce du/son marcas registradas de LEGO Group. ©2026 The LEGO Group.  
BLUEY (word mark and character logos) are trade marks of Ludo Studio Pty Limited and are used under license. BLUEY logo © Ludo Studio Pty Limited 2018.  
Licensed by BBC Studios. BBC is a trade mark of the British Broadcasting Corporation and is used under licence. BBC logo © BBC 1996.