



**SPEED**  
CHAMPIONS

77261







LEGO® Builder



[LEGO.com/sustainable-packaging](https://LEGO.com/sustainable-packaging)



 <sup>FR</sup> **DONNEZ**  
OU  
**RECYCLEZ**

 OU  OU 

ASSOCIATION    MAGASIN    DÉCHÈTERIE

Adresses sur [quefairedemesdechets.fr](https://quefairedemesdechets.fr)

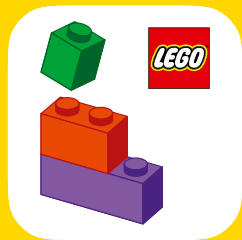

LEGO® Builder



# BUILDER



Apple and the Apple logo are trademarks of Apple Inc., registered in the U.S. and other countries and regions. App Store is a service mark of Apple Inc. Google Play and the Google Play logo are trademarks of Google LLC. Tencent and the Tencent logo are trademarks of Tencent Inc.

[LEGO.com/devicecheck](http://LEGO.com/devicecheck)

EN Ask parents' permission before going online | DE Eltern um Erlaubnis bitten, bevor du online gehst | FR Demande l'autorisation d'un parent avant d'aller en ligne | IT Chiedi il permesso ai tuoi genitori prima di andare online | ES Pídeles permiso a tus papás antes de conectarte a Internet | PT Pede autorização aos teus pais antes de ficares online | ZH 上网前应先征得父母的同意 | PL Poproś rodziców o zgodę, zanim wejdiesz do Internetu | CS Než půjdeš na internet, požádej rodiče o svolení | SK Skôr než pôjdeš na internet, vypýtaj si povolenie od rodičov | HU Kérj szülői engedélyt, mielőtt online csatlakoznál! | UA Запитуйте дозволу батьків, перш ніж користуватися інтернетом | RO cere permisiunea părinților înainte de a te conecta online | BG Поискайте разрешение от родител, преди да влезете онлайн | LV Pirms došanās tiešsaistē palūdz atļauju vecākiem | ET Enne Interneti kasutamist küsi vanematelt luba | LT Prieš prisijungdami prie interneto, atsiklauskite tėvų | TR İnternete girmeden önce anne babandan izin iste



## Designed for show, not for go!

Designed for show, not for go! | Für die Show konzipiert, nicht für die Fahrt! | Conçue pour l'exposition, pas pour la compétition! | Progettata per l'esposizione, e per le emozioni!  
| Para presumir, no para conducir! | Criado para exposição, não para condução! | 为展示而设计, 而非漂移! | Zaprojektowane, by cieszyć oko, nie śmigać! | Model na wystavení,  
nikolí na ježdění! | Stvorený na obdiv, nie na jazdu! | Kiállításra tervezték, nem versenyre! | Створено для шоу, а не для їзди! | Concepută pentru spectacol, nu pentru pornit  
la drum! | Предназначен за показване, а не за пътуване! | Paredzēts demonstrēšanai, nevis braukšanai! | Mōeldud nāitamiseks, mitte sõitmiseks! | Sukurta eksponuoti, o ne  
važiuoti! | Sürüş için değil, gösteri için tasarlandı!



## Redefining hyper racing!

Redefining hyper racing! | Hyper-Rennen neu definiert! | L'hypercourse redéfinie ! | Ridefinisce l'hyper racing! | ¡Reinventando la hipervelocidad! | As corridas de hipercarros redefinidas! | 重新定义超级赛车! | Nowe oblicze hipercyścigów | Nová definice hyper závodění! | Nová definícia hyperrýchlej jazdy! | A hiperautók újragondolása! | Нове визначення гіперперегонів! | Redefinieste hipercursele! | Ново определение на високоскоростните състезания! | Spraiģu sacikģu pārdefinēšana! | Mōtestame hūpervōidusōidu ūmber! | Nauja hiperlenktynių era! | Hiper yarış yeniden tanımlandı!



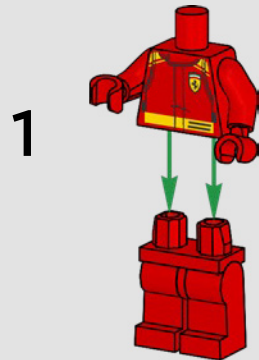

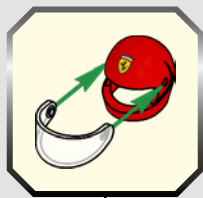

2

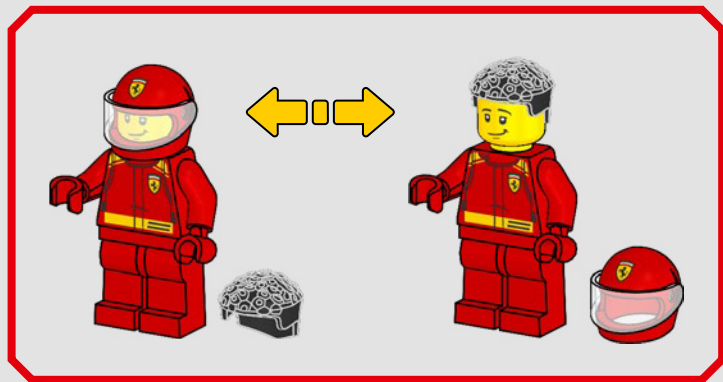
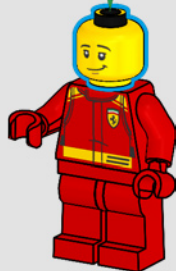

3

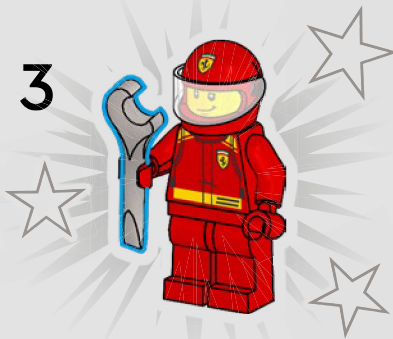

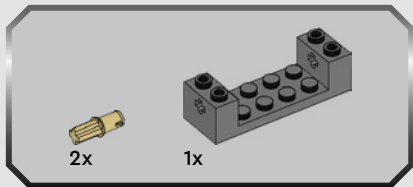

1

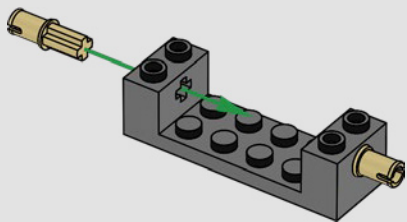

2

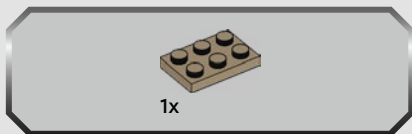
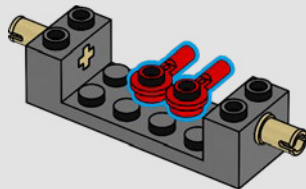

3

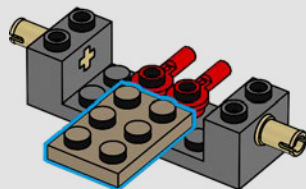

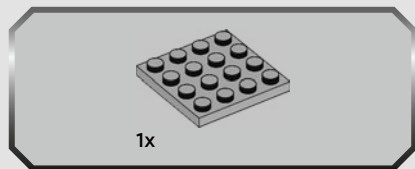

4

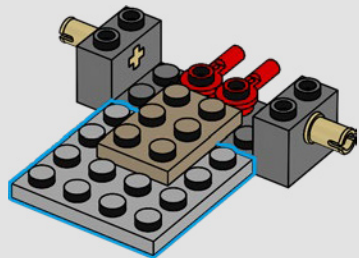

5

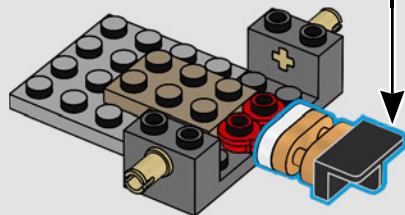
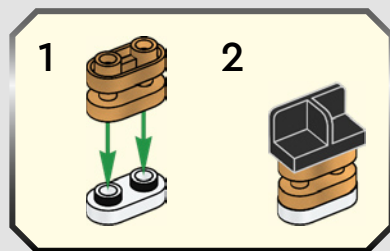

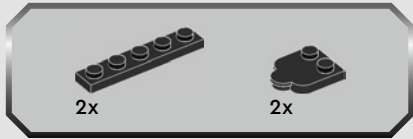

6

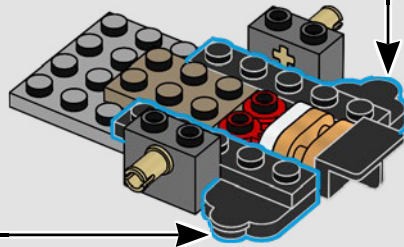
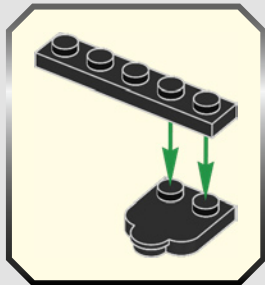
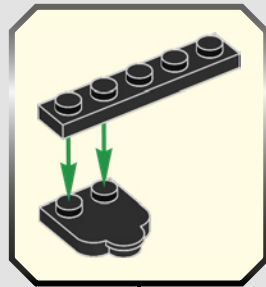



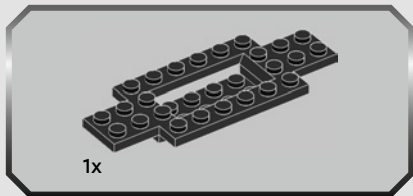

9

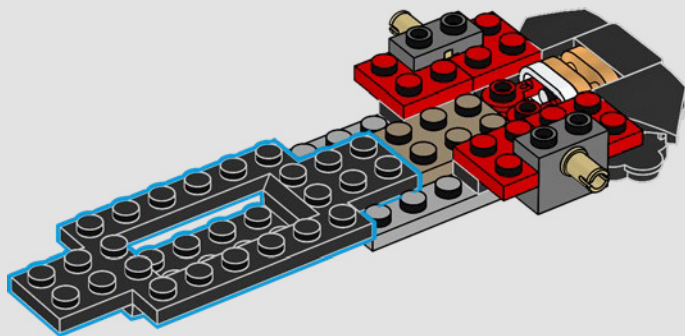

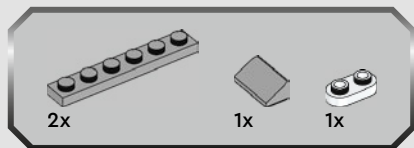

10

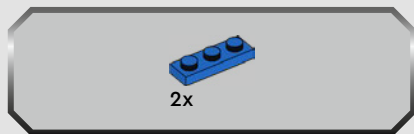
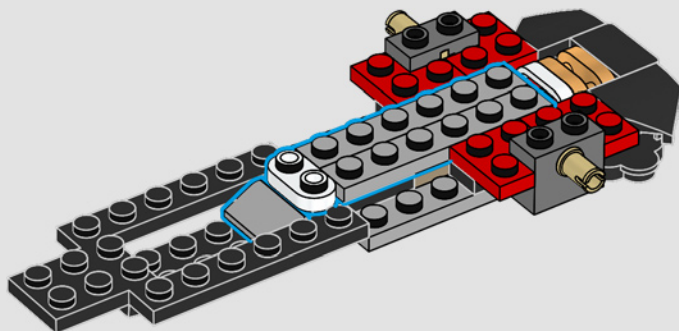

11

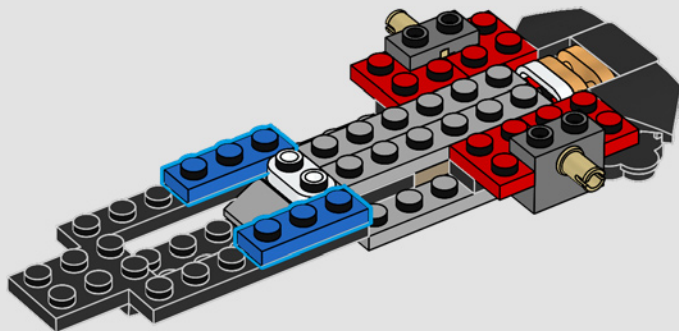



6x

12

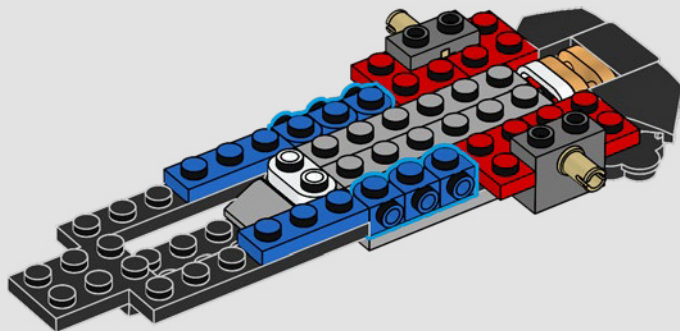

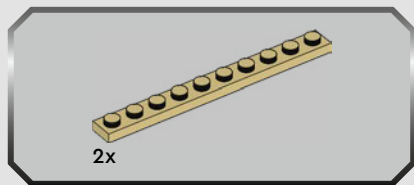

13

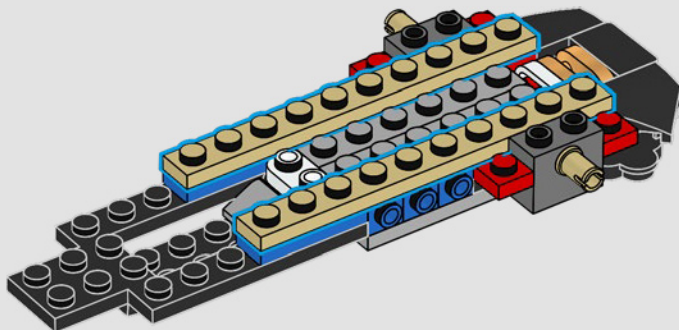

14

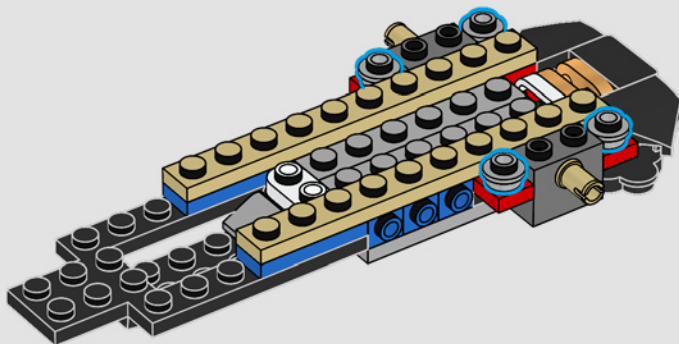



15

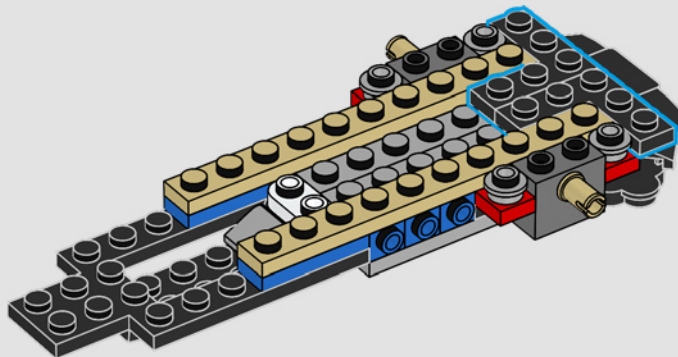





17

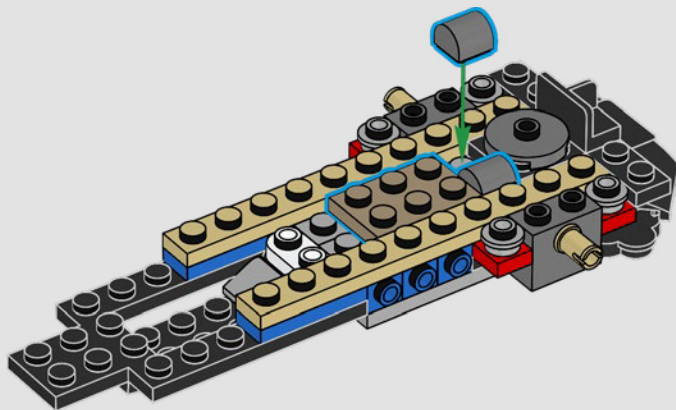

18



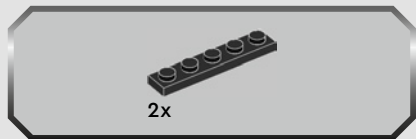

18

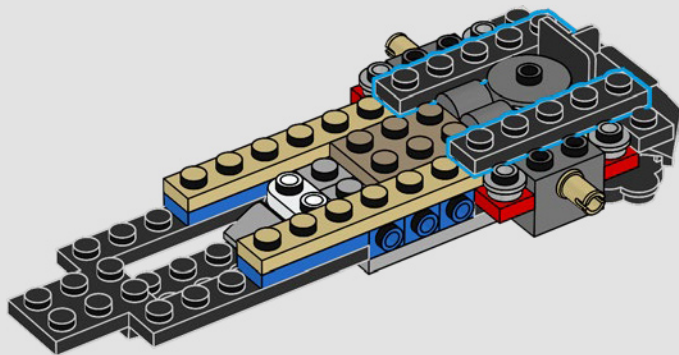

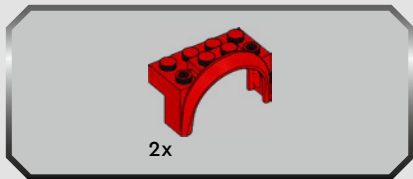

19

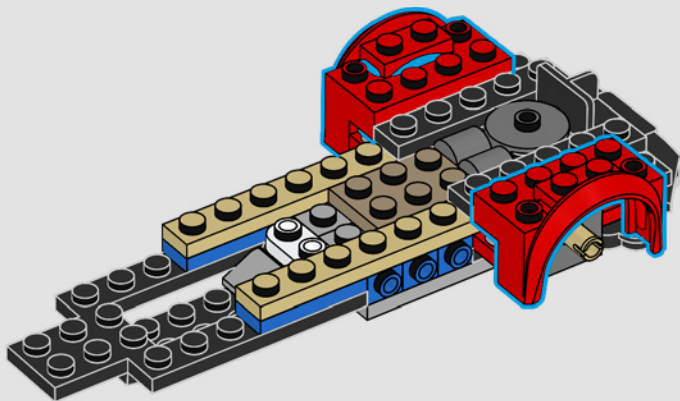

20







20

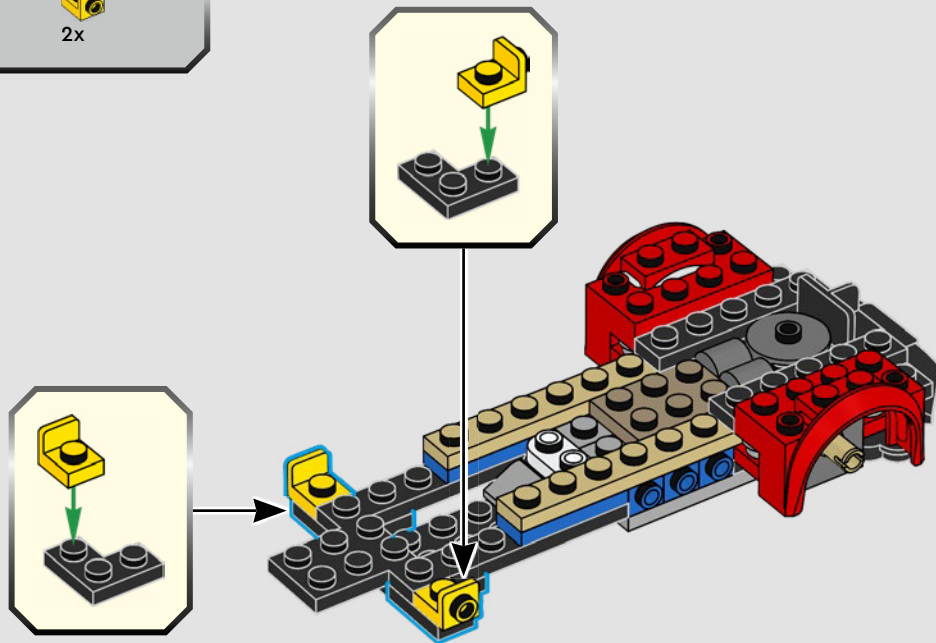

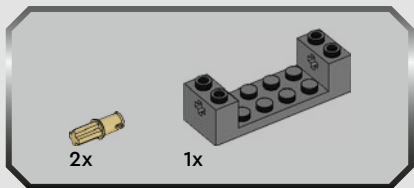
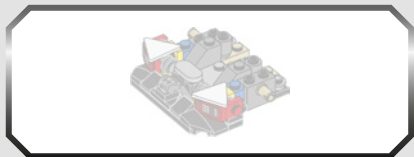

21

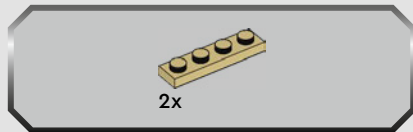
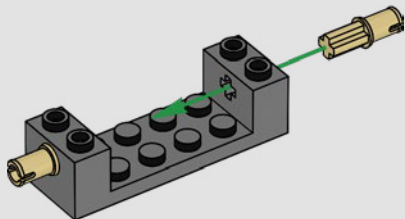

22

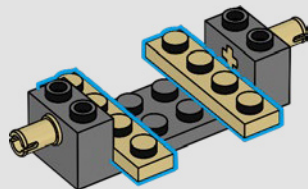

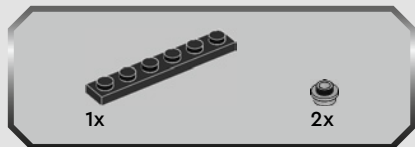

23

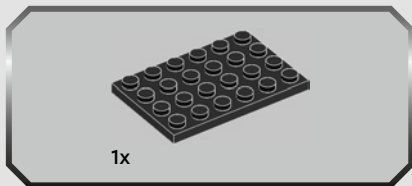
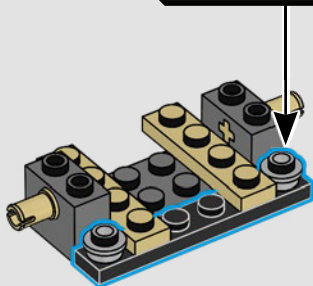
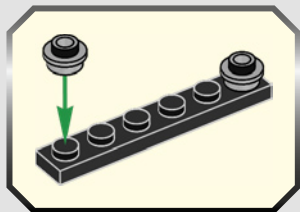

24

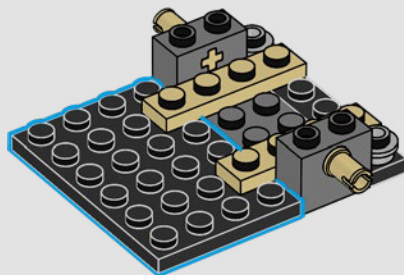

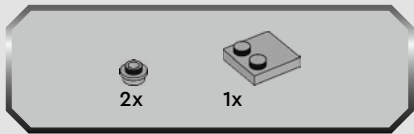

25

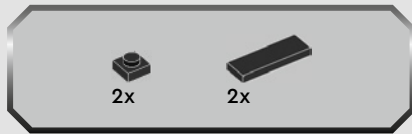
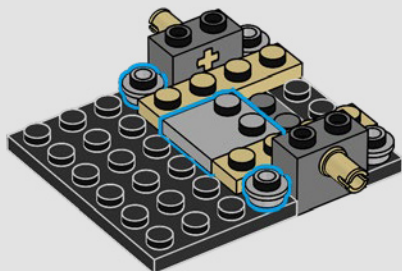

26

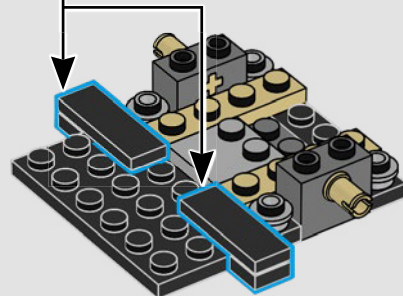
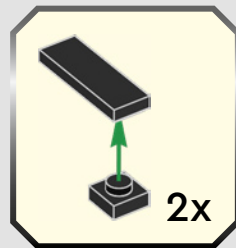



2x



2x

27

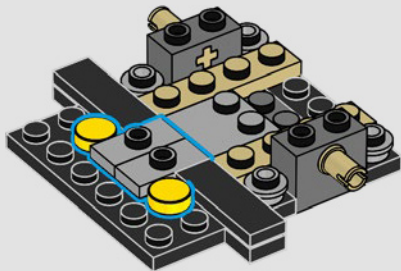

2x



1x



1x

28

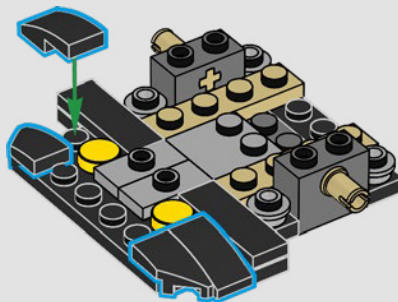



29

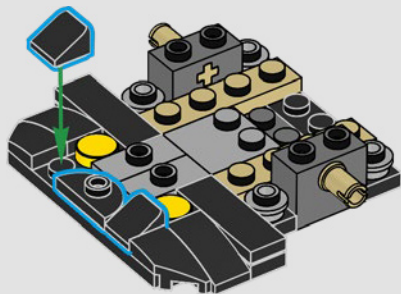

30

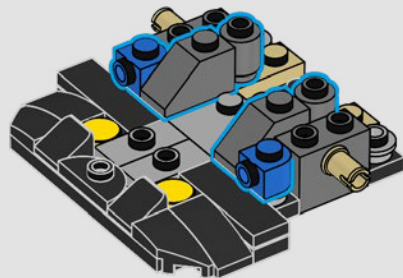



31

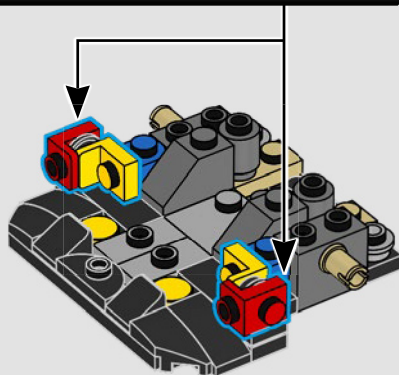



32

1

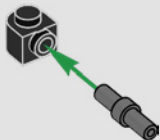

2



2x

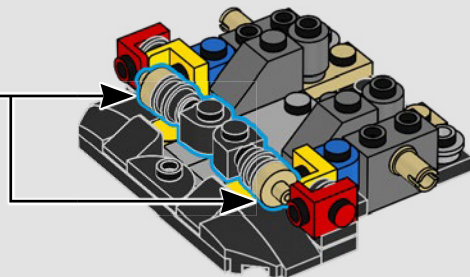
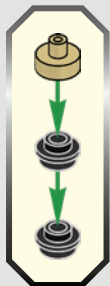

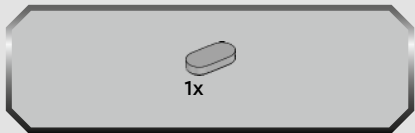

33

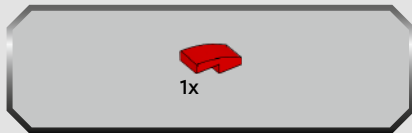
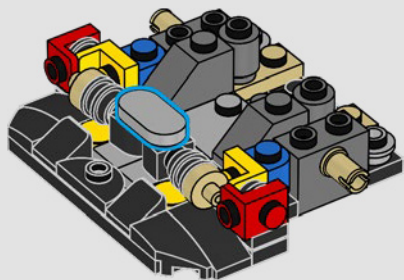

34

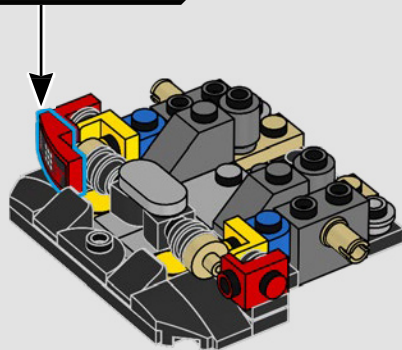
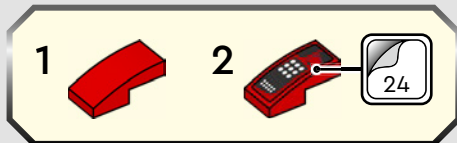



35

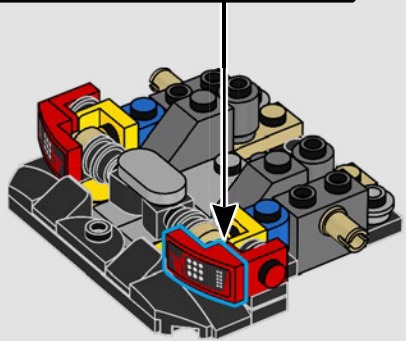
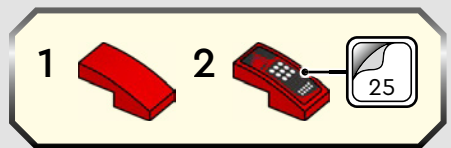

36

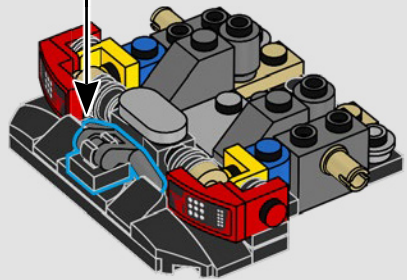
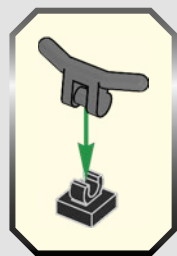



37

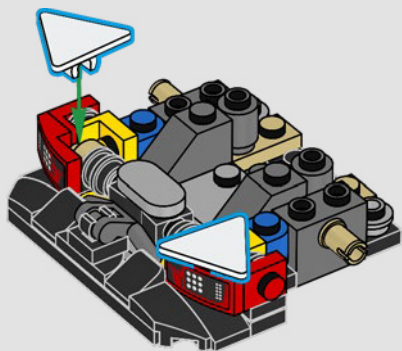

38

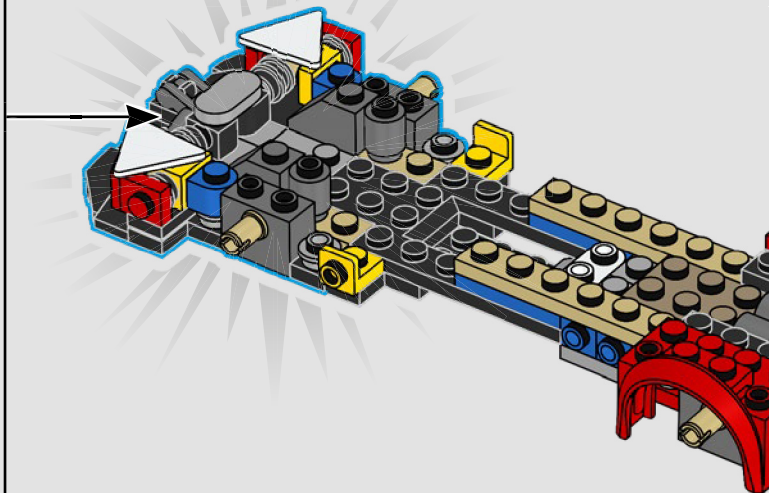

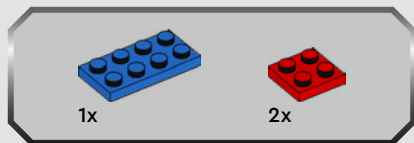

39

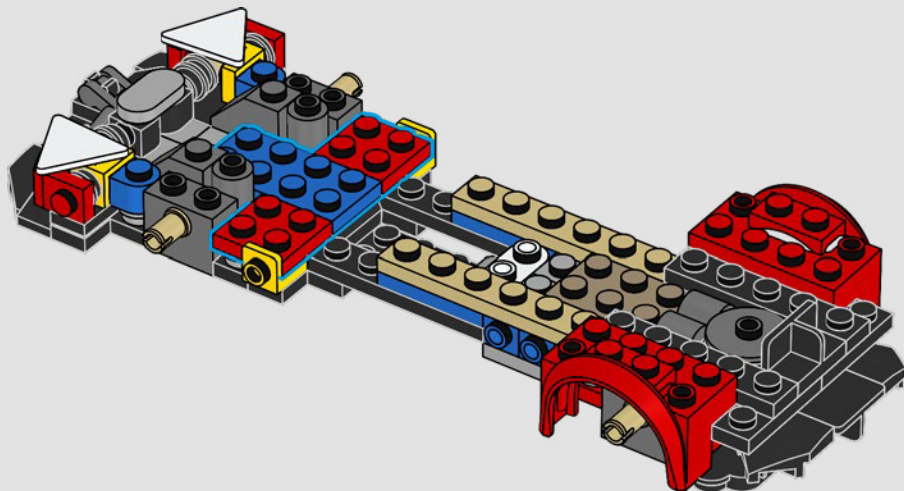



4x

40

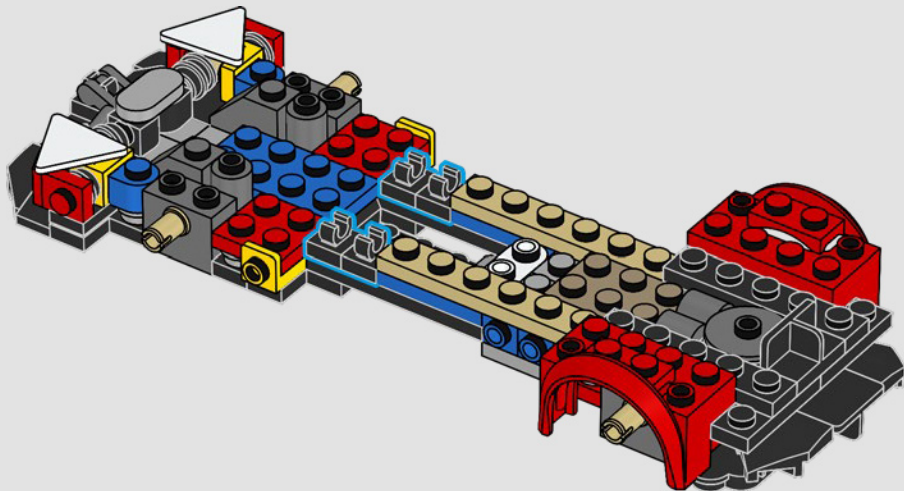

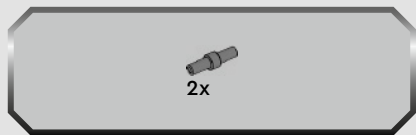

41

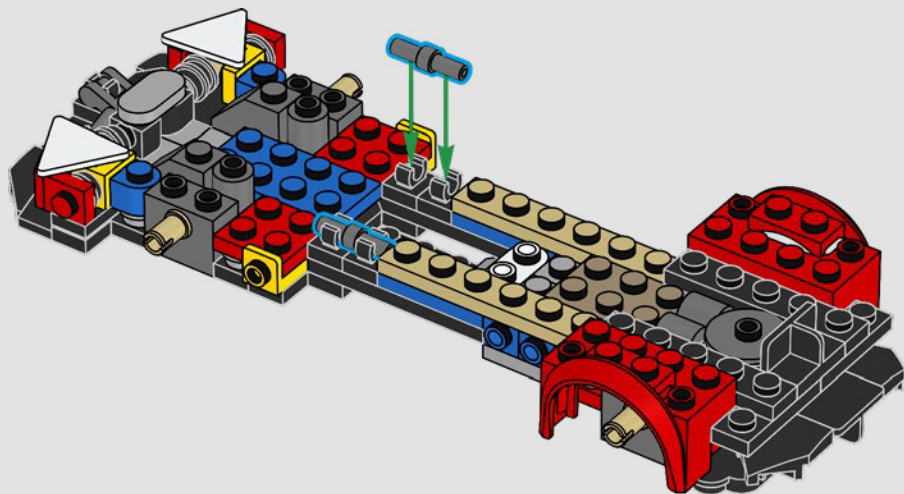

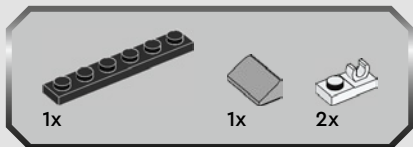

42

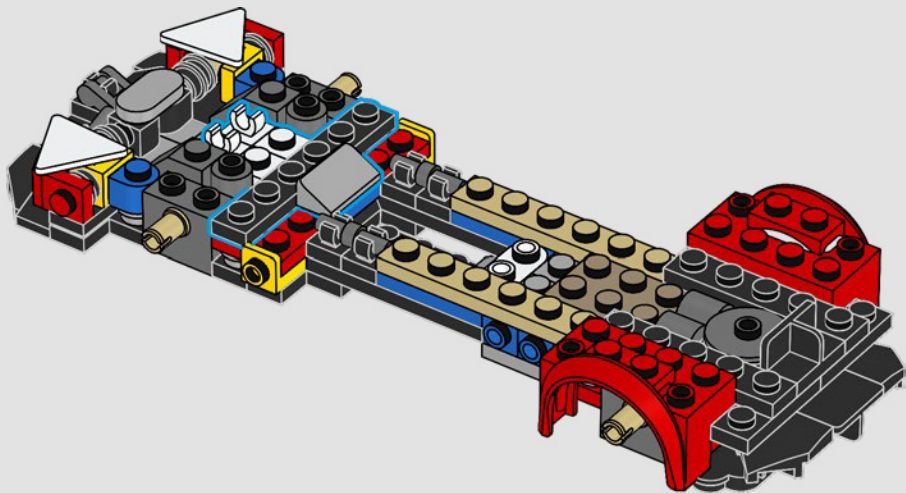

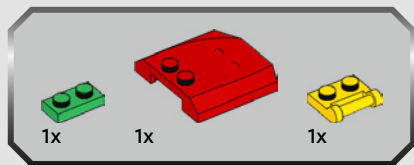

43

1

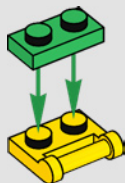

2

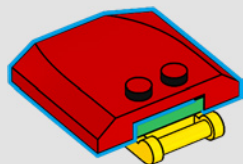

3

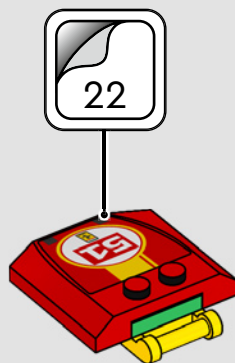

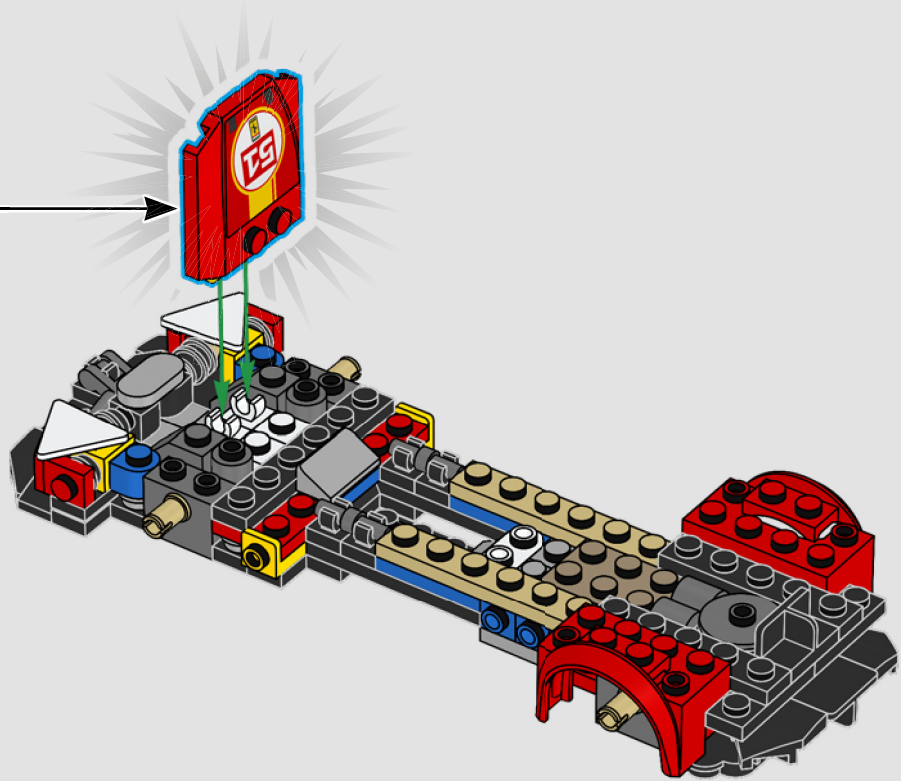

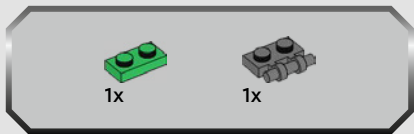

44

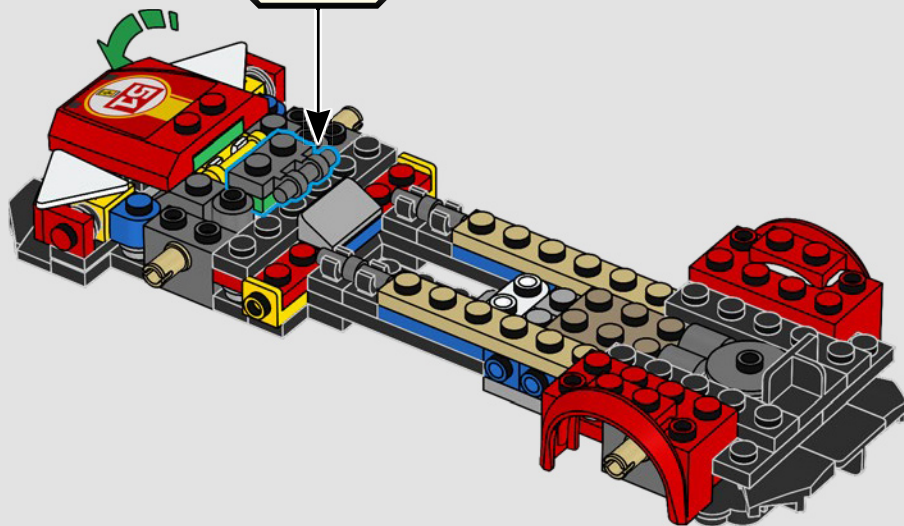
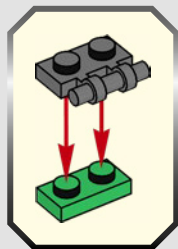

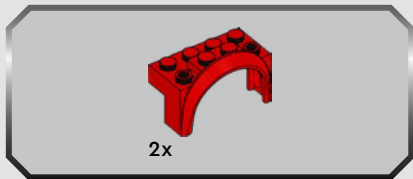

45

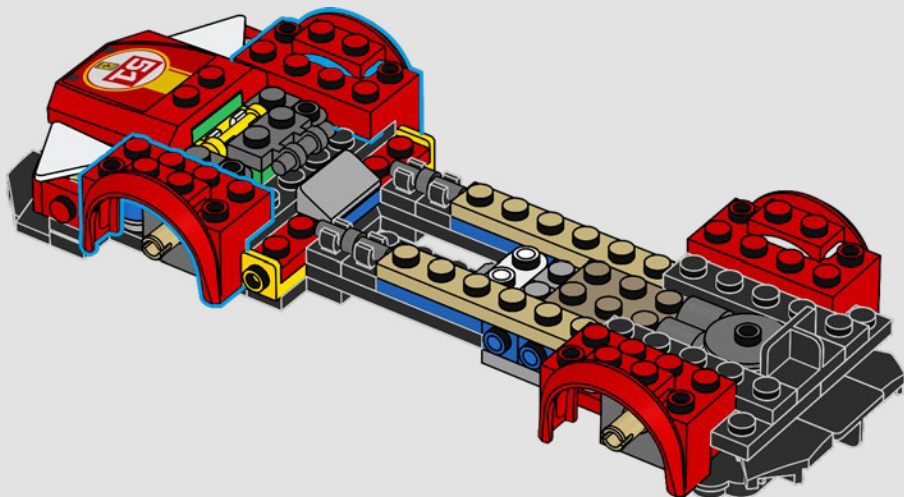

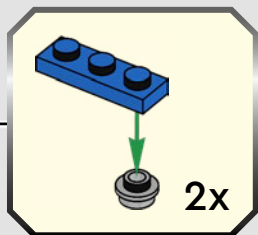
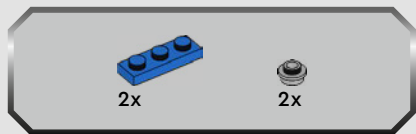

46

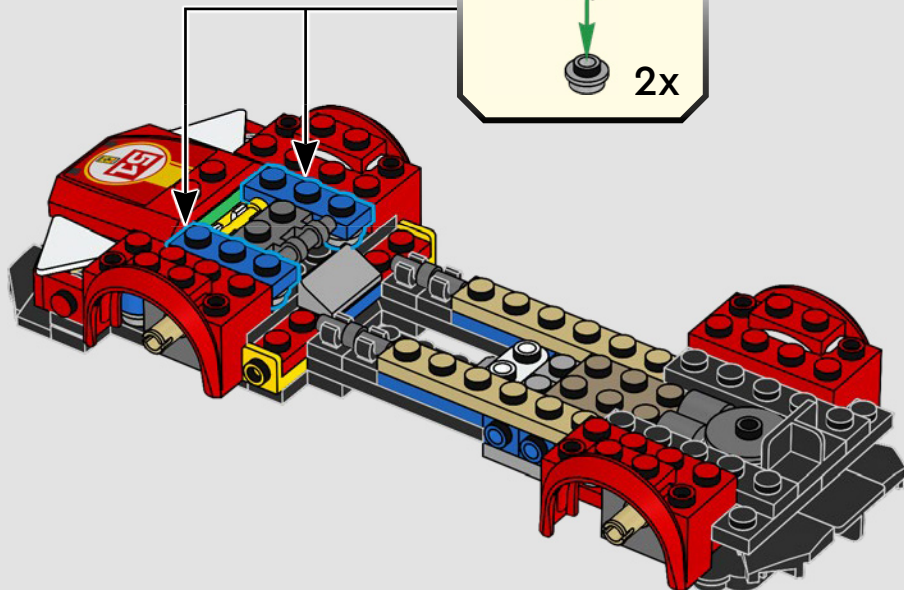



47

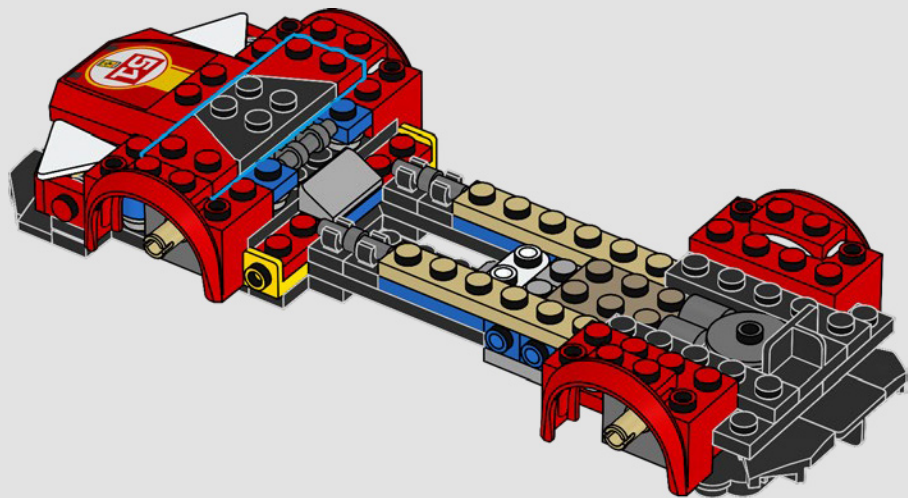



48

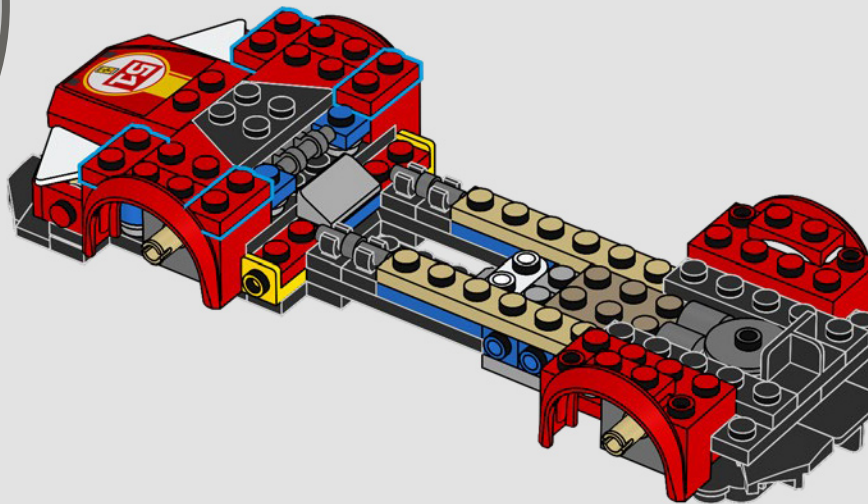



49

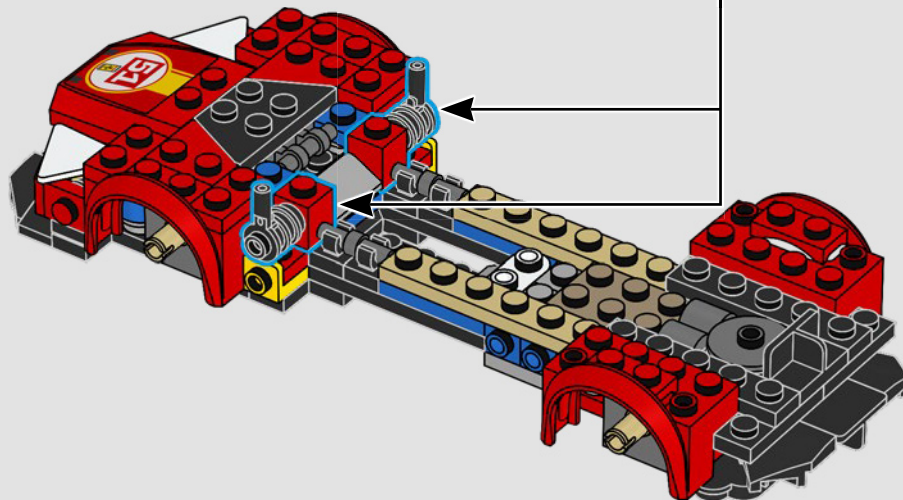
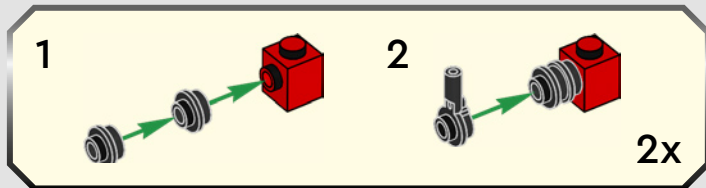



50

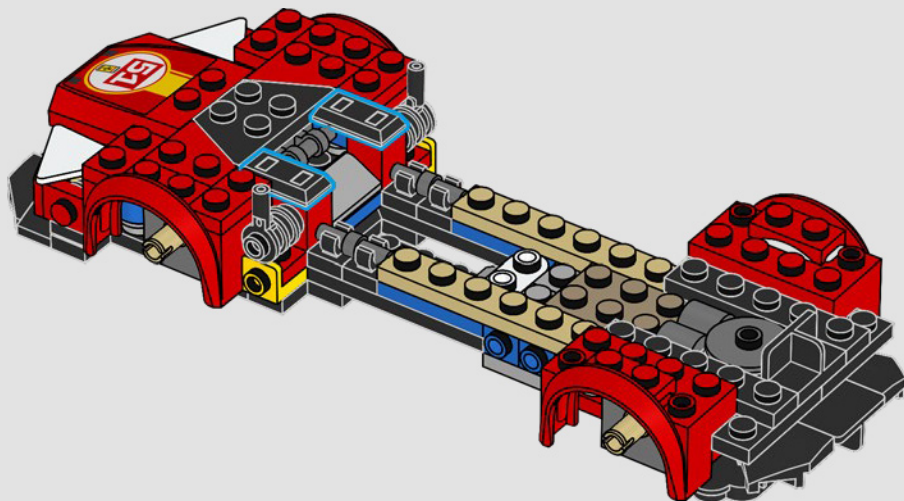

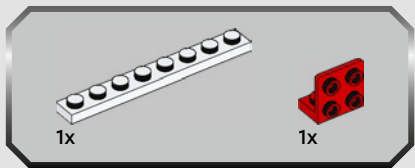

51

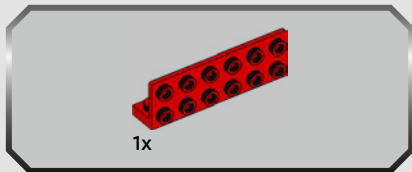
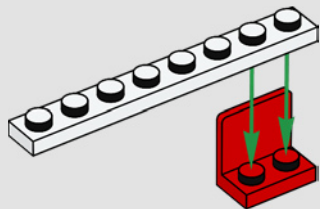

52

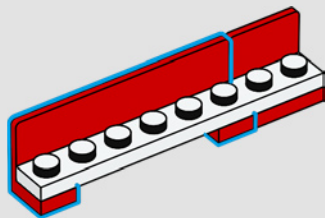



53

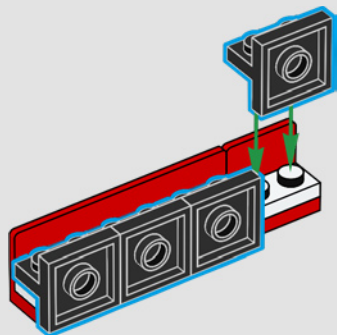

54

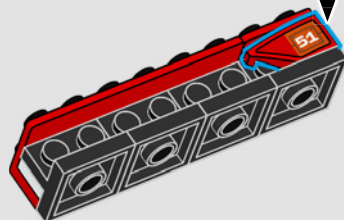
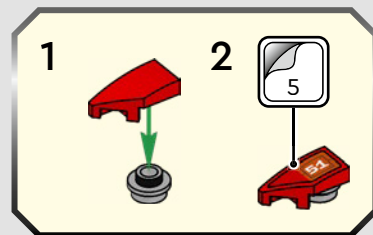

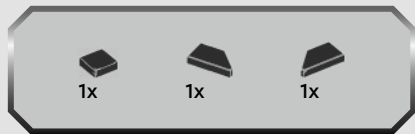

55

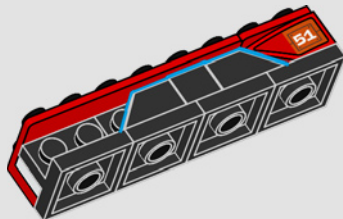

56

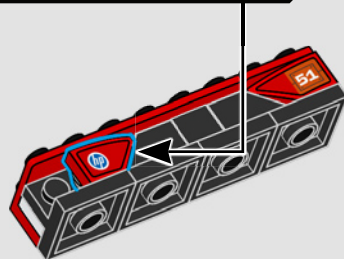
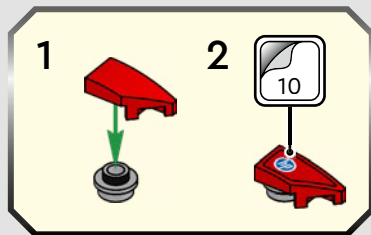

57

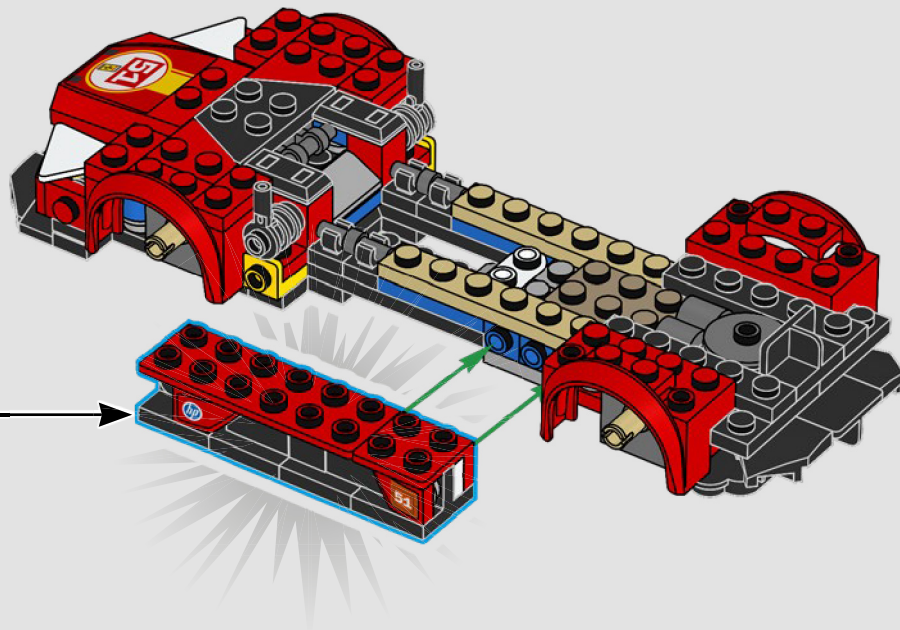

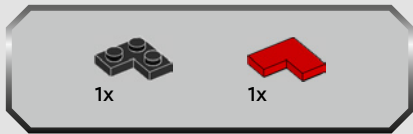

58

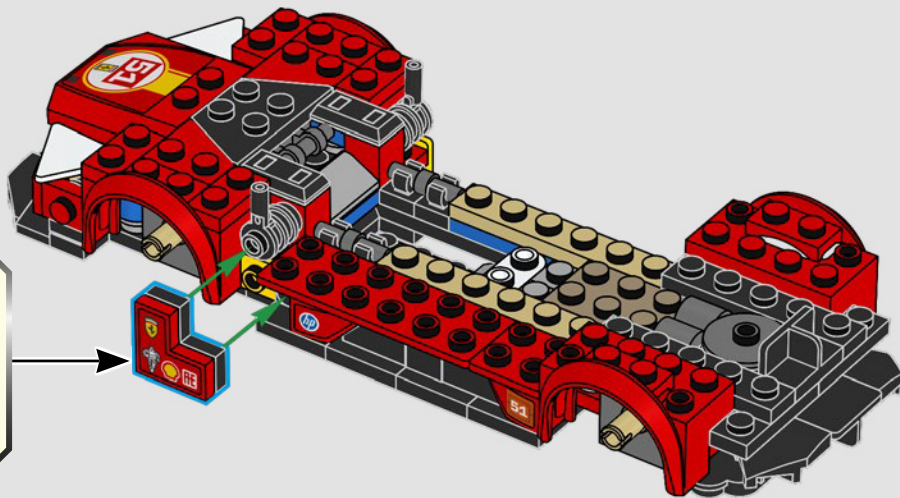
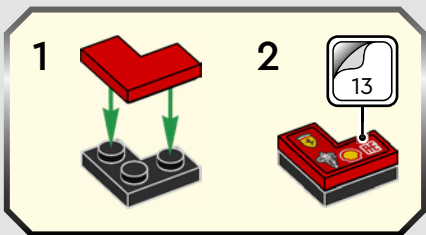

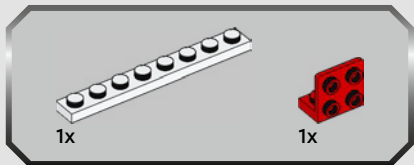

59

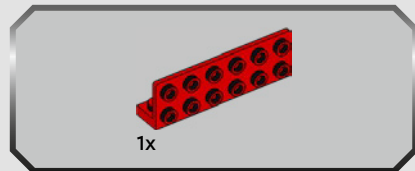
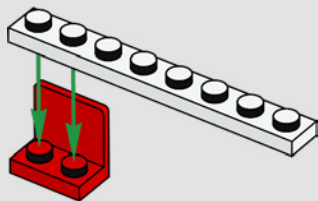

60

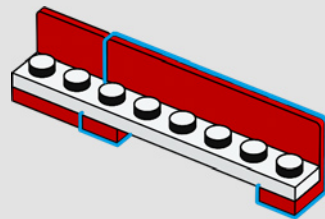



61

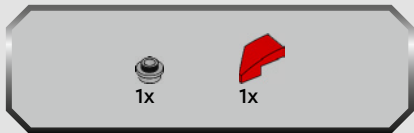
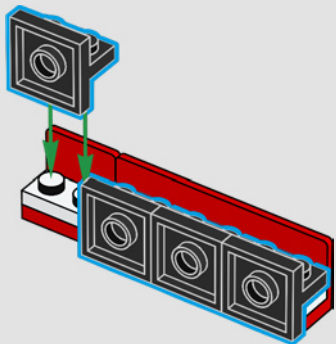

62

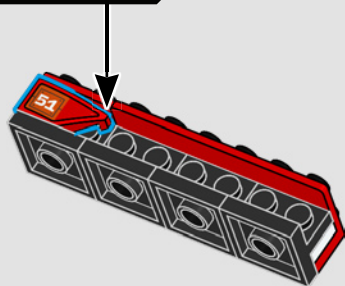
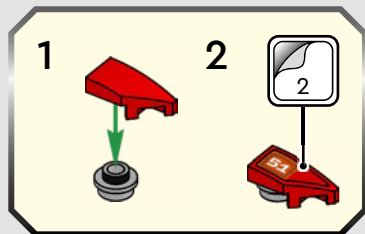



63

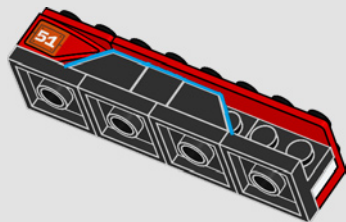

64

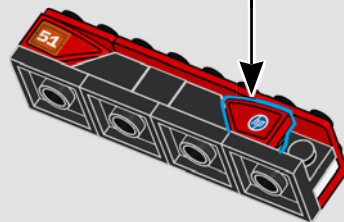
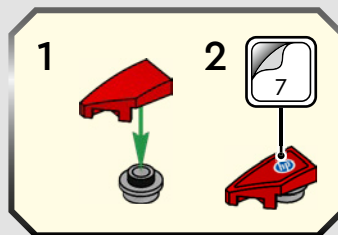

65

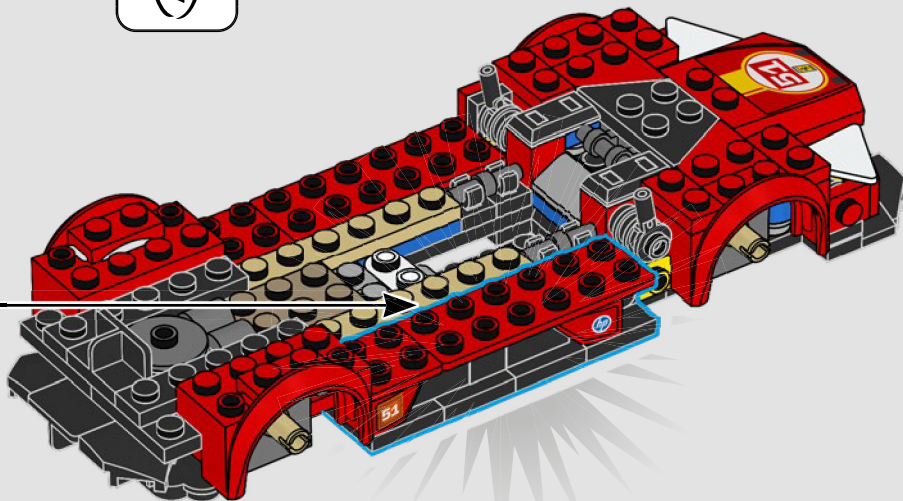

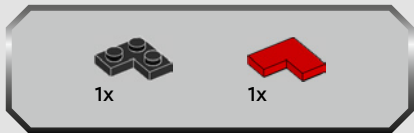

66

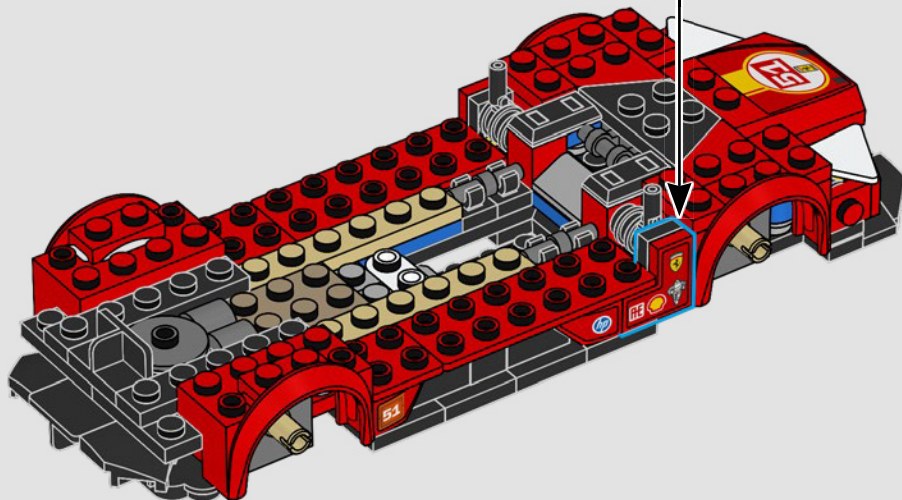
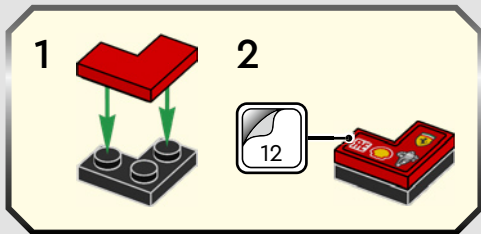

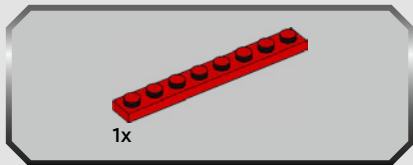

67

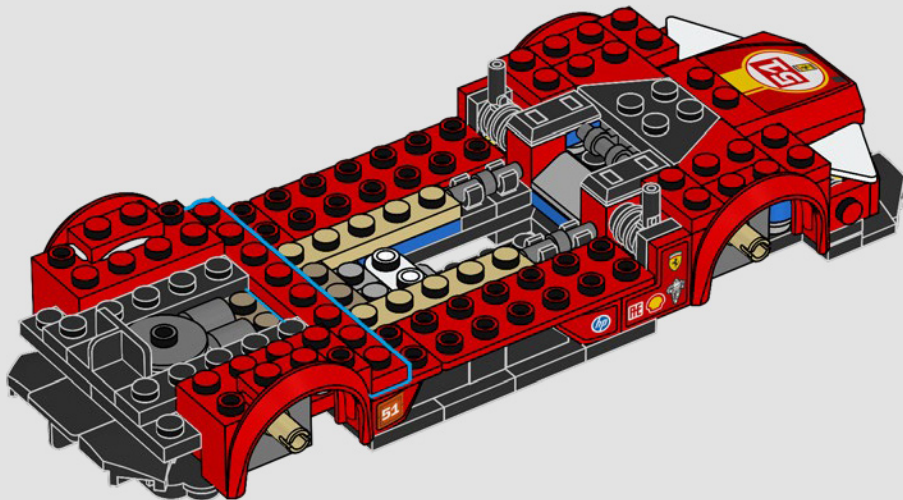

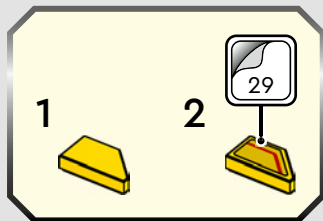
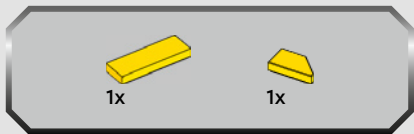

68

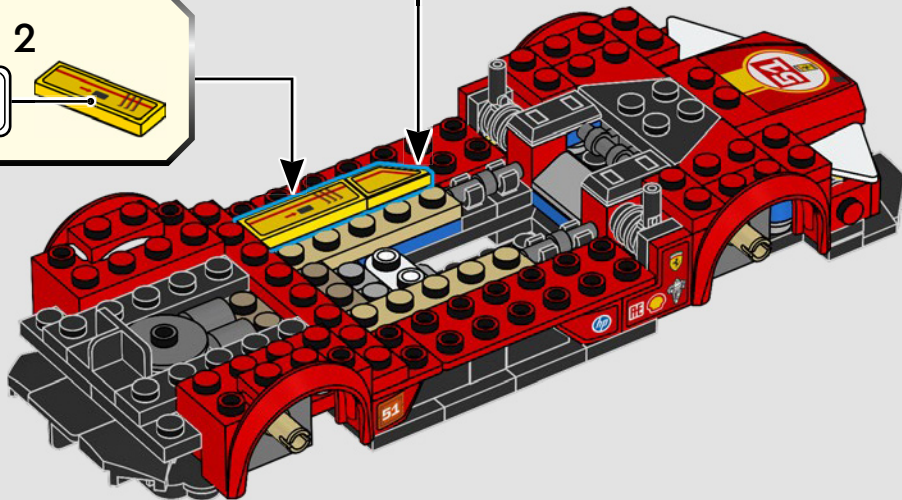
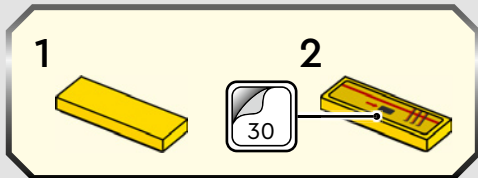

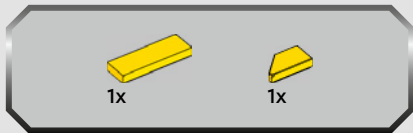

69

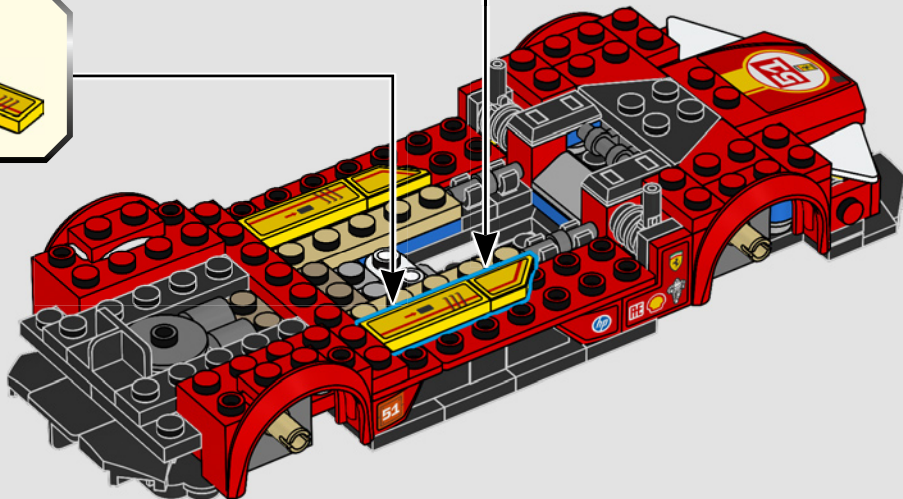
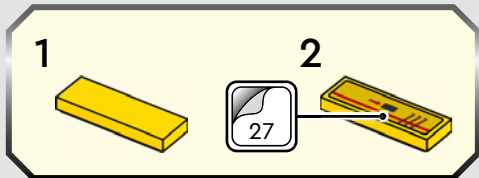
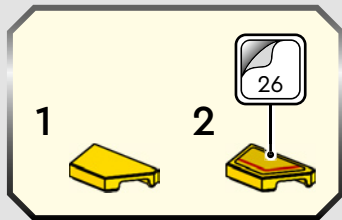

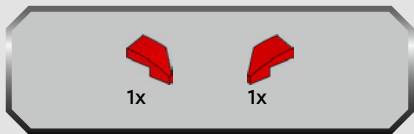

70

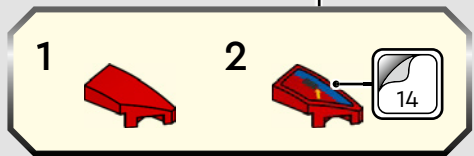
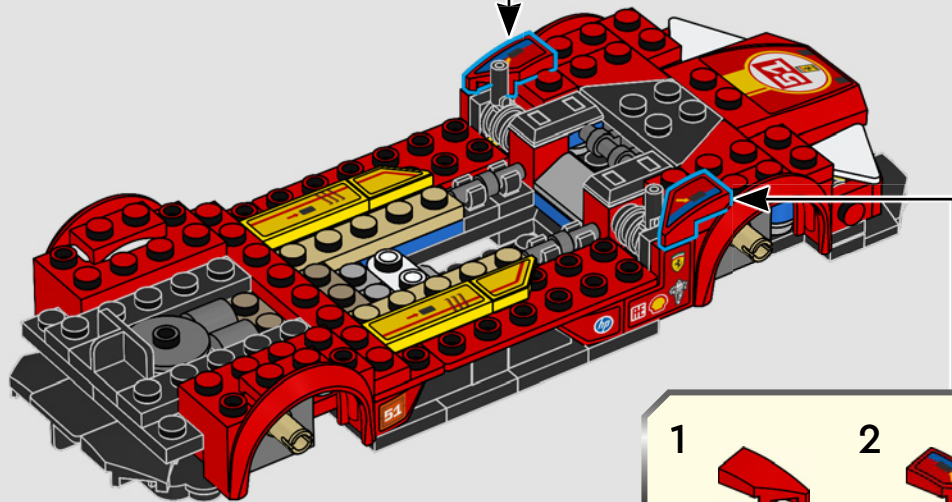
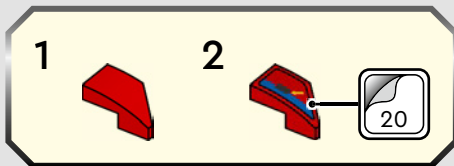



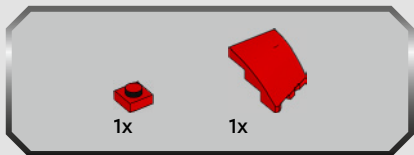

71

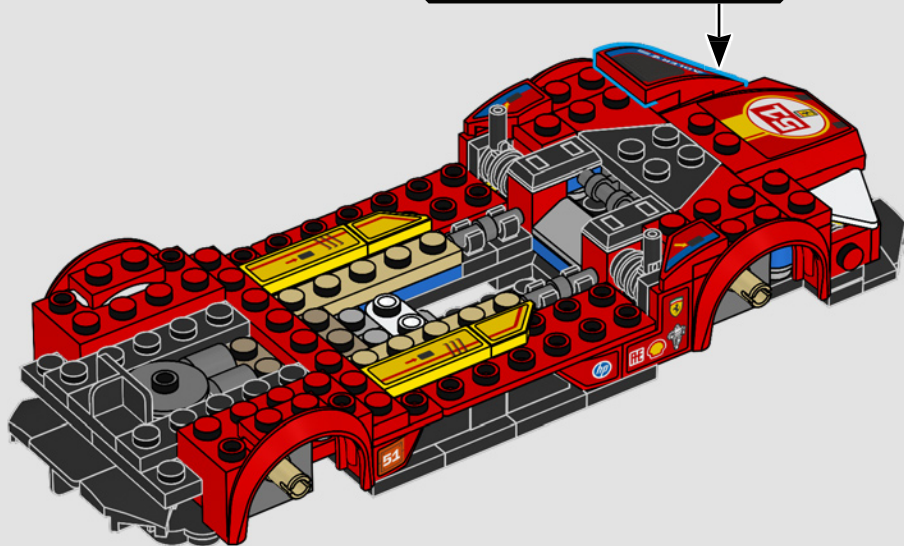
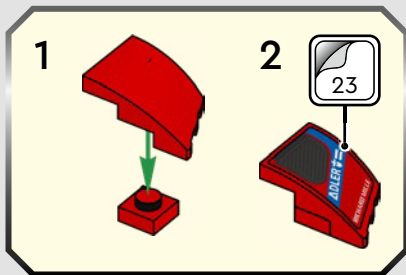

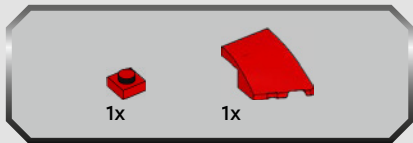

72

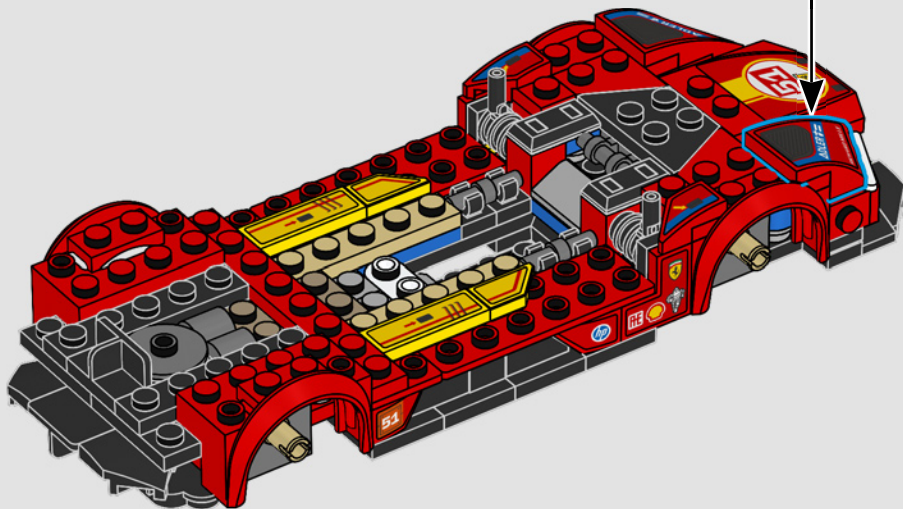
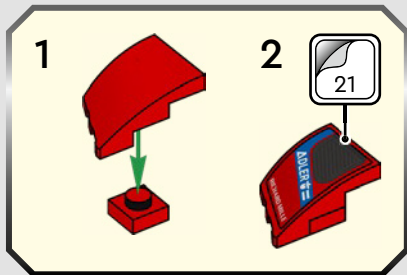



73

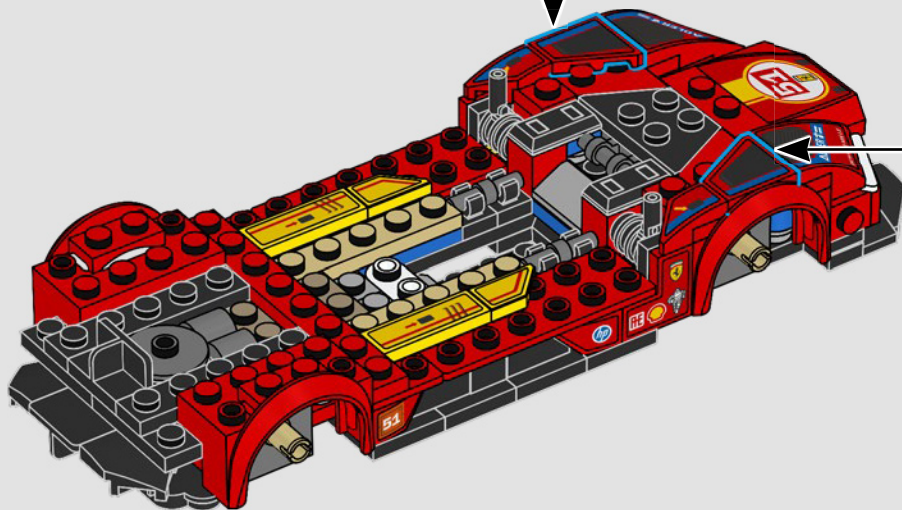
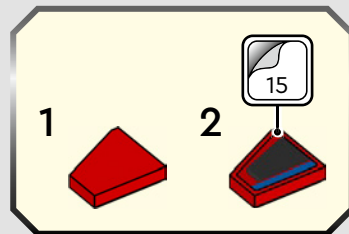
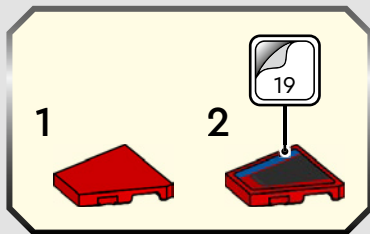

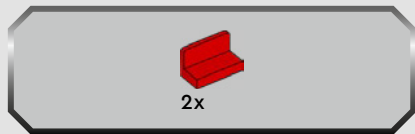

74

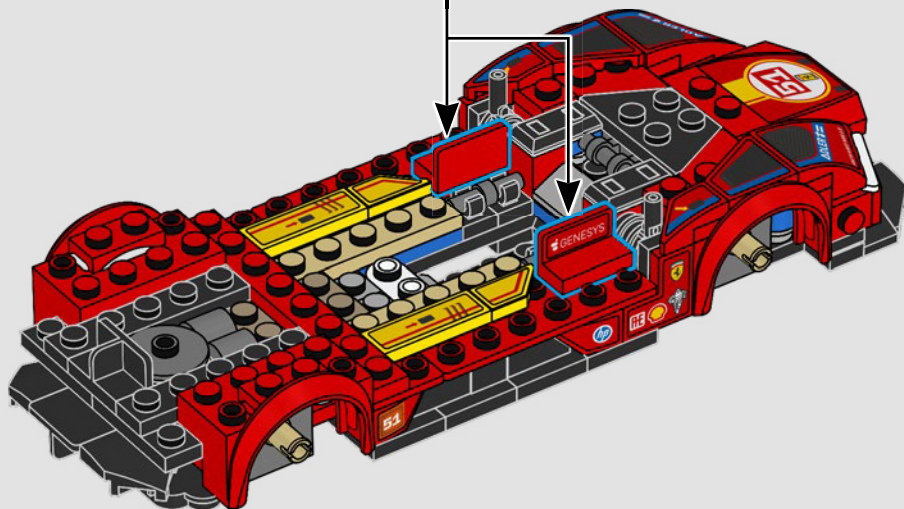
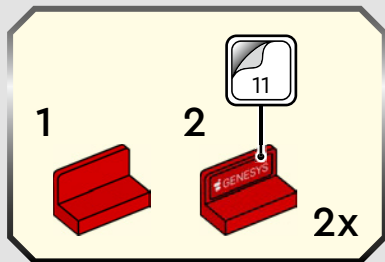



75

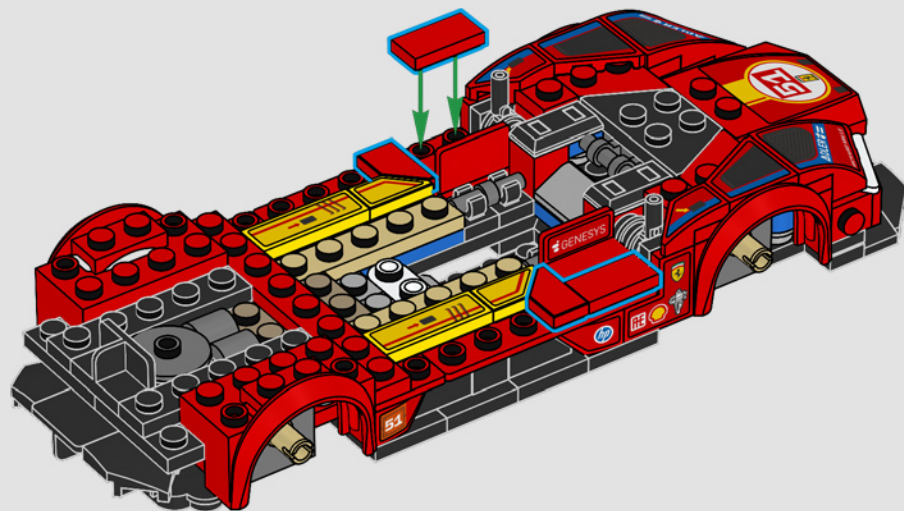

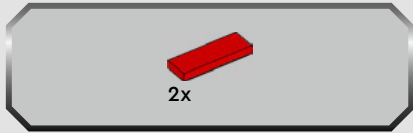

76

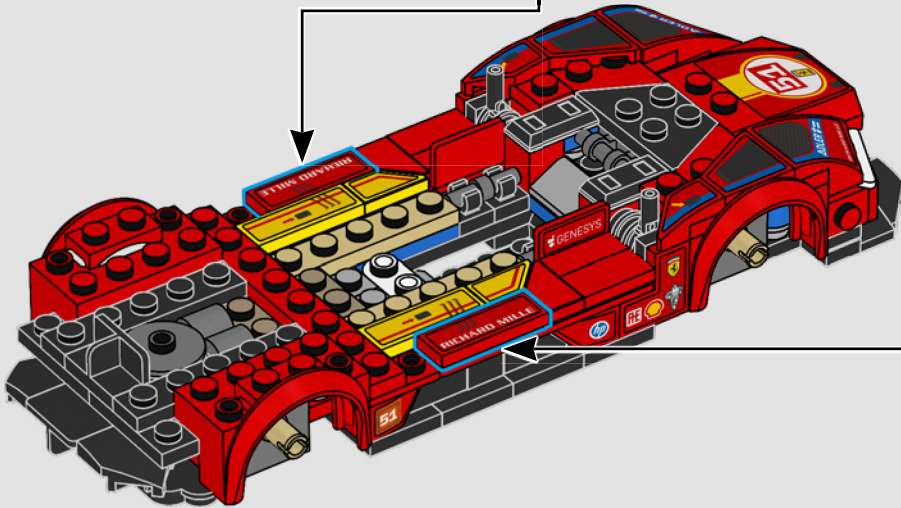
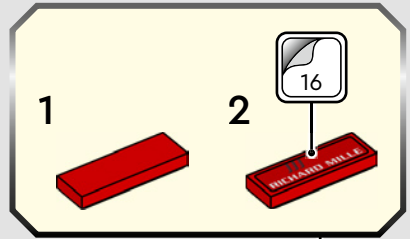
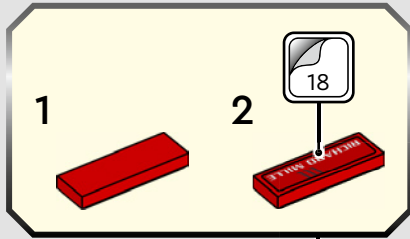



77

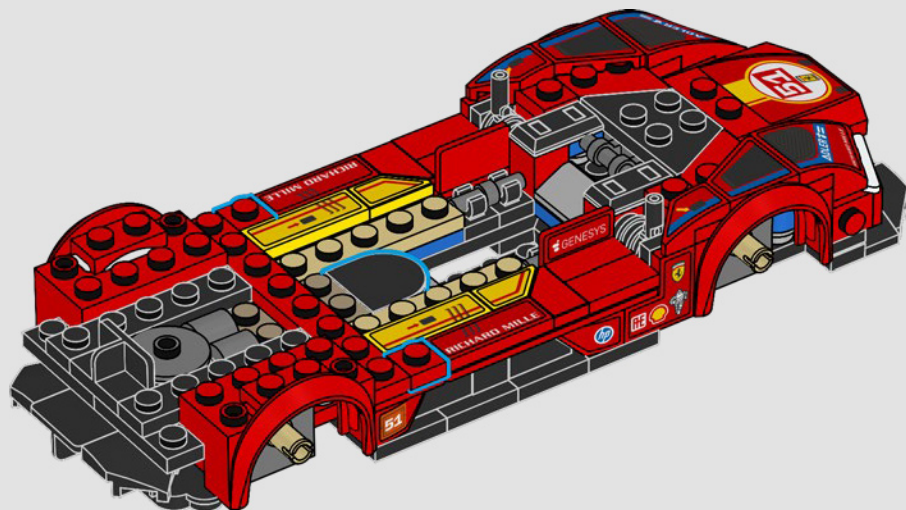

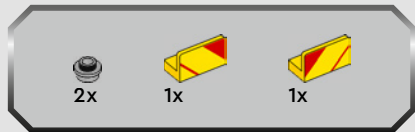

78

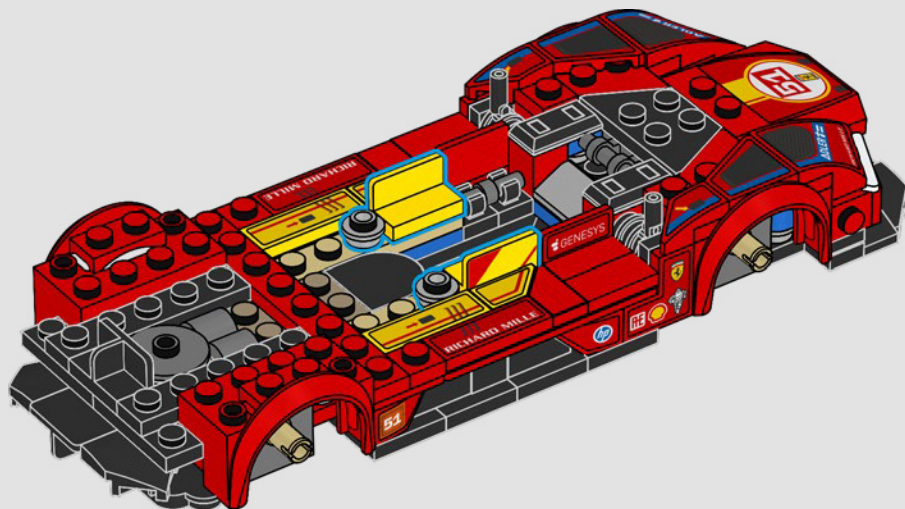



79

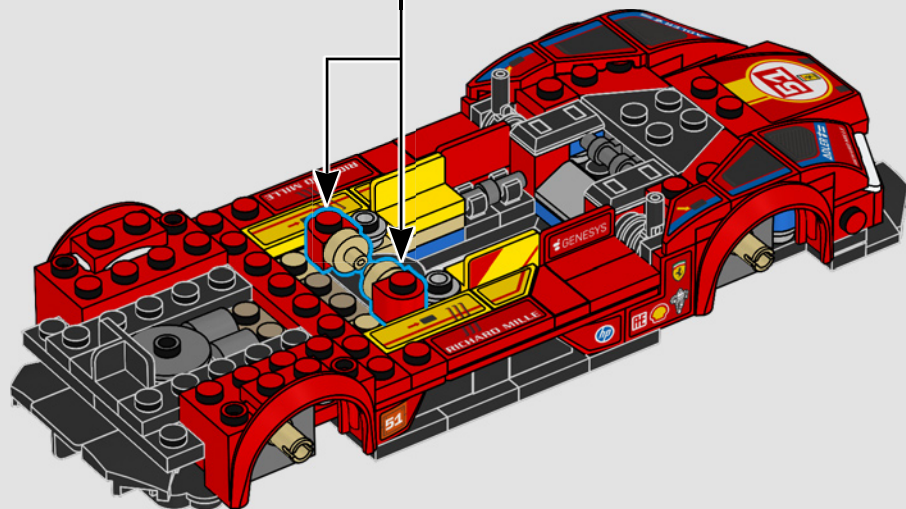
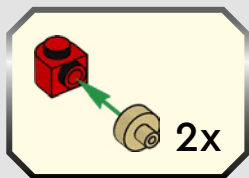

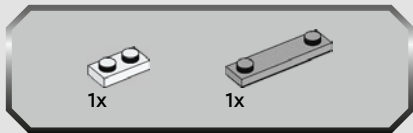

80

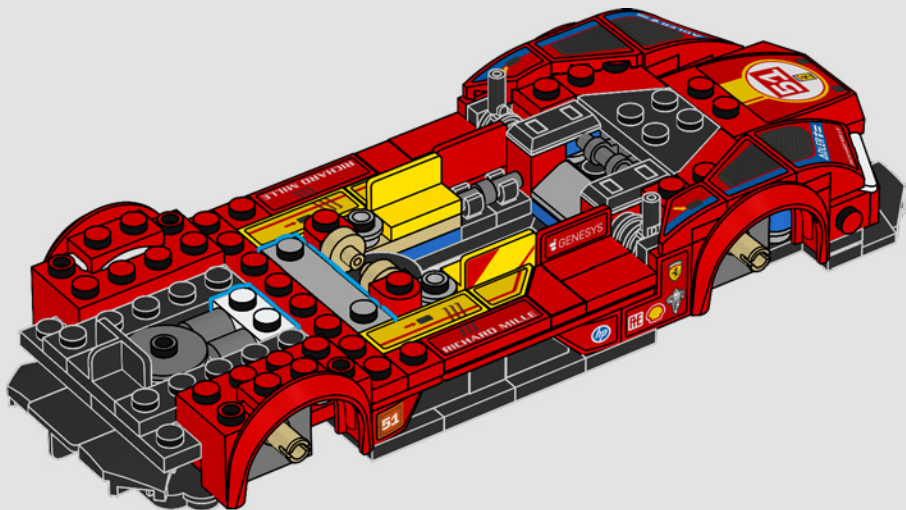



2x



2x

# 81

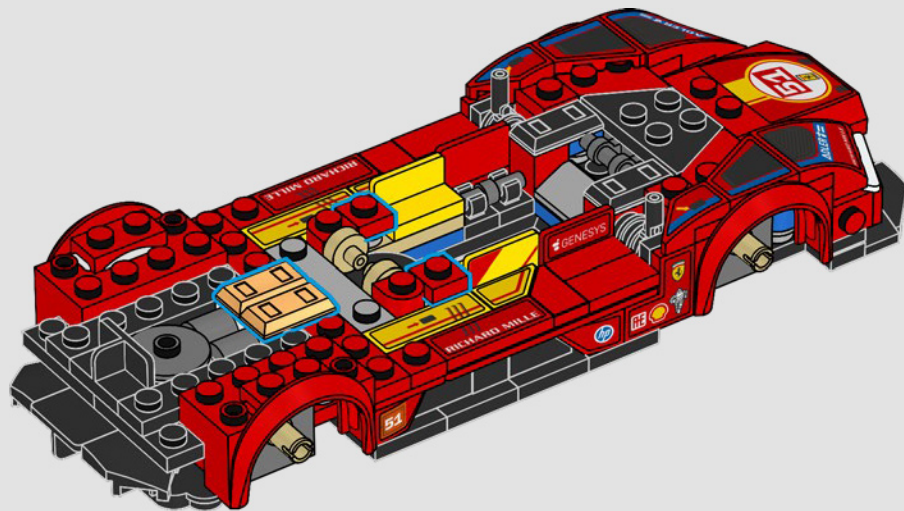



82

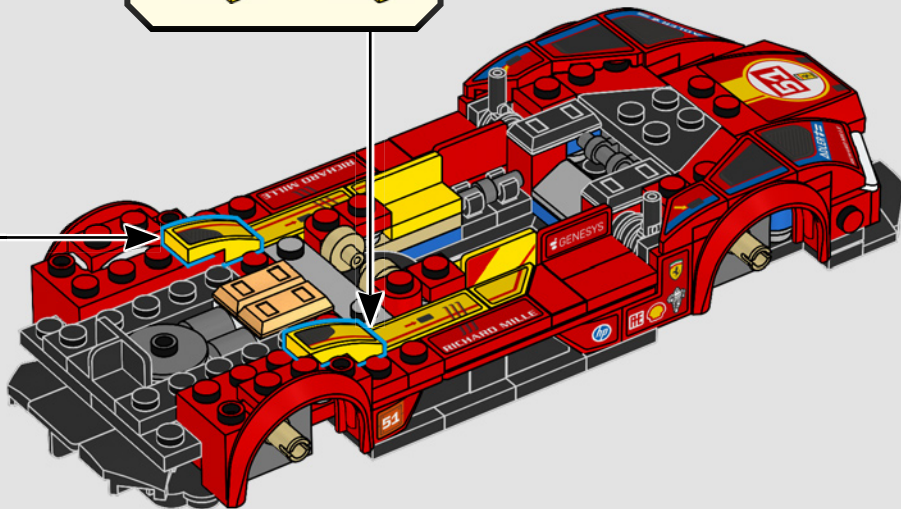
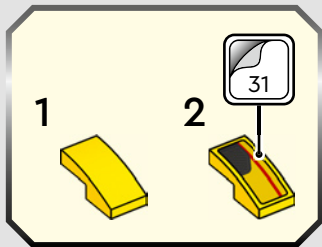
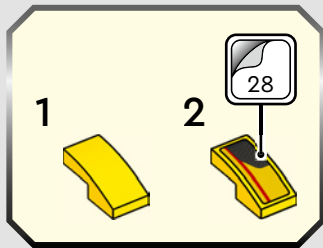

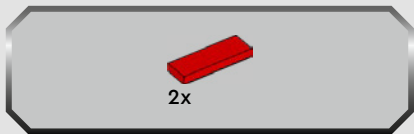

83

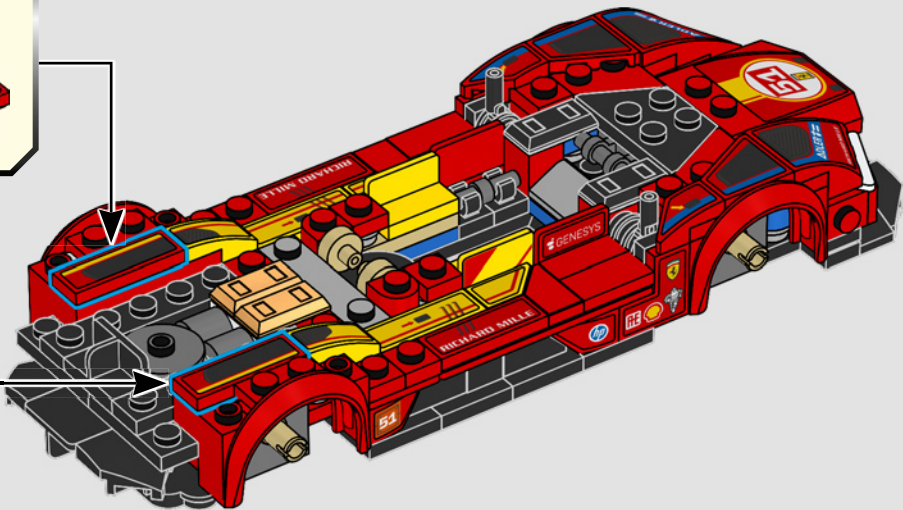
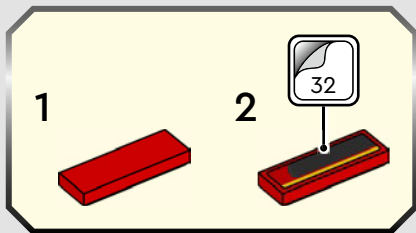
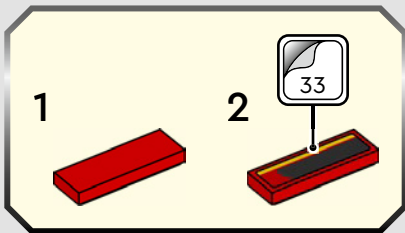

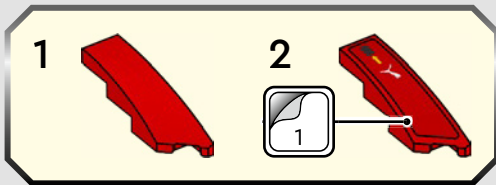
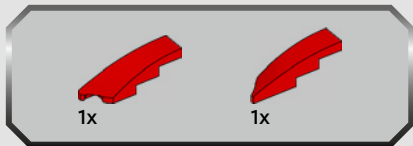

84

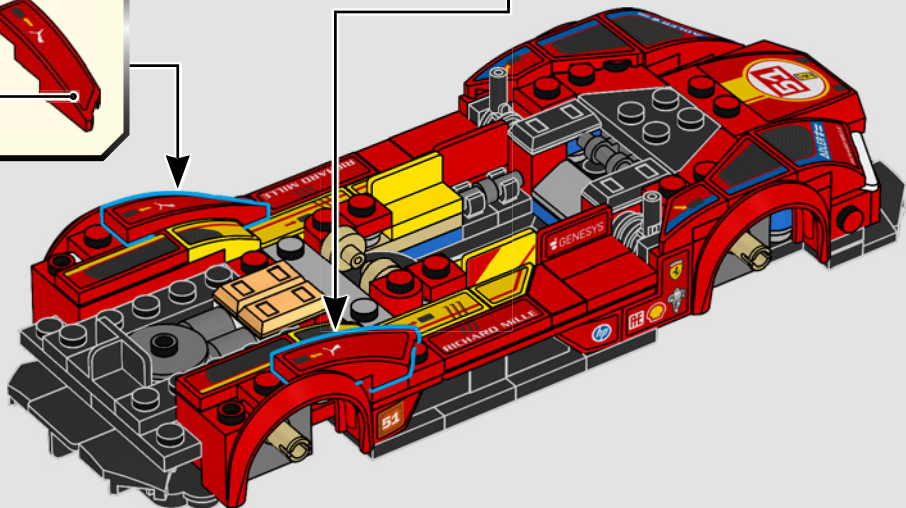
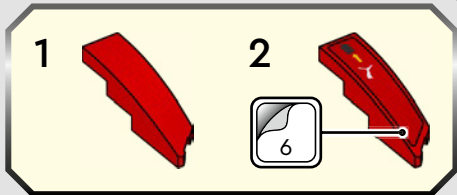

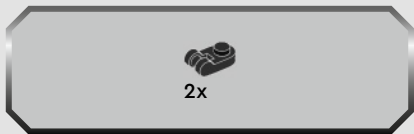

85

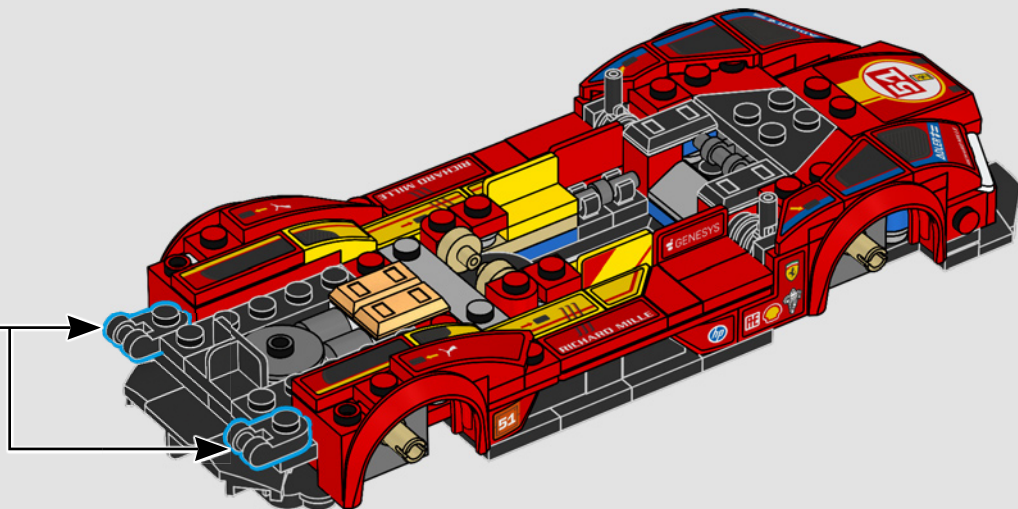

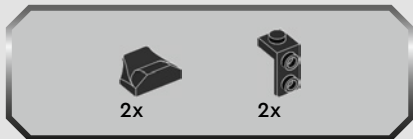

86

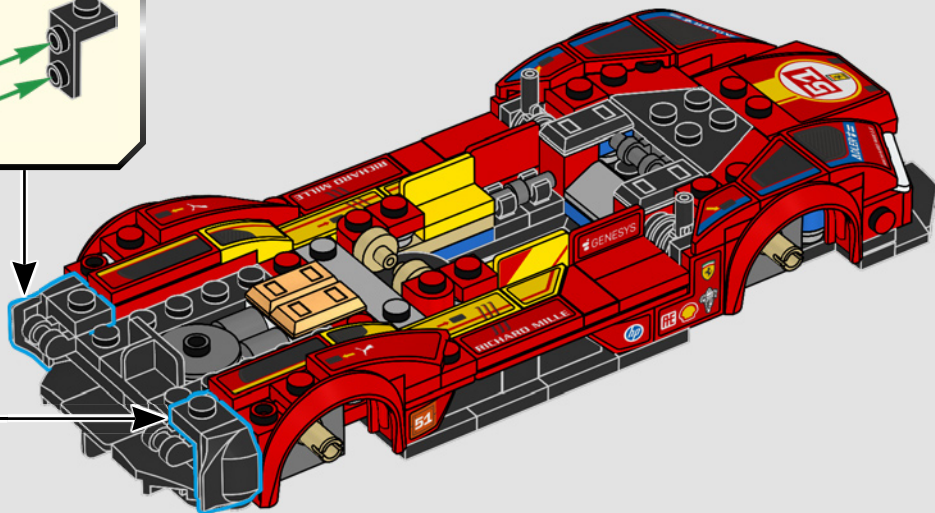
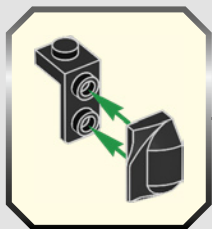
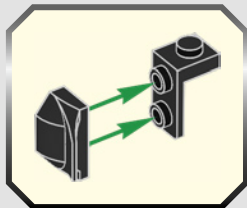



2x

87

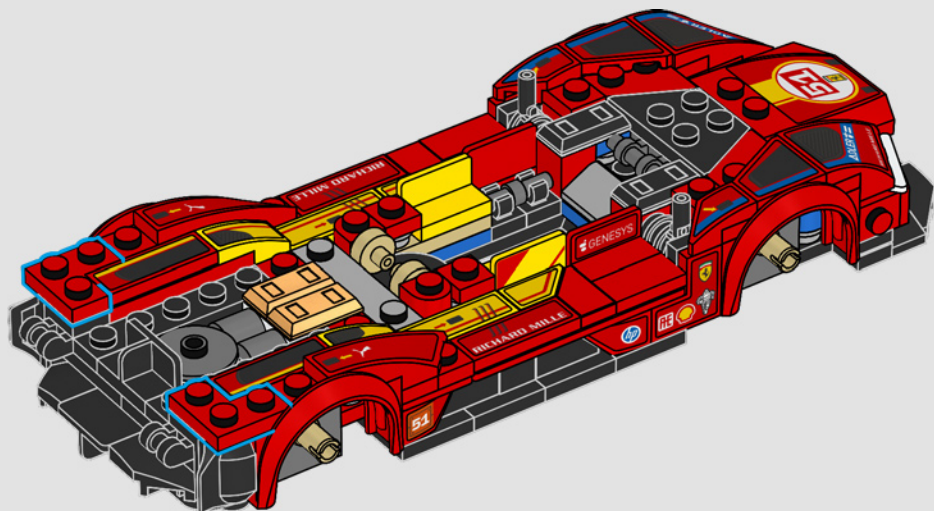

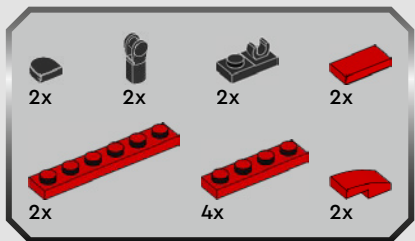
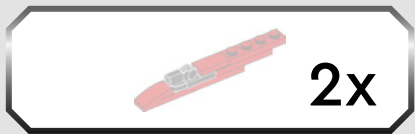

88

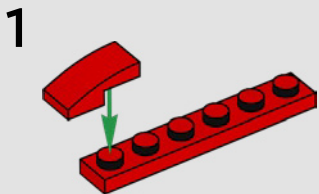

2

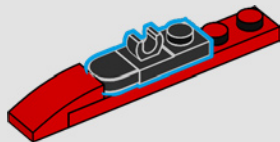

3

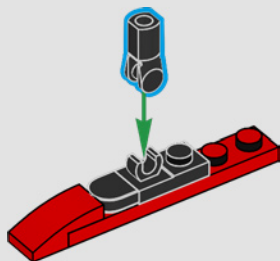

4

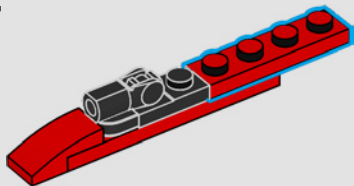

5

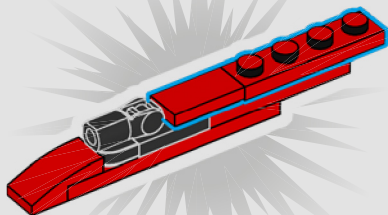

2x

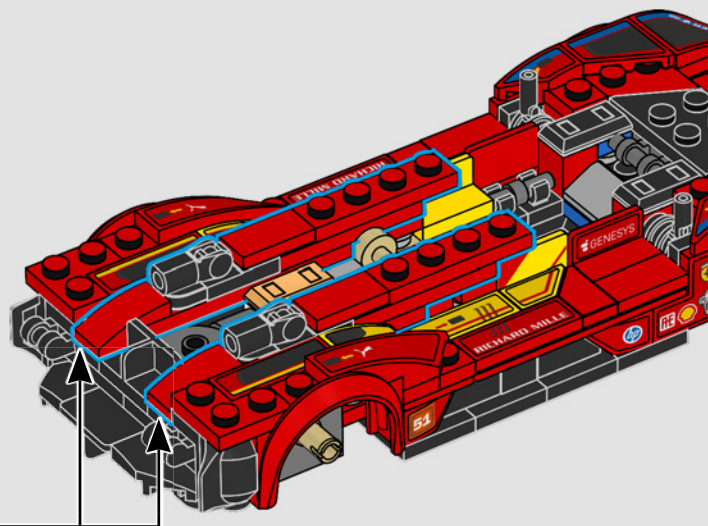



2x



2x

89

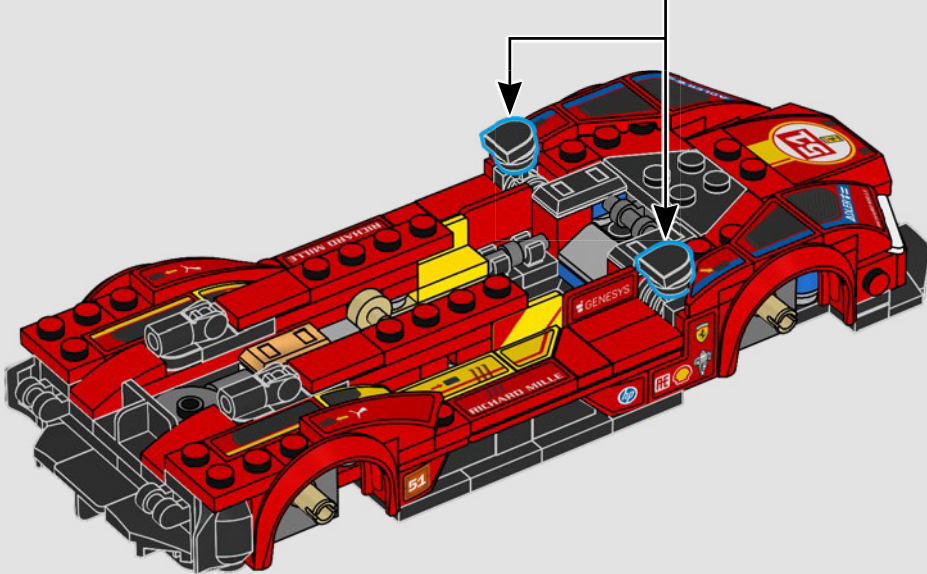
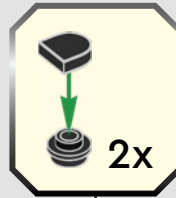



90

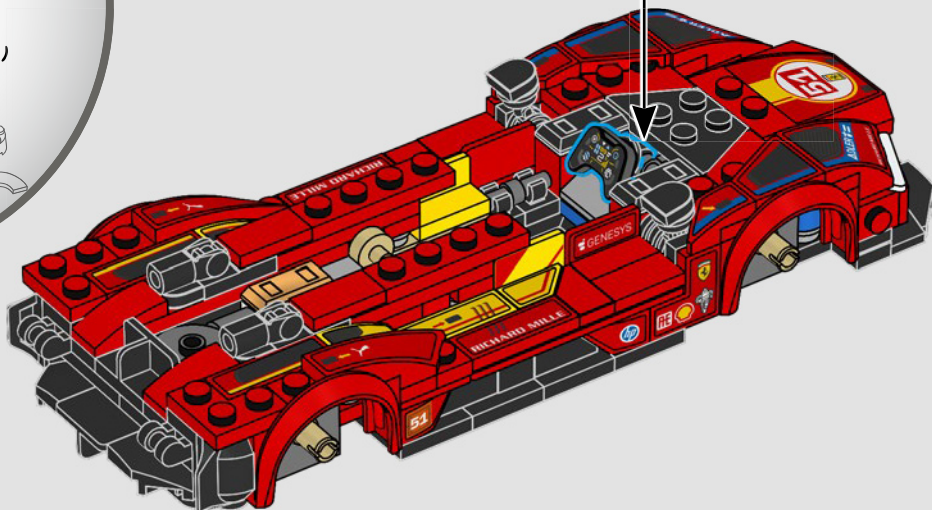
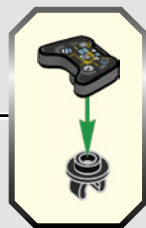



2x

91

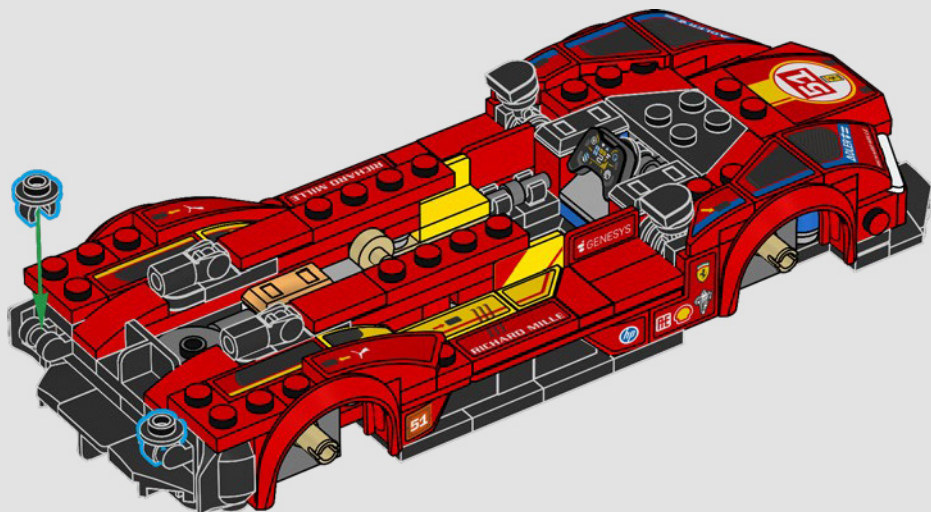

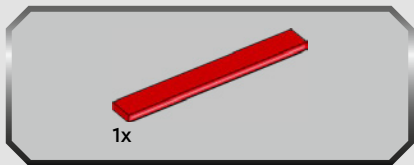

92

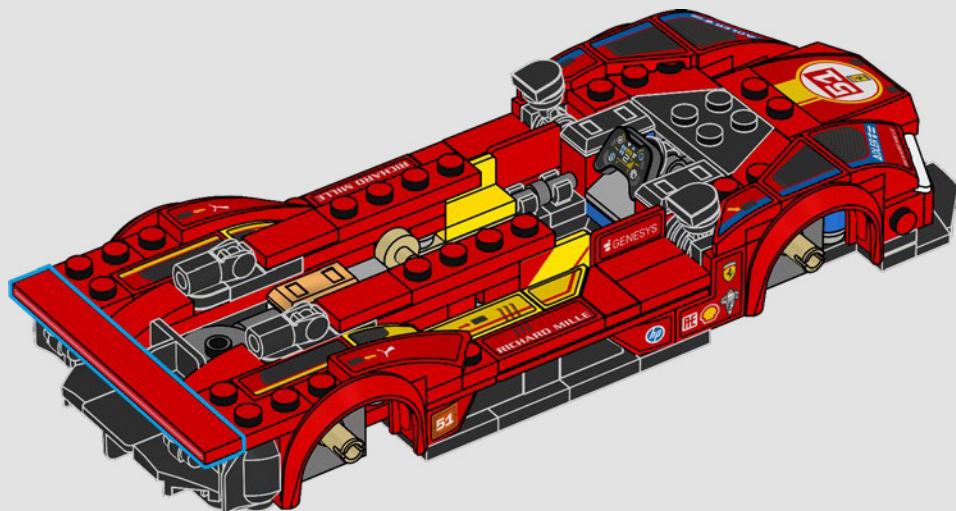

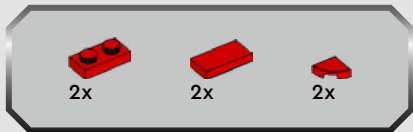

93

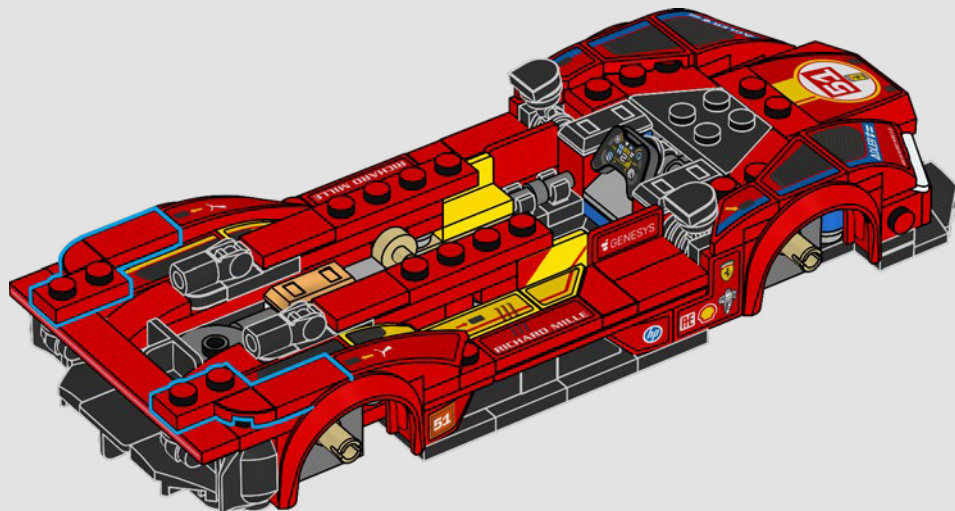

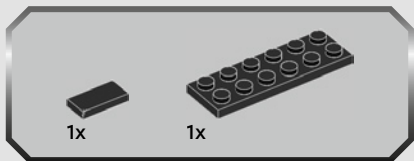
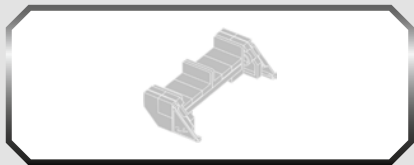

94

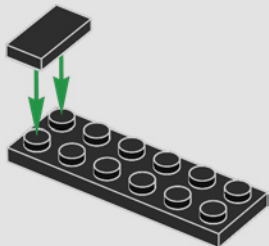

95

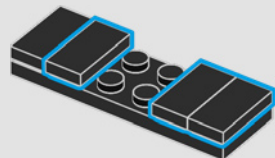

96

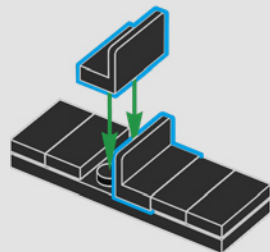



2x

97

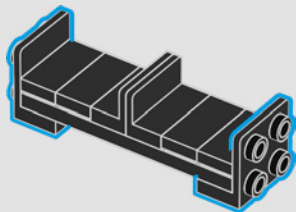

1x



1x

98

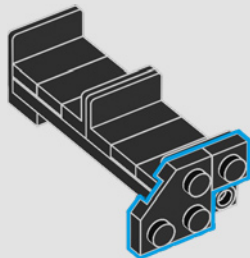

1x



1x

99

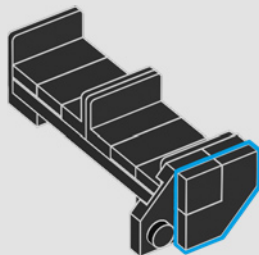



100

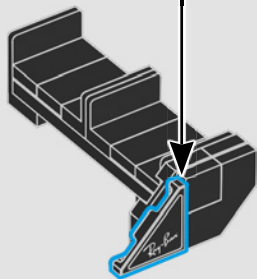
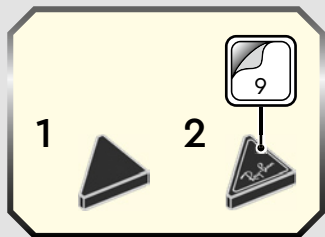

101

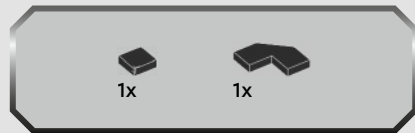
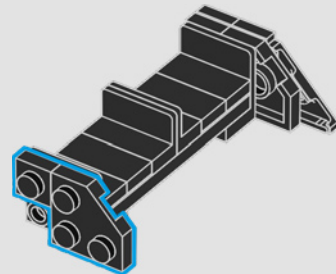

102

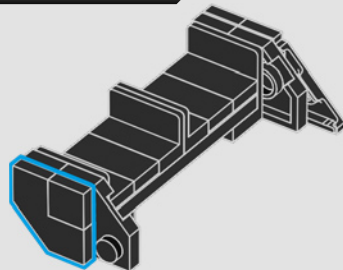



103

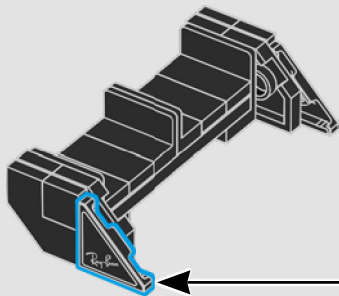
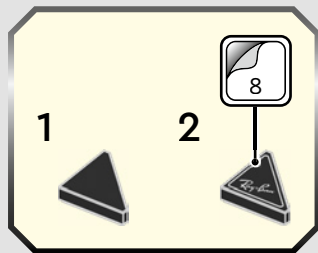

104

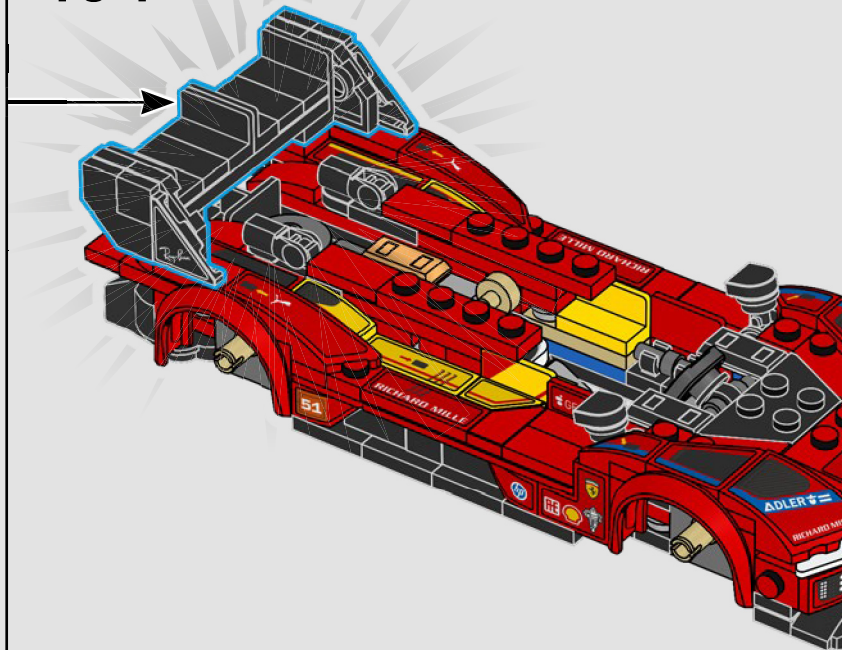

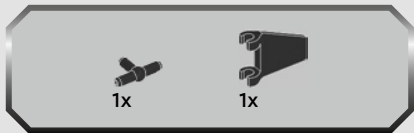

105

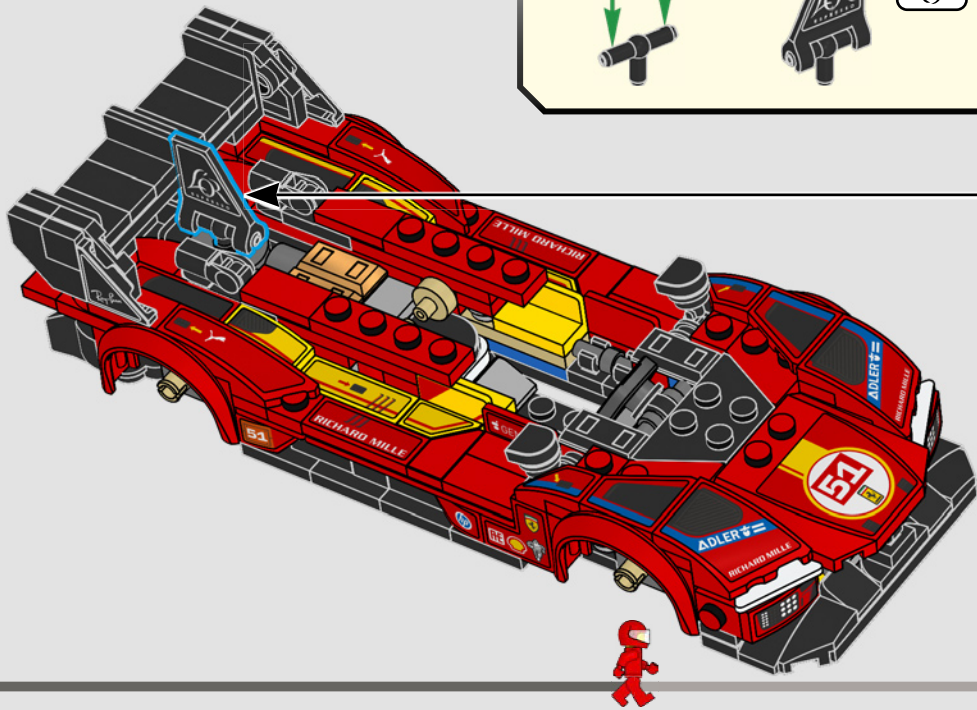
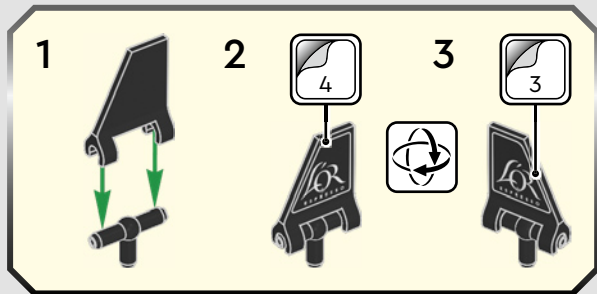

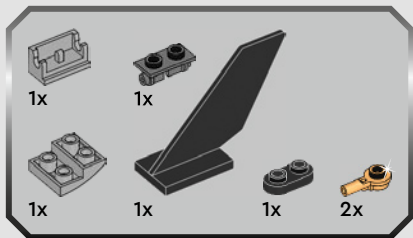

106

1

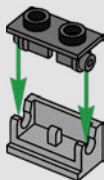

2

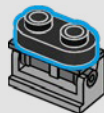

3



4

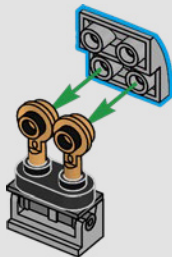

5

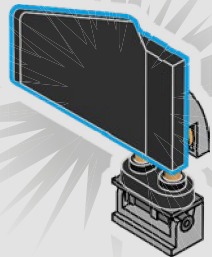

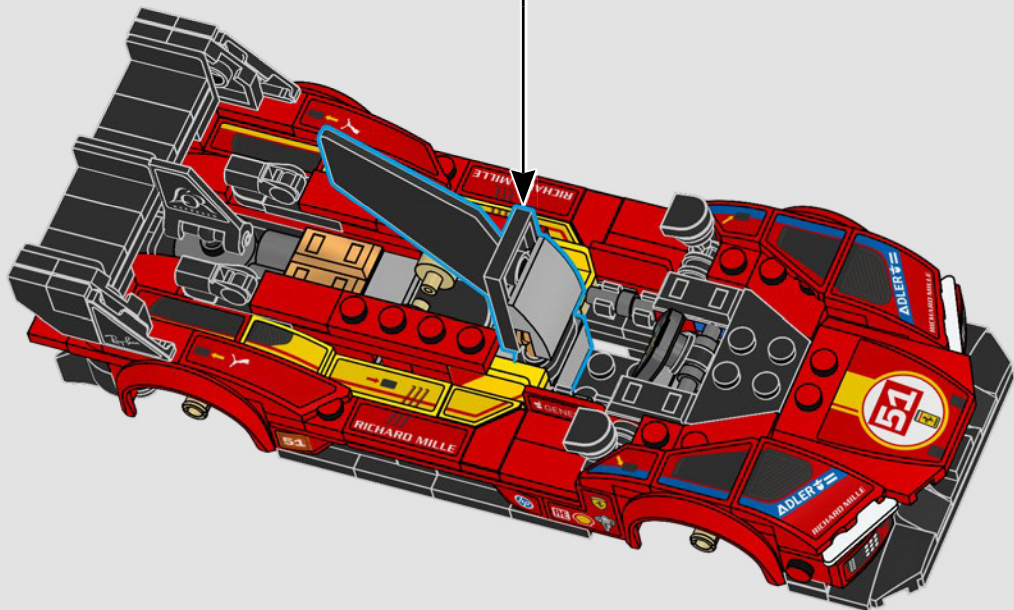

107

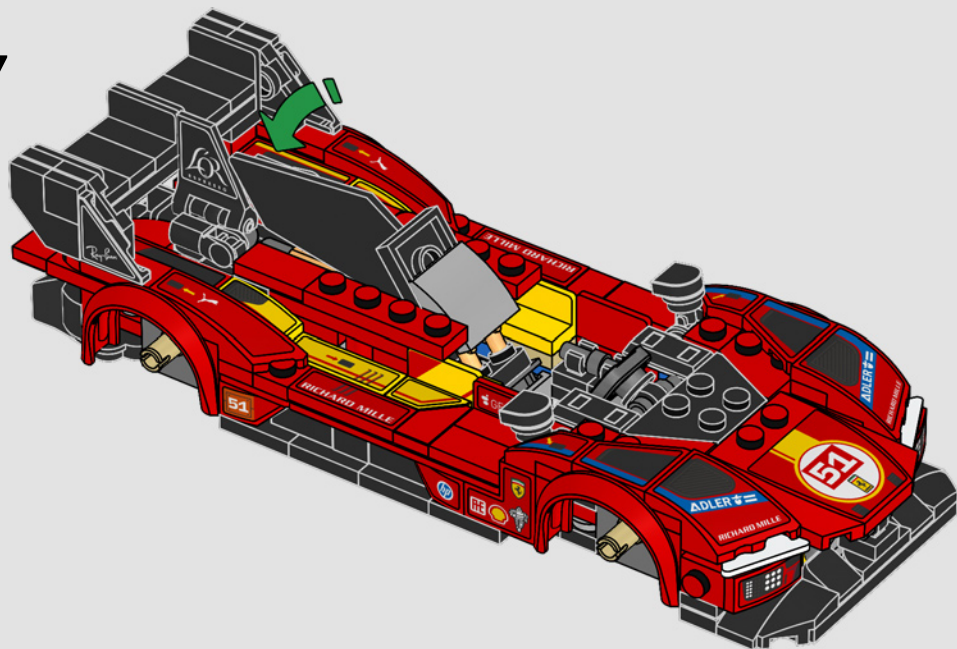

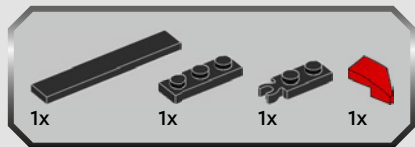

108

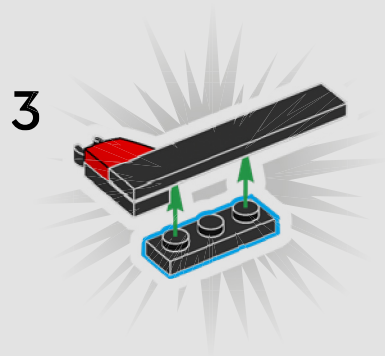
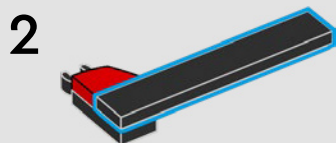
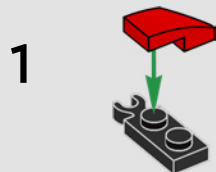

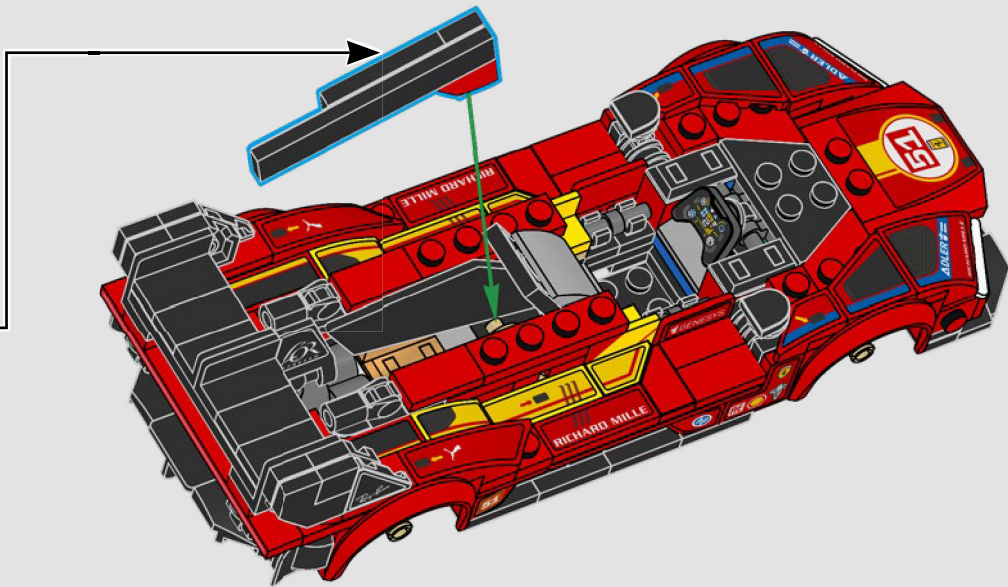

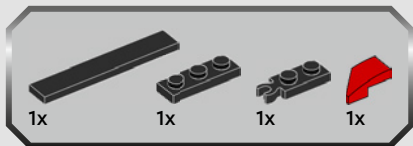

109

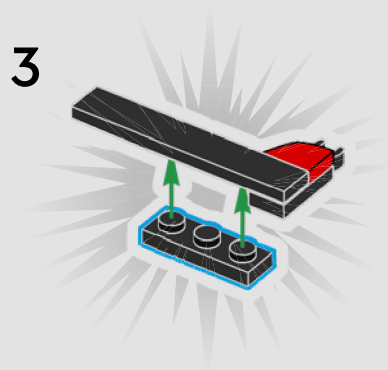
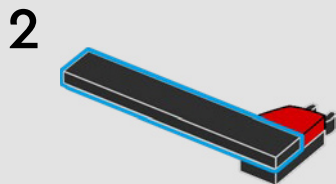
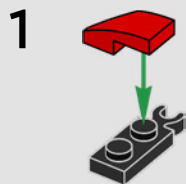

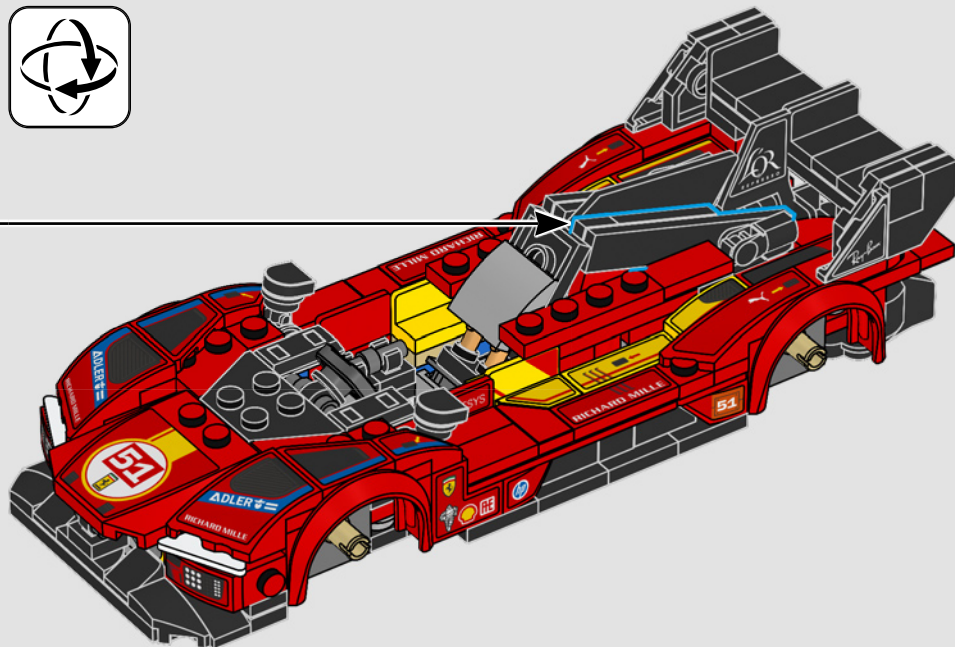



110

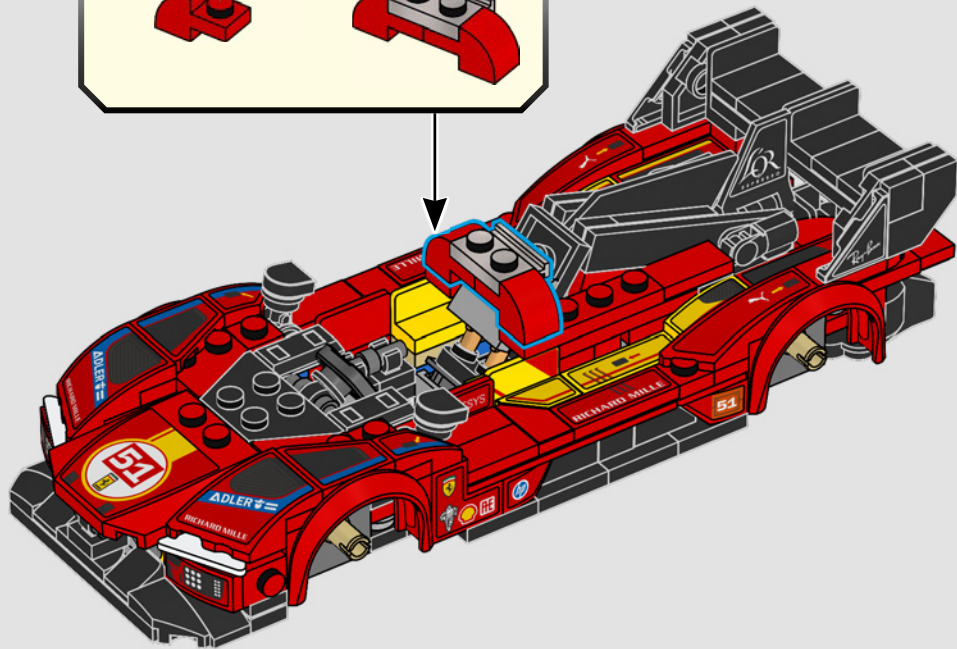
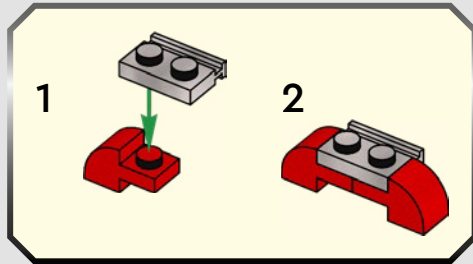

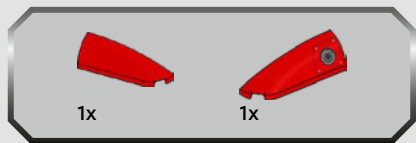

111

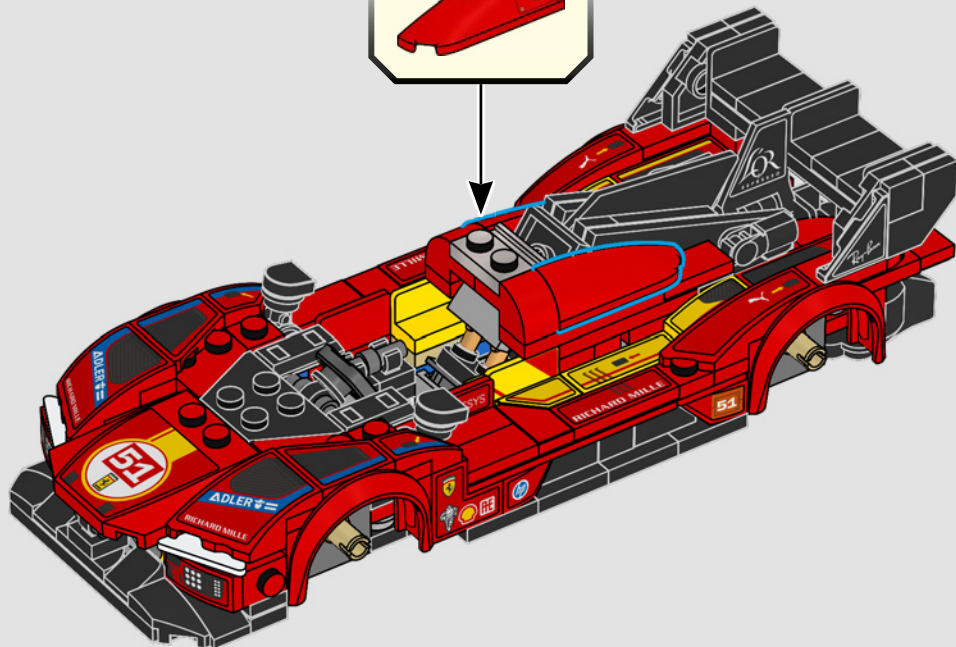

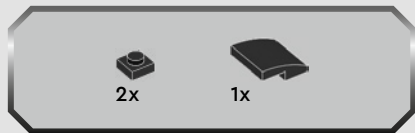

112

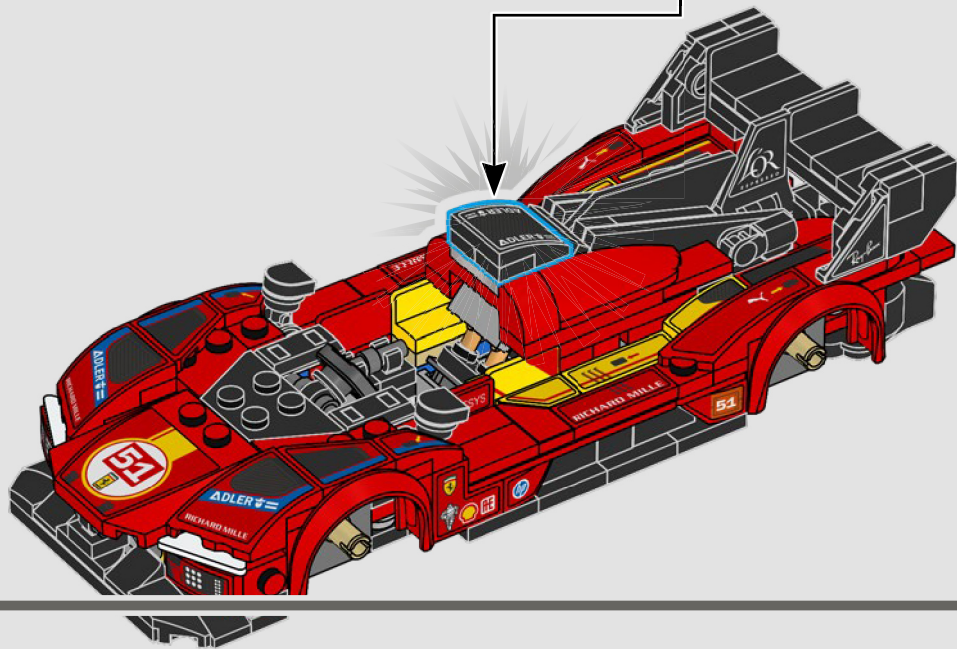
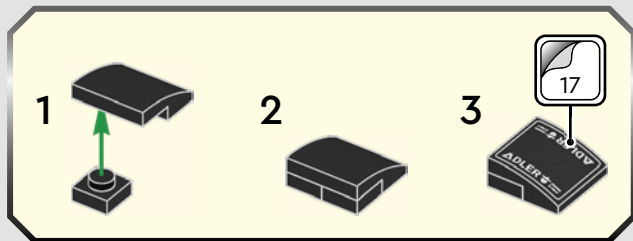



113

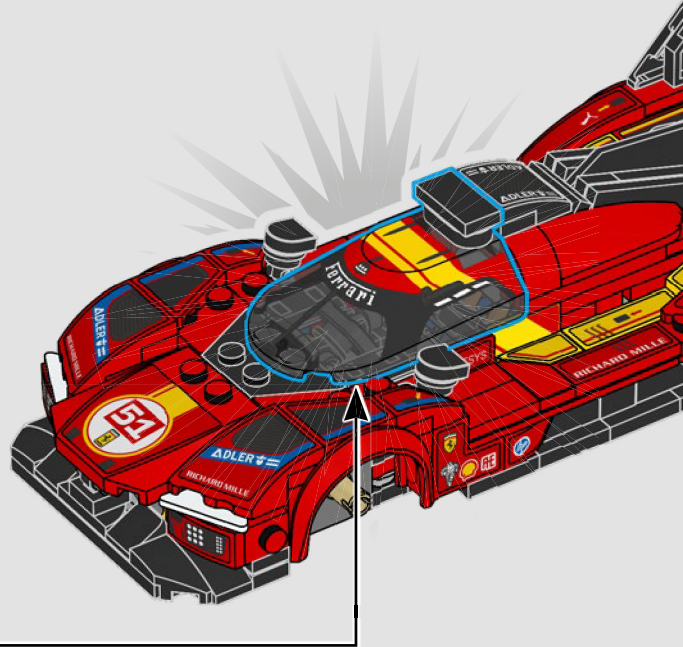
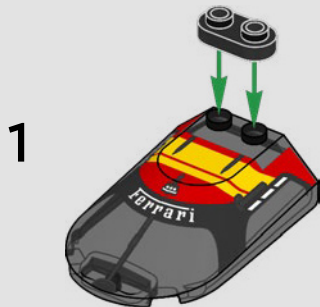



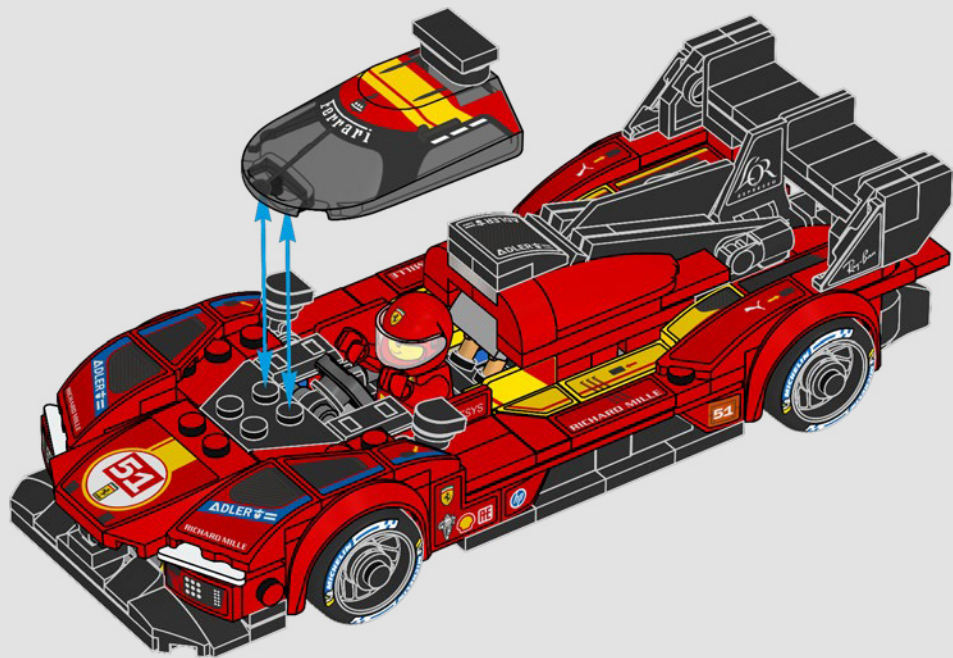

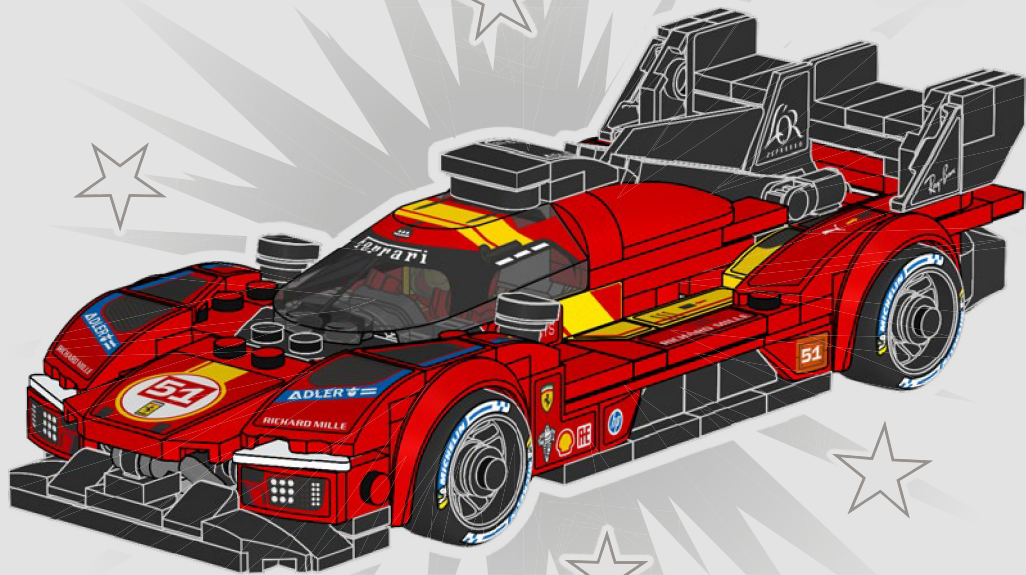



© Universal City Studios LLC. All Rights Reserved.

Designs of Toyota cars and all other associated marks, emblems and designs are intellectual property rights of Toyota Motor Corporation and used with permission.

Produced under license of Ferrari S.p.A. The name FERRARI, the PRANCING HORSE device, all associated logos and distinctive designs, including the design of the Ferrari cars, are property of Ferrari S.p.A.

APXGP is a trademark of Apple.

The F1 logo, FORMULA 1, F1, GRAND PRIX and related marks are trademarks of Formula One Licensing BV, a Formula 1 company. All rights reserved.  
OFFICIAL LICENSEE OF FORMULA 1®

HOONIGAN® and HOONICORN® are registered trademarks of Wheel Pros, LLC © 2026 Wheel Pros, LLC All rights reserved.

The 43, Skull logos, and KEN BLOCK are trademarks of KP8 Trust and are used with permission from KP8 Trust and in partnership with Building the Blocks, LLC.

RTR trademarks and designs used under permission from Vaughn Gittin Jr. Motorsports, LLC.

Ford Motor Company Trademarks and Trade Dress used under license to the LEGO Group.



2x  
6210272



2x  
6317569



1x  
302301



2x  
6347309

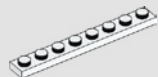

2x  
346001



4x  
6463667



4x  
4666579



2x  
4113233



2x  
4143409



2x  
6284577



1x  
6256543



4x  
6329867



1x  
6510151



1x  
6510138



1x  
6614268



1x  
6614267



2x  
6029947



1x  
4501232



2x  
4558172



2x  
6494496



2x  
4558886



2x  
6170390



6x  
302421



2x  
6372478



4x  
6177507



4x  
6177505



1x  
6510141



1x  
6550889



1x  
6510127



1x  
6141552



1x  
6141553



2x  
6384112



1x  
6602157



6x  
306921



2x  
6146217



6x  
302321



4x  
6029946



2x  
6544439



2x  
6001806



1x  
6602155



6x  
242021



2x  
6078641



2x  
302221



4x  
4533742



1x  
6616755



6527716



1x  
6436412



1x  
6588366



1x  
6527713



4x  
371021



1x  
6614269



4x  
6441691



1x  
4193074



2x  
366621



2x  
6477769



1x  
346021



1x  
6614271



8x  
6482573



4x  
362323



1x  
302023



2x  
6321194



12x  
6168646



4x  
614126



3x  
6534180



4x  
6256435



2x  
6424674



4x  
307026



2x  
4504382



6x  
302426



5x  
6335388



2x  
6380236



2x  
6510139



1x  
6181713



1x  
6181720



1x  
6356861

2x  
6510125

1x  
6510061

1x  
6104209

2x  
6210270

2x  
6196548

2x  
6157554

2x  
6347310

2x  
6156991

5x  
306926

2x  
6640376

2x  
6375706

2x  
6174243

2x  
6146220

2x  
6308912

2x  
6047276

2x  
6000650

1x  
6517779

8x  
6250020

1x  
6363033

2x  
6214807

2x  
6350725

2x  
6593250

4x  
242026

2x  
6166859

1x  
6053077

2x  
4558170

2x  
362326

4x  
6614270

1x  
4531412

2x  
6439175

2x  
6439175

2x  
6439175

4x  
6350415

2x  
366626

2x  
663626

1x  
6093011

1x  
379526

1x  
303226

1x  
4656764

1x  
4656764

1x  
4656764

1x  
4656764

1x  
4656764

1x  
4656764

16x  
6168647

1x  
6507791

2x  
4568637

2x  
6066097

1x  
4211469

1x  
6212077

1x  
6185676

1x  
6257593

2x  
4211438

1x  
4243797

1x  
4243797

1x  
4243797

2x  
6454959

2x  
4211090

2x  
6333129

4x  
6350724

1x  
6115080

2x  
4211135

1x  
6176400

1x  
4261908

1x  
4210660

1x  
4210660

1x  
4210660

1x  
6614264

1x  
6472255

1x  
6132264

1x  
6167576

1x  
6244787

1x  
6244787

1x  
6244787

1x  
6244787

1x  
6244787

1x  
6244787

1x  
6244787

1x  
6244787

2x  
6035540

2x  
302328

1x  
6510211

2x  
6335111

2x  
6207933

2x  
6207933

2x  
6207933

2x  
6207933

2x  
6207933

2x  
6207933

2x  
6207933

2x  
6207933



 [LEGO.com/service](https://www.LEGO.com/service)

YOU COULD  
**WIN**



Scan this QR code or go to  
**LEGO.COM/PRODUCTFEEDBACK** and give us  
your short feedback about this LEGO® set  
for a chance to win a cool LEGO prize.

Terms and Conditions apply\*



**EN: YOU COULD WIN.** Terms and Conditions apply\* **DE: Du könntest GEWINNEN.** Es gelten die Teilnahmebedingungen\* **FR: TU POURRAIS GAGNER.** Des conditions s'appliquent\* **IT: Potresti VINCERE tu.** Termini e condizioni sono applicabili\* **ES: PUEDES GANAR.** Aplican términos y condiciones\* **PT: PODERÁ GANHAR.** Aplicam-se Termos e Condições\* **ZH: 轻松获奖.** 条款和条件适用\* **PL: Szansa na WYGRANĄ.** Obowiązuje regulamin\* **CS: Máte šanci VYHRÁT.** Platí všeobecné smluvní podmínky\* **SK: Máte šancu VYHRAŤ.** Platia všeobecné zmluvné podmienky\* **HU: TE IS NYERHETSZ!** Felhasználási feltételek érvényesek\* **UA: ВИ МОЖЕТЕ ВИГРАТИ.** Застосовуються загальні положення та умови\* **RO: Ai putea CÂȘTIGA.** Se aplică termenii și condiții\* **BG: Можете да СПЕЧЕЛИТЕ.** Има определени правила и условия\* **LV: Tu vari LAIMĒT.** Ir spēkā noteikumi un nosacījumi.\* **ET: Sul on võimalus VÕITA.** Kehtivad tingimused\* **LT: Jūs galite LAIMĖTI.** Taikomos sąlygos\* **TR: KAZANABİLİRSİN.** Şartlar ve Koşullar geçerlidir\*

\*[LEGO.com/productfeedback-terms](https://www.lego.com/productfeedback-terms)

Produced under license of Ferrari S.p.A. The name FERRARI, the PRANCING HORSE device, all associated logos and distinctive designs, including the design of the Ferrari cars, are property of Ferrari S.p.A.