



43302

Disney





## EMPORIUM

Grand in appearance and full of welcoming details, the iconic Emporium is a classic Main Street landmark. Using a clever forced perspective, it feels larger than life – the first floor is full scale, the second floor just 5/8 scale. It's a trove of Disney treasures waiting to be discovered.

## EMPORIUM

Imposant et rempli de détails chaleureux, l'emblématique Emporium est un incontournable de Main Street. Grâce à un ingénieux effet de perspective forcée, il semble plus grand que nature – le rez-de-chaussée est à l'échelle réelle, tandis que l'étage supérieur est à seulement 5/8 de l'échelle. C'est un véritable coffre aux trésors Disney qui ne demande qu'à être exploré.

## EMPORIUM

Con su aspecto grandioso y llena de detalles acogedores, la icónica tienda Emporium es una parada obligatoria en Main Street, U.S.A. Una ingeniosa perspectiva forzada la hace parecer más grande de lo que en realidad es. Mientras que el primer piso se presenta a escala completa, el segundo piso se recrea a solo 5/8 de esta proporción. Tiene un montón de tesoros Disney esperando a que los descubras.





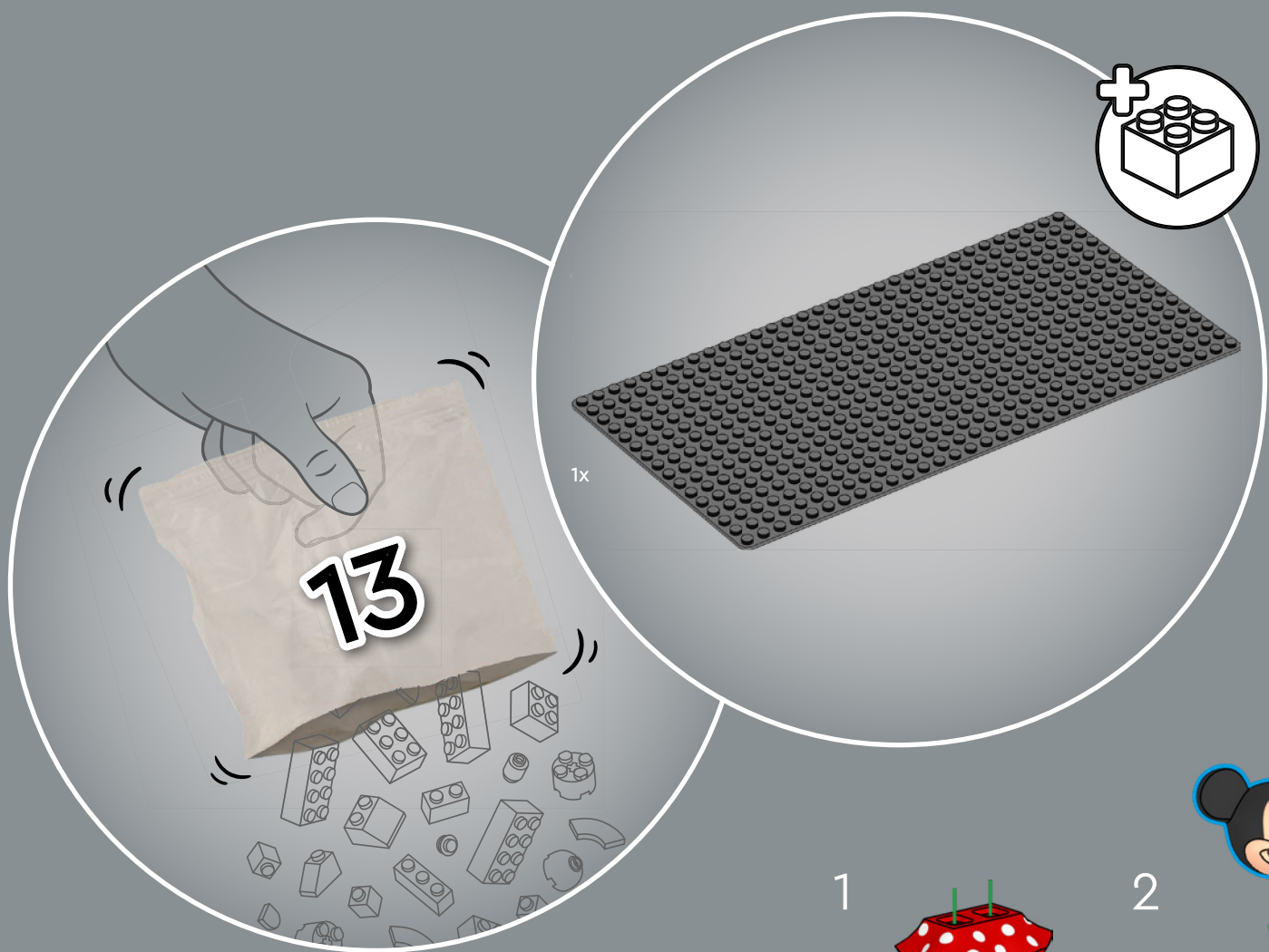

1

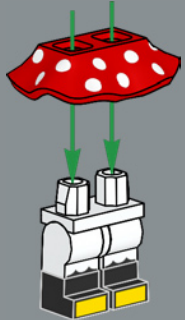

2

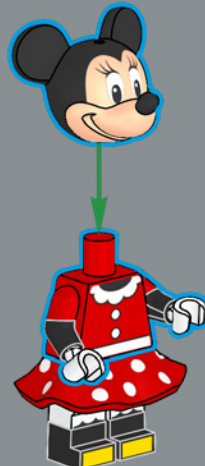

3



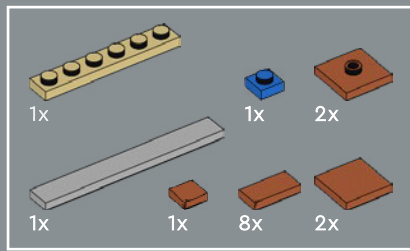

1

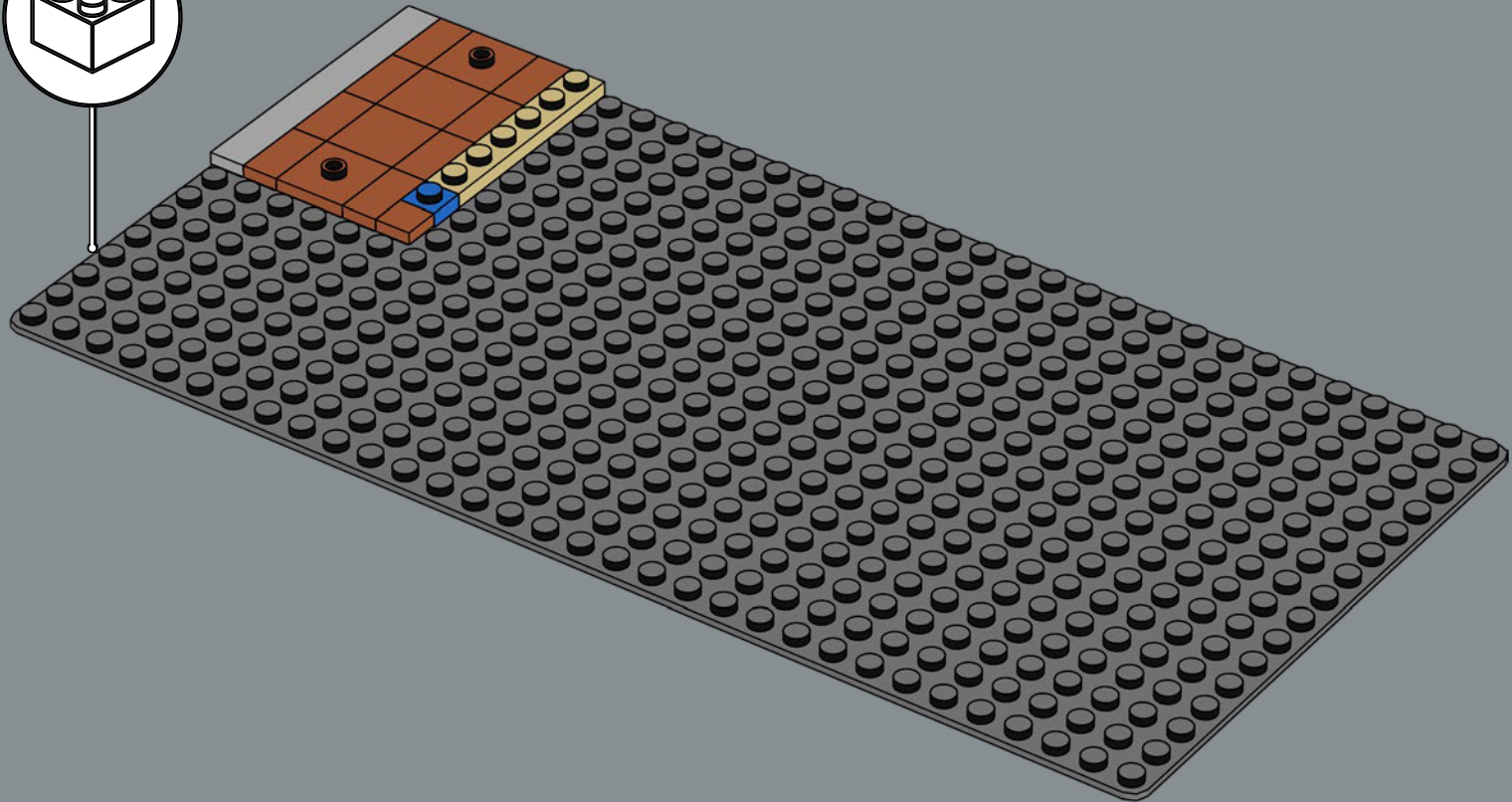
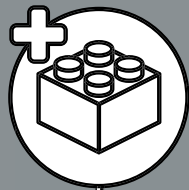

When designing Main Street, U.S.A., Walt Disney drew inspiration from the turn-of-the-century charm he loved in his hometown of Marceline, Missouri.

Pour concevoir Disney Main Street, Walt Disney s'est inspiré du charme du début du siècle qu'il aimait tant dans sa ville natale de Marceline, au Missouri.

Durante el diseño de Main Street, U.S.A., Walt Disney se inspiró en el encanto de principios de siglo que tanto le gustaba de su ciudad natal: Marceline, Misuri (EE. UU.).

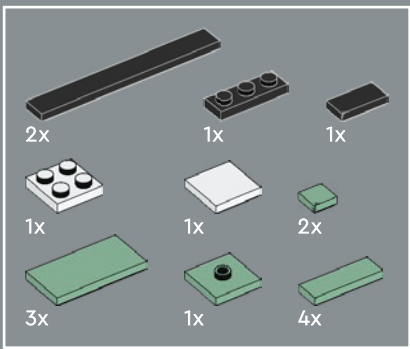

2

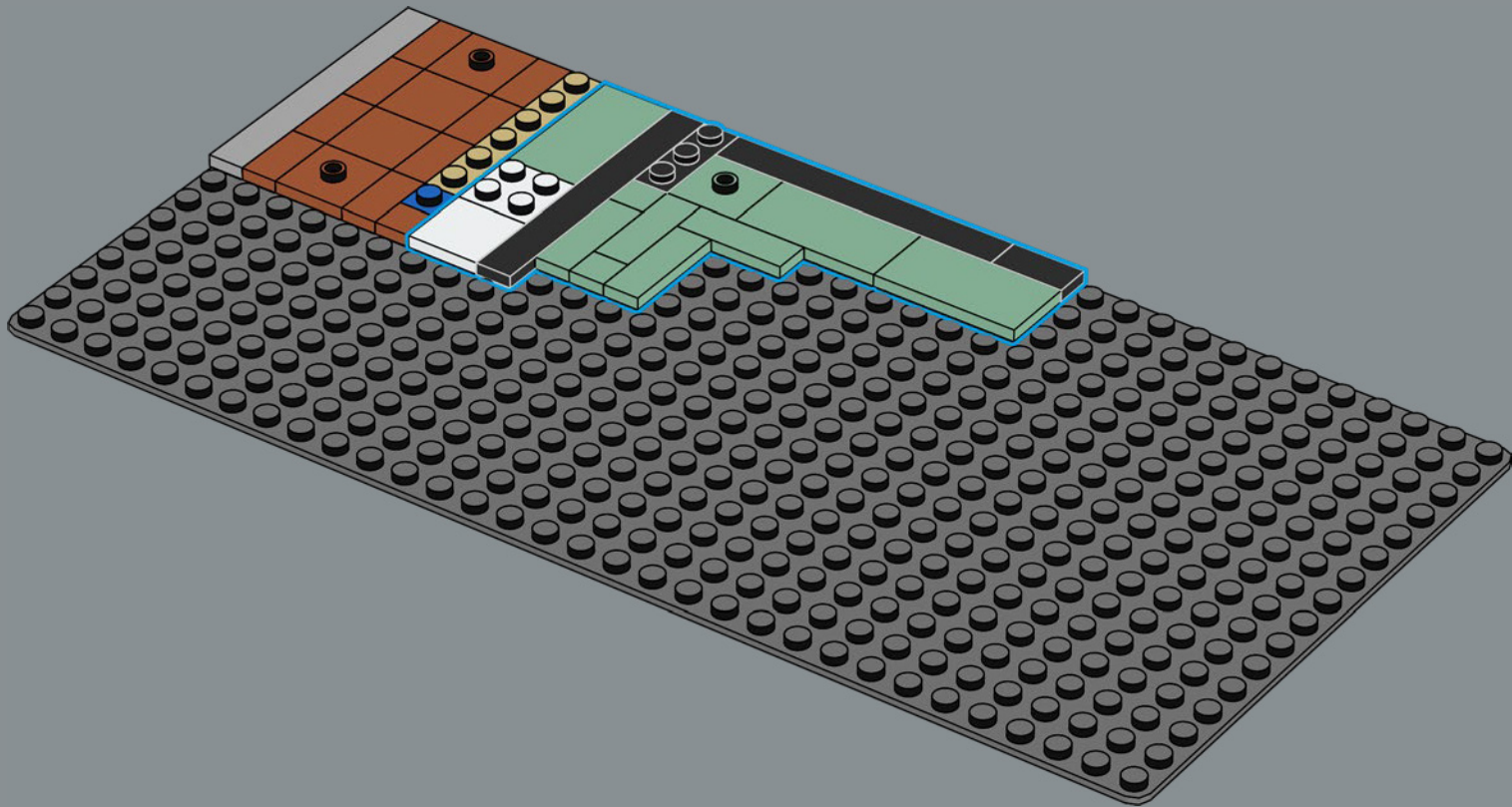

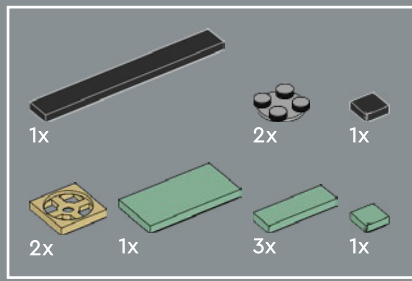

3

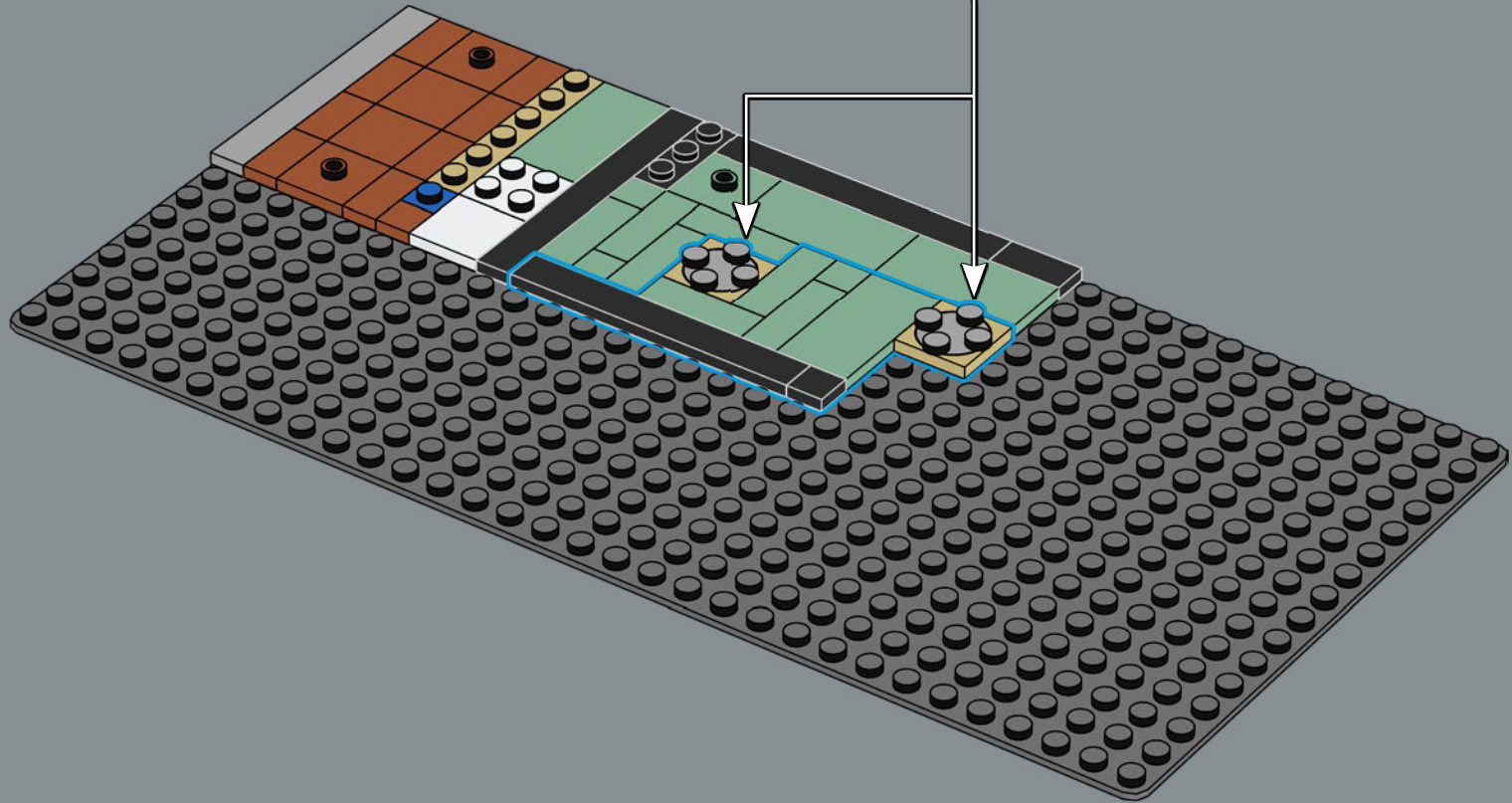
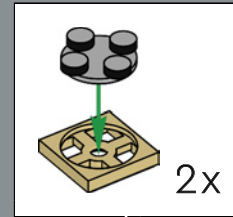

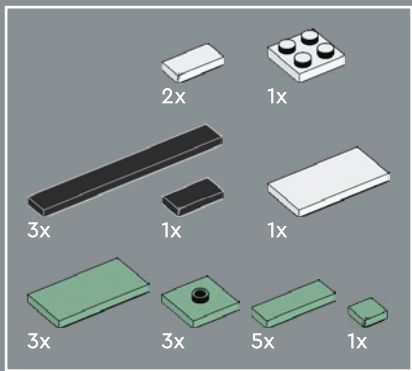

4

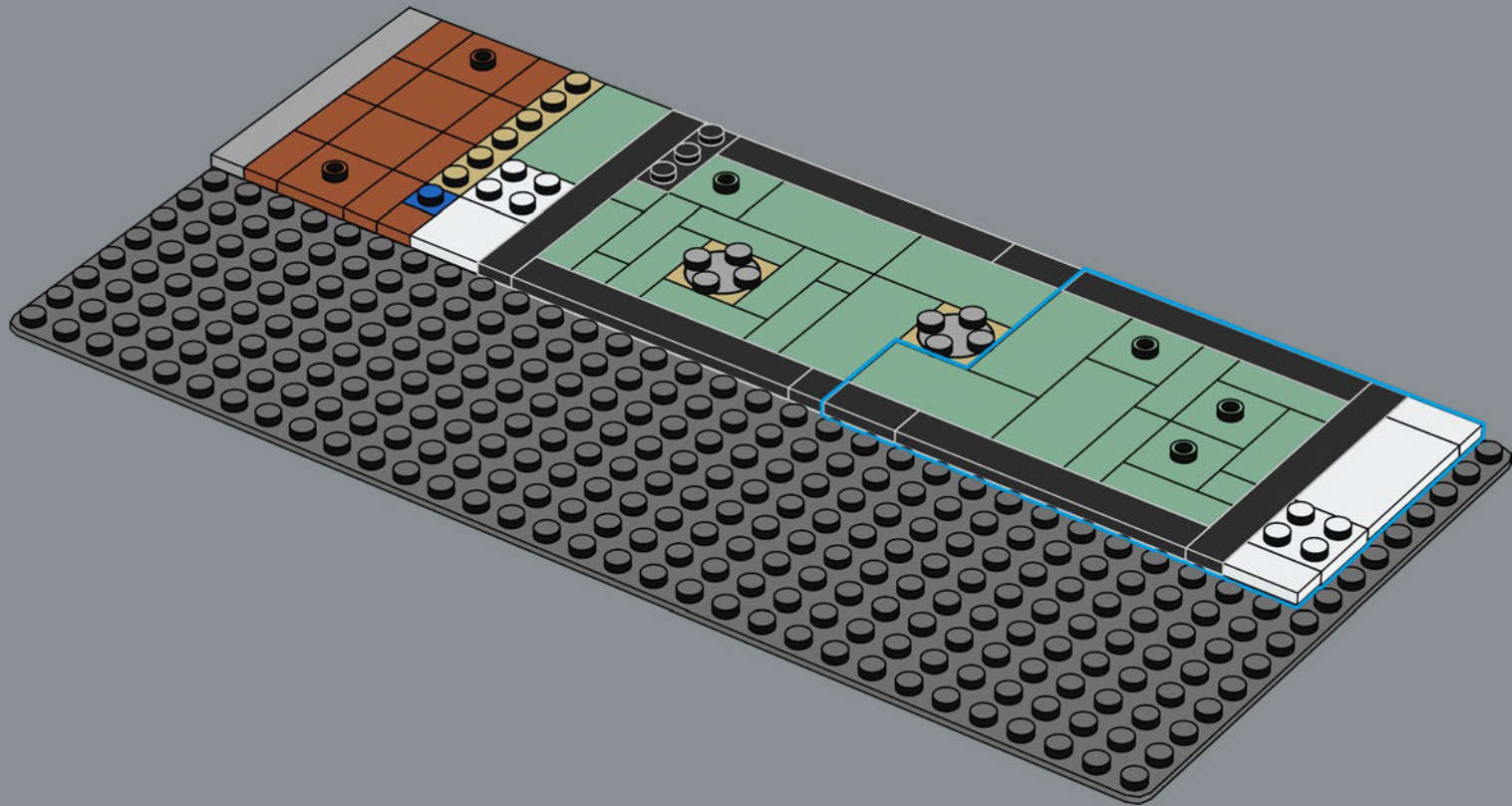

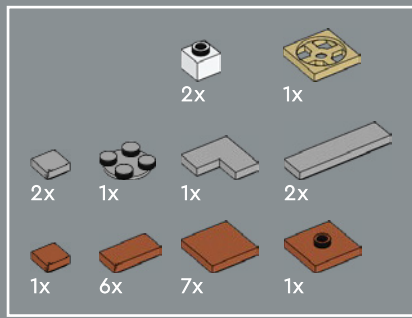

5

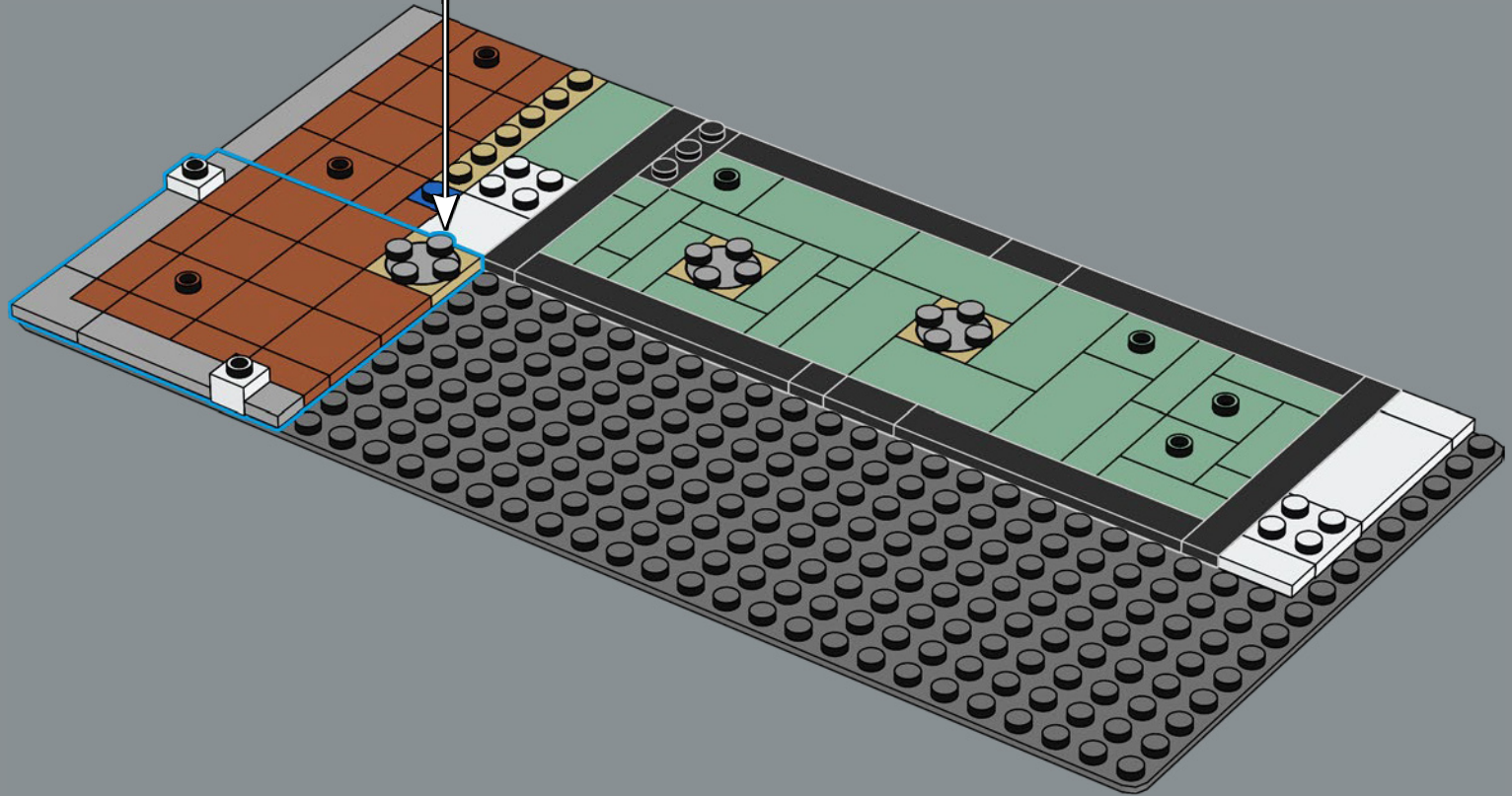
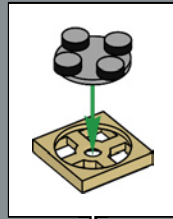

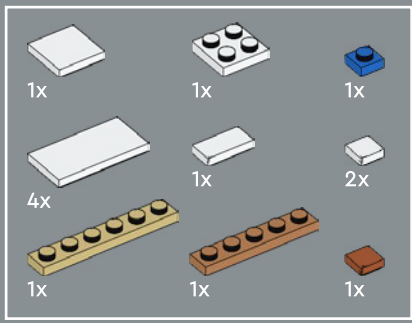

6

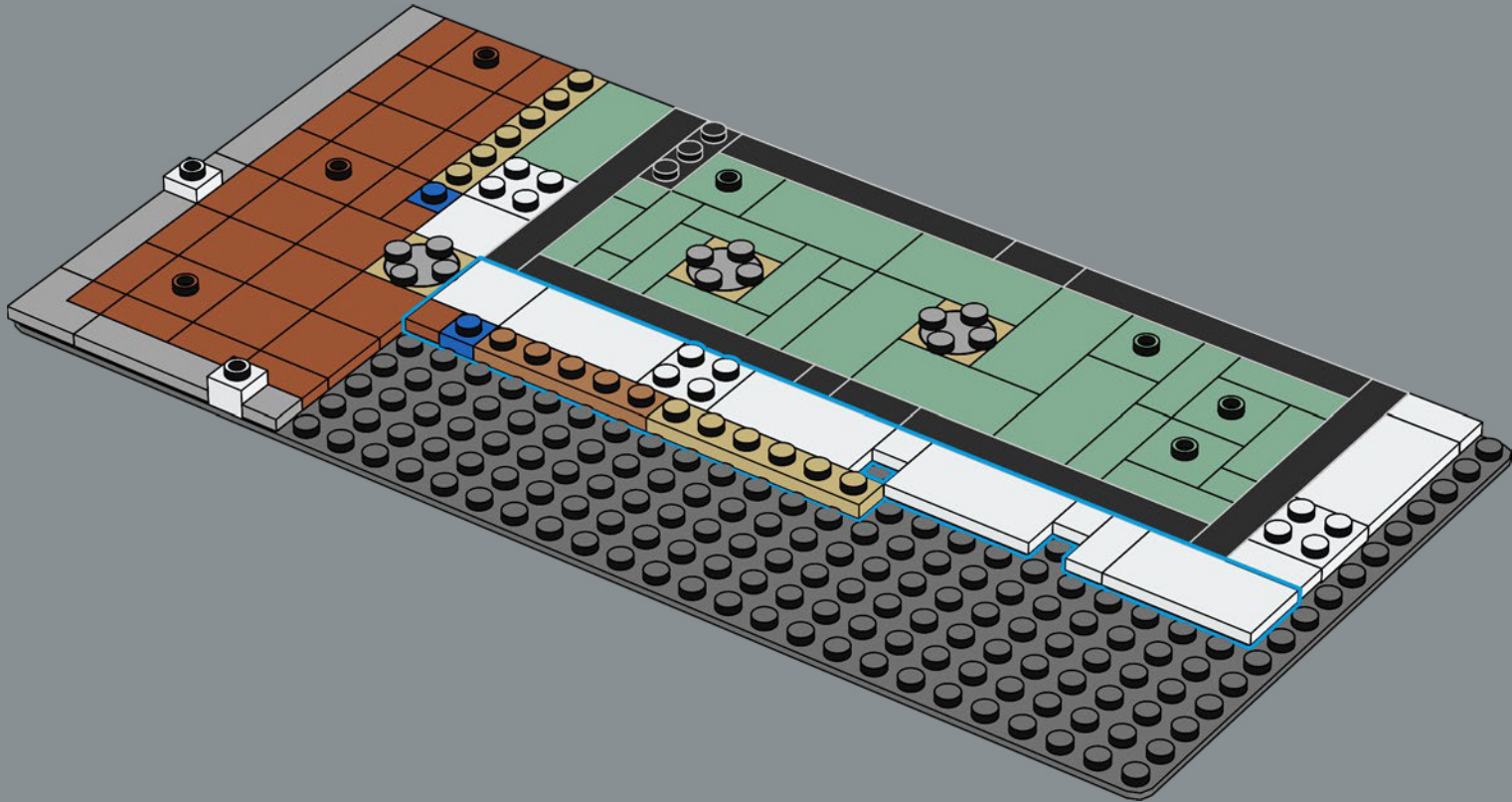

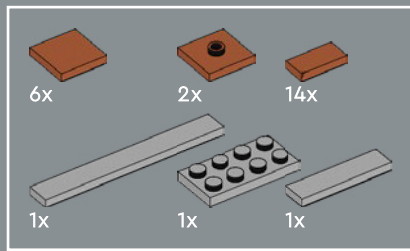

7

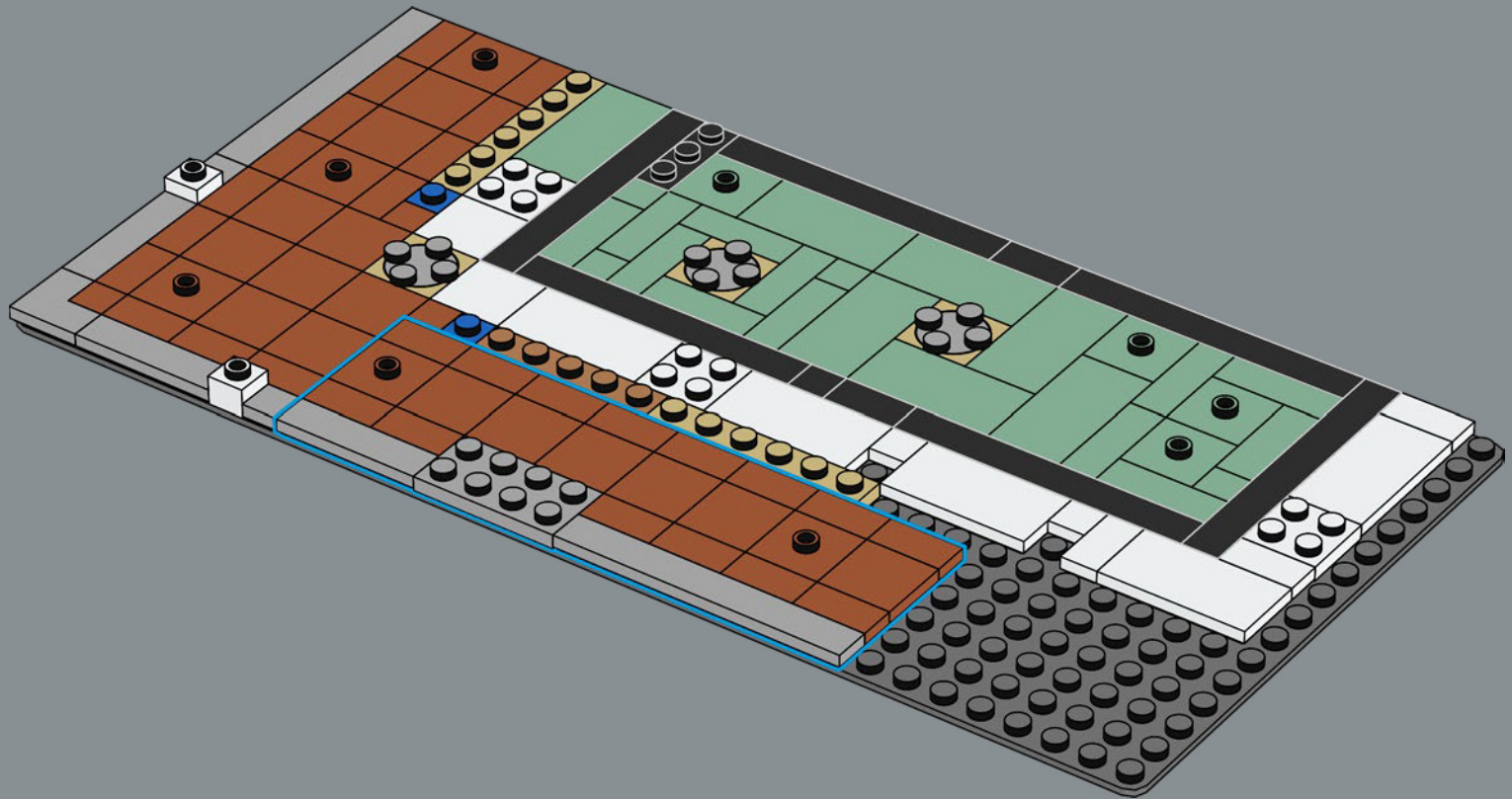

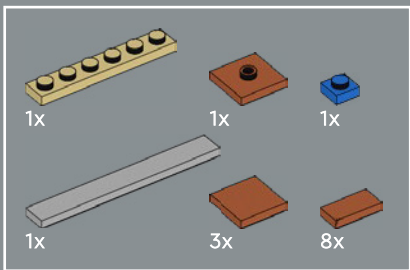

8

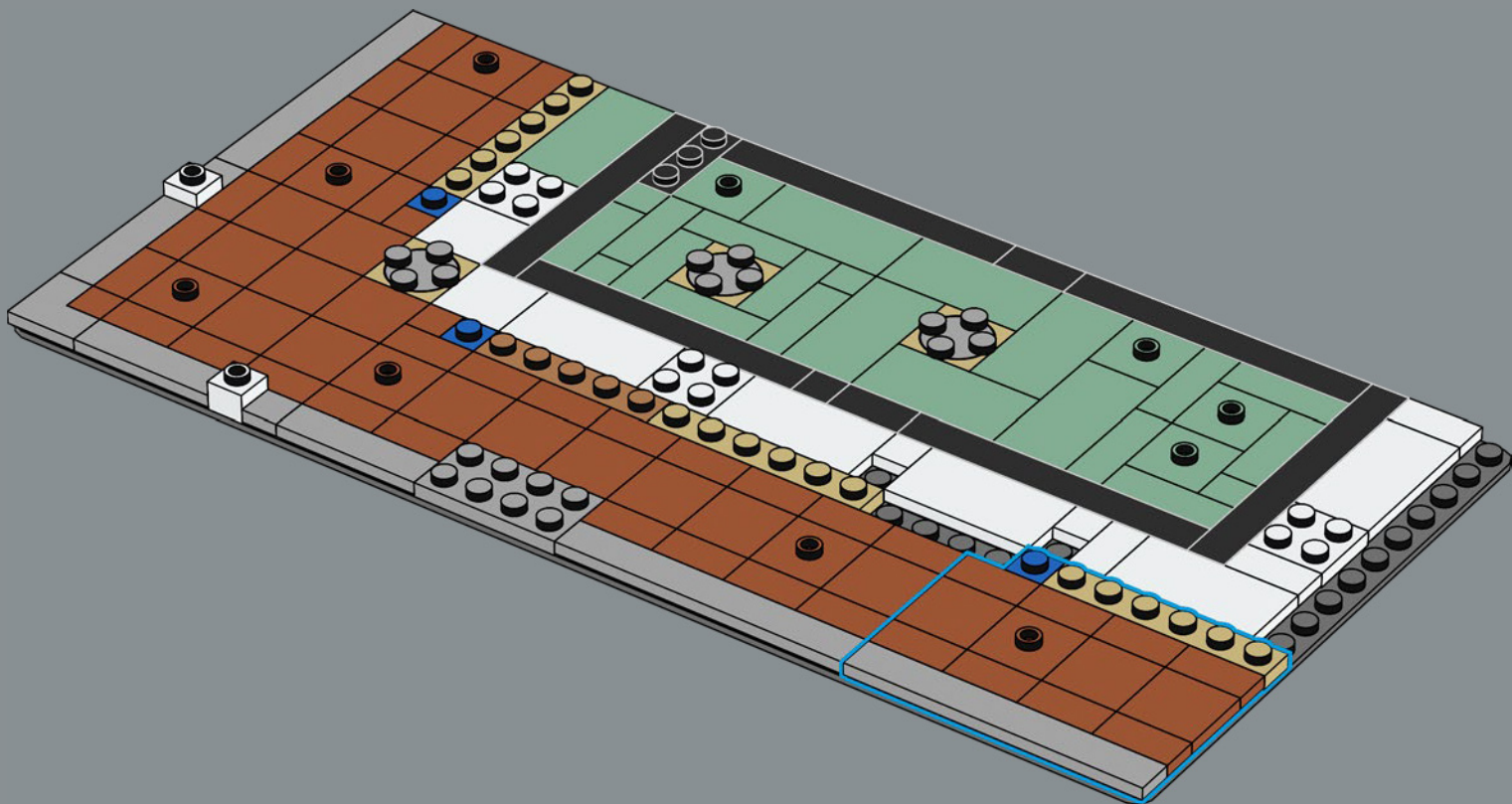

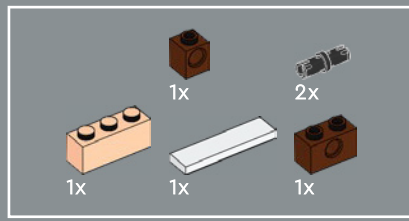

9

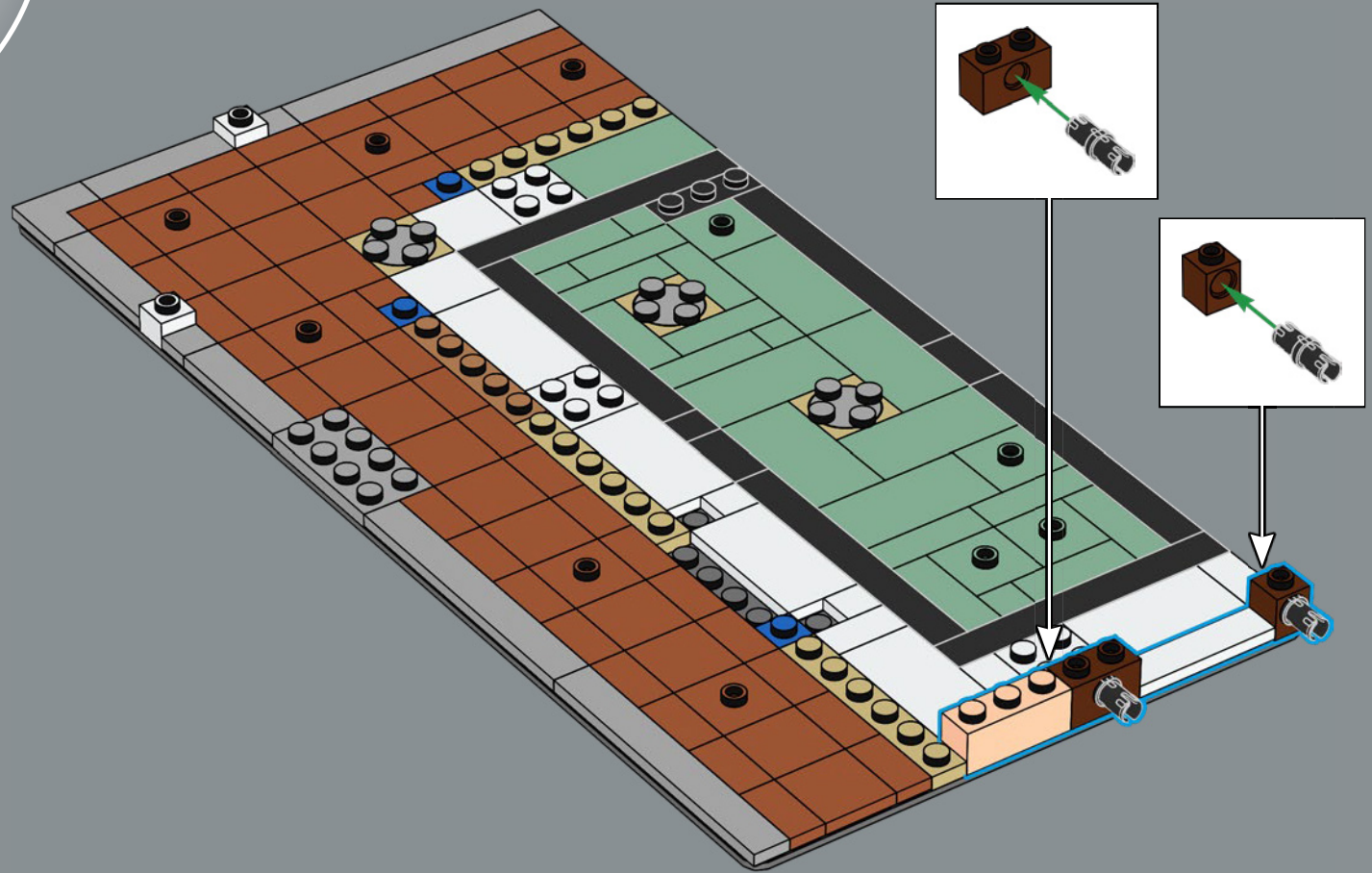

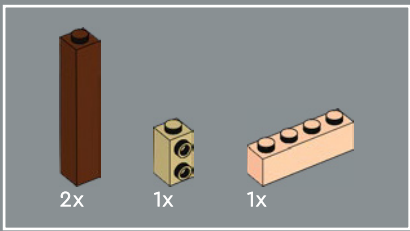

10

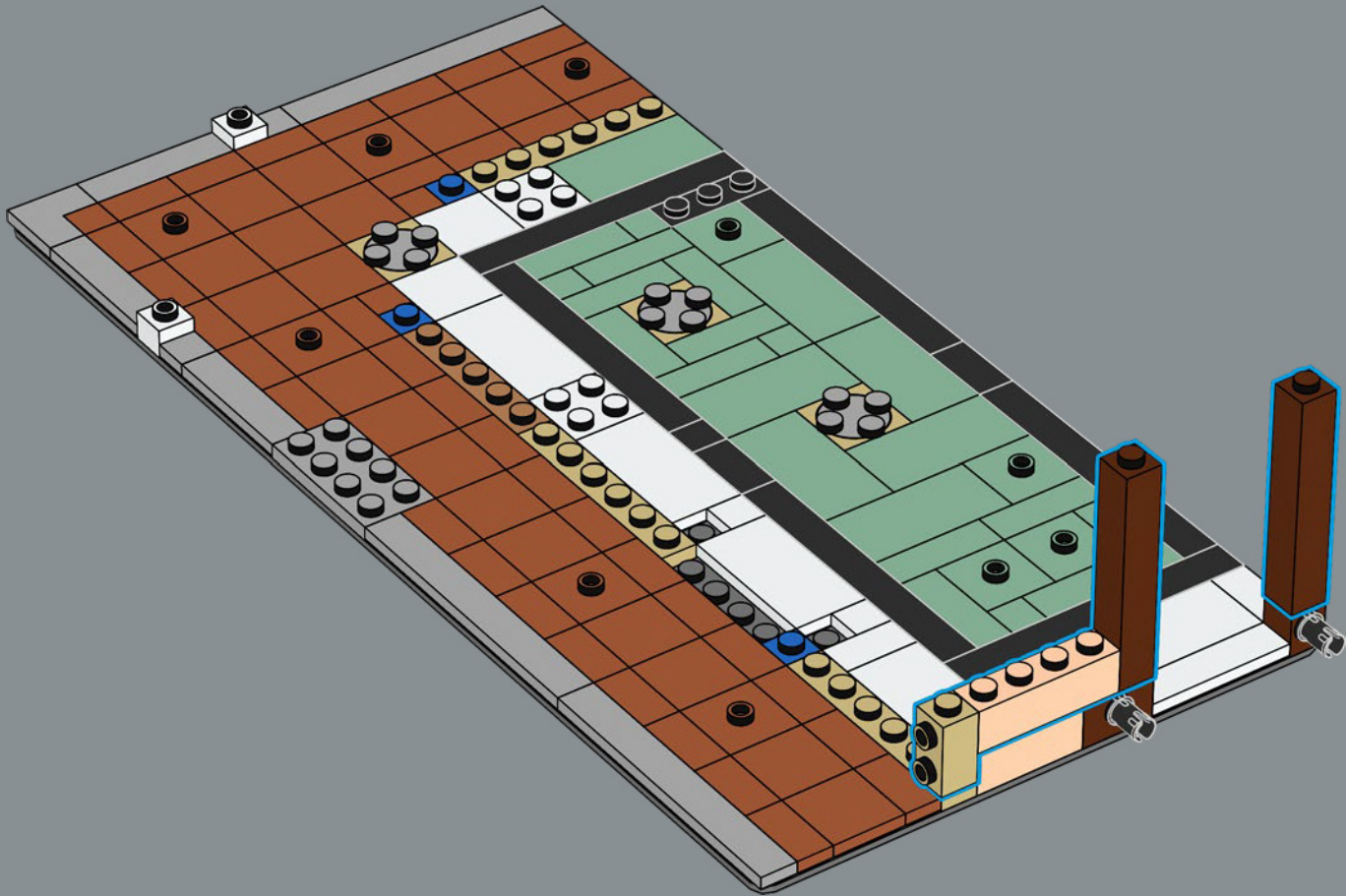



11

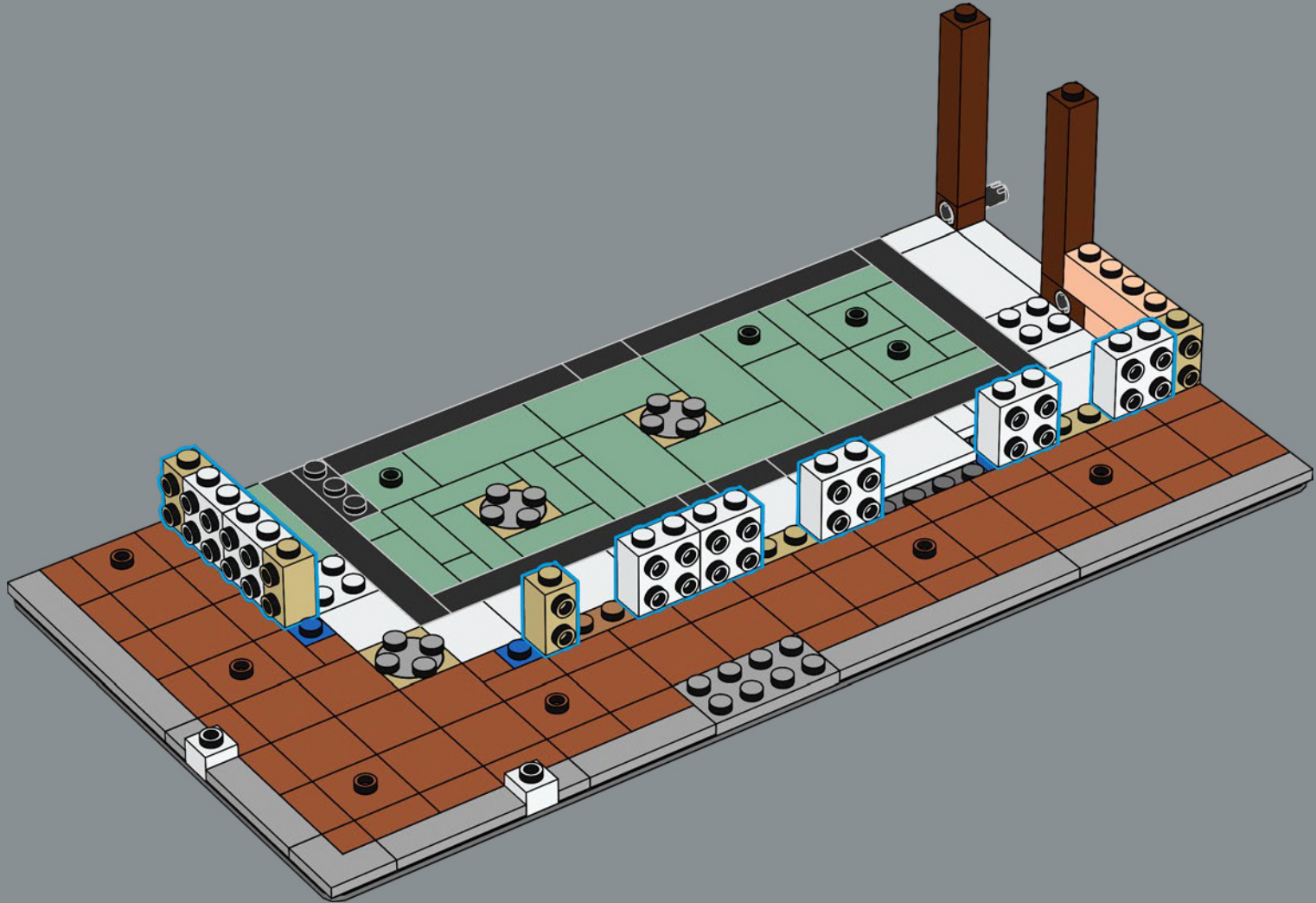

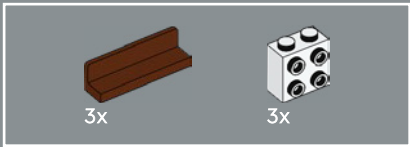

12

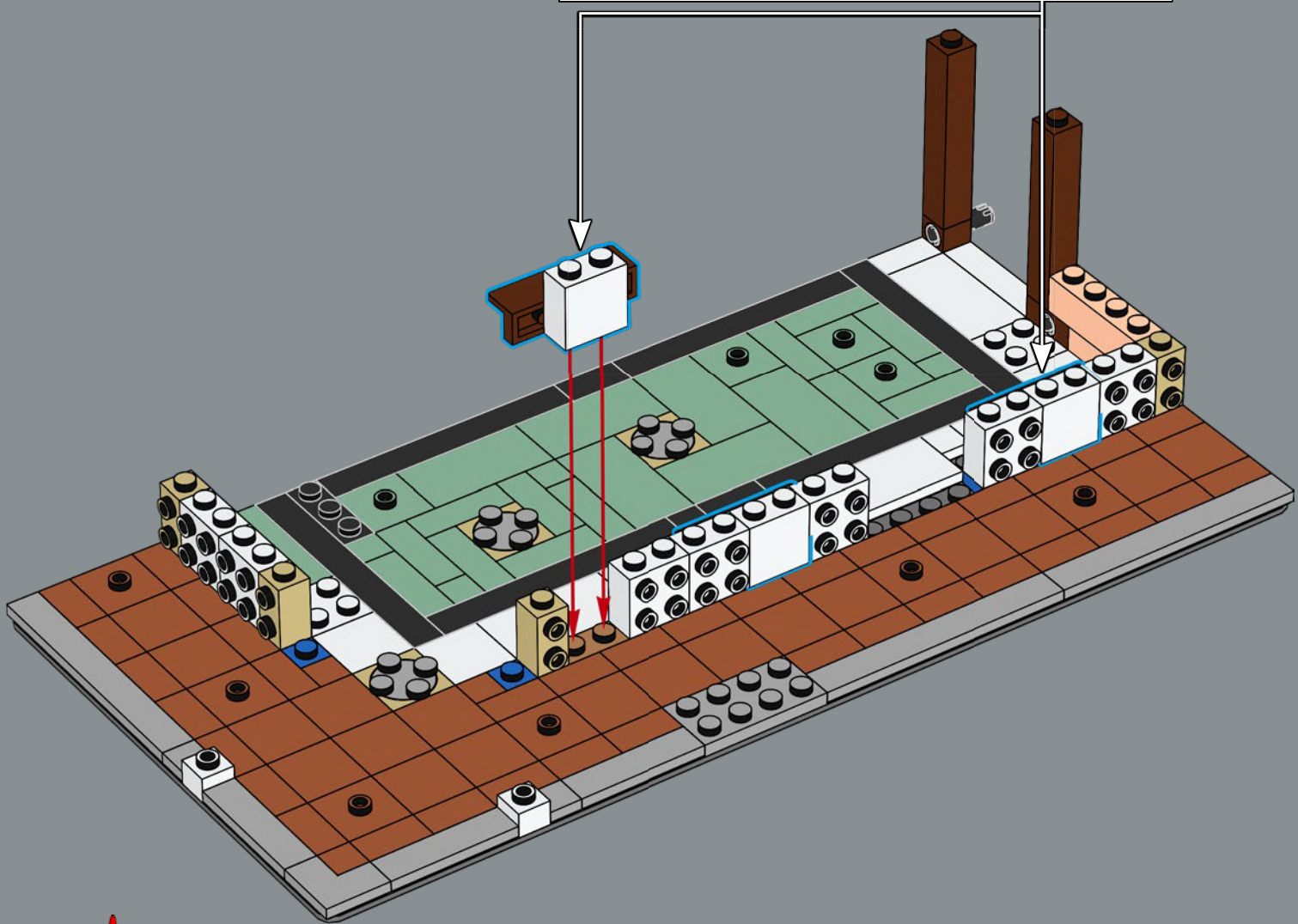
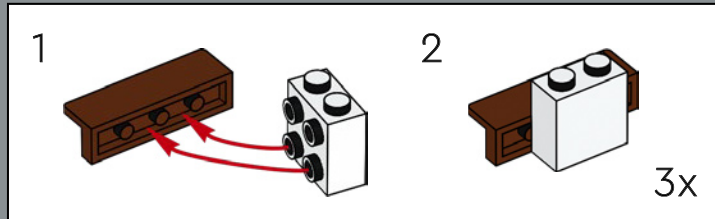

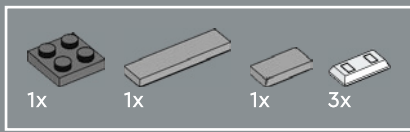

13

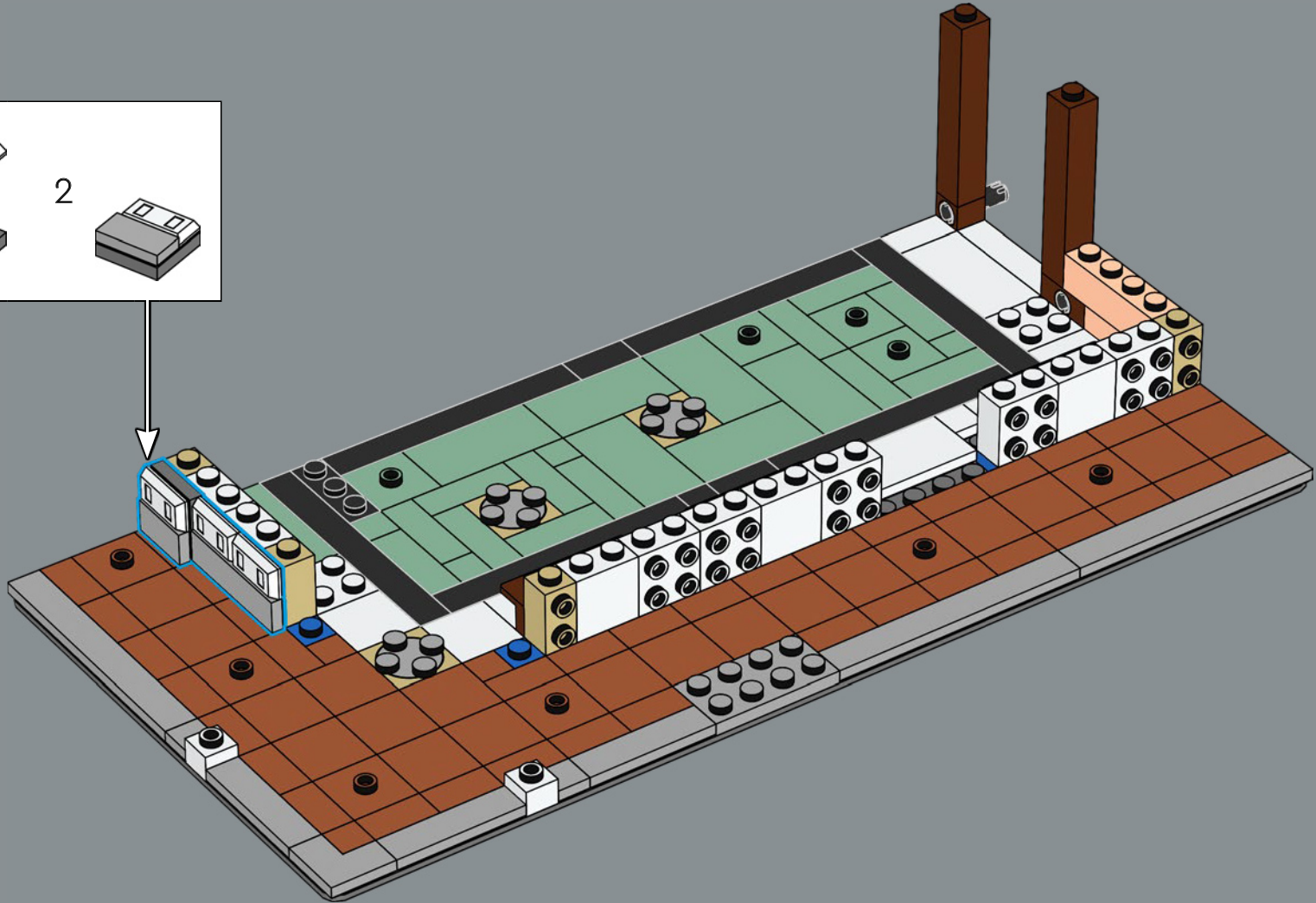
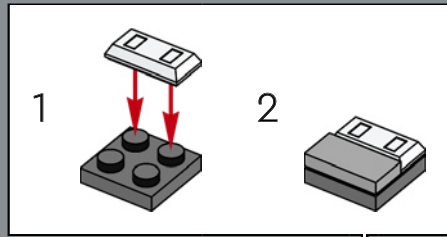

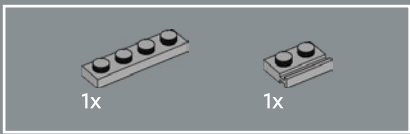

14

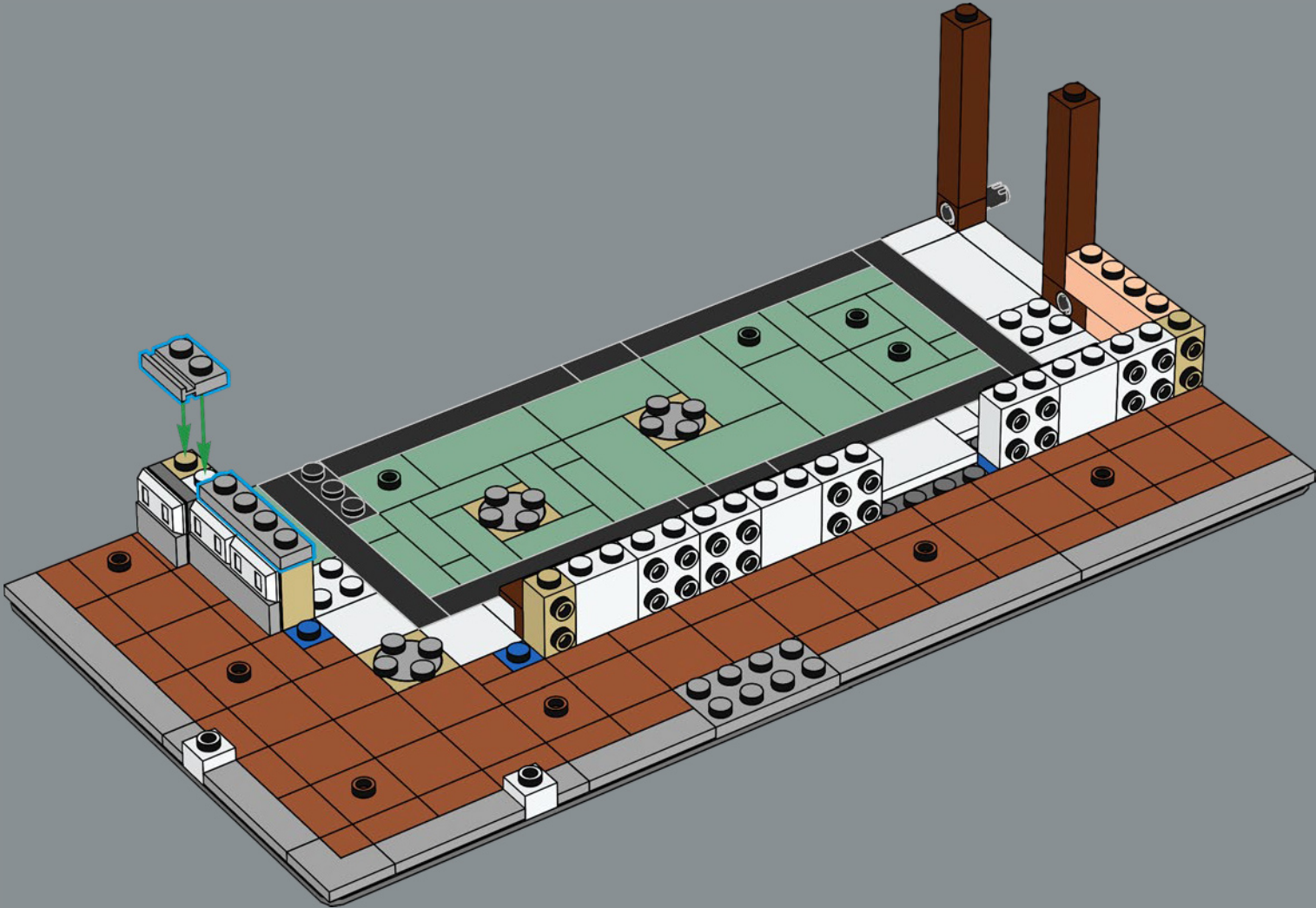

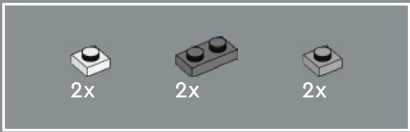

15

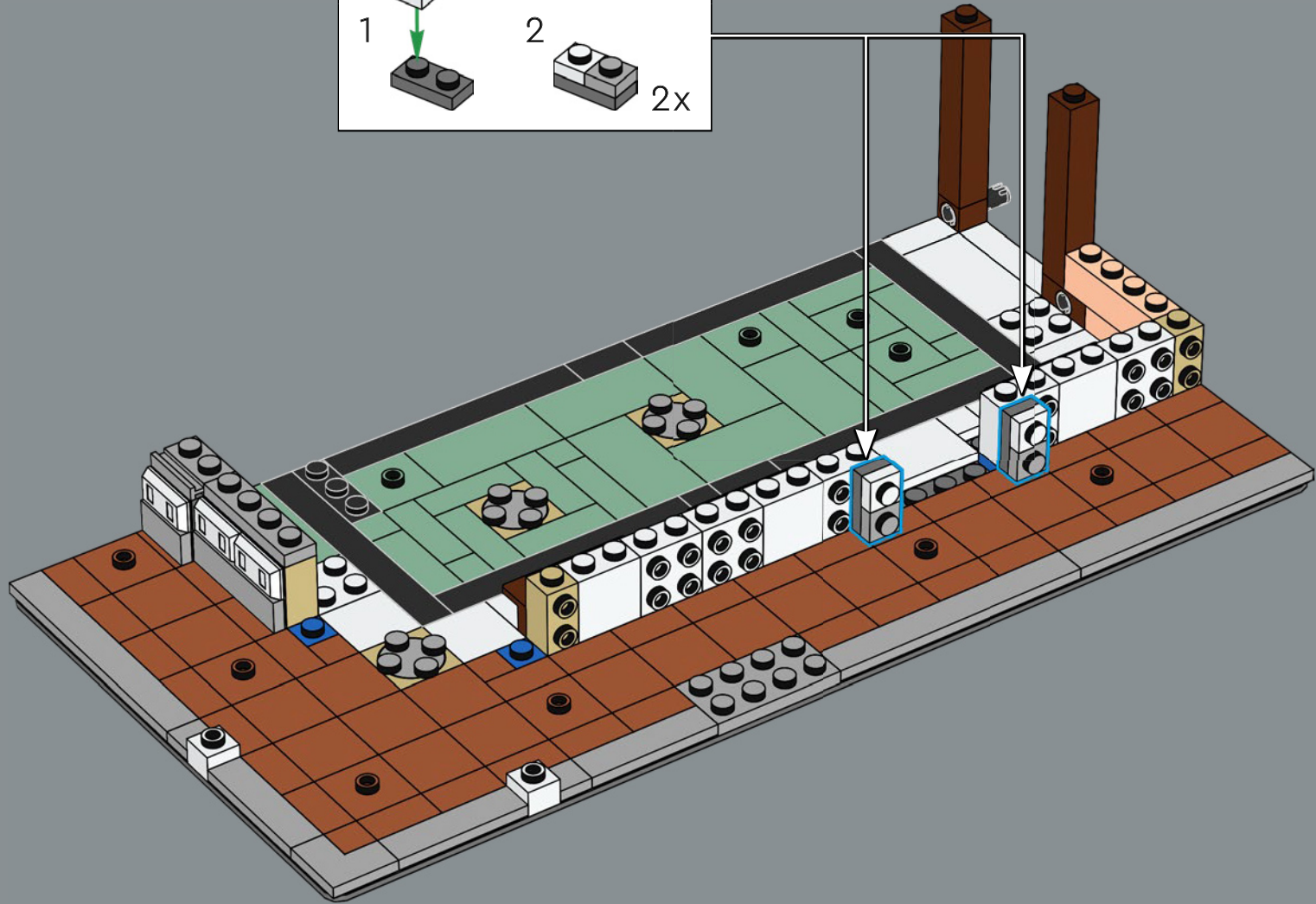
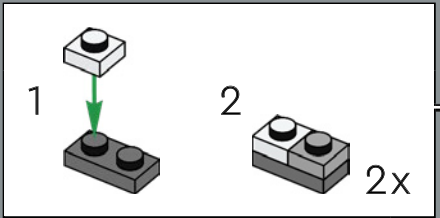

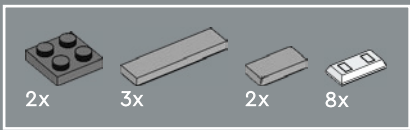

16

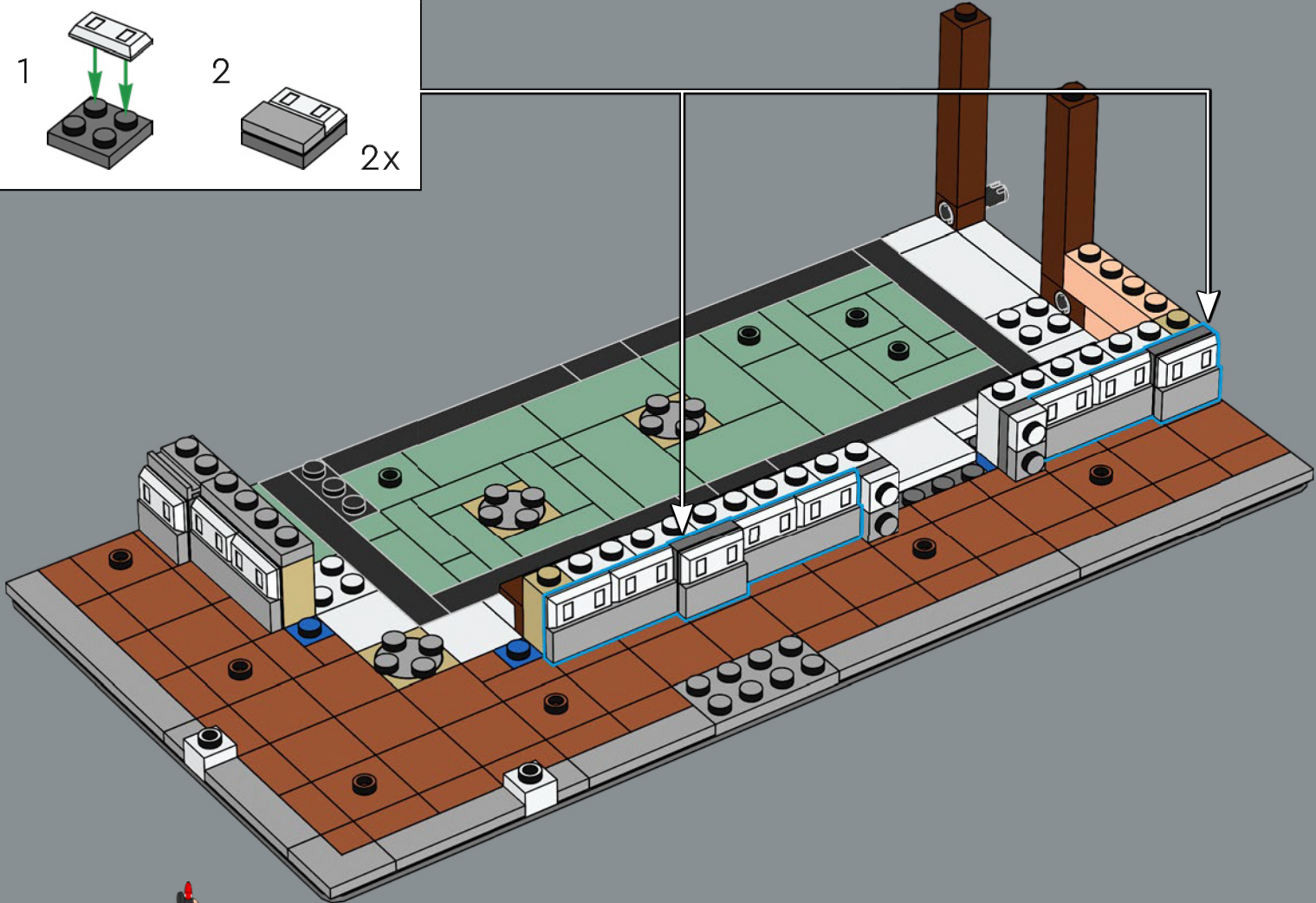
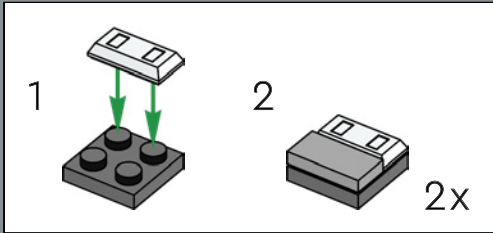

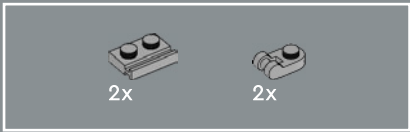

17

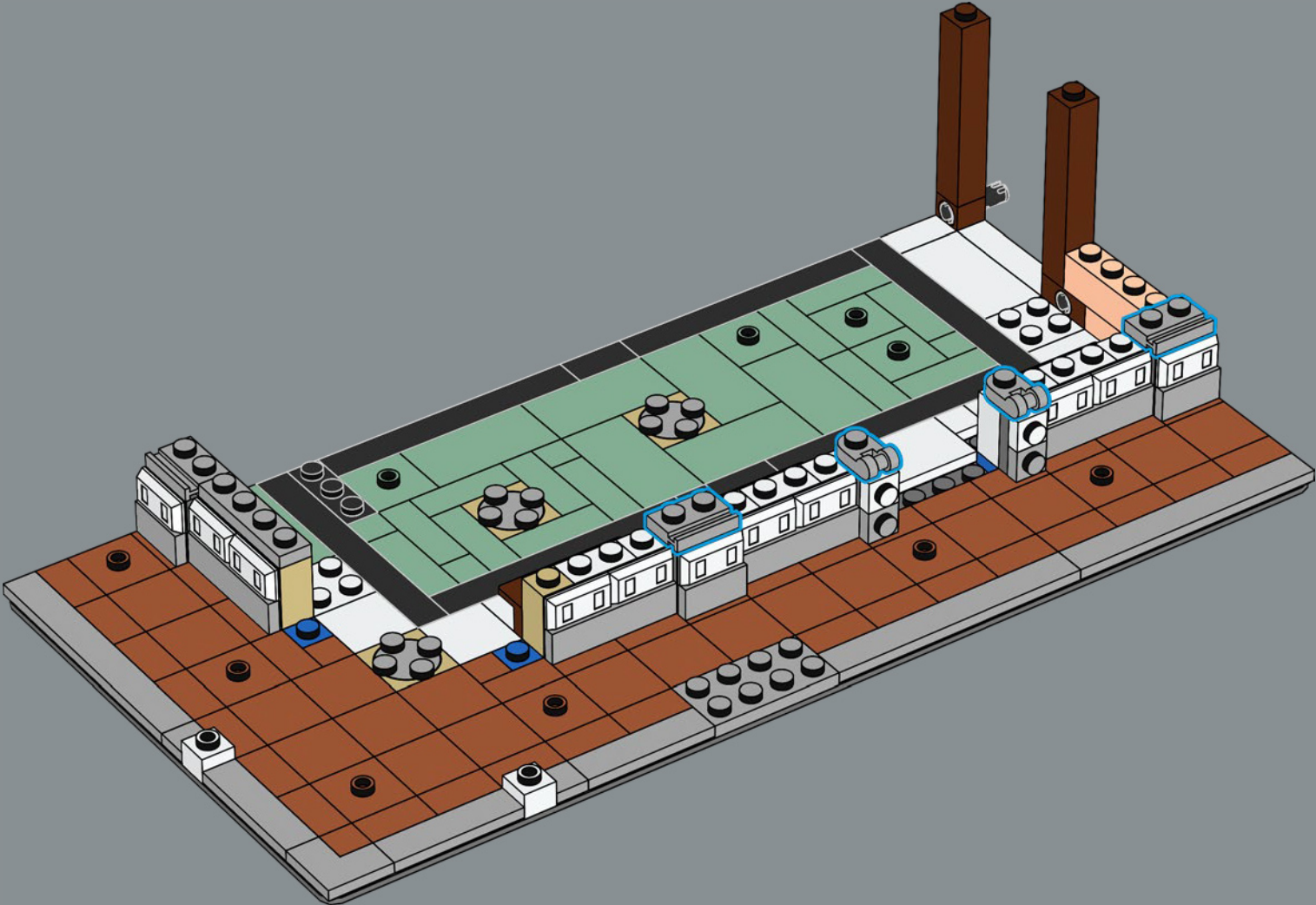

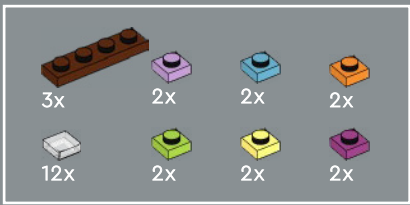

18

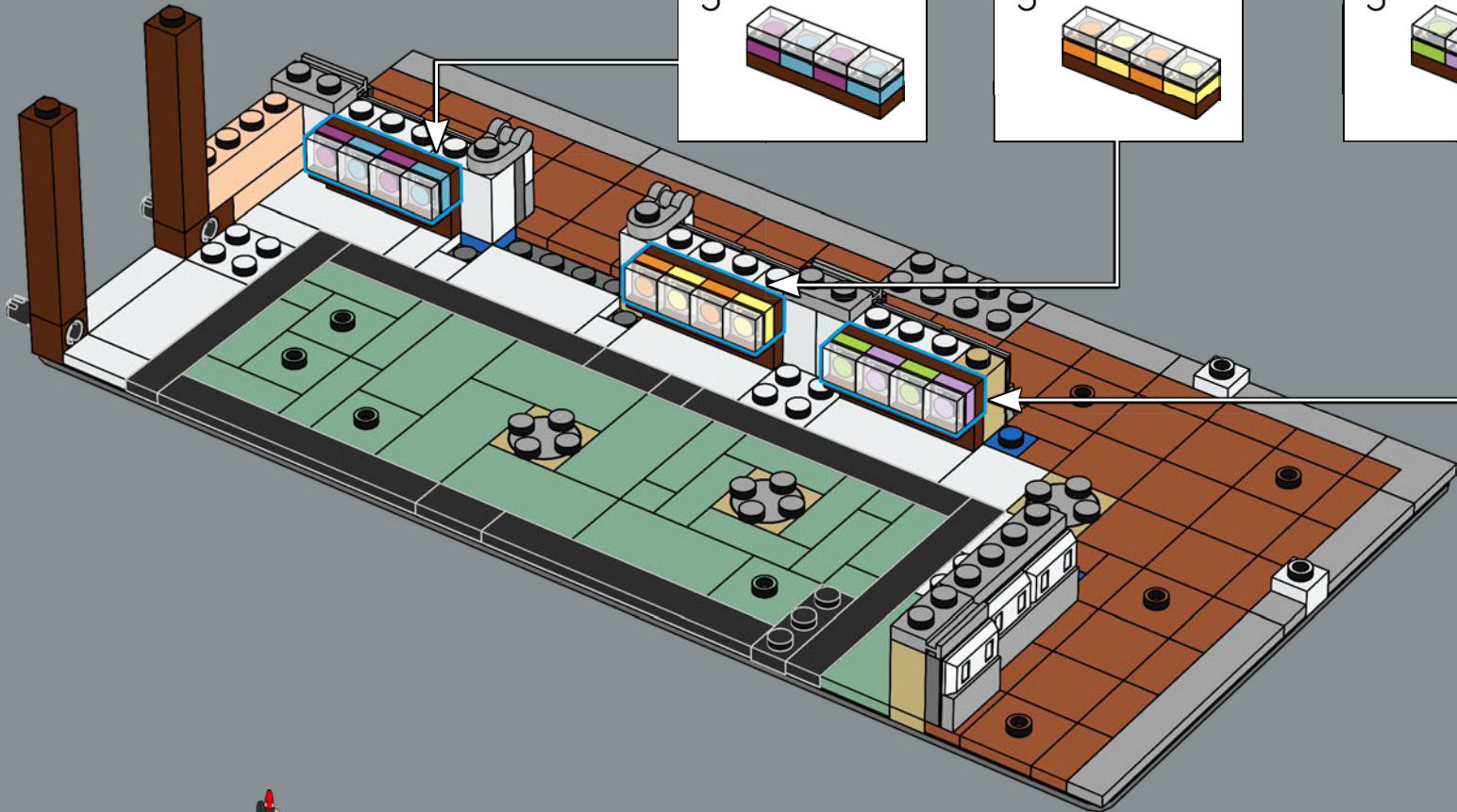
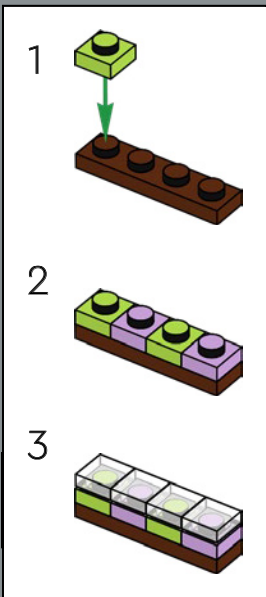
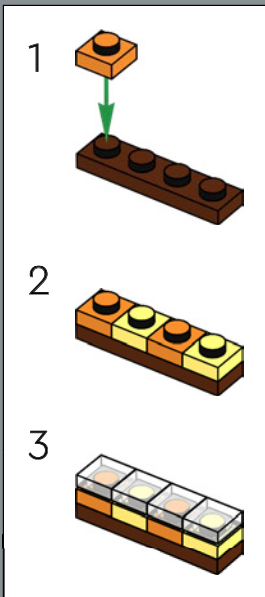

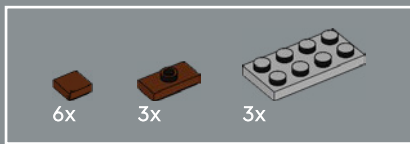

19

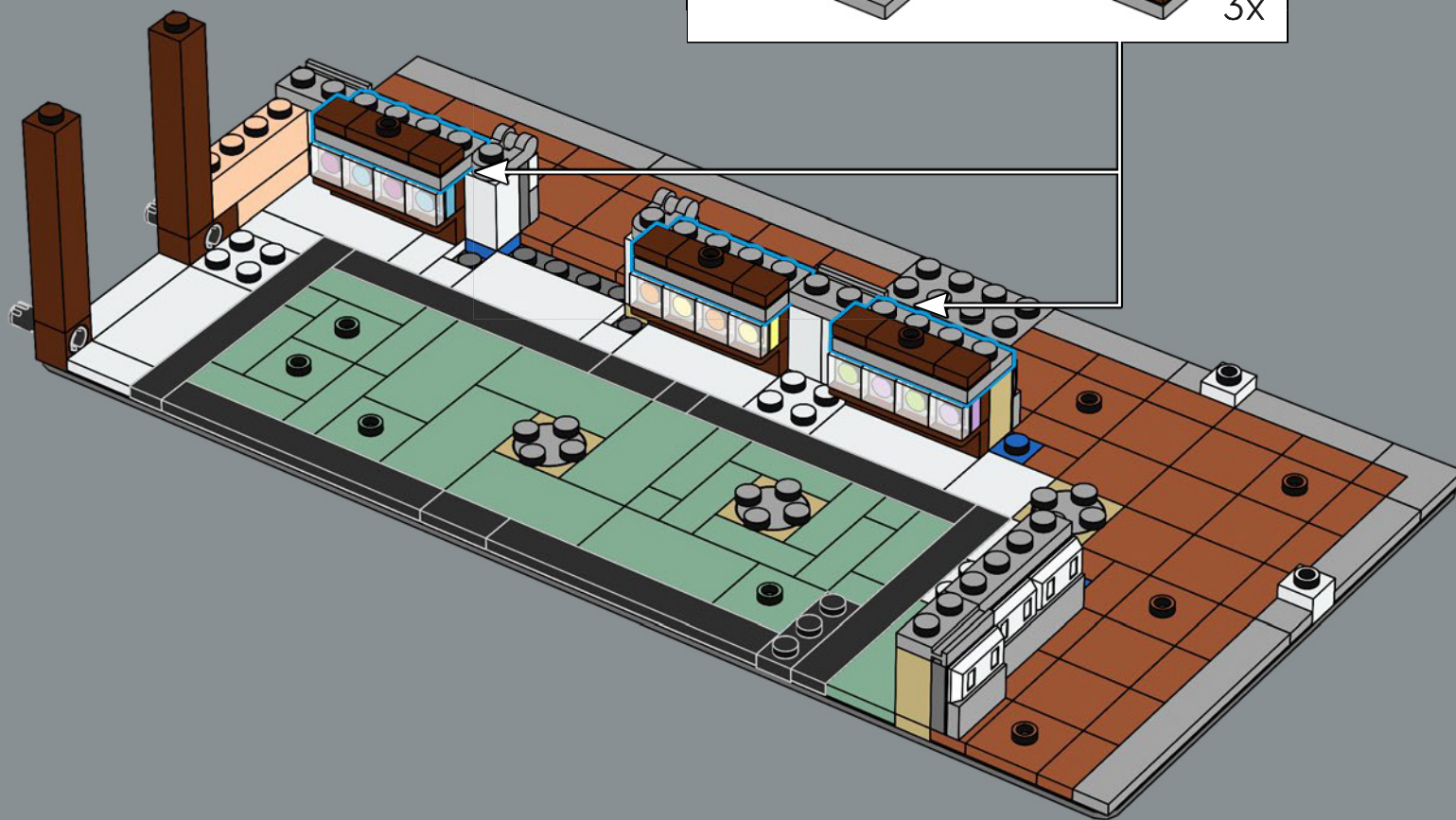
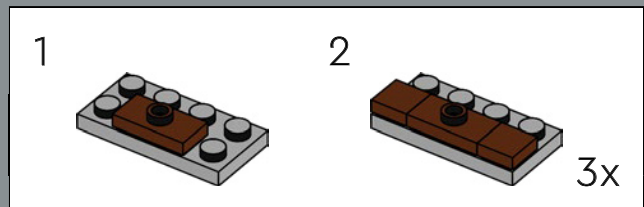

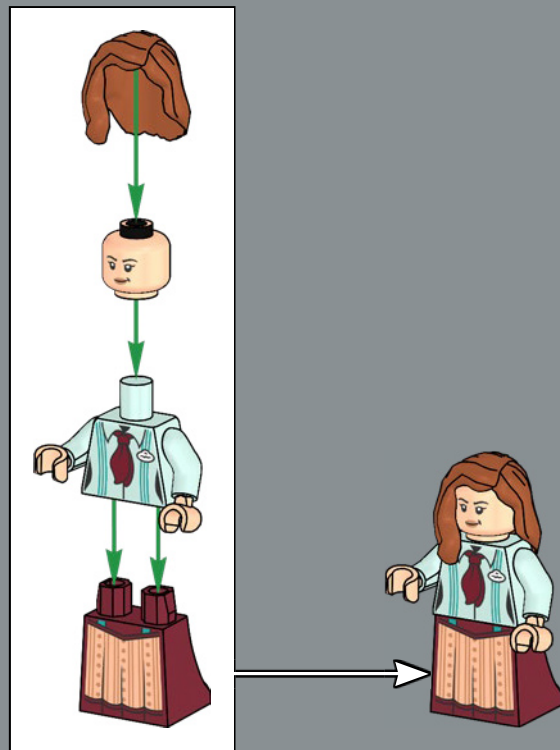

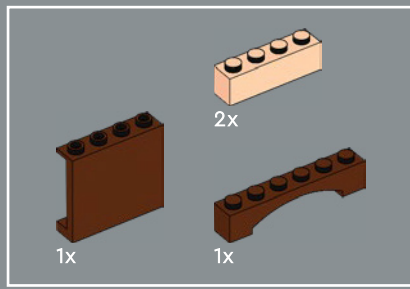

20

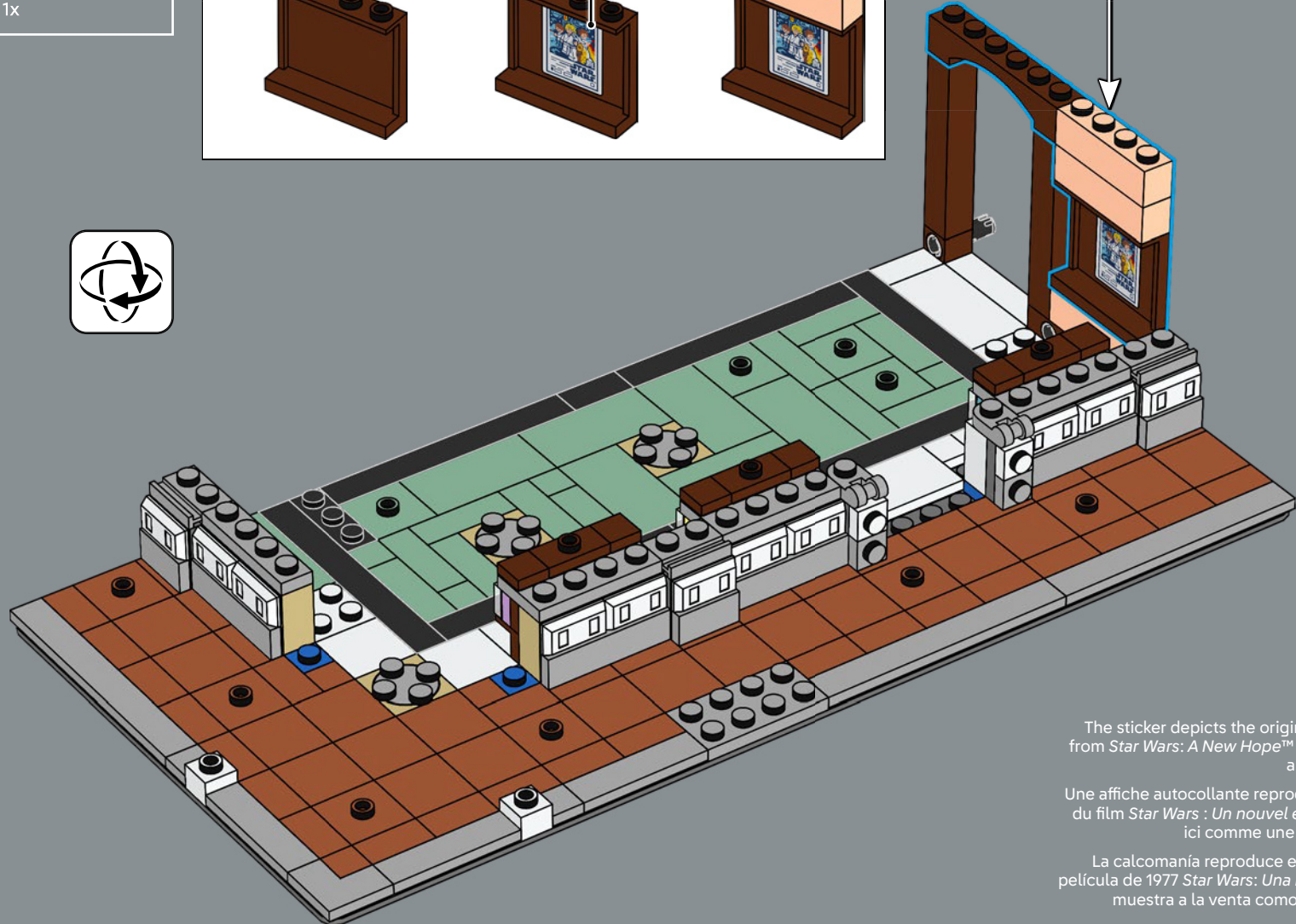
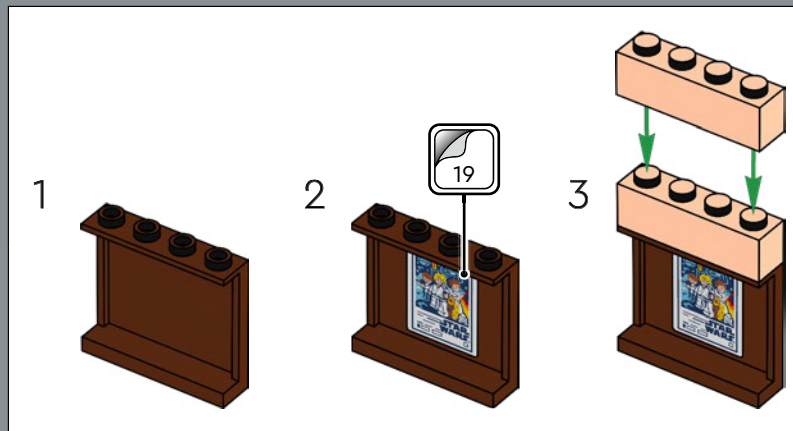

The sticker depicts the original 1977 movie poster from *Star Wars: A New Hope*™ and is shown for sale as a collectible poster.

Une affiche autocollante reproduit l'affiche originale du film *Star Wars : Un nouvel espoir* (1977), exposée ici comme une affiche de collection.

La calcomanía reproduce el póster original de la película de 1977 *Star Wars: Una nueva esperanza* y se muestra a la venta como objeto de colección.

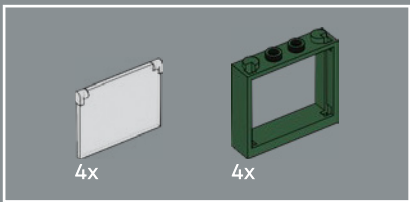

21

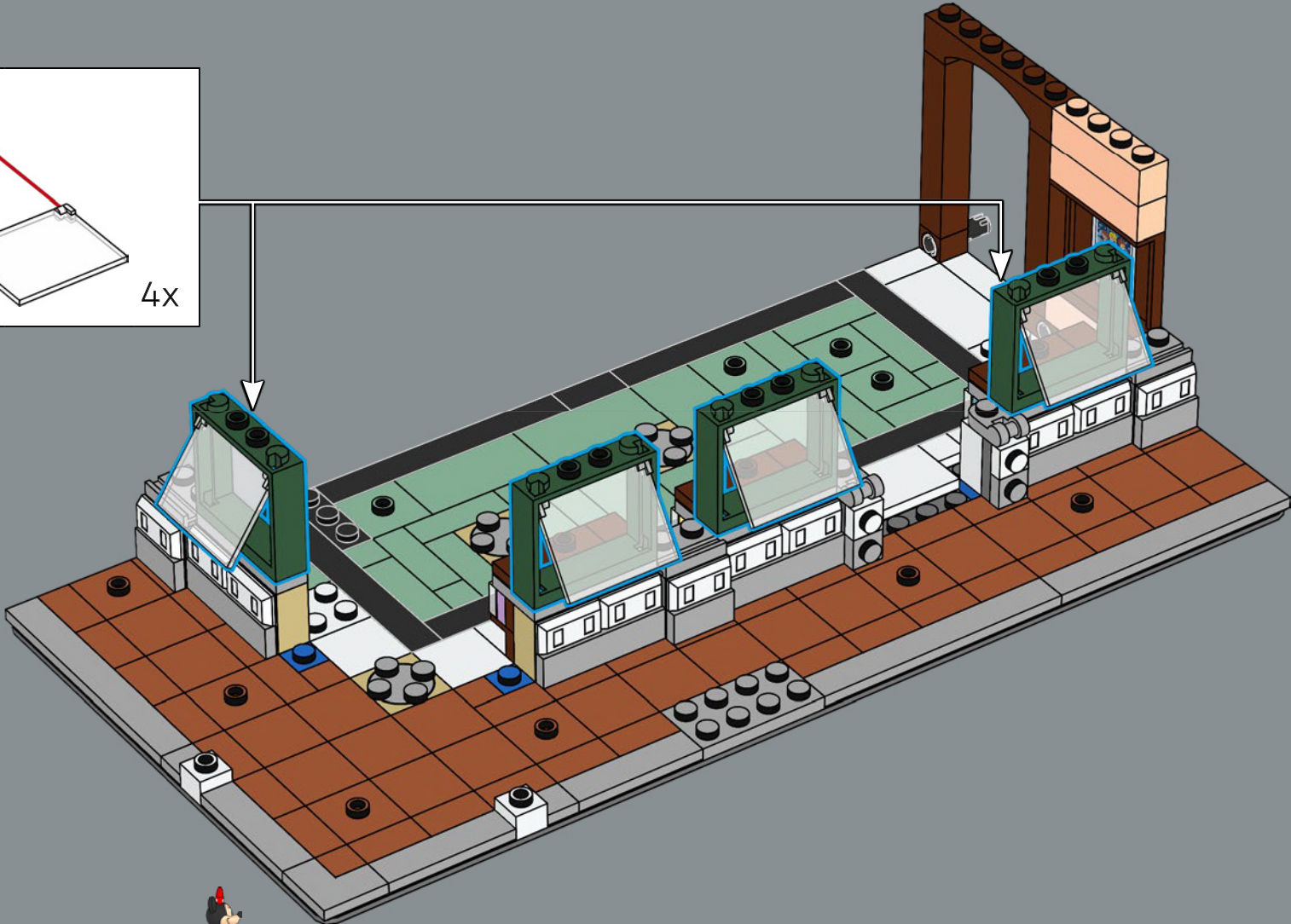
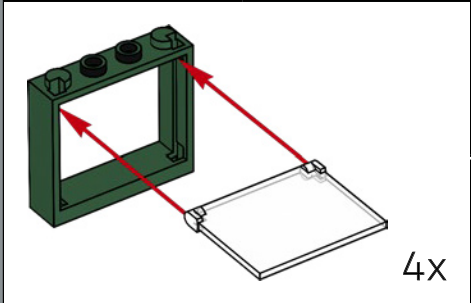

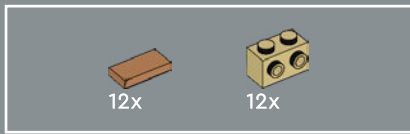

22

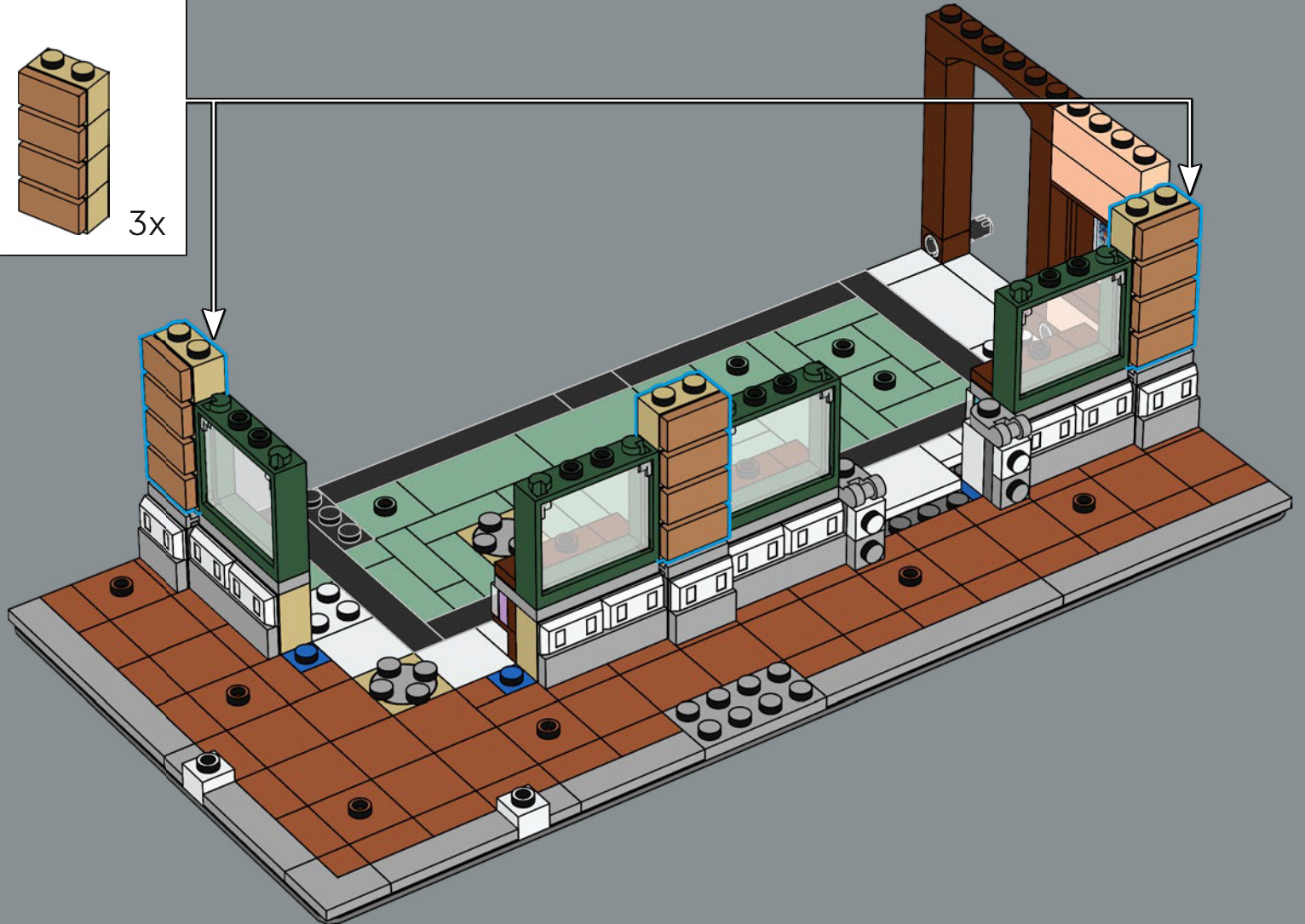
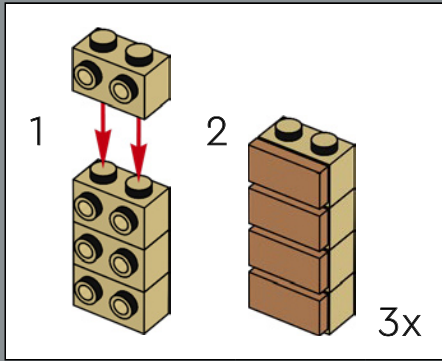



23

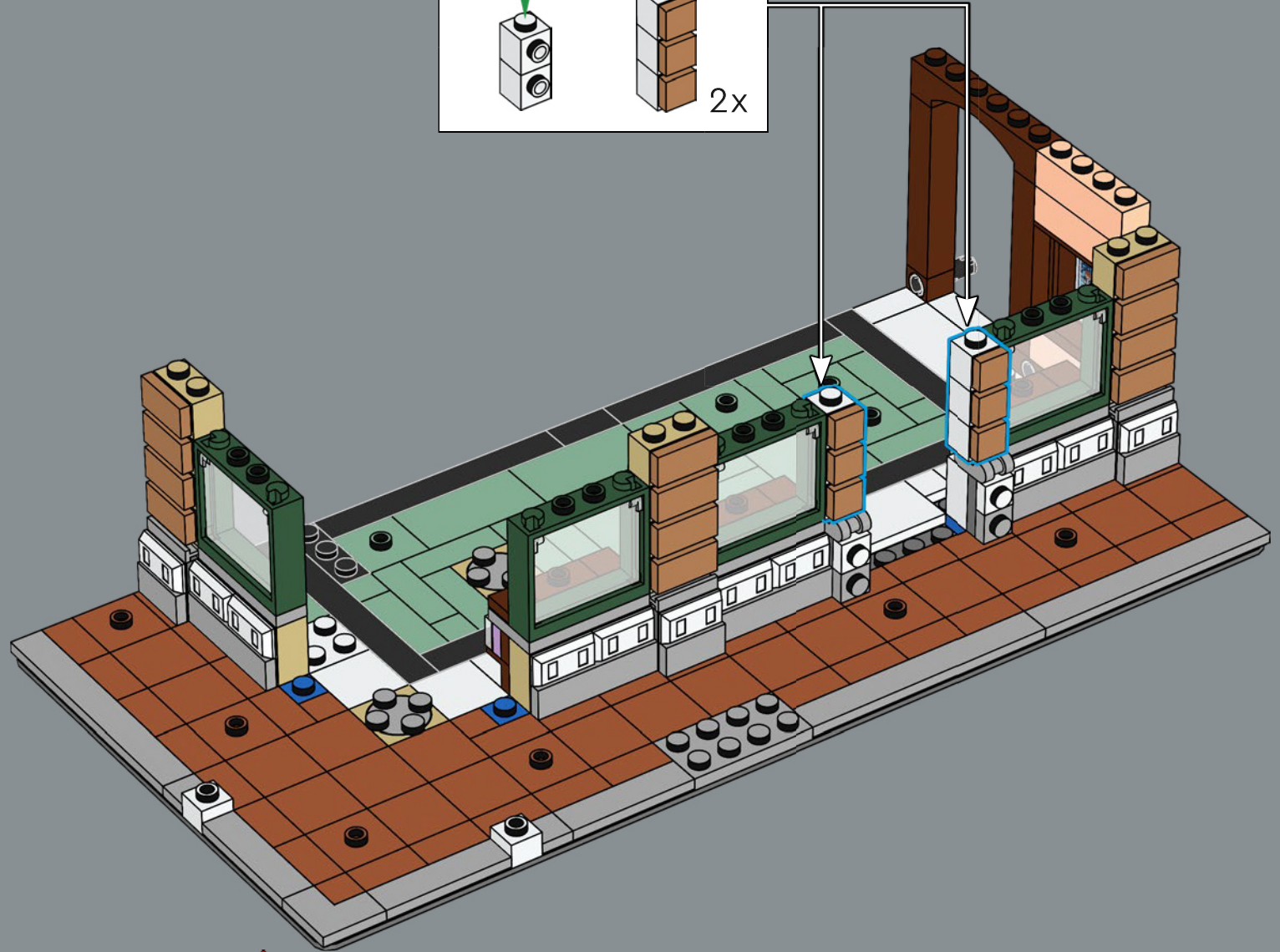
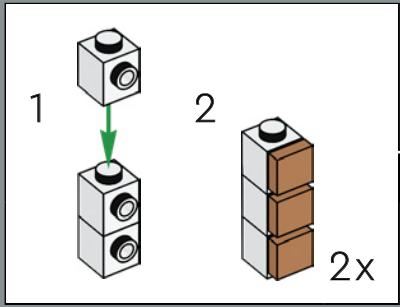

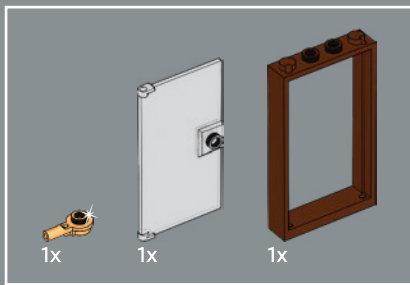

24

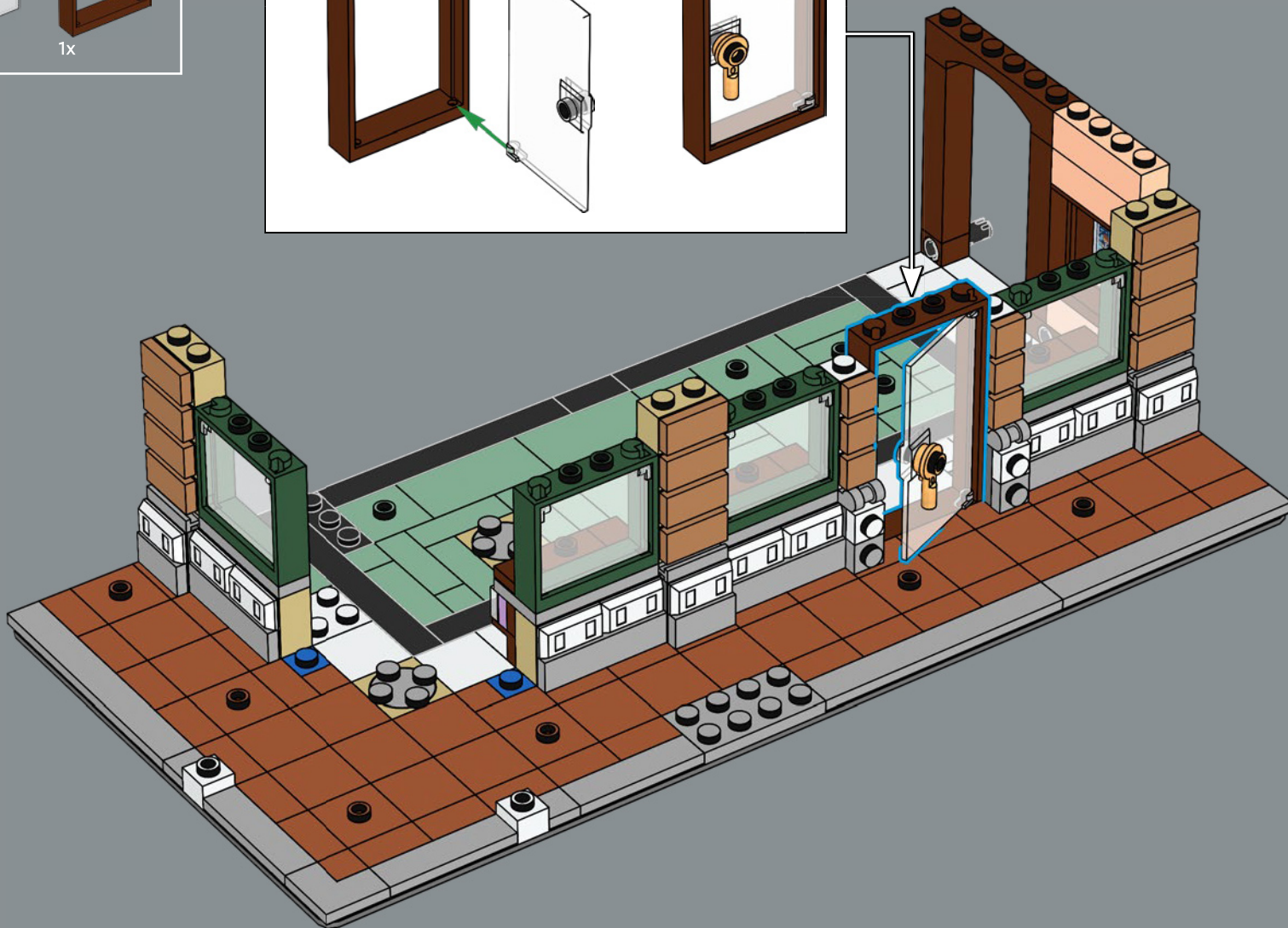
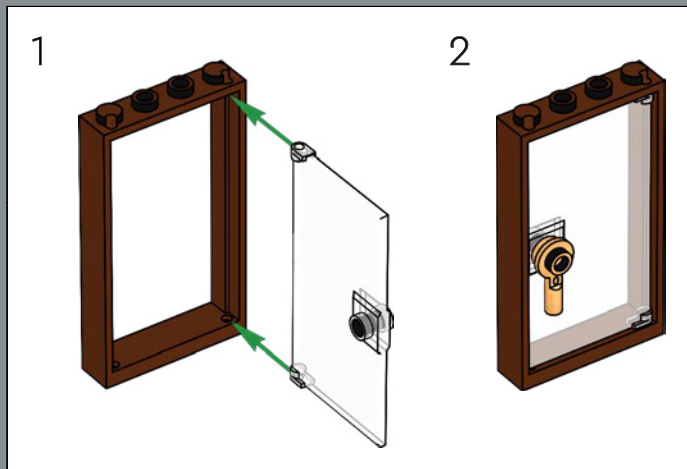



2x

25

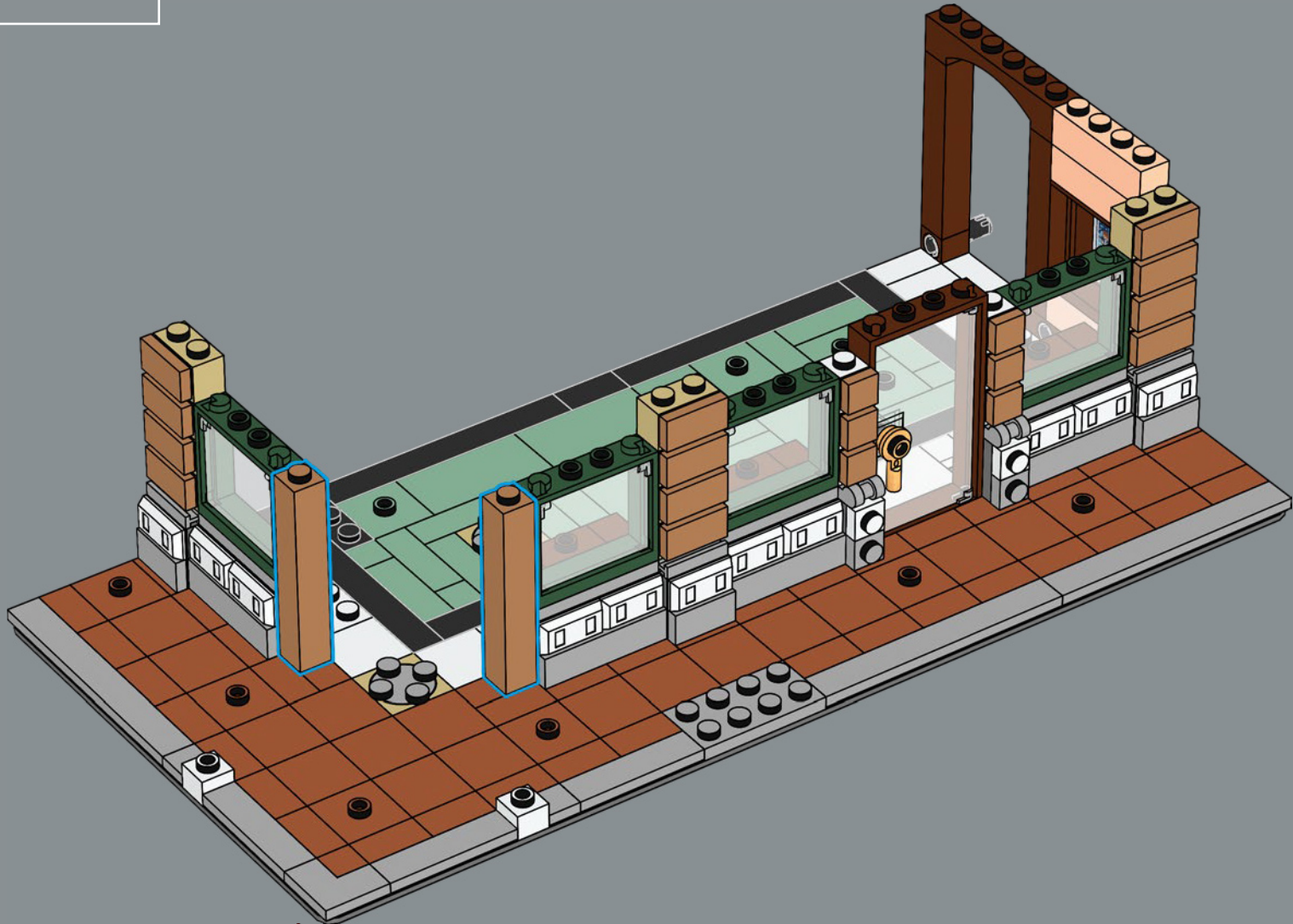

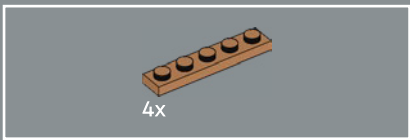

26

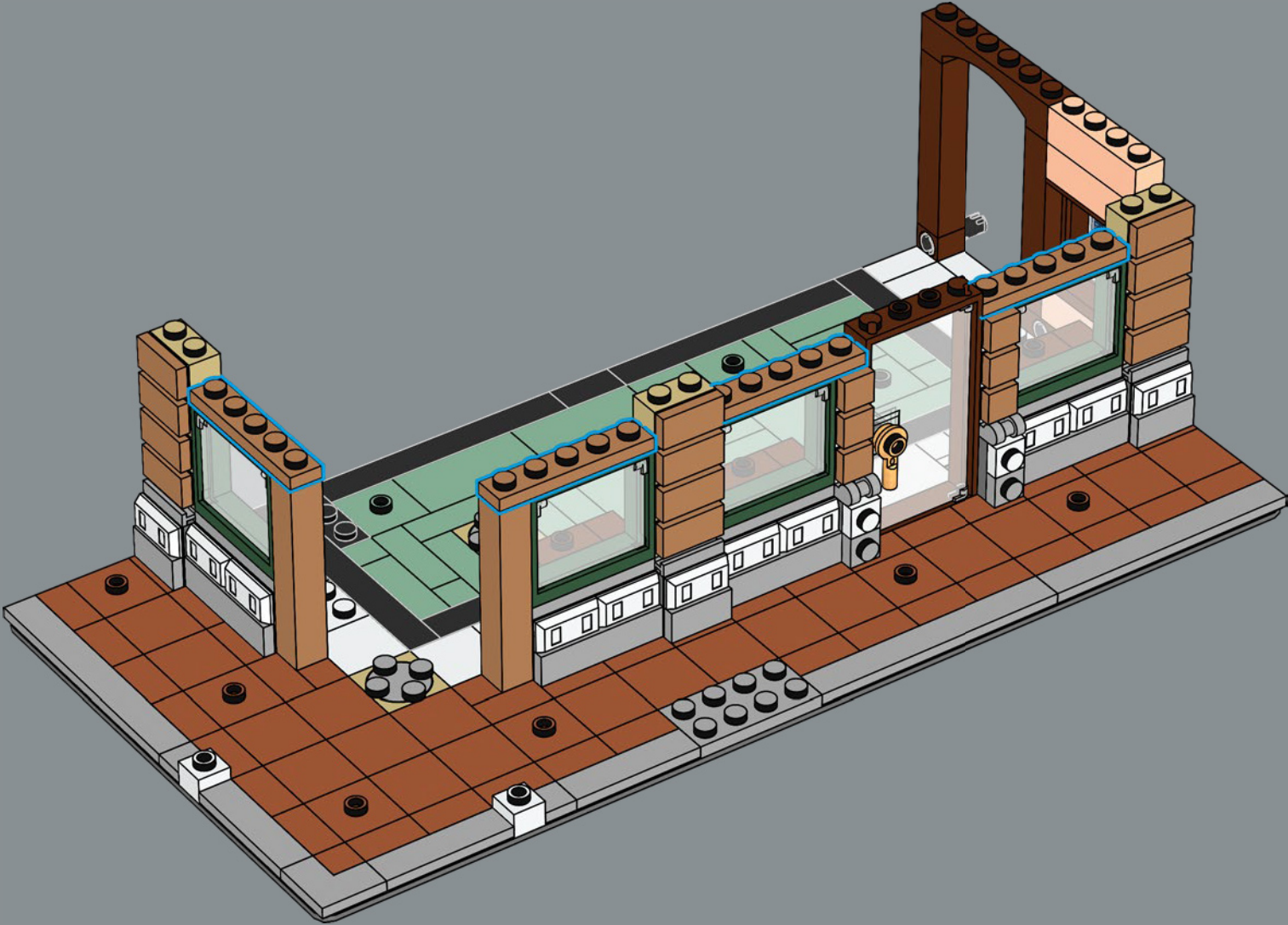

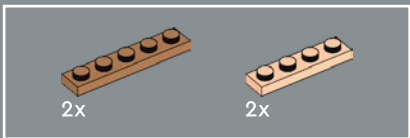

27



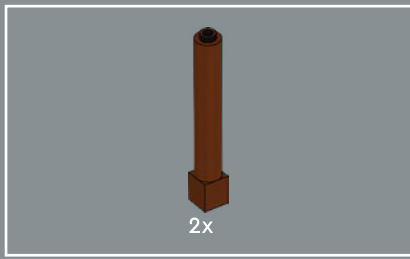

28

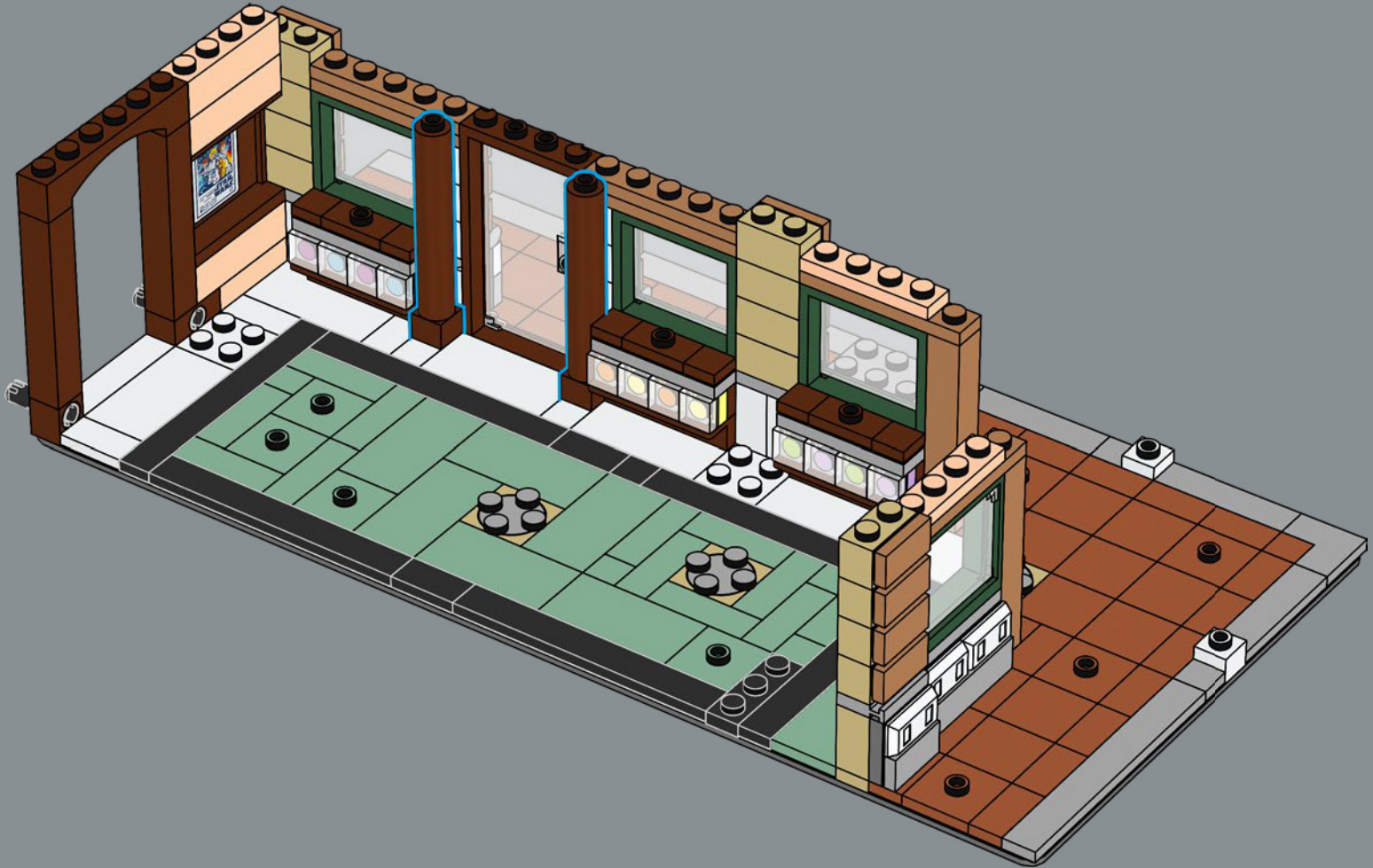

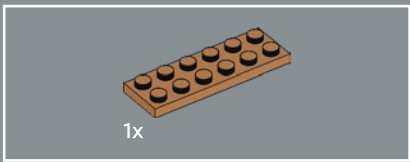

29

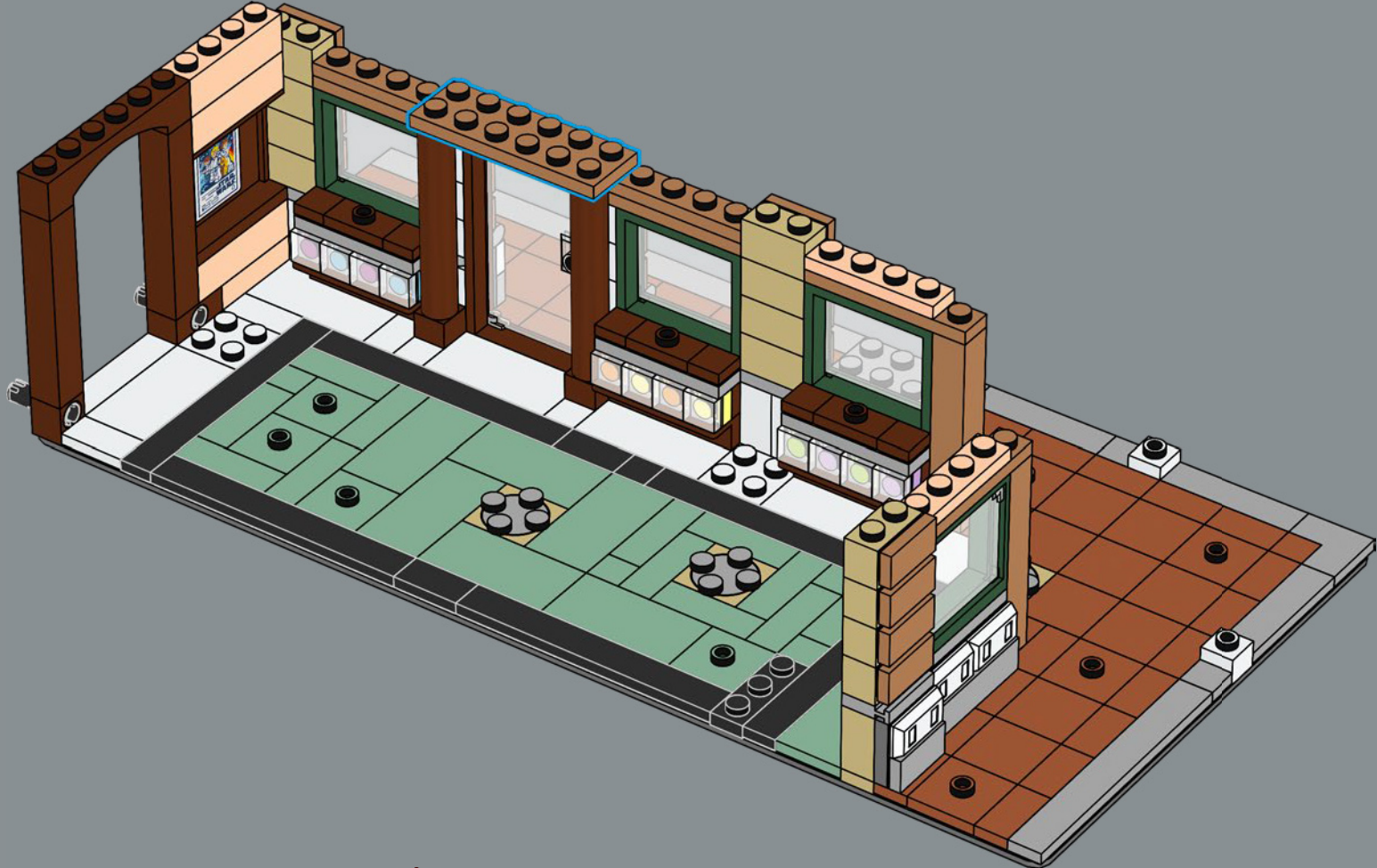

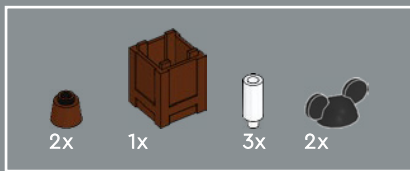

30

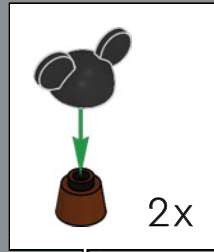

A Mickey Mouse ear hat element was created specifically for this model – and for you to add to your Mickey ear hat collection! The LEGO® minifigure guests can ‘buy’ them here.

Un élément de chapeau à oreilles de Mickey a également été créé pour ce modèle – parfait pour enrichir votre propre collection de chapeaux Mickey! Les figurines LEGO® peuvent ainsi les « acheter ».

Con motivo de este modelo, ¡diseñamos un nuevo elemento con forma de gorro con orejas de Mickey Mouse que puedes agregar a tu colección de sombreros de Mickey! Las minifiguras LEGO® de visitantes pueden “comprarlo” aquí.

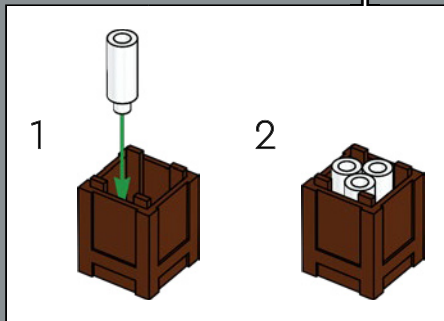
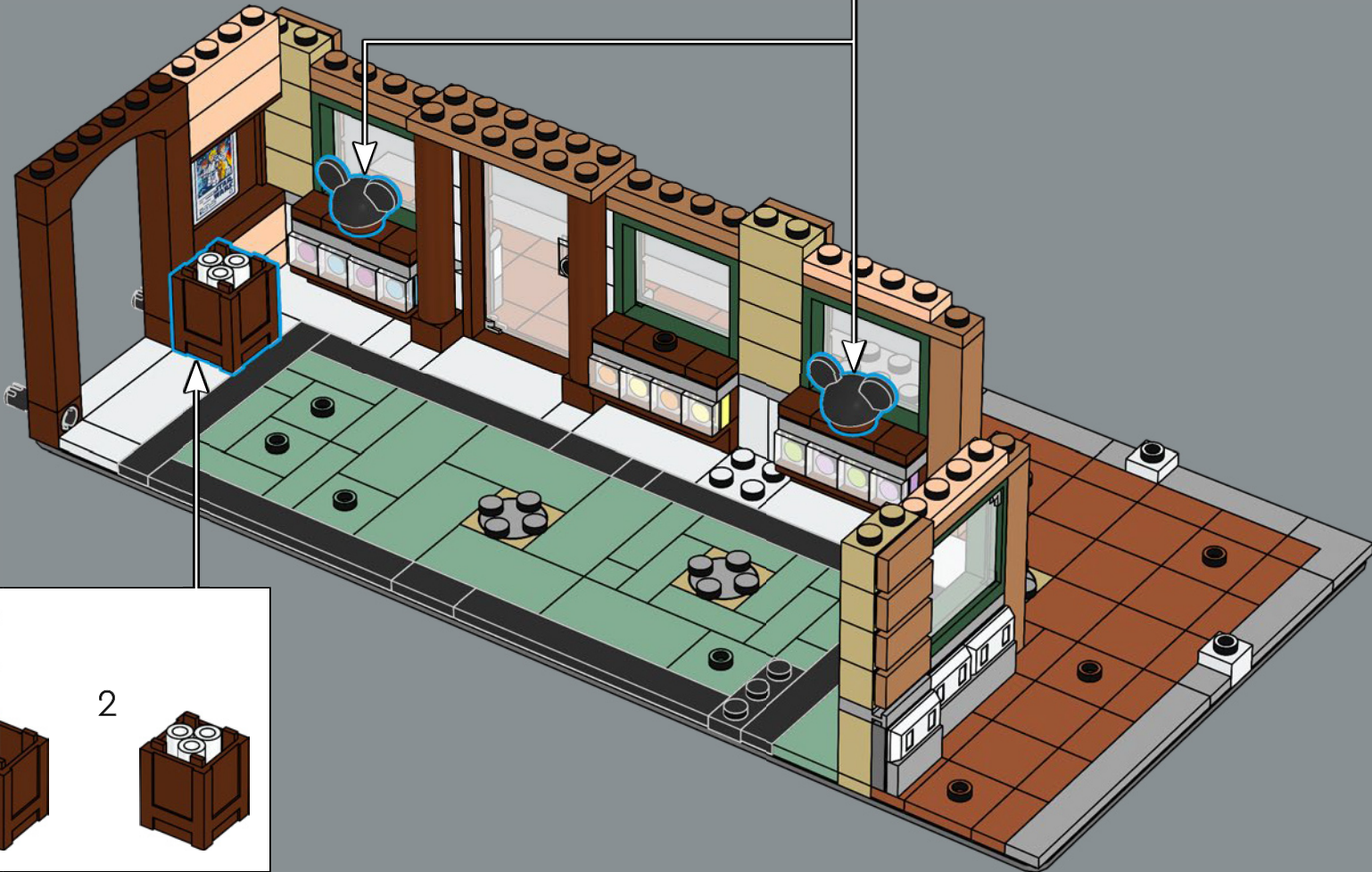



31

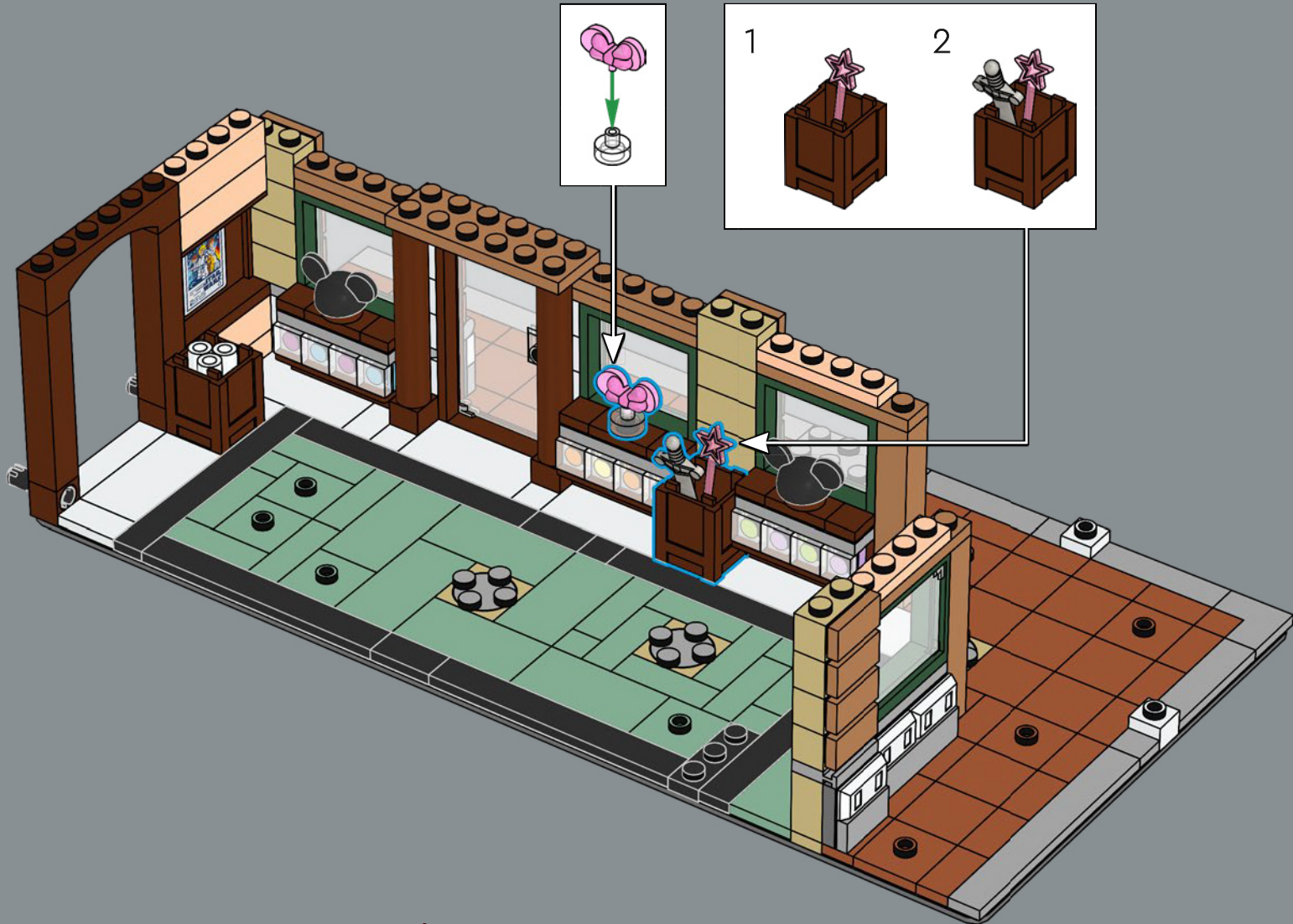

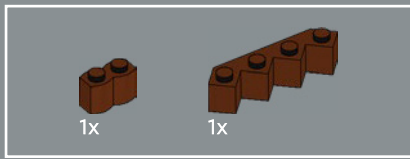

32

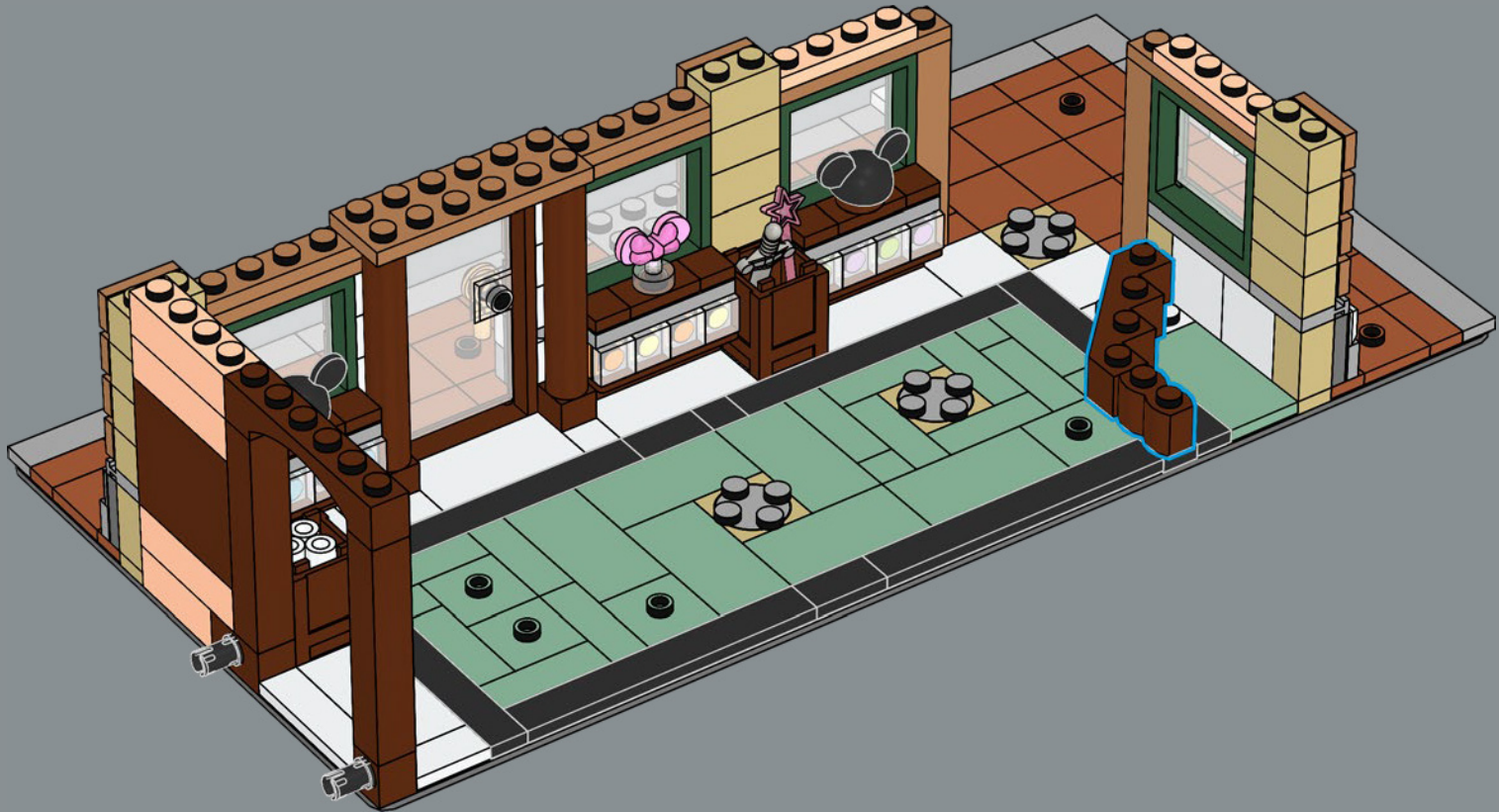

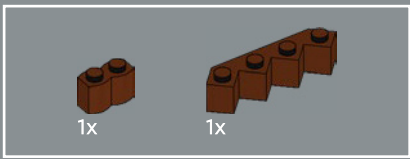

33

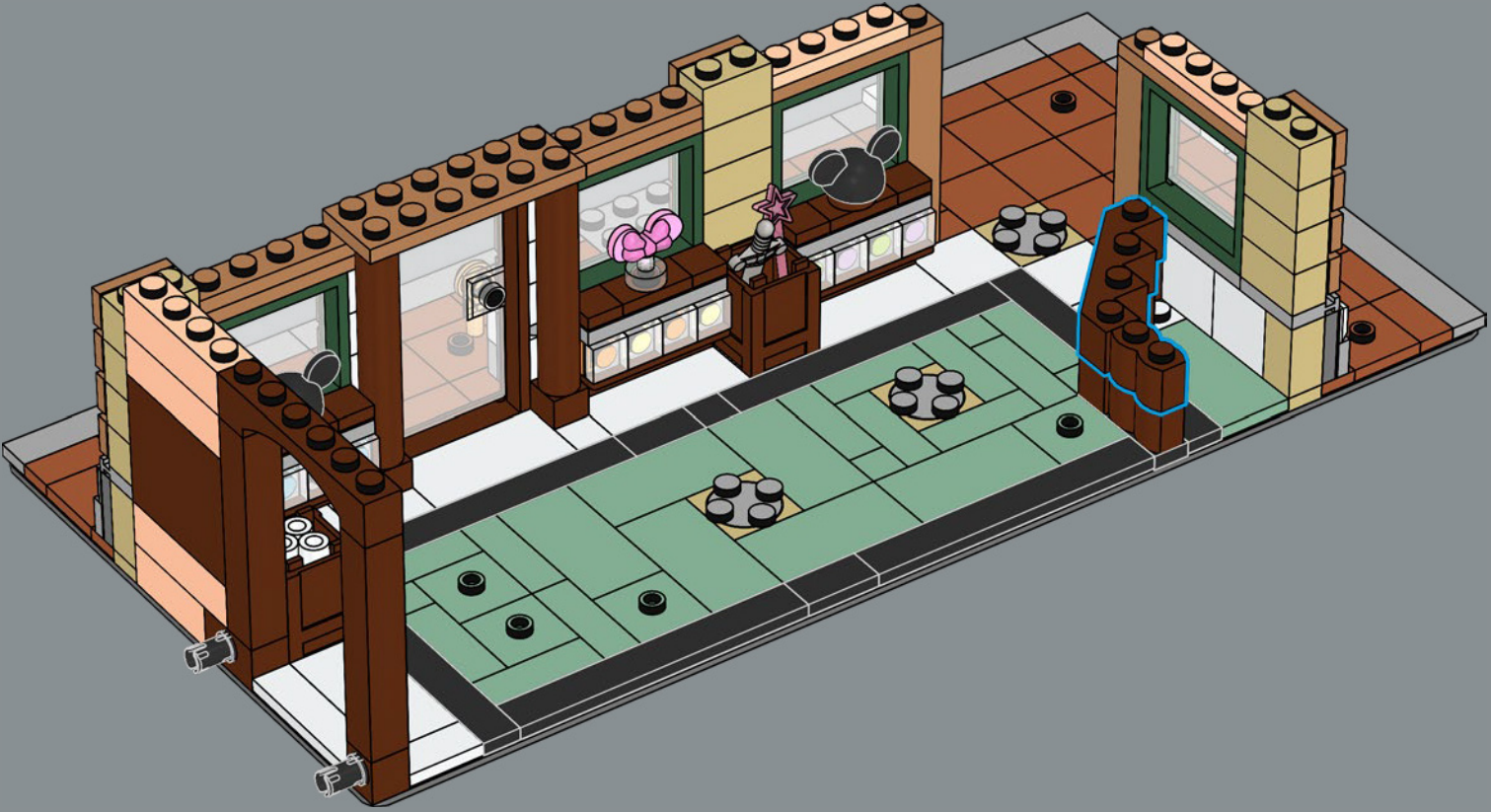



34

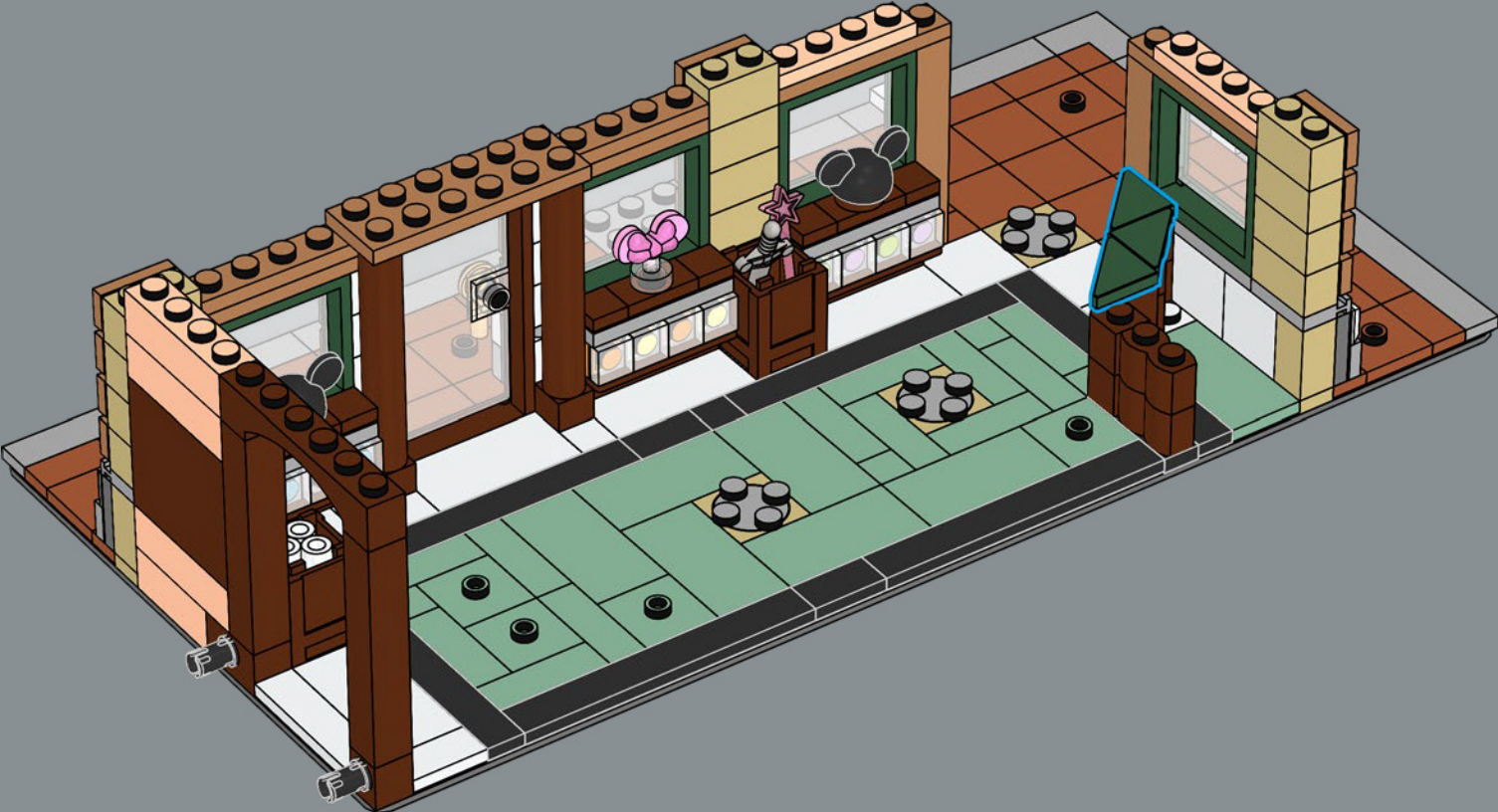



35

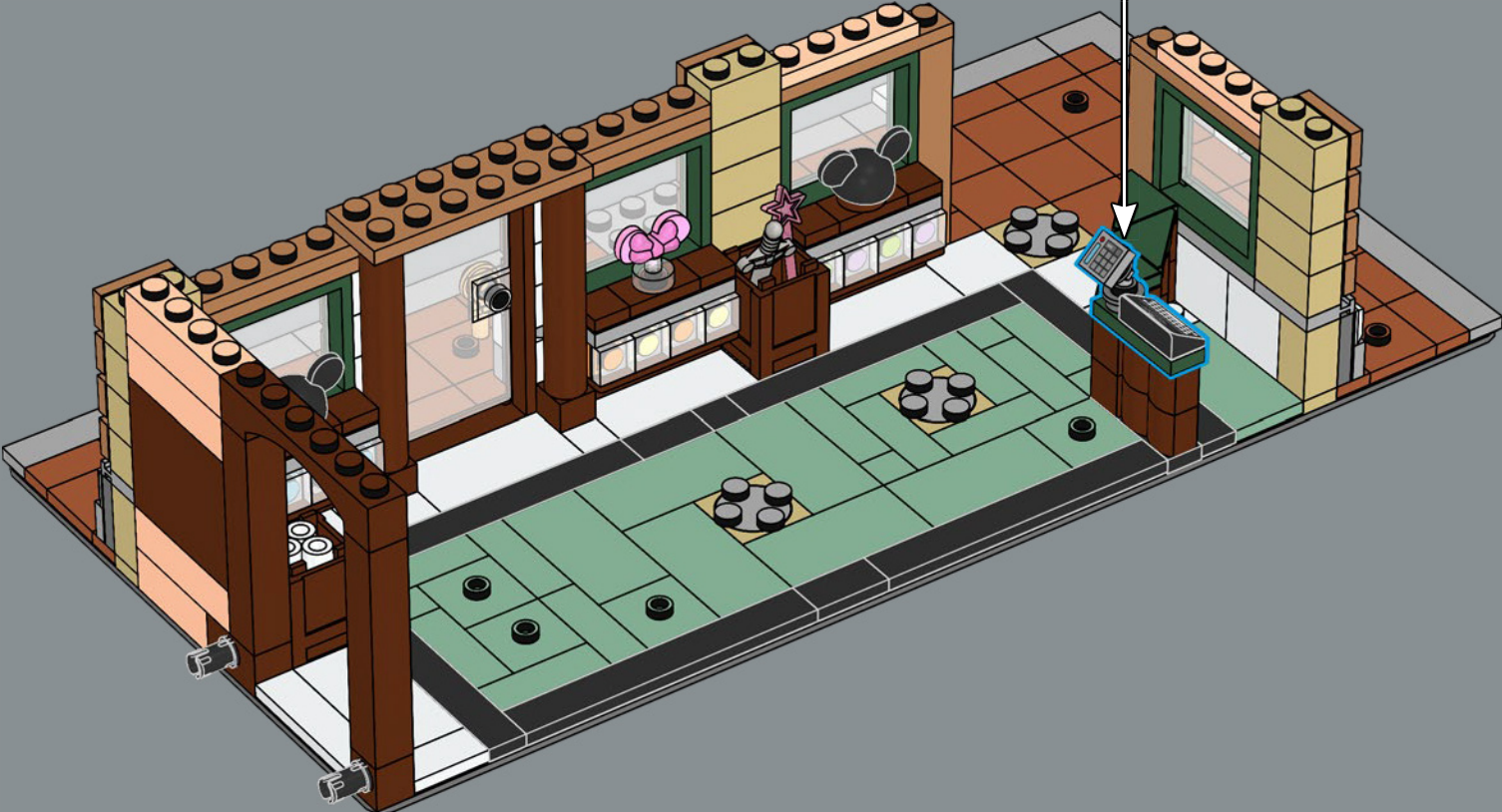
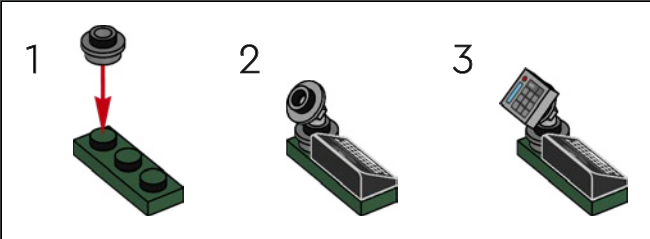

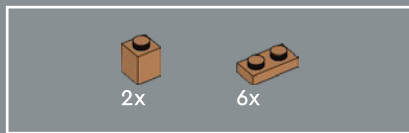

36

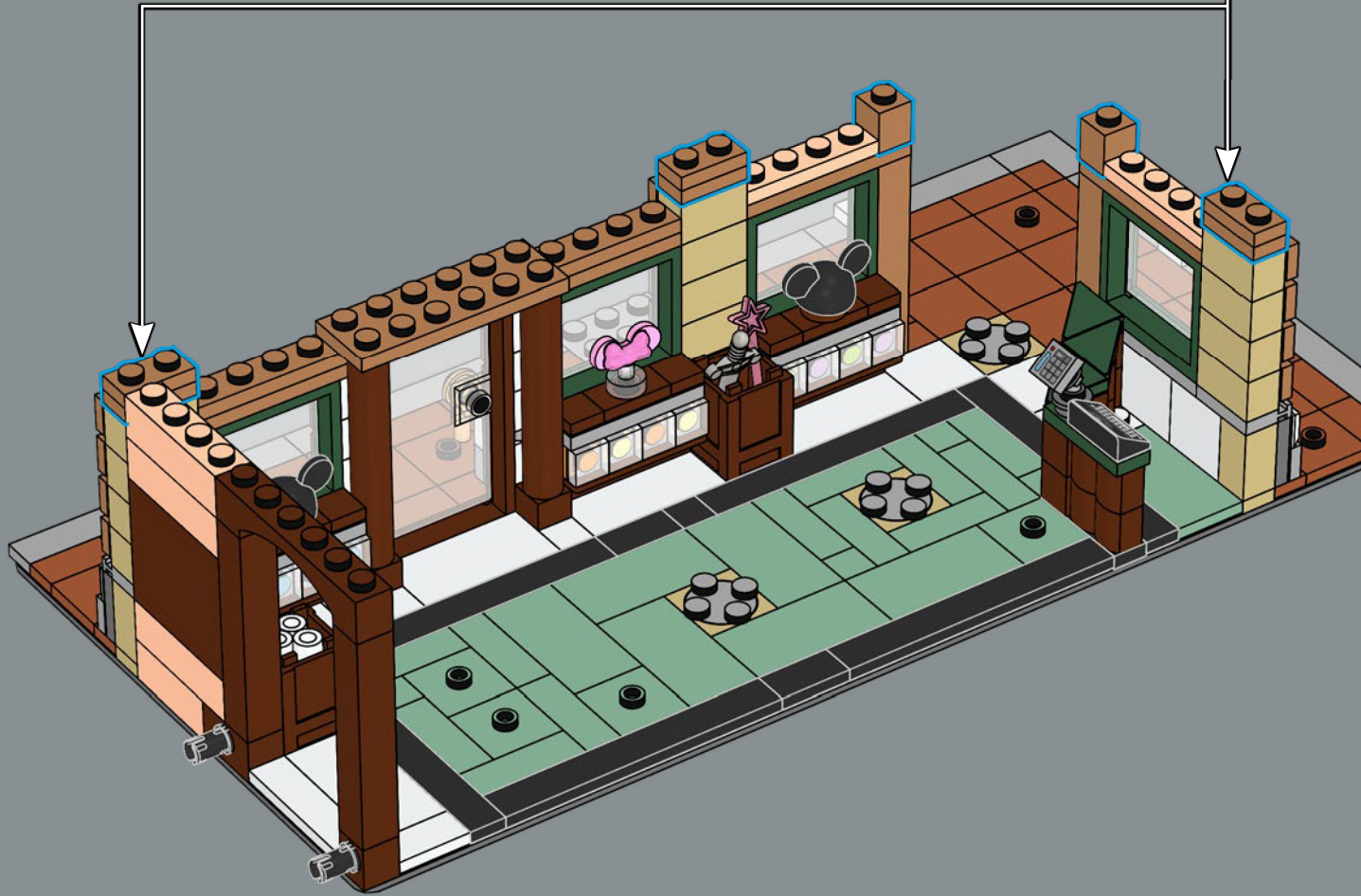
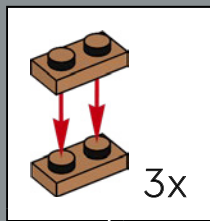

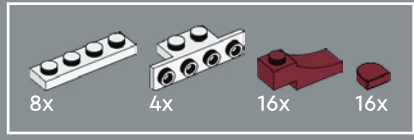
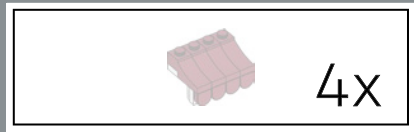

37

1

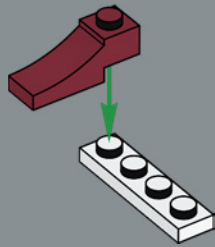

2

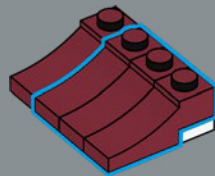

3

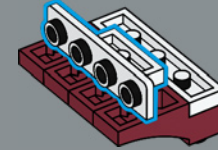

4

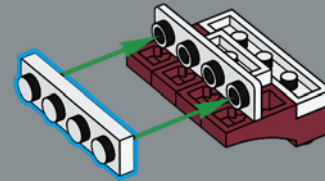

5

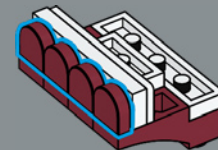

4x



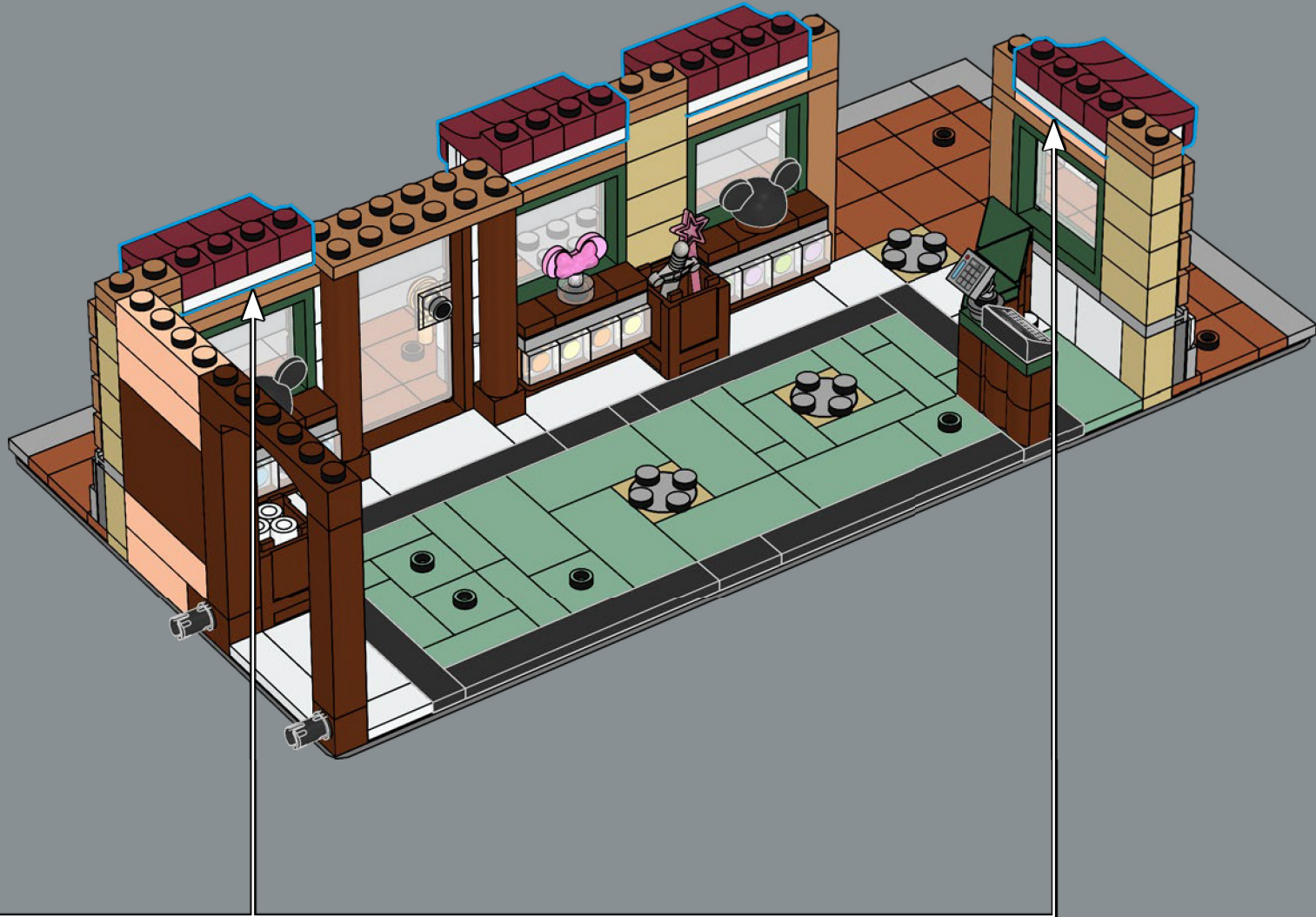

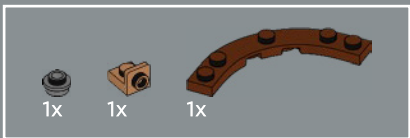

38

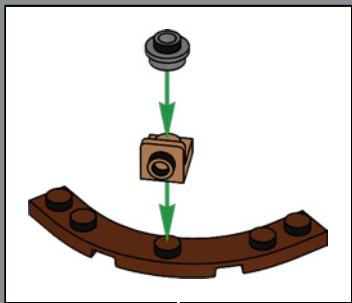

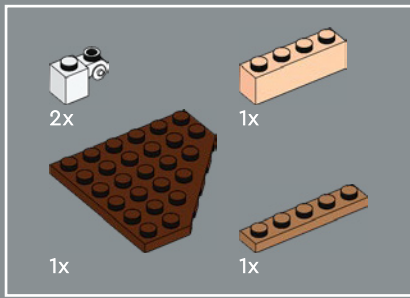

39



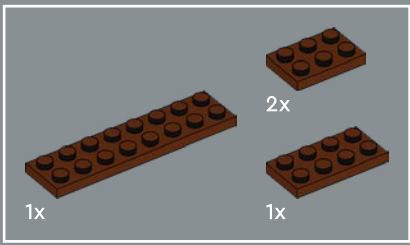

40



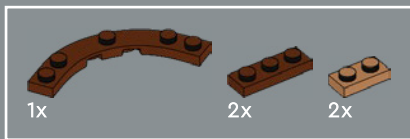

41

1

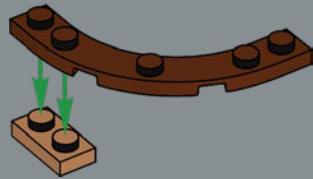

2

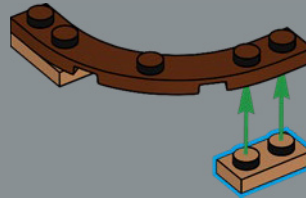

3

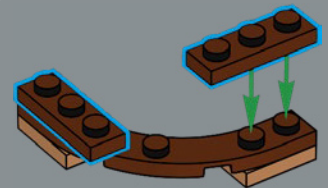

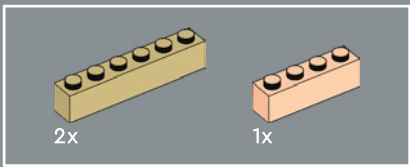

42



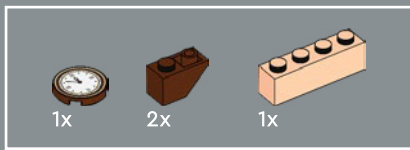

43



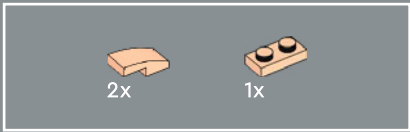

44

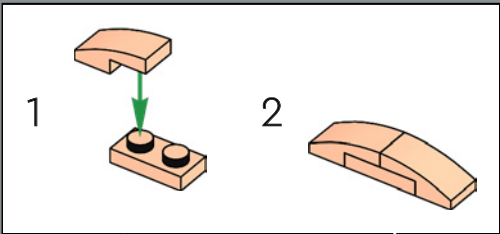

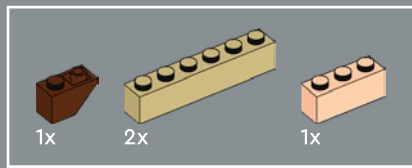

45



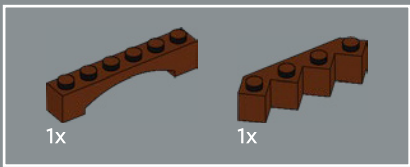

46



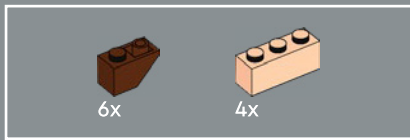

47





A brand-new Mickey Mouse balloon element was created for this model, so that park guests can carry and hold the balloons throughout their visit and take an iconic selfie with them.

Un tout nouveau ballon en forme de Mickey Mouse a été conçu spécialement pour ce modèle, afin que les visiteurs du parc puissent le tenir tout au long de leur visite et prendre un autoportrait emblématique, ballon à la main.

Se creó un nuevo elemento con forma de globo con orejas de Mickey Mouse para este modelo a fin de que los visitantes pudieran llevarlo en sus visitas al parque y tomarse selfies con él.

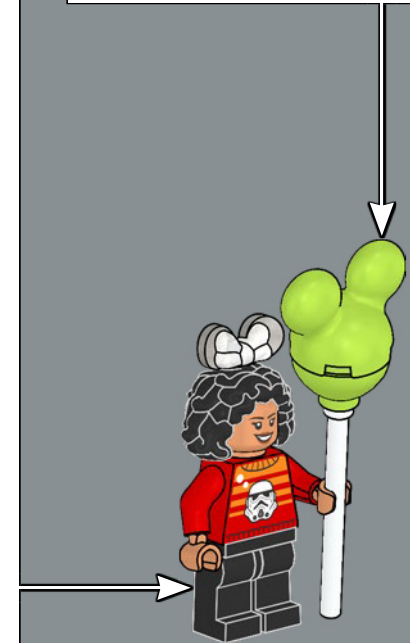
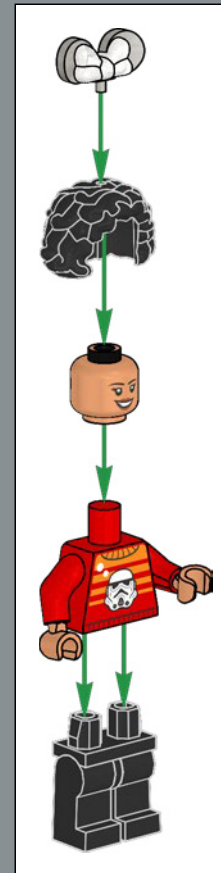
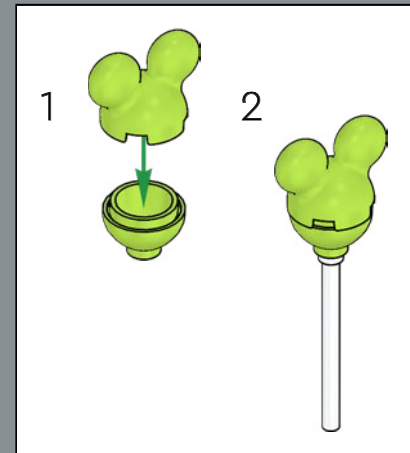

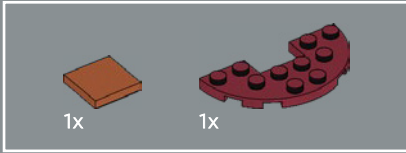
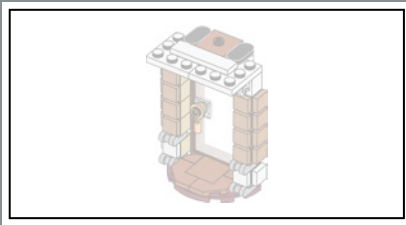

48

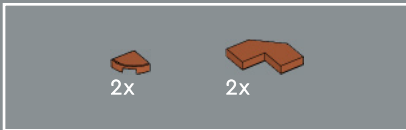
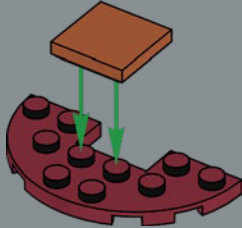

49

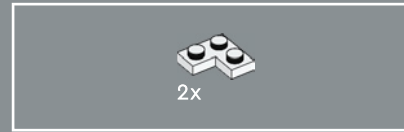
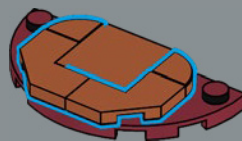

50

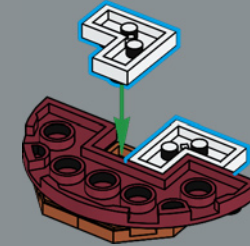

51

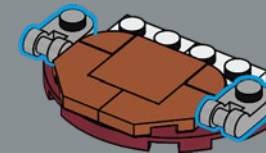



52

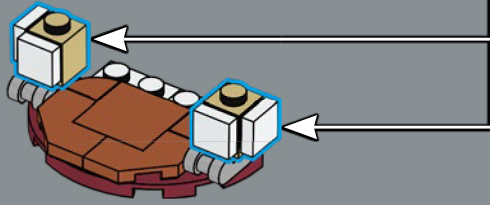
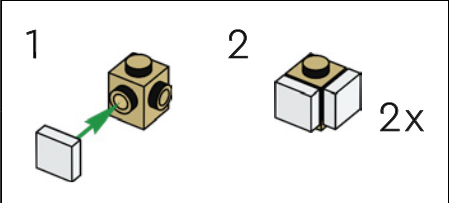

53

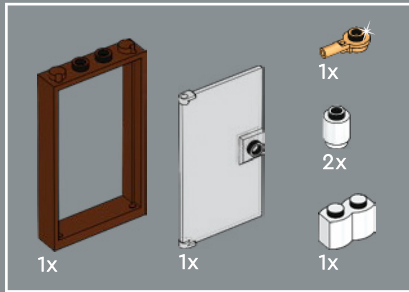
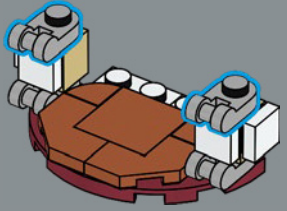

54

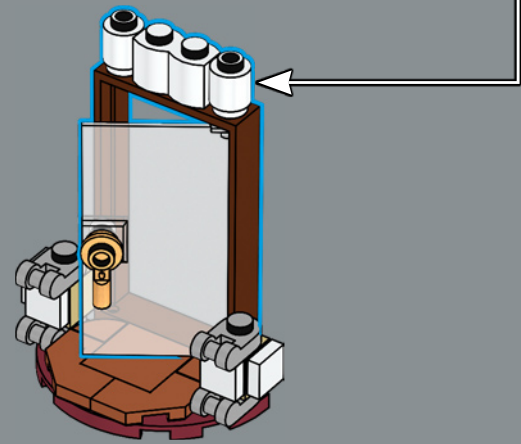
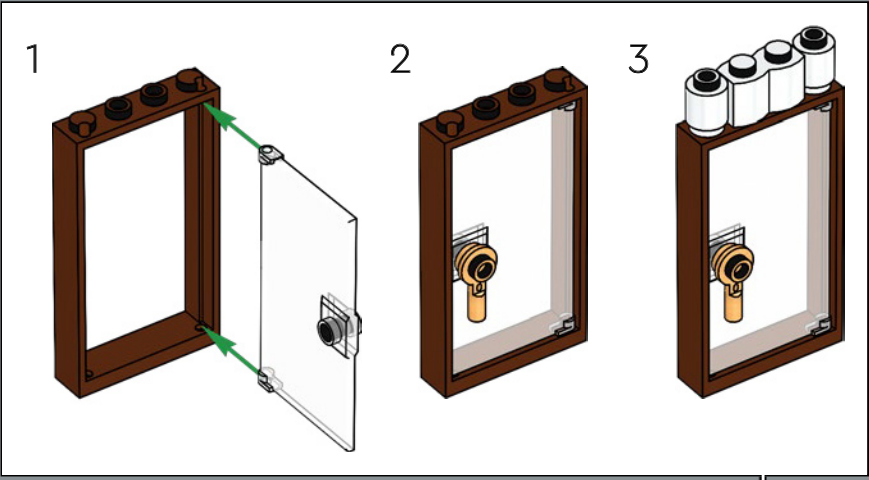

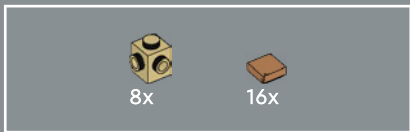

55

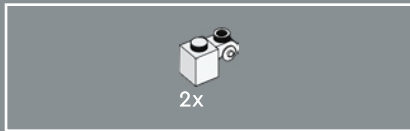
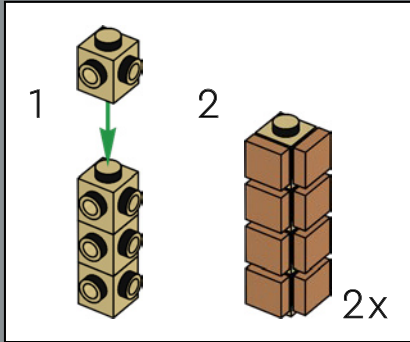

56

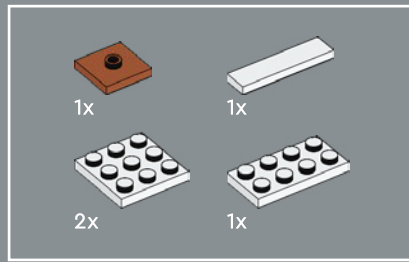

57

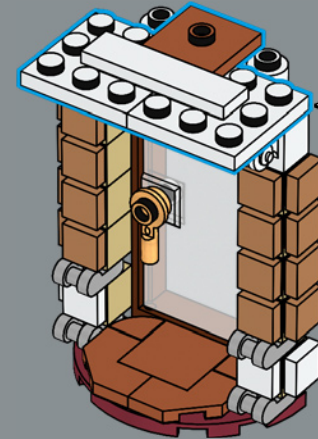
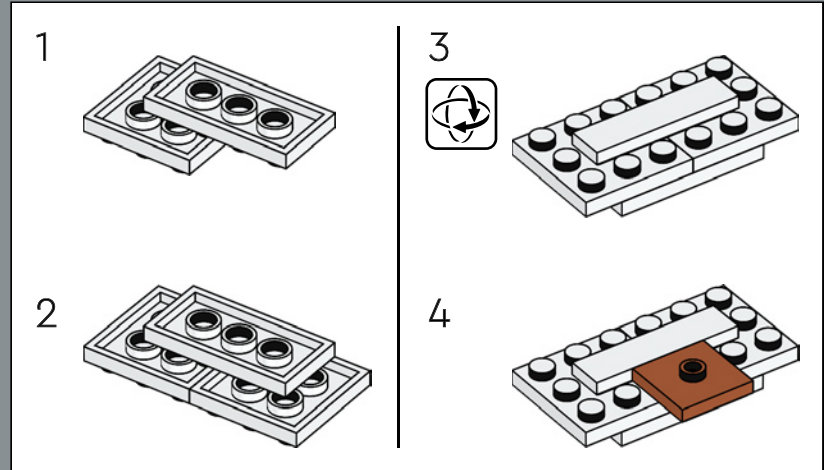



2x

58

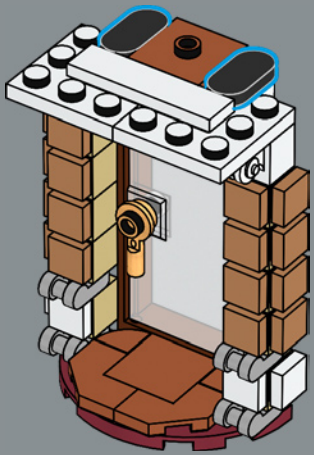

59



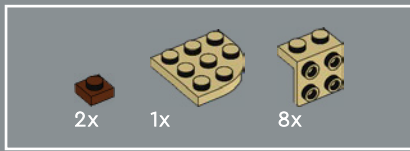

60

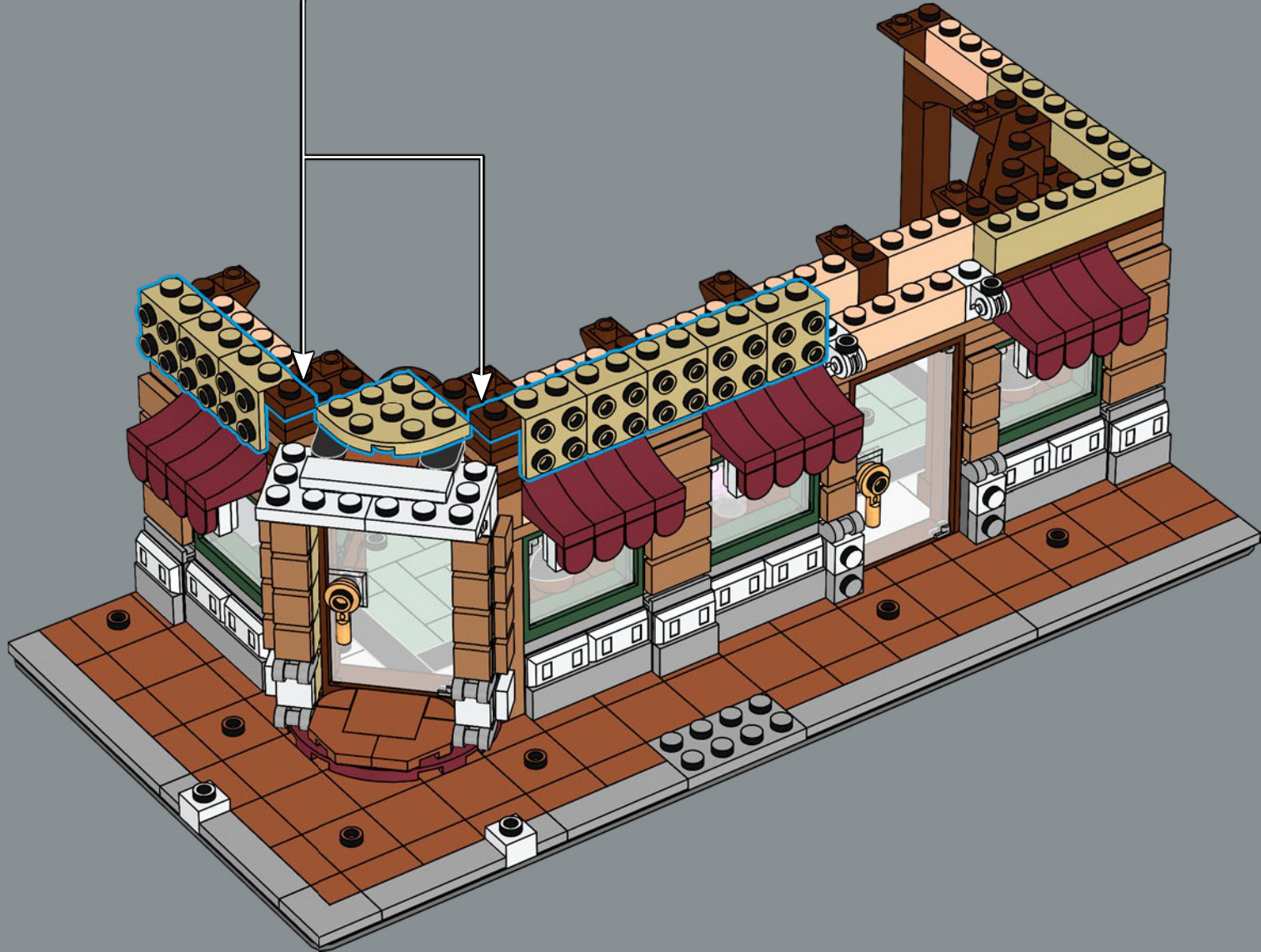

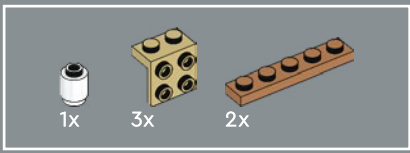

61

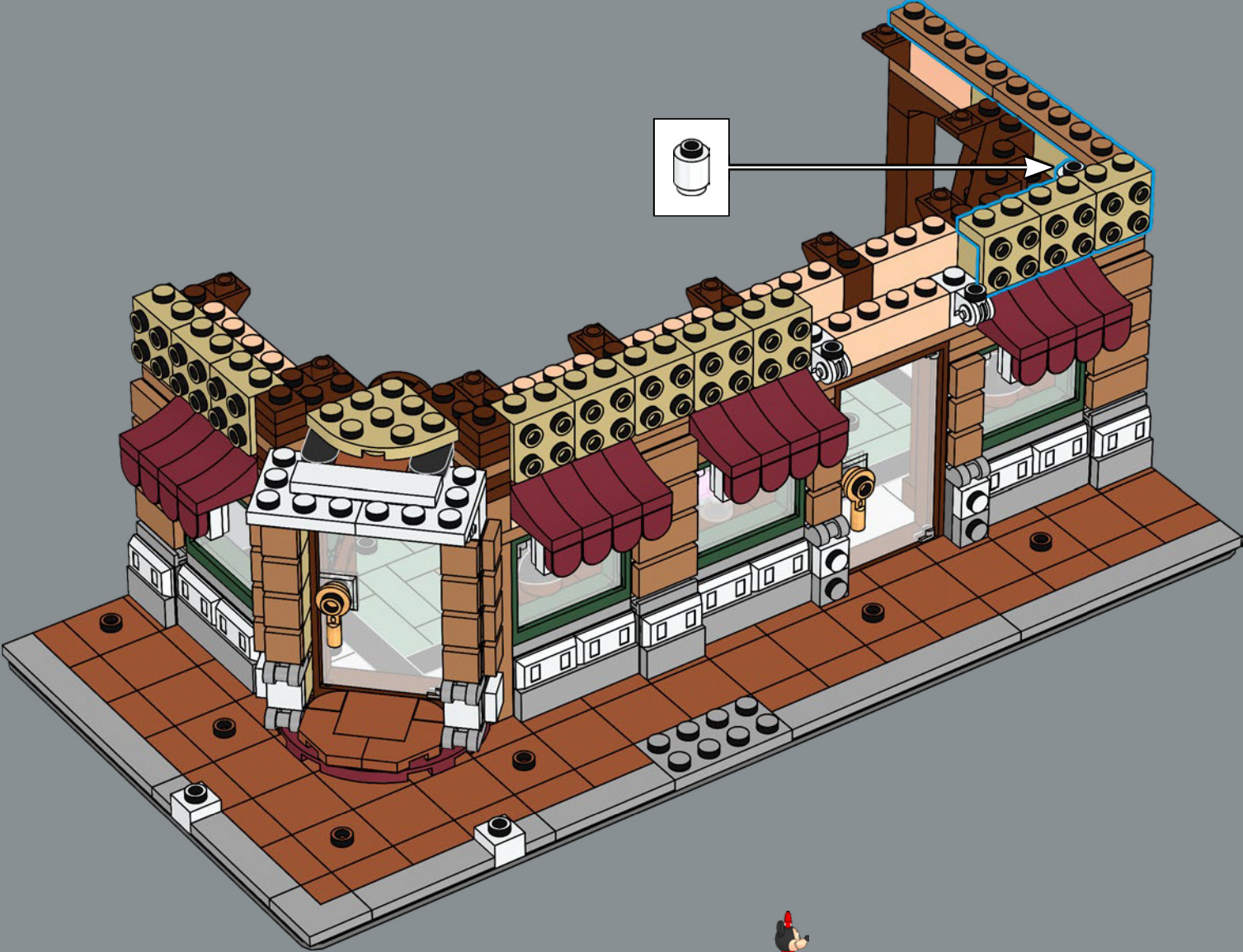

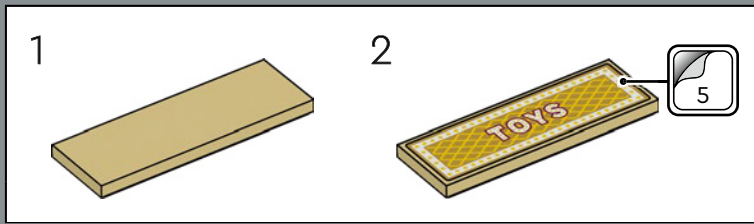
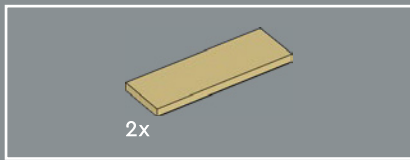

62

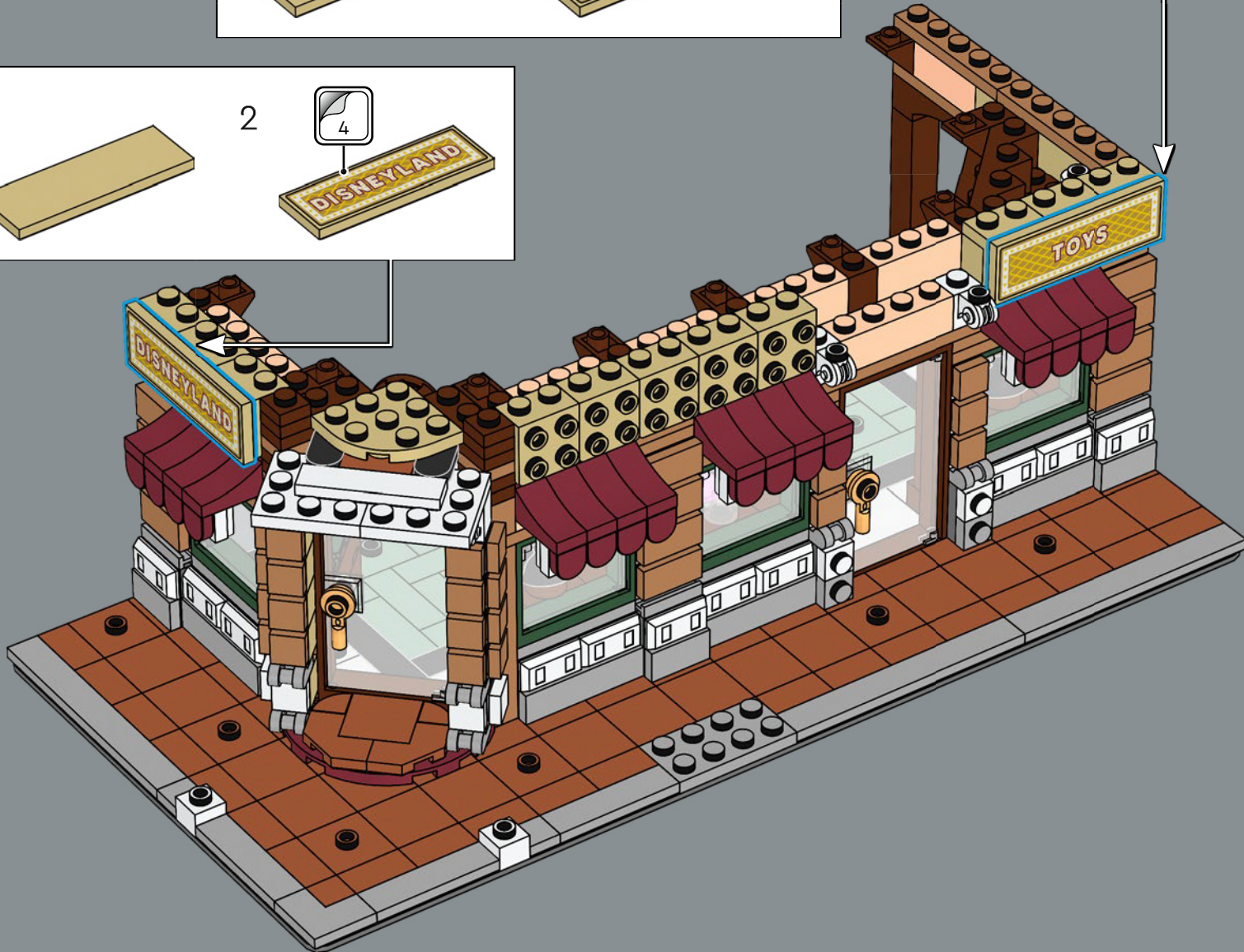
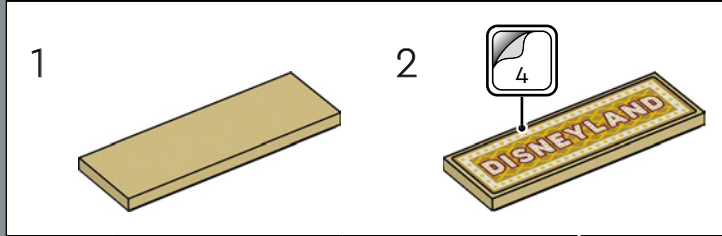

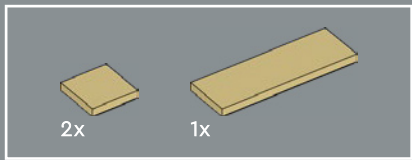

63

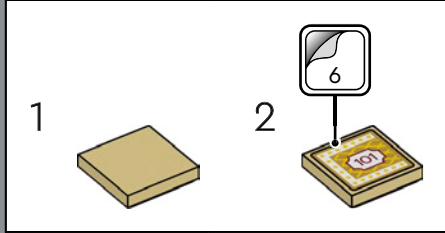
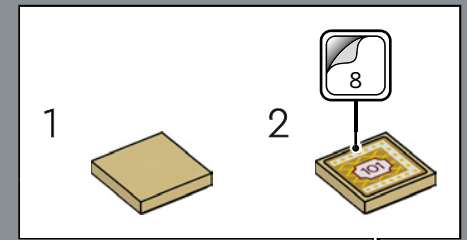
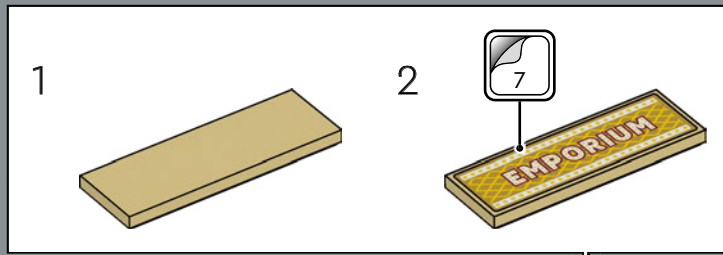

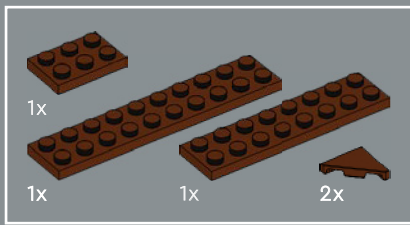

64



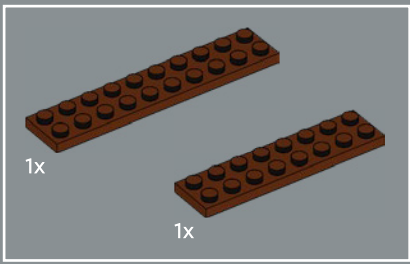

65



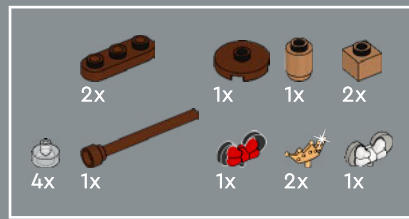

66

1

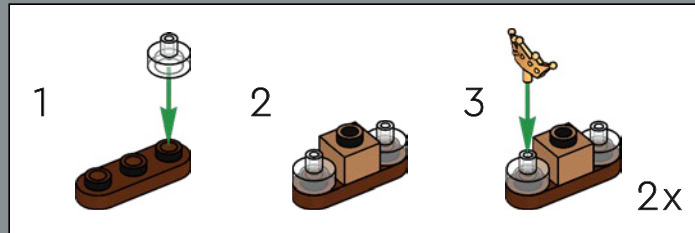
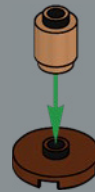

2

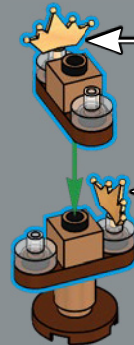

3

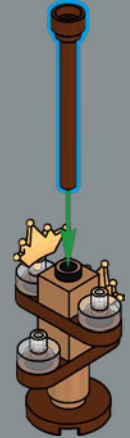

4





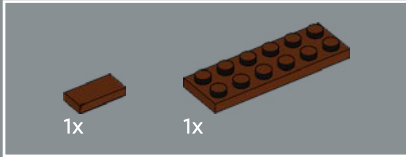

67

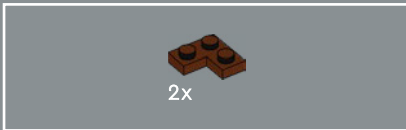
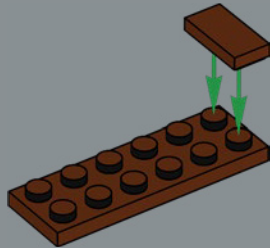

68

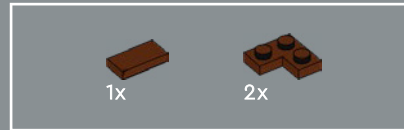
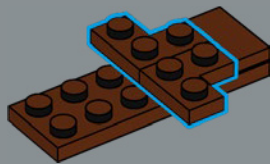

69

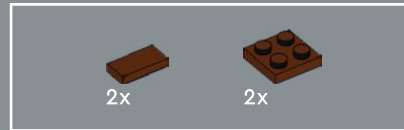
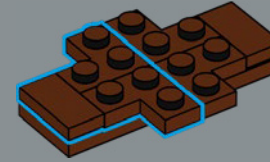

70

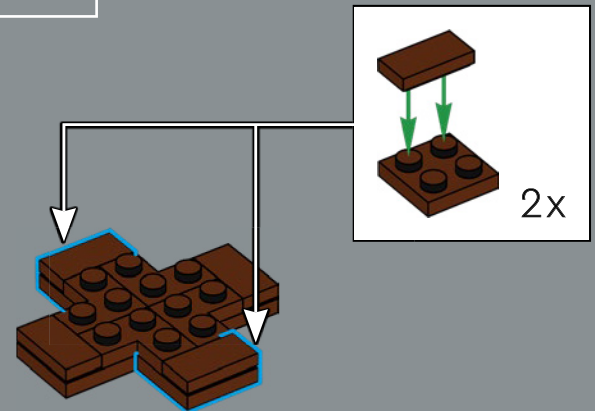

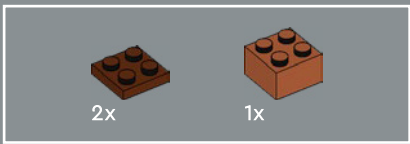

71

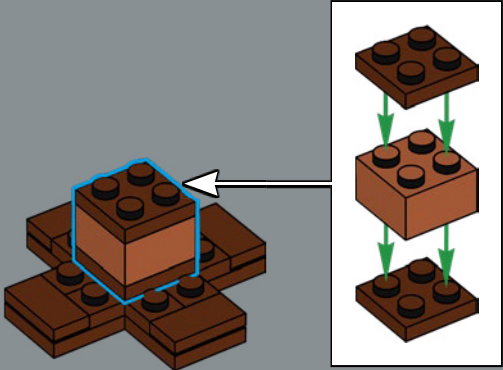

72

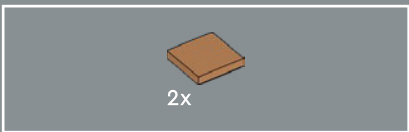
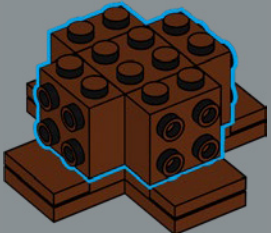

73

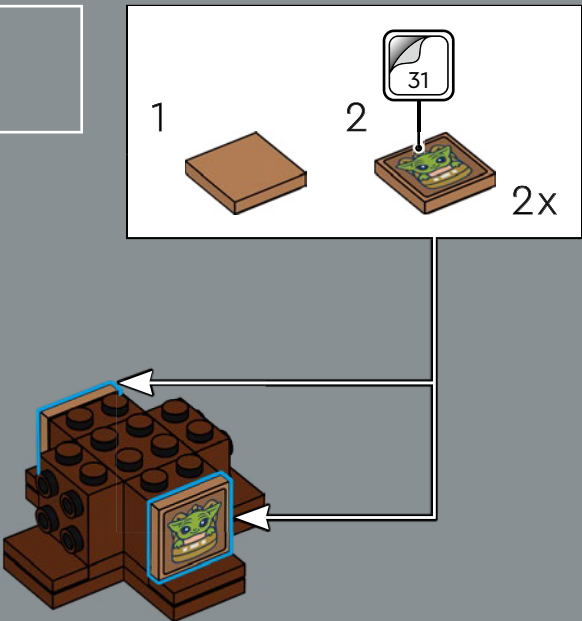

74

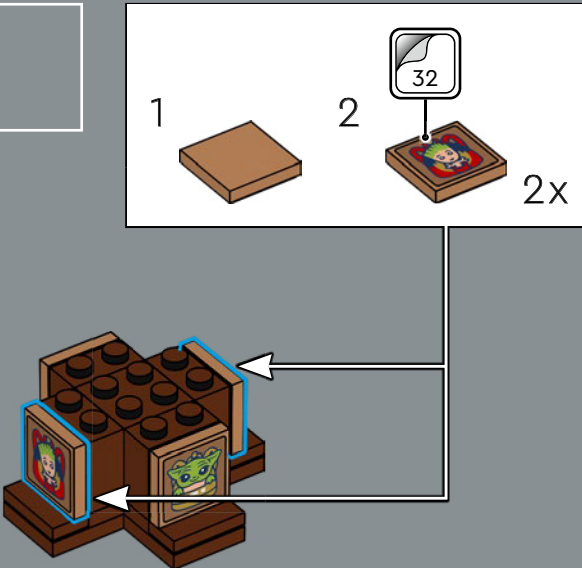

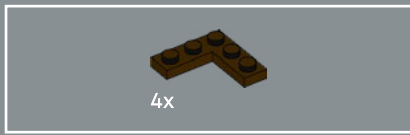

75



76

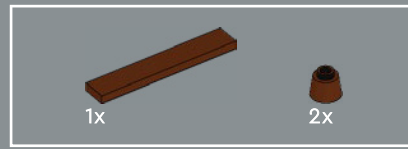
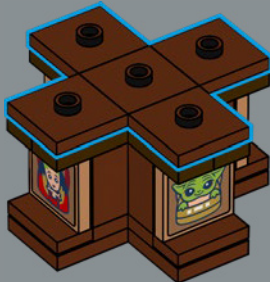

77



78





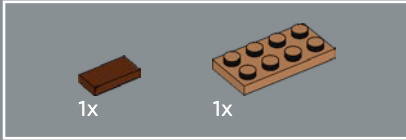

80

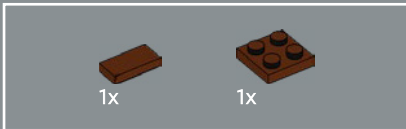
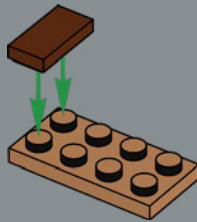

81

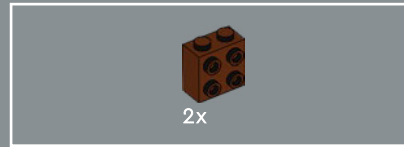
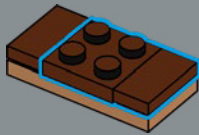

82

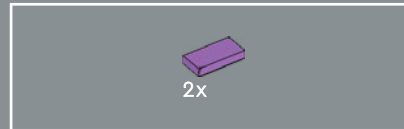
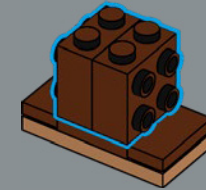

83

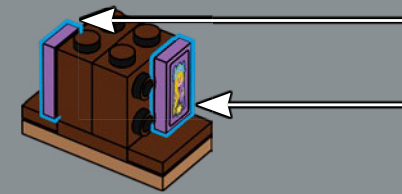
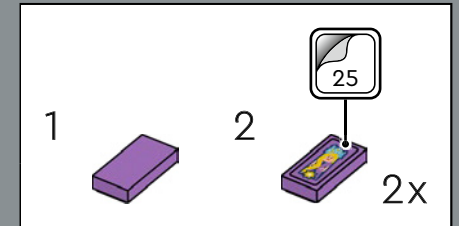

2x

84

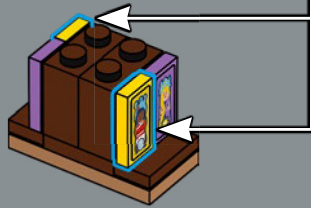
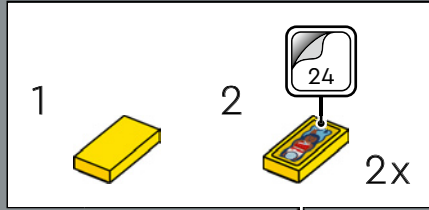

1x

85



1x 1x 1x 1x 2x 1x

86

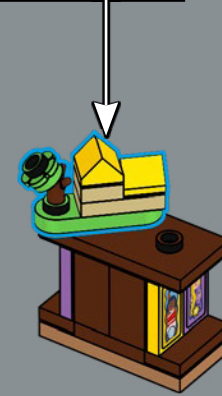
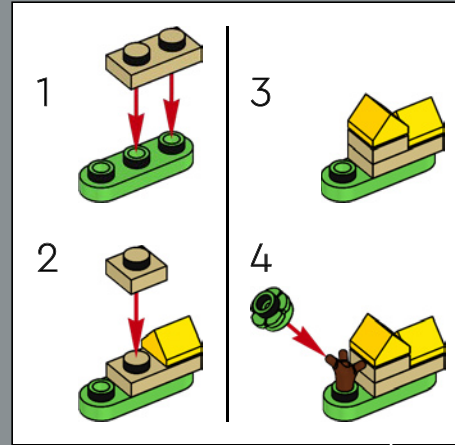



87

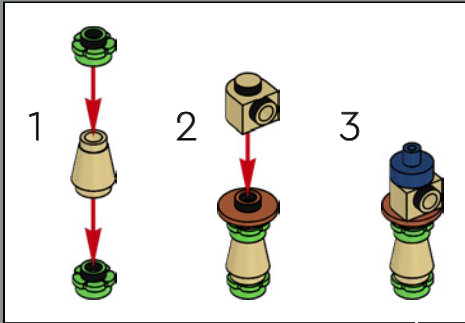

88



Stores are packed with toys and souvenirs.  
 Les boutiques regorgent de jouets et de souvenirs.  
 Las tiendas están repletas de juguetes y recuerdos.

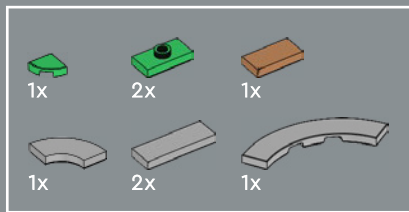

89



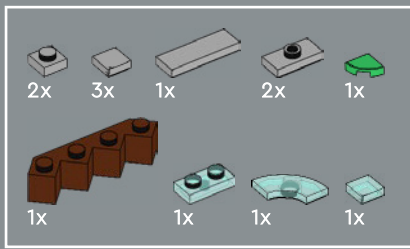

90



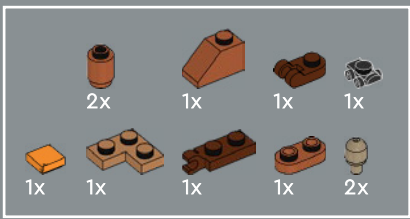

91

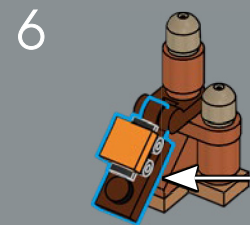
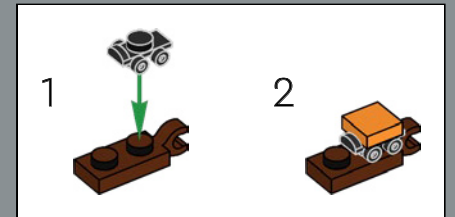
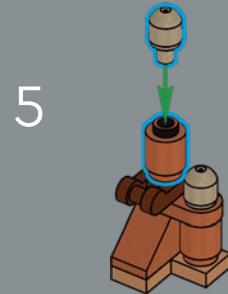
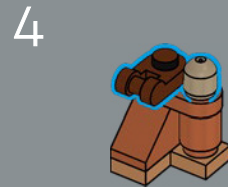
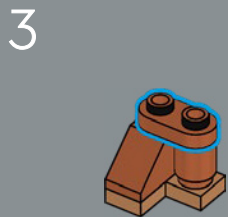
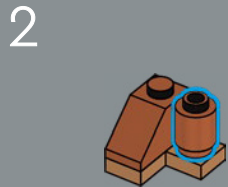
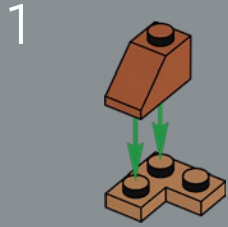



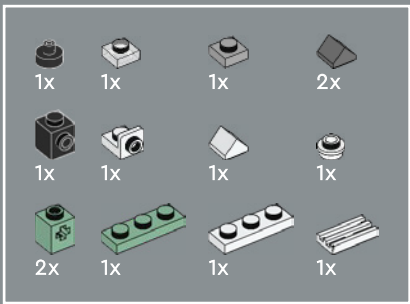

92

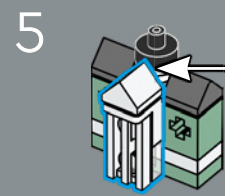
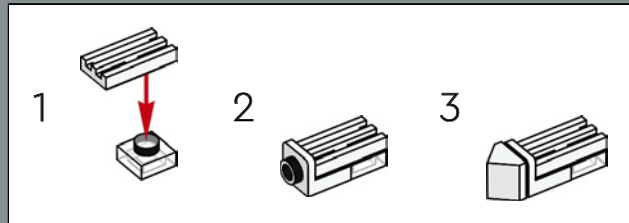
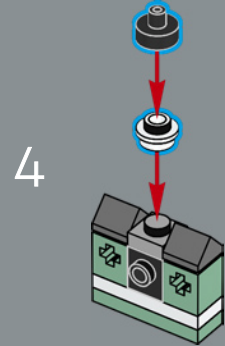
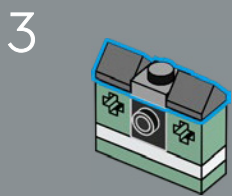
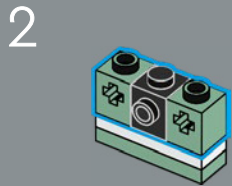
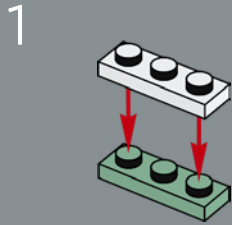





93

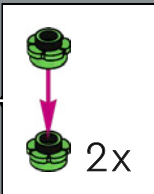

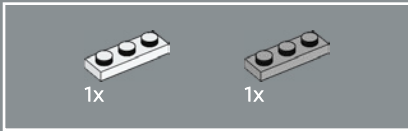

94

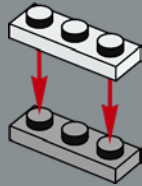

95

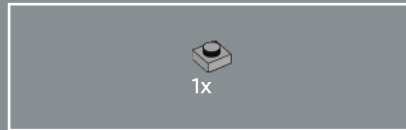
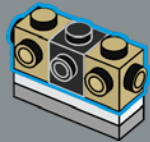

96

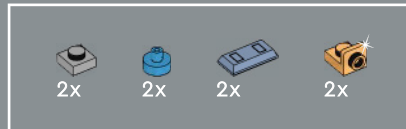
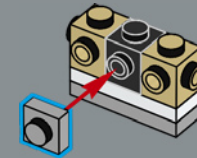

97

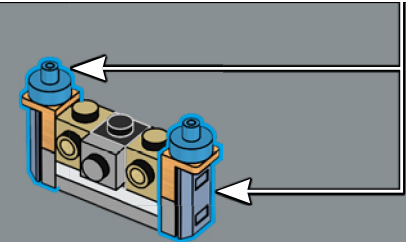
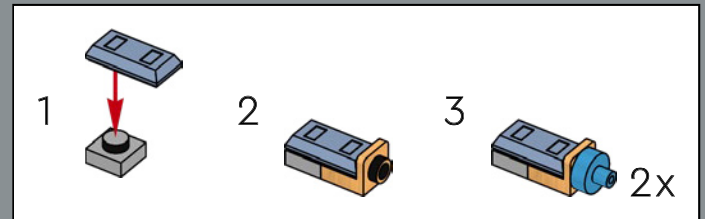



98

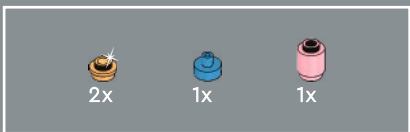
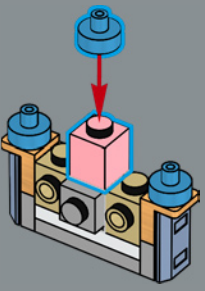

99

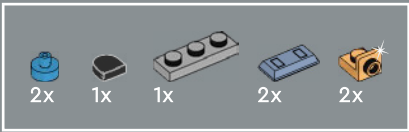
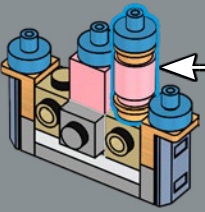
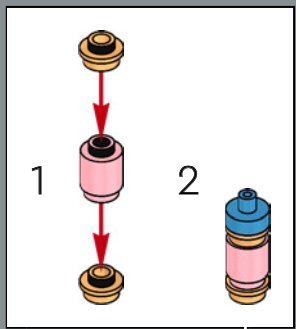

100

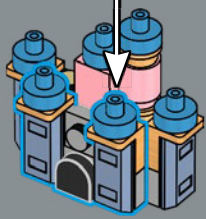
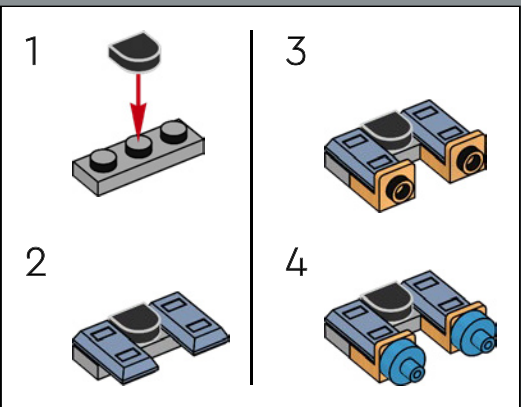



The famous Sleeping Beauty Castle, which was inspired by Neuschwanstein Castle in Bavaria, opened in 1955 along with the first park, and has become an icon of the Disney brand globally.

Le château emblématique de la Belle au bois dormant, inspiré du château de Neuschwanstein en Bavière, a ouvert ses portes en 1955 avec le tout premier parc Disney. Il est depuis devenu un symbole universel de la marque.

Inspirado en el Castillo de Neuschwanstein de Baviera (Alemania), el famoso Castillo de la Bella Durmiente abrió sus puertas en 1955 junto con el primer parque y se ha convertido en un icono global de la marca Disney.

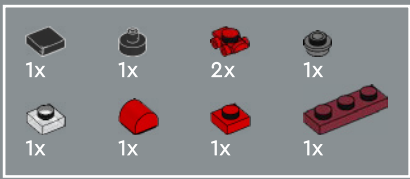

102

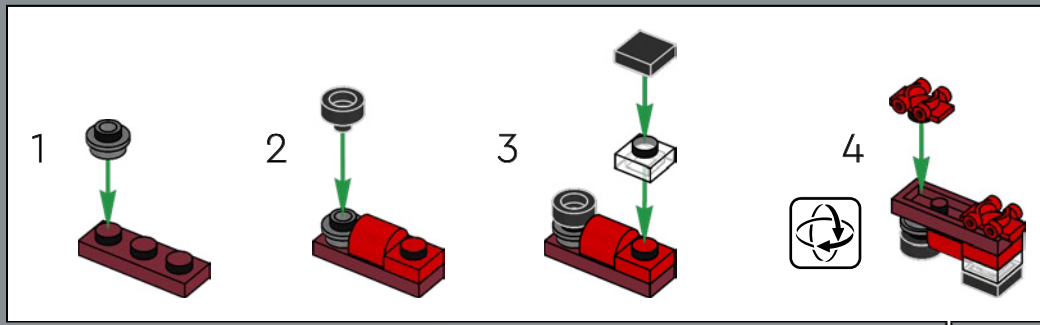

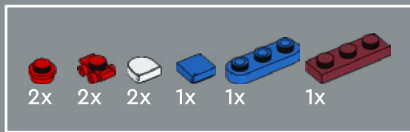

103

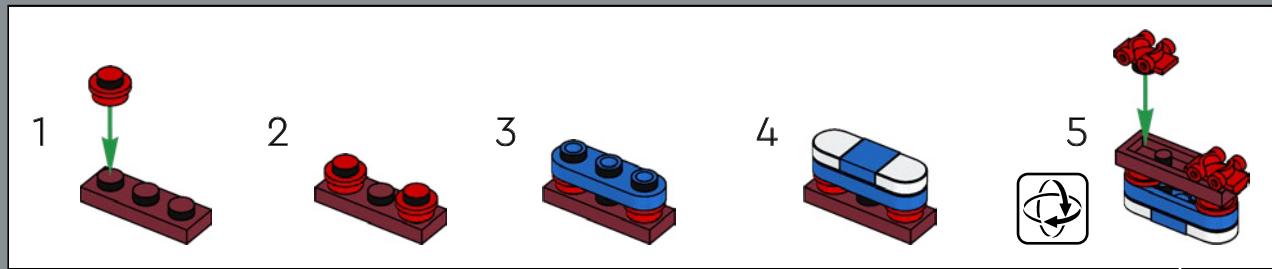

The Railroad was inspired by Walt Disney's lifelong love of trains.

Le chemin de fer du parc rend hommage à la passion de toujours de Walt Disney pour les trains.

La pasión que Walt Disney sintió toda su vida por los trenes inspiró el ferrocarril.



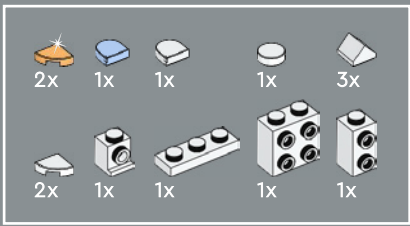

# 104

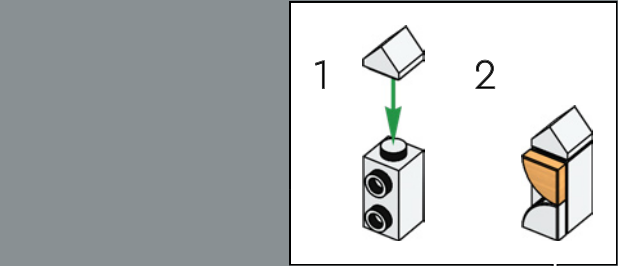
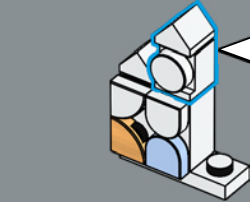
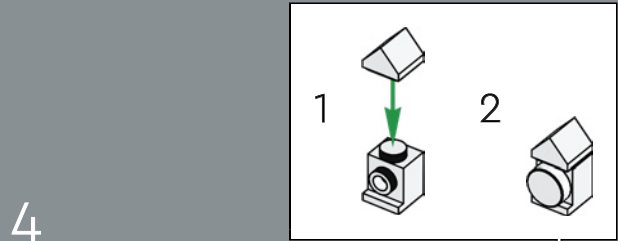
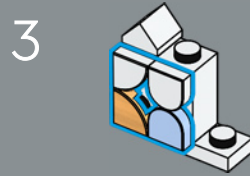
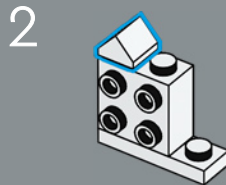
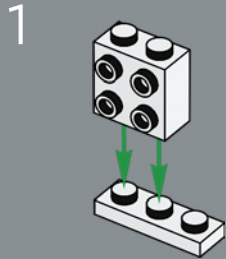



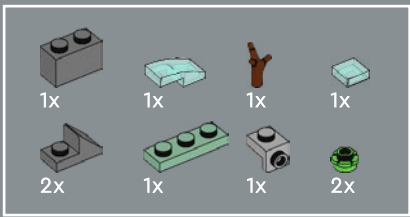

105

1

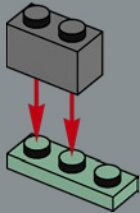

2

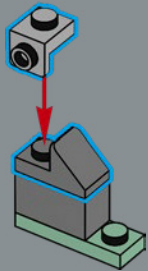

3

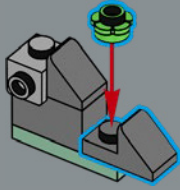

4

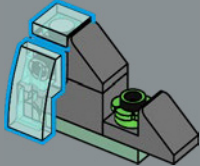

5

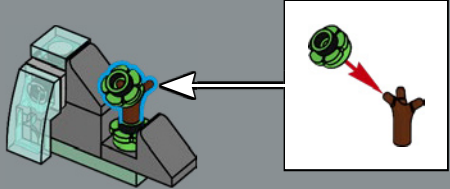



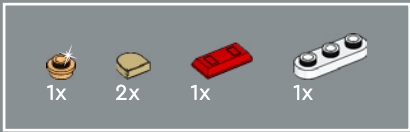

106

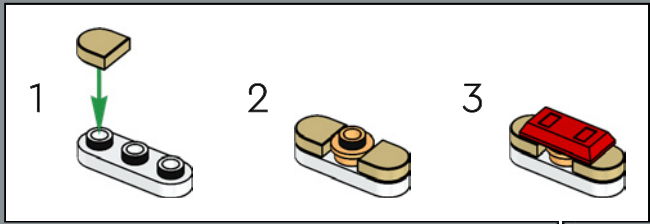

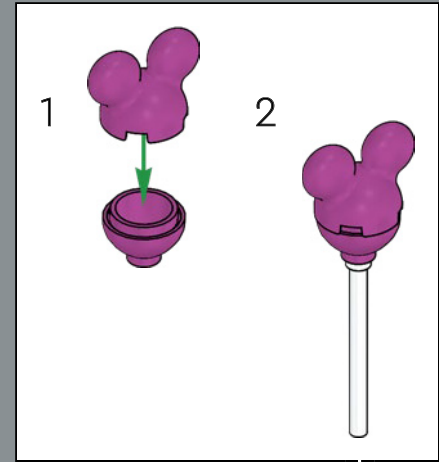
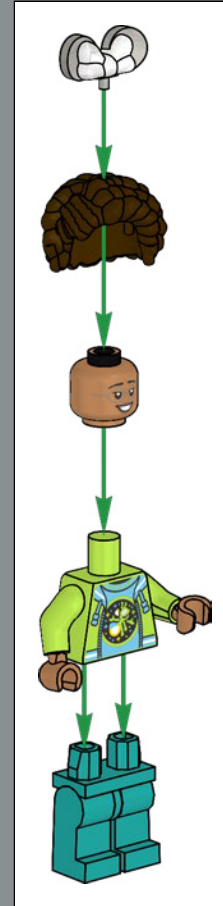

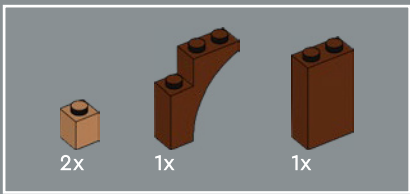

107

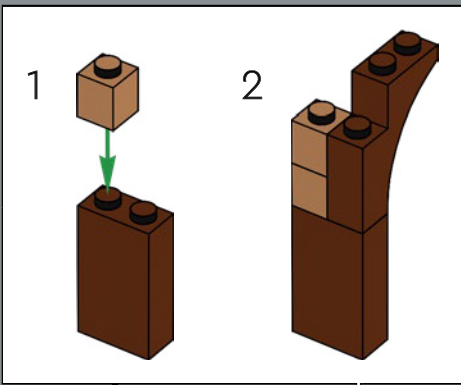

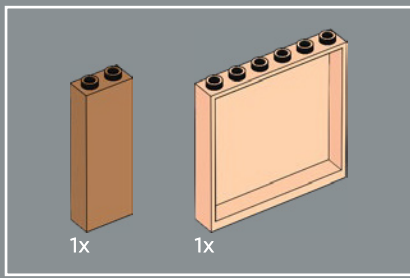

108



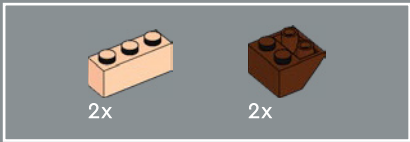

109



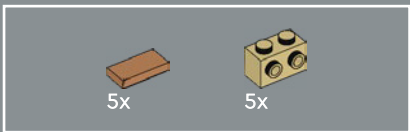

110

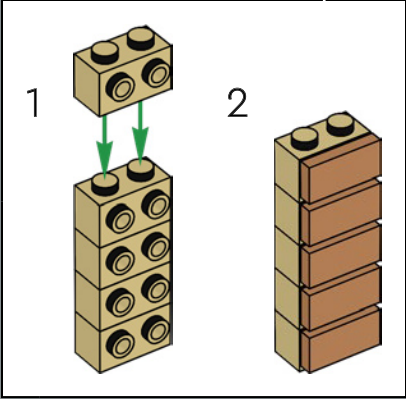

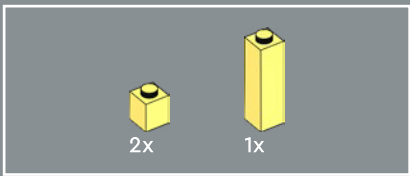

111

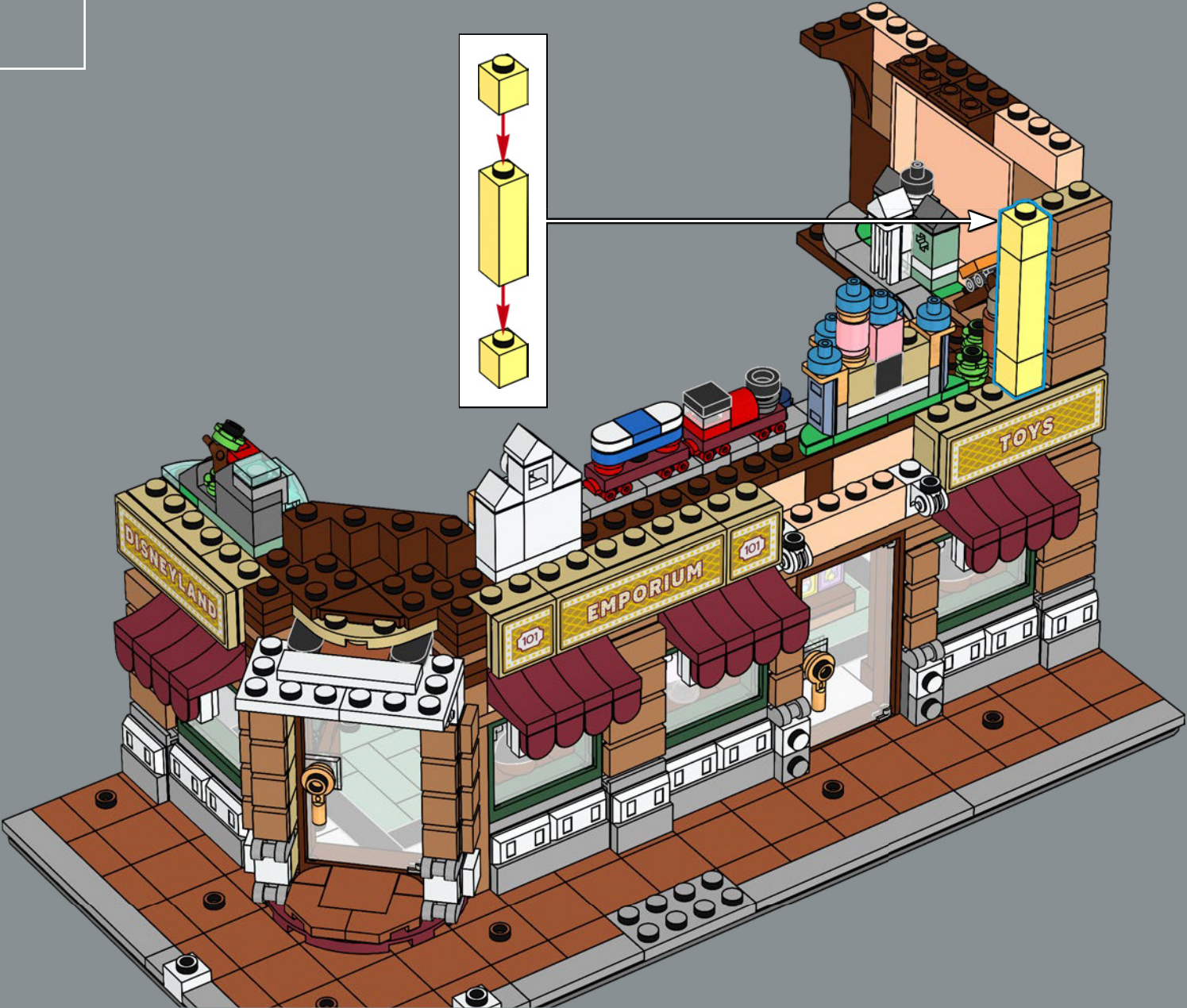
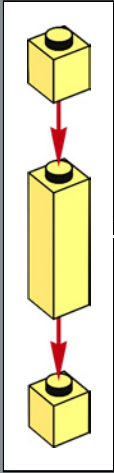

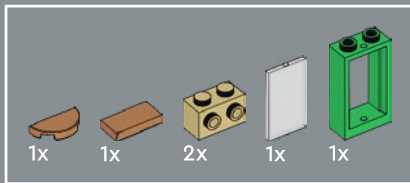

112

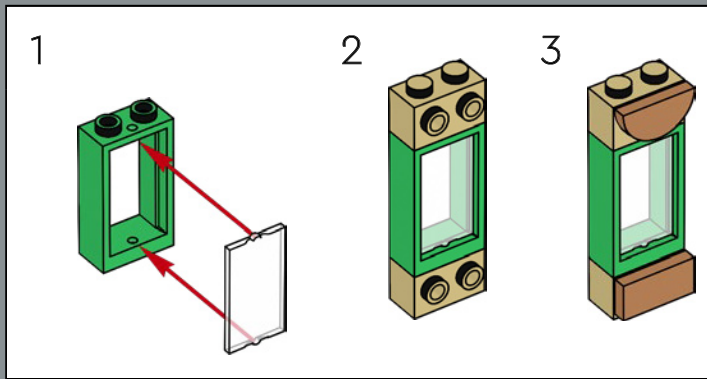

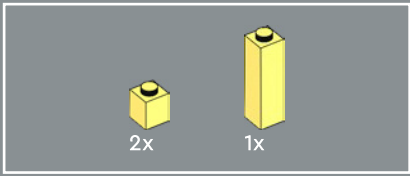

113

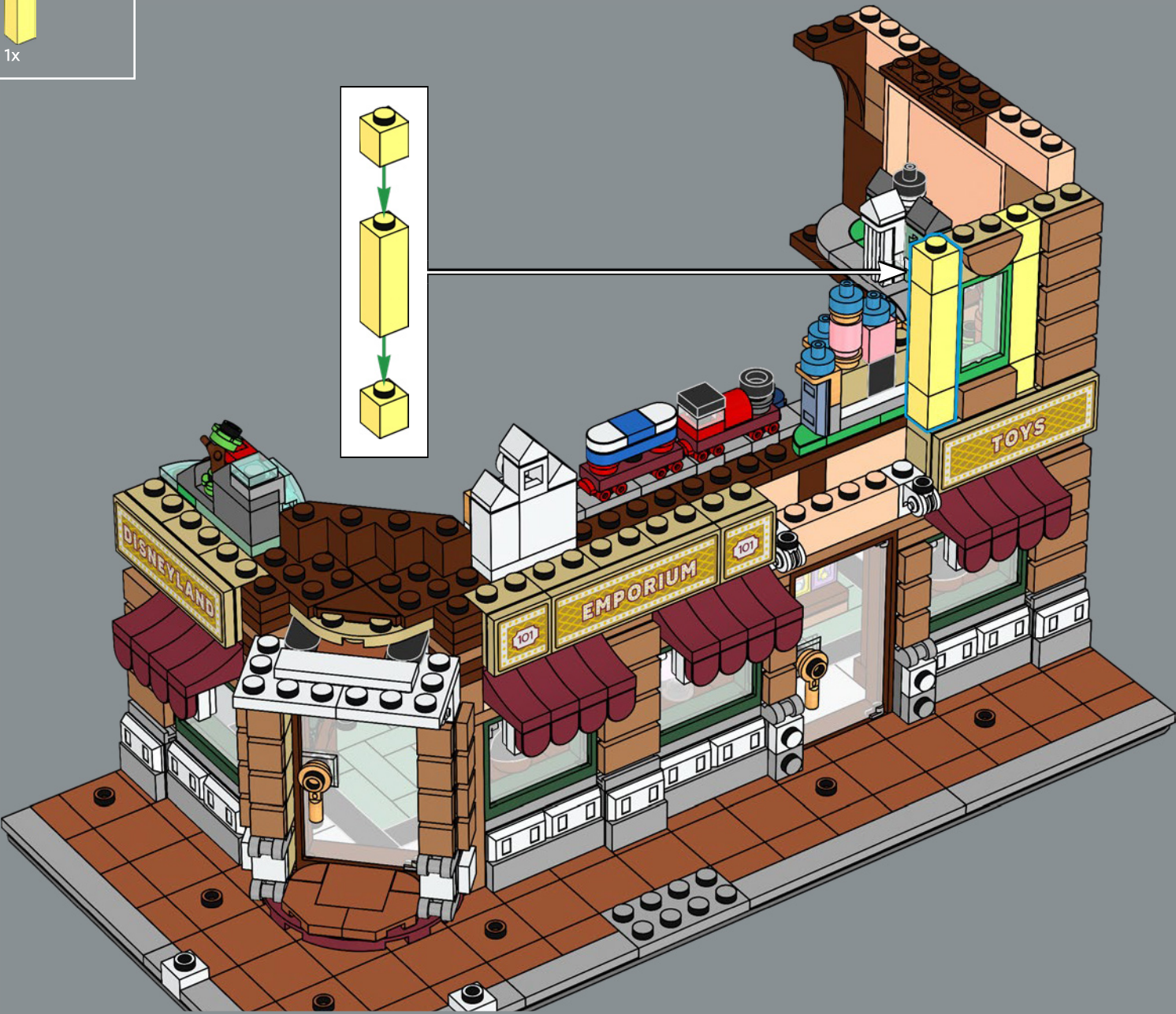
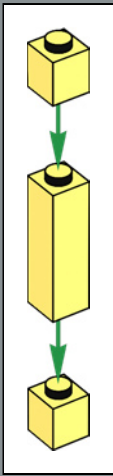

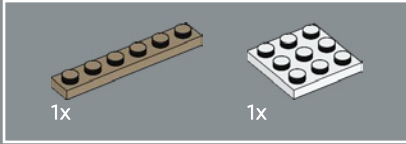
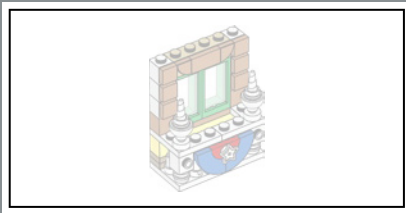

114

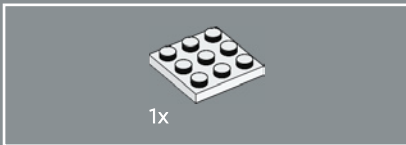
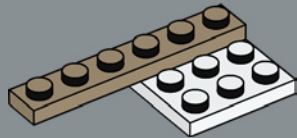

115

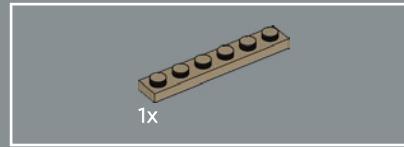
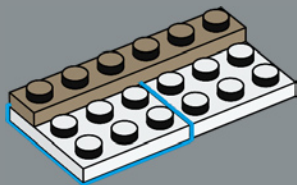

116

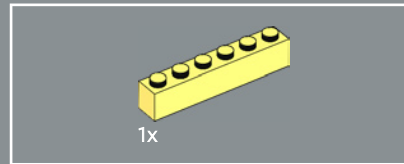
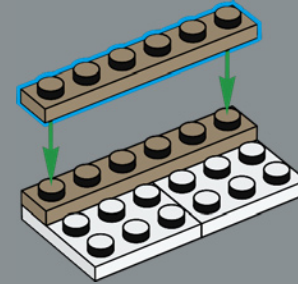

117

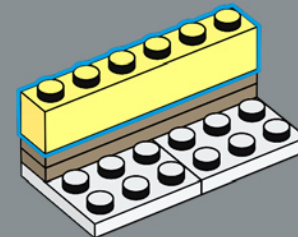

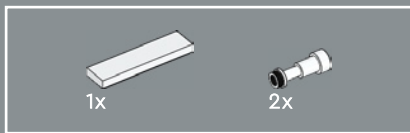

118

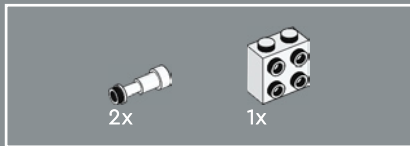
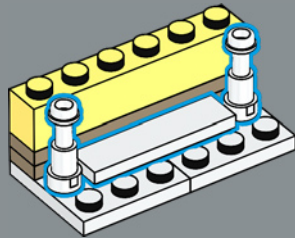

119

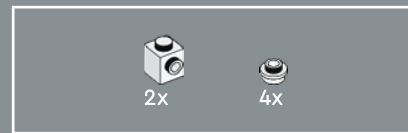
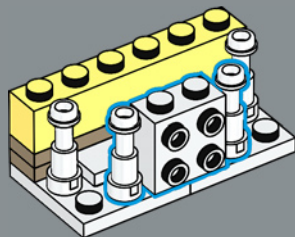

120

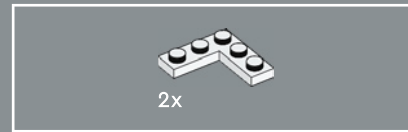
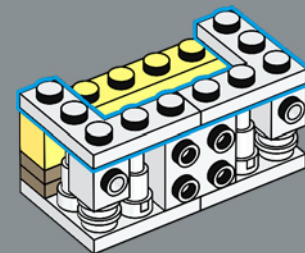
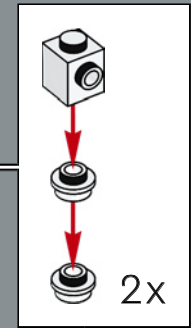
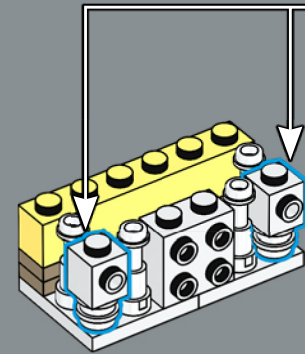

121

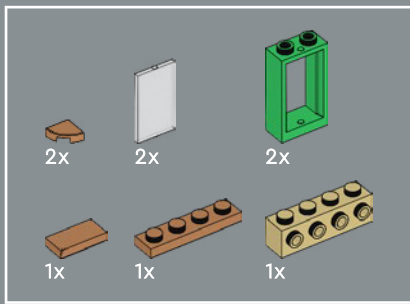

122

1

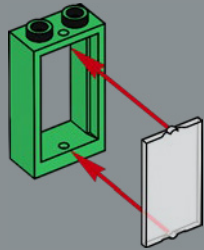

2

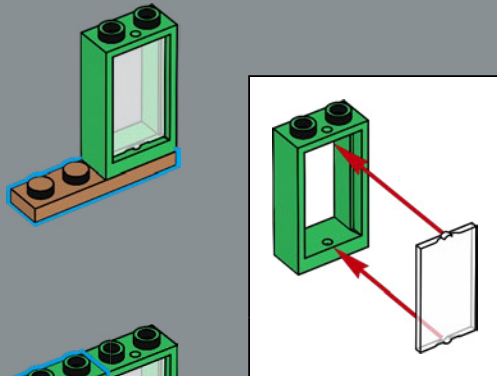

3

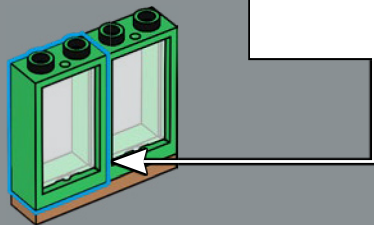

4

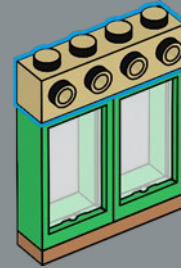

5

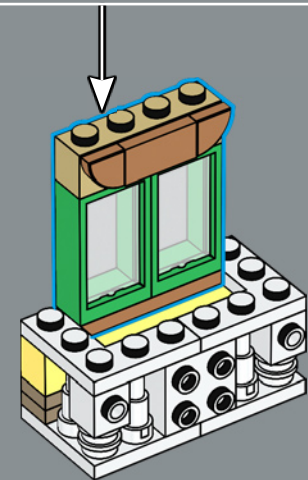
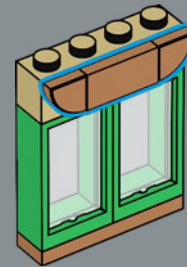



123

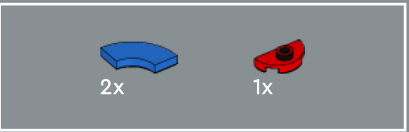
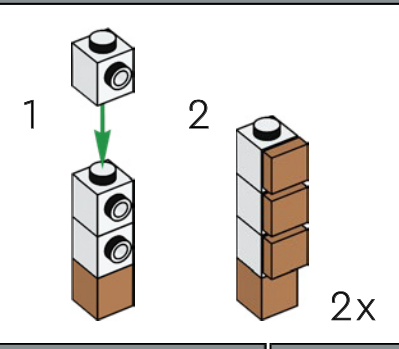
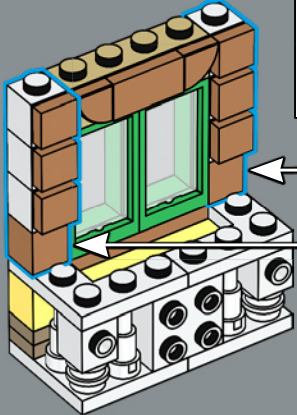

125



124

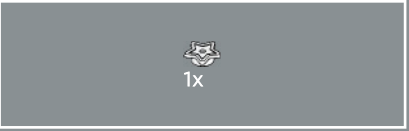
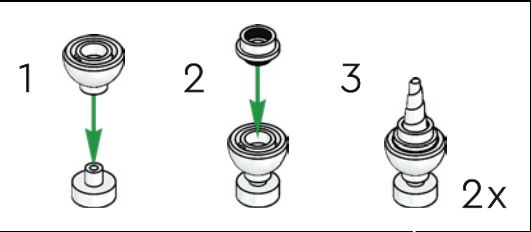
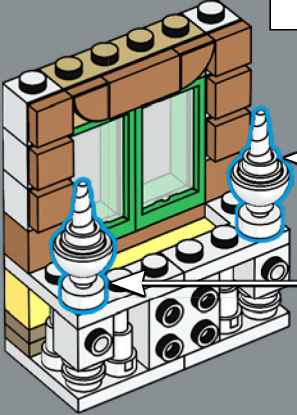

126







128

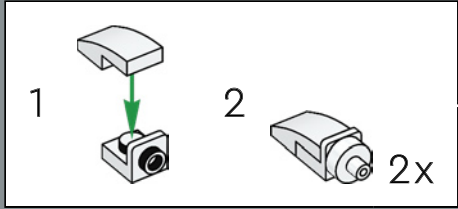

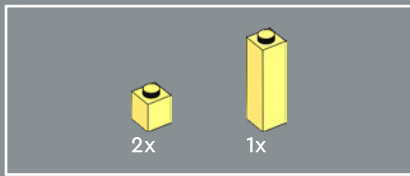

129

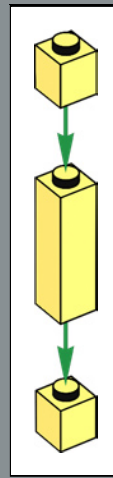

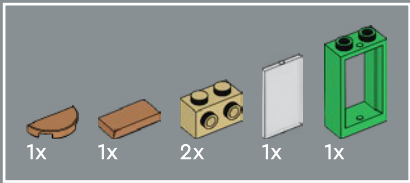

130

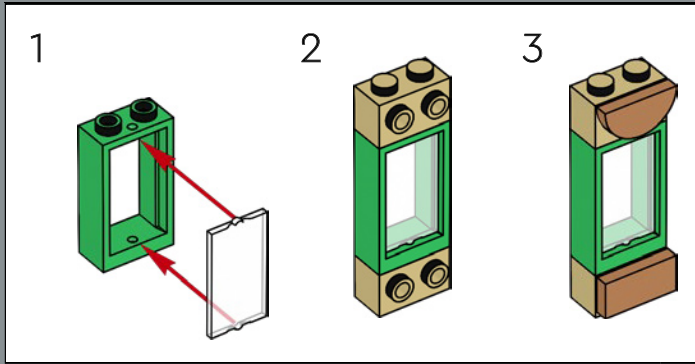

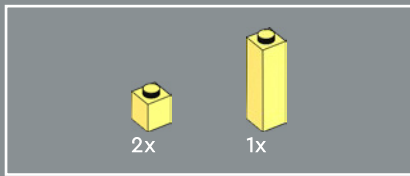

131

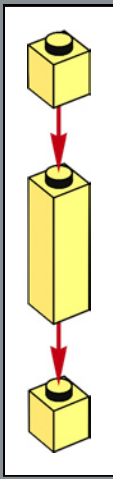

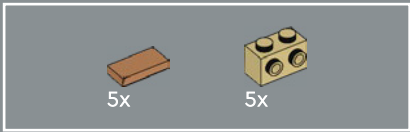

132

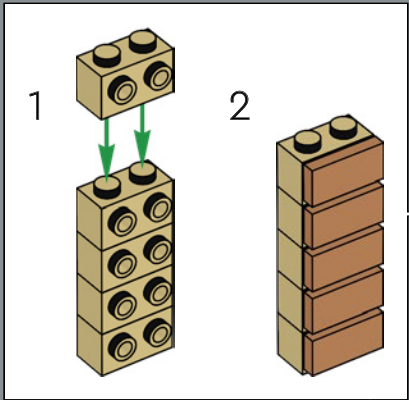

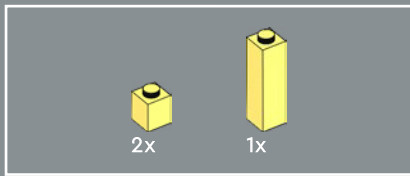

133

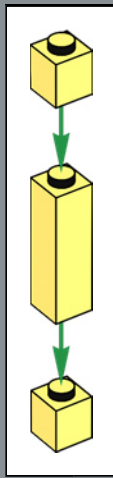

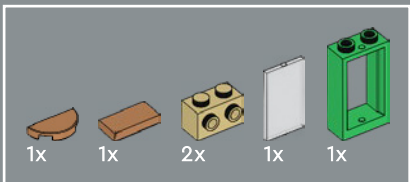

134

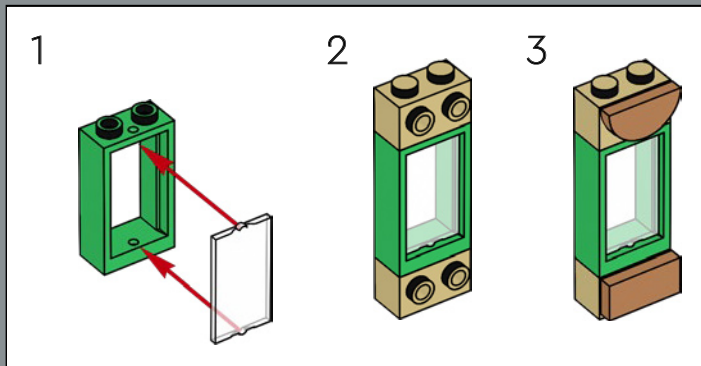

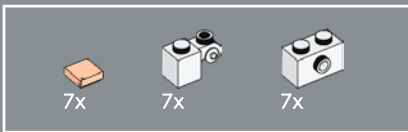

135

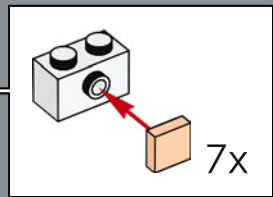

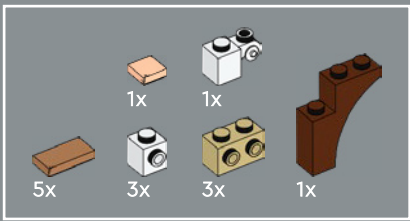

136

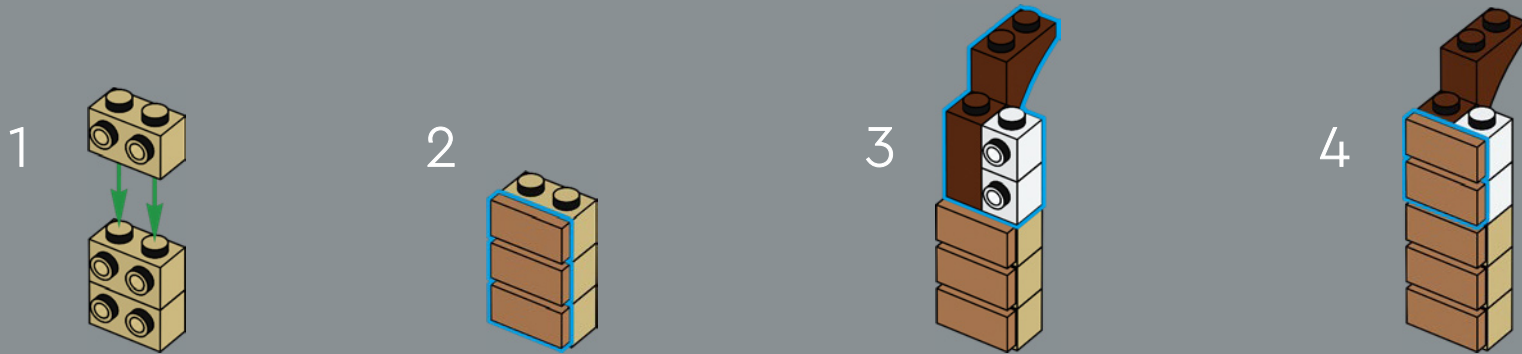

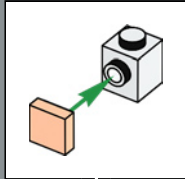

5

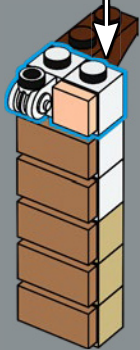

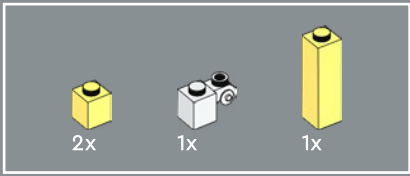

137

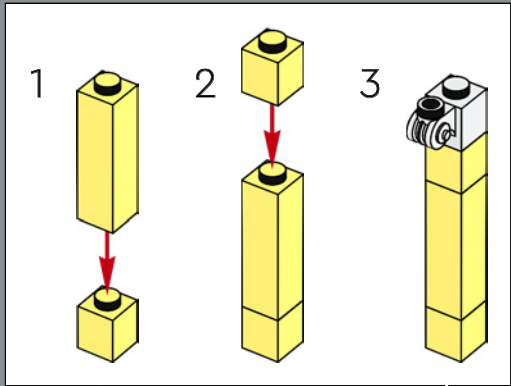

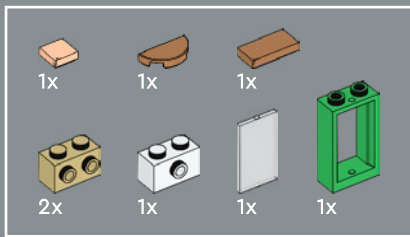

138

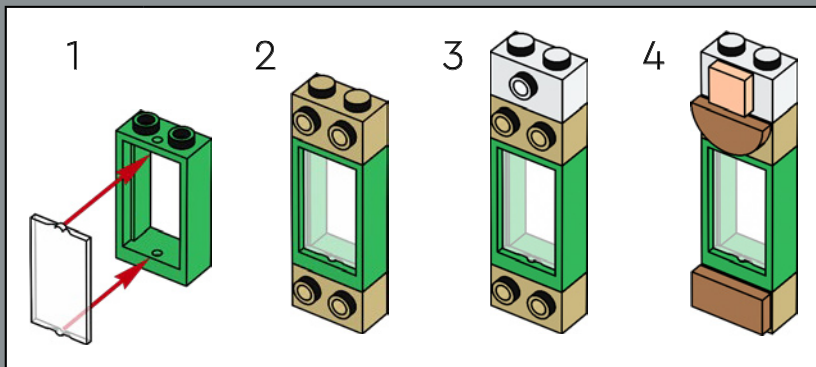



2x

139



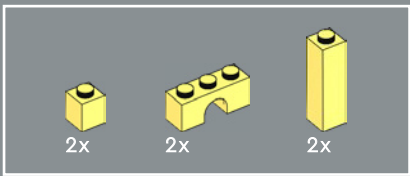

140

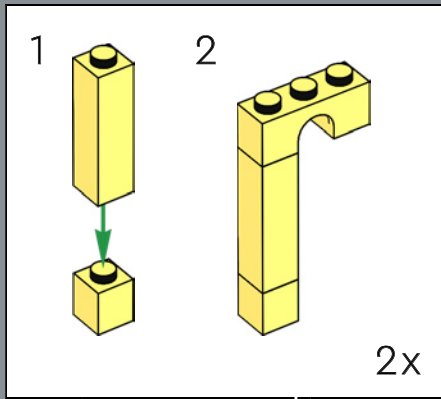

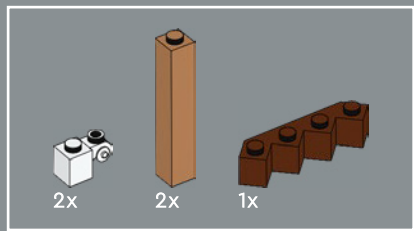

141





2x

142



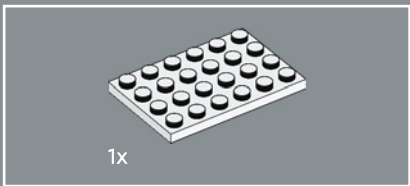

143



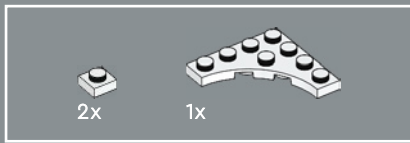

144



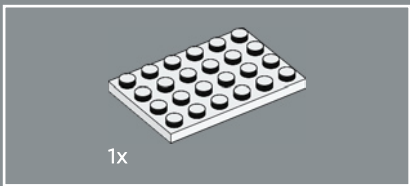

145



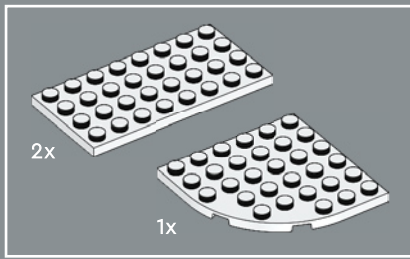

146



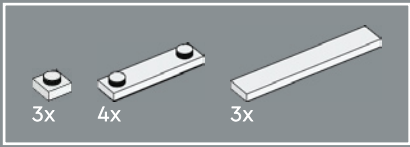

147



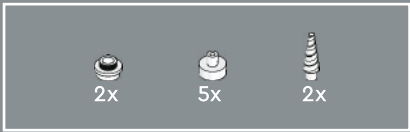

148

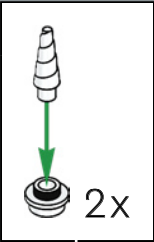



2x

149



2x



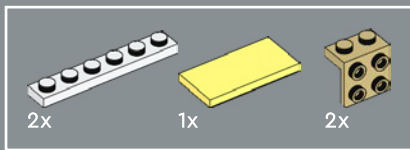

150

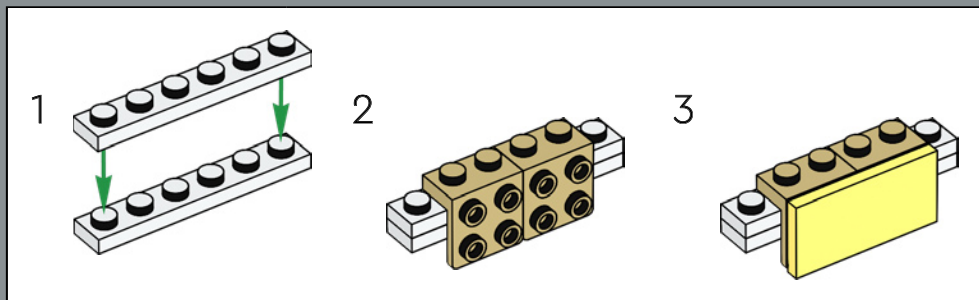



151

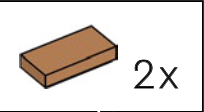

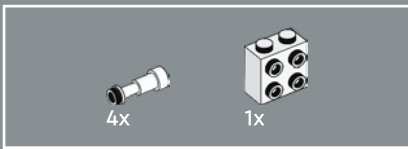

152





153

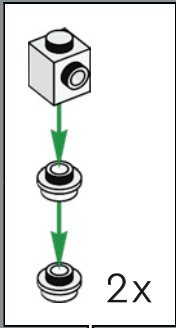

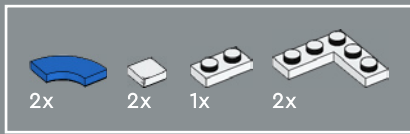

154





1x



1x

155





156

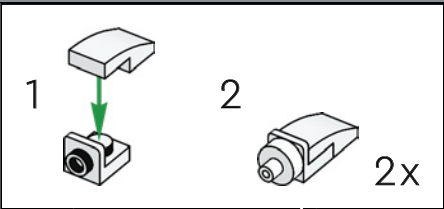

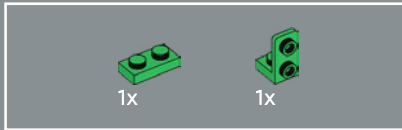

157

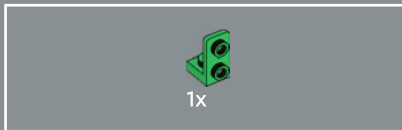
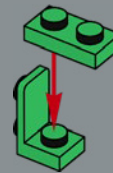

158

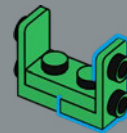



159

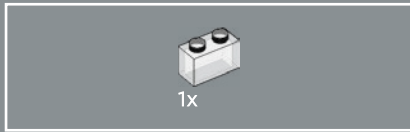
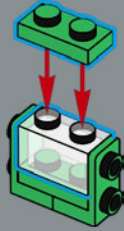

160

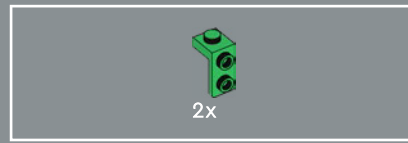

161

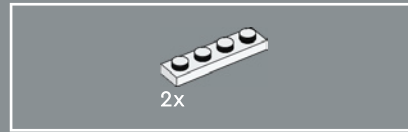
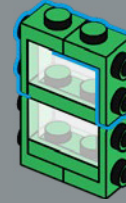

162

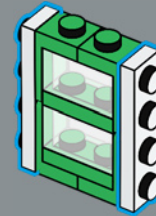

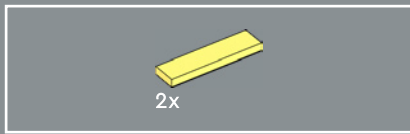

163

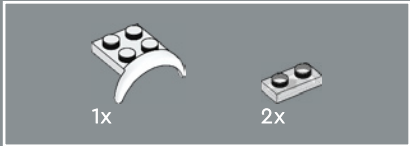
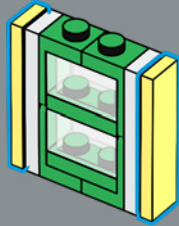

164

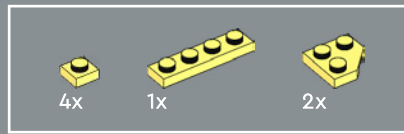
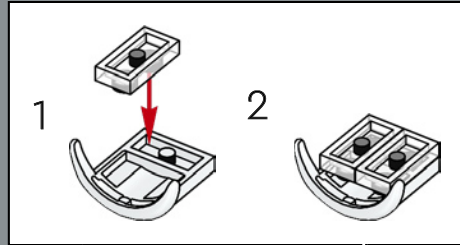

165

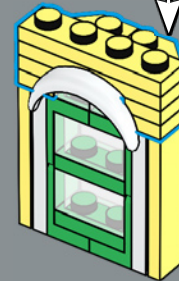
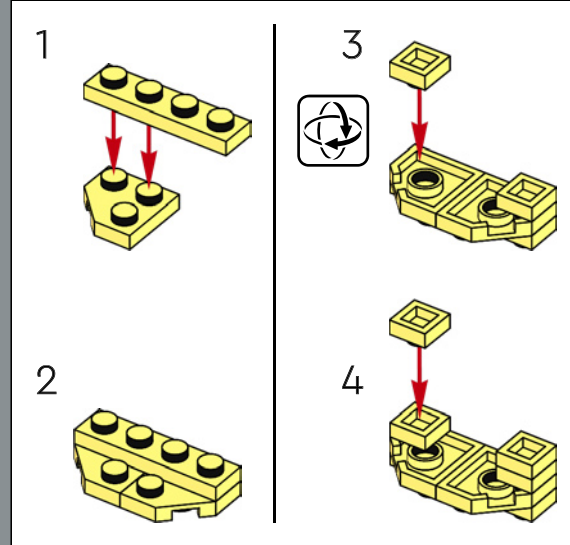





2x



2x

167

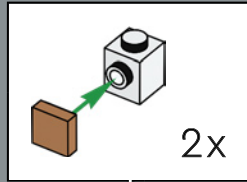



6x



12x

168

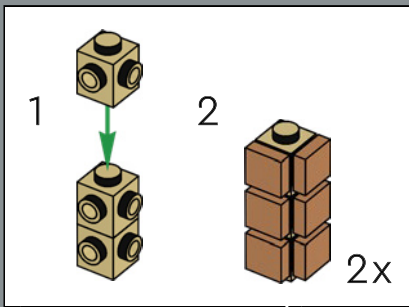



169

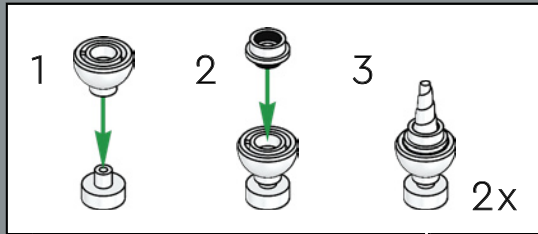



2x

170



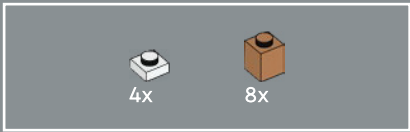

171

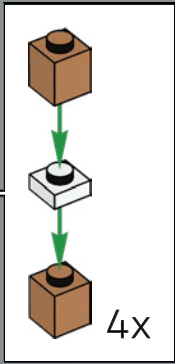



2x

172



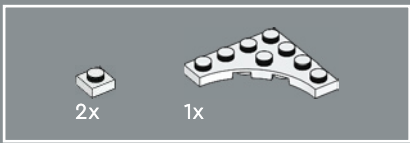

173



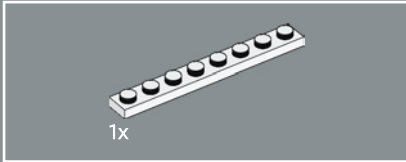
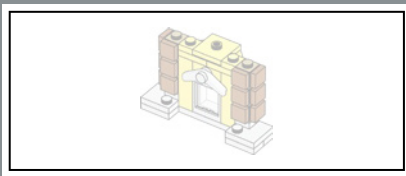

174

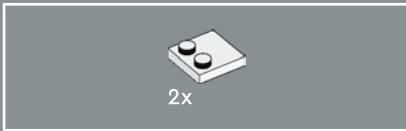
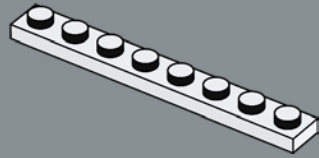

175

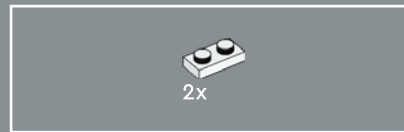
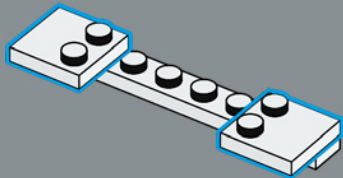

176

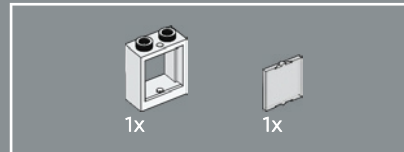
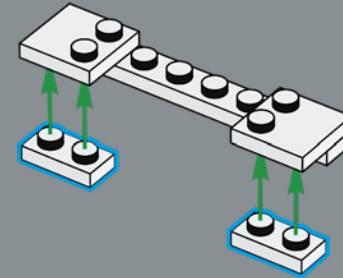

177

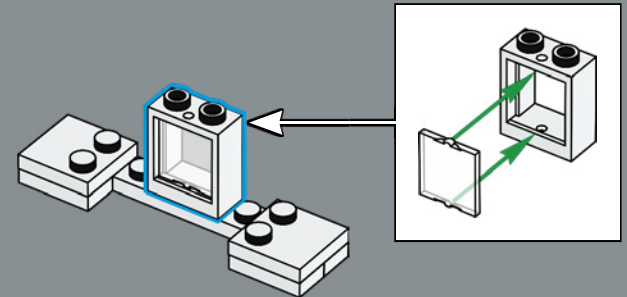

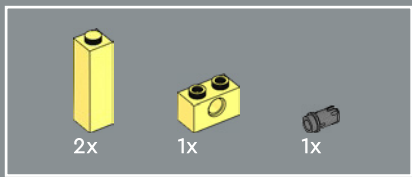

178

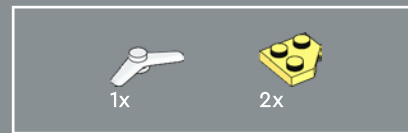
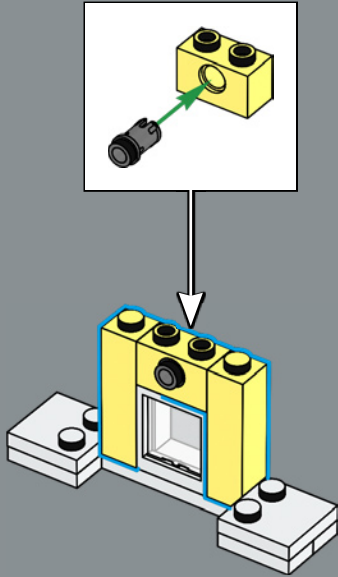

179

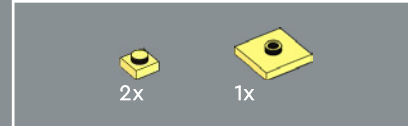
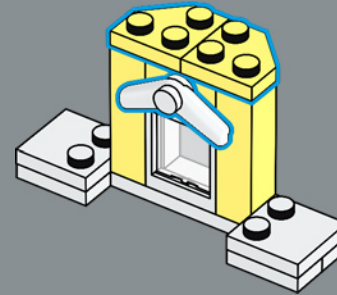

180

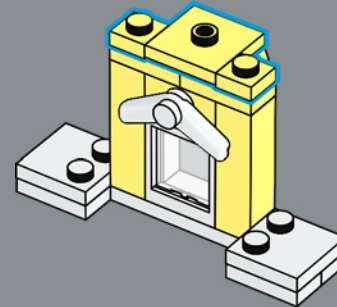

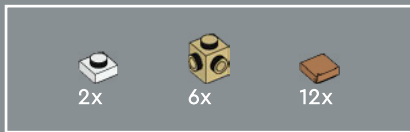

181

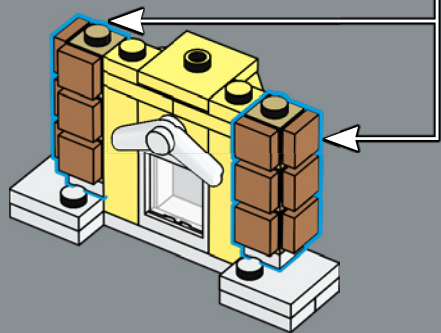
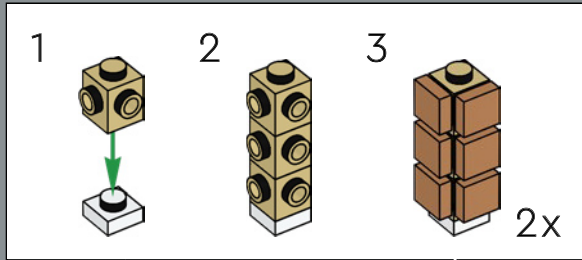

182





183



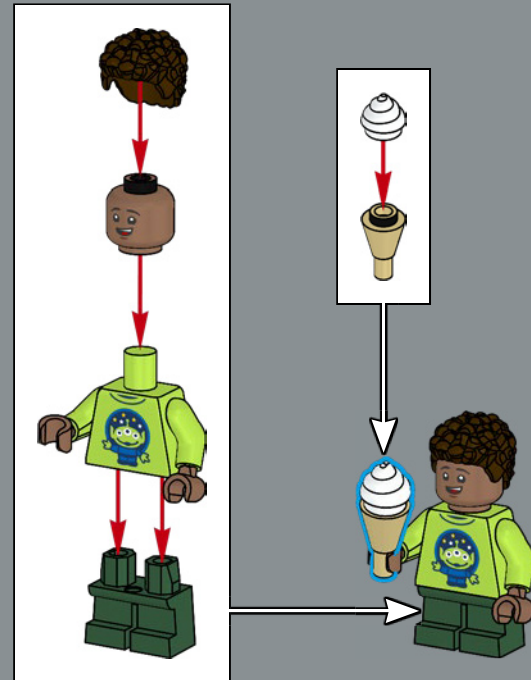

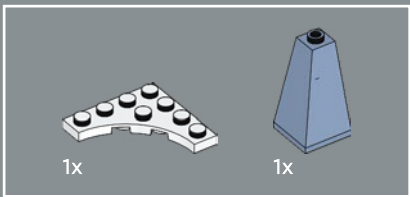

184



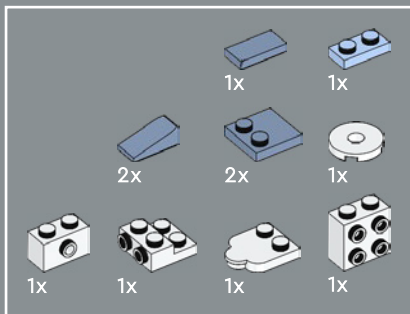

185

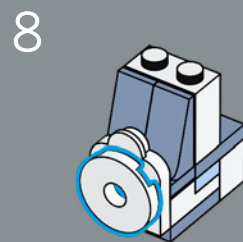
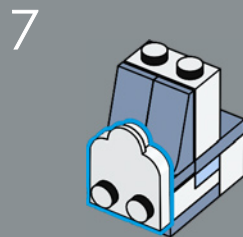
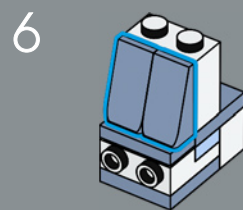
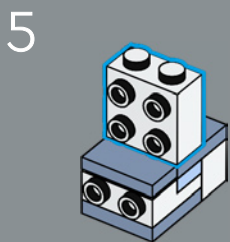
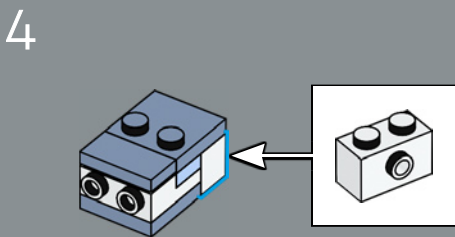
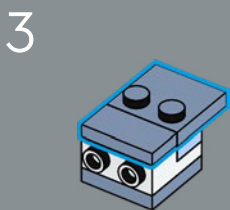
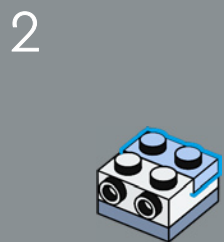
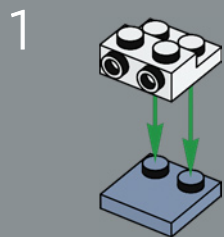

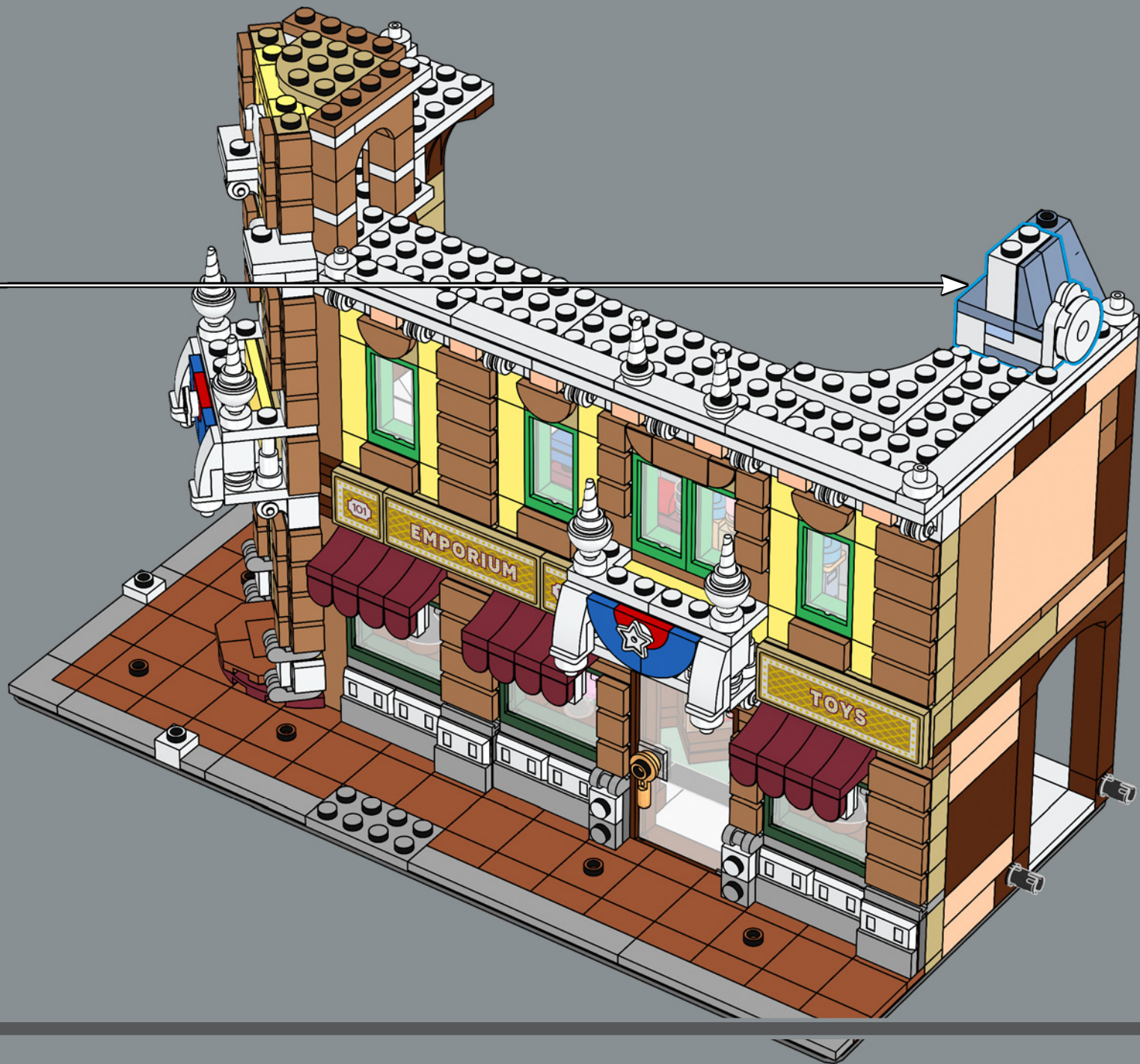

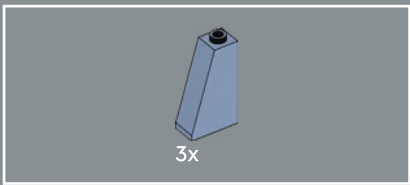

186

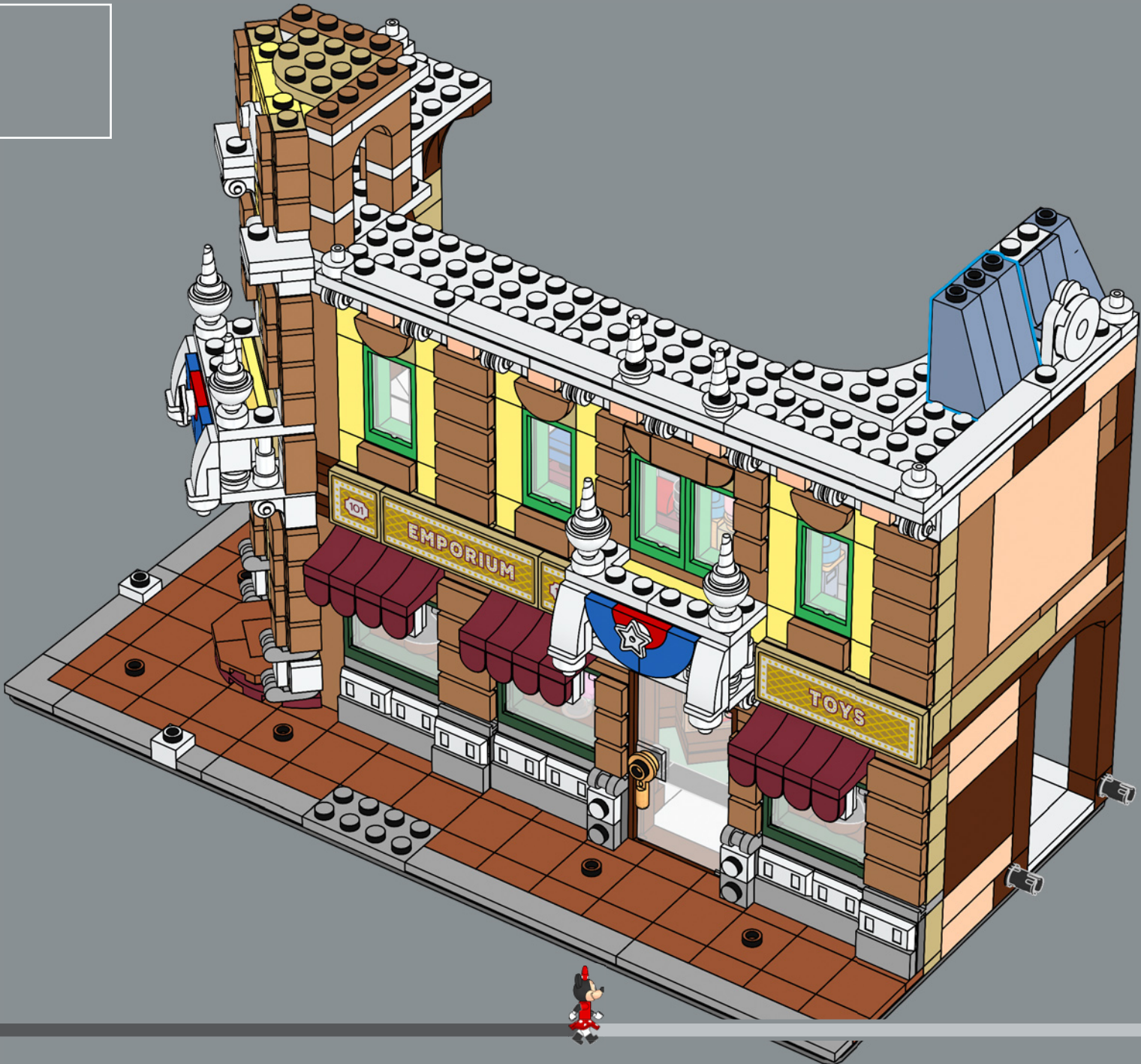



2x



2x



4x



2x



4x



2x



2x



2x

187

1

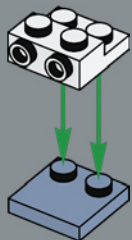

2



3

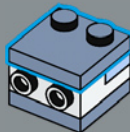

4

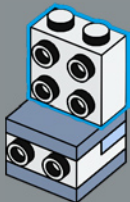

5



6



7

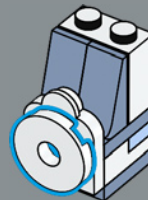

2x

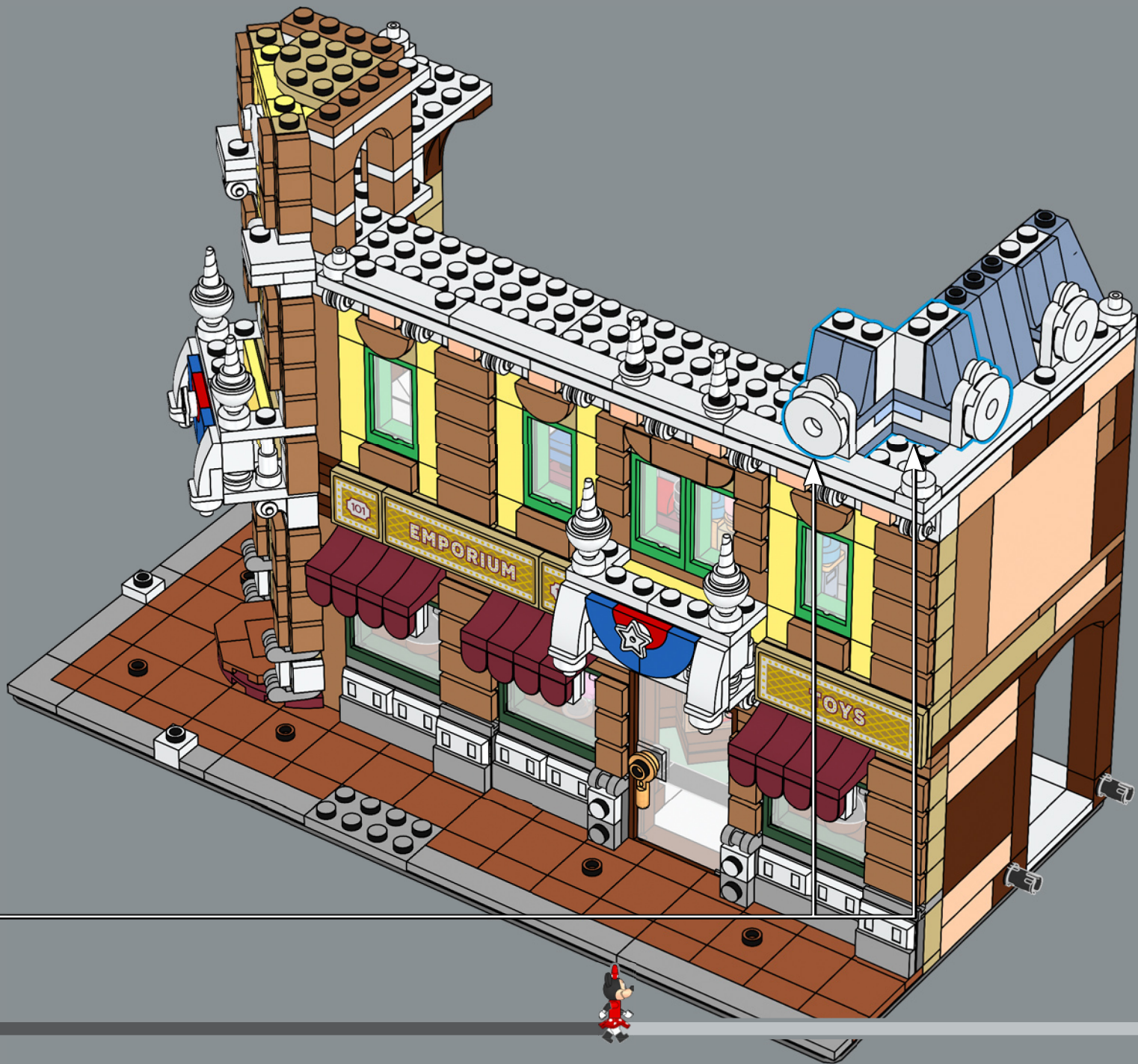

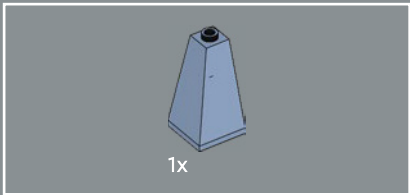

188



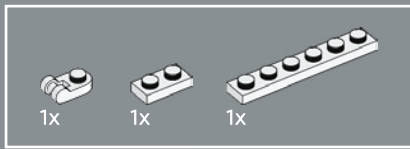

189

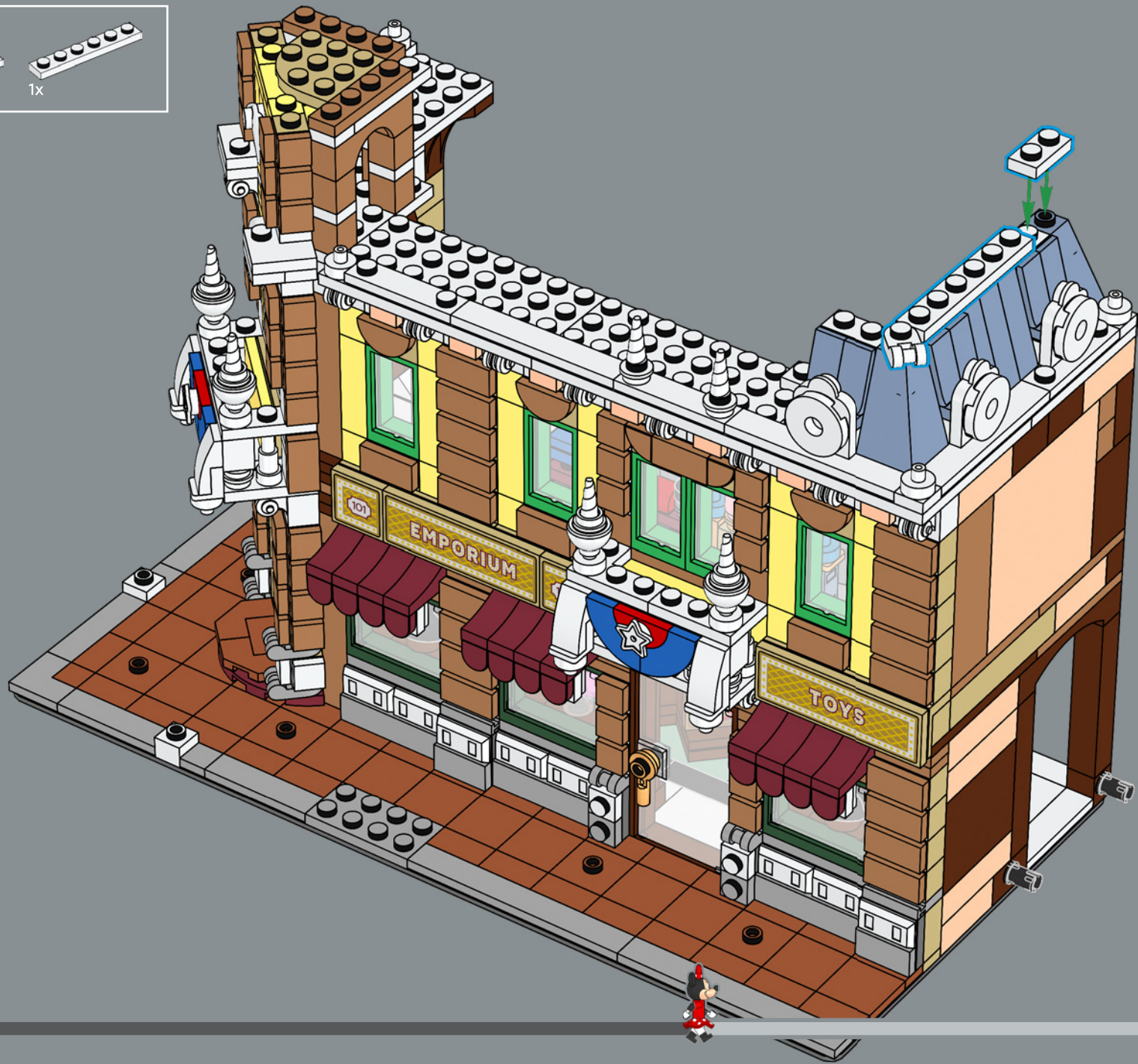

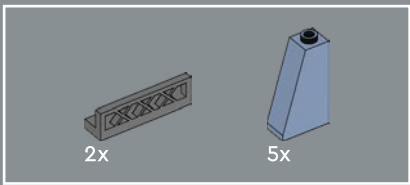

190



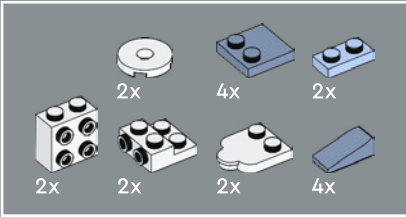
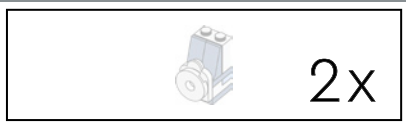

191

1

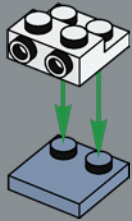

2



3

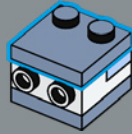

4

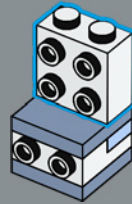

5

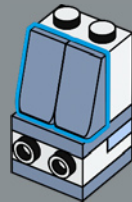

6



7

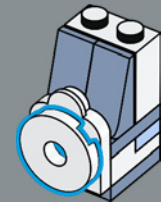

2x





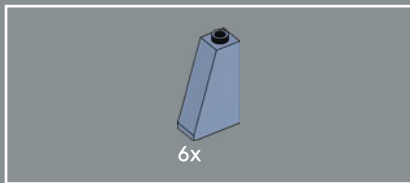

192



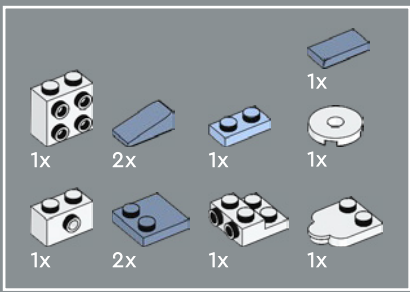

193

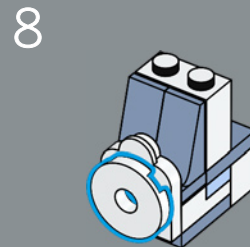
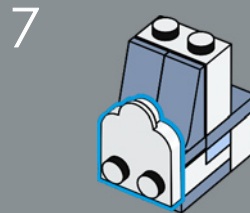
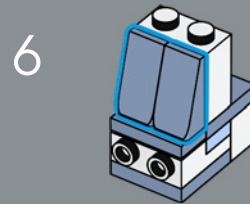
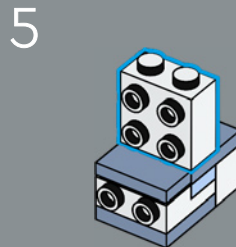
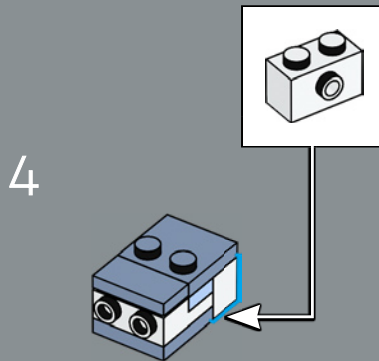
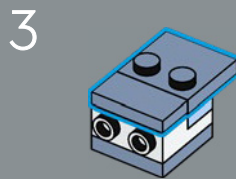
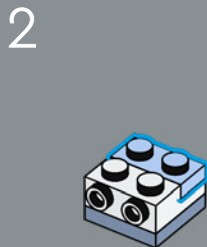
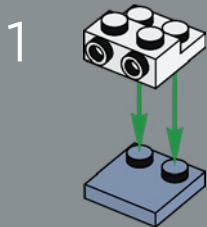

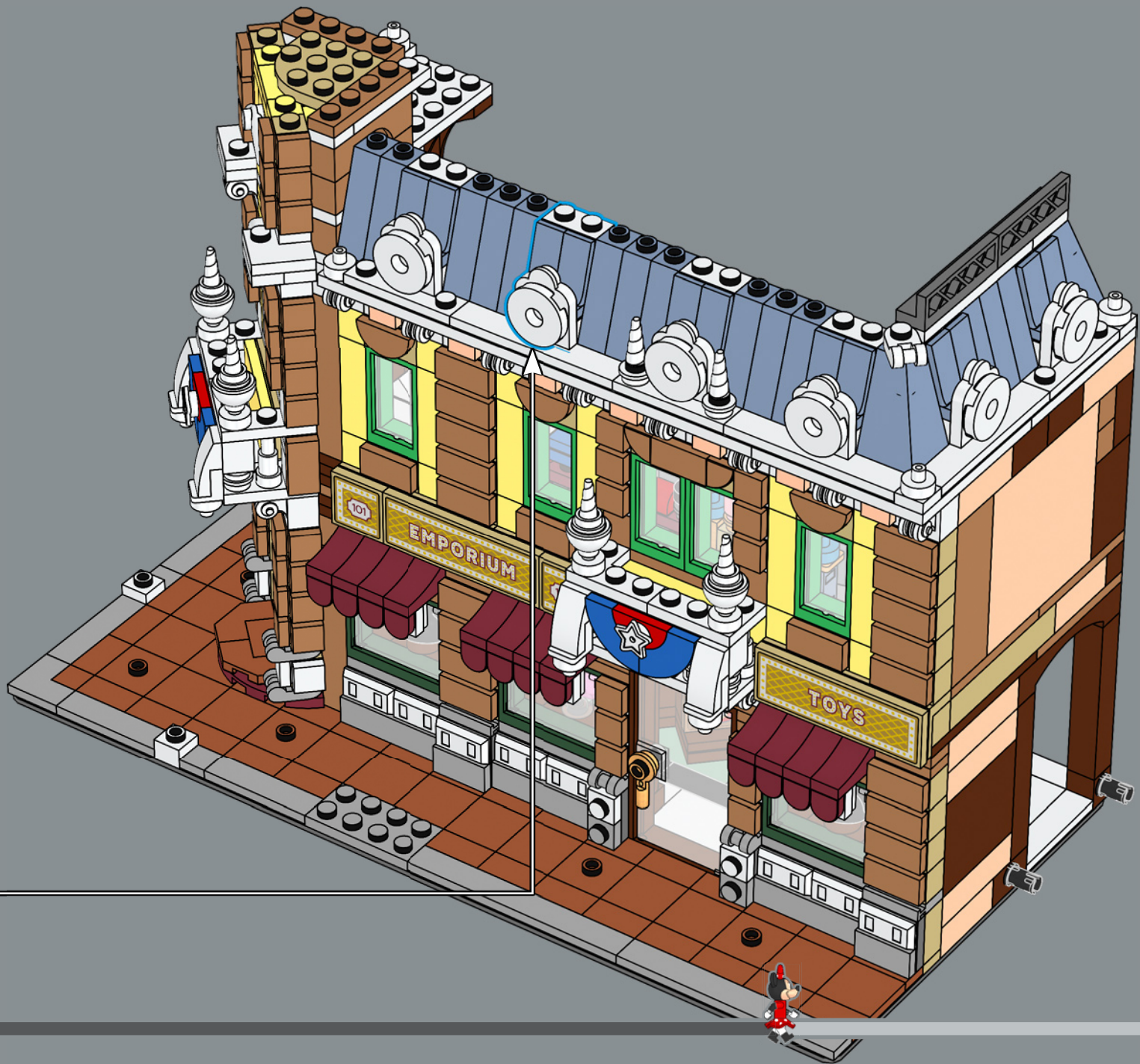

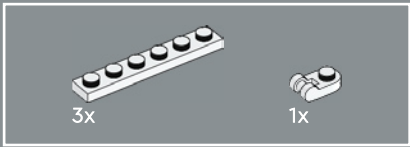

194

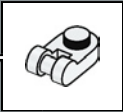

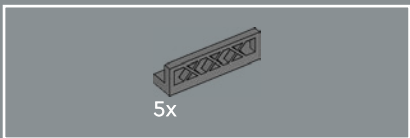

195





2x

196



2x

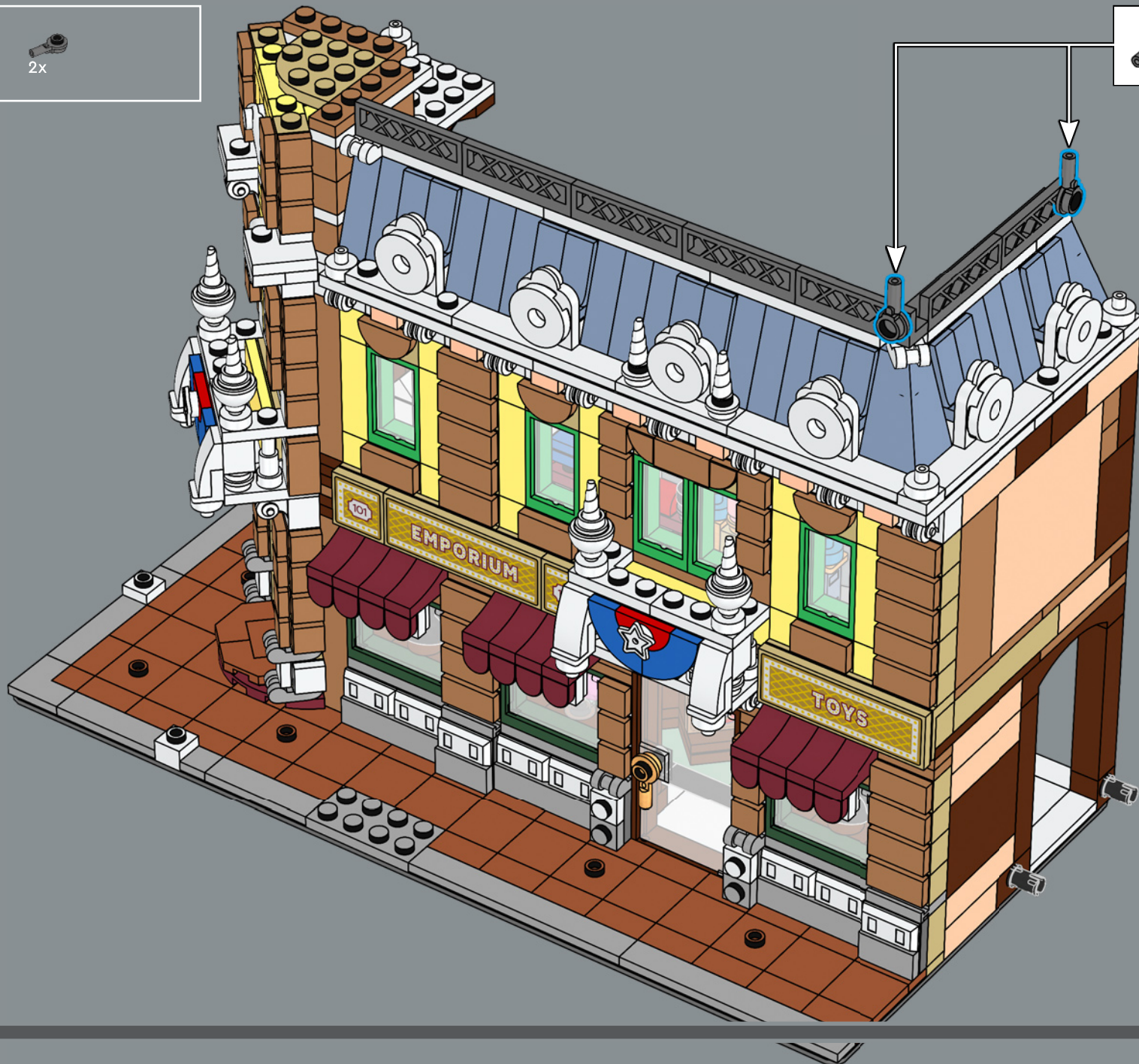

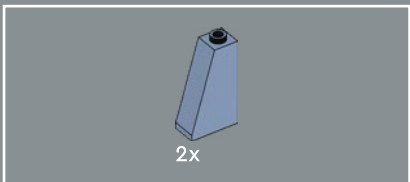

197



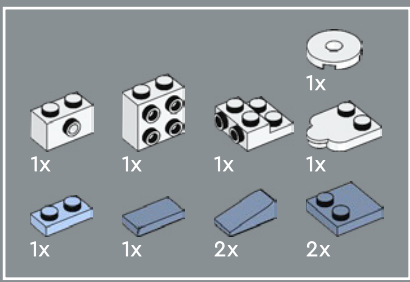

198

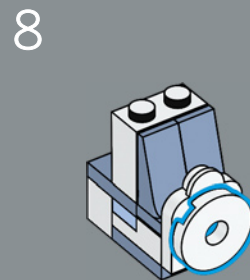
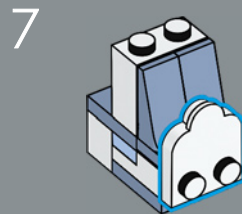
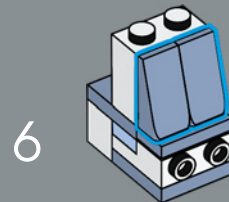
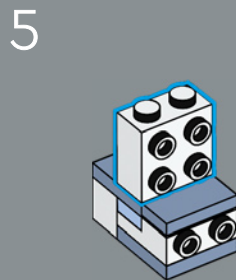
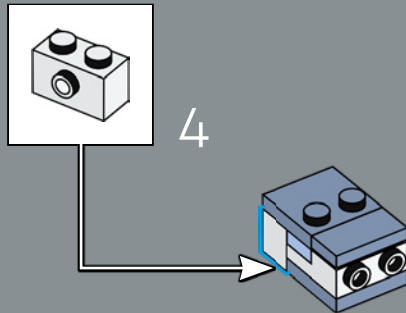
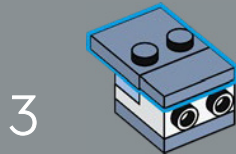
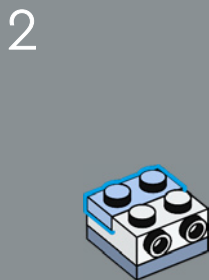
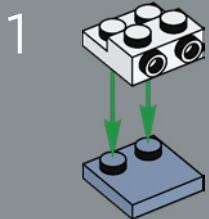



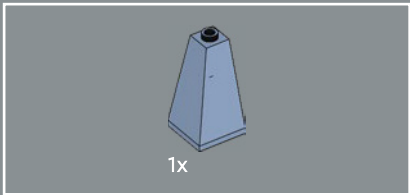

199





200



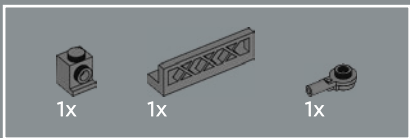

201

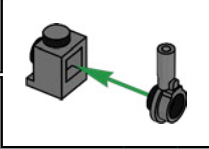



3x



3x

202

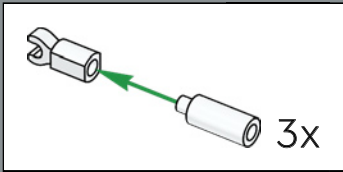

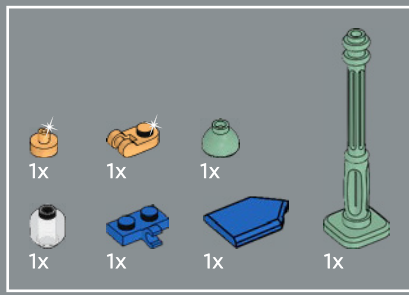

203

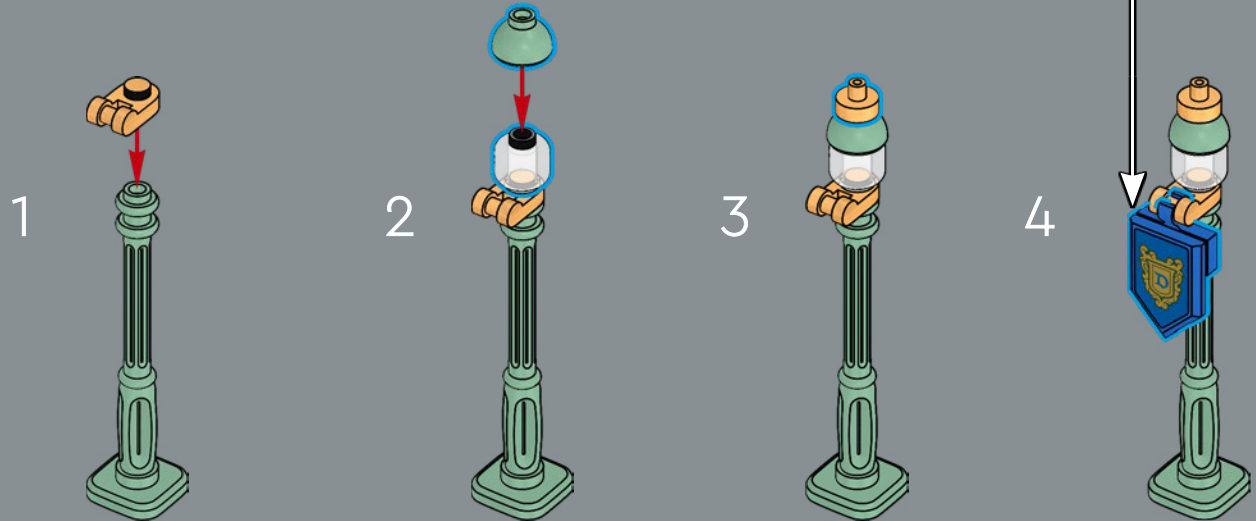
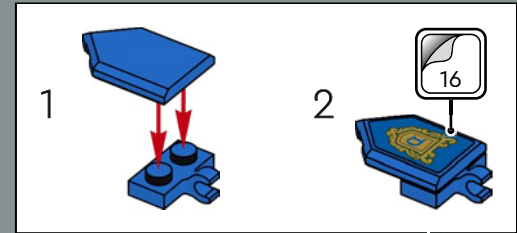



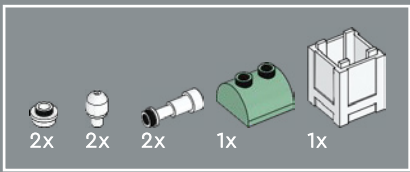

204

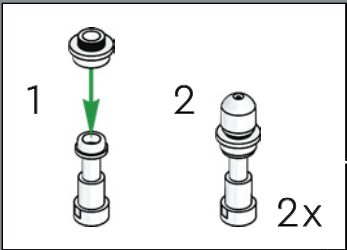
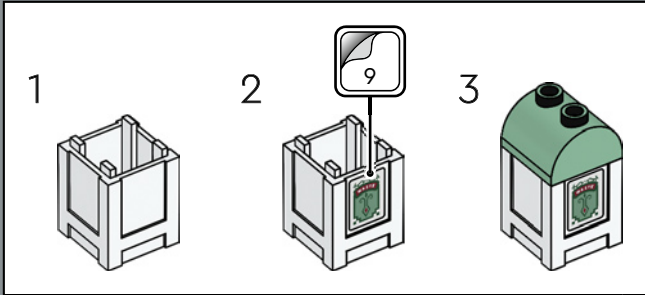

Main Street, U.S.A. features a horse-drawn streetcar that guests can ride. Along the street, you can still find hitching posts that would have been used back in the day to secure horses.

Disney Main Street comprend aussi un tramway tiré par des chevaux, que les visiteurs peuvent encore emprunter. On y aperçoit toujours des poteaux d'attache utilisés à l'époque pour y attacher les chevaux.

Main Street, U.S.A. cuenta con un tranvía impulsado por caballos en el que los visitantes pueden tomar un paseo. A lo largo del pasaje, todavía pueden verse los postes para atar caballos que antiguamente se usaban para sujetar a los animales.

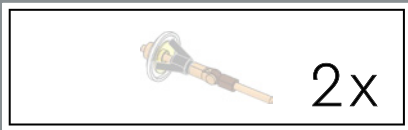

205

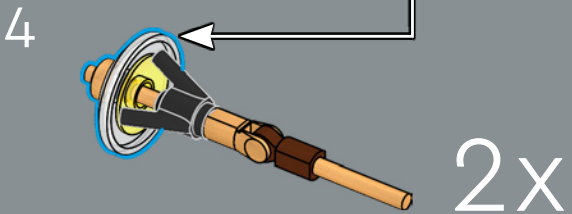
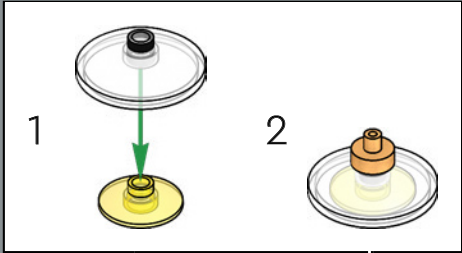
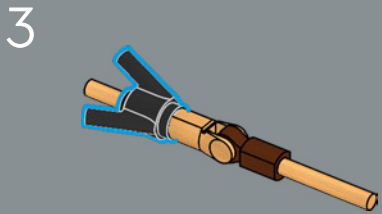
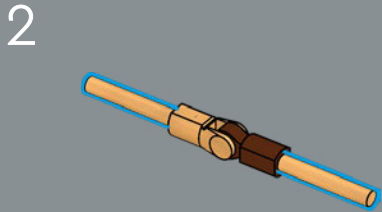
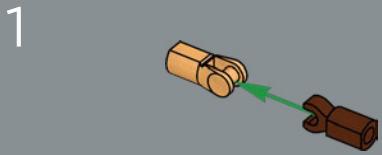



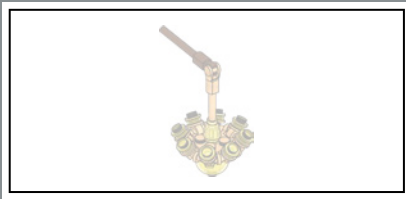

206

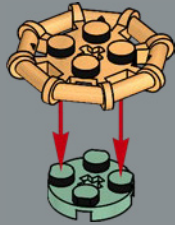

207

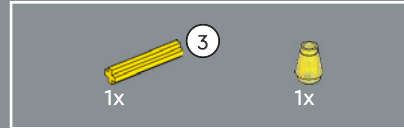
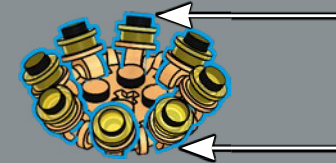
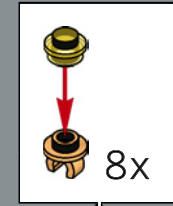

208

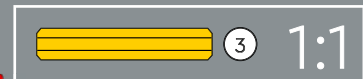
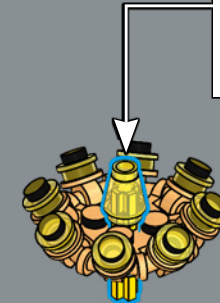
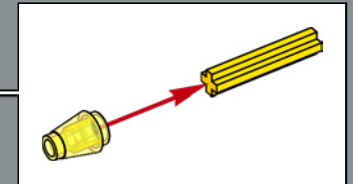



1x

209

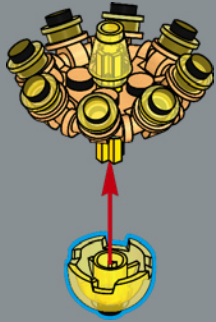

1x



1x

210

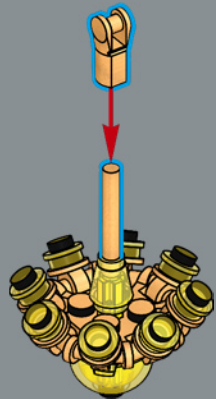

1x



1x

211

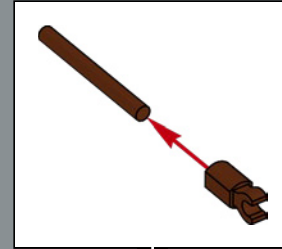



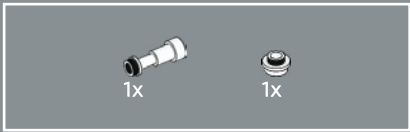

213

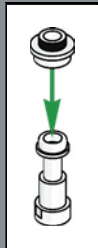

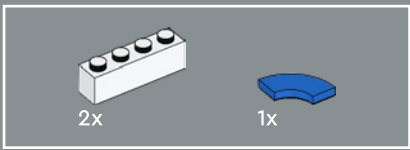

214



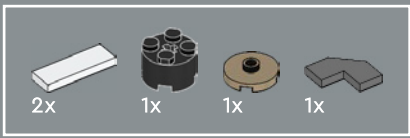

215

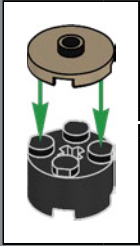

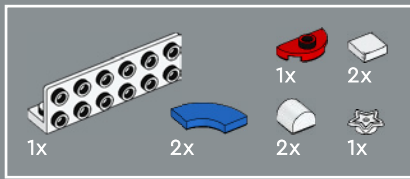

216

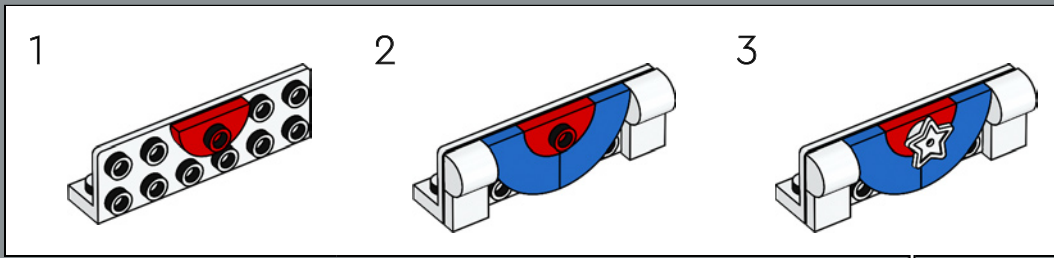

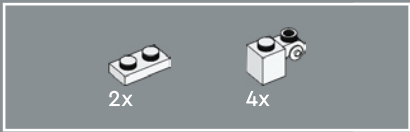

217

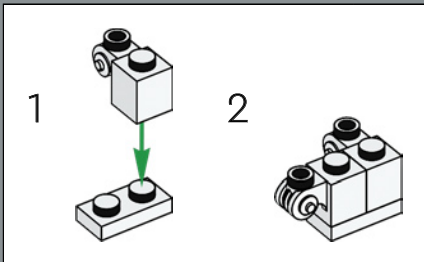
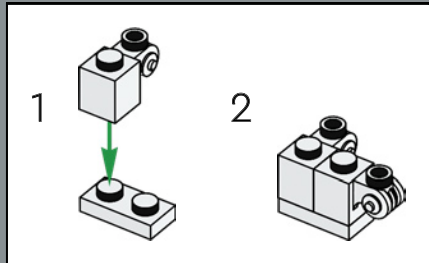

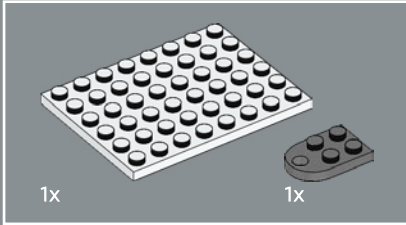
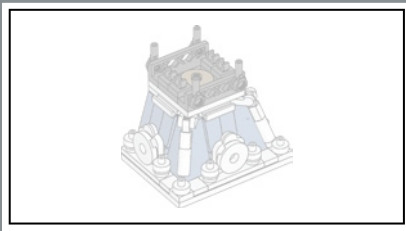

218

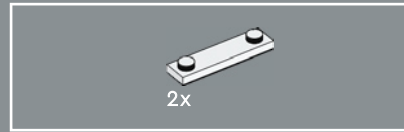
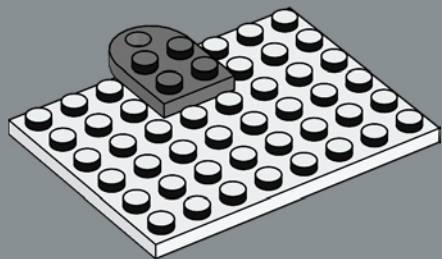

219

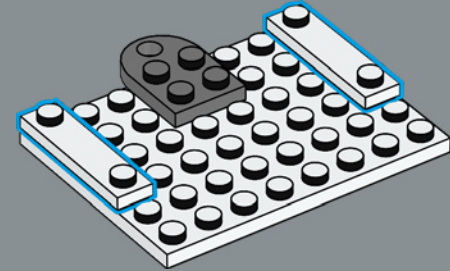

220

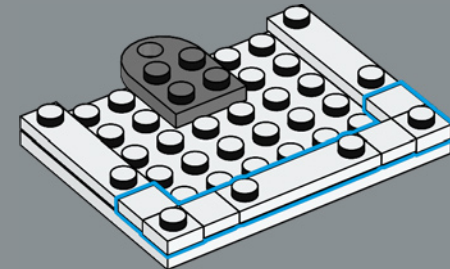



6x



6x

221

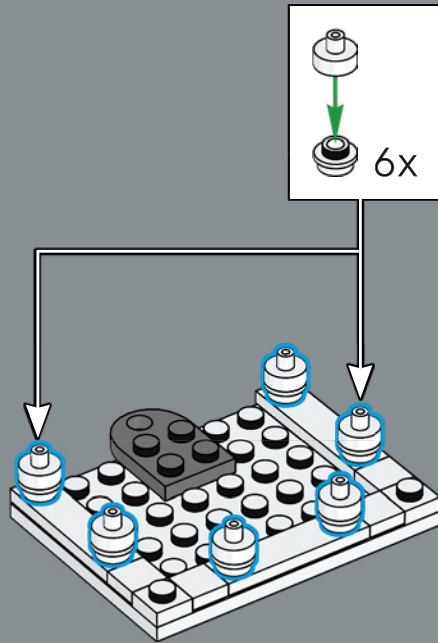

2x

222

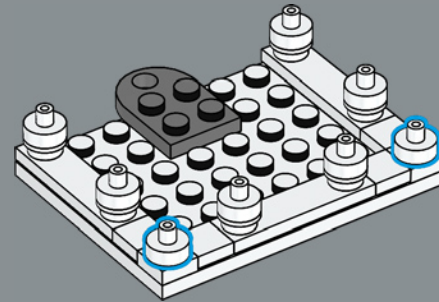

1x



2x

223

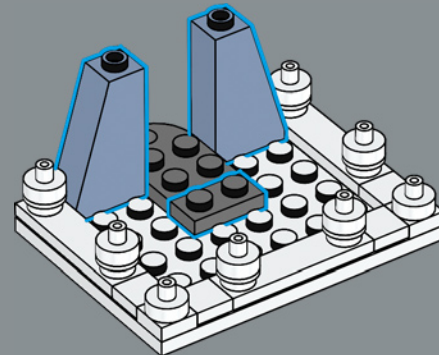

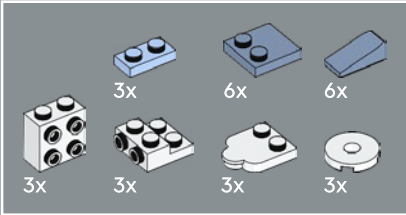
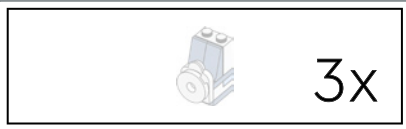

224

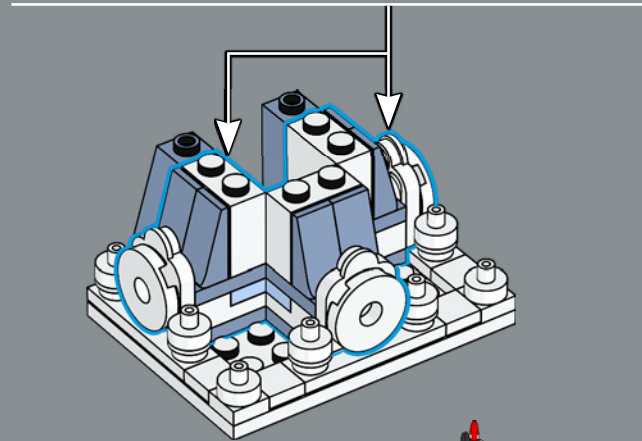
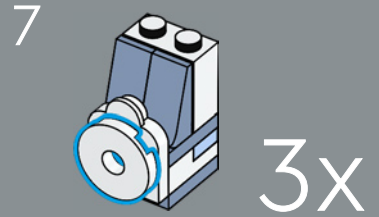
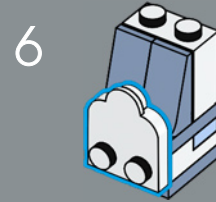
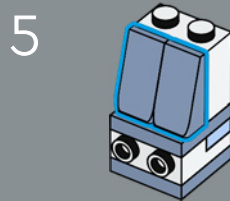
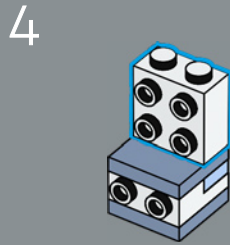
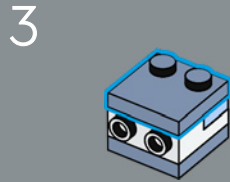
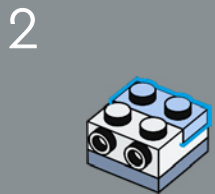
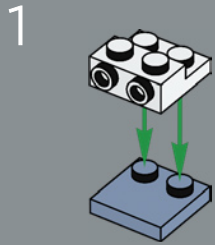

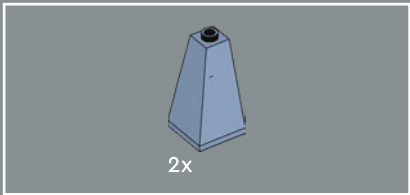

225

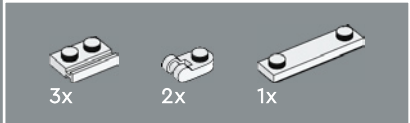
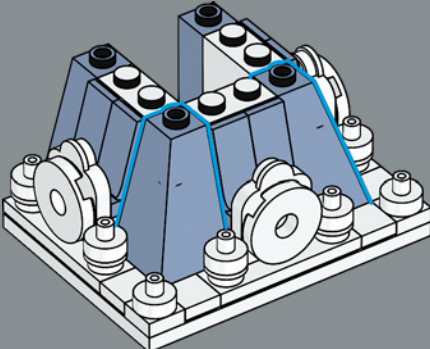

226

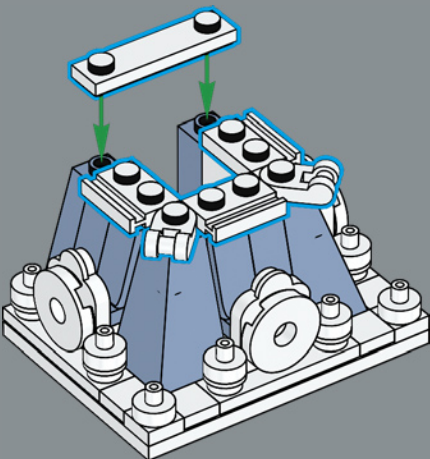

227

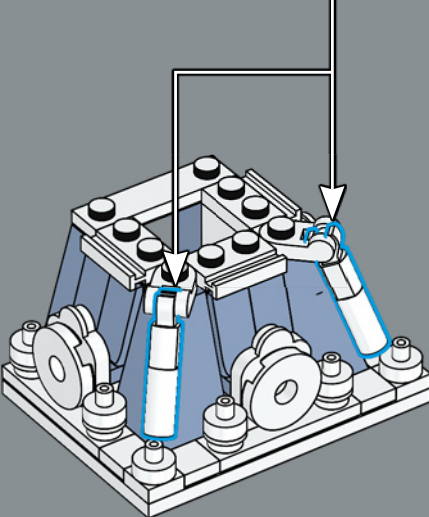
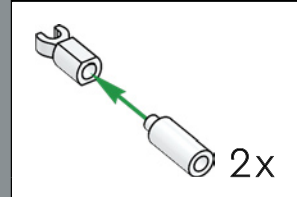

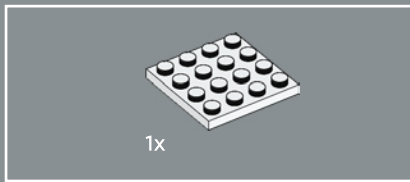

228

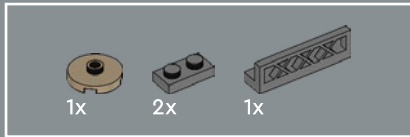
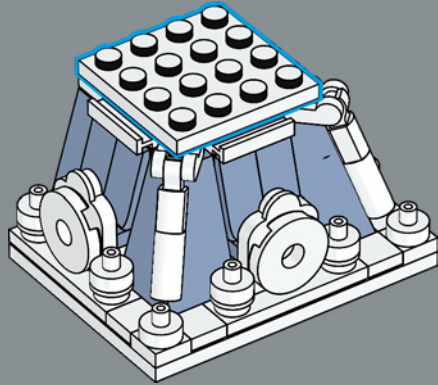

229

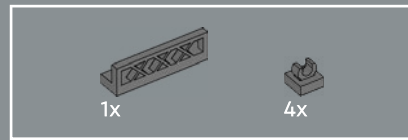
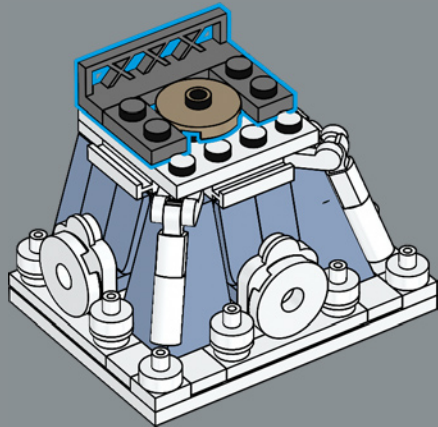

230

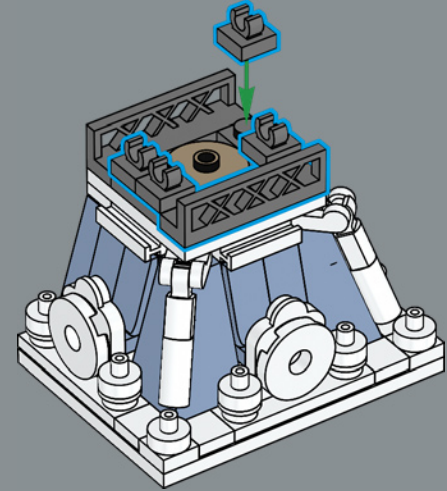

231

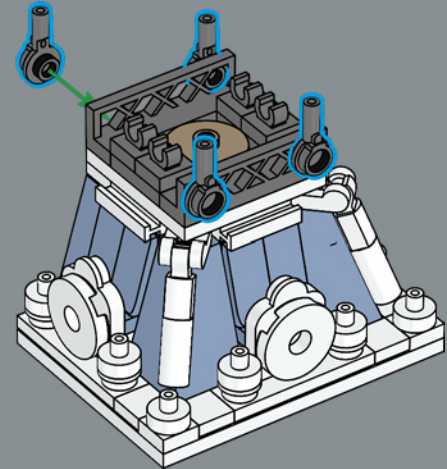

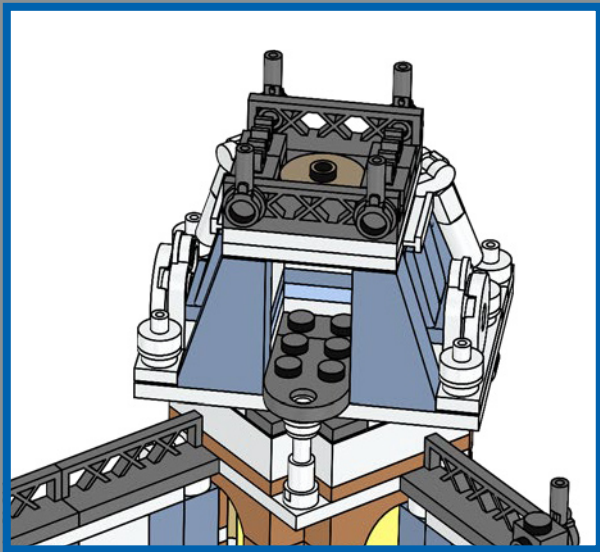

232





233

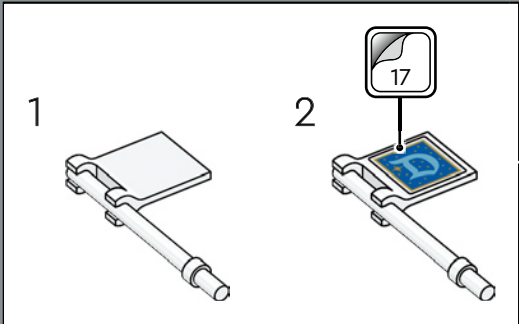



234

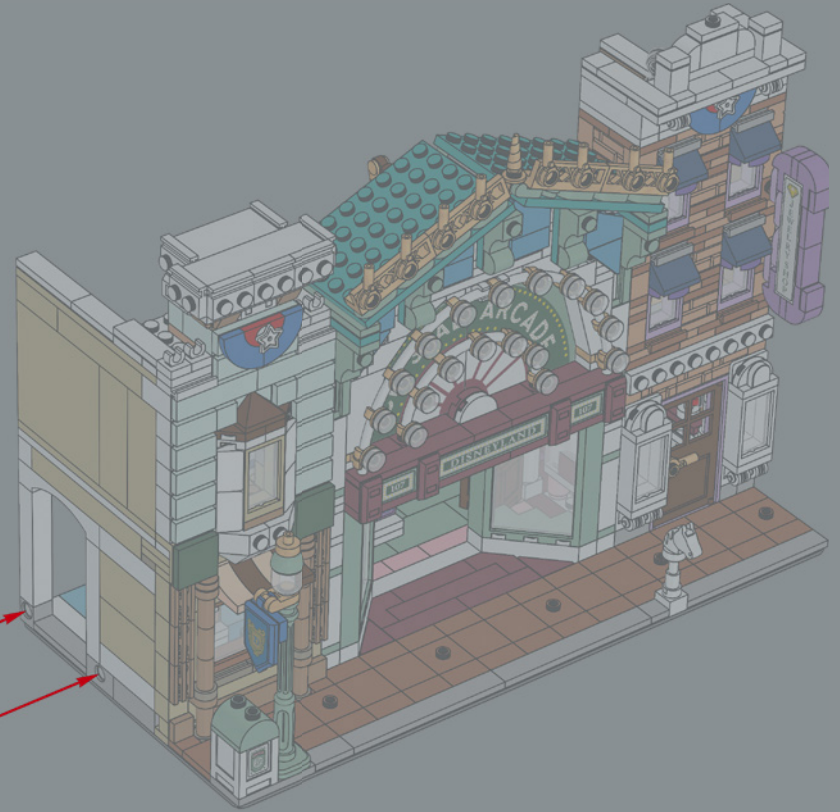



LEGO and the LEGO logo are trademarks of the/son des marques de commerce du/son marcas registradas de LEGO Group. ©2026 The LEGO Group.  
© Disney © Disney/Pixar © & TM Lucasfilm Ltd © 2026 MARVEL

 6649255