



43302

Disney







**FIRE STATION AND
WALT DISNEY'S
APARTMENT**

From his apartment above the park's fire station, Walt Disney could follow the construction and bustle of Main Street, U.S.A. Though closed to the public, this private space reflects his vision. Now, you can recreate its unique ambience.

**LA CASERNE DE
POMPIERS ET
L'APPARTEMENT DE
WALT DISNEY**

Depuis son appartement situé au-dessus de la caserne de pompiers du parc, Walt Disney pouvait suivre l'évolution de Disney Main Street. Bien qu'inaccessible au public, cet espace privé incarne pleinement sa vision. Vous pouvez maintenant recréer son ambience unique.

**ESTACIÓN DE
BOMBEROS Y
DEPARTAMENTO DE
WALT DISNEY**

Desde su departamento ubicado arriba de la estación de bomberos del parque, Walt Disney podía mantenerse al tanto del avance de la construcción y el bullicio de Main Street, U.S.A. Si bien está cerrado al público, este espacio privado refleja su visión. Y ahora tú puedes darle forma a su singular atmósfera.



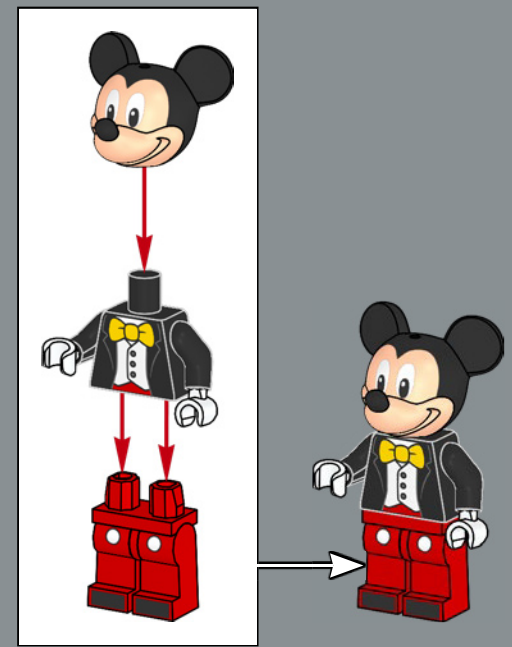
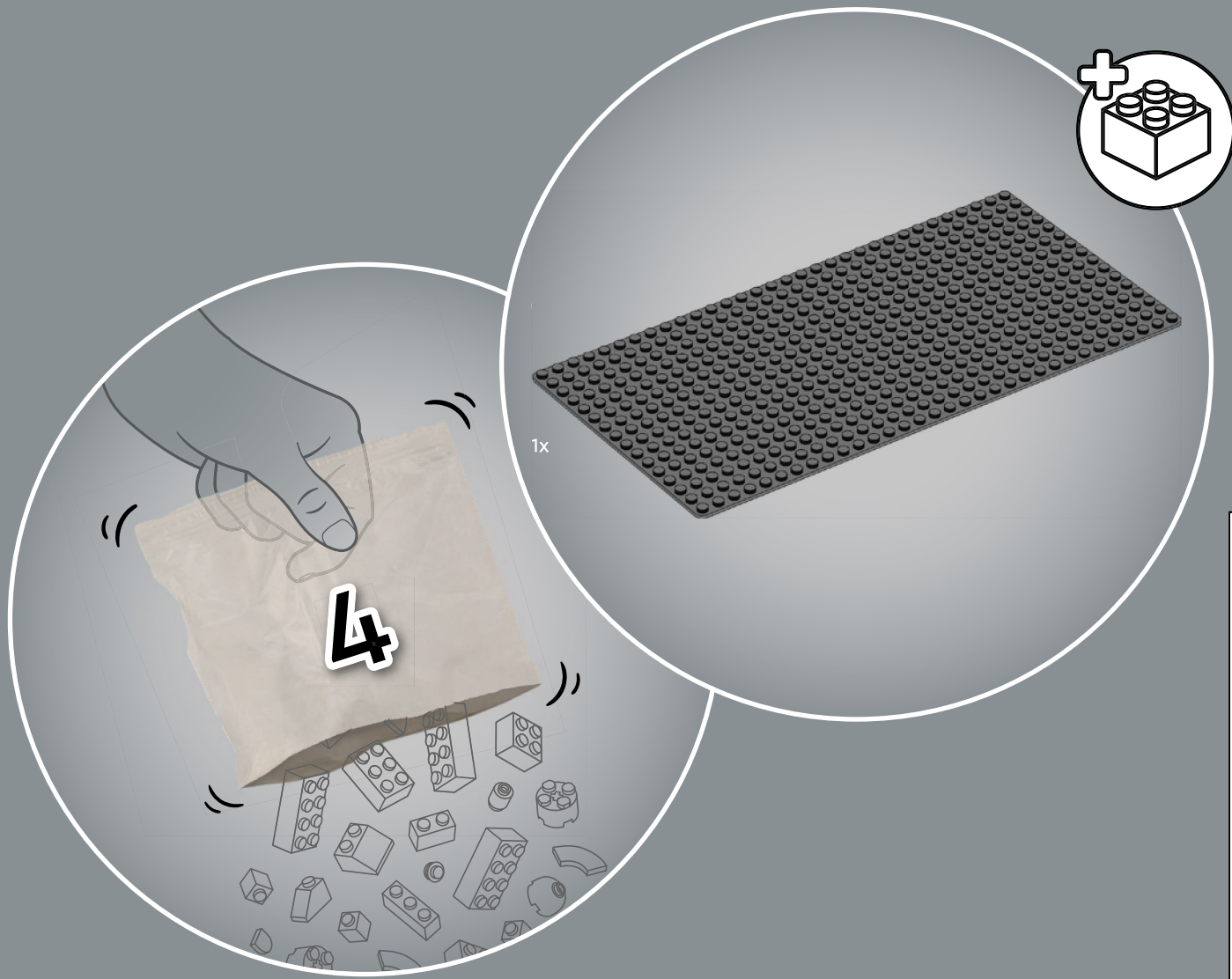

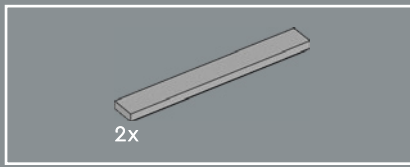

1

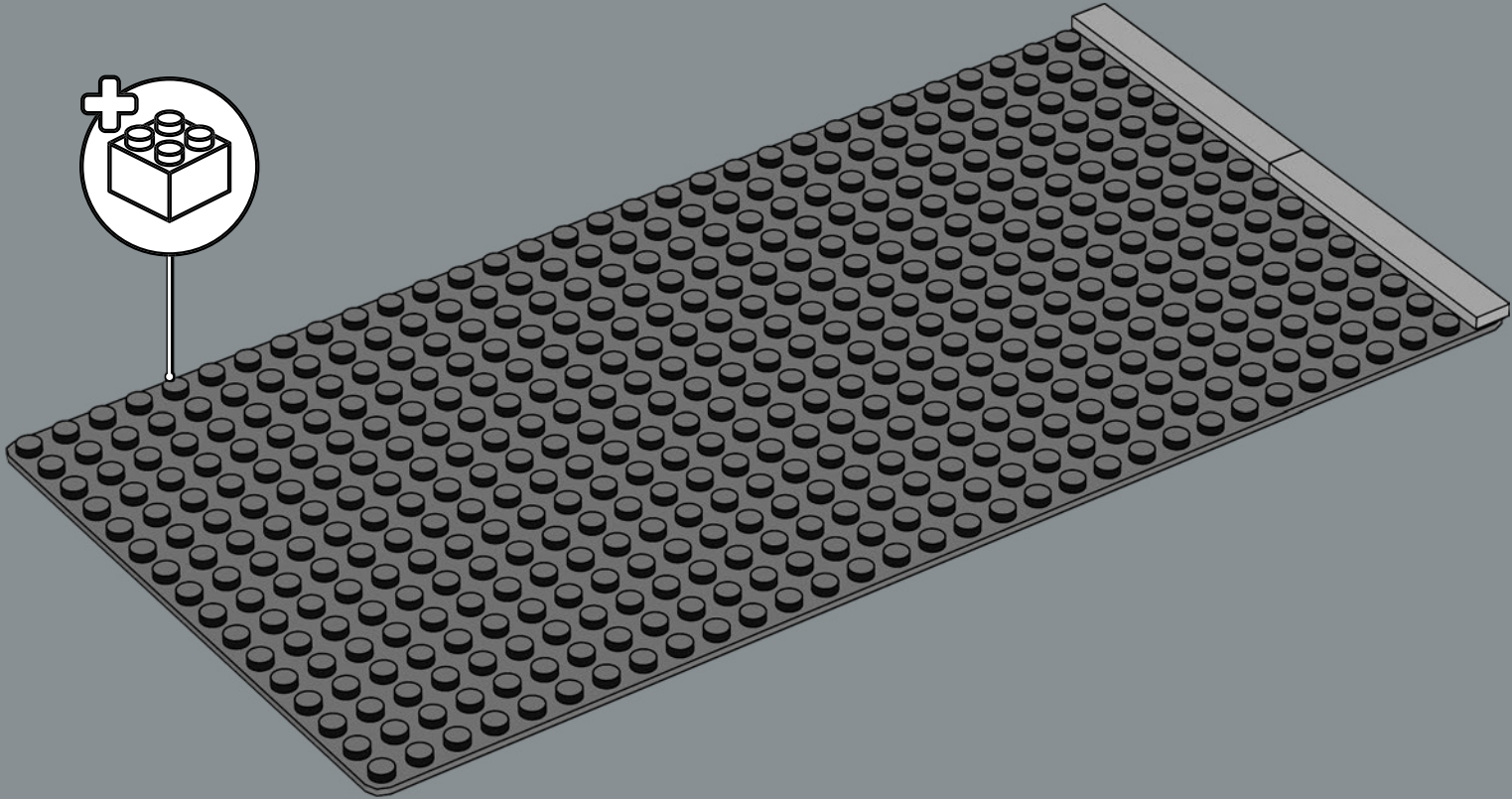

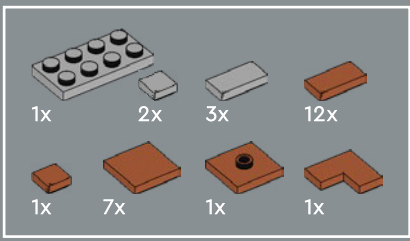

2

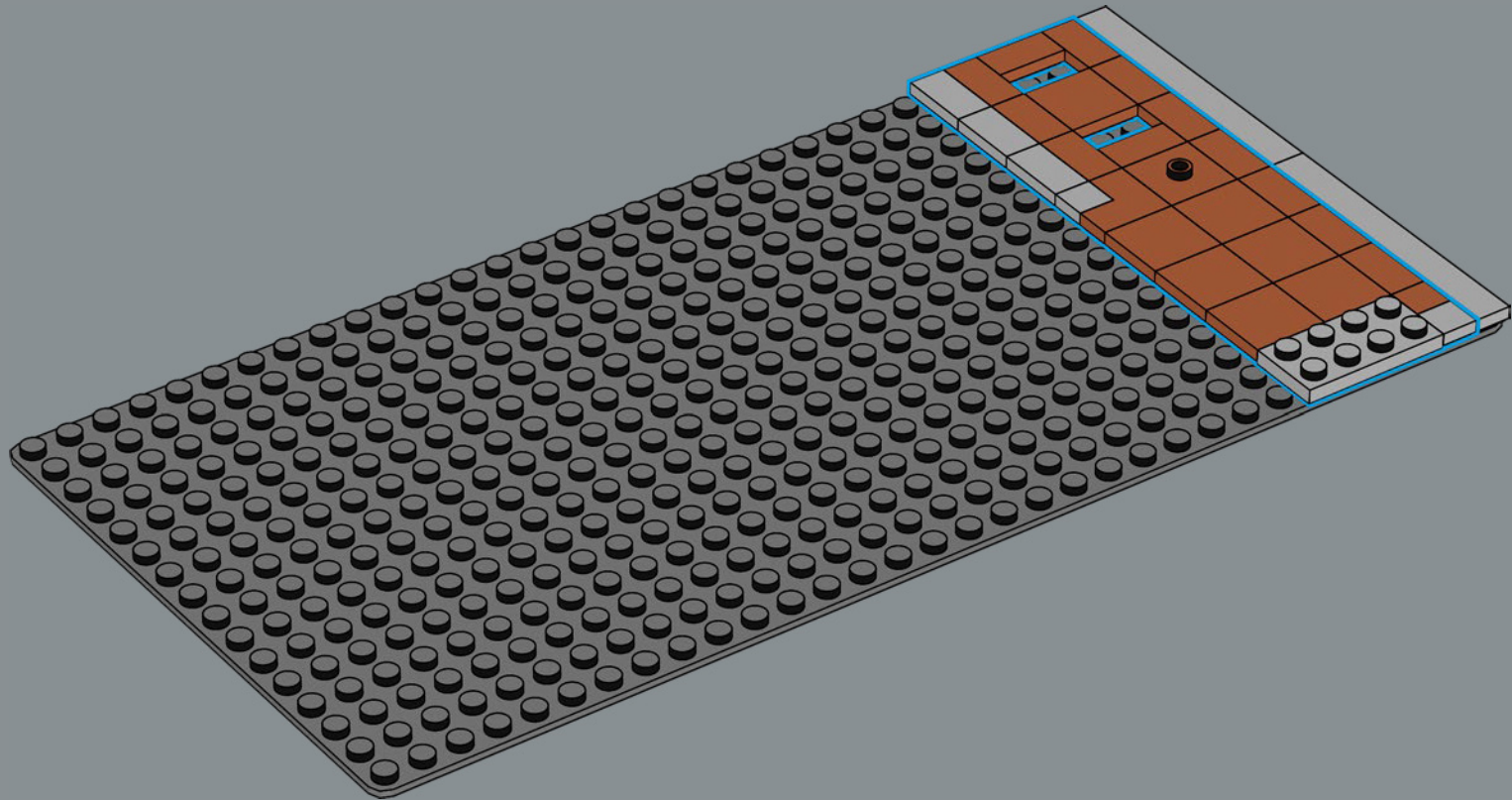

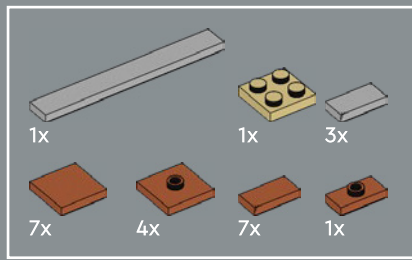

3

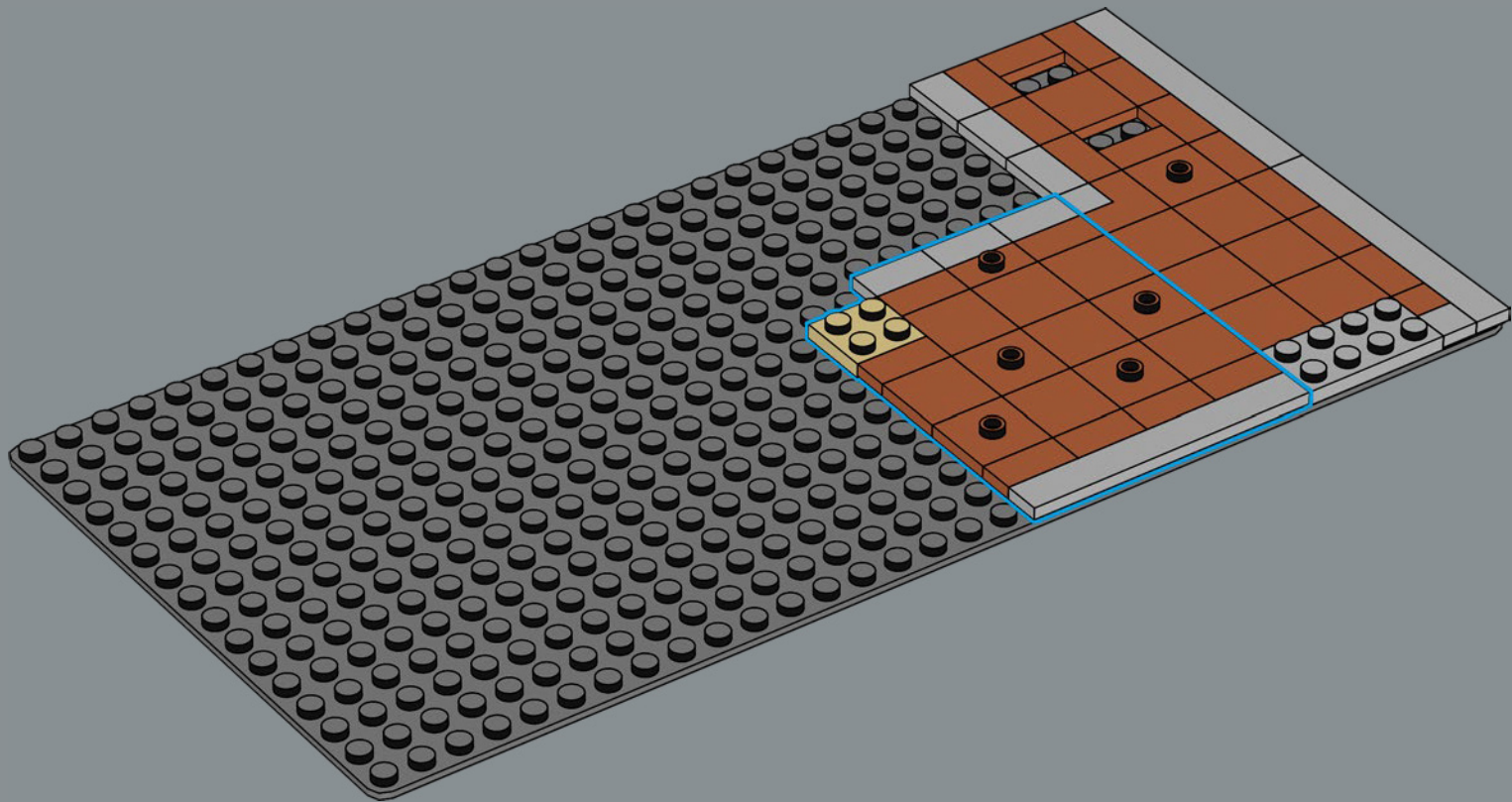

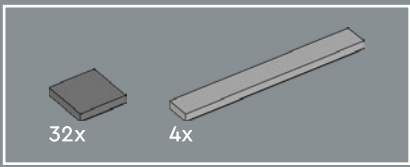

4

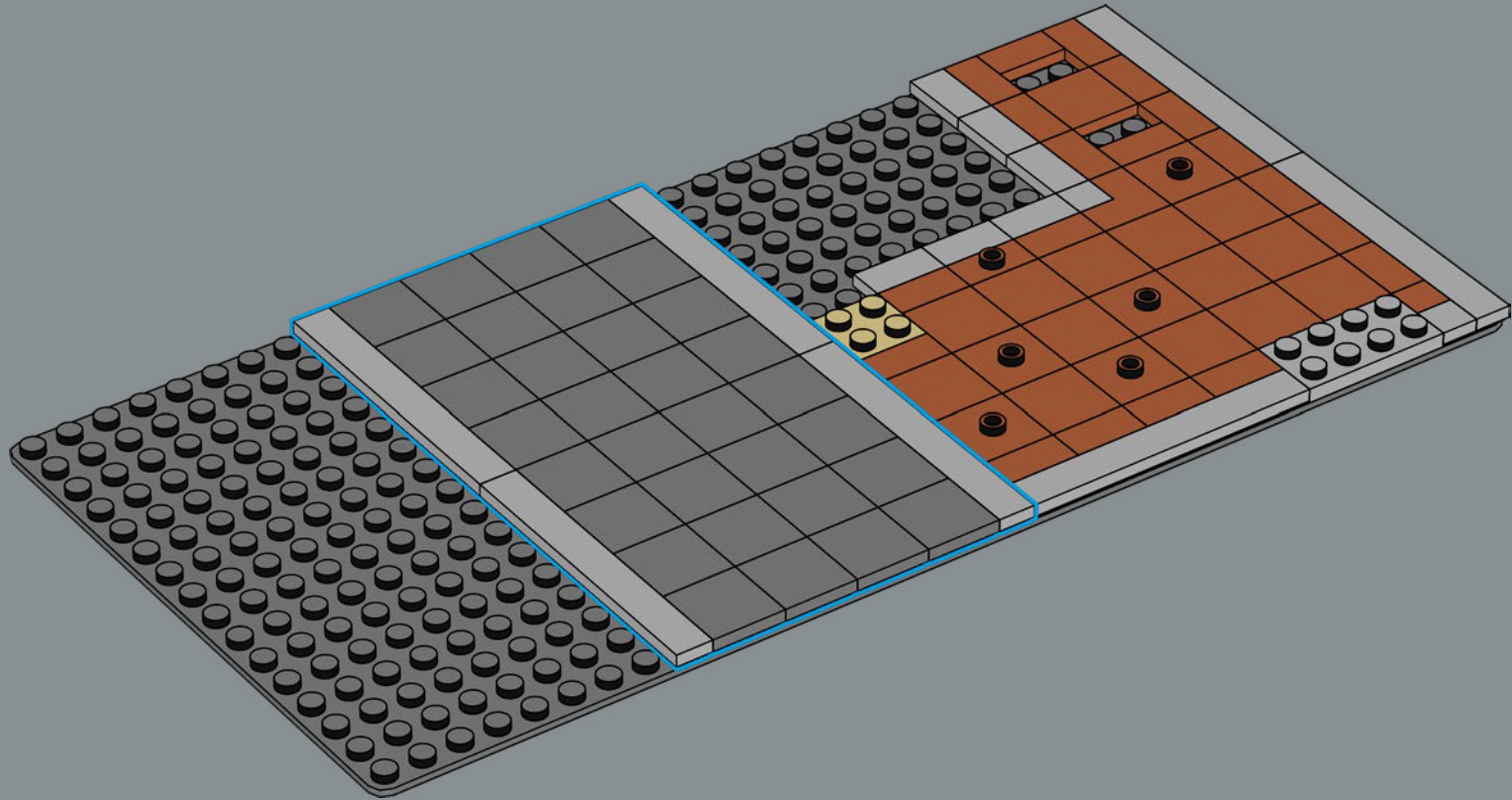

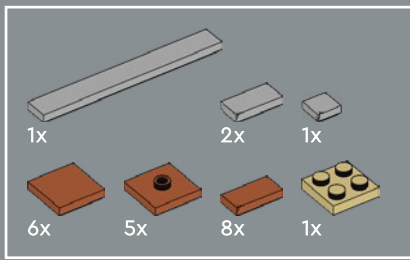

5

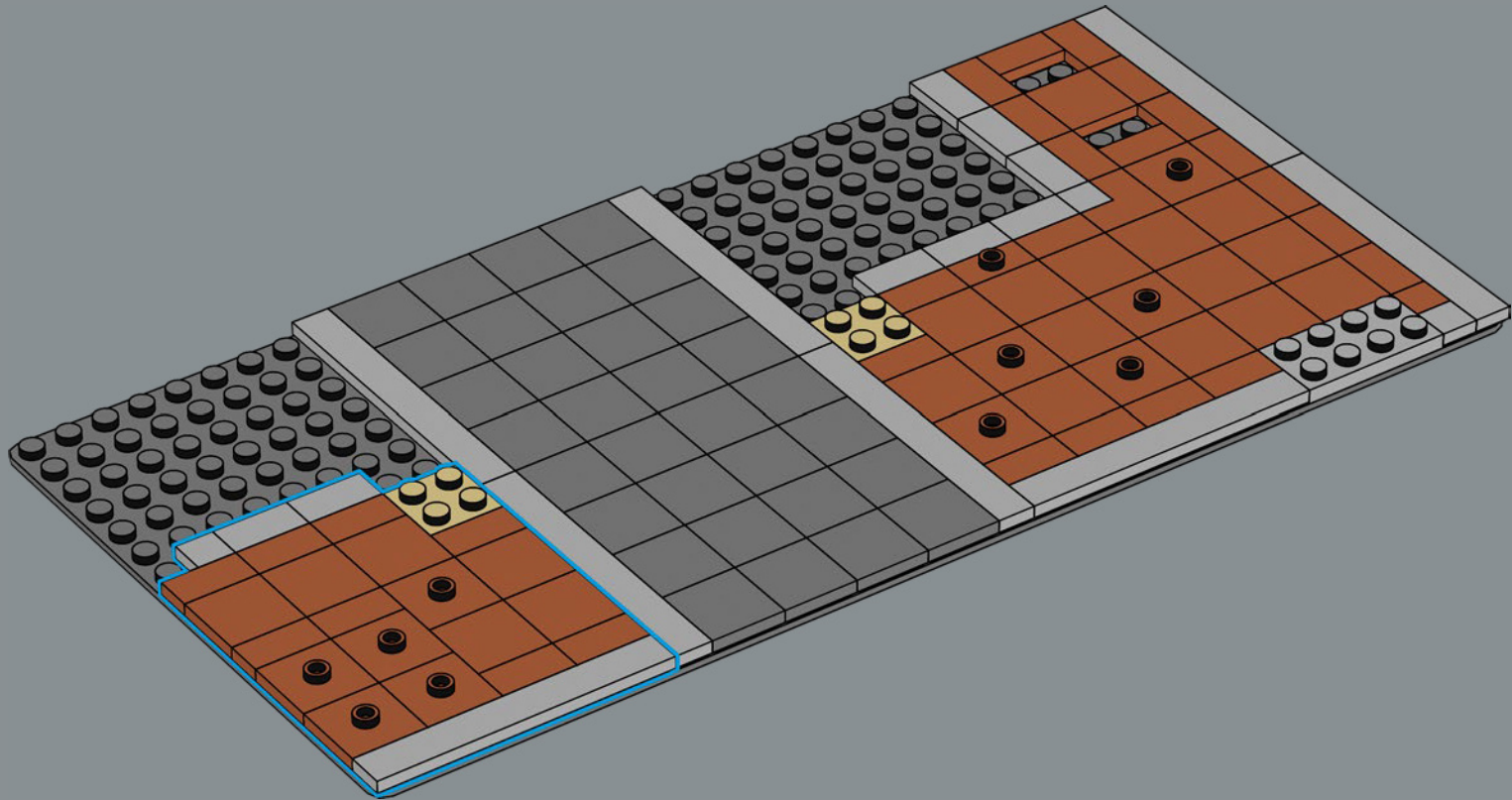

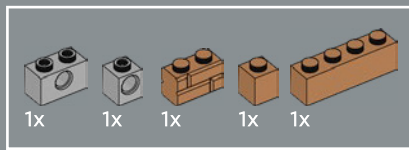

6

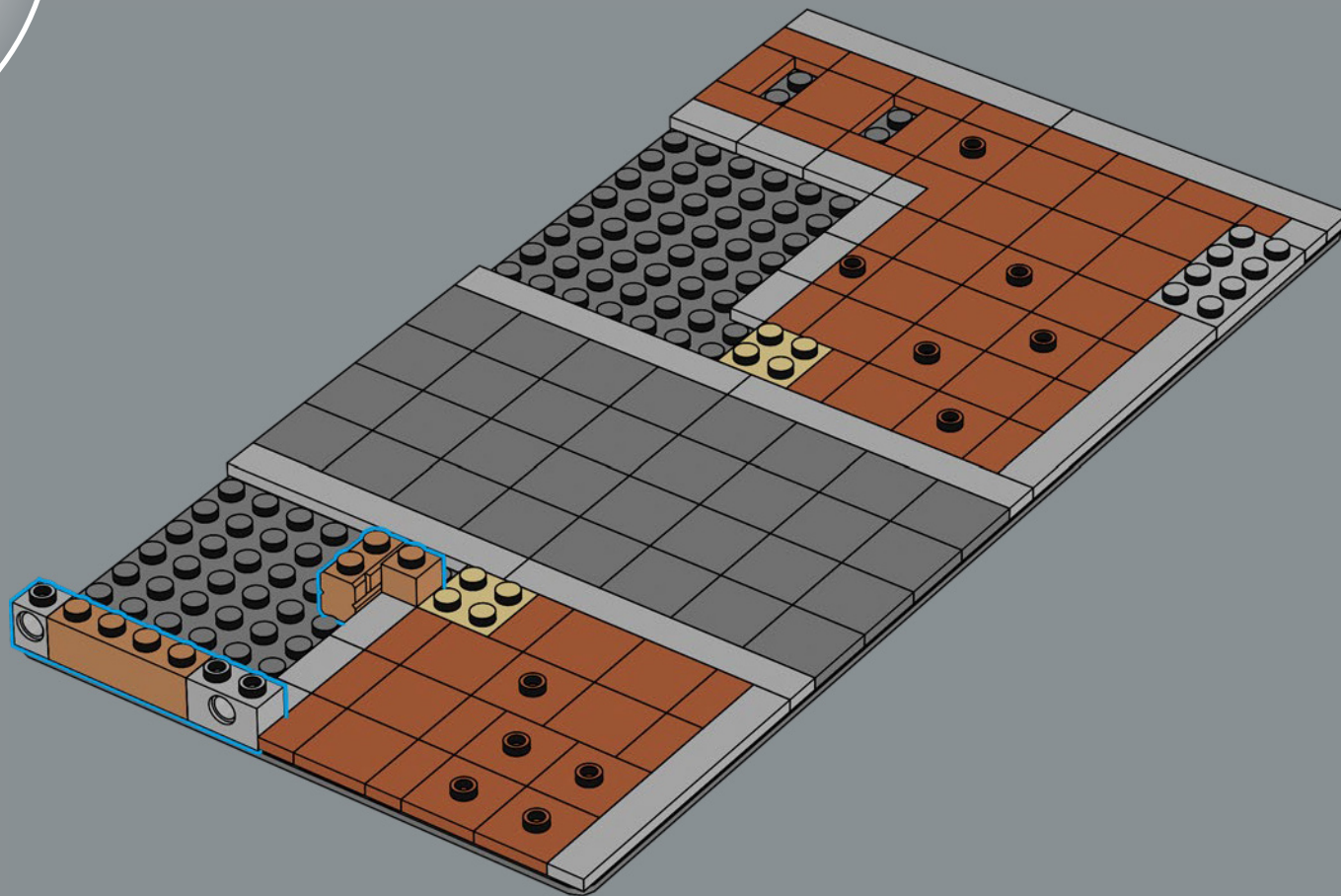

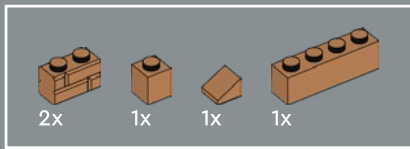

7

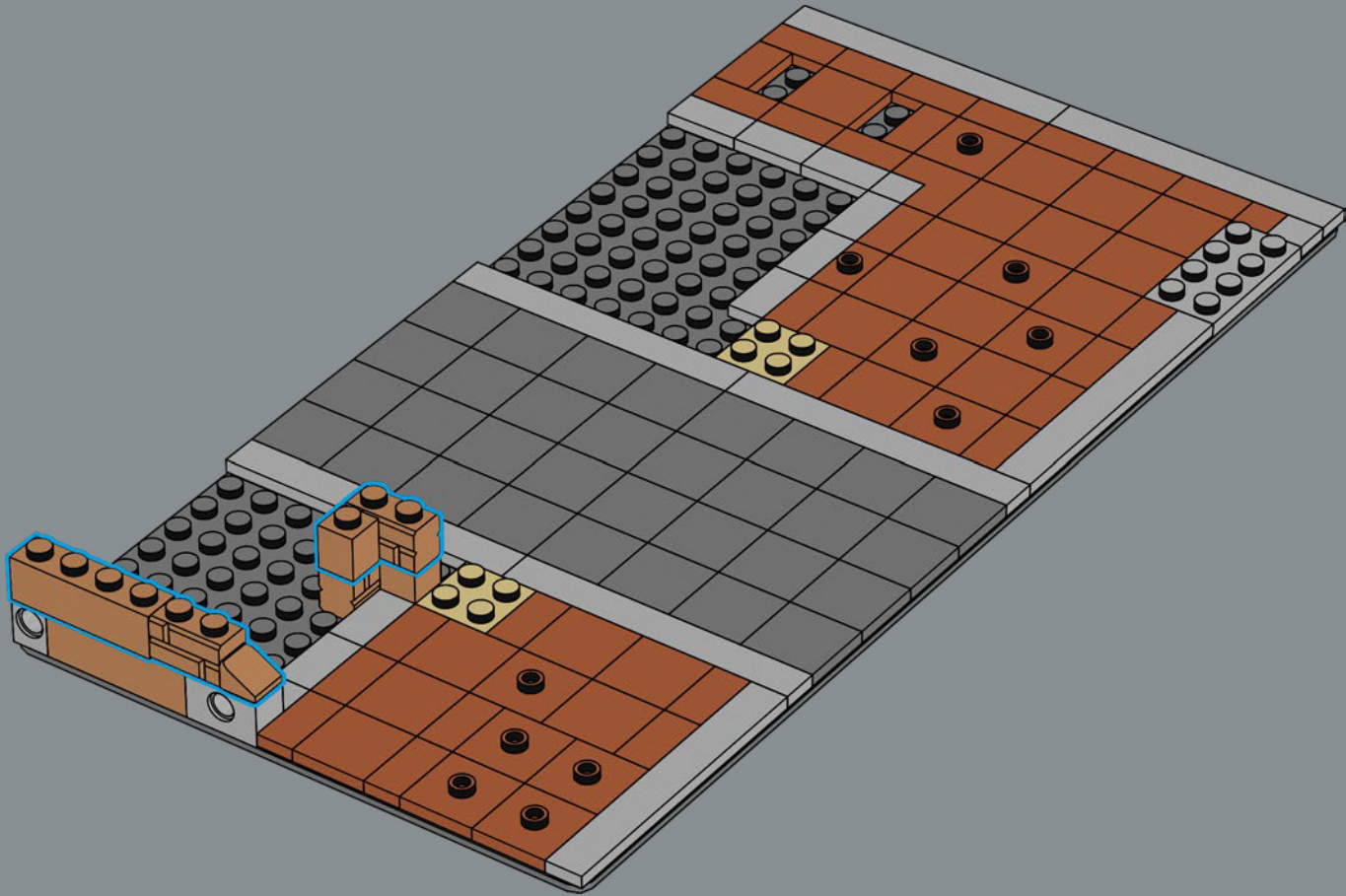

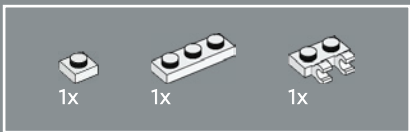

8

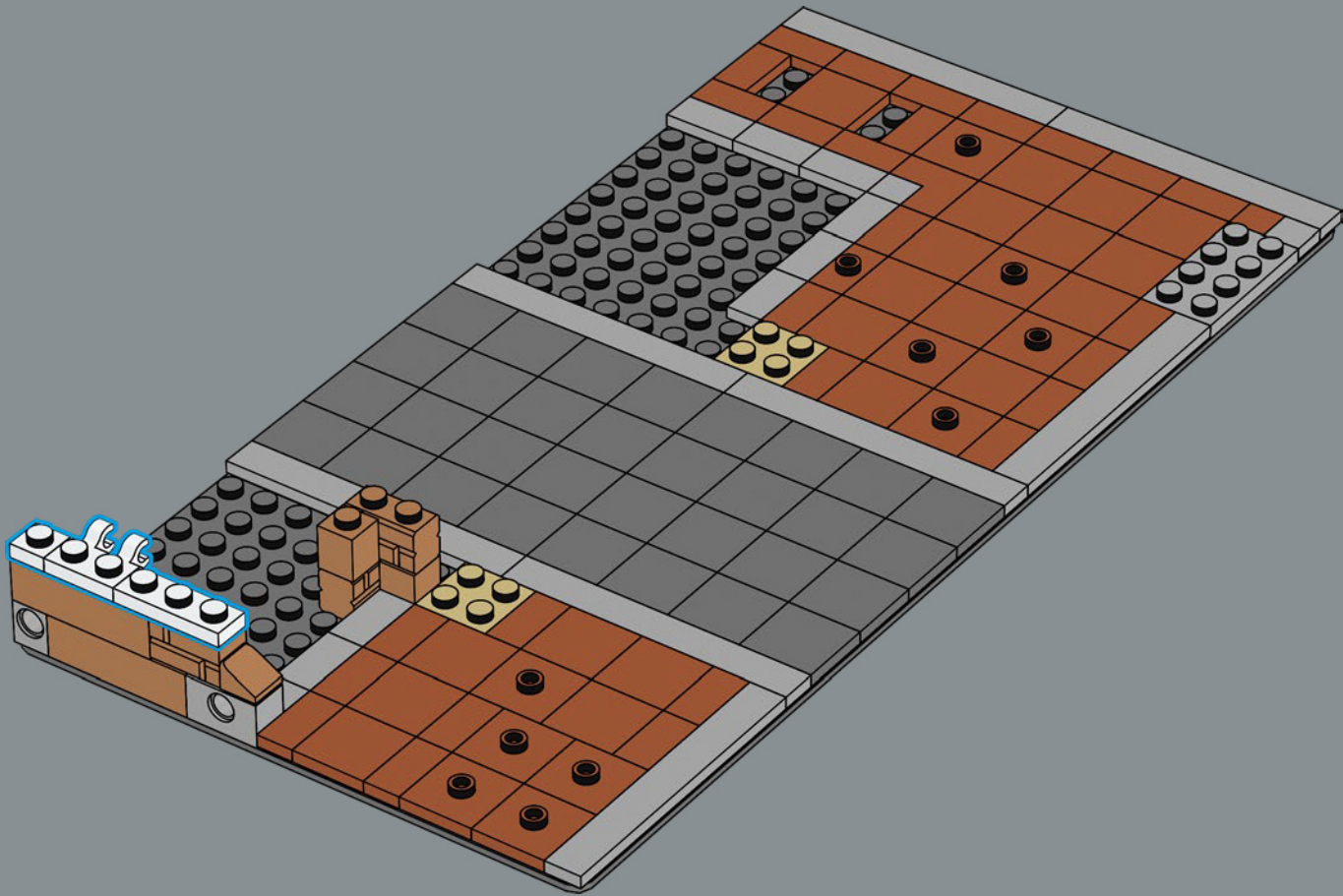

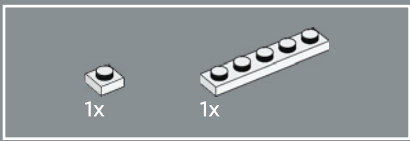

9

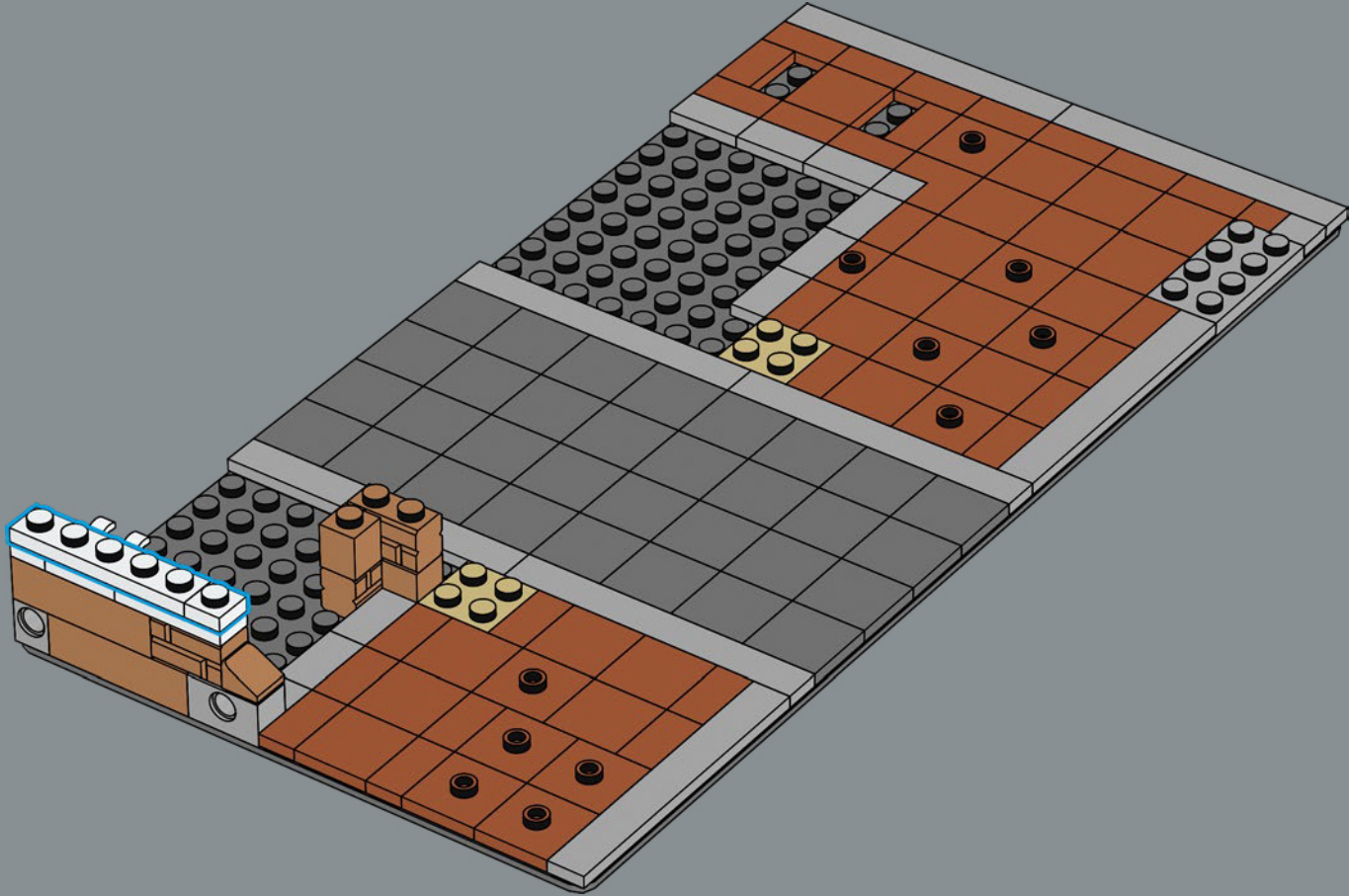

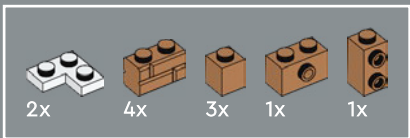

10

1

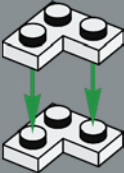

2

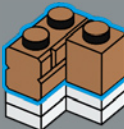

3

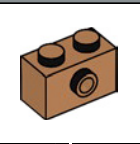
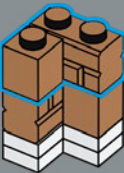

4

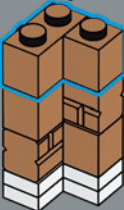

5

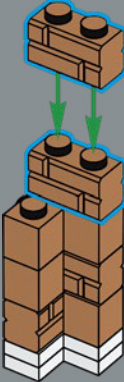

6

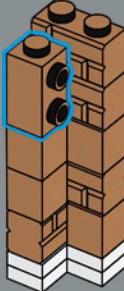

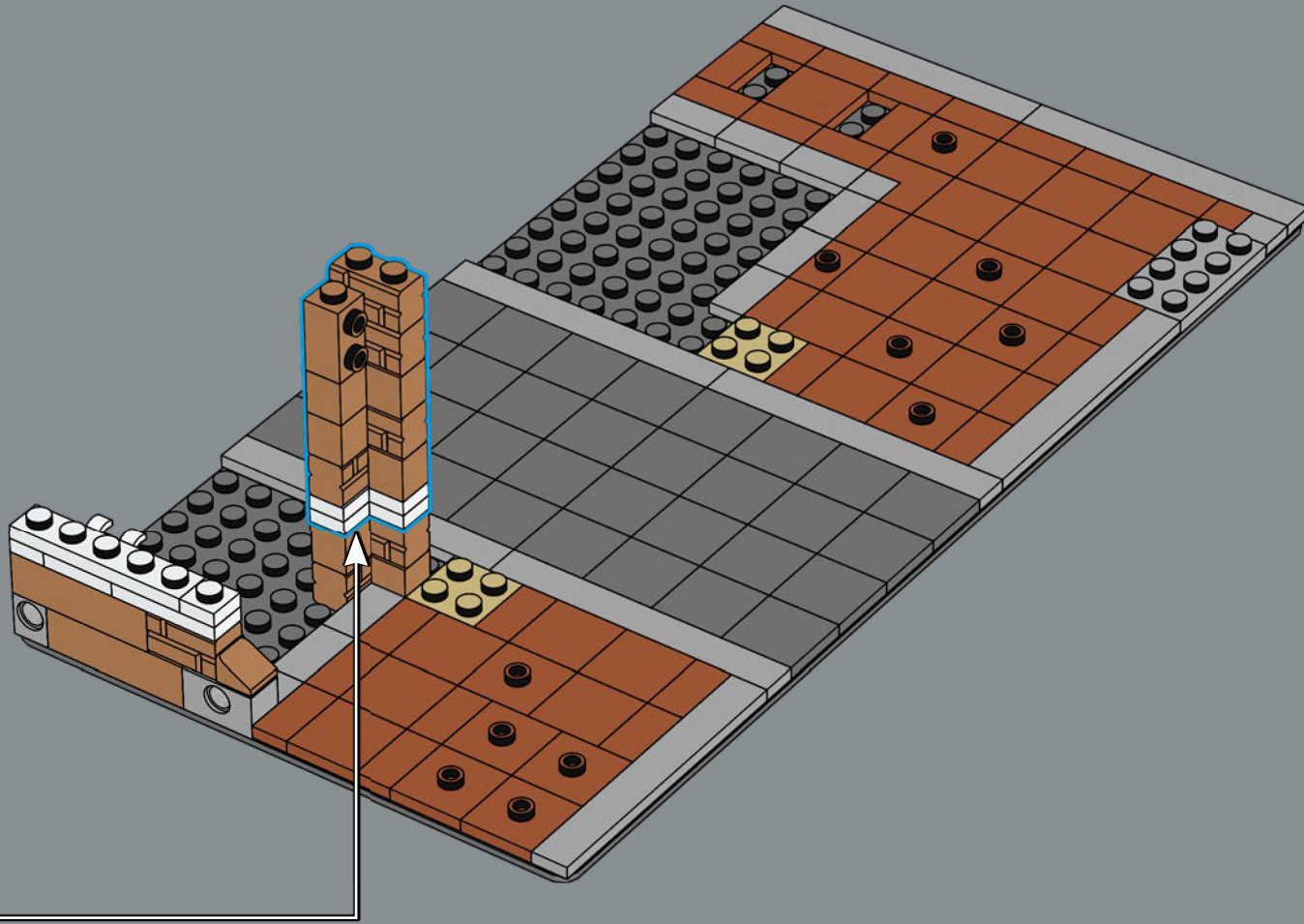

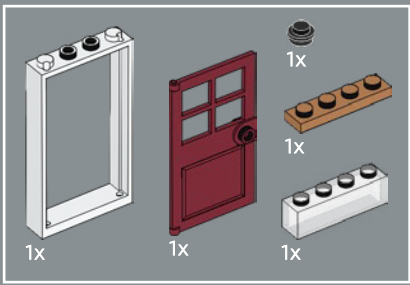

11

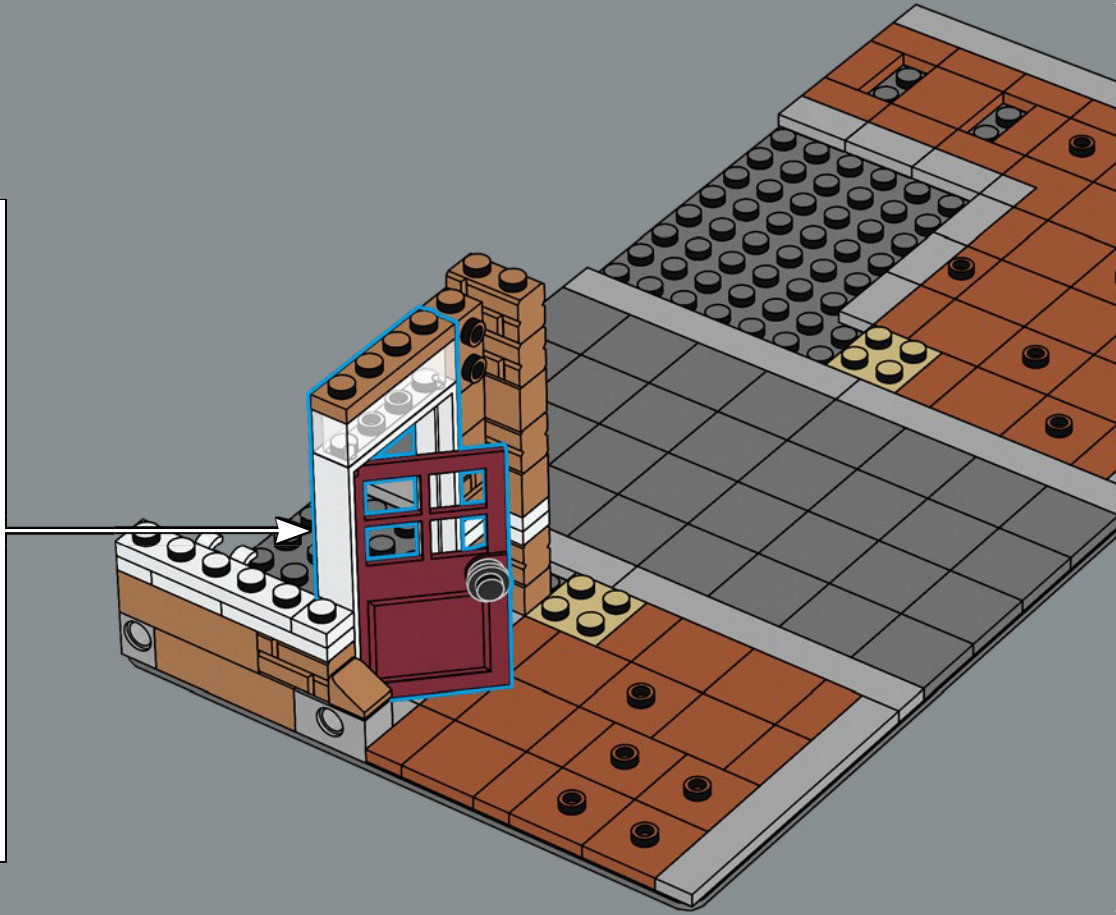
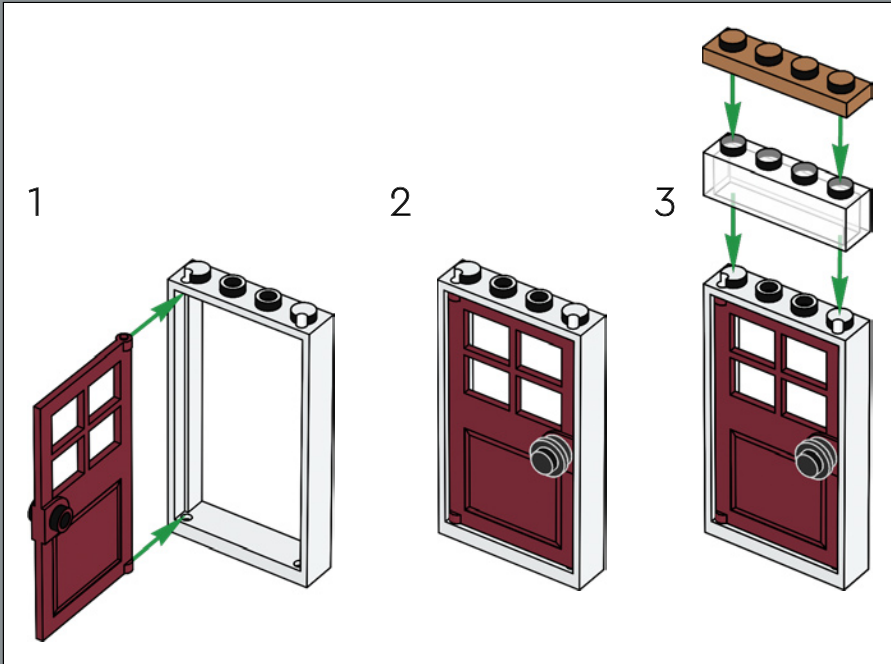

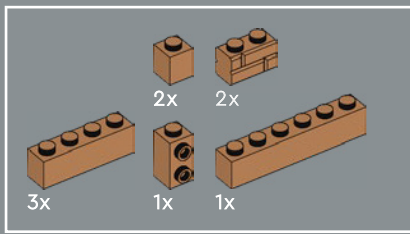

12

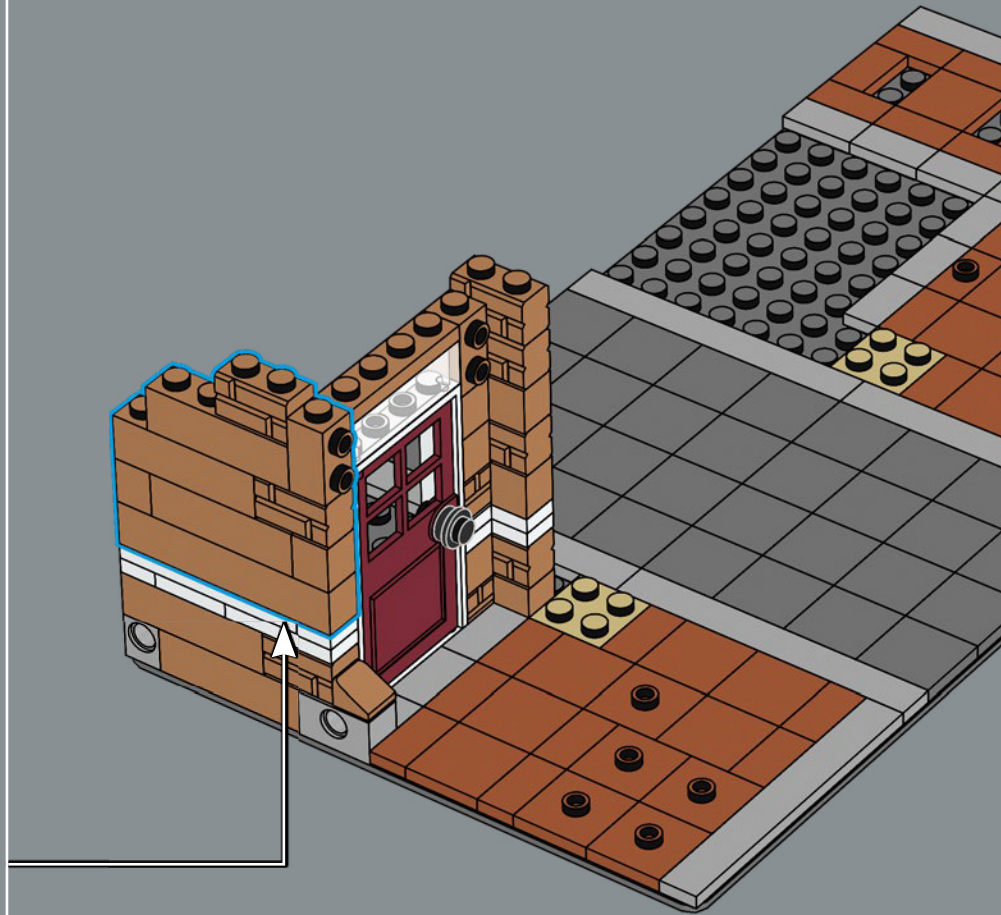
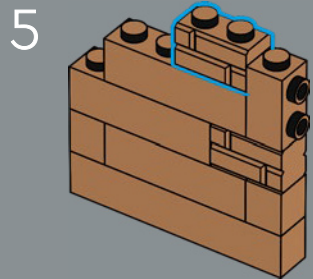
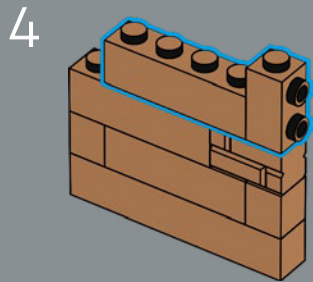
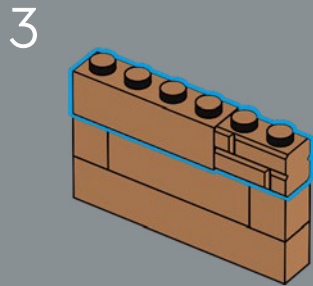
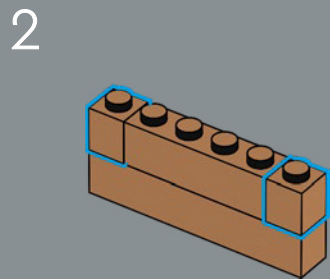
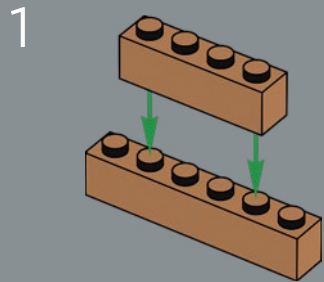

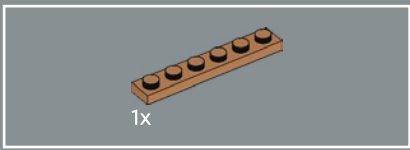

13

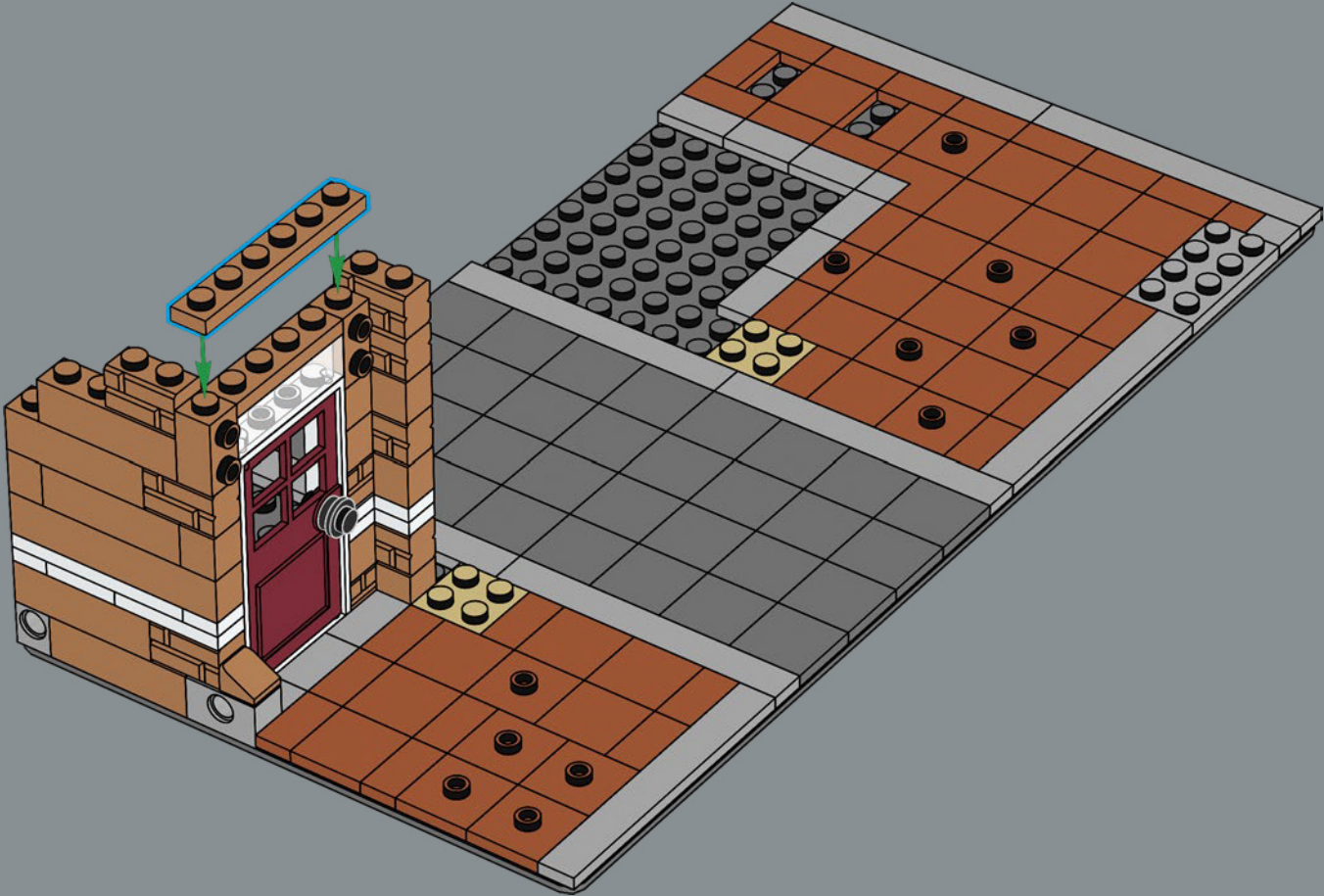

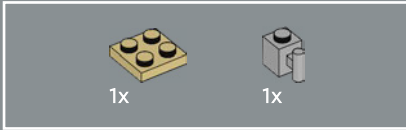
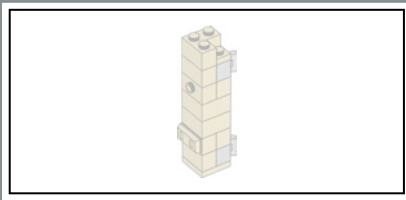

14

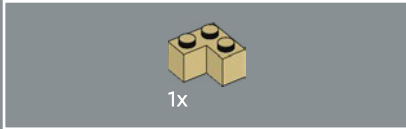
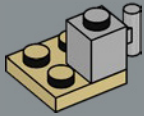

15

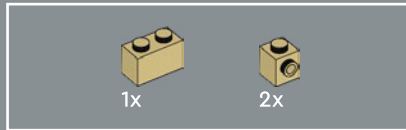
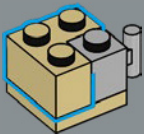

16

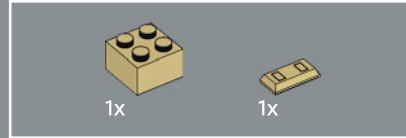
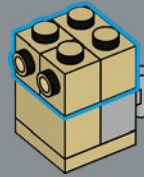

17

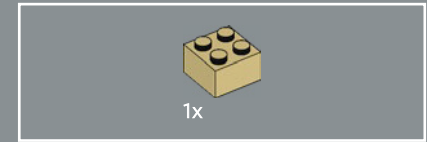
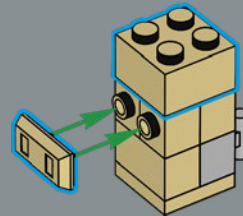

18

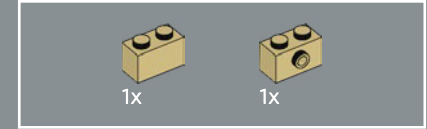
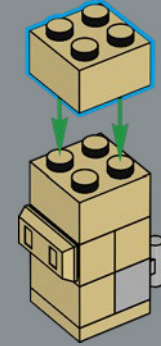

19

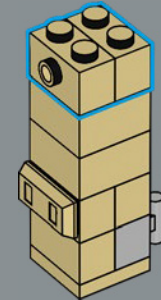

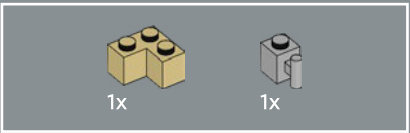

20

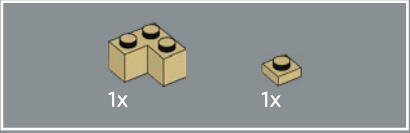
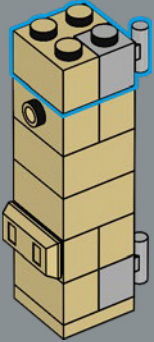

21

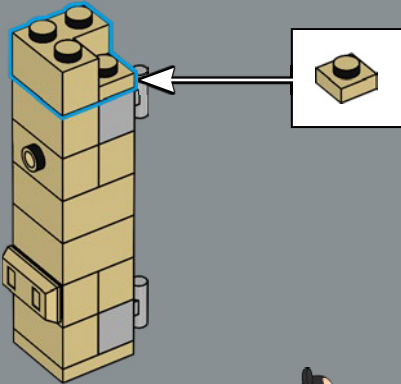

22

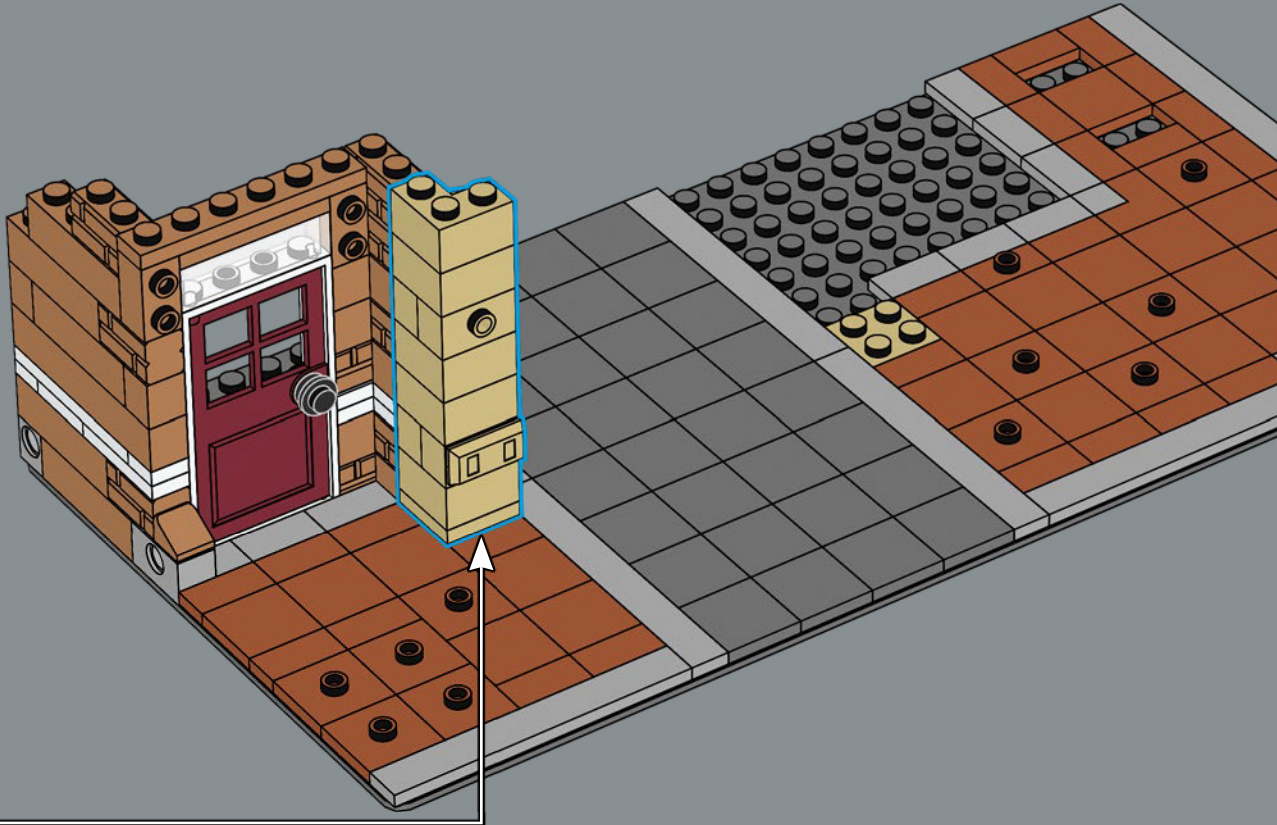

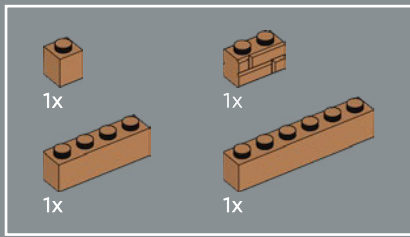

23

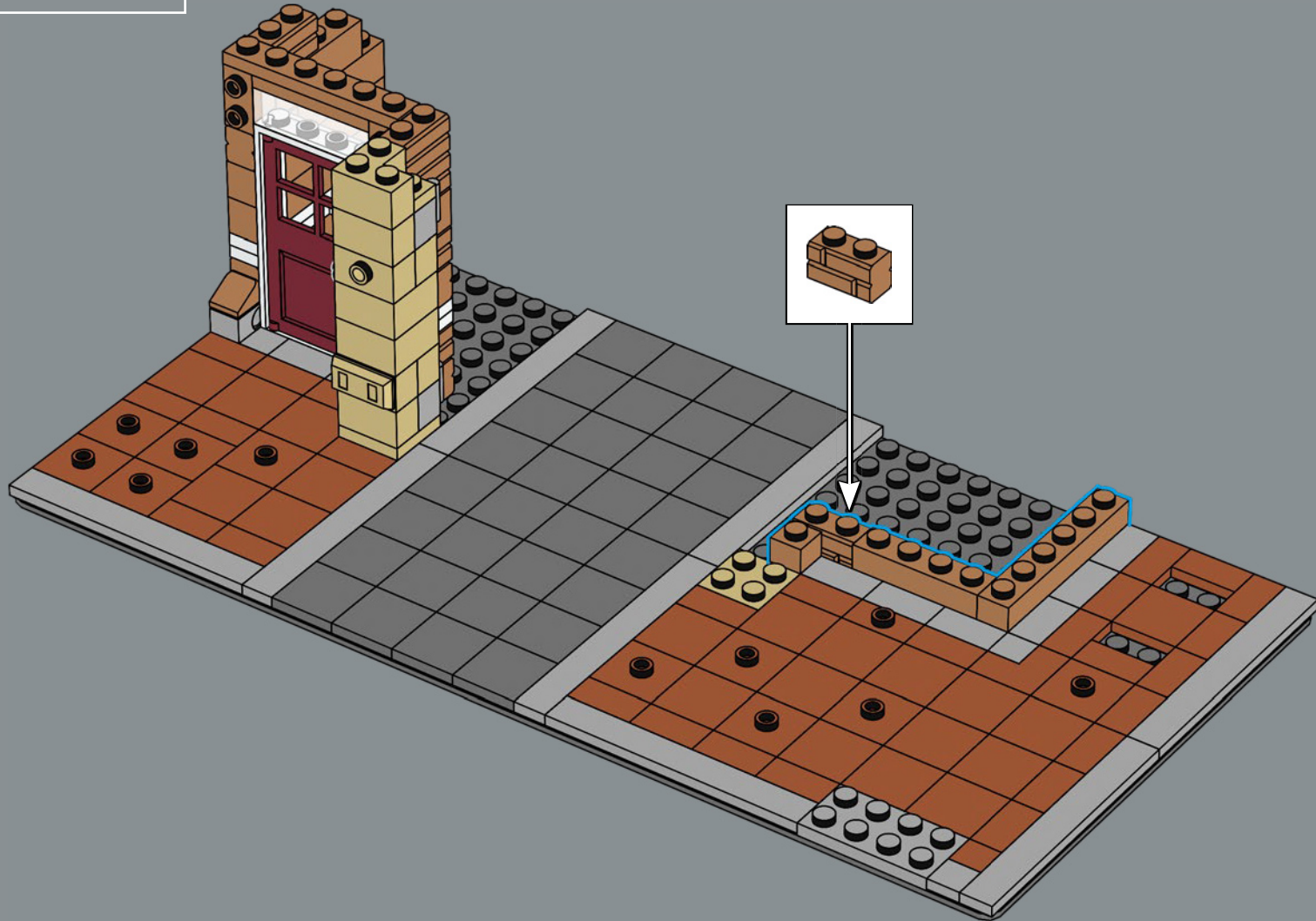

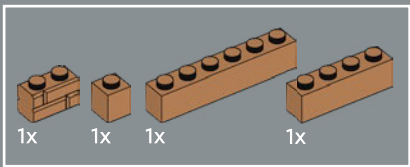

24

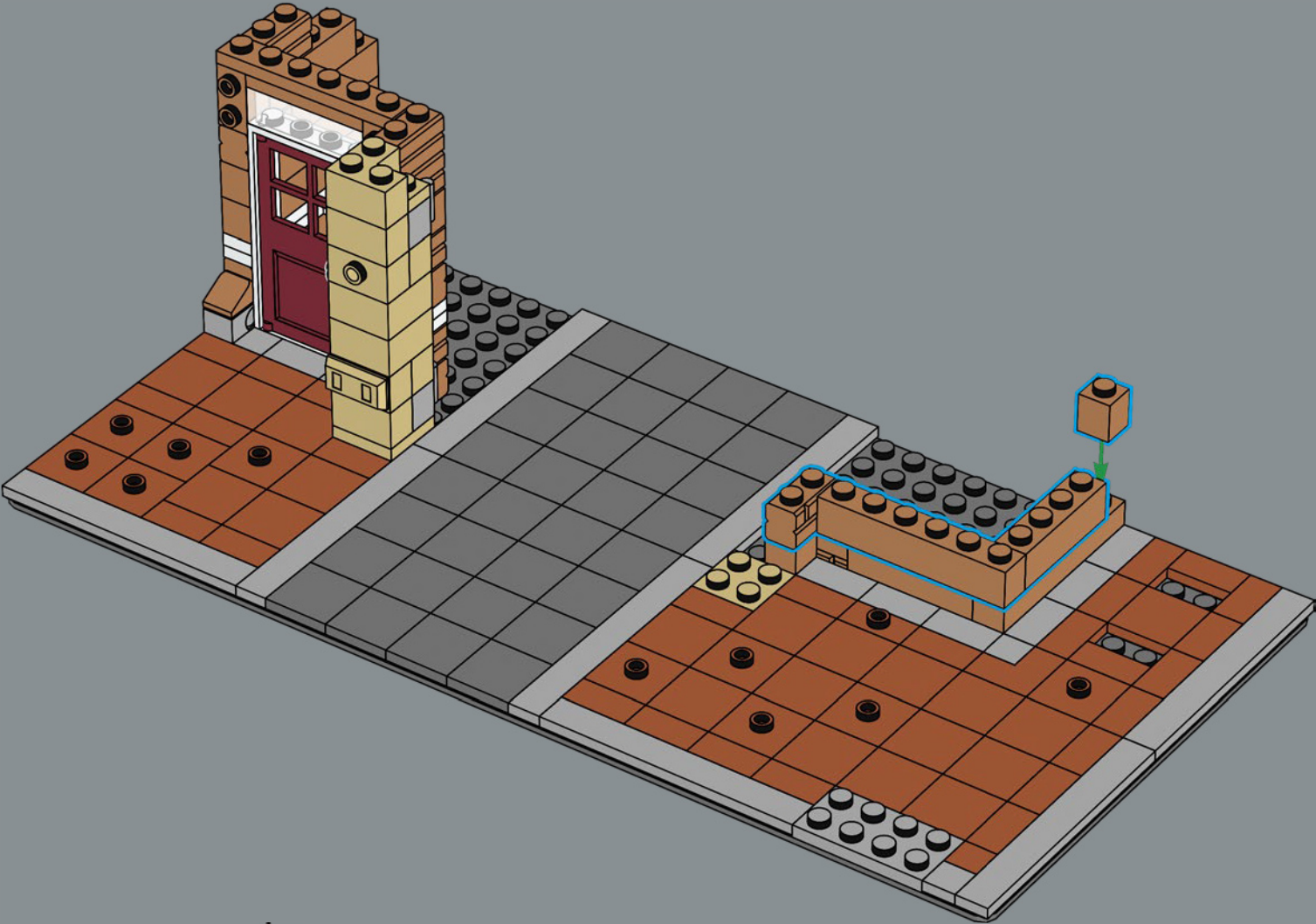

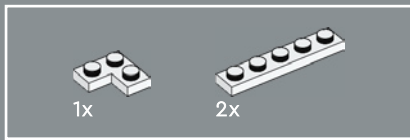

25

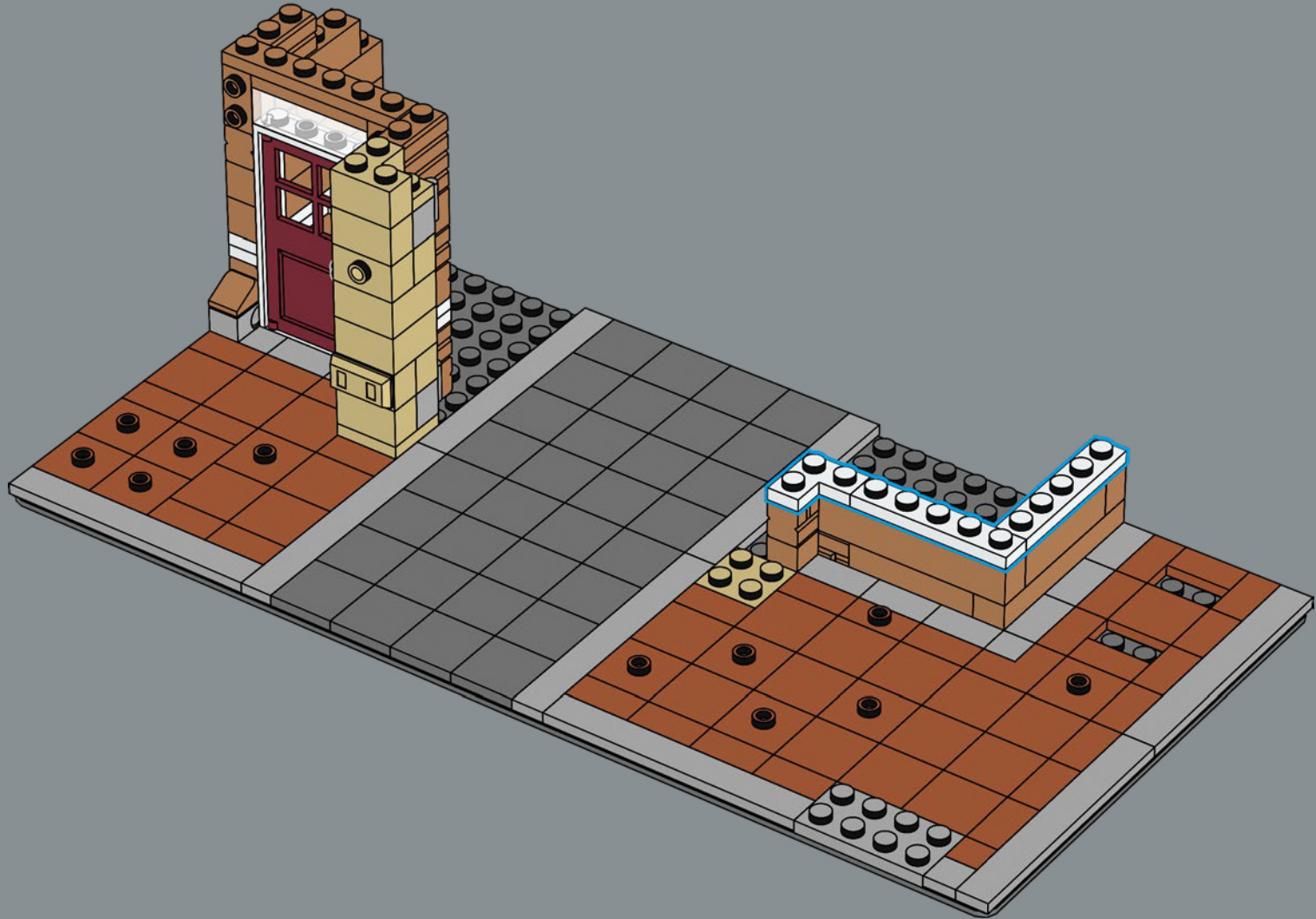

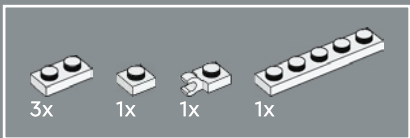

26

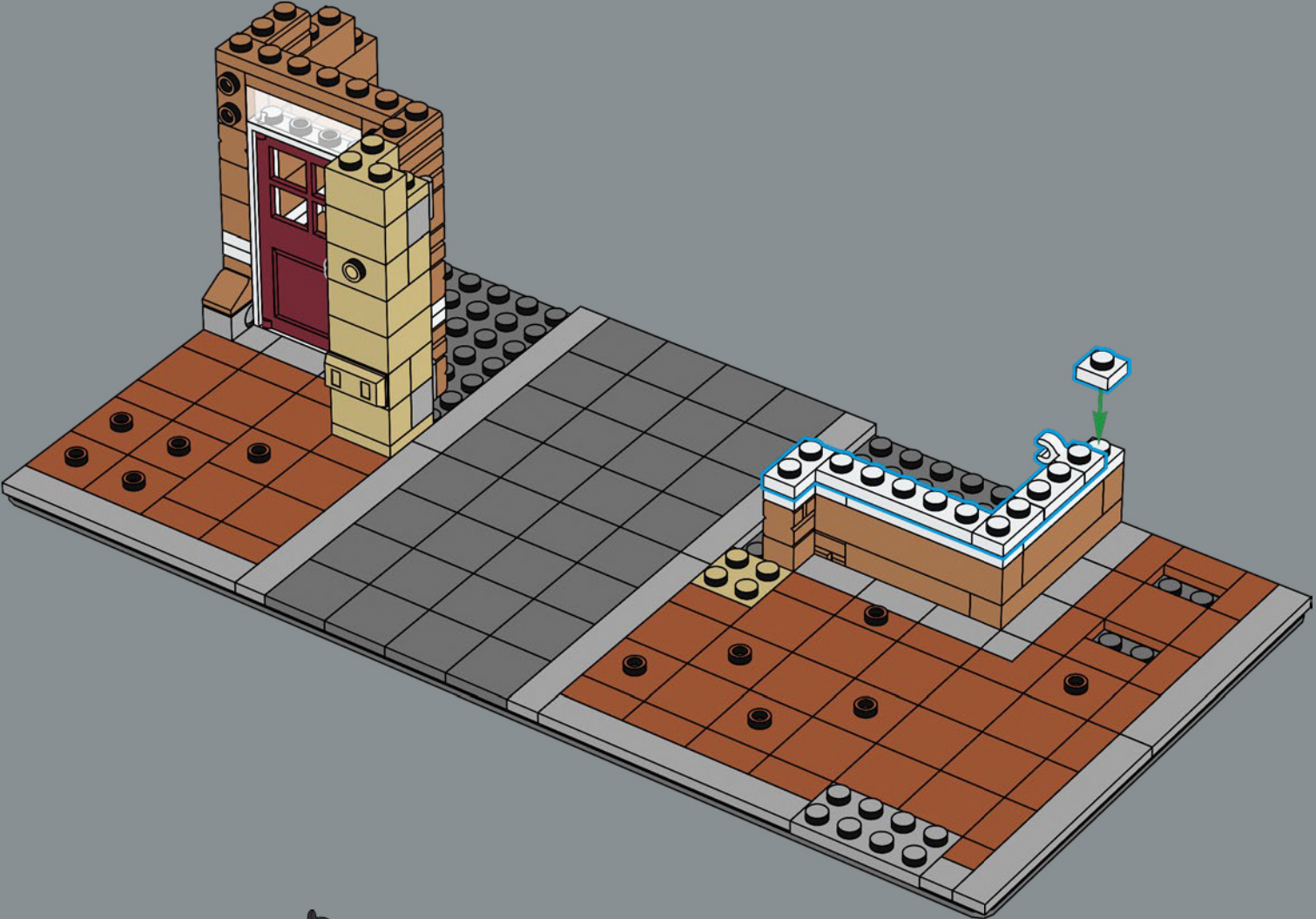

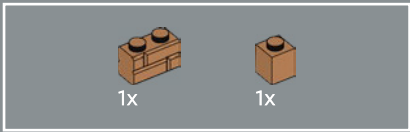

27

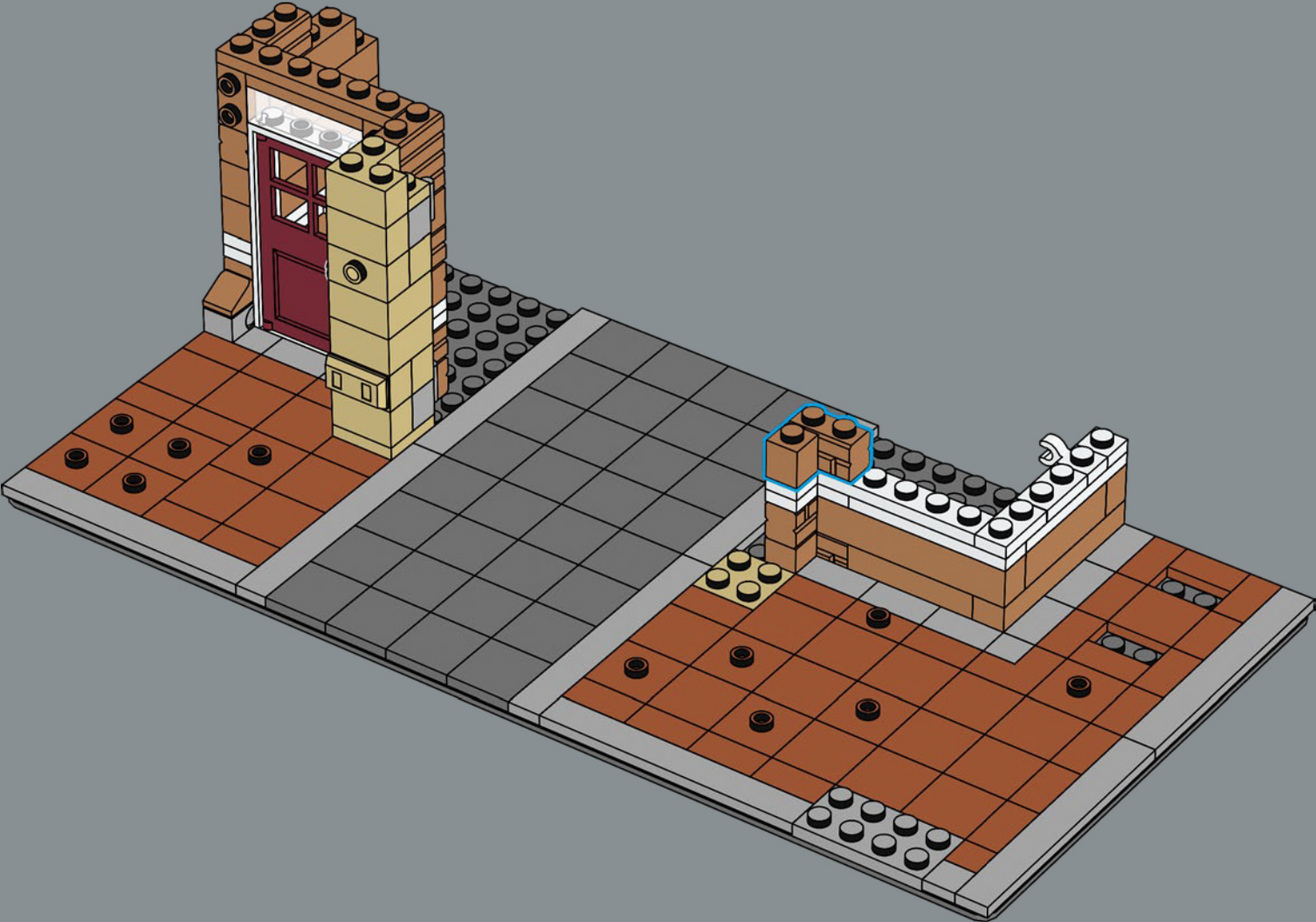

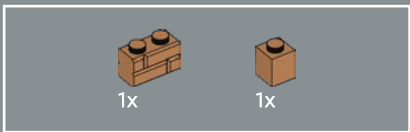

28

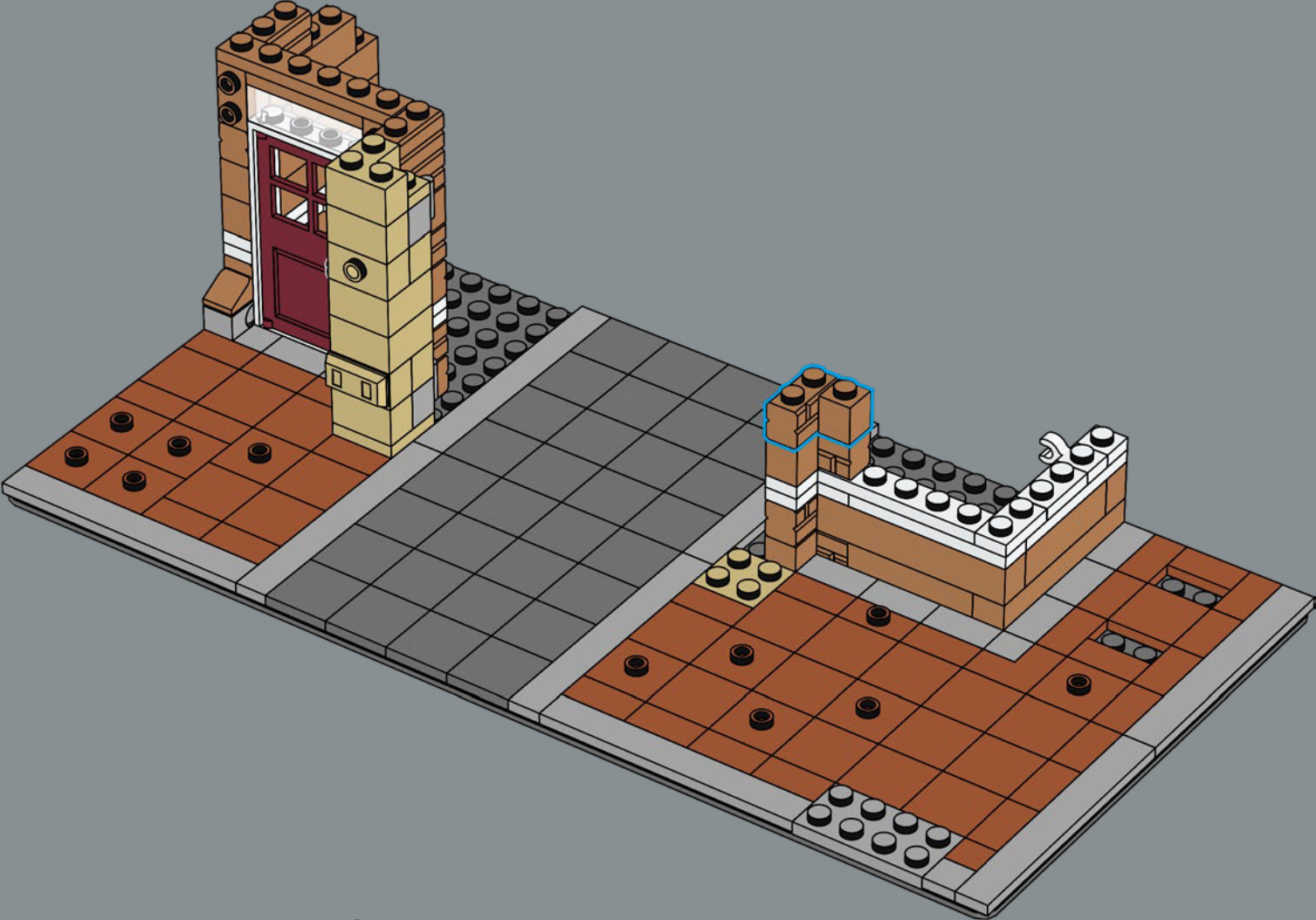

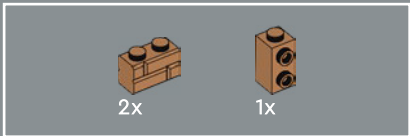

30

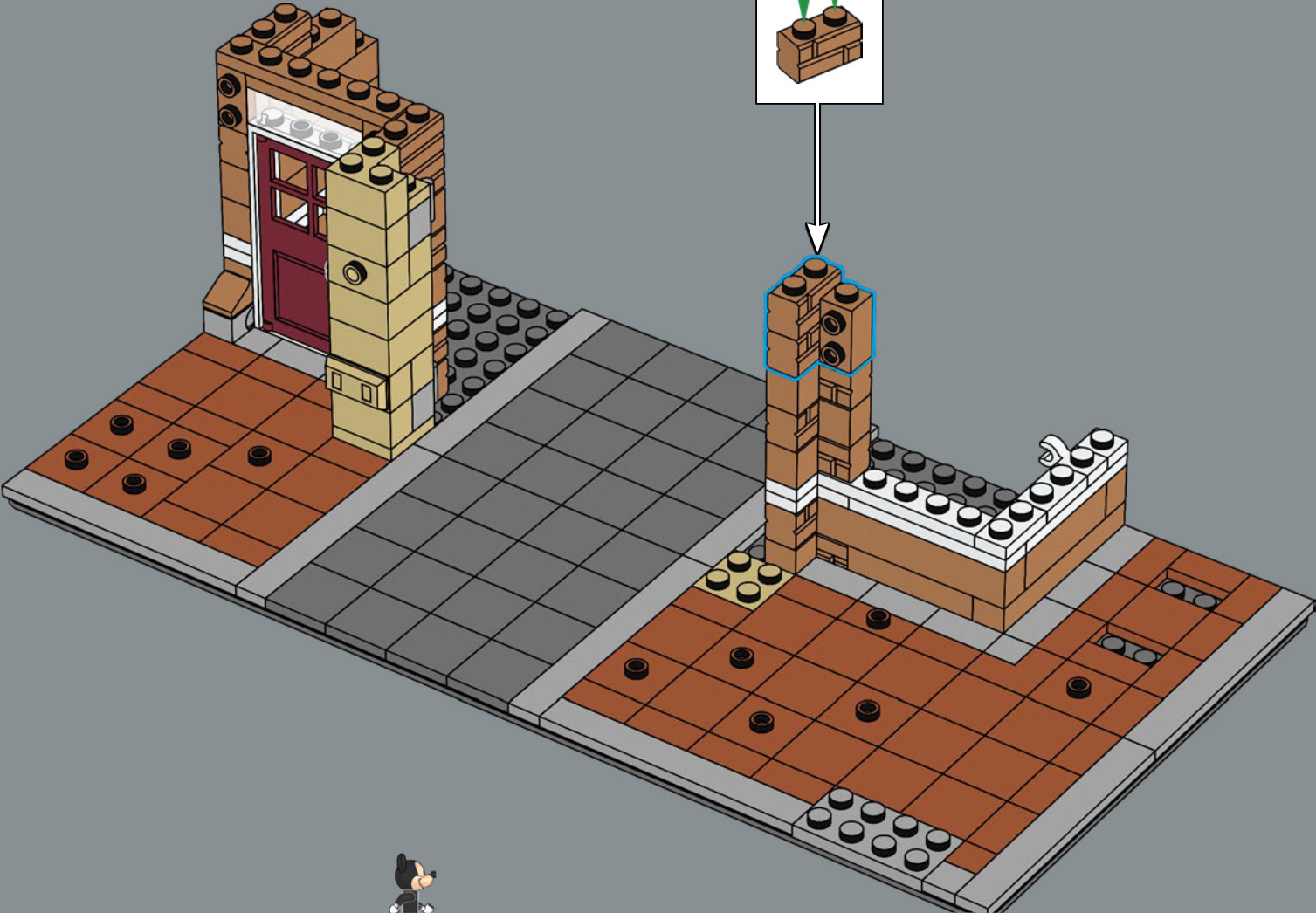
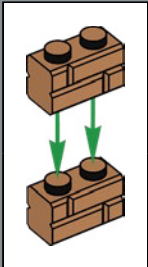

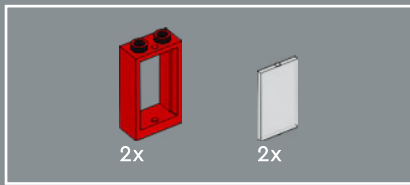

31

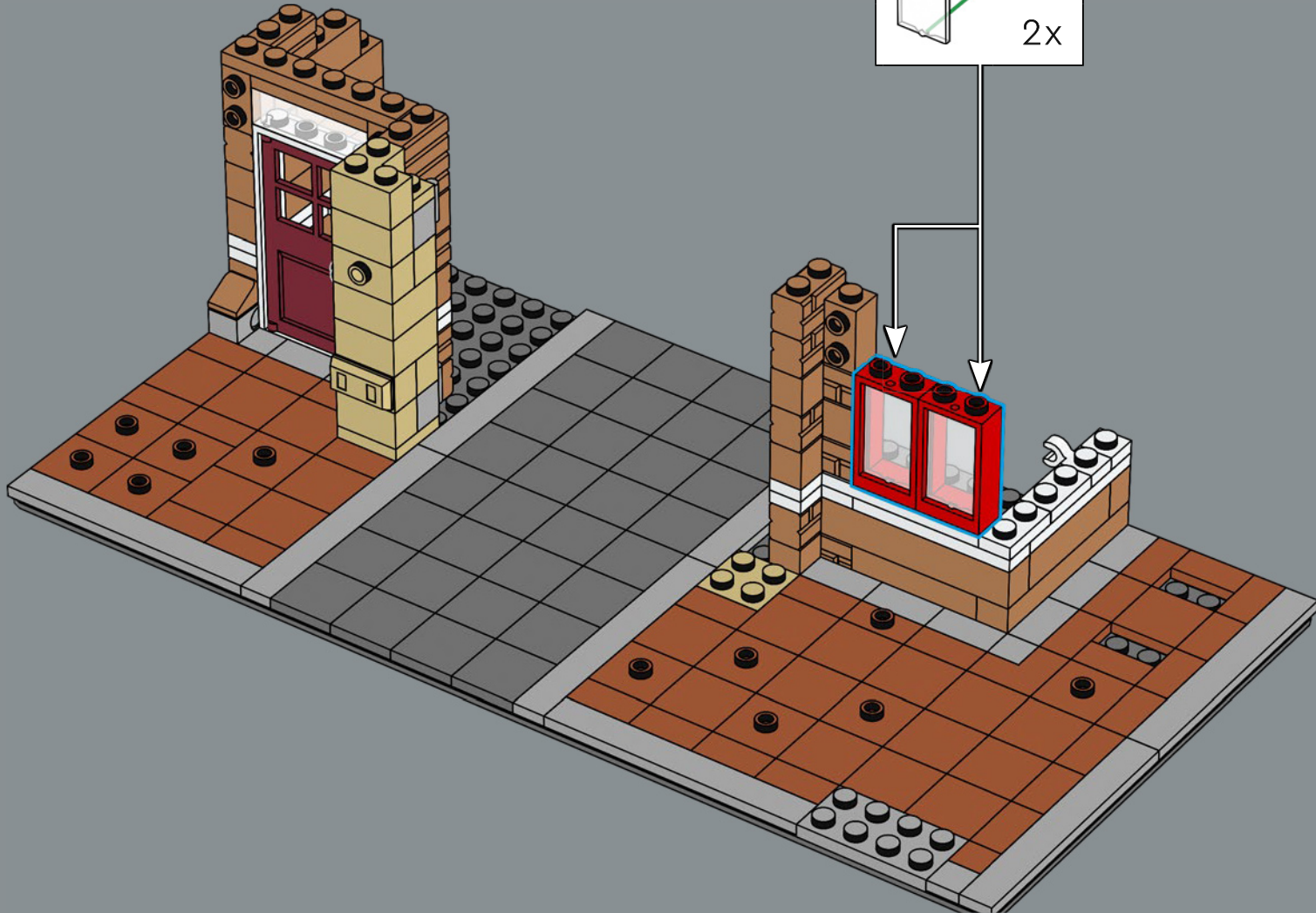
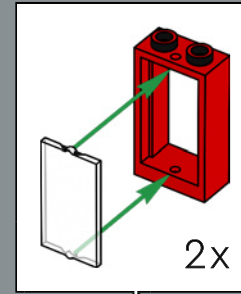

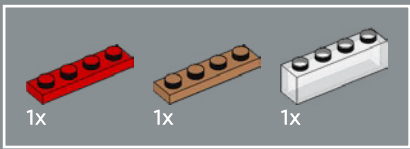

32

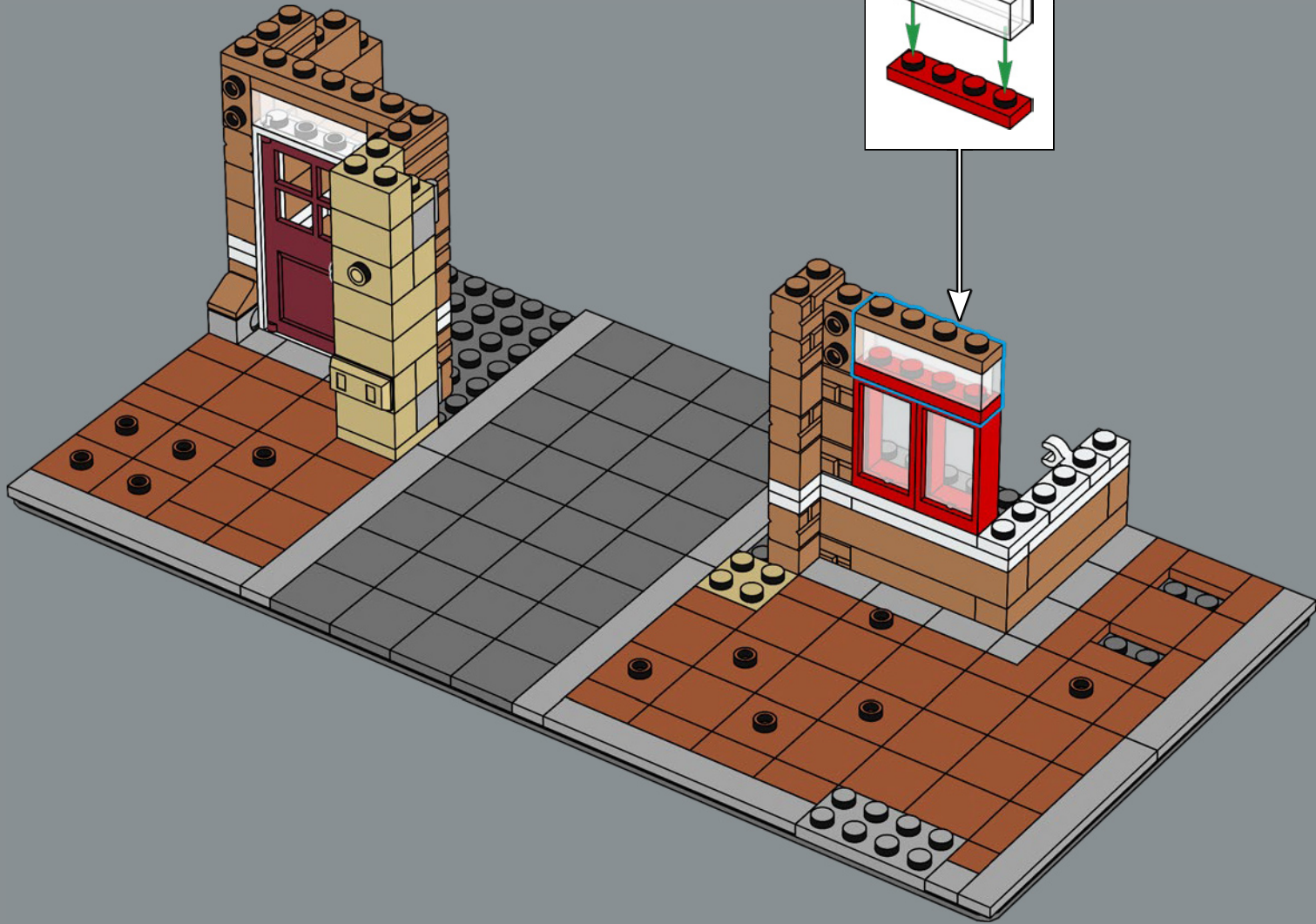

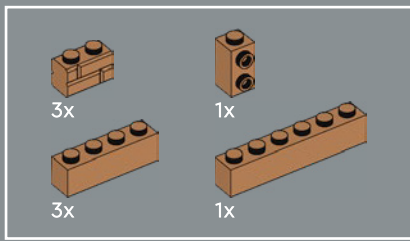

33

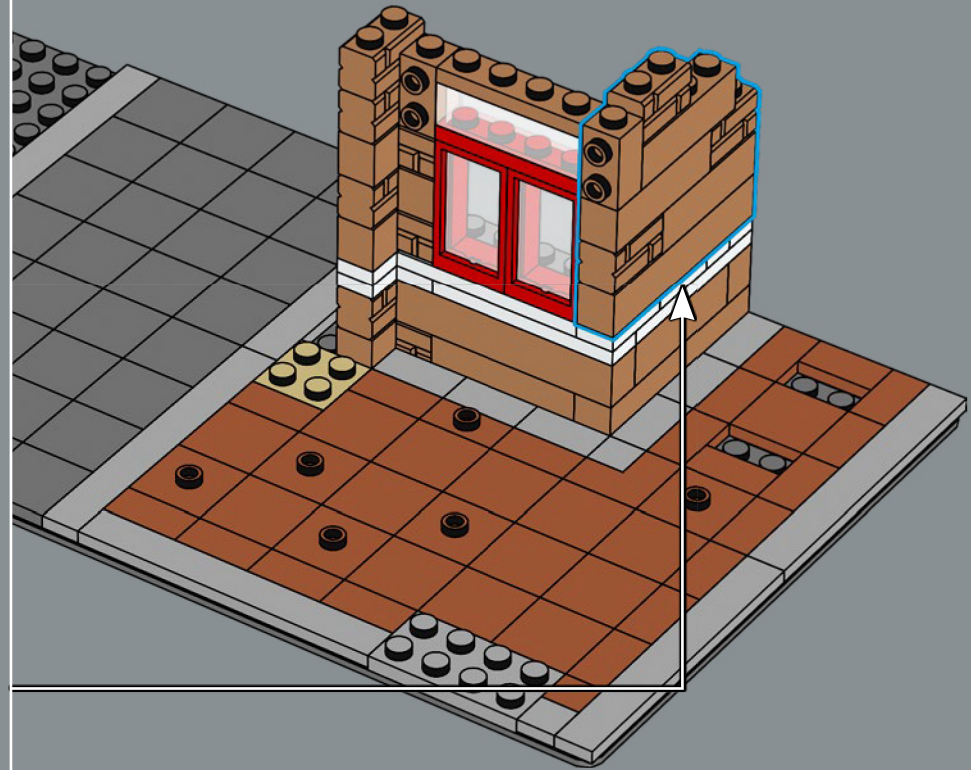
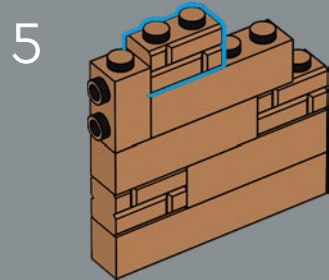
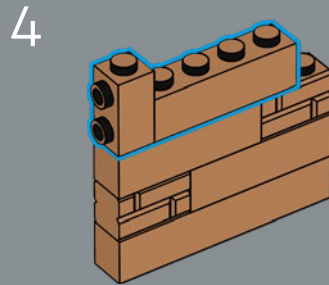
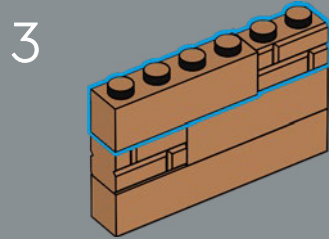
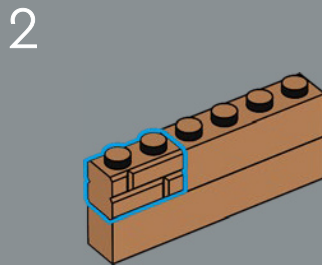
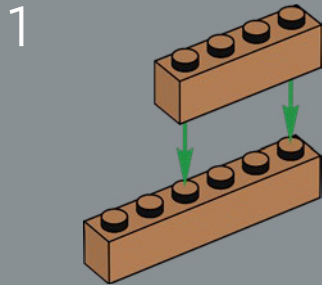

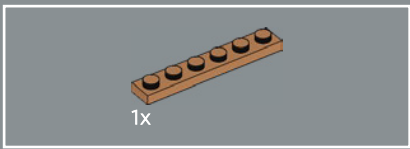

34

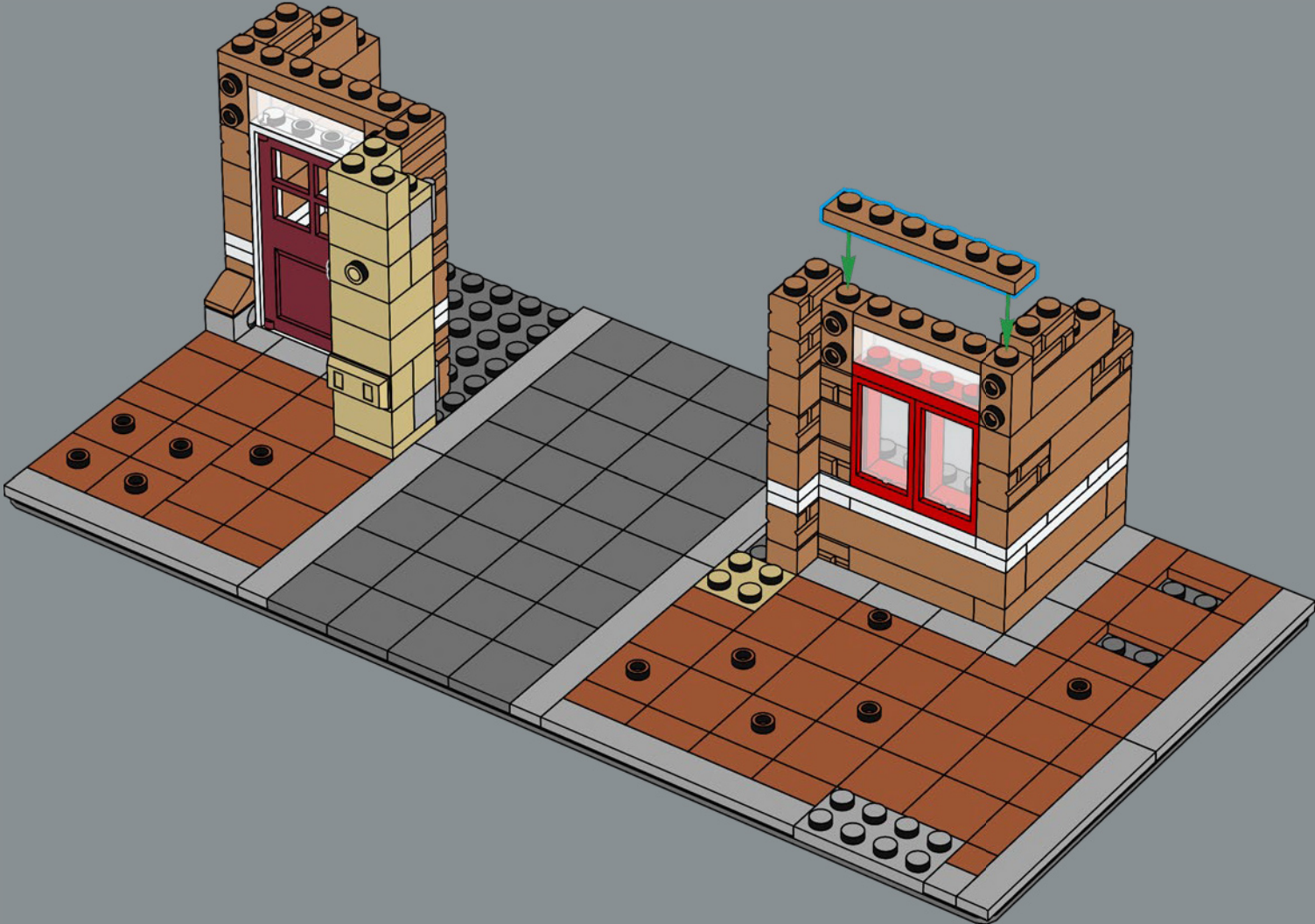

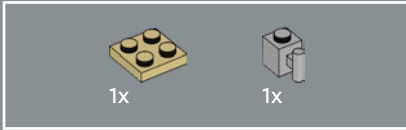
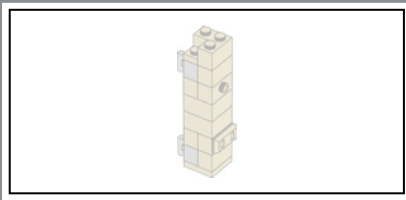

35

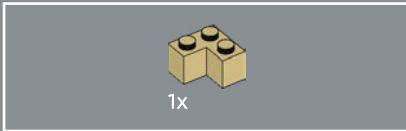
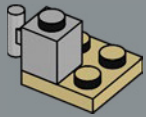

36

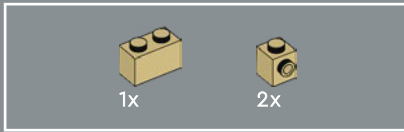
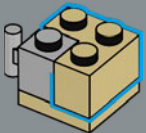

37

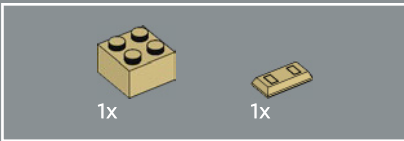
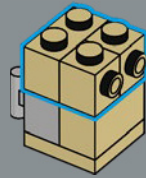

38

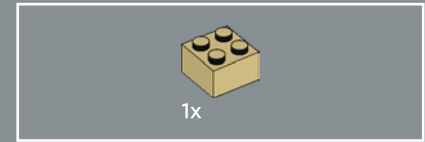
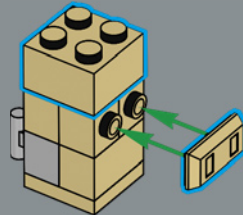

39

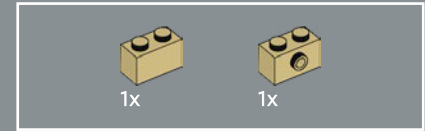
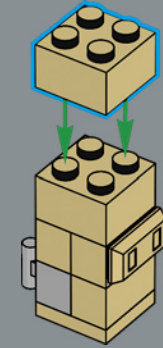

40

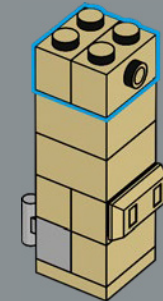

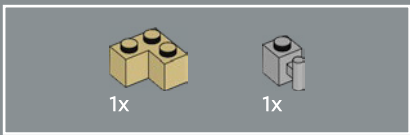

41

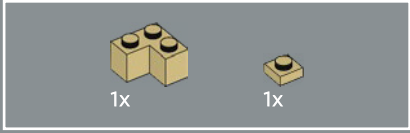
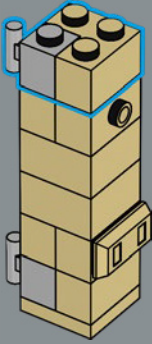

42

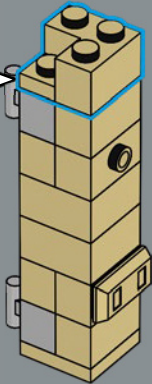

43

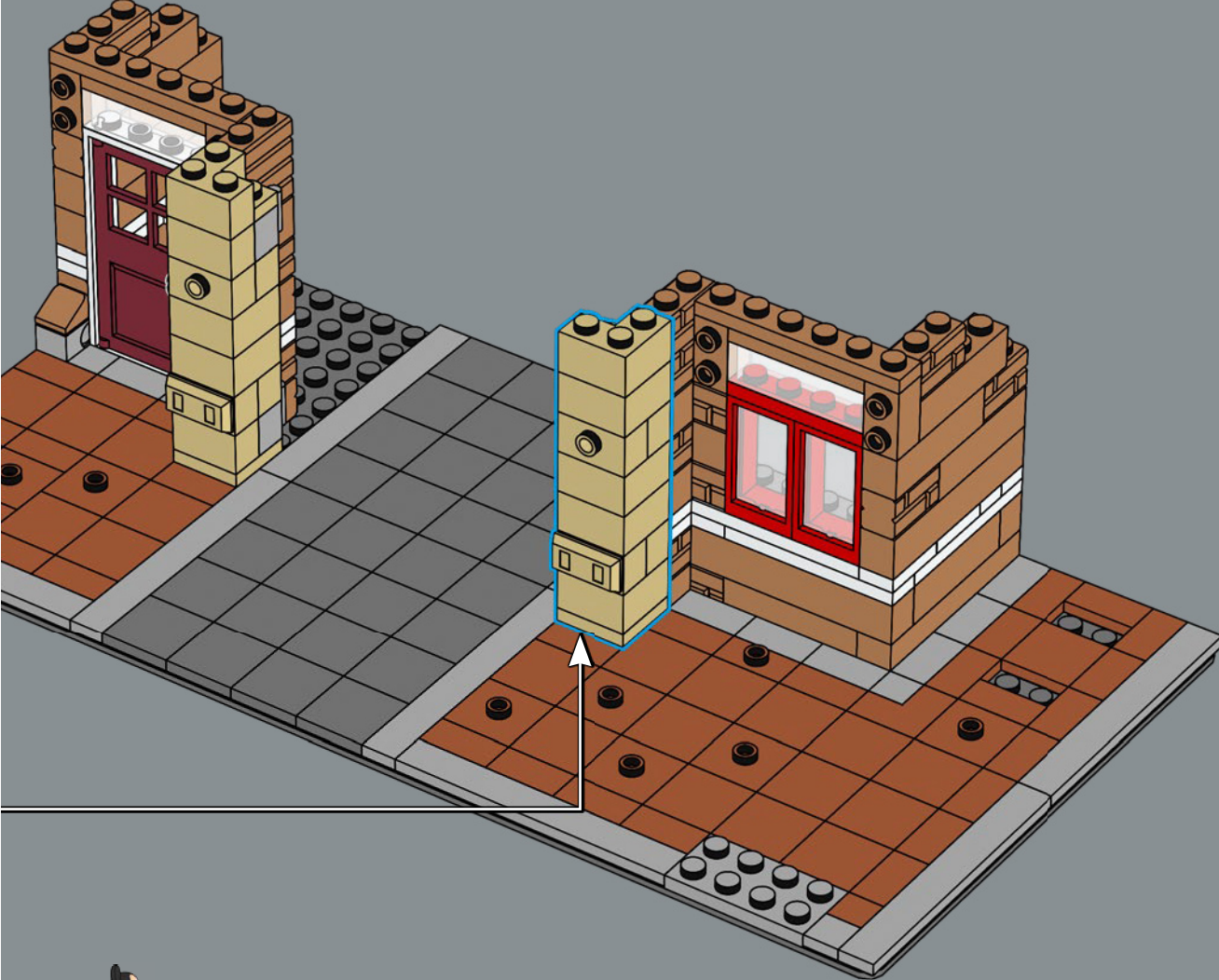

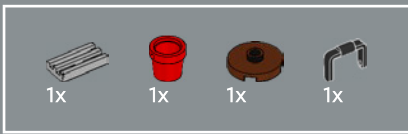

44

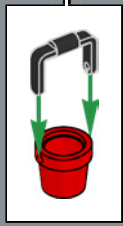
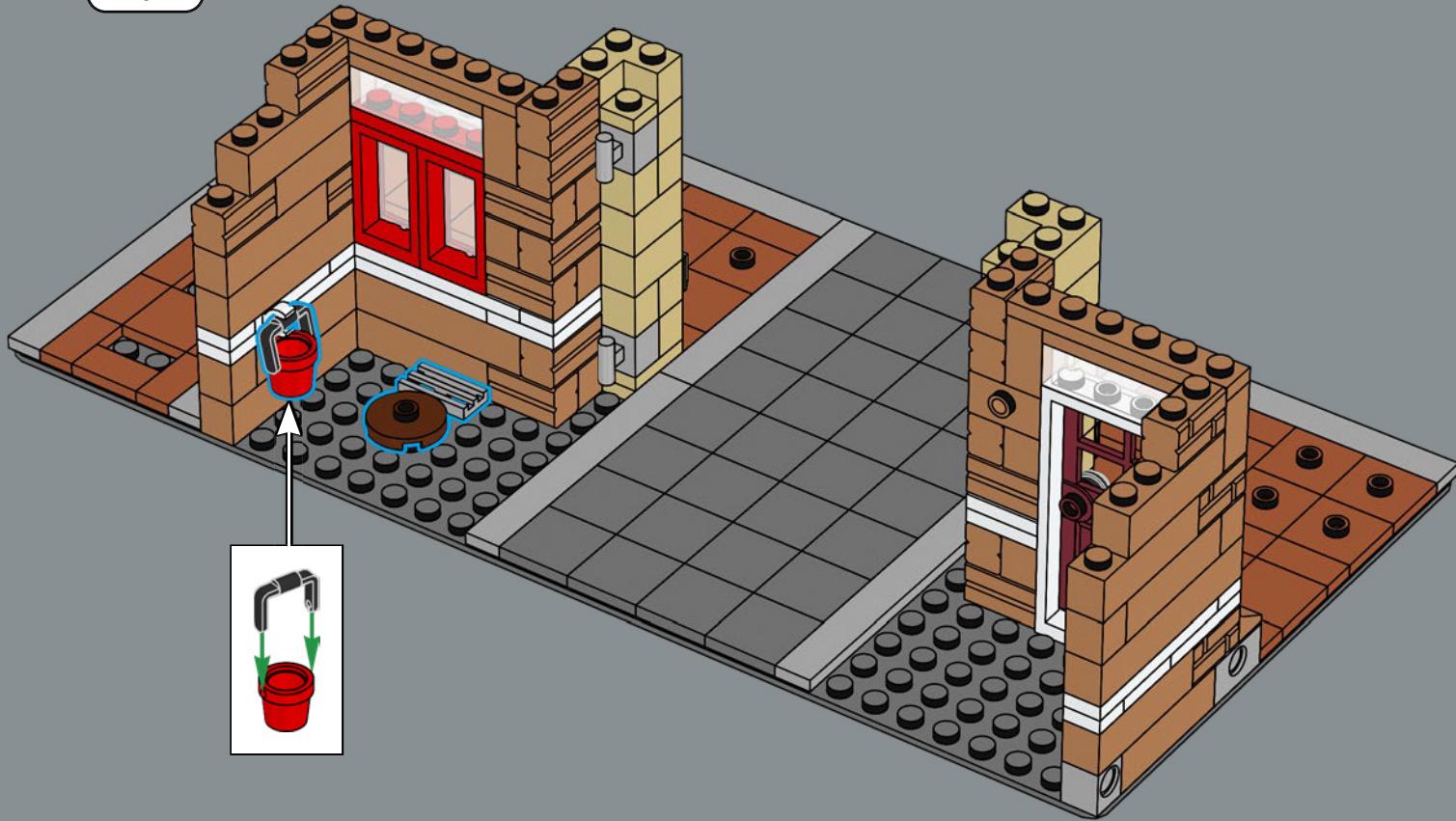



45

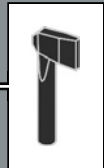
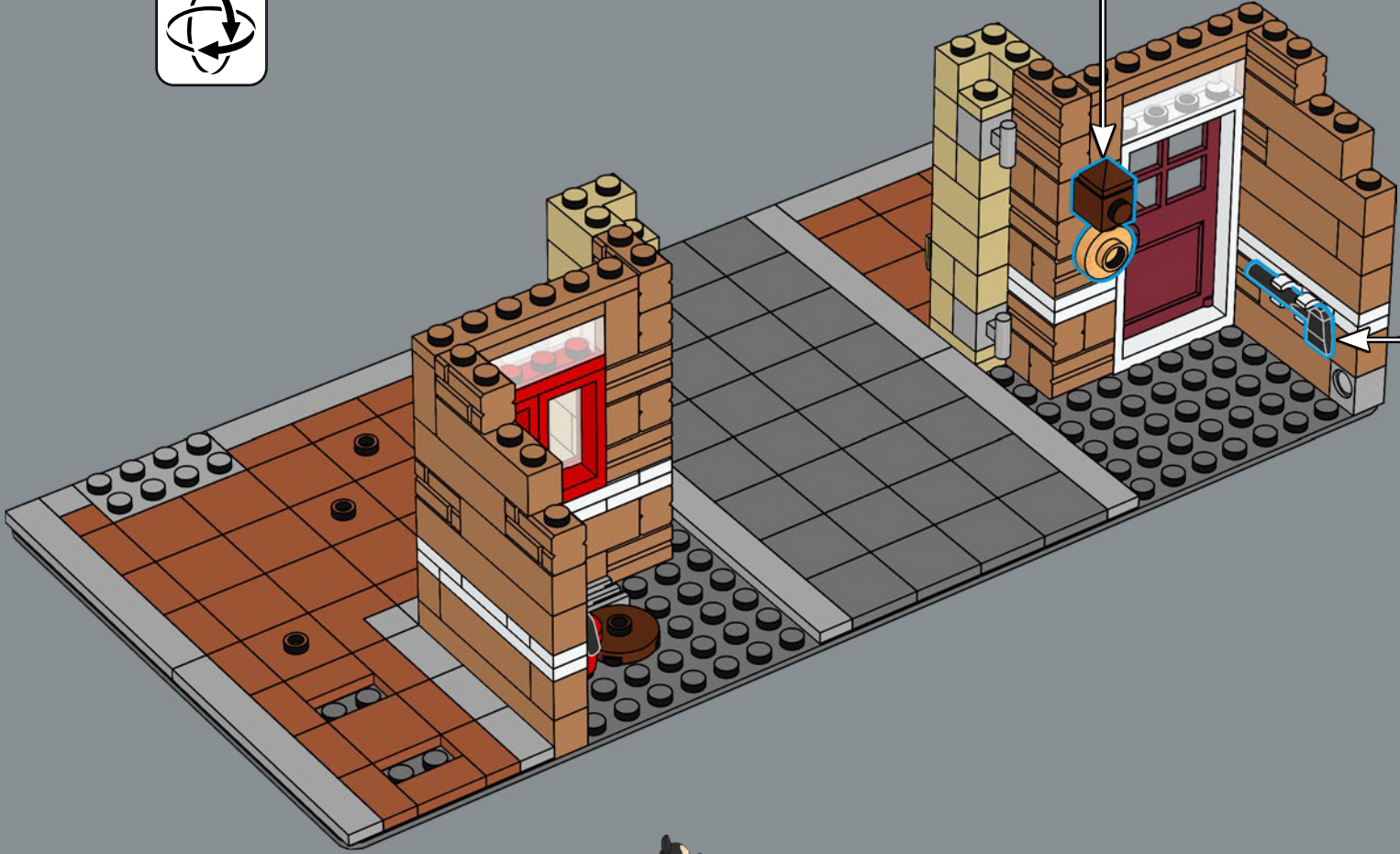
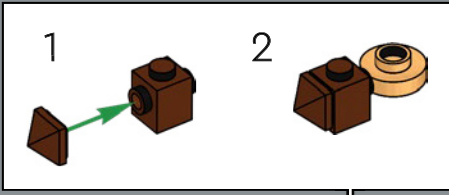



The new straw boater hat element is used for the iconic Dapper Dans singers.

Un nouveau canotier a été conçu pour représenter les célèbres chanteurs Dapper Dans.

Los icónicos cantantes Dapper Dans llevan en la cabeza un nuevo elemento que representa un sombrero de paja.

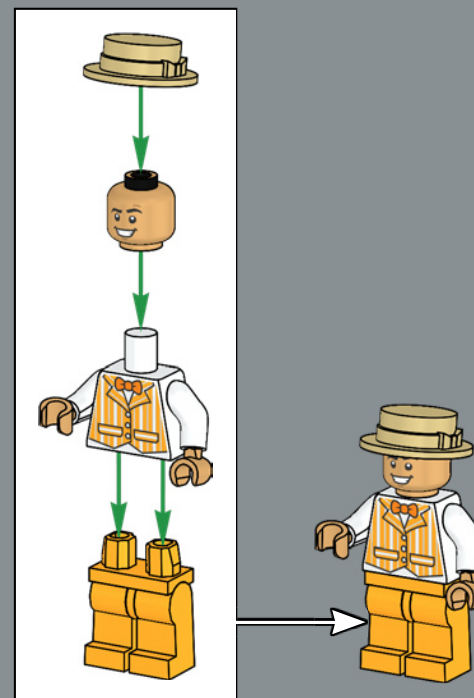

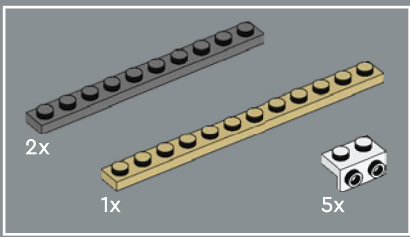

46

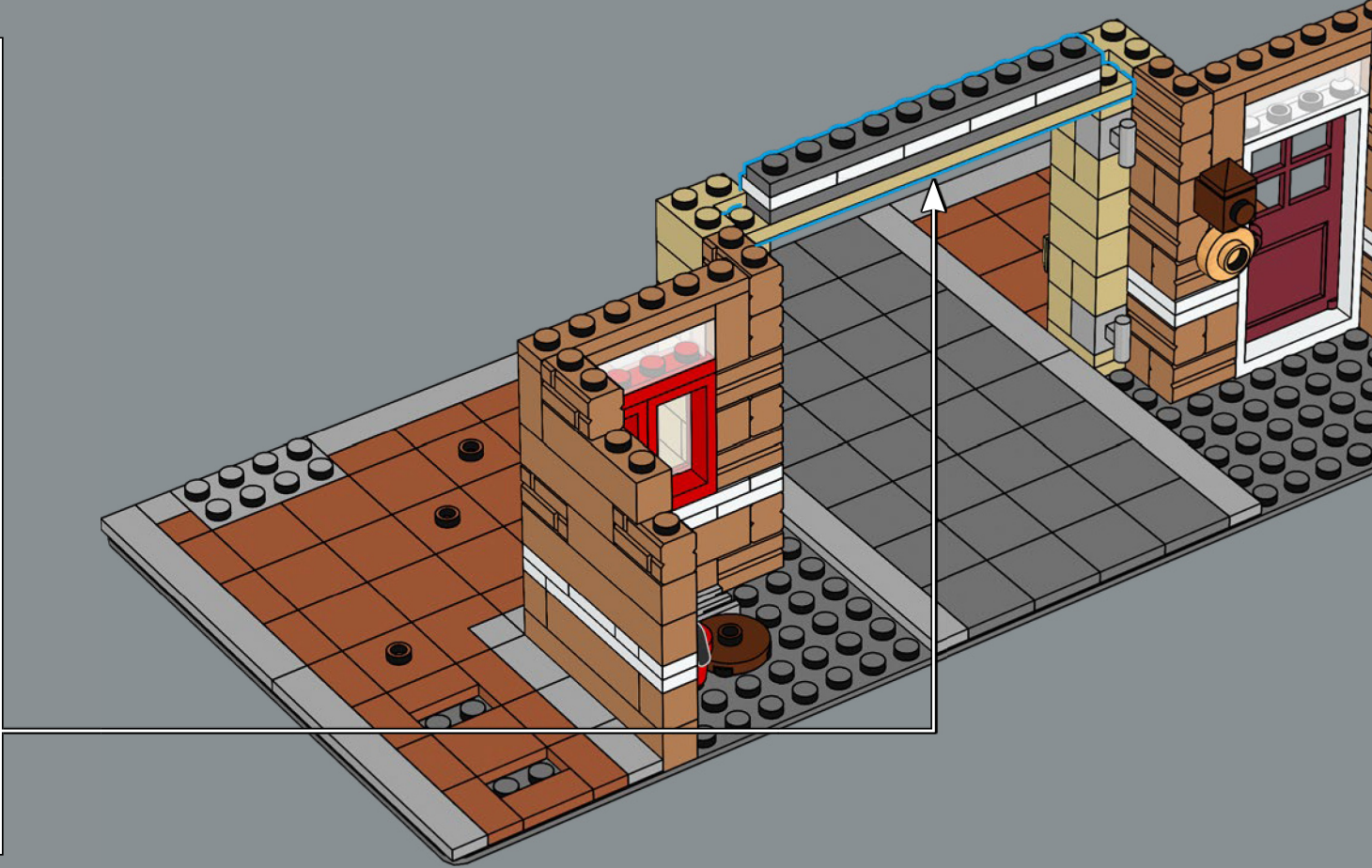
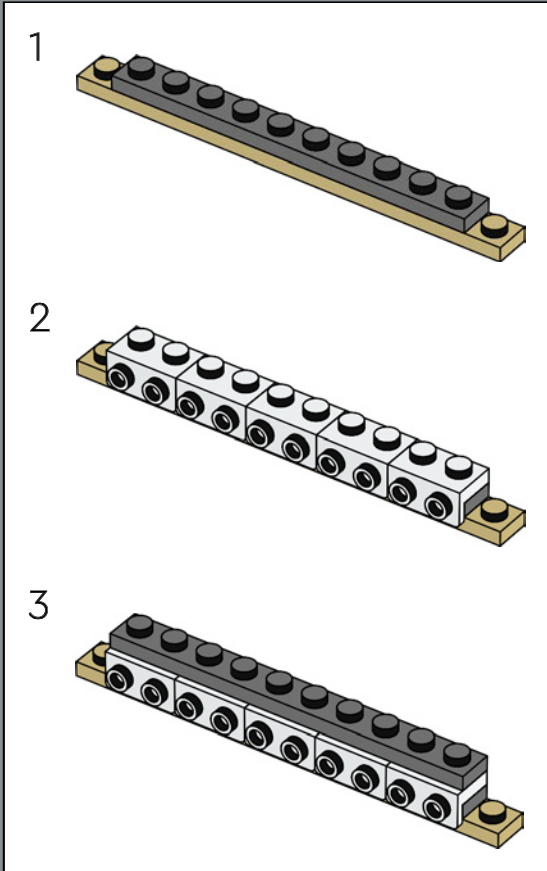

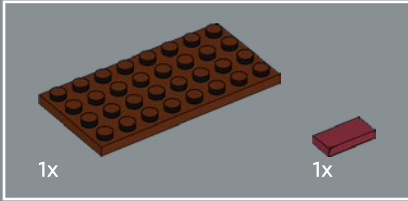
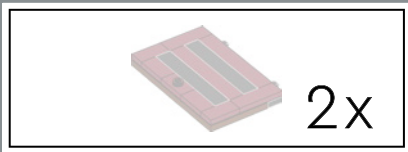

47

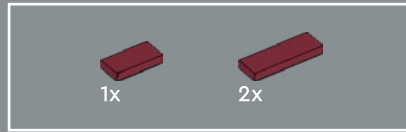
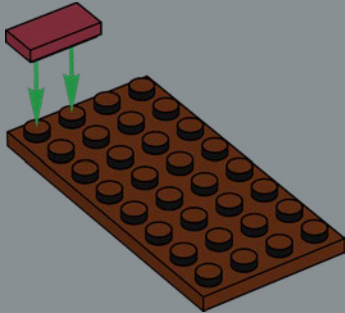

48

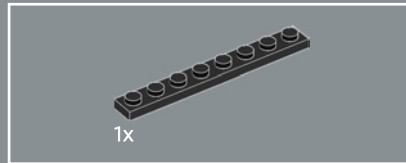
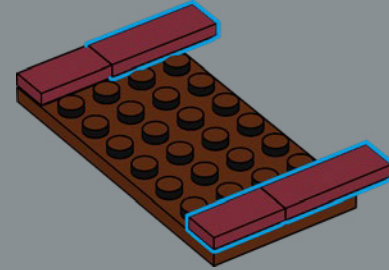

49

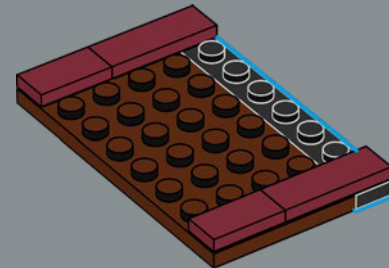

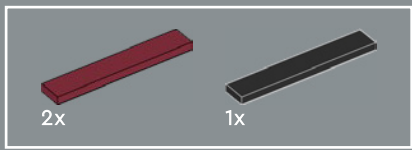

50

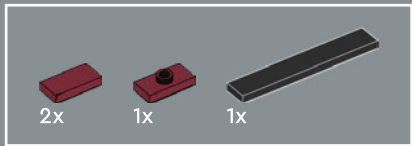
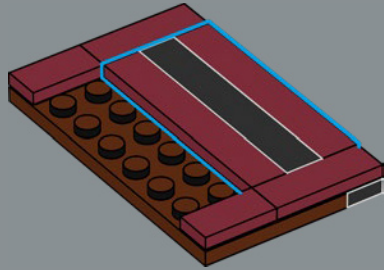

51

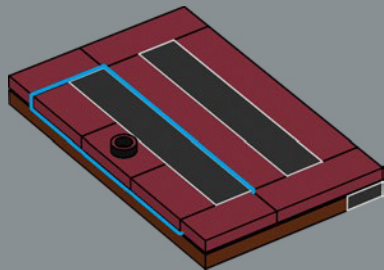

52

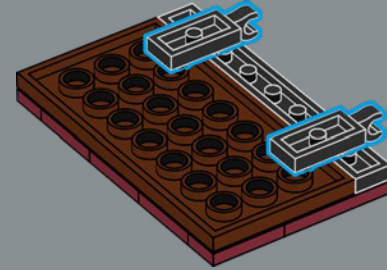

53

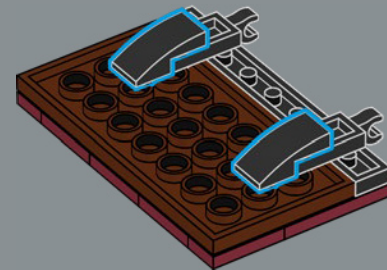

2x



54

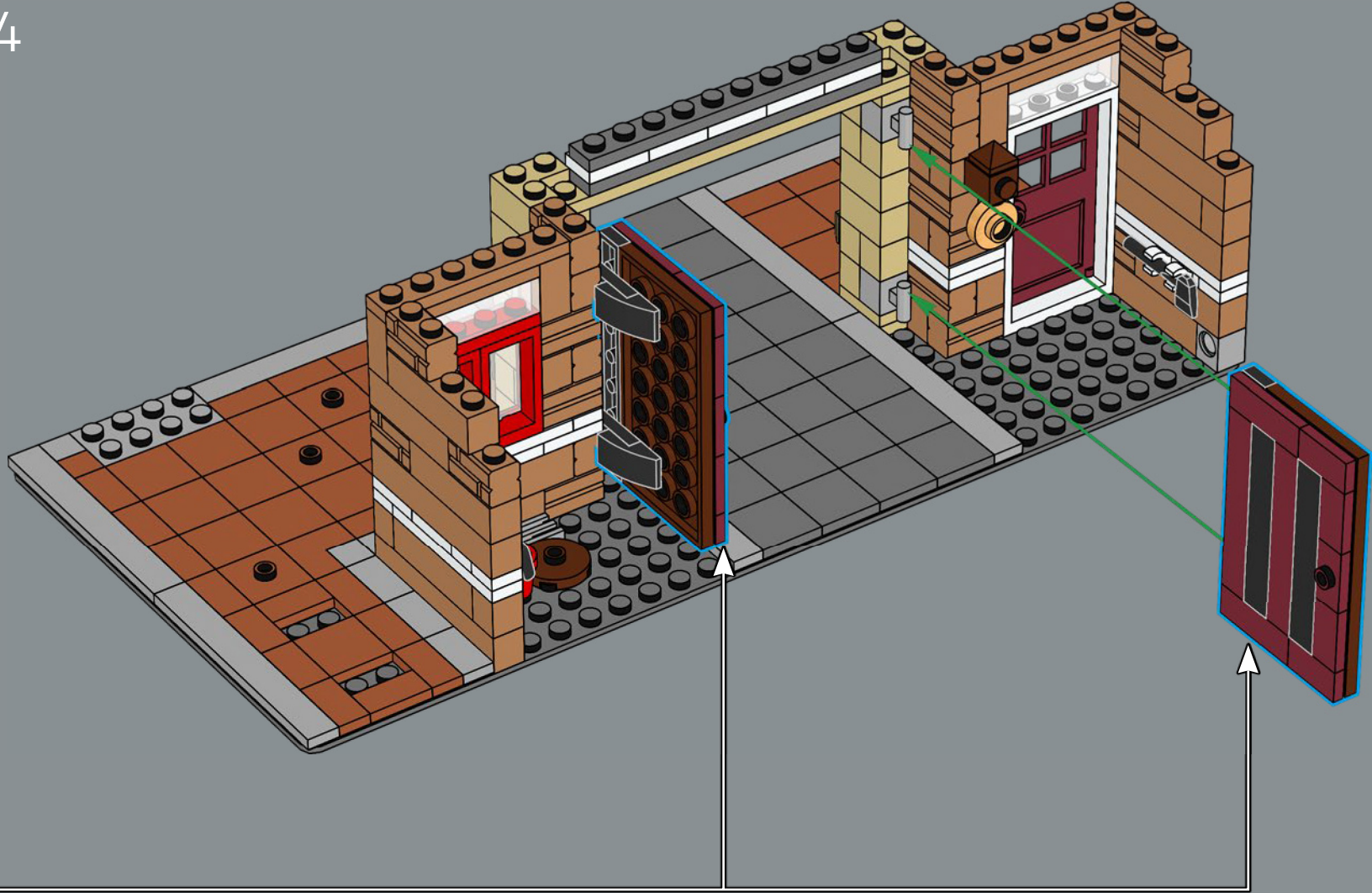

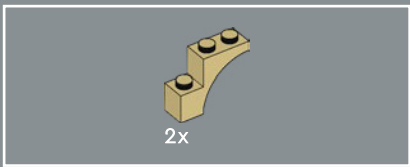

55

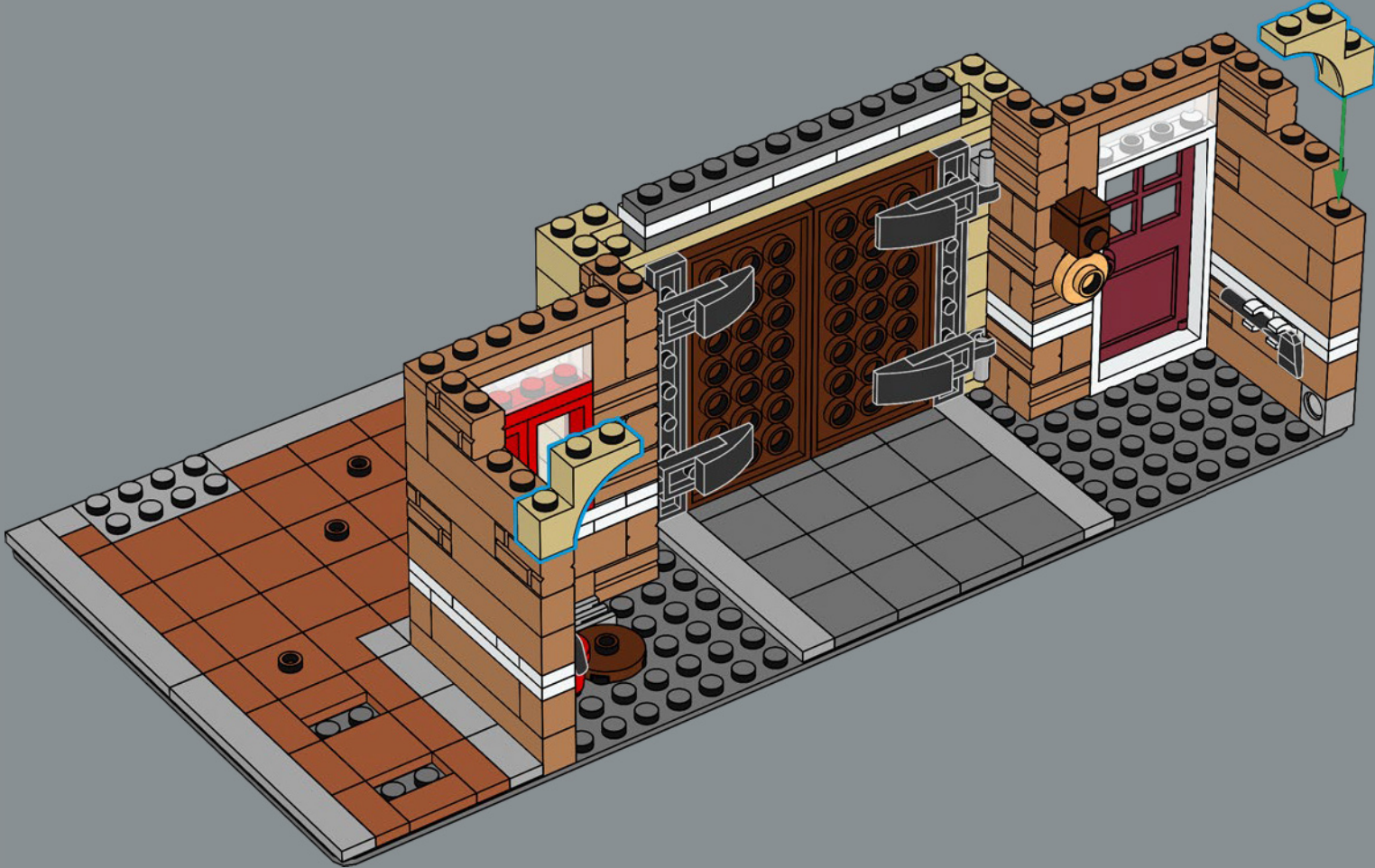

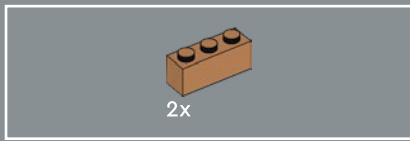

56

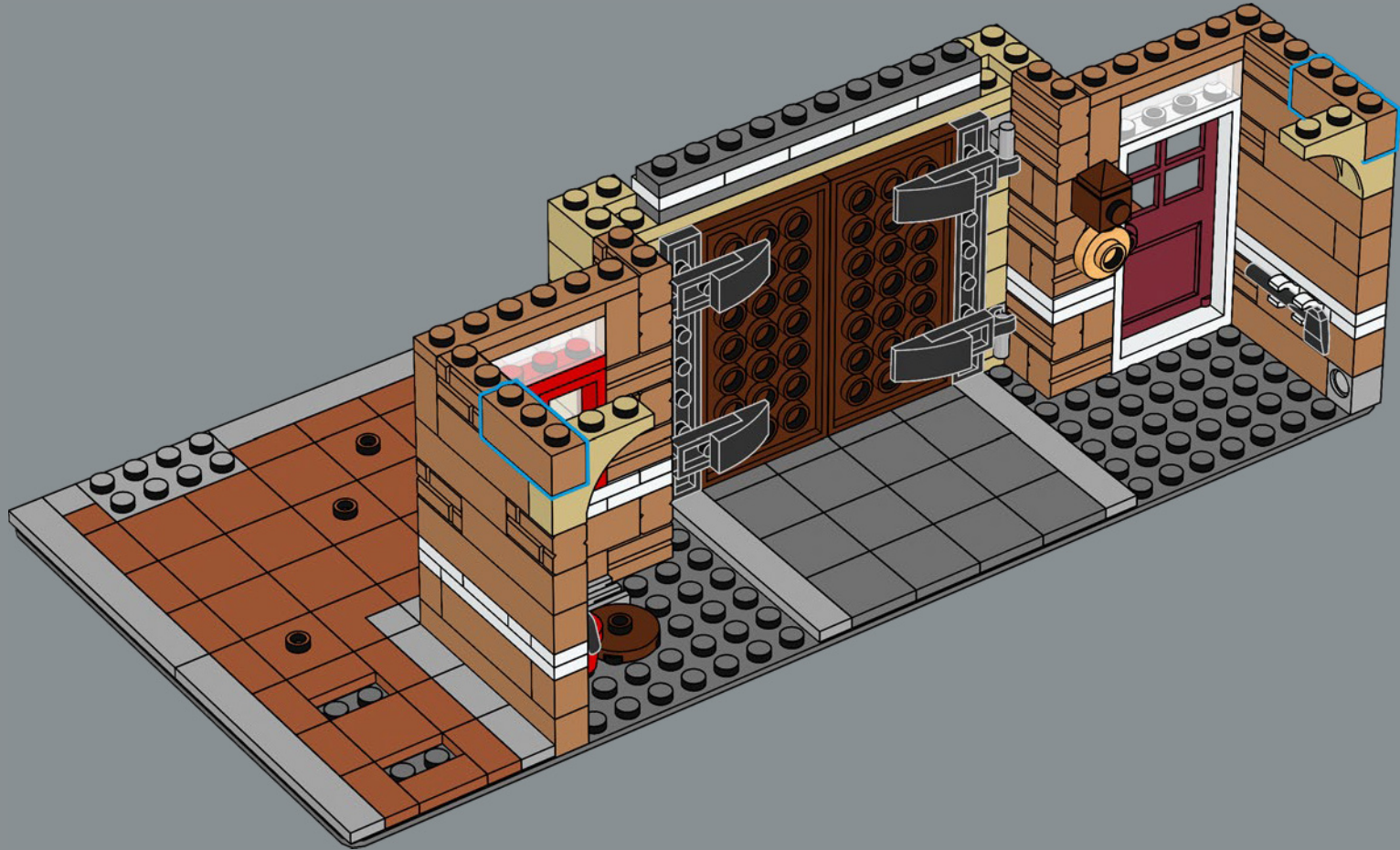

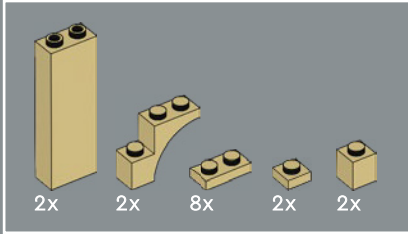
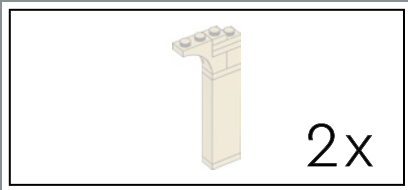

57

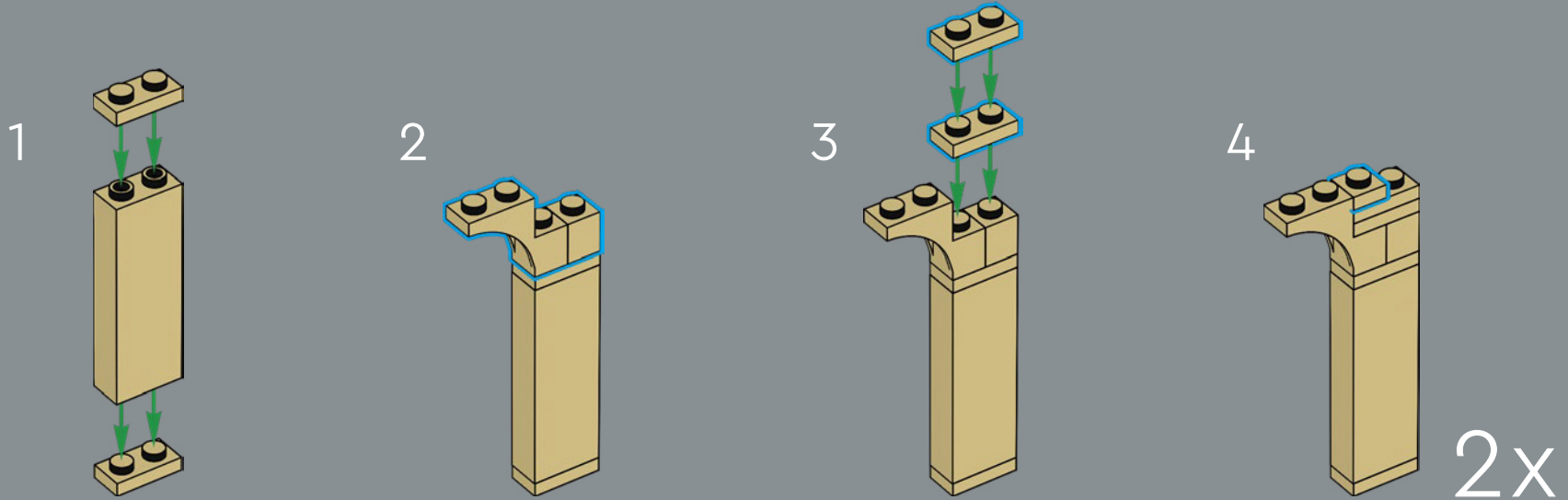

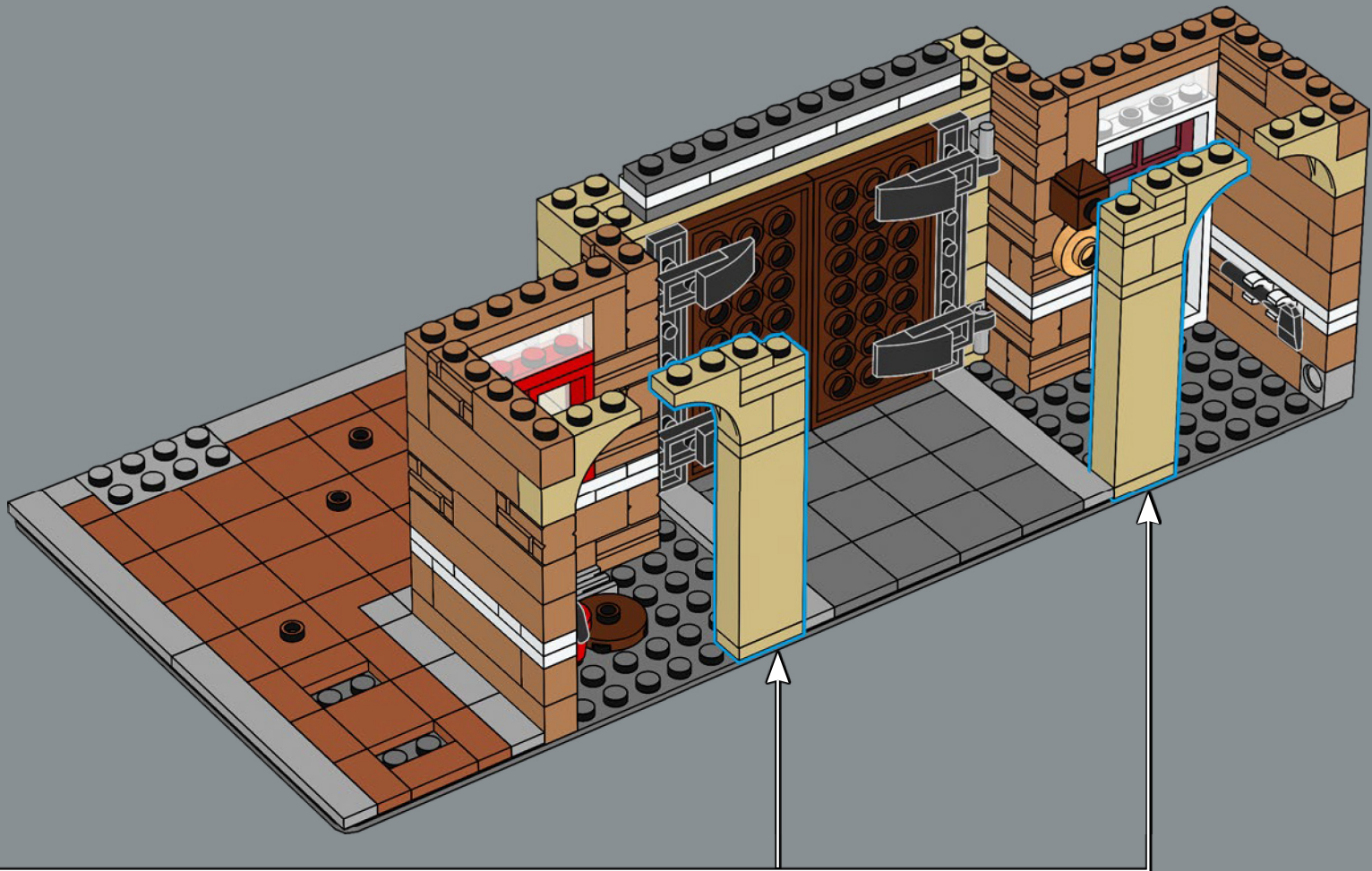

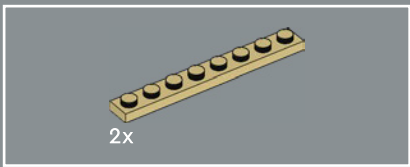

58

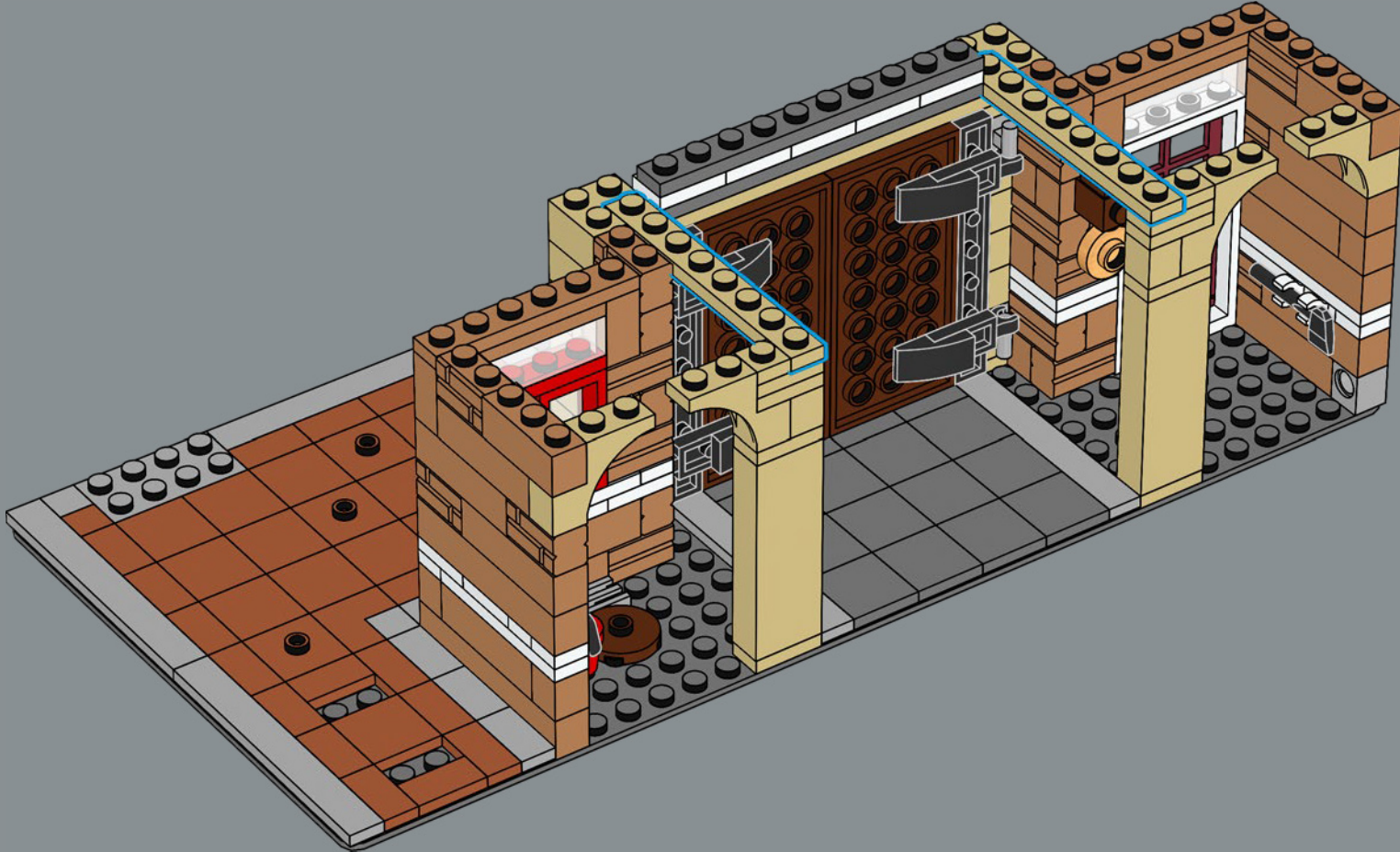

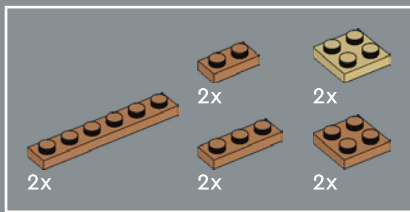

59

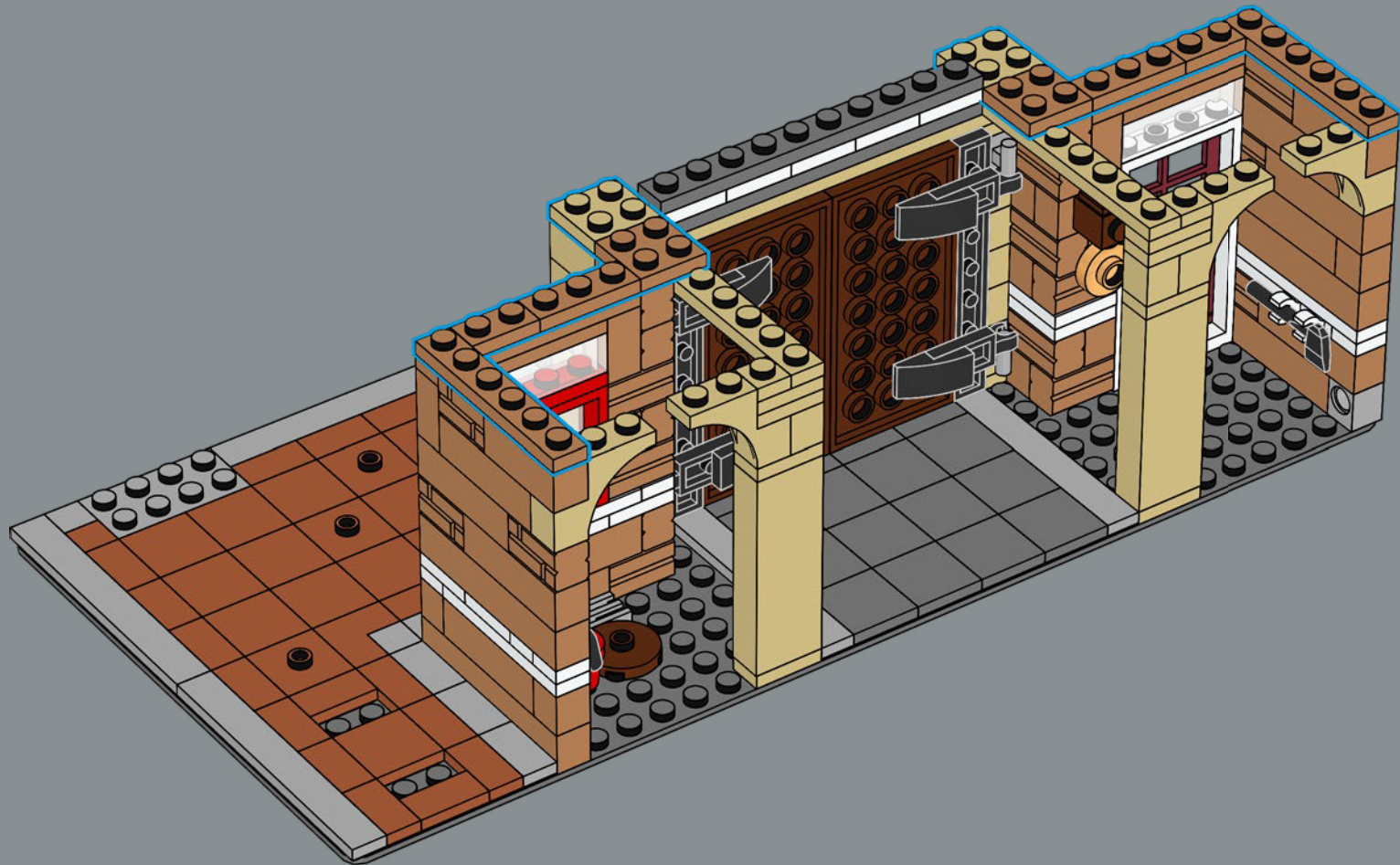



60

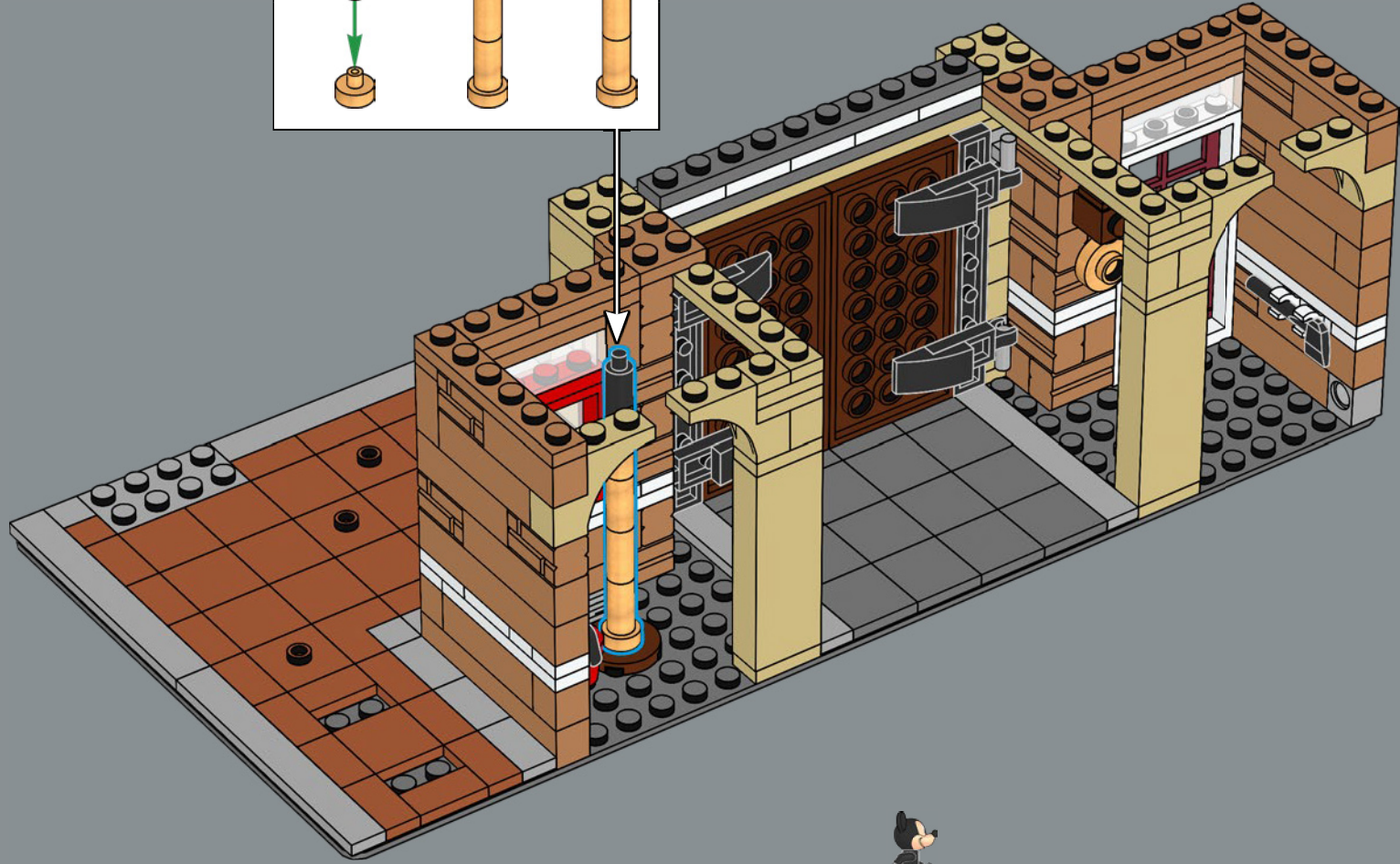
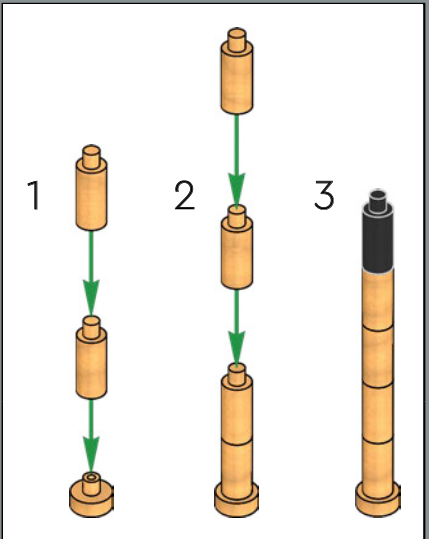

The fire pole was originally used by Walt Disney, but the hole was sealed after a determined park guest climbed the pole and entered the private apartment.

Le poteau de pompier dans la caserne a déjà été utilisé par Walt pour descendre, mais l'ouverture a été scellée après qu'un visiteur déterminé a réussi à grimper jusqu'à l'appartement privé.

Walt Disney solía usar el tubo de bomberos, pero su abertura se cerró luego de que un decidido visitante del parque trepara por él e ingresara al departamento privado.



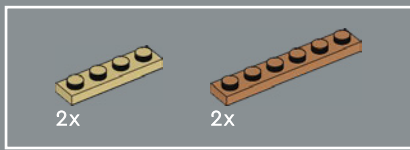

61

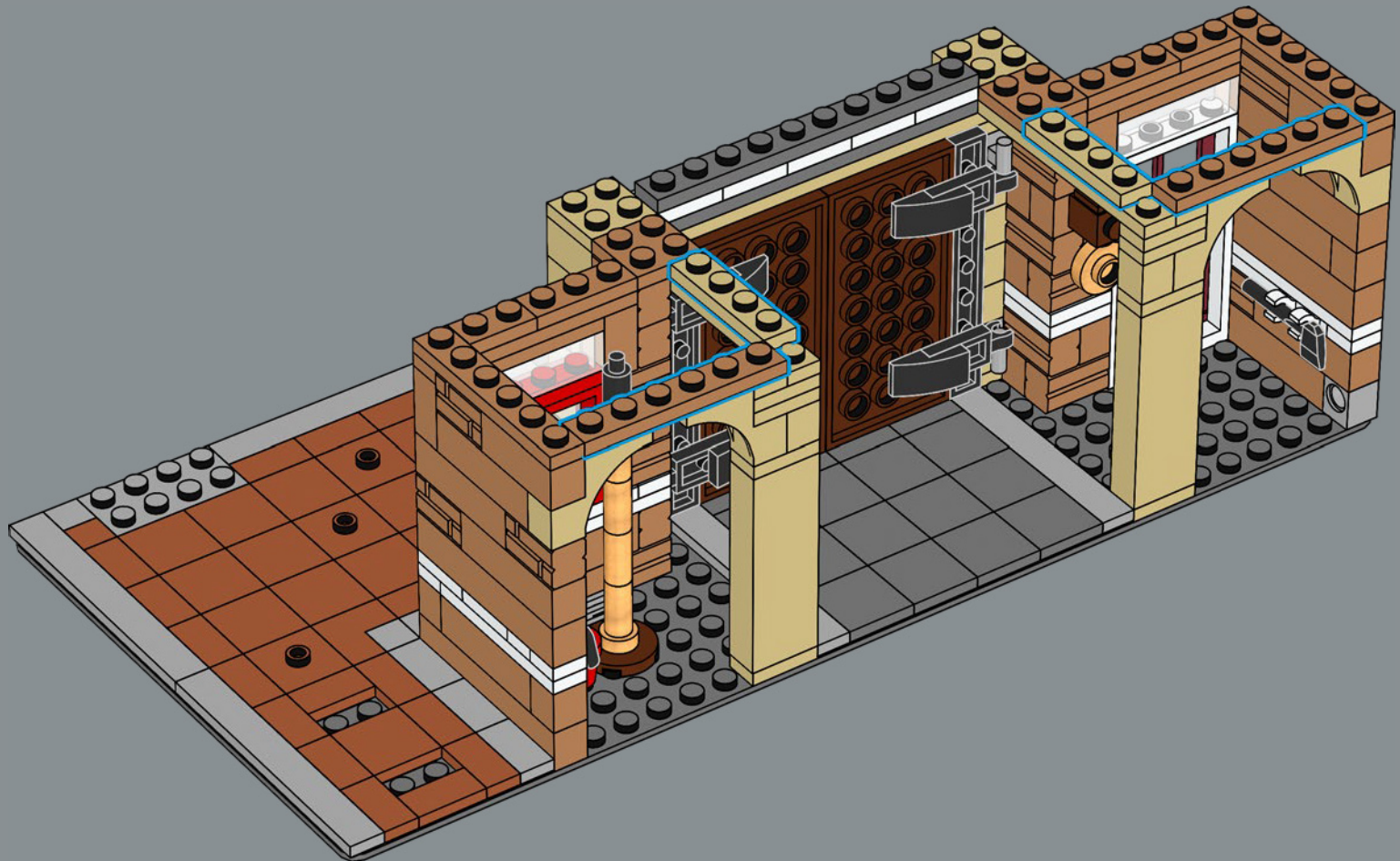

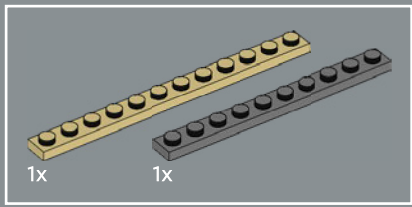

62

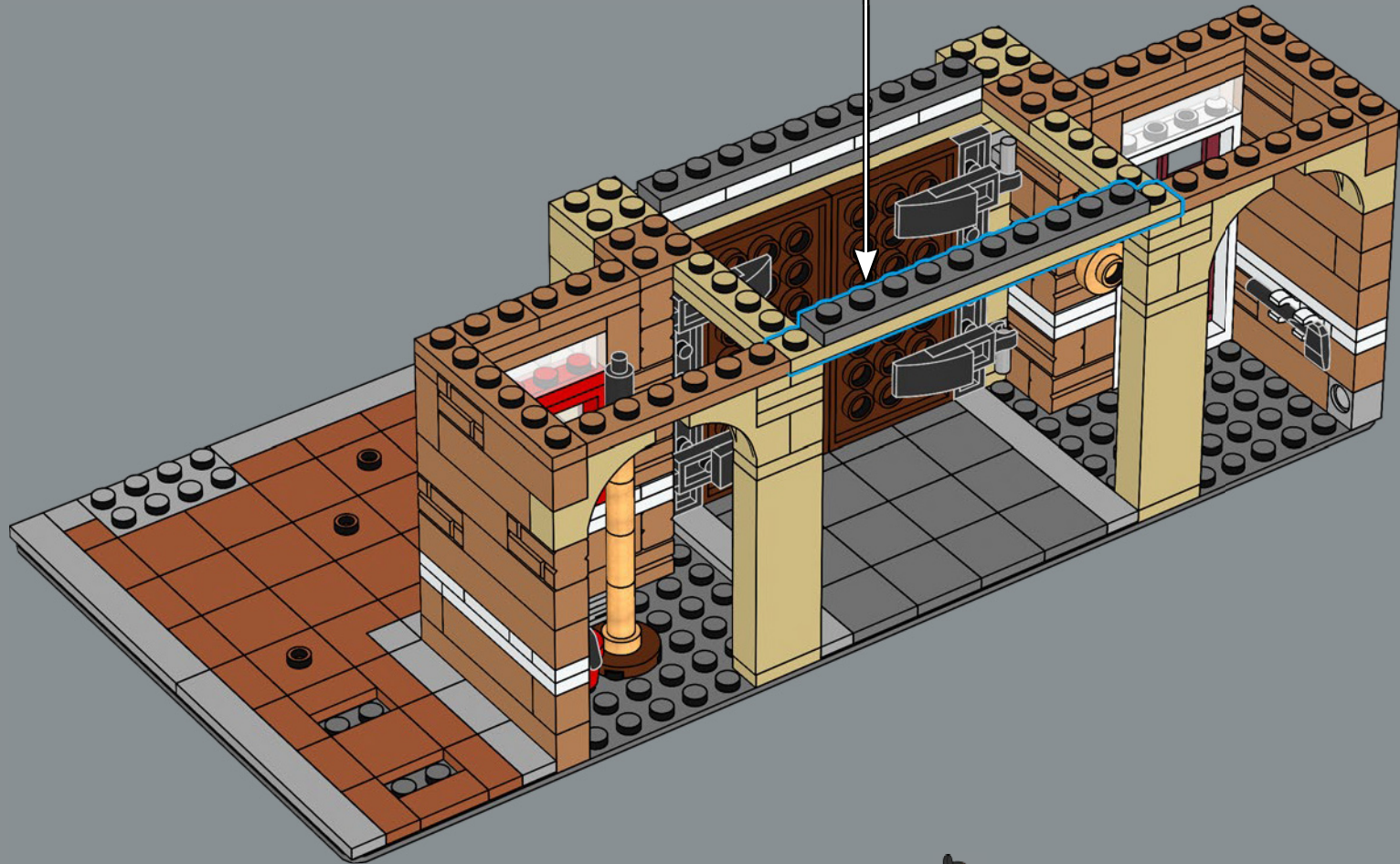
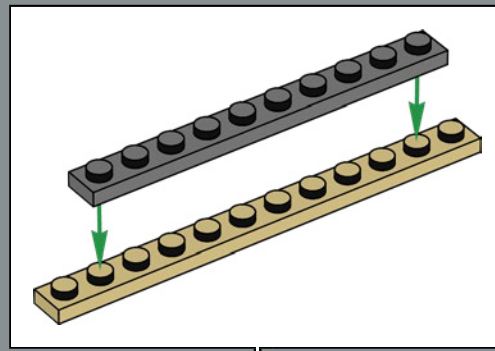

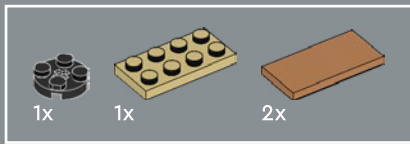

63

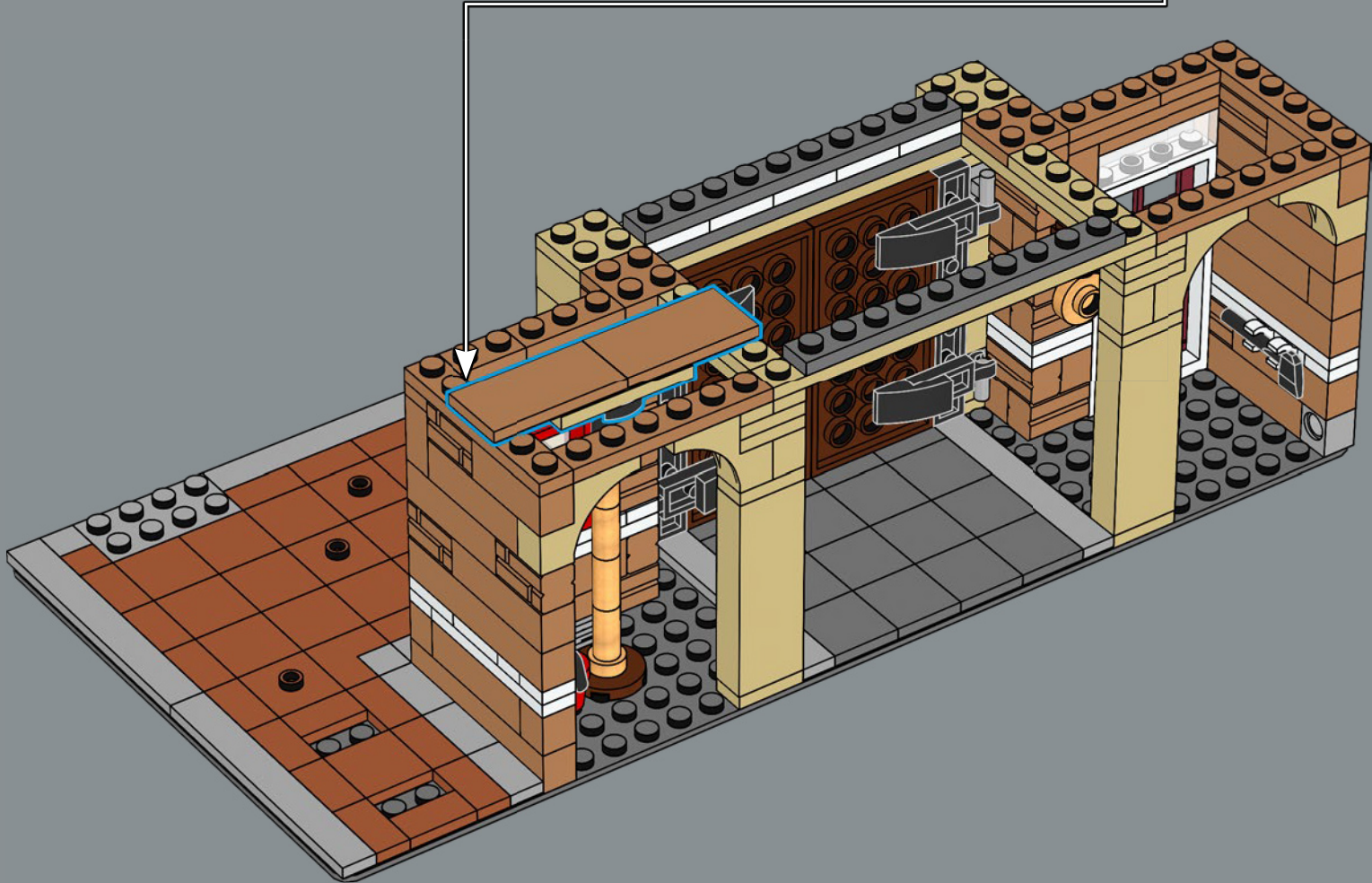
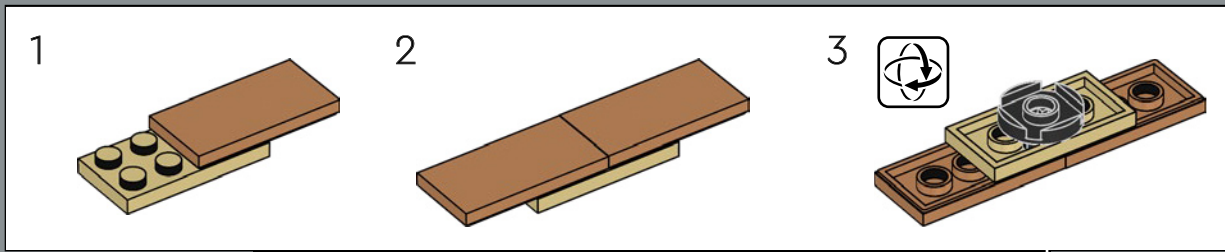

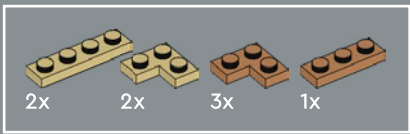

64

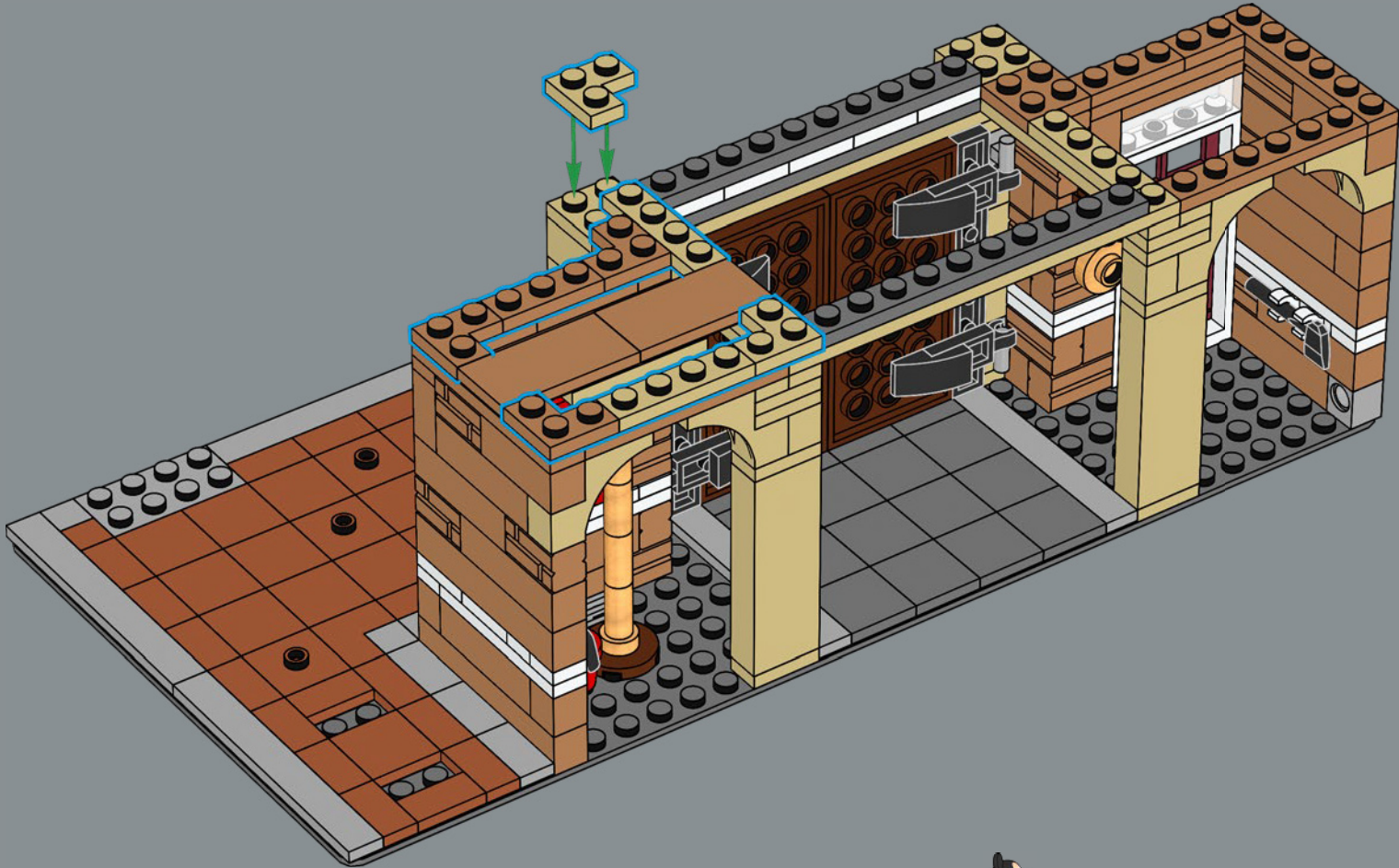

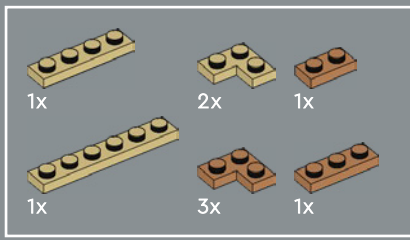

65

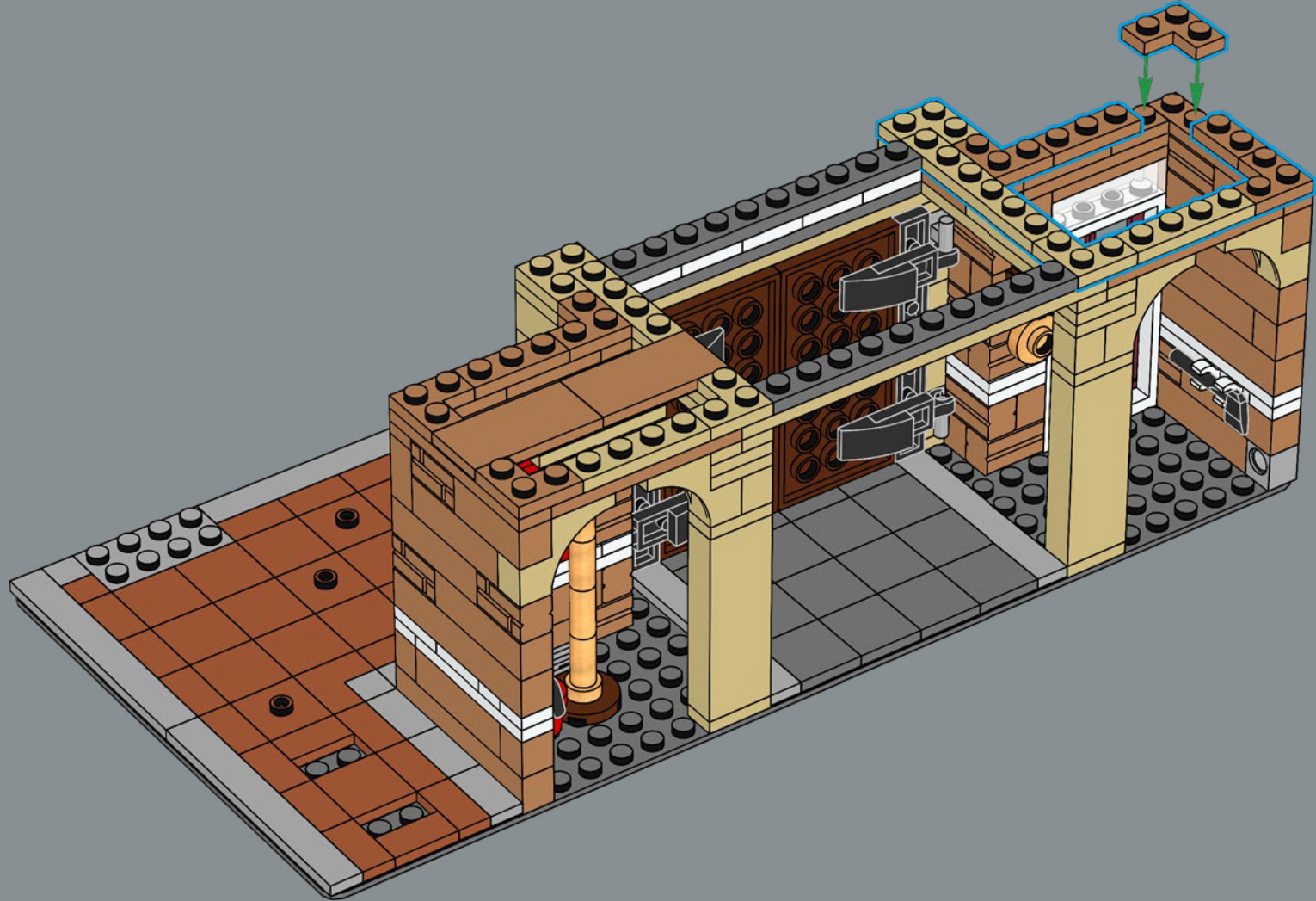

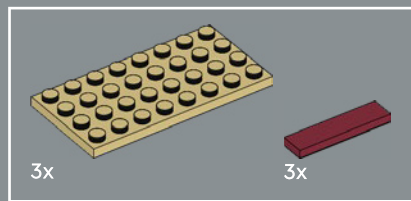

66

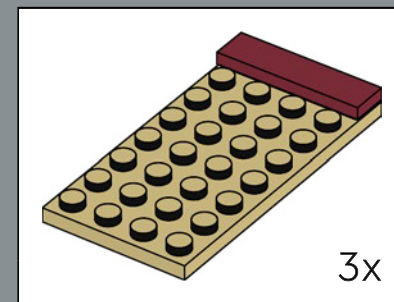

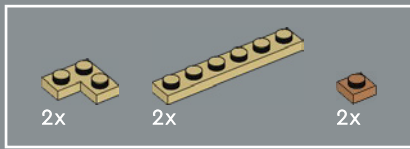

67



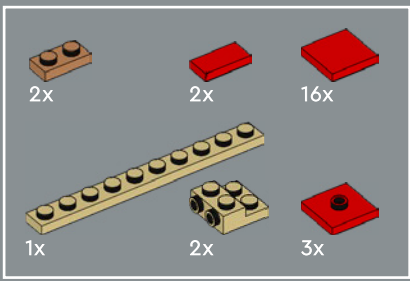

68

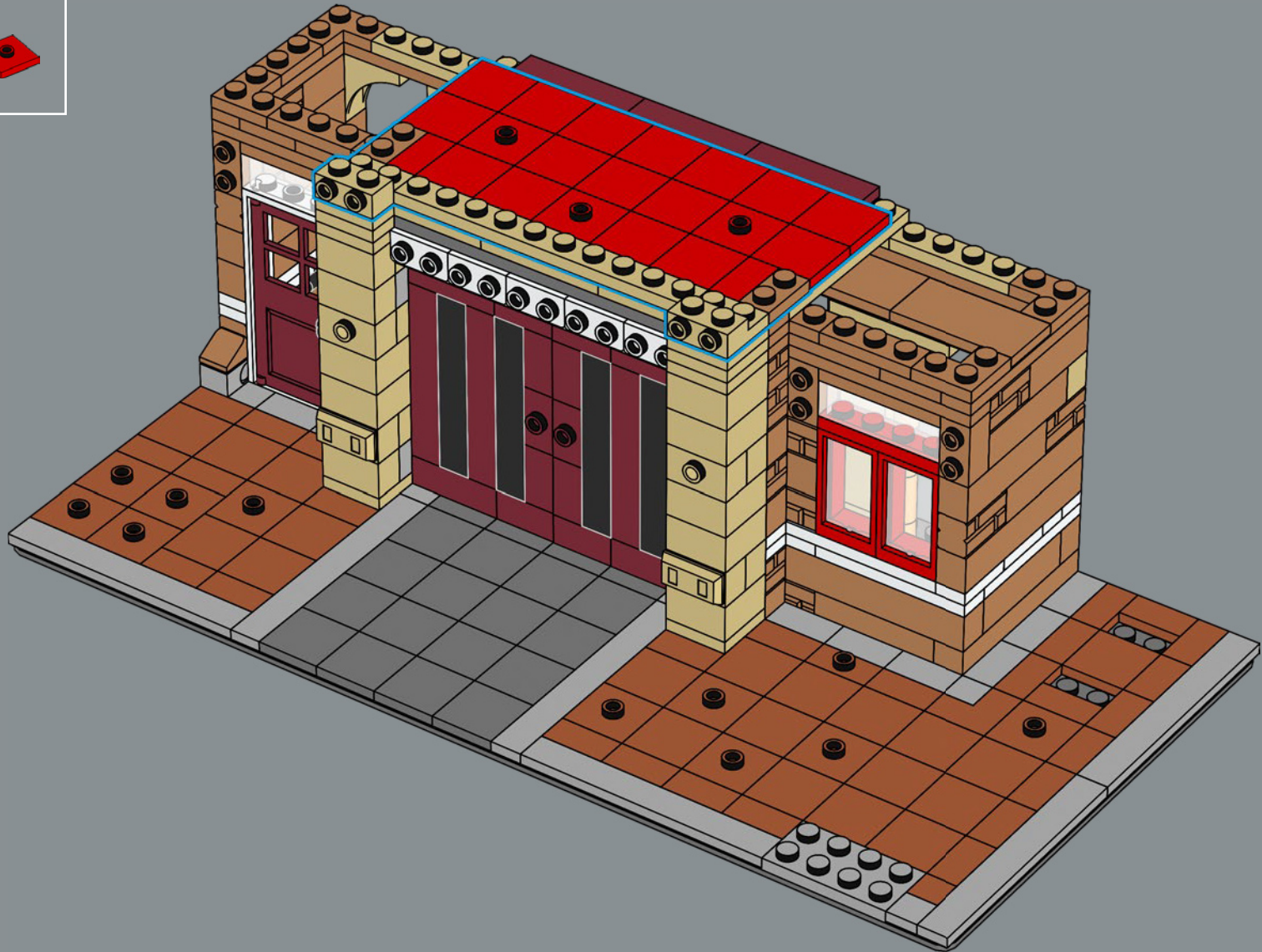

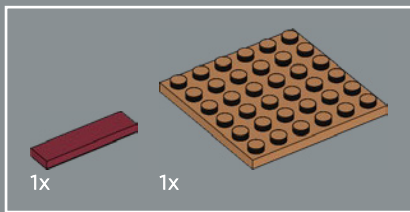

69

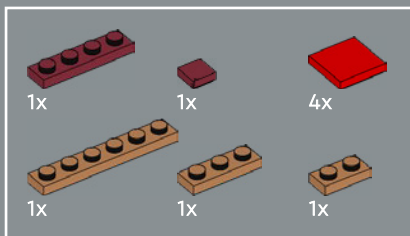
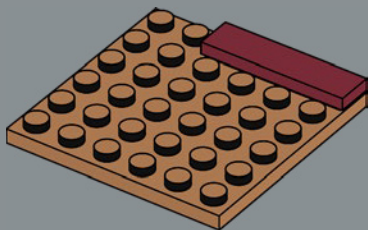

70

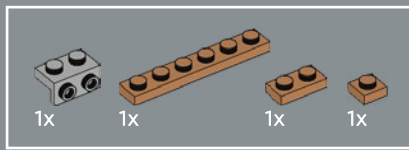
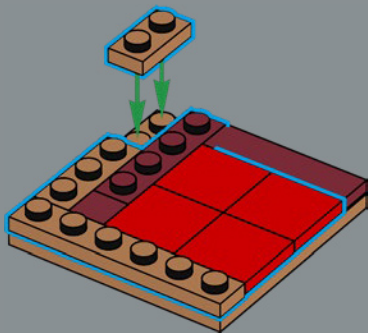

71

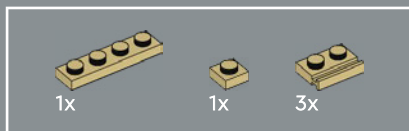
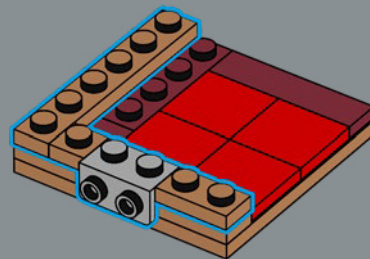

72

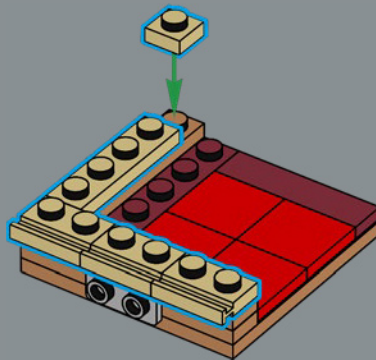

73

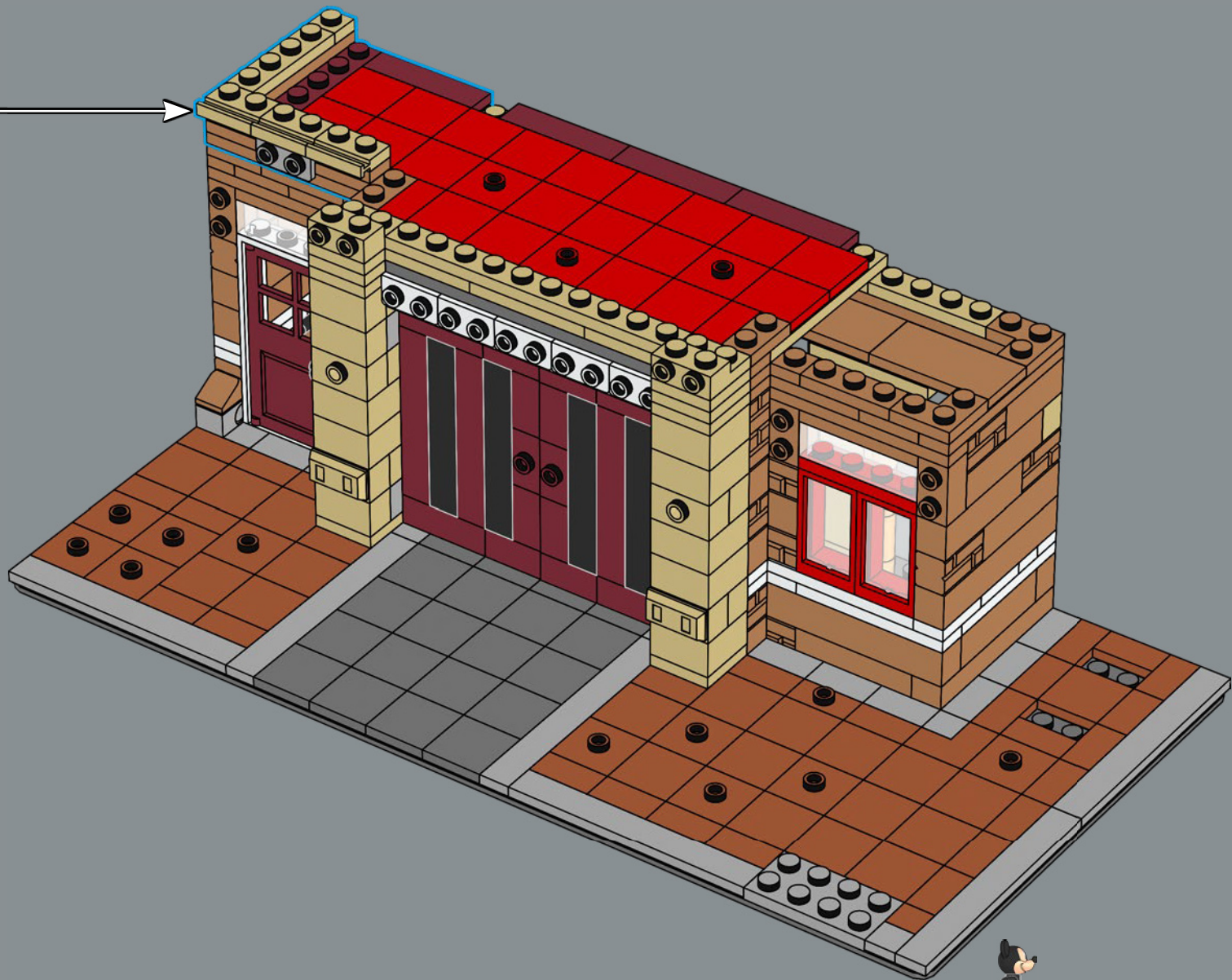

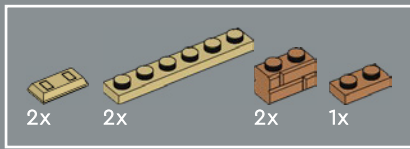

74

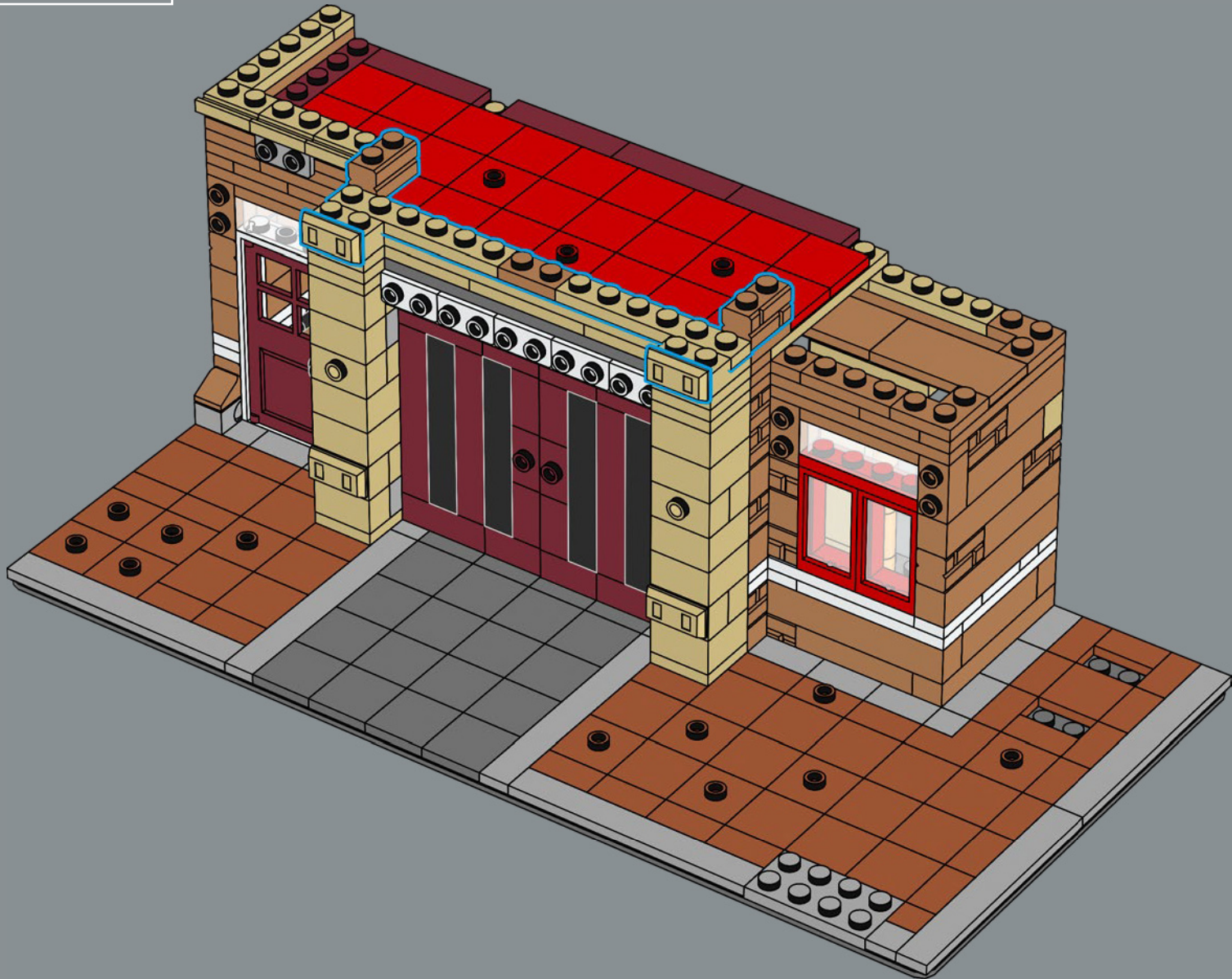

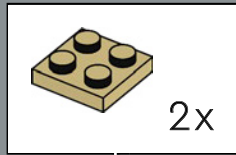
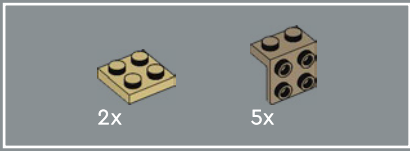

75

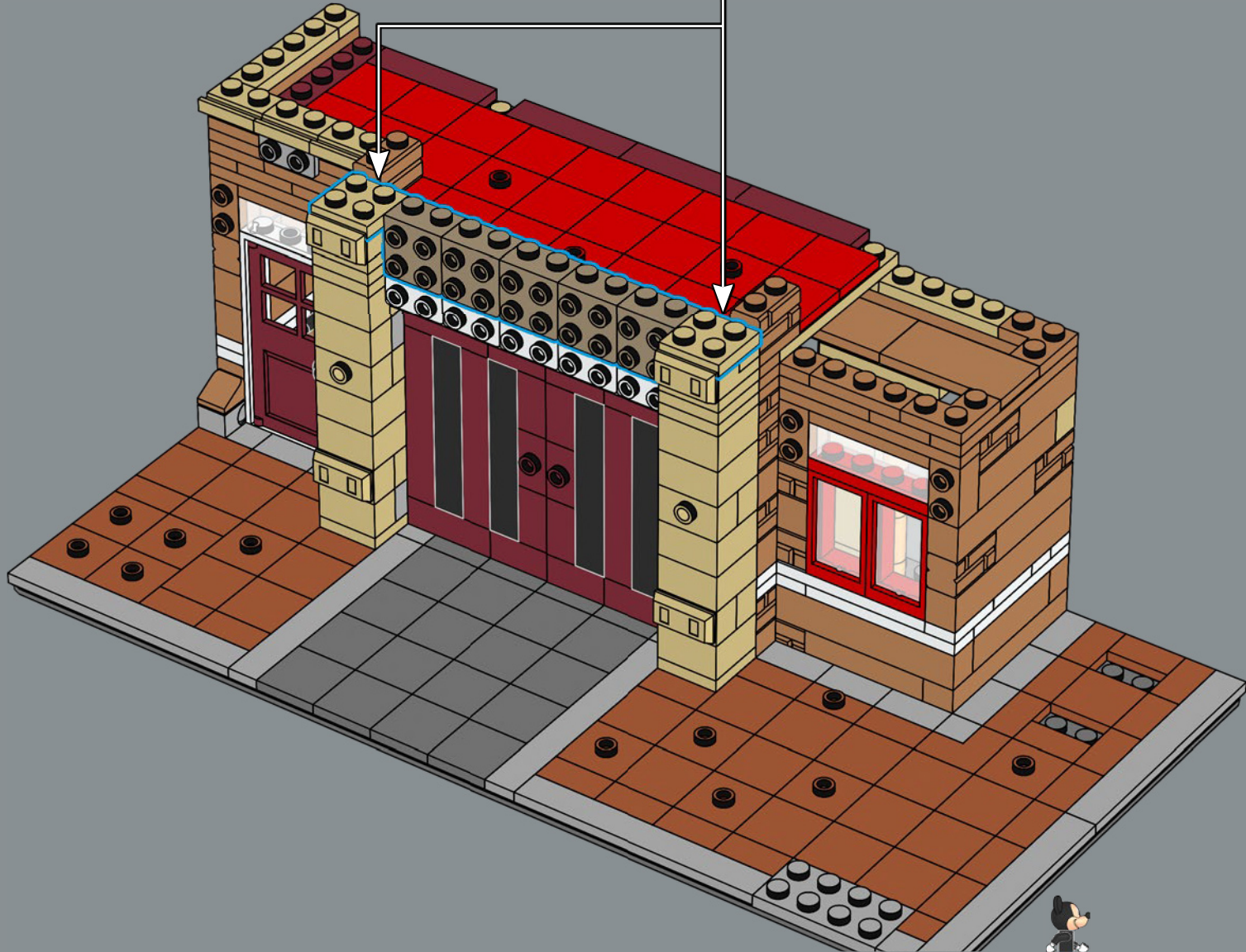

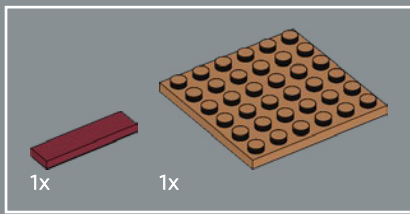

76

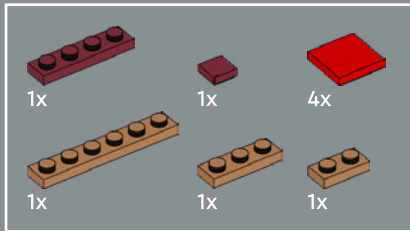
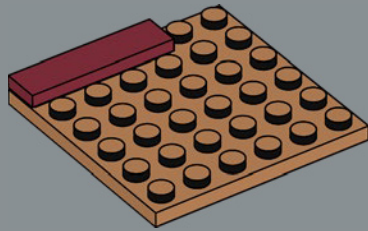

77

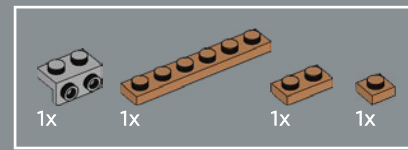
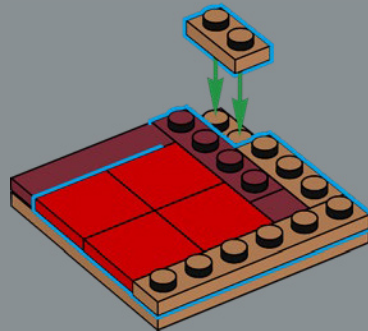

78

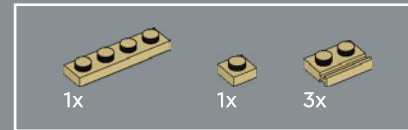
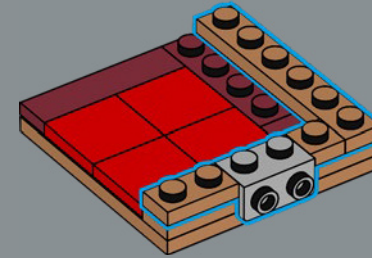

79

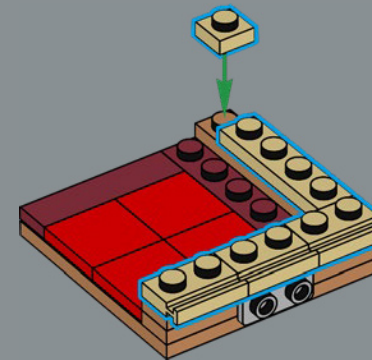

80

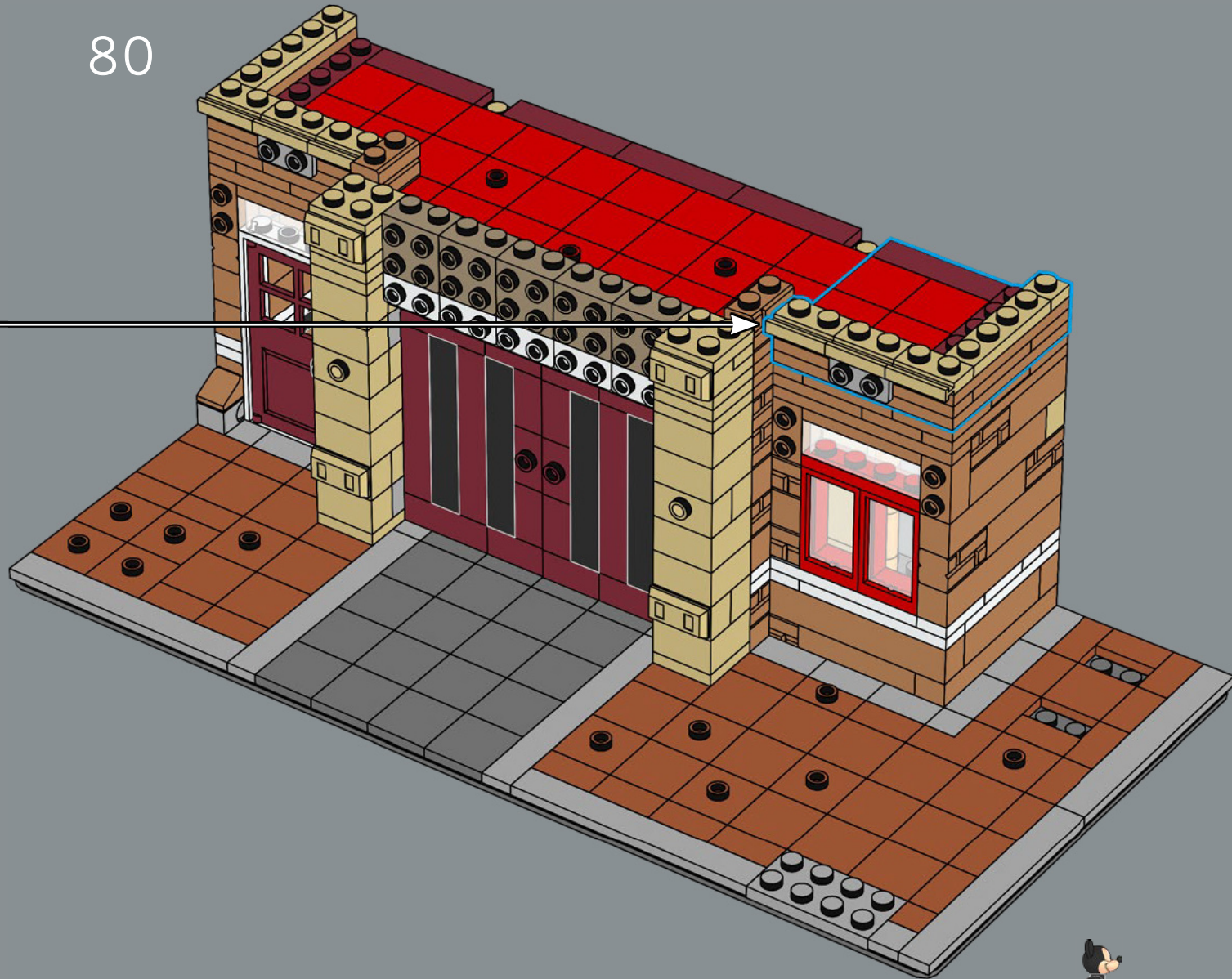

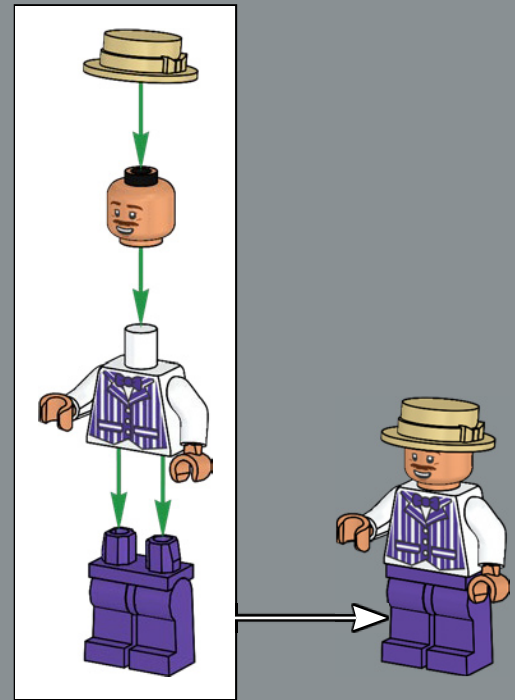

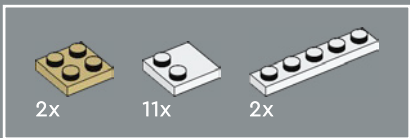

81

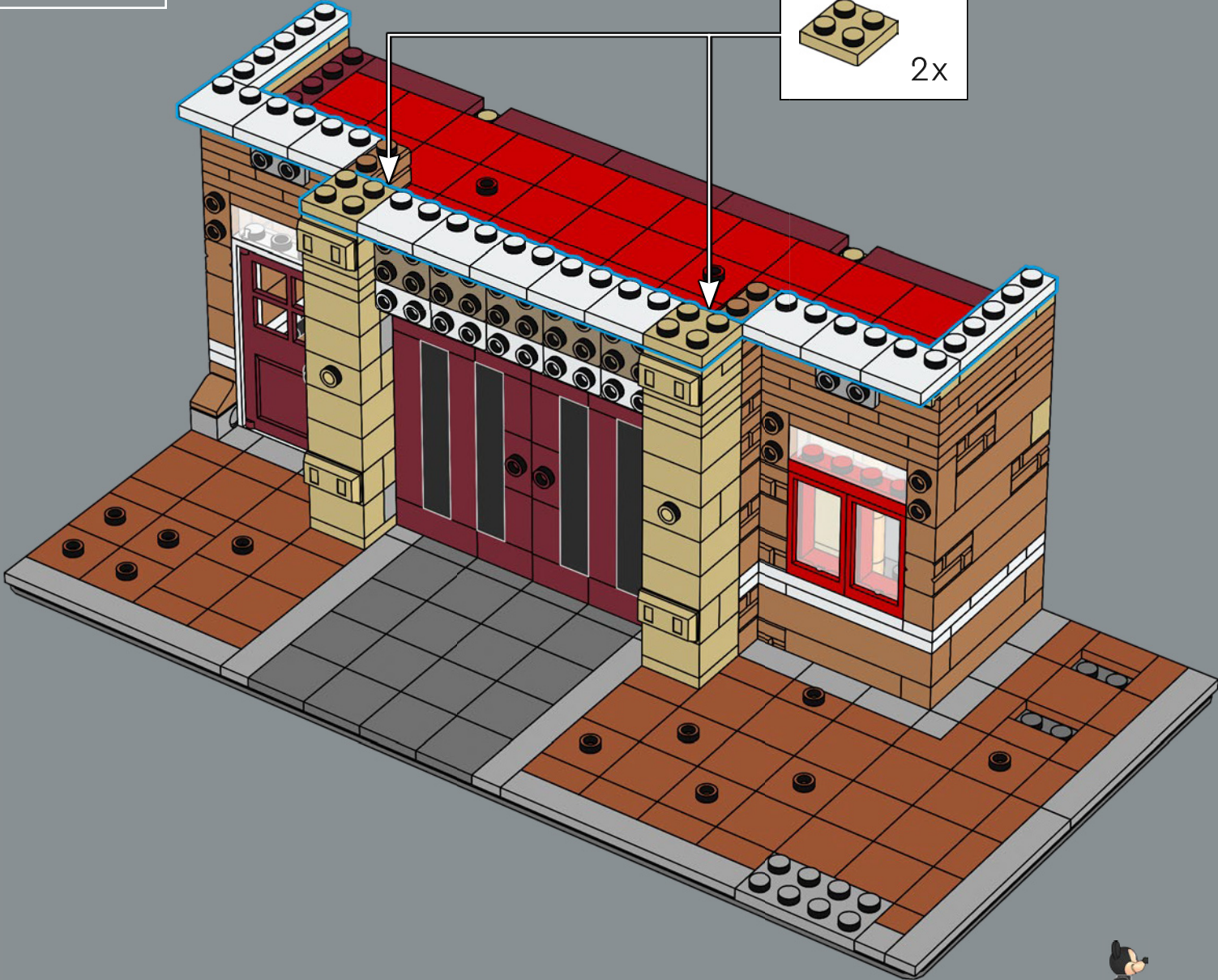
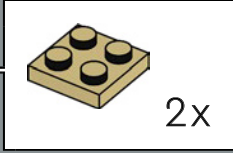

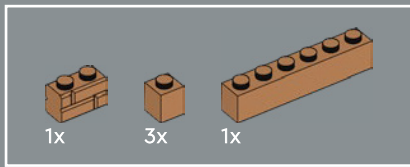

82

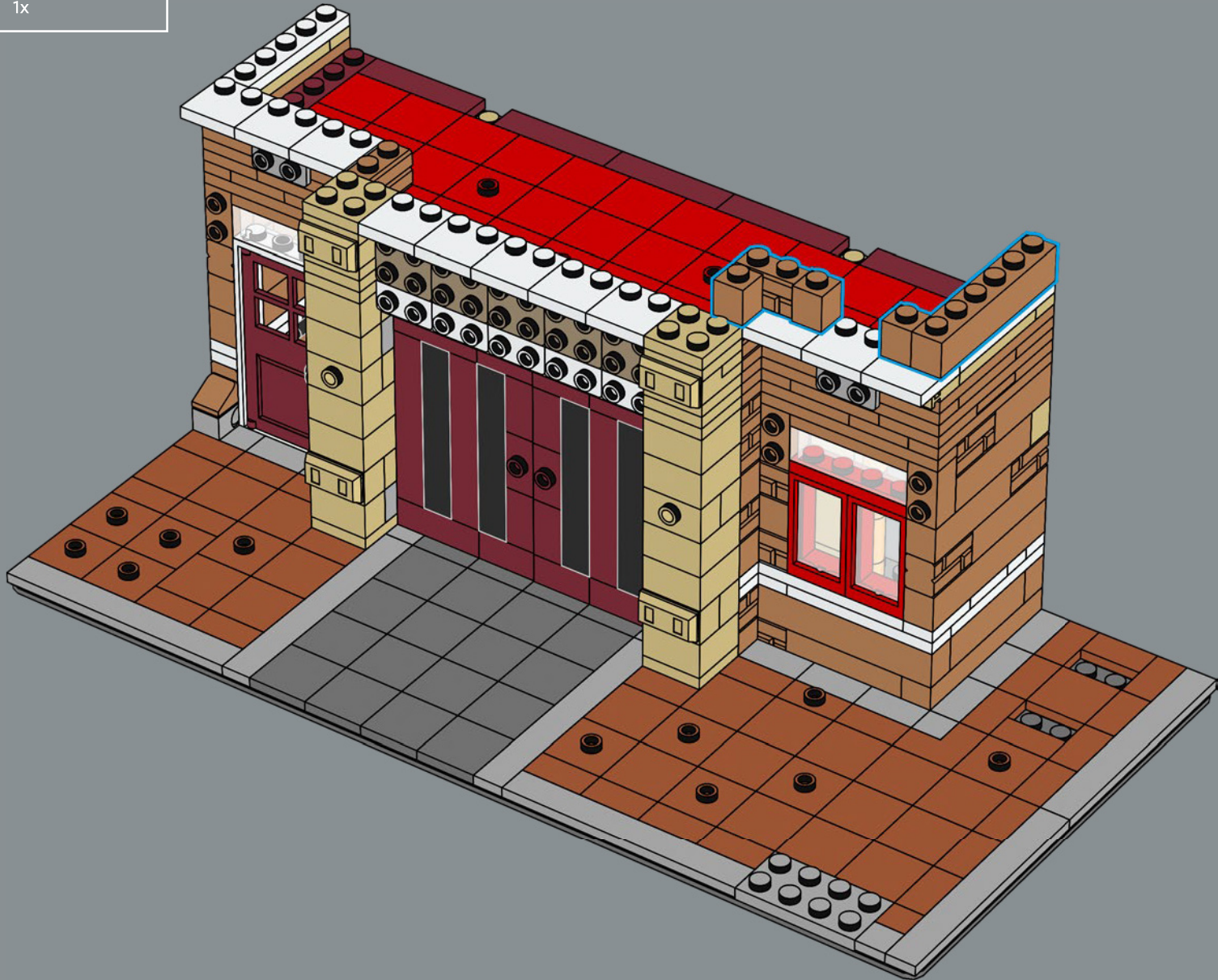

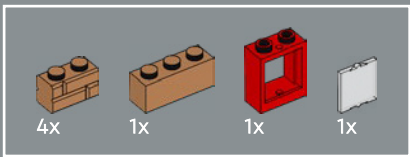

83

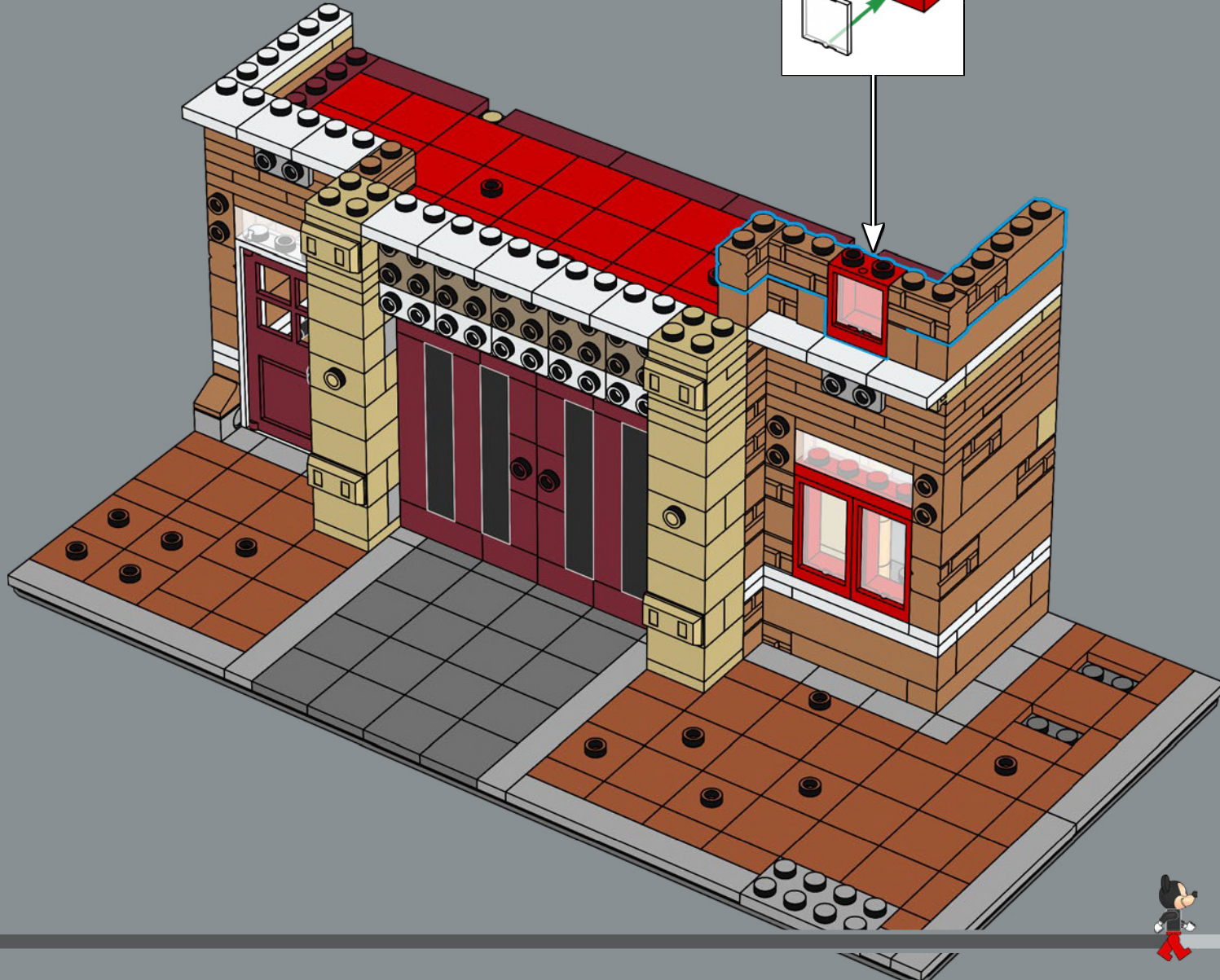
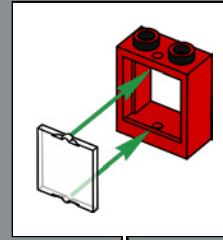

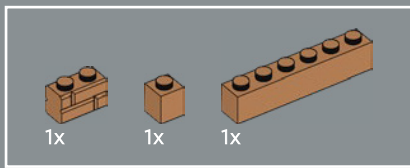

84



2x  4x 

85

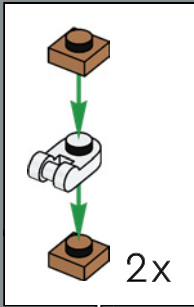

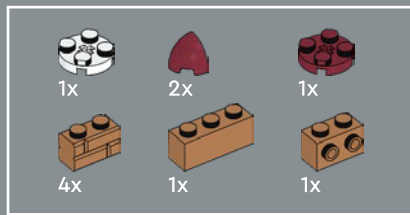

86

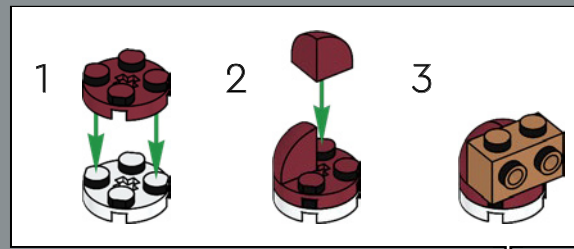

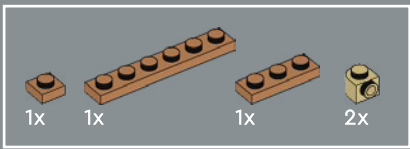

87



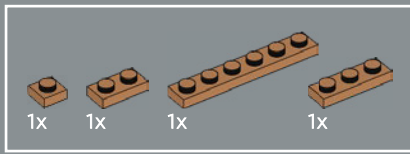

88



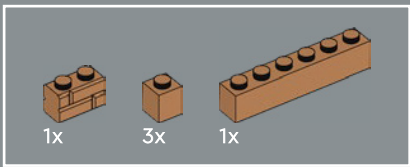

89



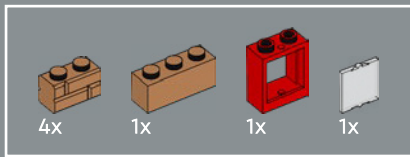

90

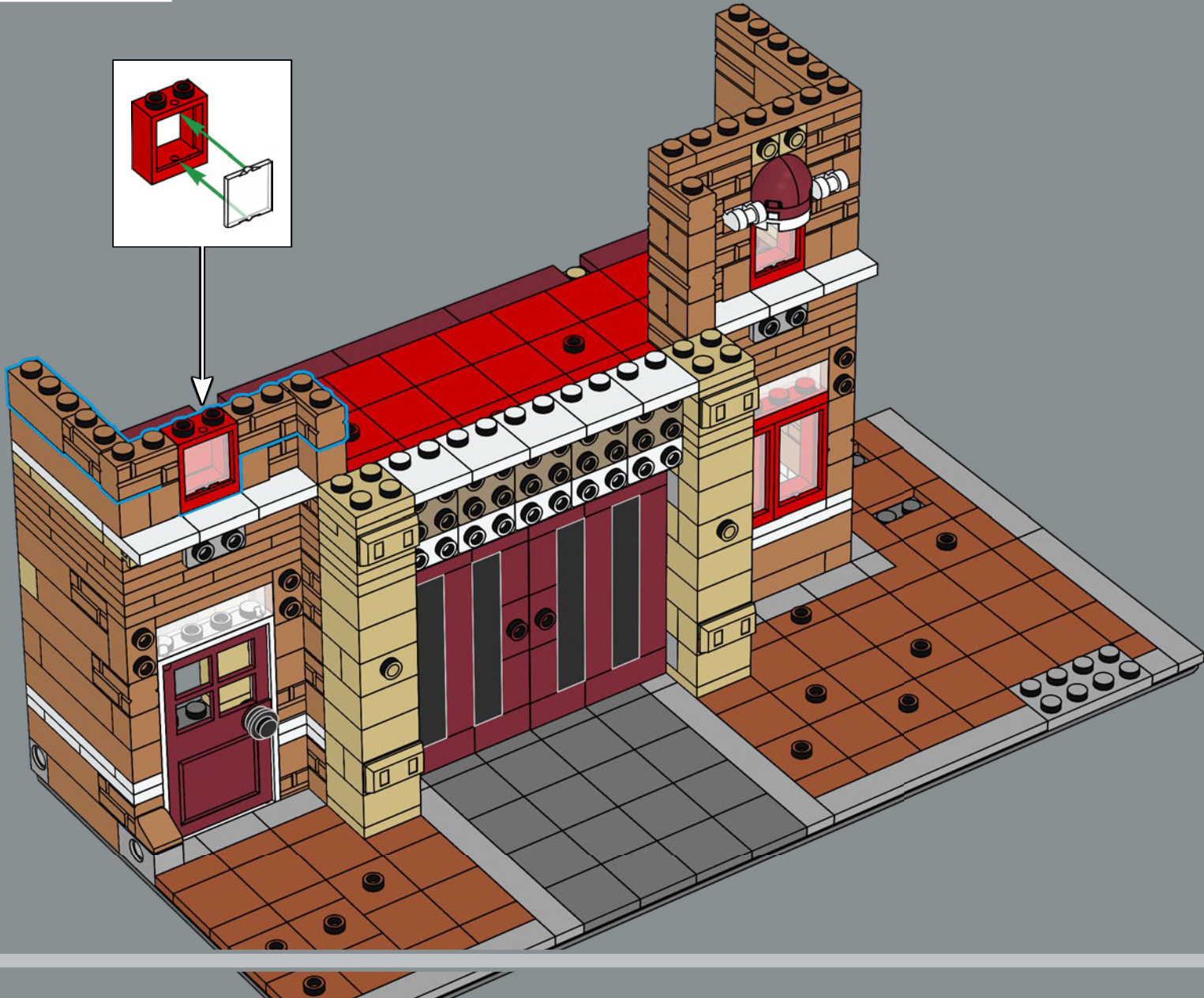
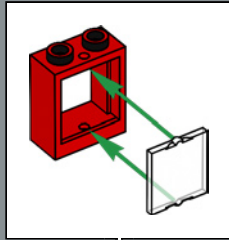

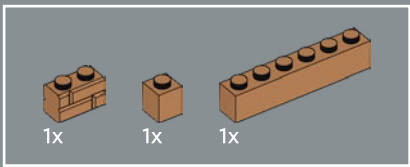

91





92

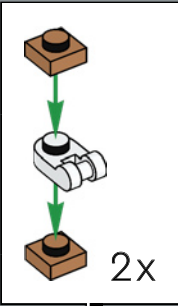

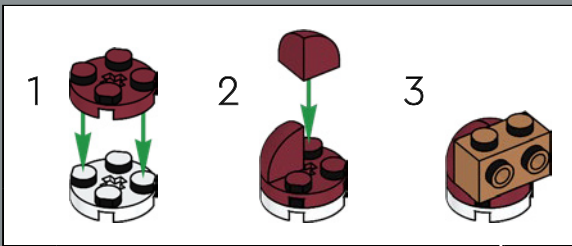
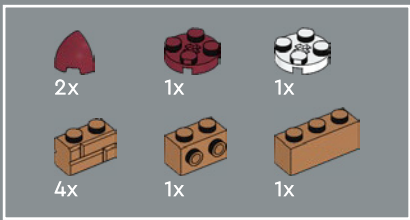

93



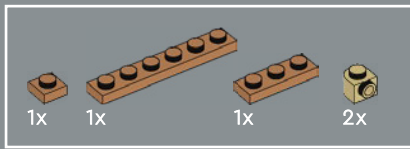

94



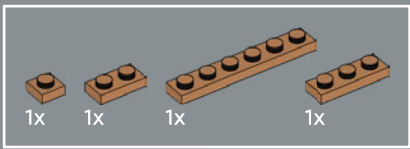

95



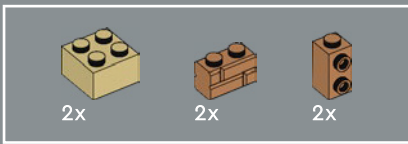

96



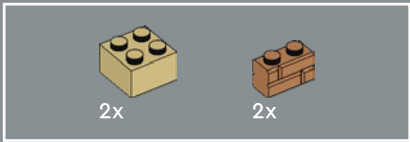

97

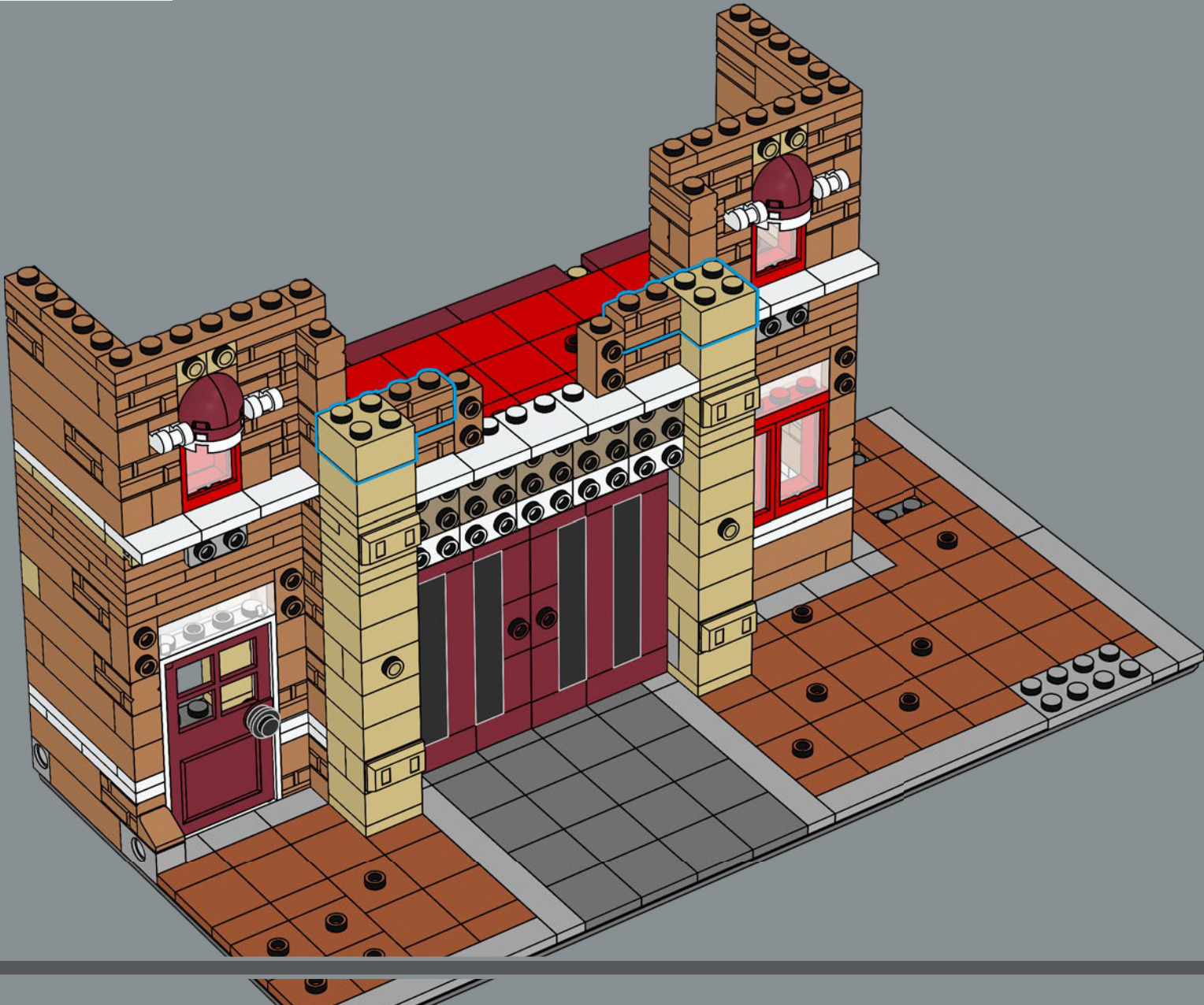

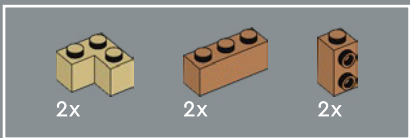

98



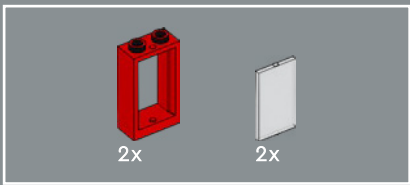

99

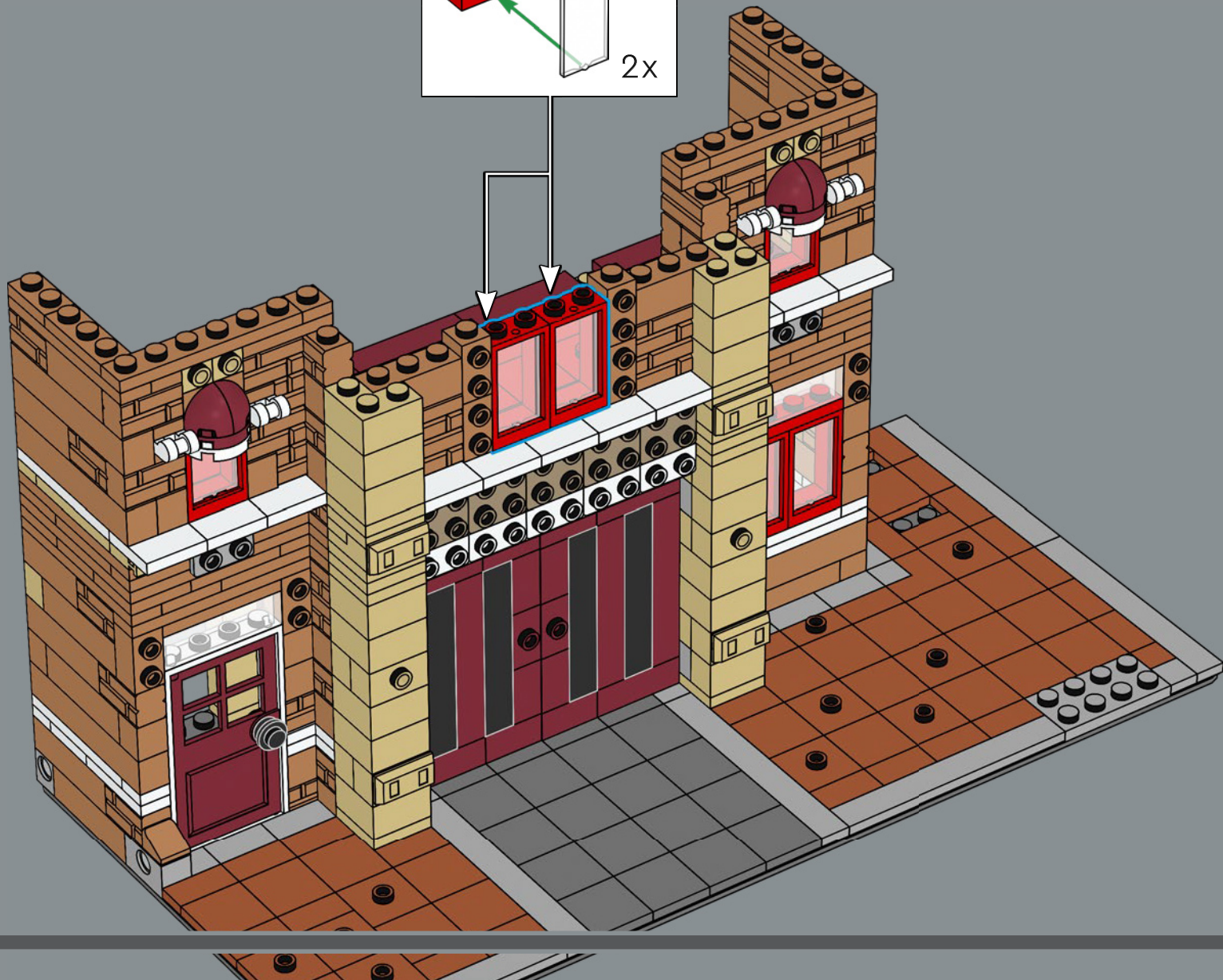
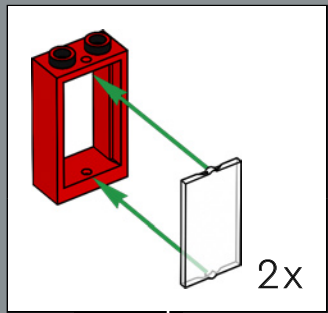

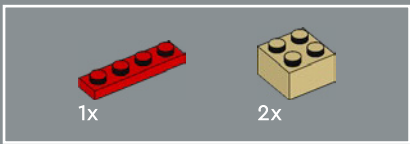

100



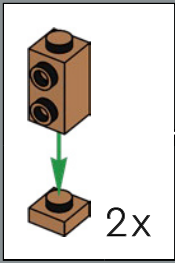

101

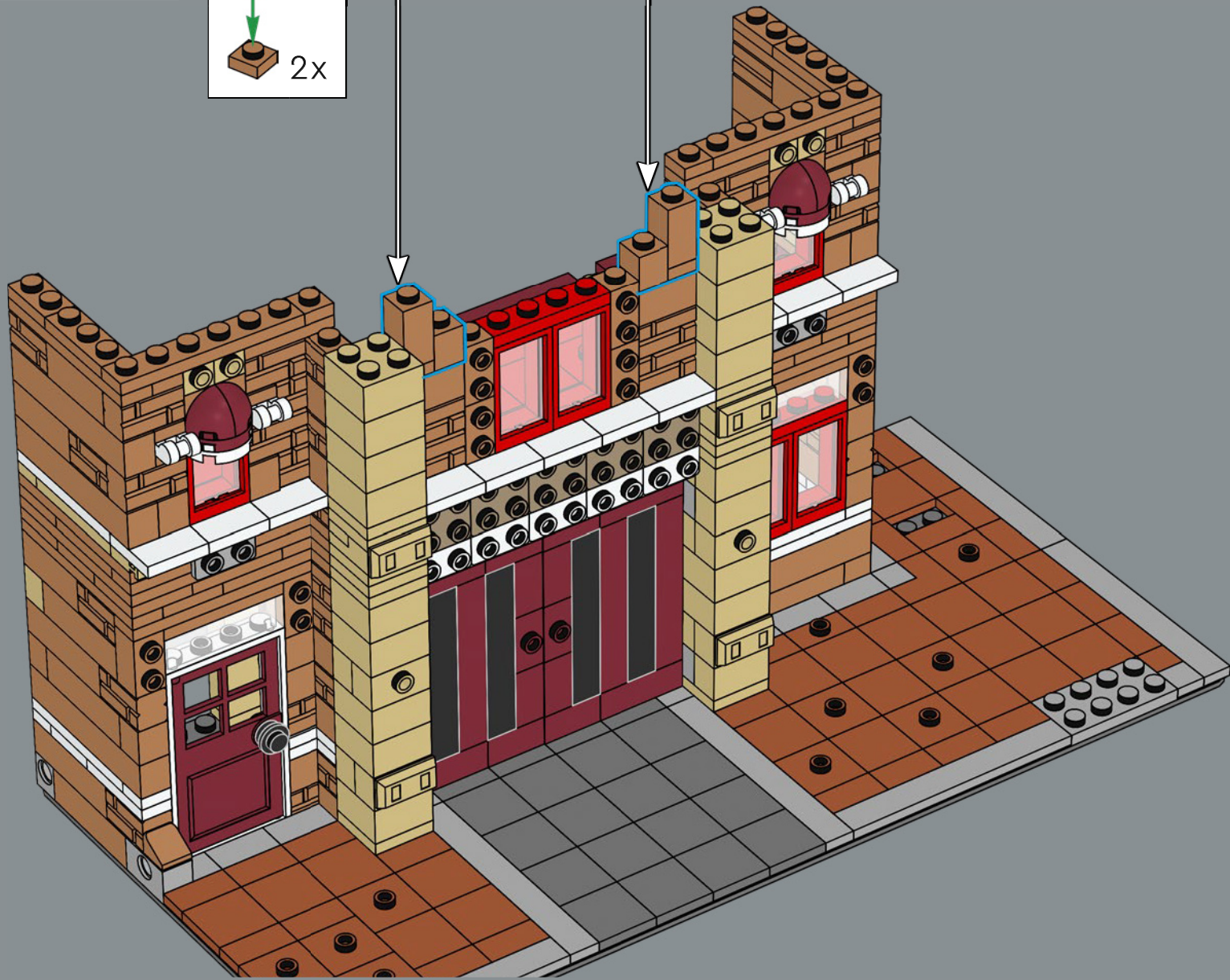

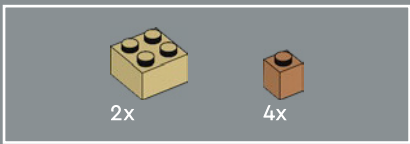

102

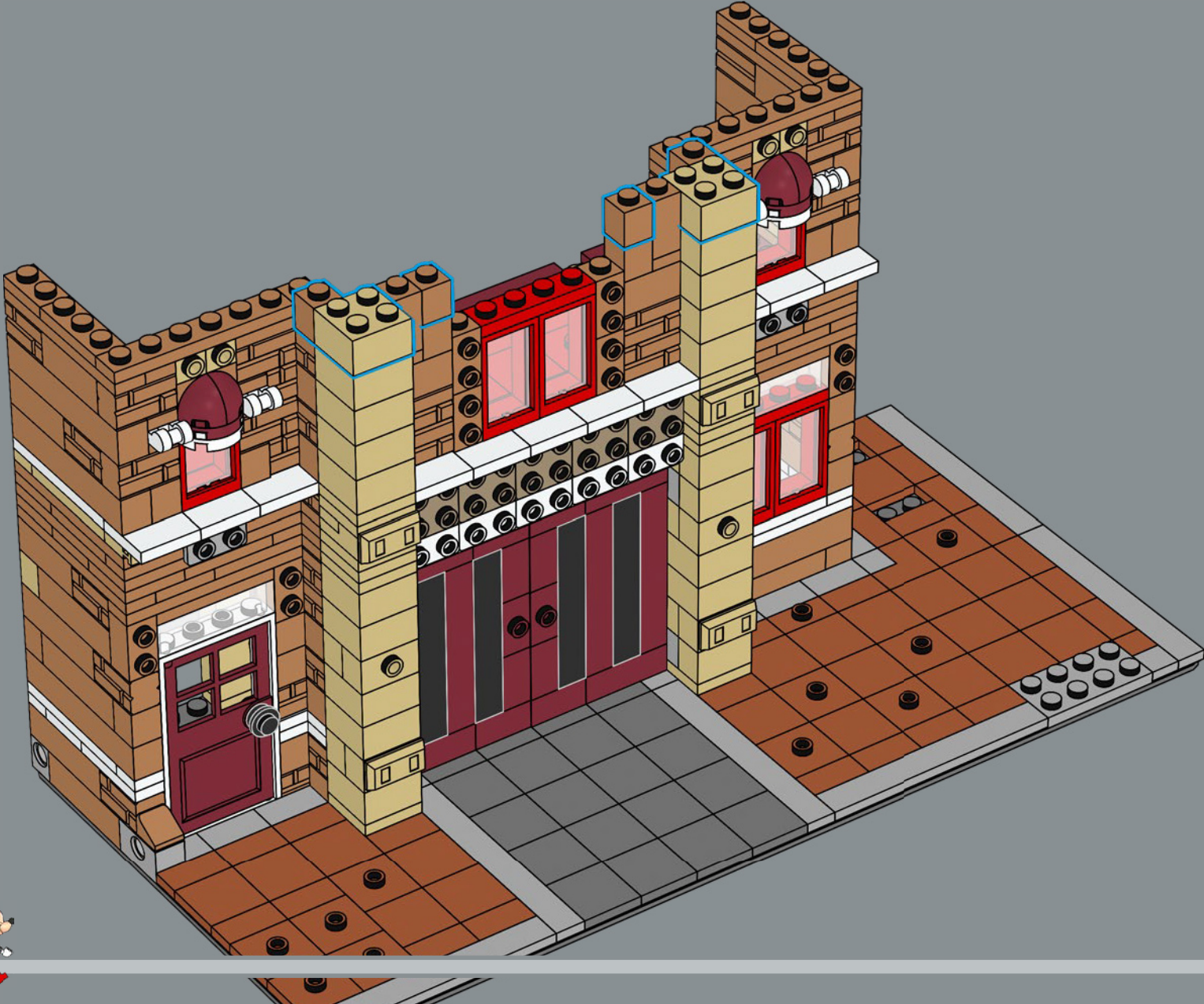



2x

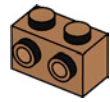

2x

103

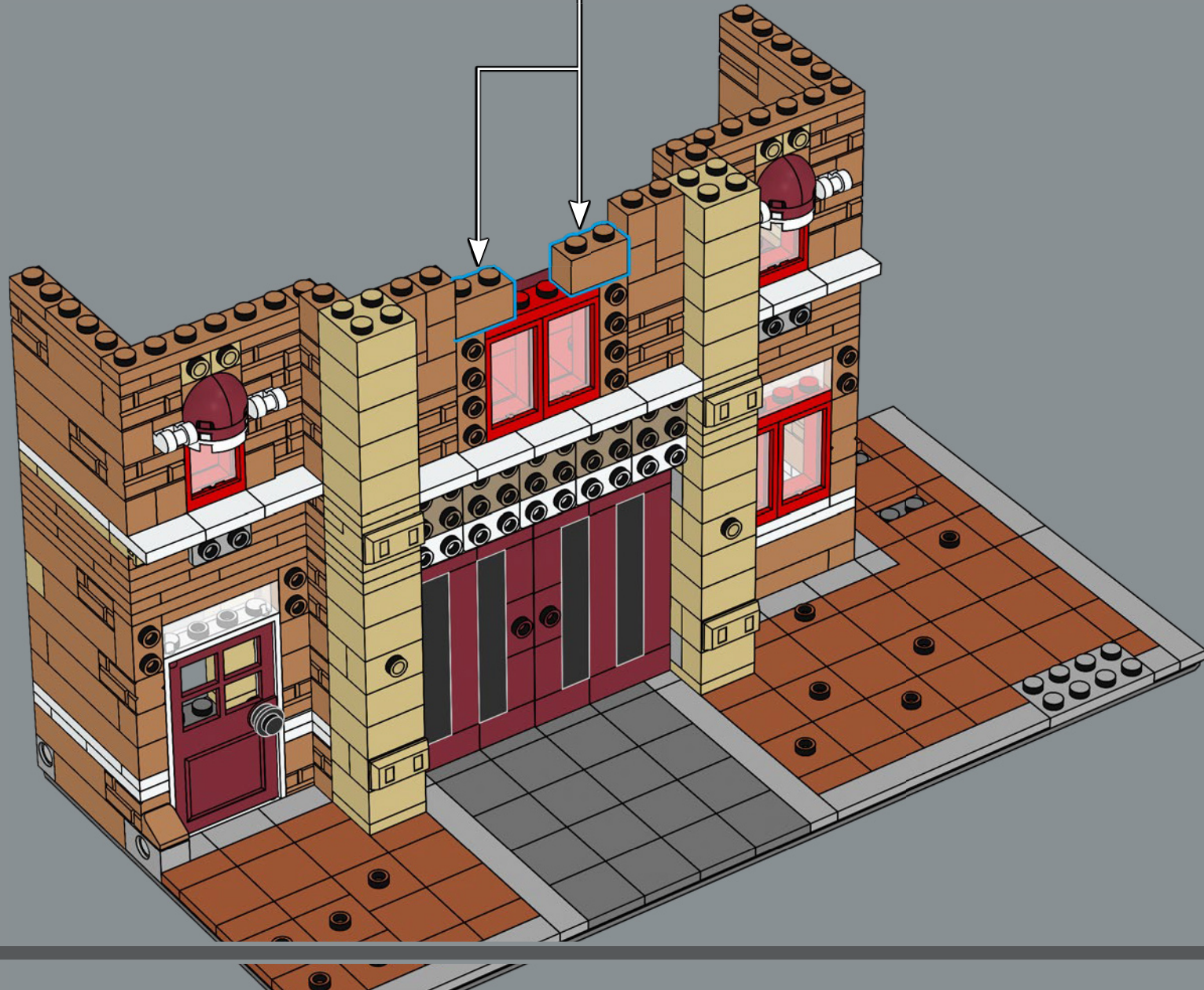



104

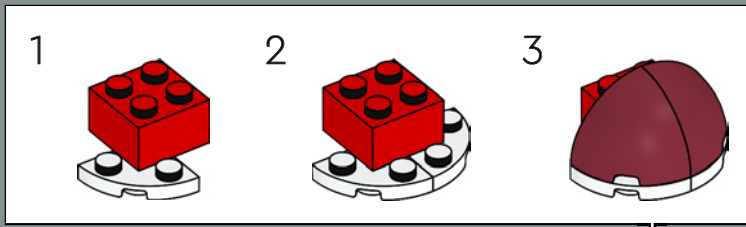

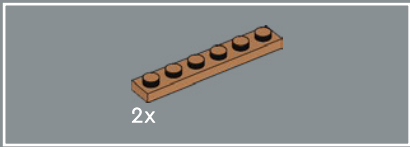

105

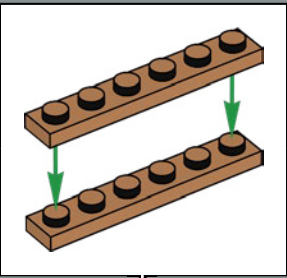

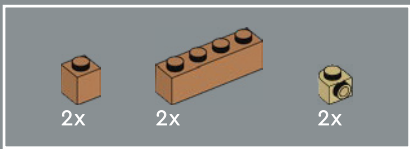

106

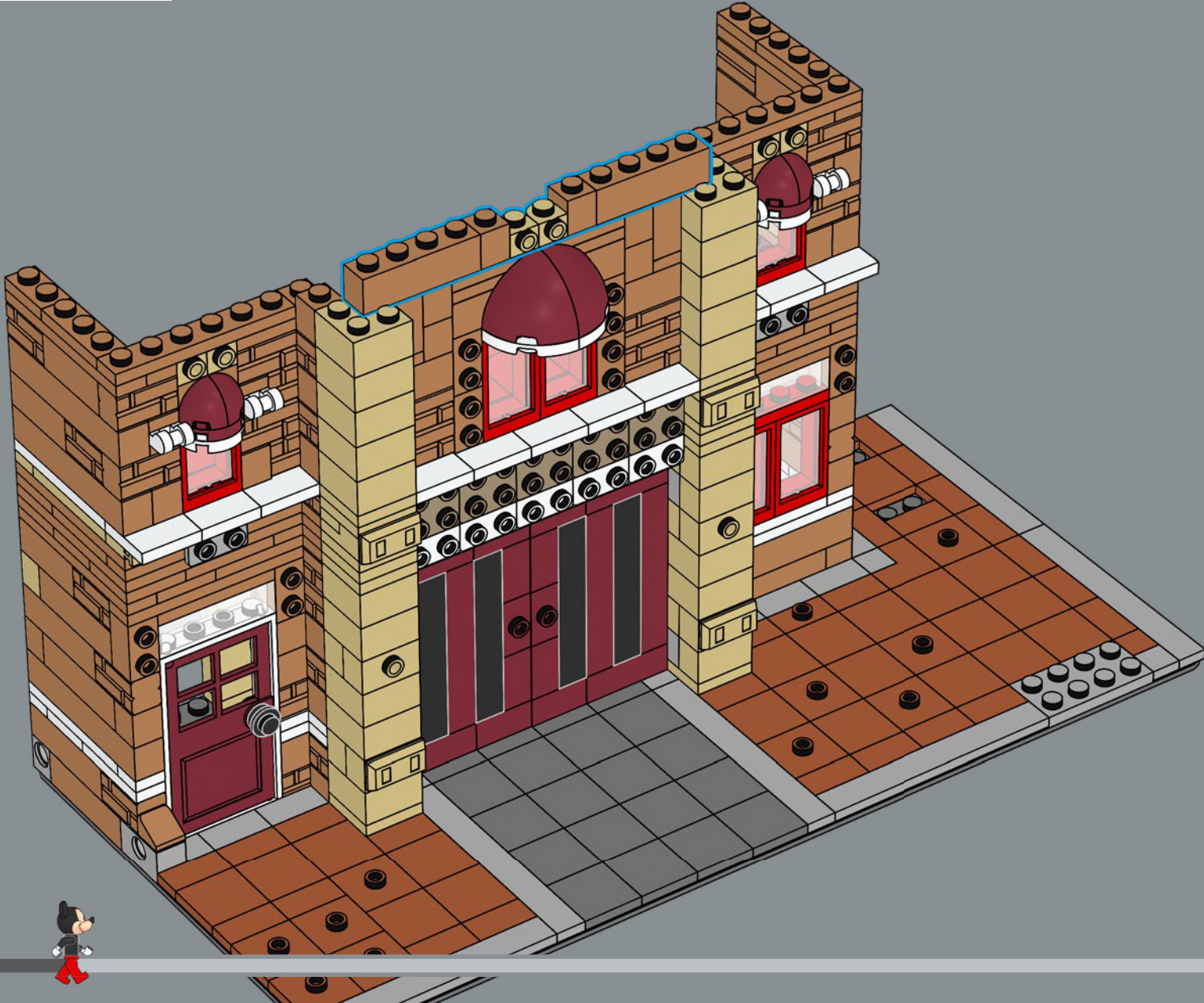

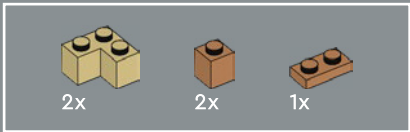

107

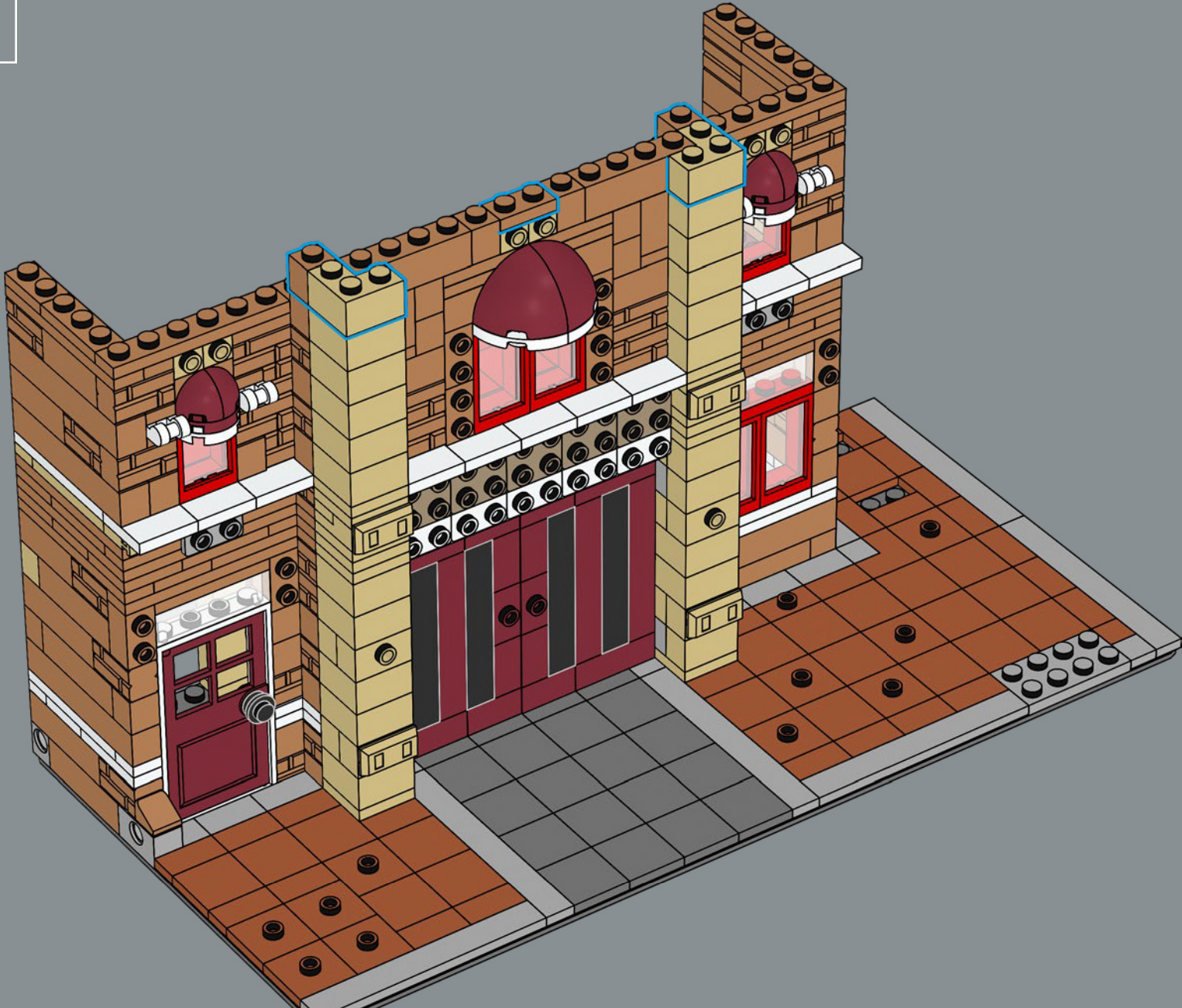

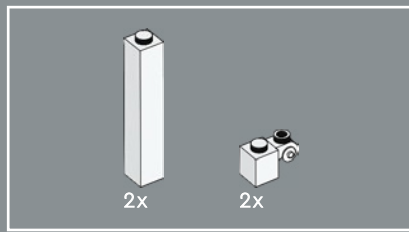

108

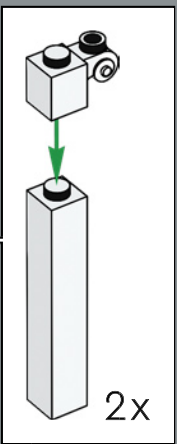

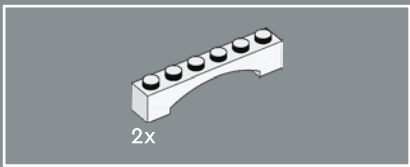

109





2x

110

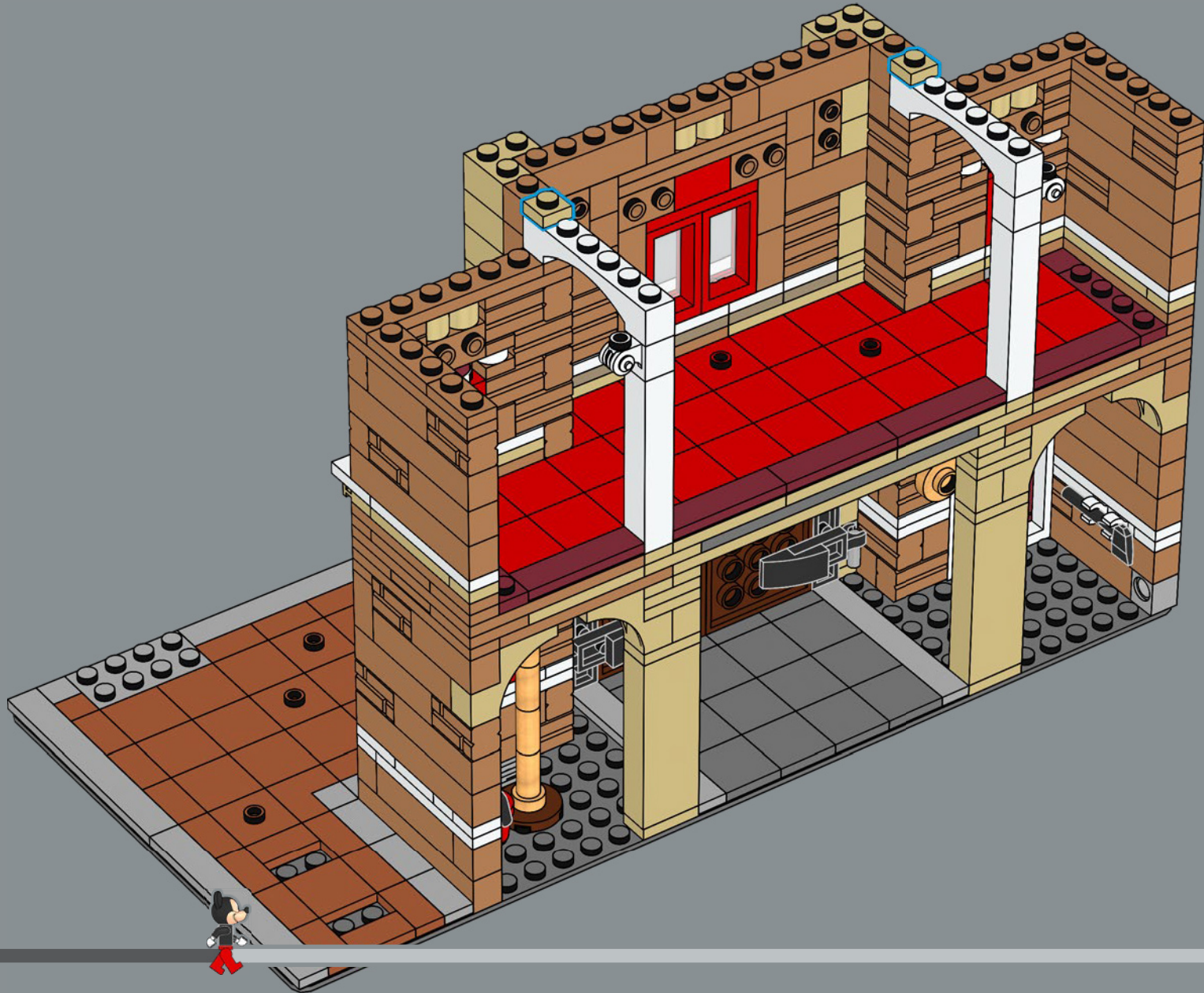

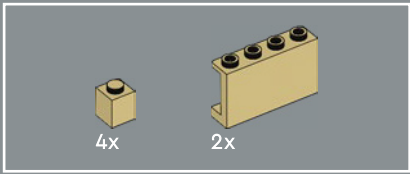

111

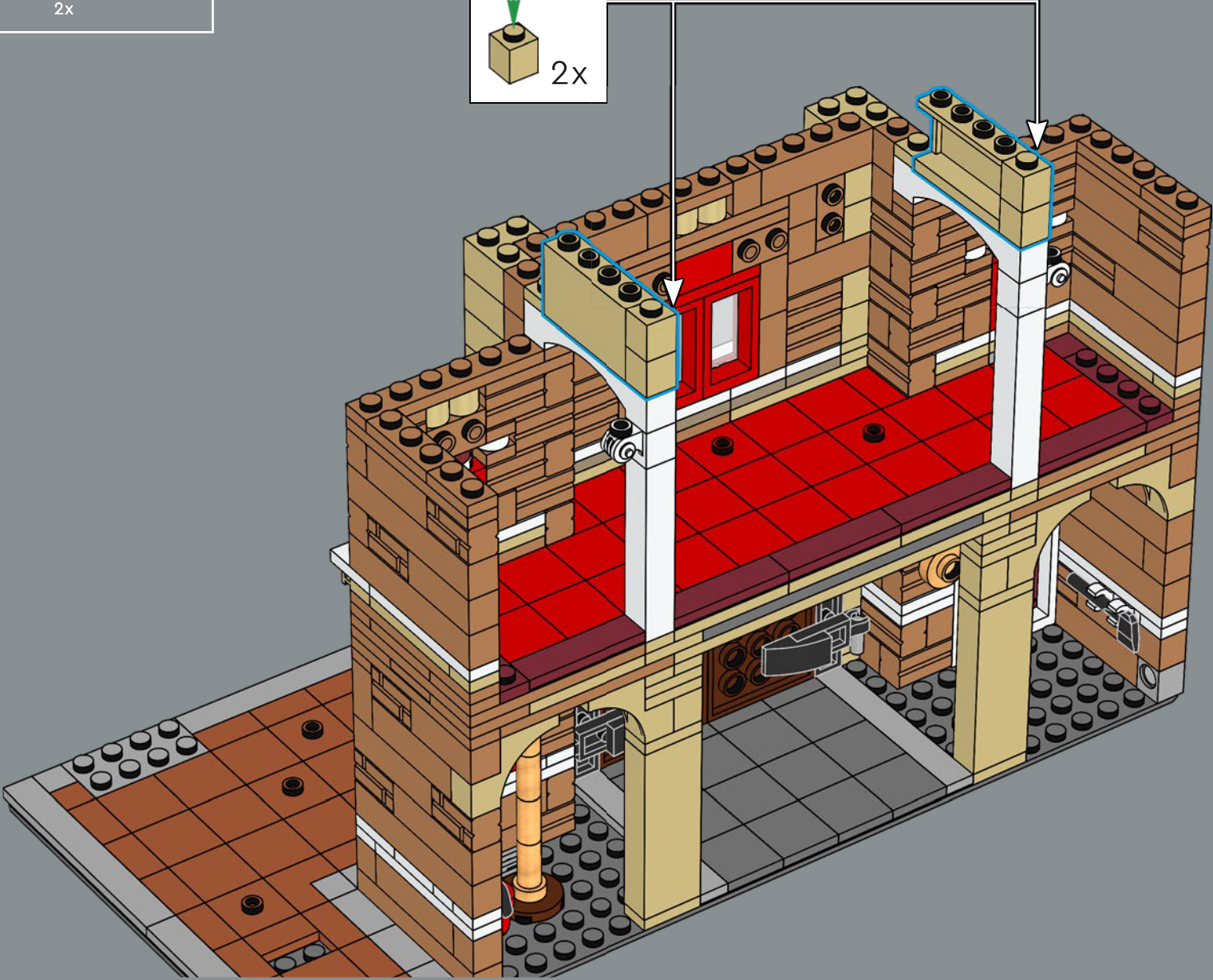
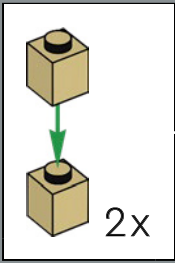

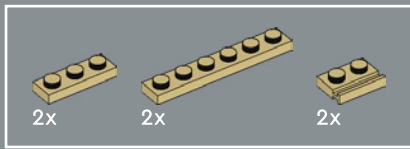

112

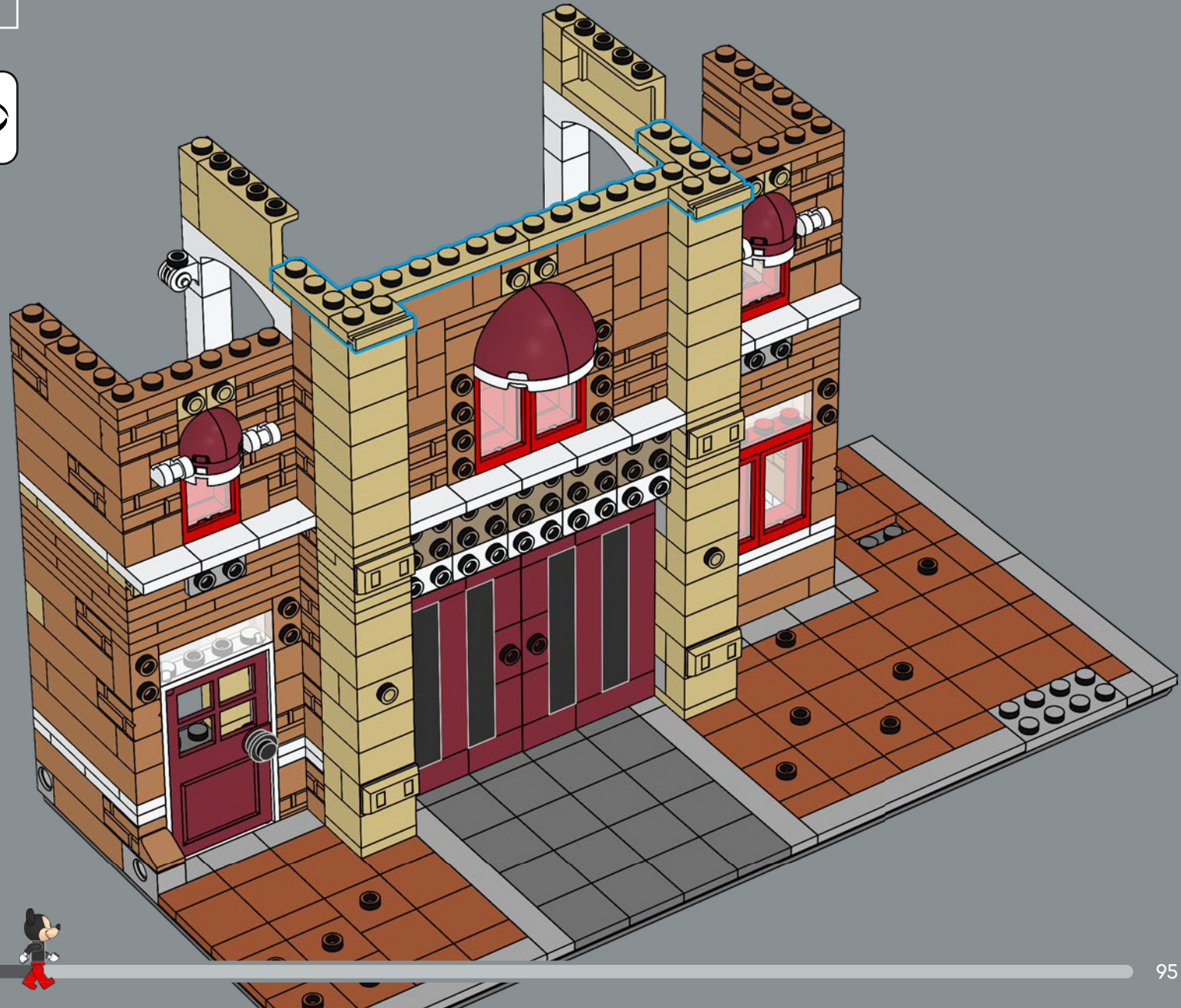

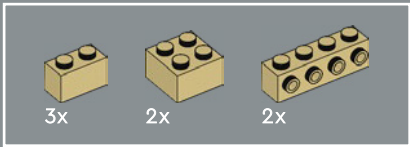

113

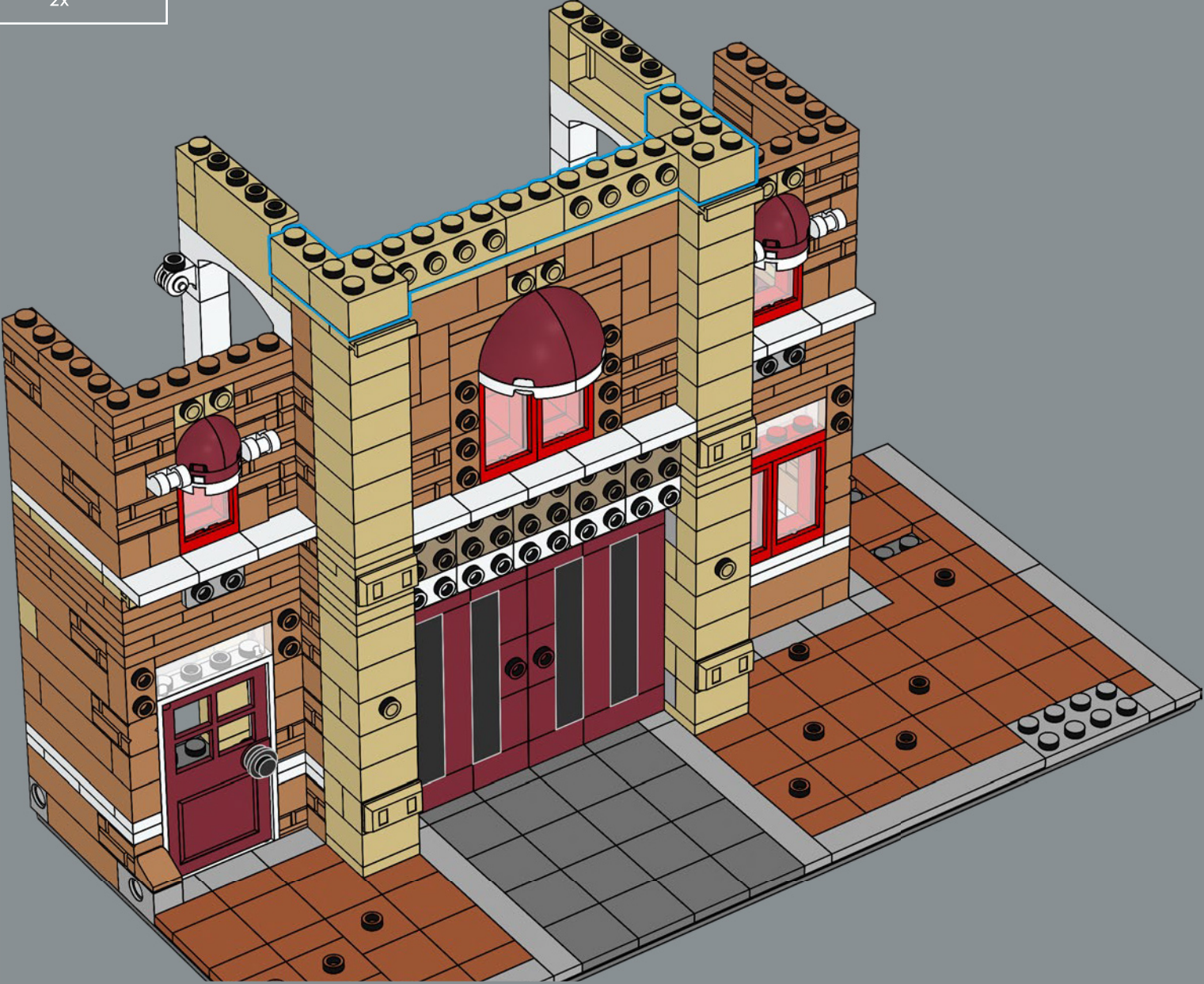

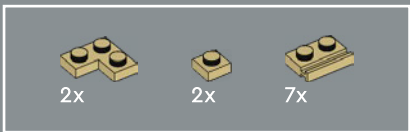

114



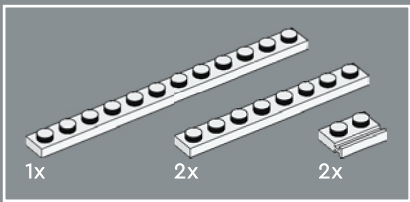

115

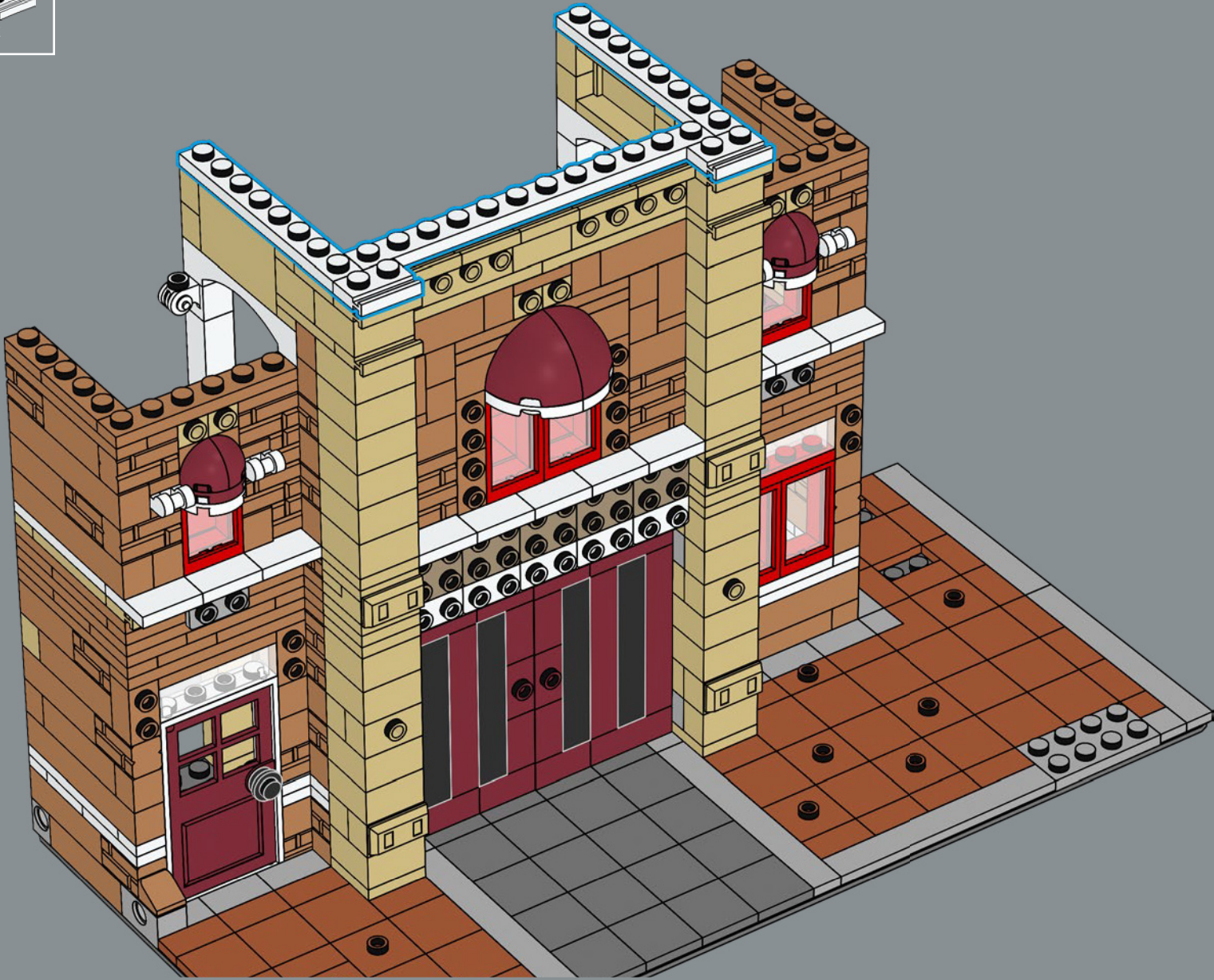

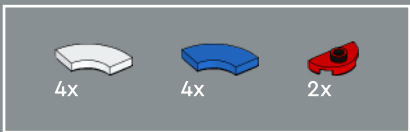

116

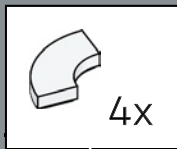

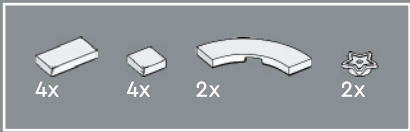

117



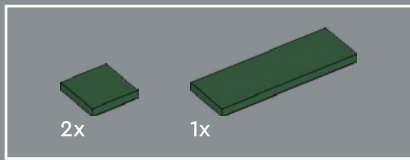

118

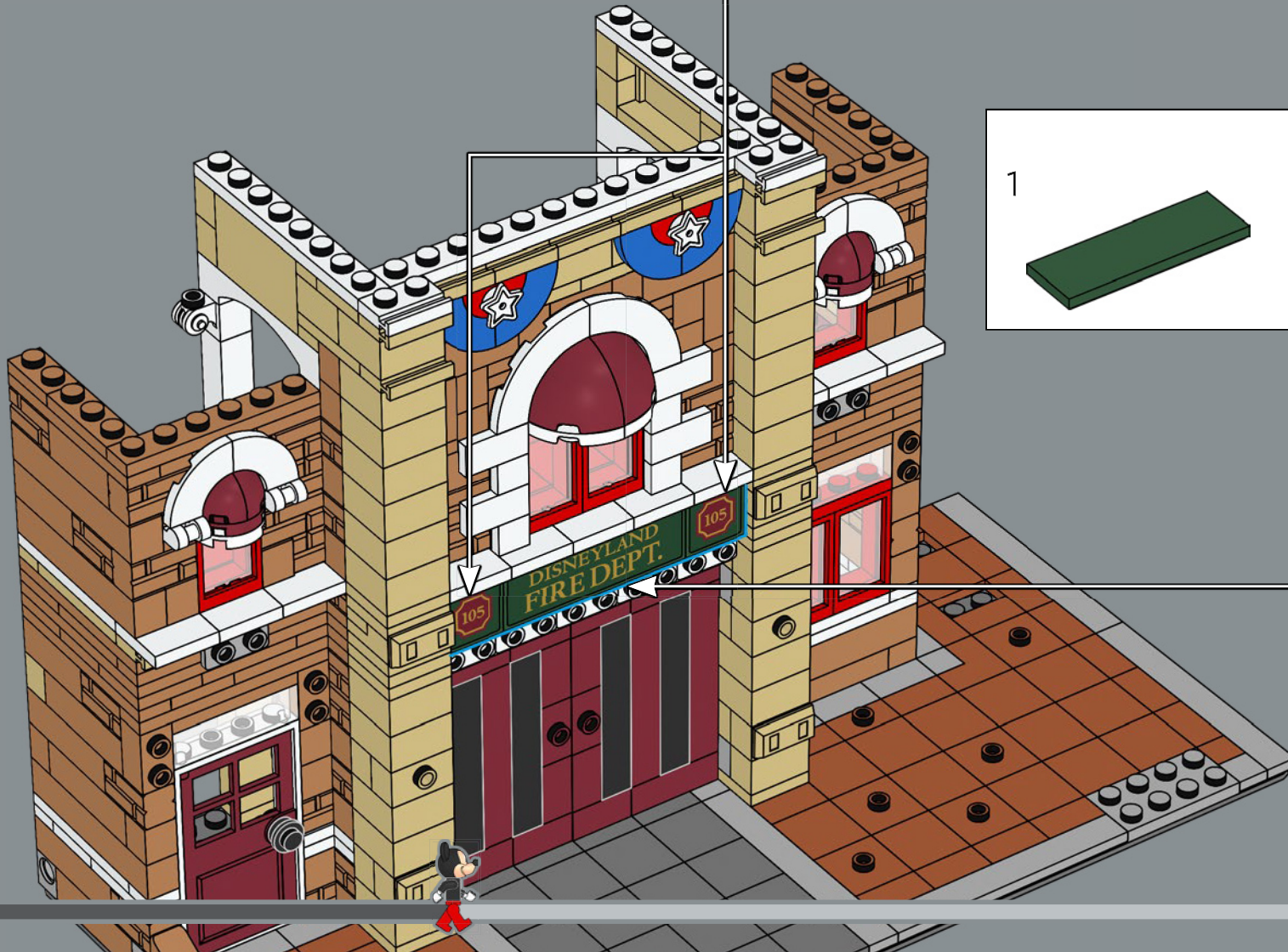
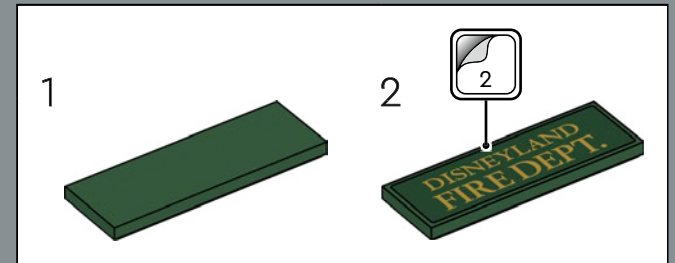
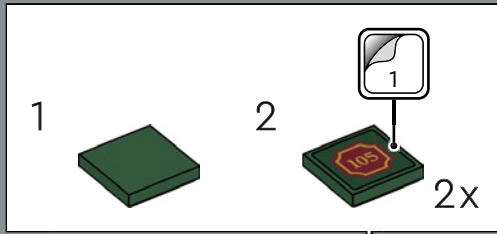

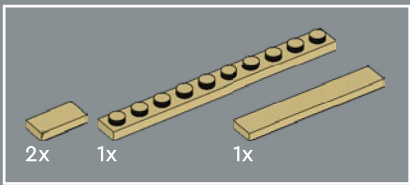

119

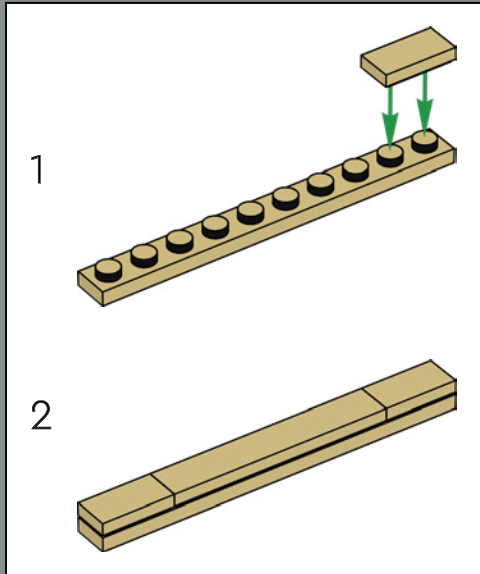

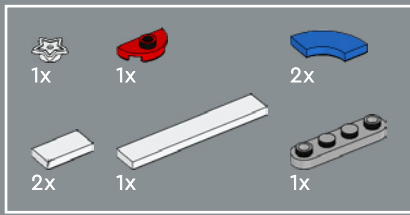

120

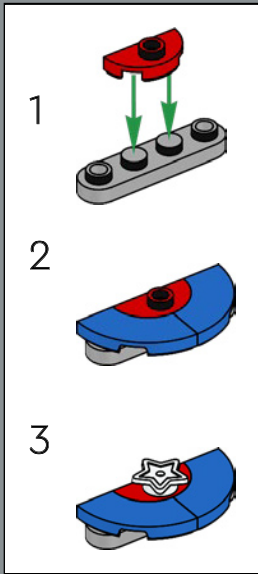



121

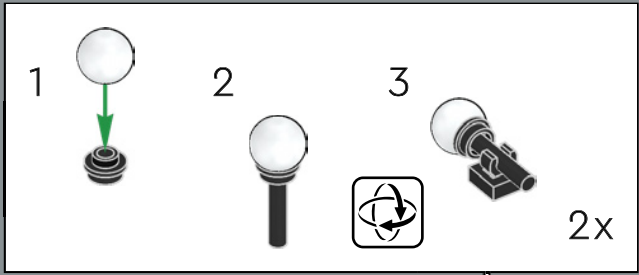

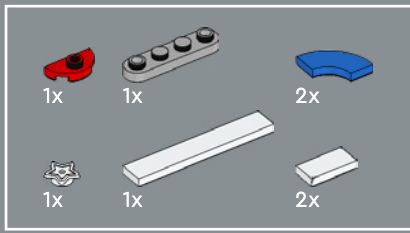

122

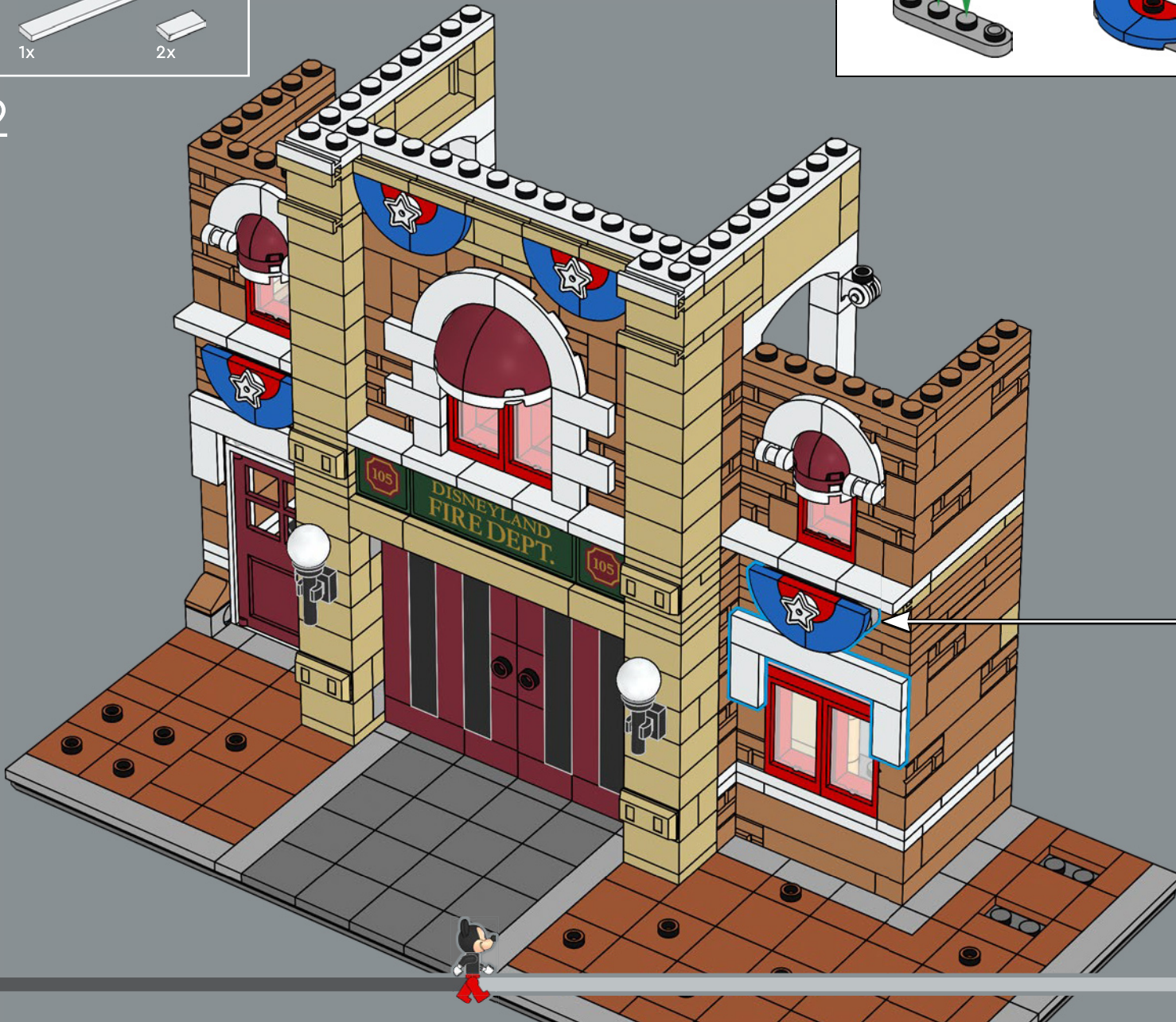
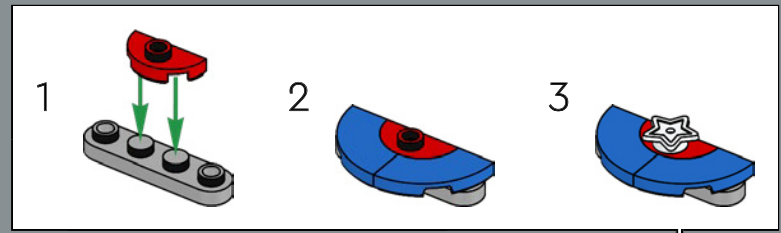

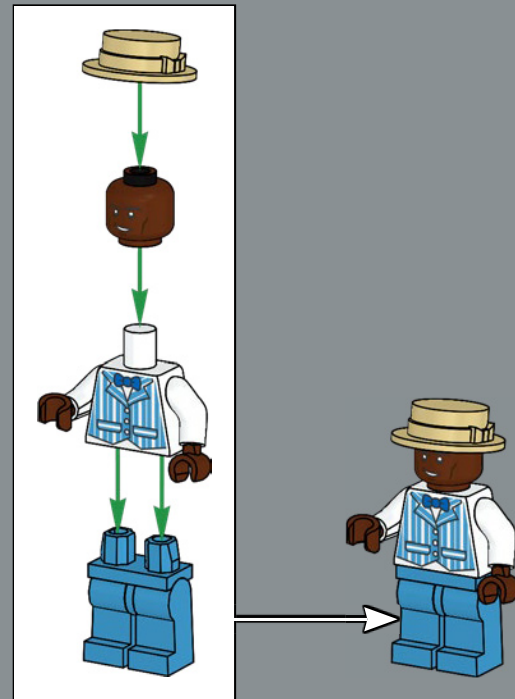

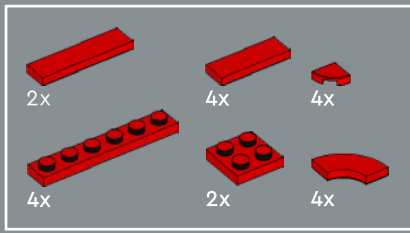

123

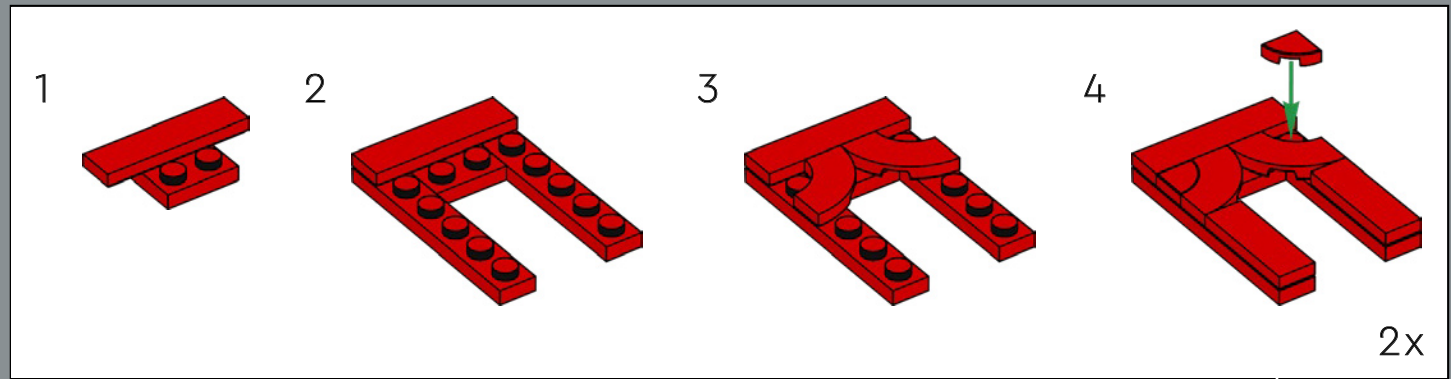

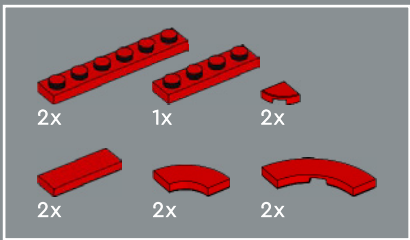

124

1



2

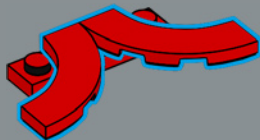

3

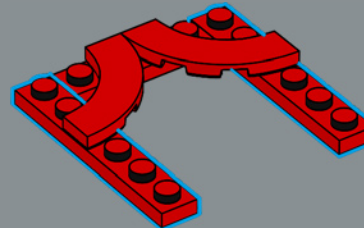

4

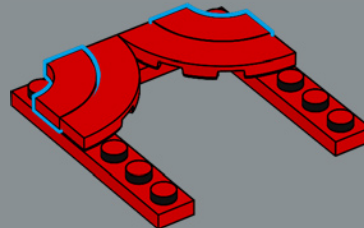

5

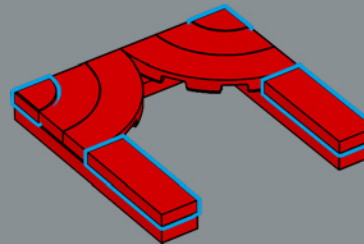



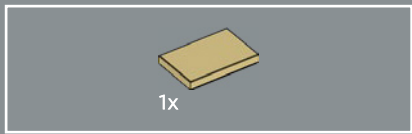

125

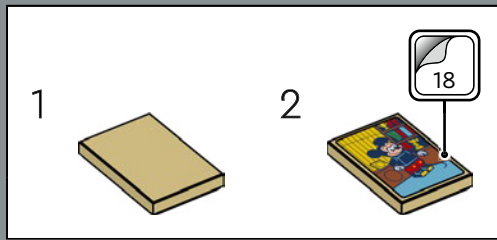



126

1



2



3

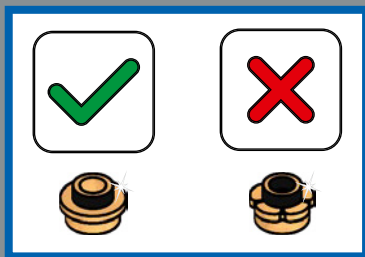
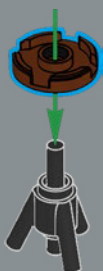

4

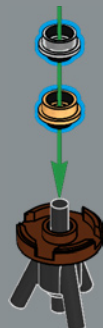

5



6



7



The lamp in the apartment window above the Fire Department is a tribute to Walt Disney and remains illuminated as a reminder of his presence and legacy.
La lampe dans la fenêtre de l'appartement, au-dessus du poste d'incendie, demeure allumée en hommage à Walt Disney et à son héritage.

El farol de la parte superior de la ventana de la estación de bomberos es un homenaje a Walt Disney, y se mantiene encendido en memoria de su presencia y legado.





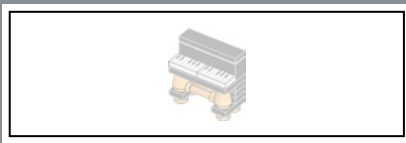

127

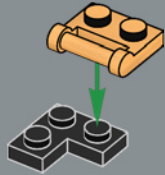

128

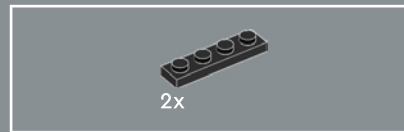
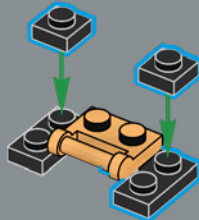

129

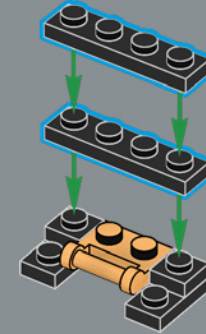

130



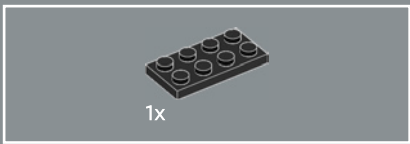

1x

131

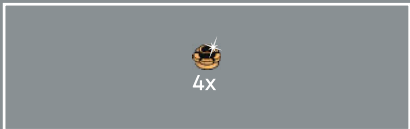
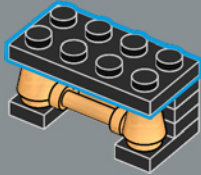

4x

132

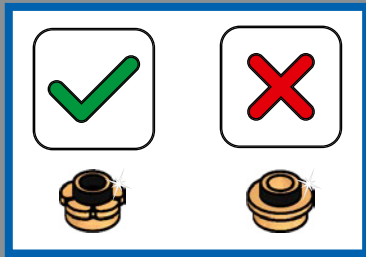
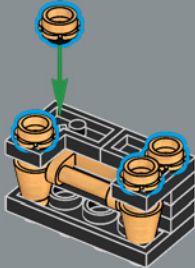

2x

133

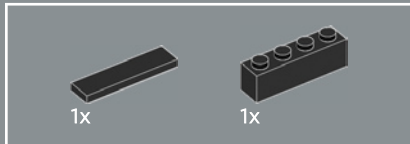
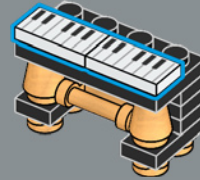

1x

1x

134

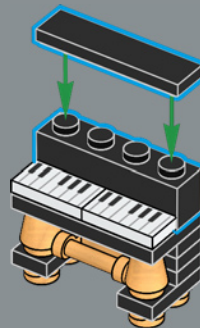

A LEGO® piano is included to reference the iconic music featured in Disney films throughout the years.

Un piano LEGO® est inclus pour faire référence à la musique emblématique des films Disney au fil des ans.

Este lugar incluye un piano LEGO® como referencia a la icónica música utilizada en las películas Disney a lo largo de los años.

135

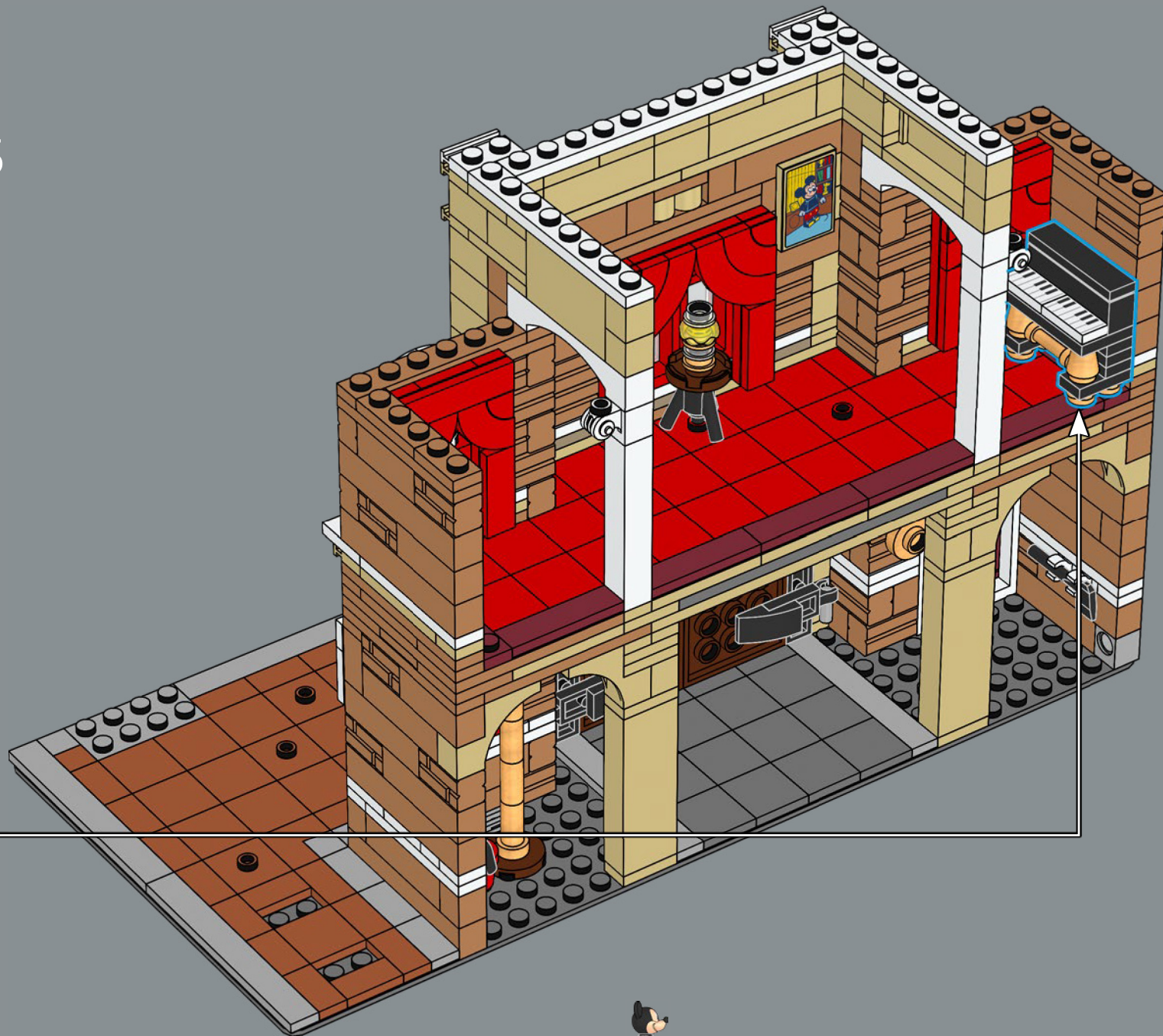



136

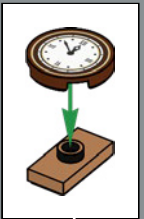

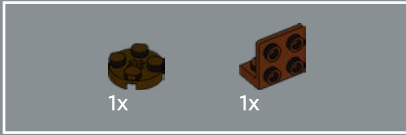
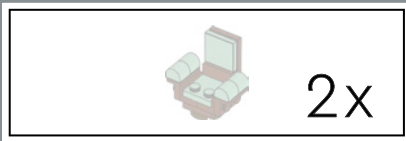

137

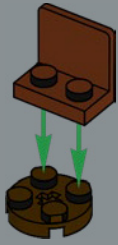

138



139

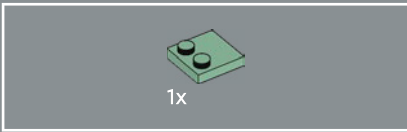

140





141

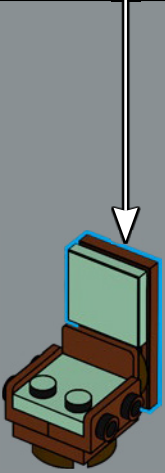
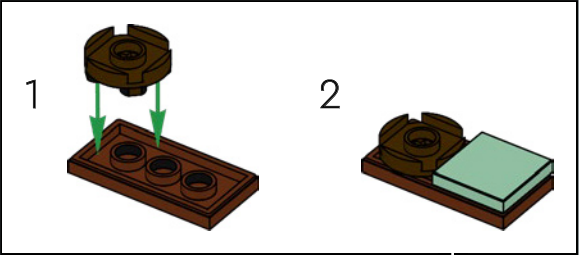

142

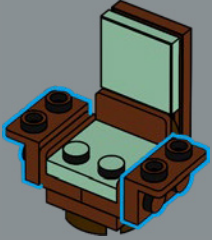

143

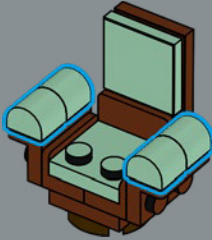

2x

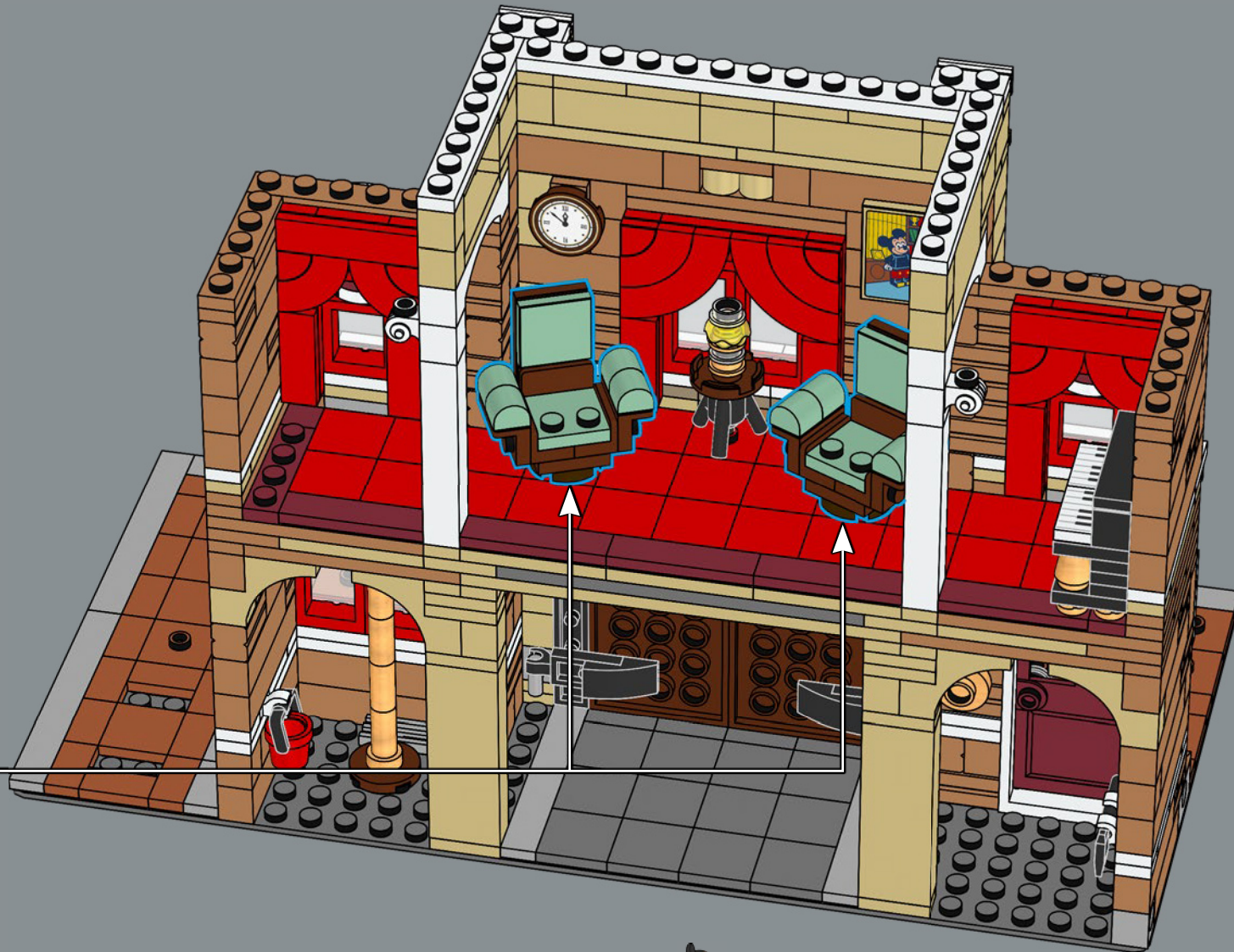

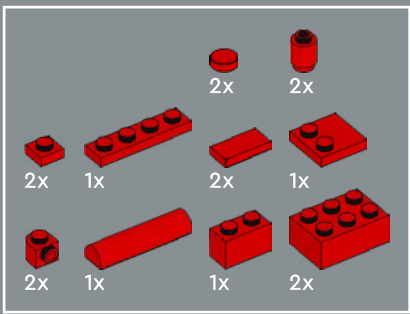

145

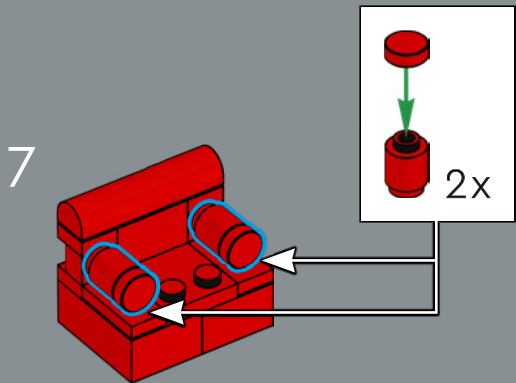
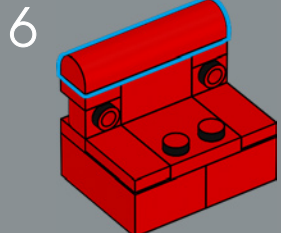
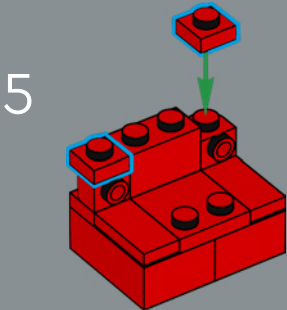
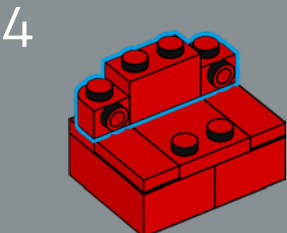
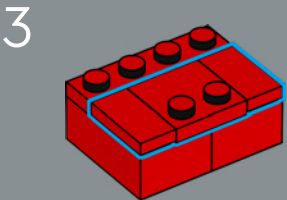
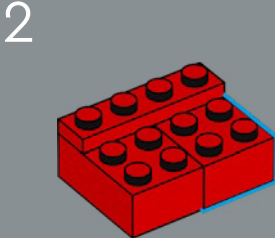
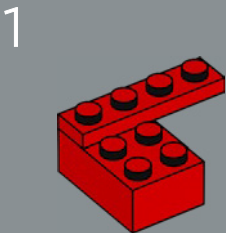

The interior of the Disney family apartment was designed with input from Walt's wife, Lillian, whose favorite color was cranberry red.

L'intérieur de l'appartement a été décoré avec la participation de Lillian, l'épouse de Walt, dont la couleur préférée était le rouge canneberge.

Lillian Disney, la esposa de Walt, cuyo color favorito era el rojo arándano, colaboró en el diseño del departamento familiar.

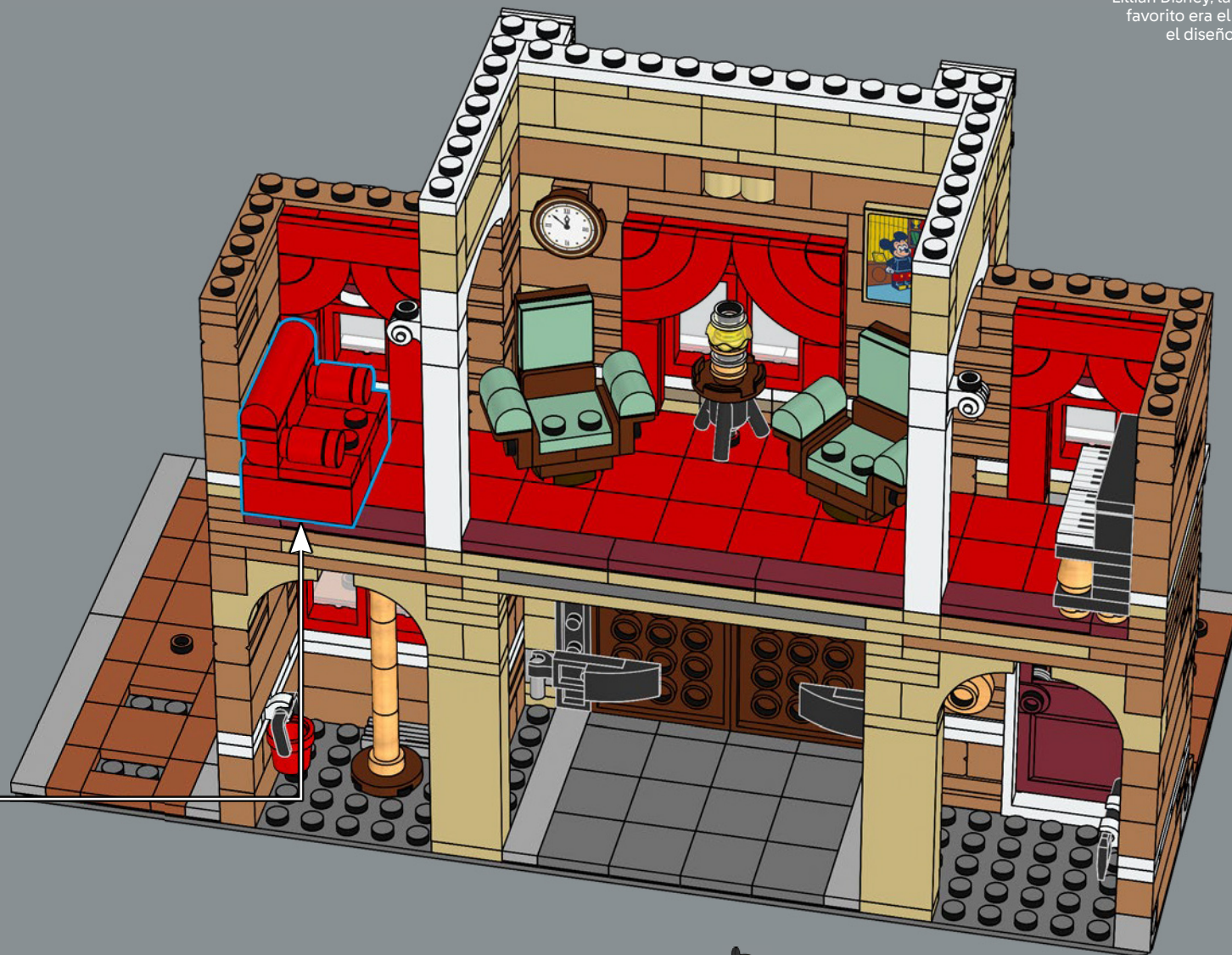

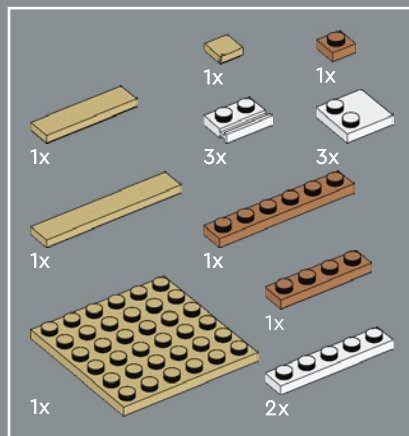

146

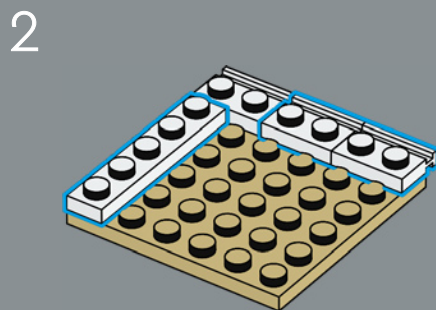
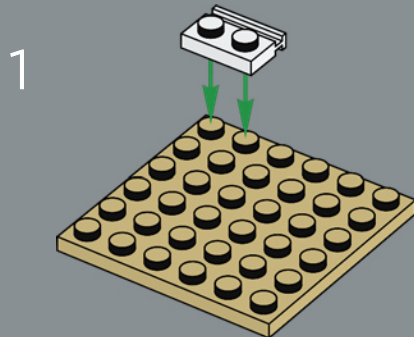

3

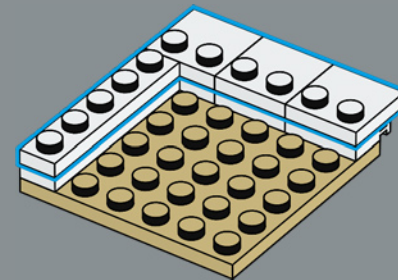

4

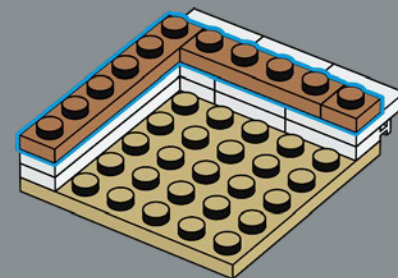

5

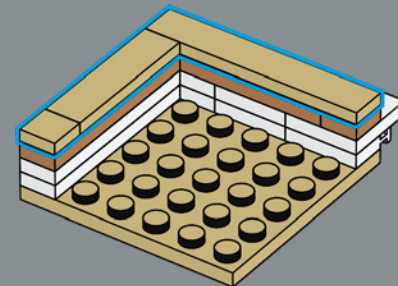

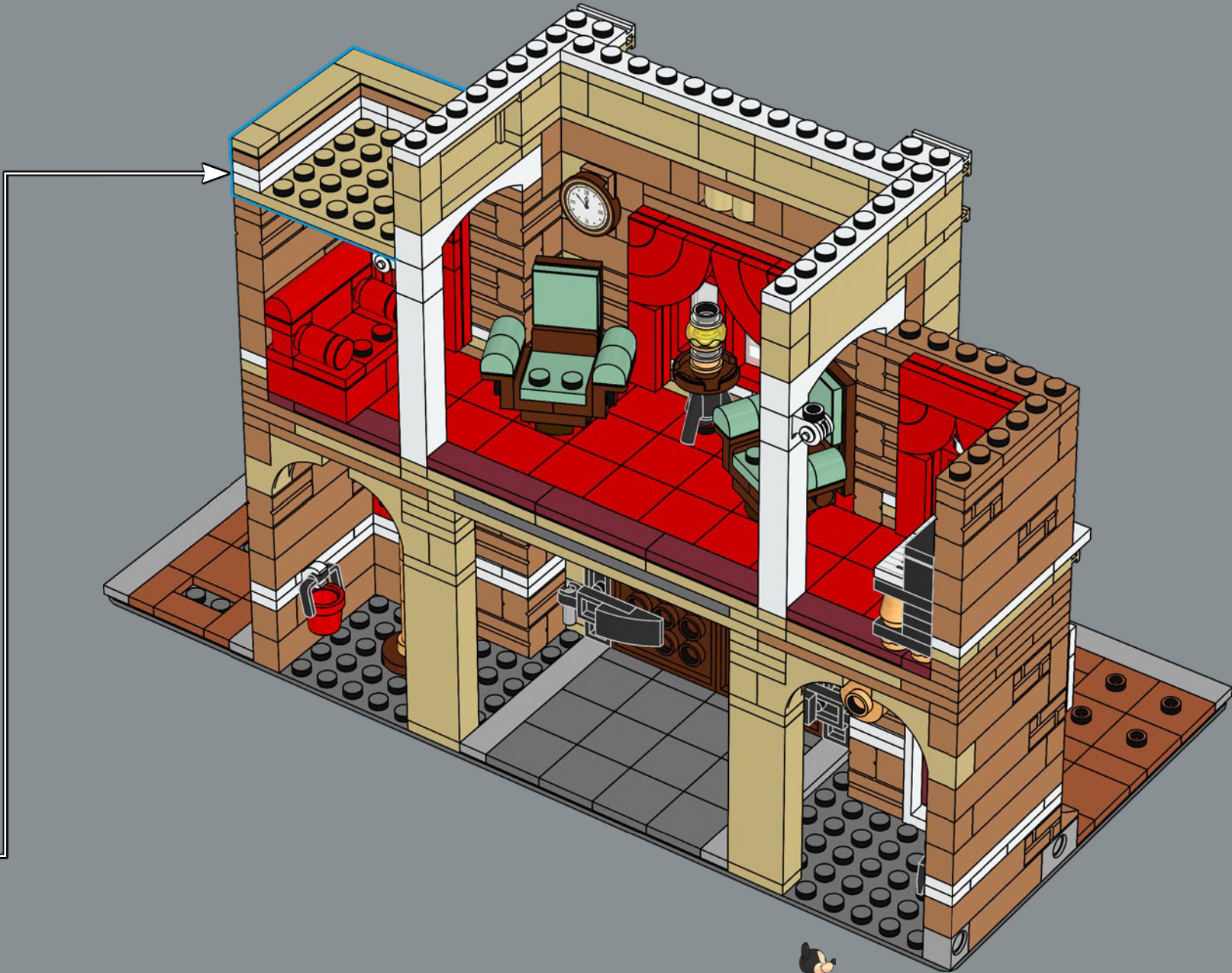

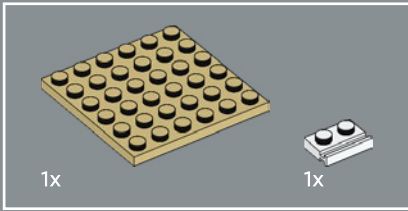
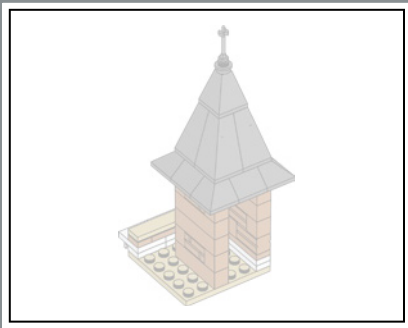

147

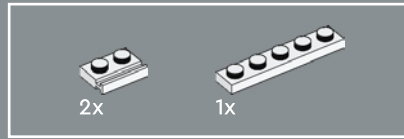
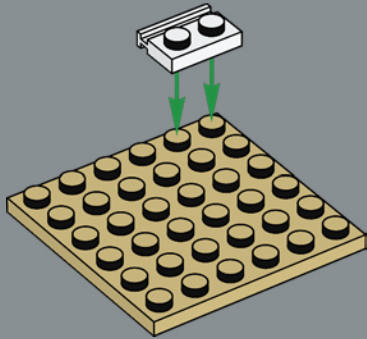

148

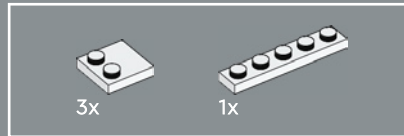
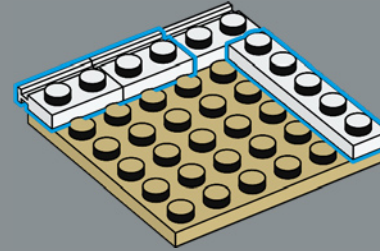

149

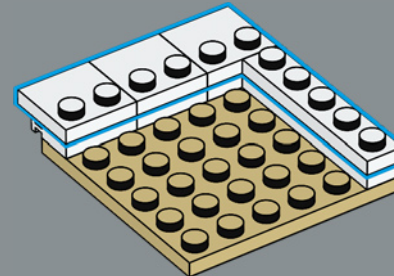

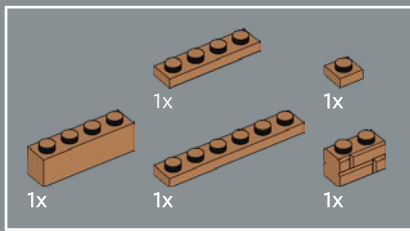

150

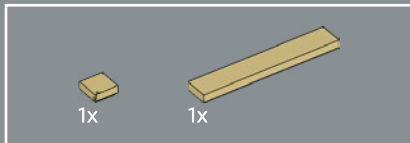
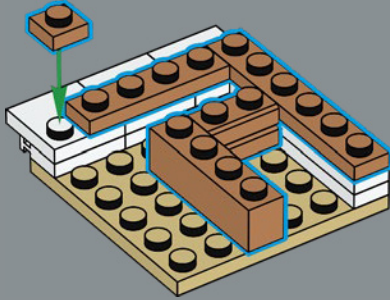

151

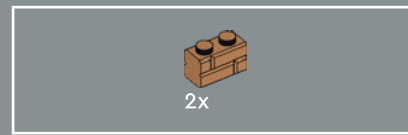
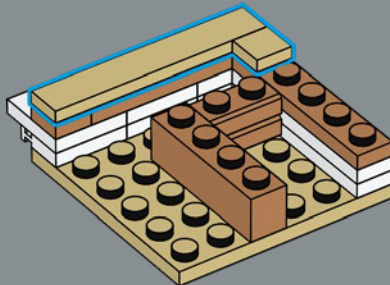

152

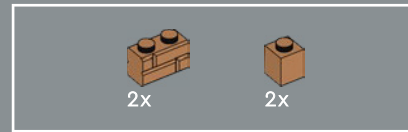
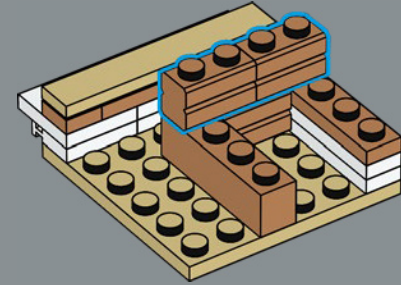

153

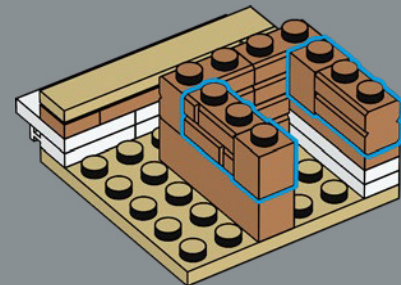



154

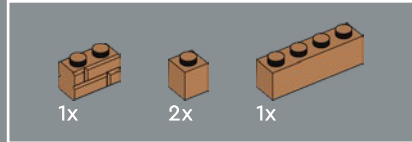
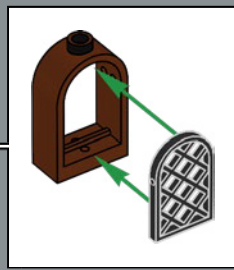
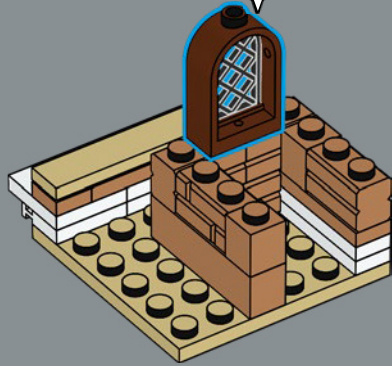

155

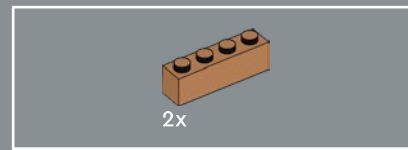
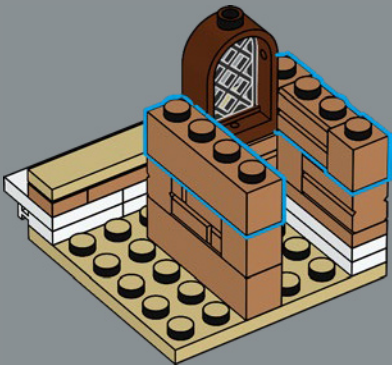

156

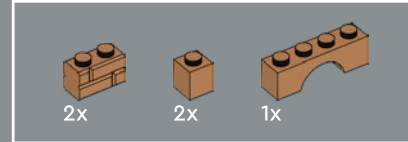
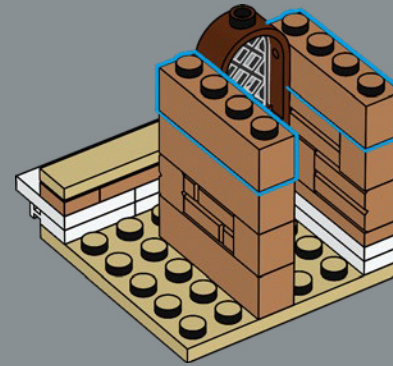

157

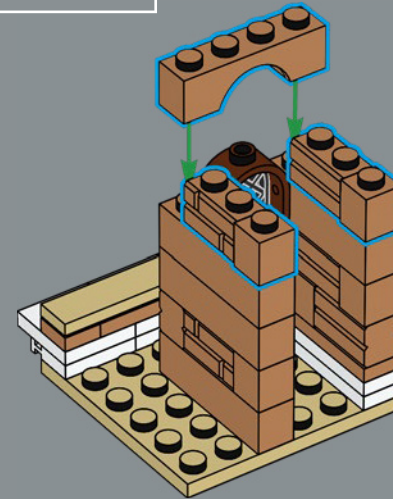

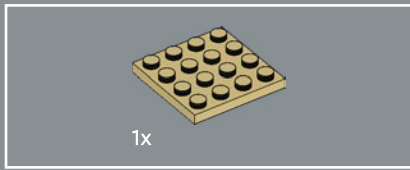

158

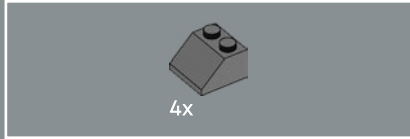
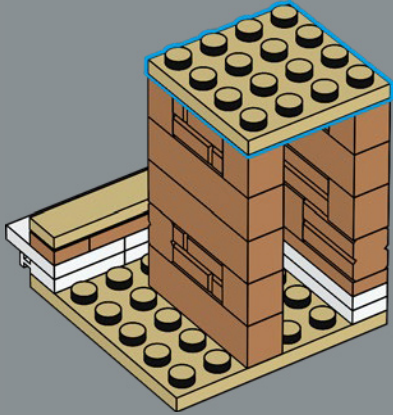

159

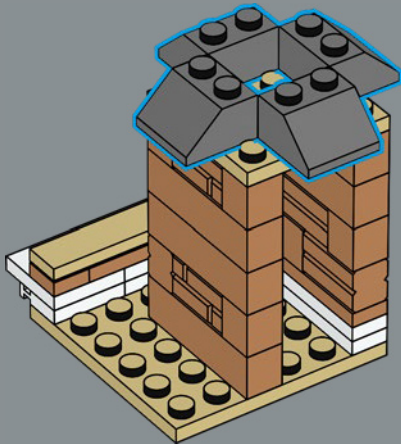

160

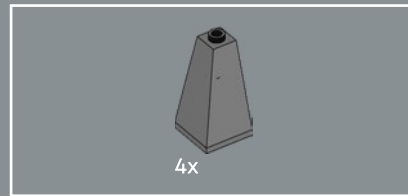
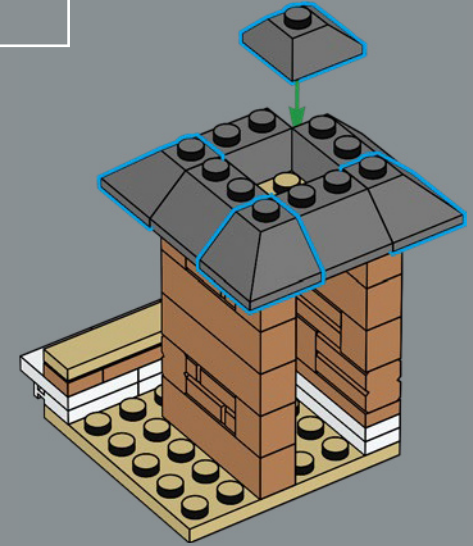

161

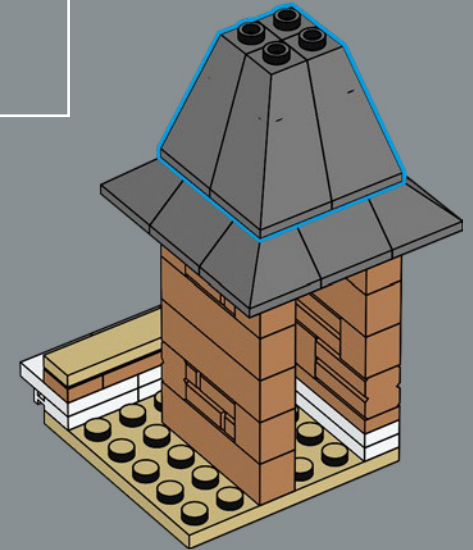

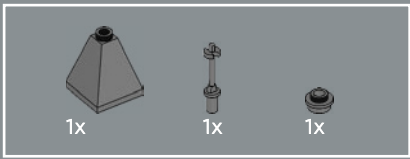

162

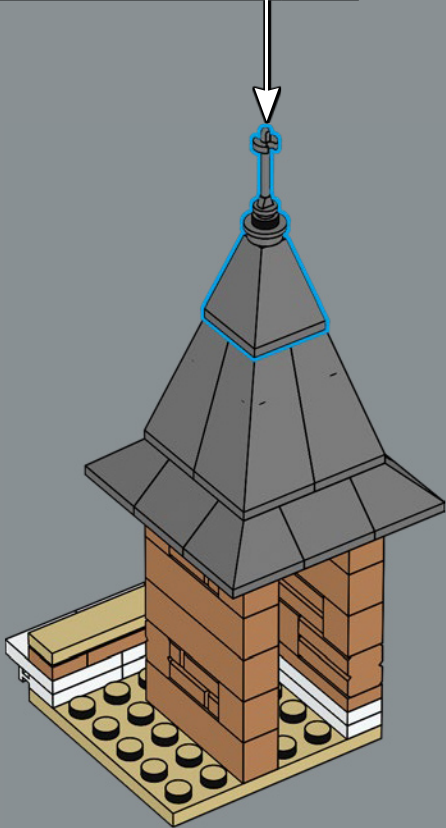
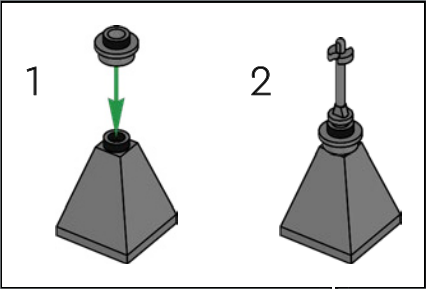

163



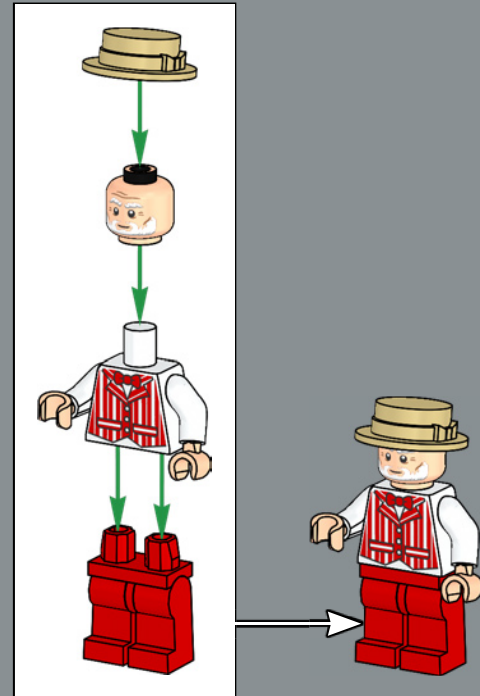

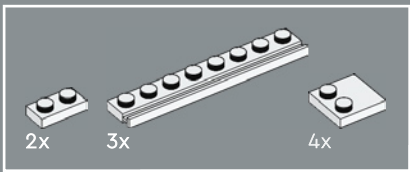

164



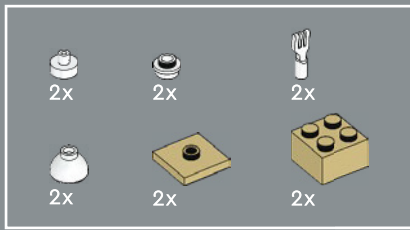

165

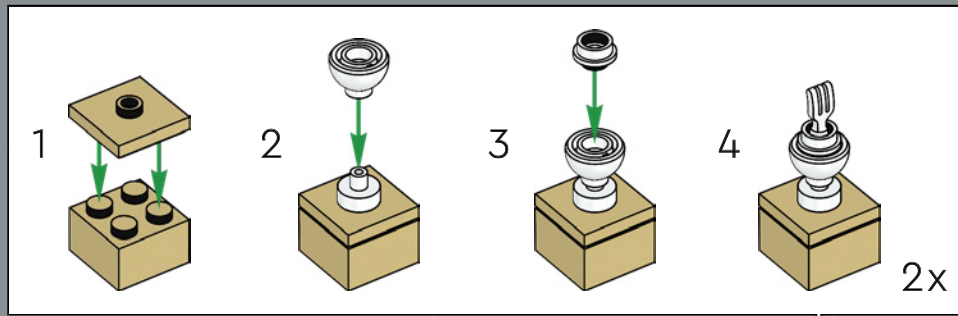

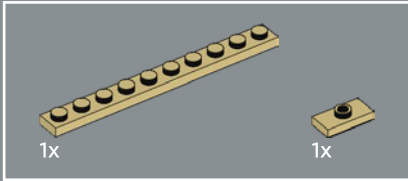
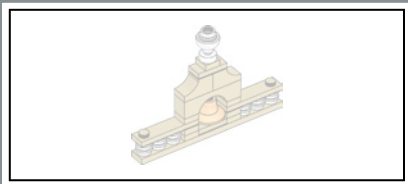

166

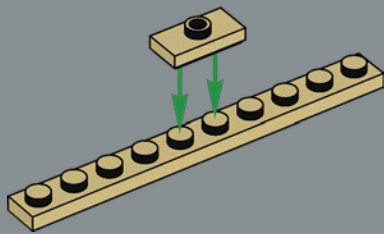

167

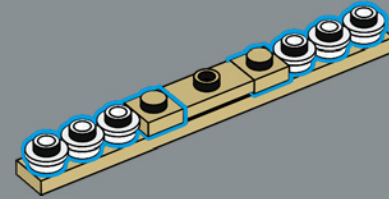

168

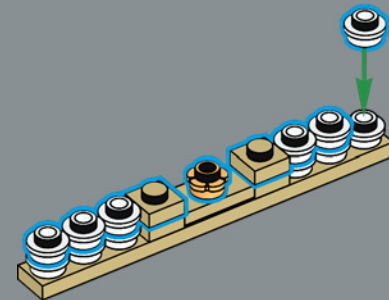



169

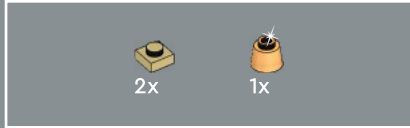
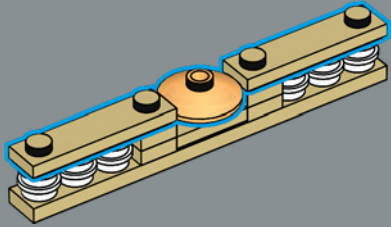

170

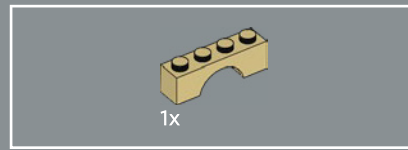
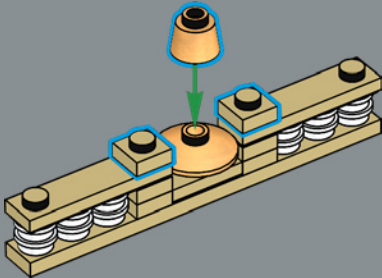

171

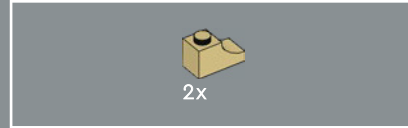
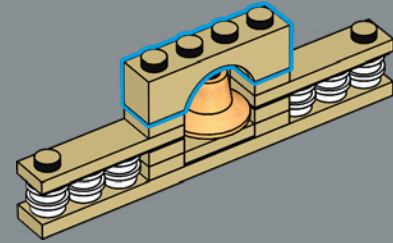

172

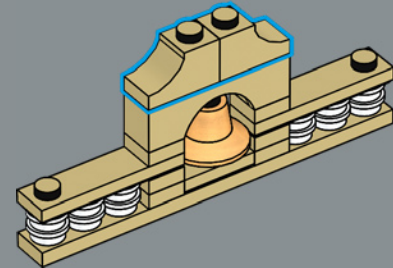

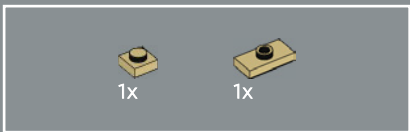

173

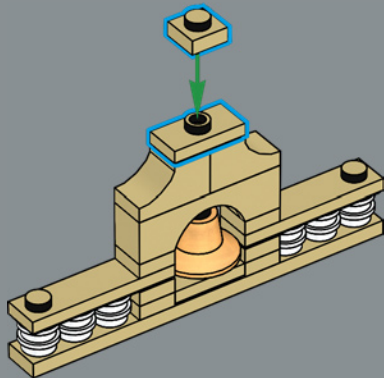

174

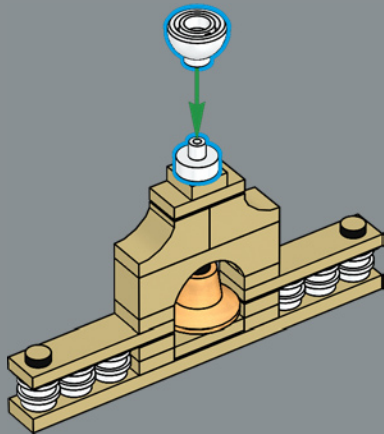

175

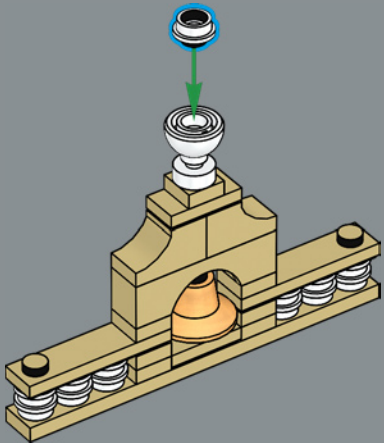

176

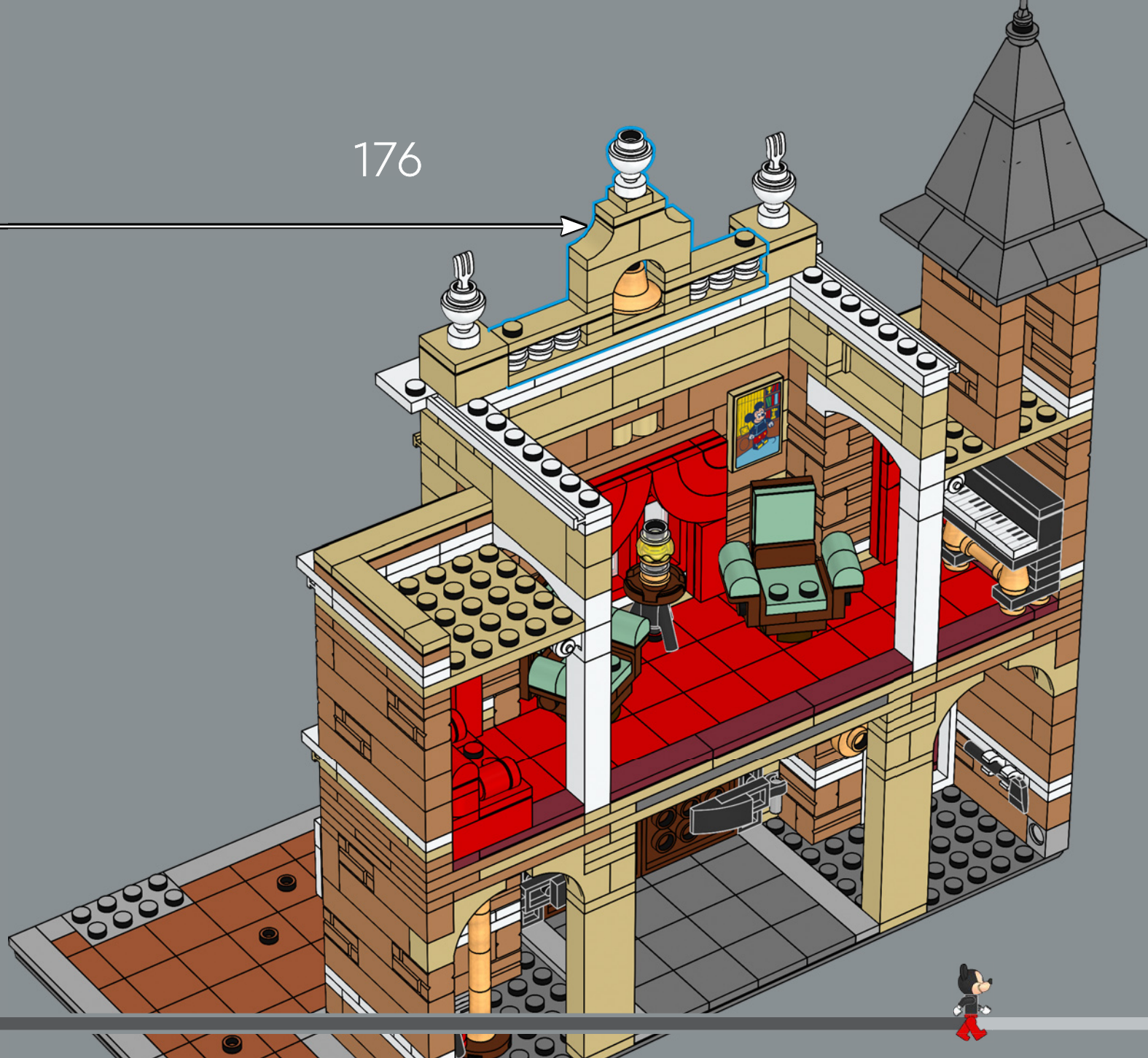

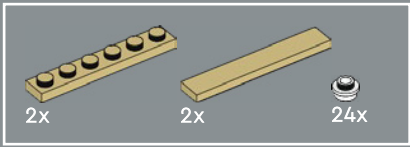

177

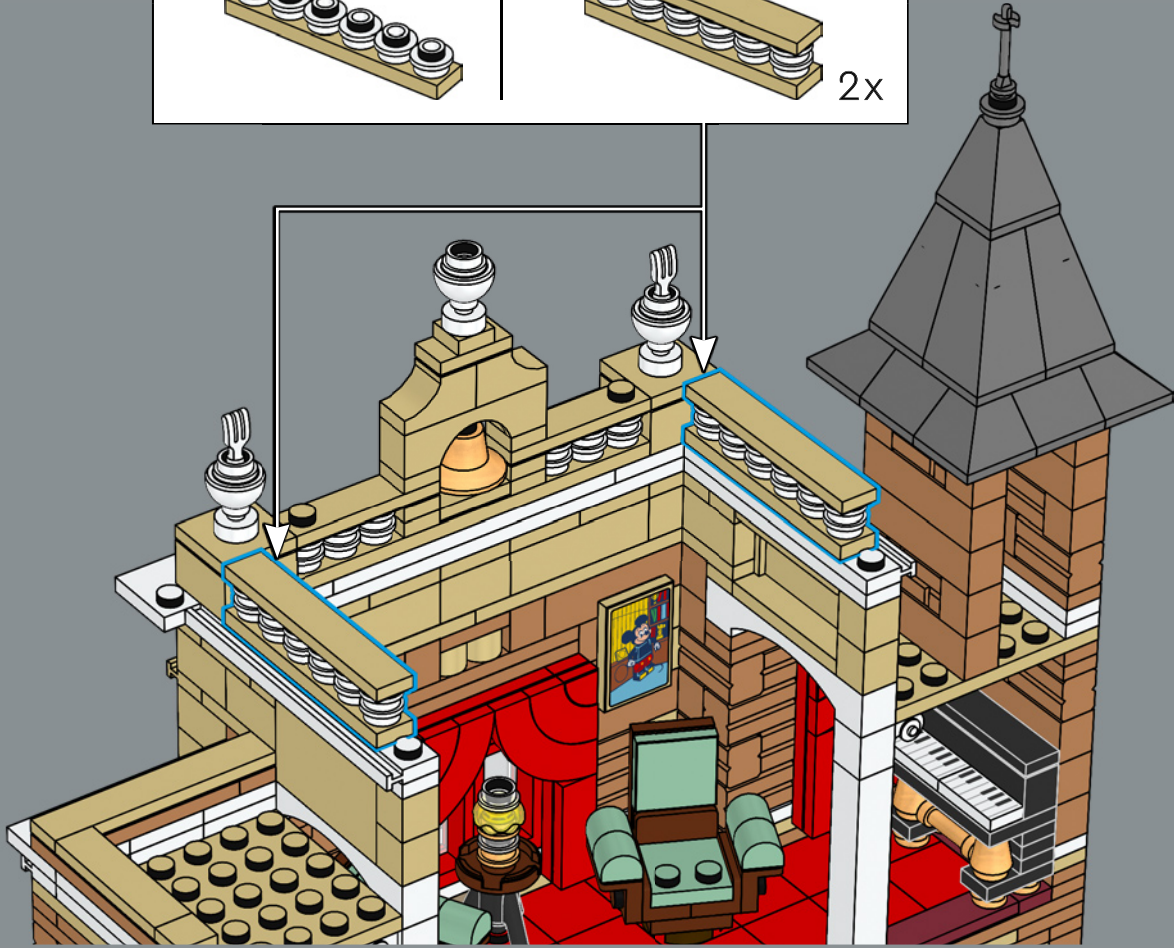
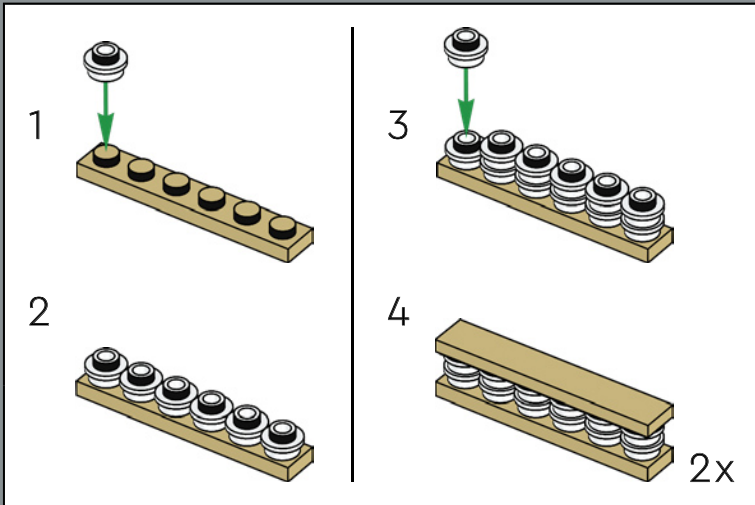



178

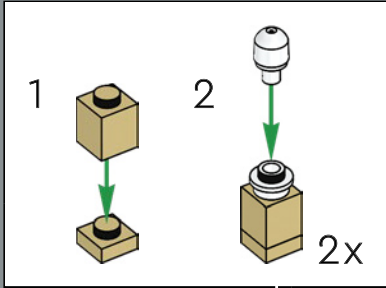

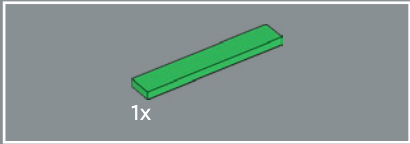
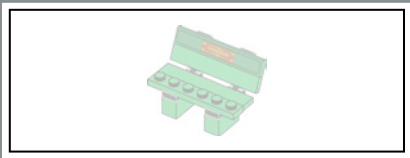

1x

179

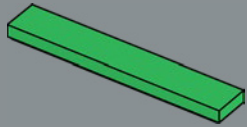

180

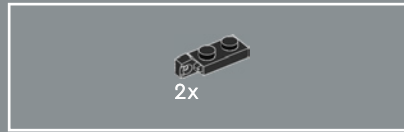
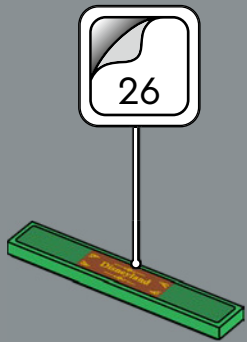

2x

181

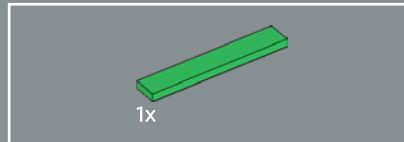
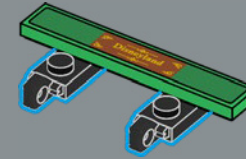

1x

182

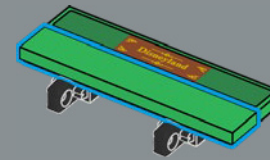



183

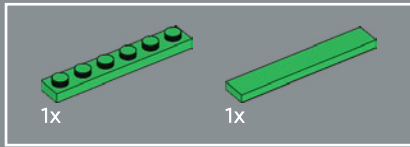
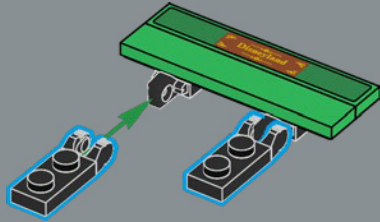

184

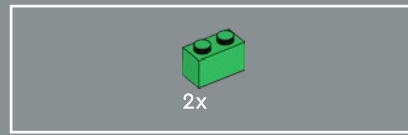
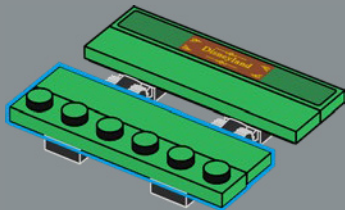

185

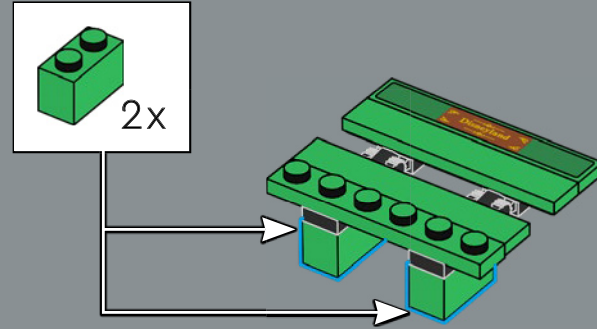

186

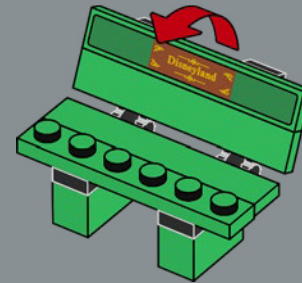

187



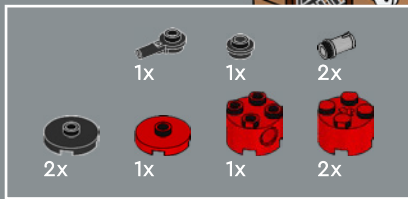

188

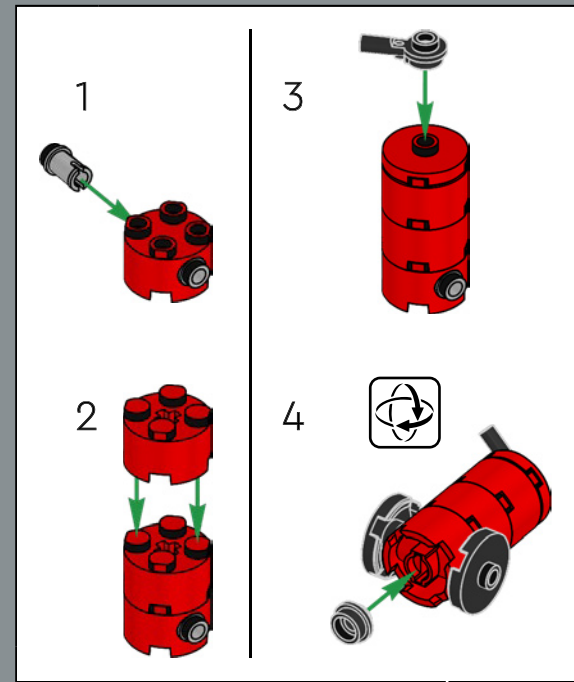

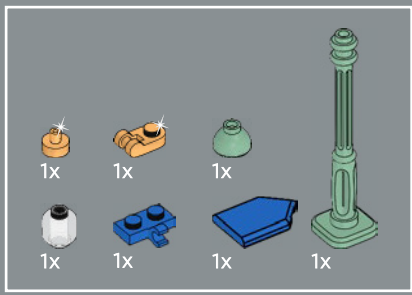

189

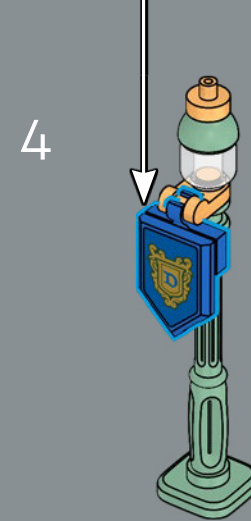
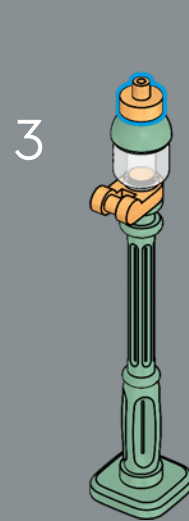
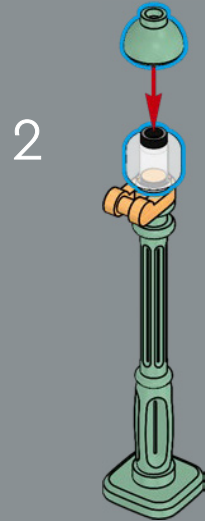
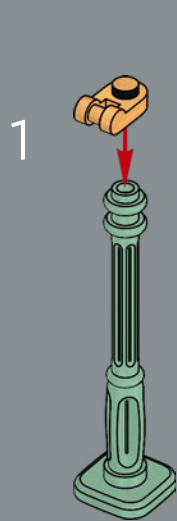
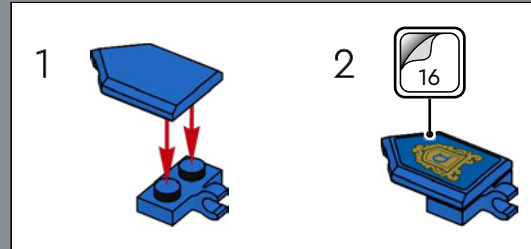



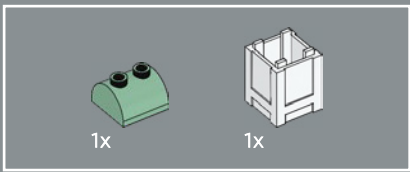

190

Park trash cans were originally planned to be no more than 30 feet (9 meters) apart when Walt Disney observed how far guests would walk before discarding trash.

Walt Disney avait remarqué que les visiteurs ne marchaient généralement pas plus de 9 mètres (30 pieds) avant de jeter leurs déchets. C'est ainsi que l'espacement stratégique des poubelles dans le parc a été imaginé.

Walt Disney observó qué tan lejos estaban dispuestos los visitantes a caminar para deshacerse de la basura y, en consecuencia, se estableció que la distancia máxima entre los basureros fuera de 9 m.

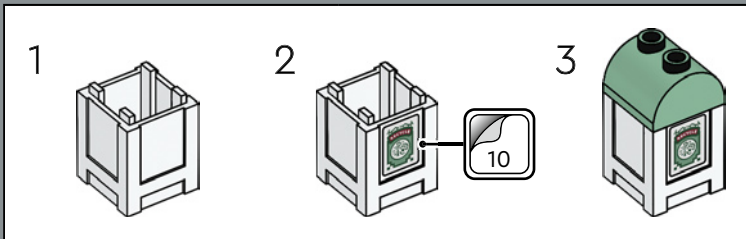

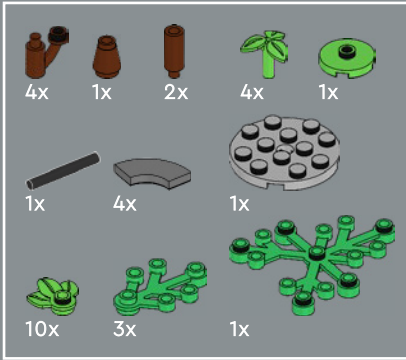
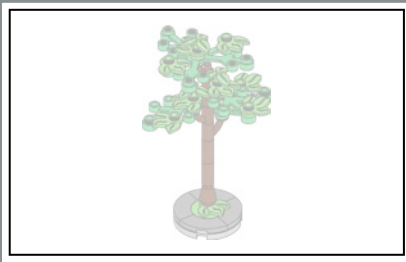

191

1

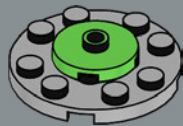

2

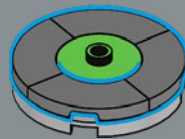

3

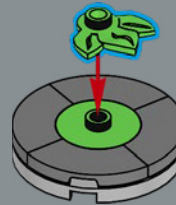

4



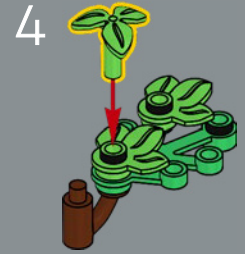
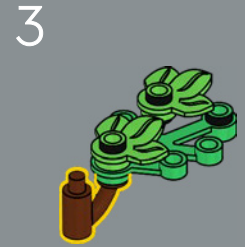
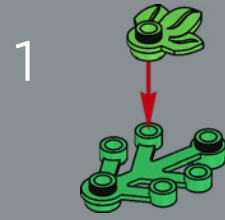
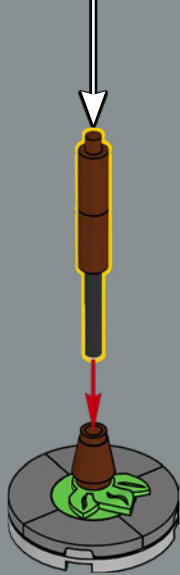
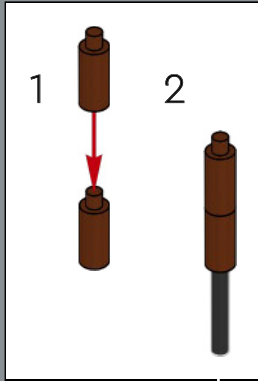

6

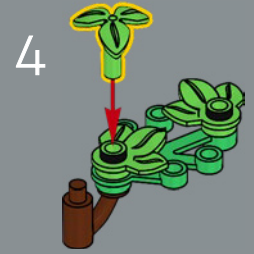
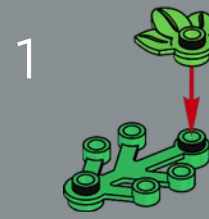
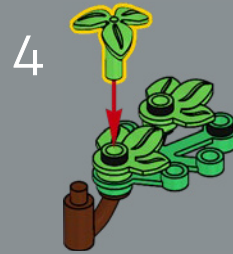
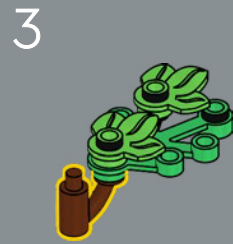
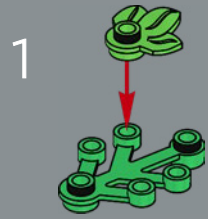

1

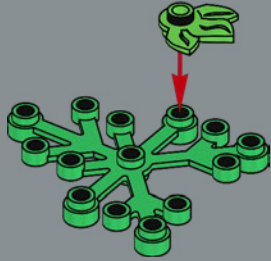

2

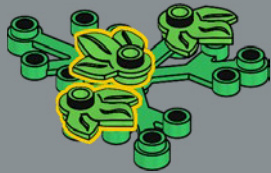

3



4

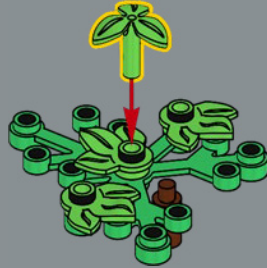

9

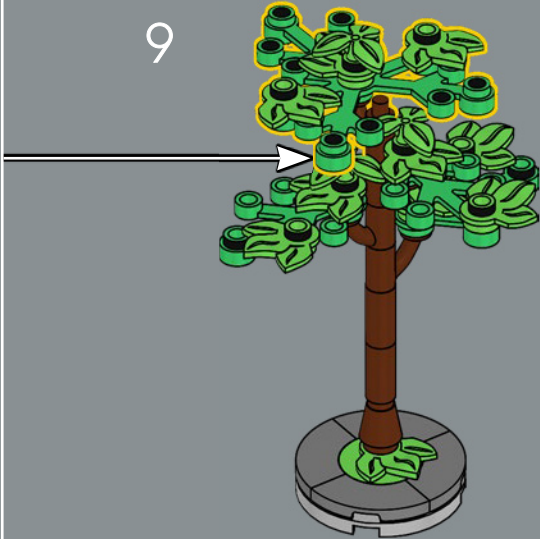



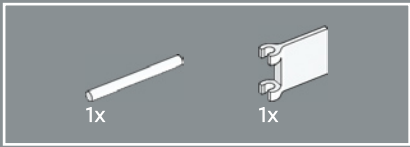

192

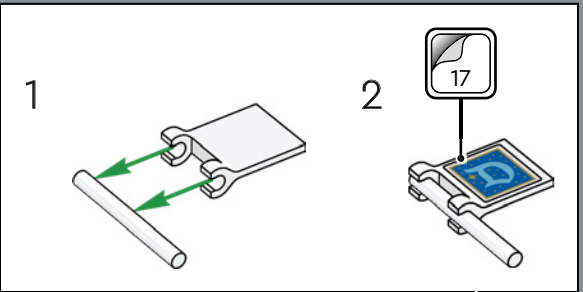



The world-famous Dapper Dans debuted on Main Street, U.S.A. in 1959, and continue to delight guests with classic and pun-filled barbershop tunes (including your favorite song: the last one).

Les célèbres Dapper Dans ont fait leurs débuts sur Disney Main Street en 1959, et continuent de ravir les visiteurs avec leurs airs de barbershop classiques et pleins de jeux de mots (y compris votre chanson préférée : la dernière).

Los mundialmente famosos Dapper Dans debutaron en Main Street, U.S.A. en 1959 y siguen deleitando a los visitantes con clásicas canciones repletas de juegos de palabras (incluida la favorita de todos: ¡la última!).



LEGO and the LEGO logo are trademarks of the/son des marques de commerce du/son marcas registradas de LEGO Group. ©2026 The LEGO Group.

© Disney © Disney/Pixar © & TM Lucasfilm Ltd © 2026 MARVEL

 6649254