



Disney

43306





LEGO® Builder



LEGO.com/sustainable-packaging



**FR**  
**DONNEZ**  
OU  
**RECYCLEZ**

 OU  OU 

ASSOCIATION MAGASIN DÉCHÈTERIE

Adresses sur [quefairedemesdechets.fr](http://quefairedemesdechets.fr)

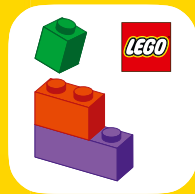

LEGO® Builder



# BUILDER



Apple and the Apple logo are trademarks of Apple Inc., registered in the U.S. and other countries and regions. App Store is a service mark of Apple Inc. Google Play and the Google Play logo are trademarks of Google LLC. Tencent and the Tencent logo are trademarks of Tencent Inc.

[LEGO.com/devicecheck](https://www.lego.com/devicecheck)

**EN** Ask parents' permission before going online | **DE** Eltern um Erlaubnis bitten, bevor du online gehst | **FR** Demande l'autorisation d'un parent avant d'aller en ligne | **IT** Chiedi il permesso ai tuoi genitori prima di andare online | **ES** Pídeles permiso a tus papás antes de conectarte a Internet | **PT** Peça autorização aos teus pais antes de ficares online | **ZH** 上网前应先征得父母的同意 | **PL** Poproś rodziców o zgodę, zanim wejdiesz do Internetu | **CS** Než půjdeš na internet, požádej rodiče o svolení | **SK** Skôr než pôjdeš na internet, vypoťaj si povolenie od rodičov | **HU** Kérj szülői engedélyt, mielőtt online csatlakoznál! | **UA** Запитуйте дозволу батьків, перш ніж користуватися інтернетом | **RO** Cere permisiunea părinților înainte de a te conecta online | **BG** Поискайте разрешение от родител, преди да влезете онлайн | **LV** Pirms došanās tiešsaistē palūdz atļauju vecākiem | **ET** Enne Interneti kasutamist küsi vanematelt luba | **LT** Prieš prisijungdami prie interneto, atsiklauskite tėvų | **TR** İnternete girmeden önce anne babandan izin iste



1x



1x

1

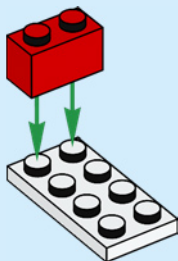



1x

2

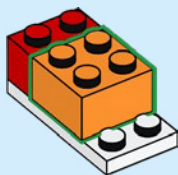

2x

3

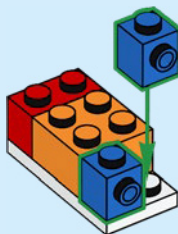
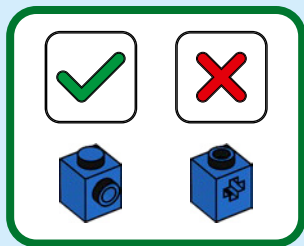

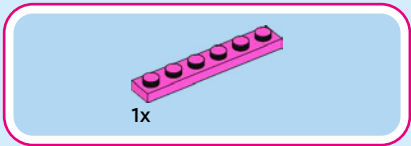

4

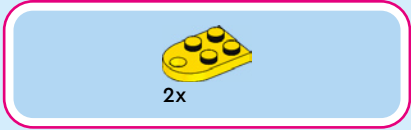
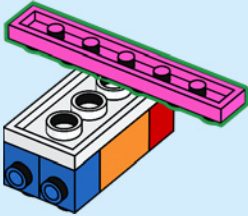

5

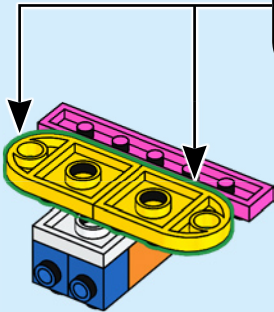
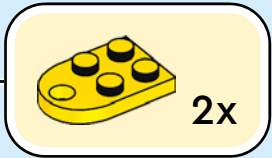

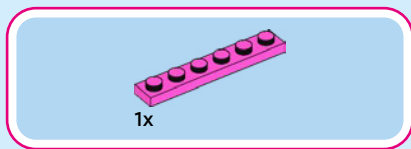

6

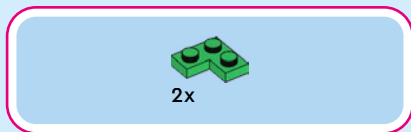
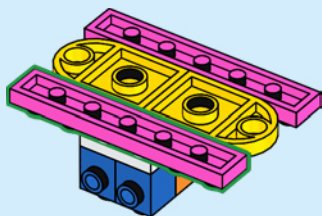

7

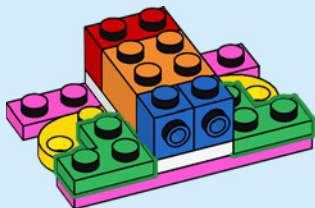

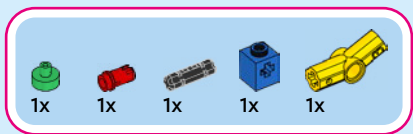

8

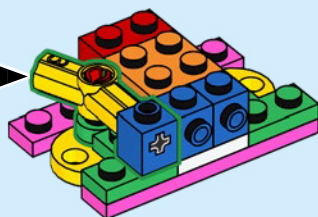
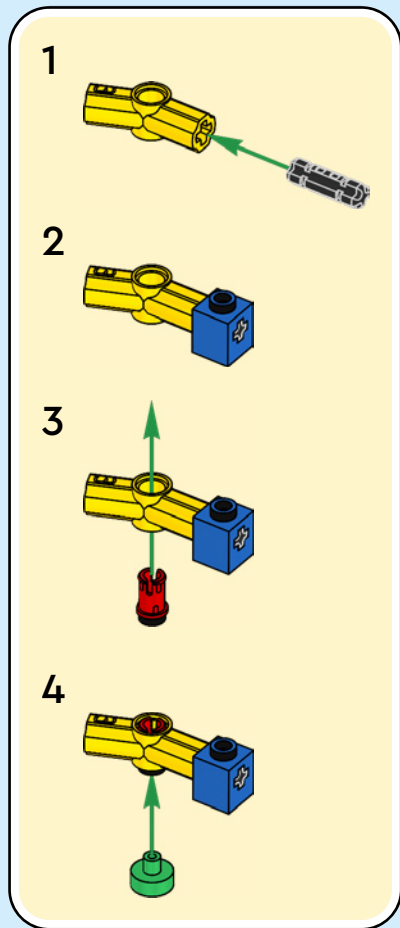

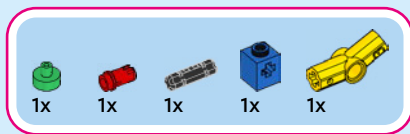

9

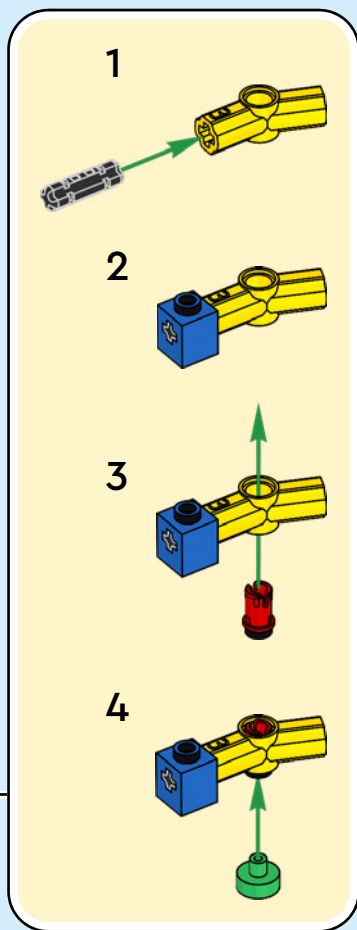
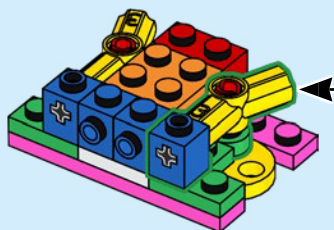



2x

10

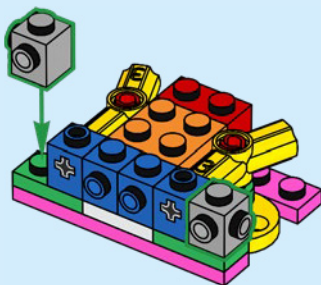

1x



1x

11

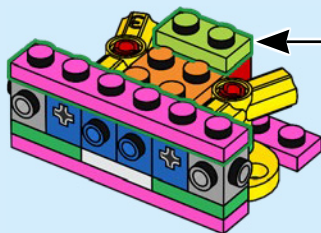



2x

12

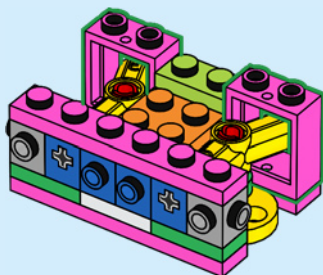

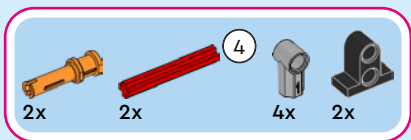

# 13

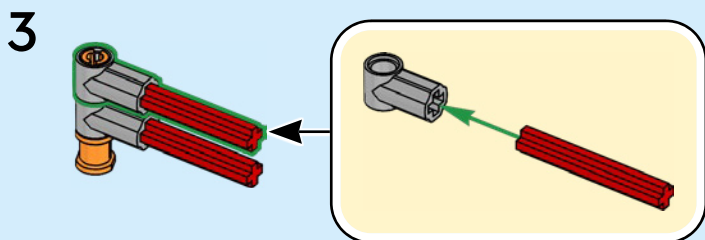
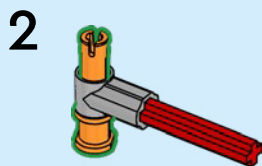
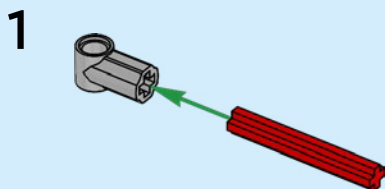

4

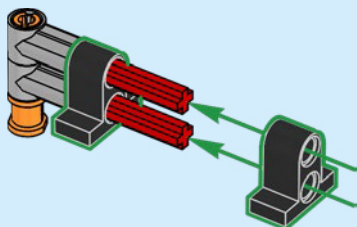

5

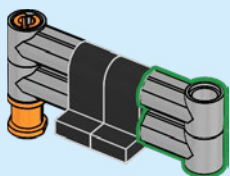

6

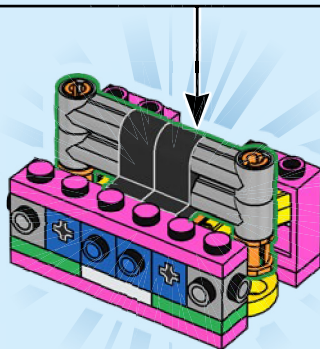
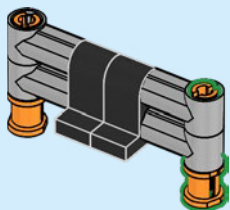



1x



2x

14

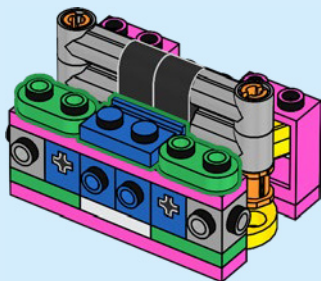

2x

15

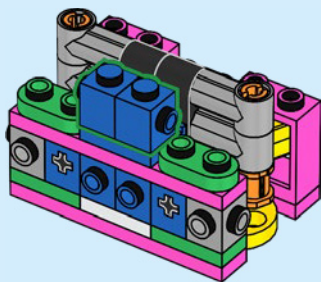



1x

16

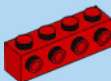
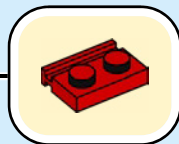
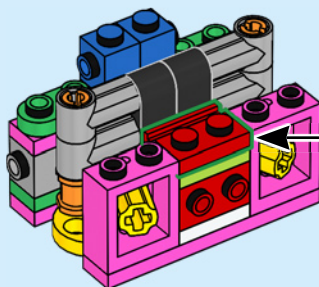

1x



2x

17

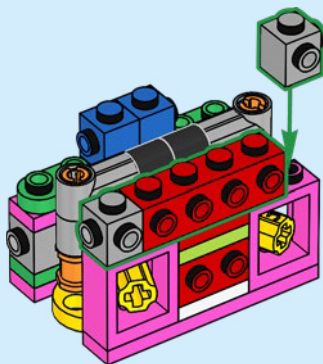



1x

18

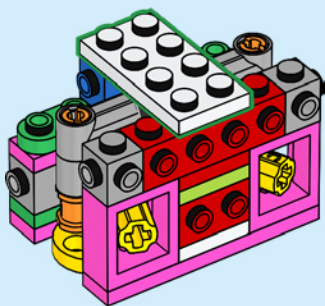

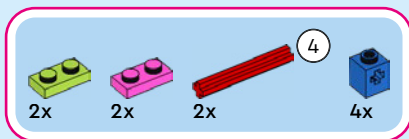

19

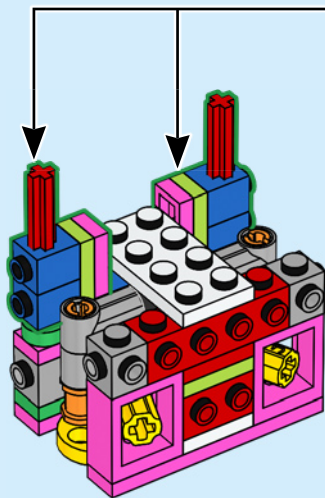
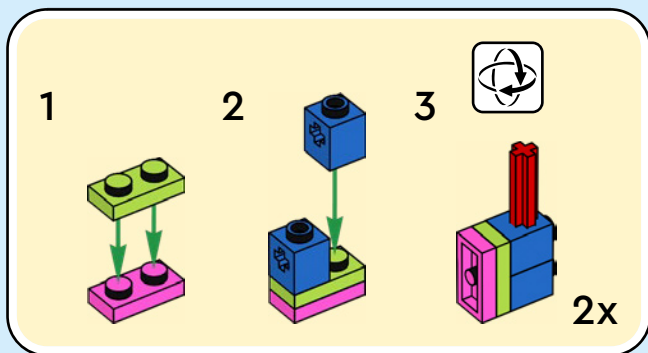



2x



4x

# 20

1

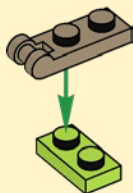

2

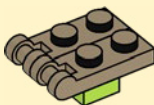

2x

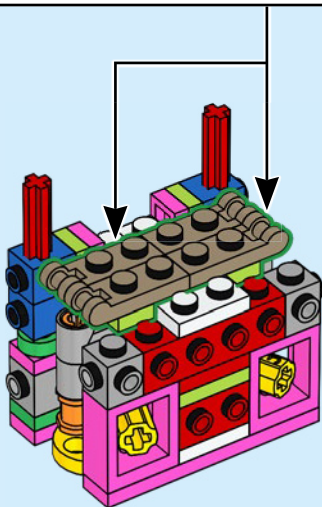



1x



1x

# 21

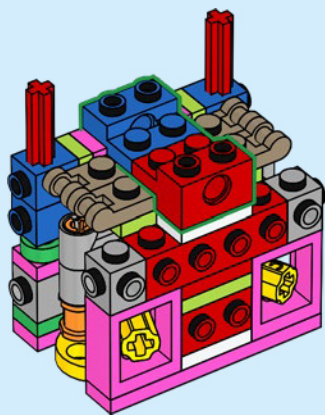



1x

22

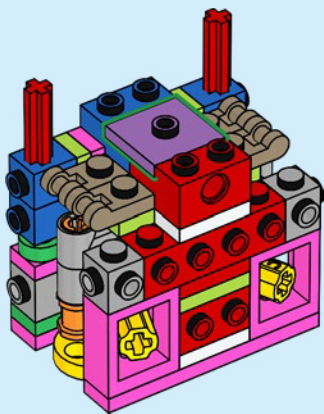



1x



2x

23

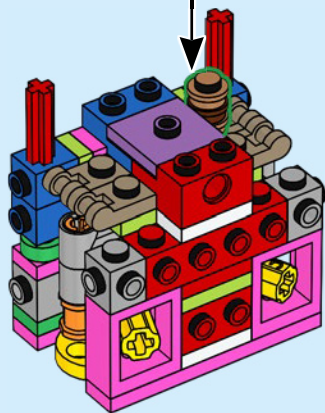
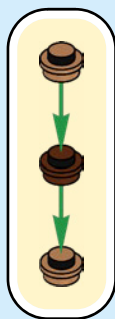



1x



1x



1x



1x

# 24

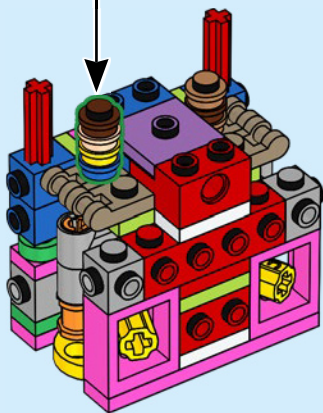
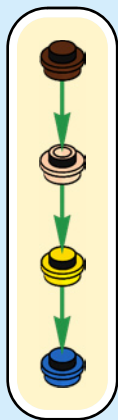



1x



1x



1x



1x

# 25

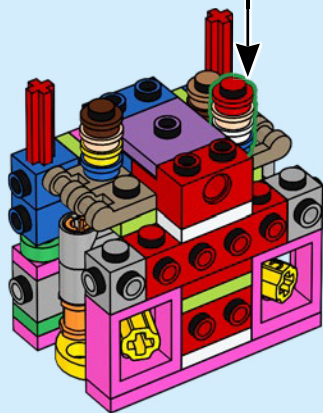
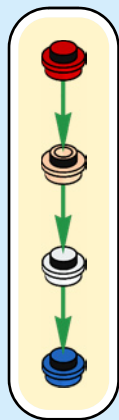



1x



1x



1x

# 26

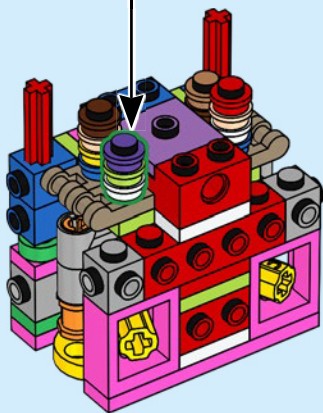
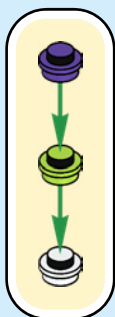



2x

27

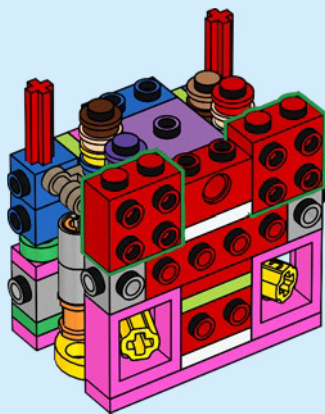



1x

28

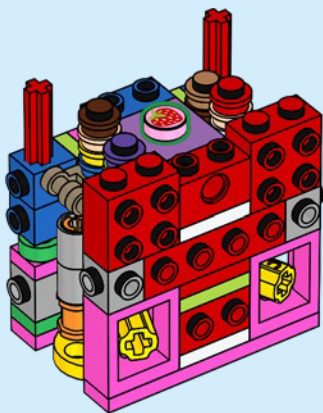



2x

29

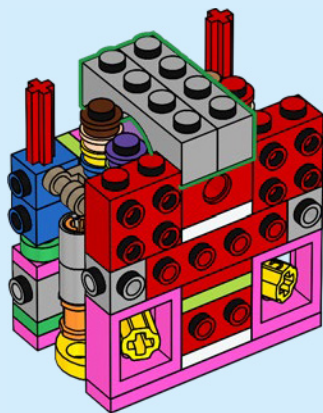



2x



2x

# 30

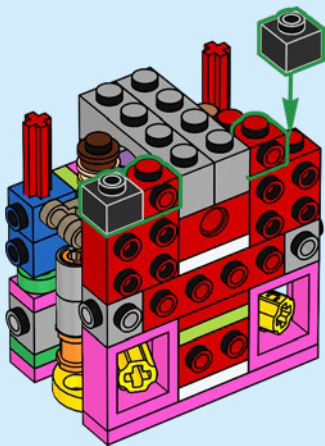



2x

31

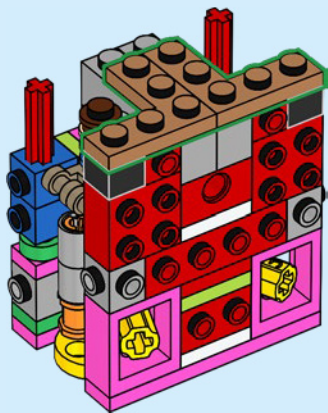

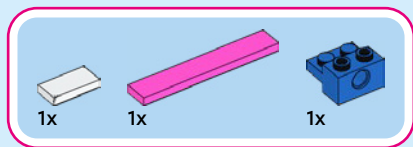

32

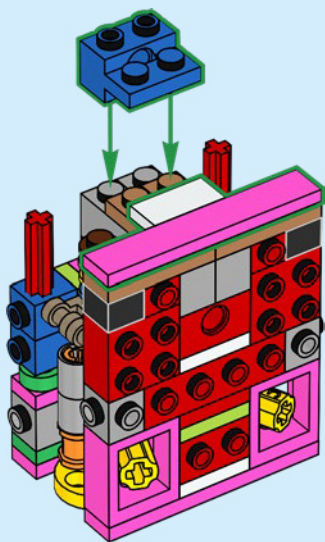



1x

33

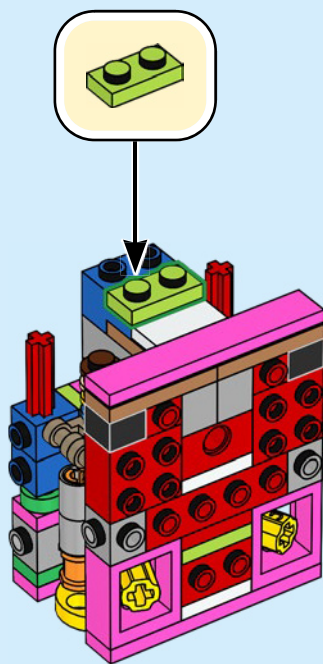



1x

# 34

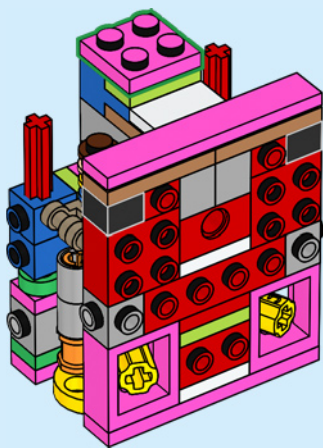



1x



1x

# 35

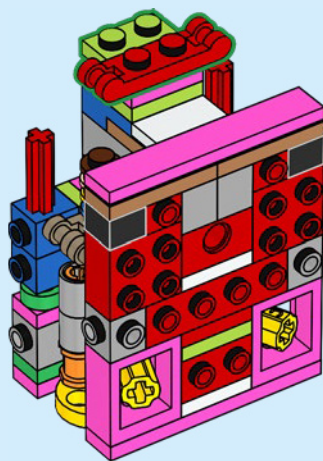



1x

36

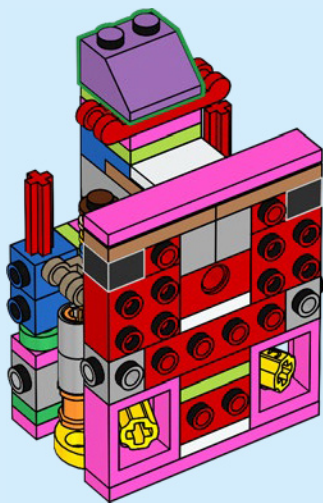



1x



1x

# 37

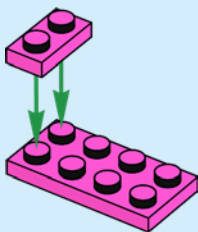

1x



1x

# 38

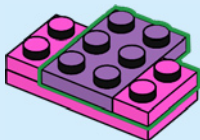



2x

# 39

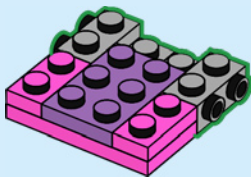

1x



1x

# 40

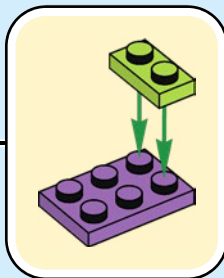
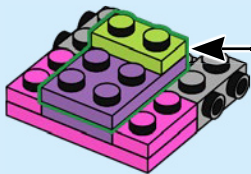

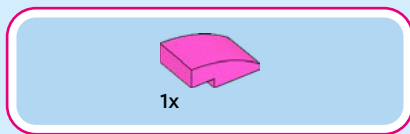

41

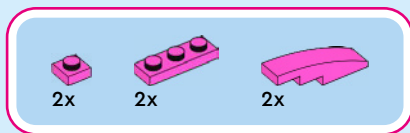
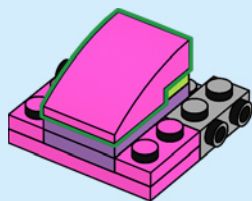

42

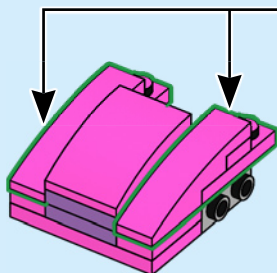
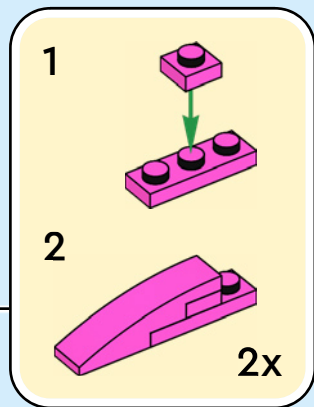



43

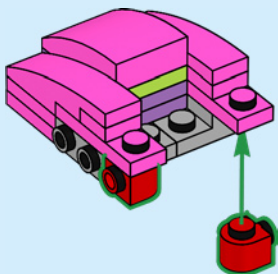

44

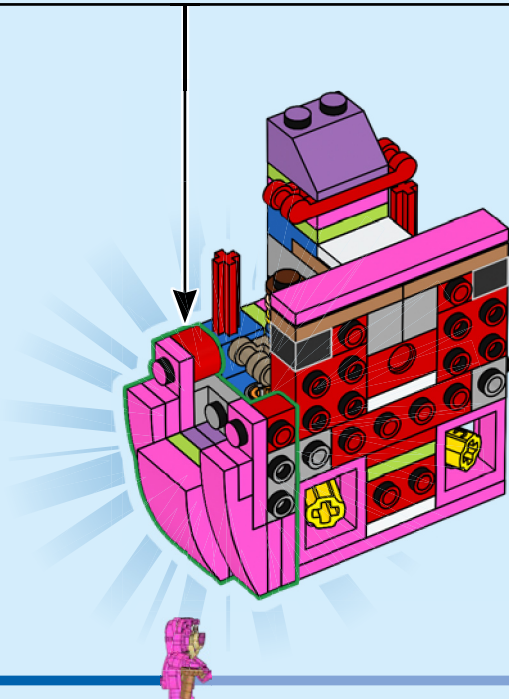



1x



1x

# 45

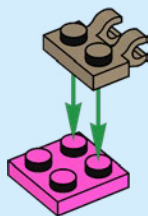

1x

# 46

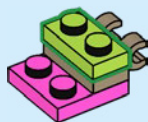



1x



1x



1x

# 47

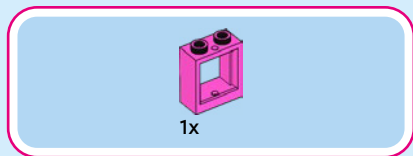
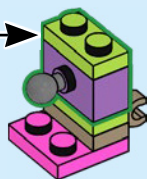
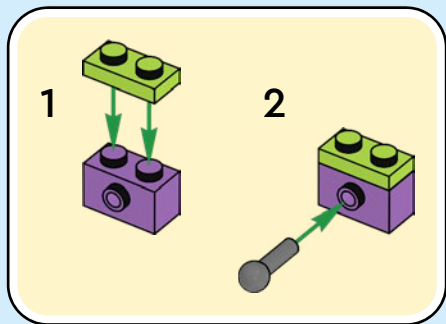

1x

# 48





1x

# 49

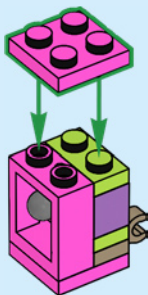

1x



1x



1x

# 50

1

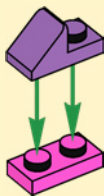

2

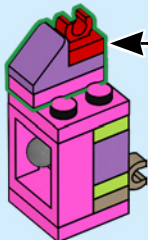

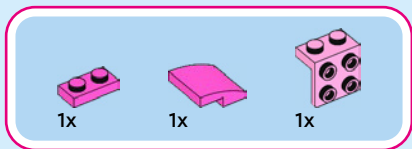

51

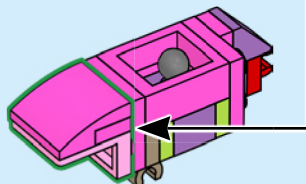
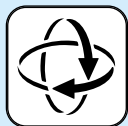
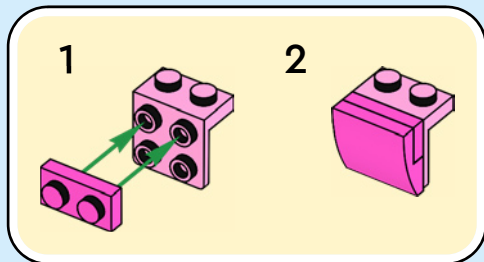

52

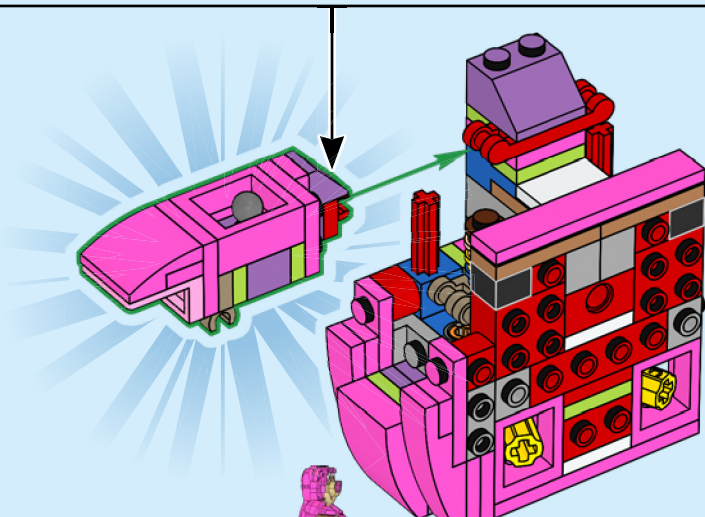

53

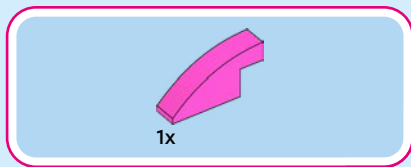
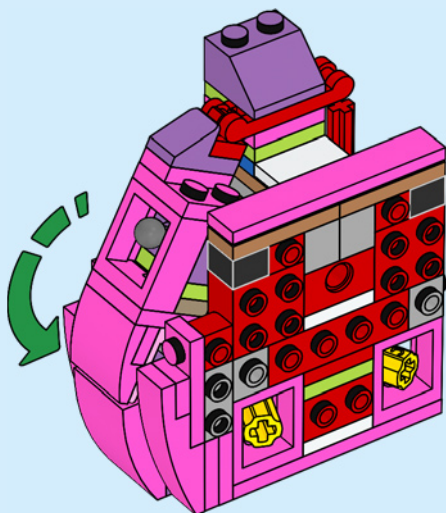

54

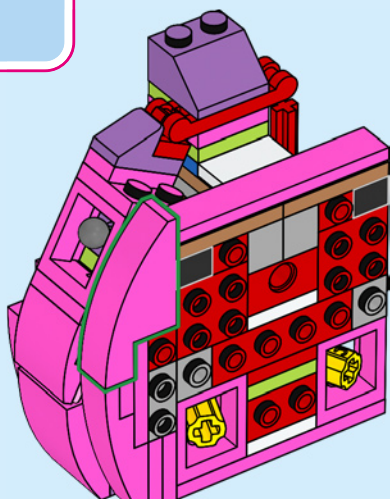



1x



1x

# 55

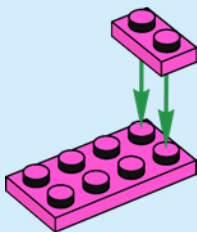

1x



1x

# 56

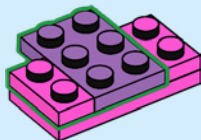



2x

57

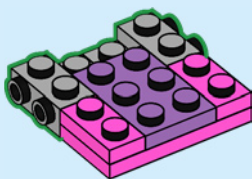

1x



1x

58

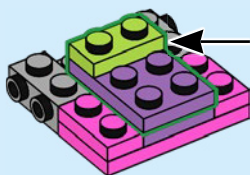
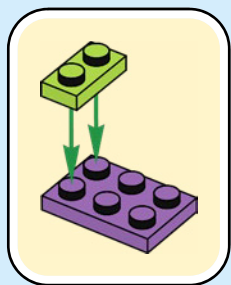

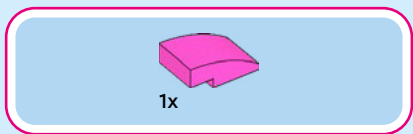

59

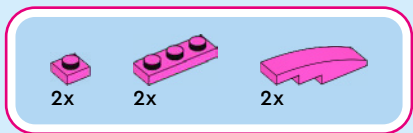
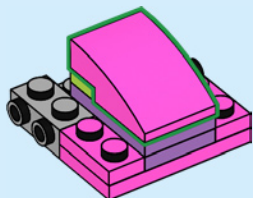

60

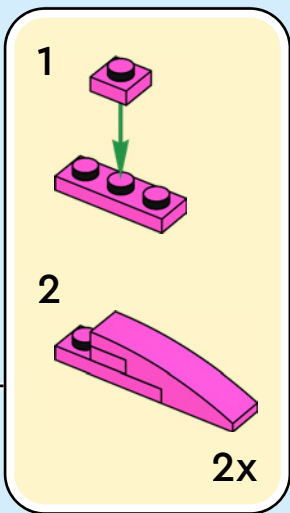
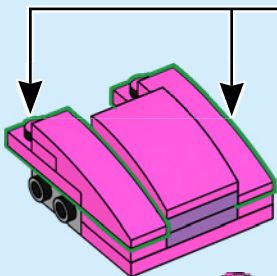



2x

61

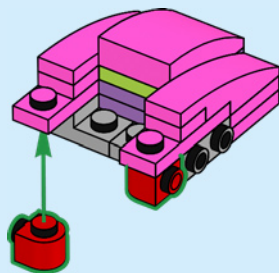

62

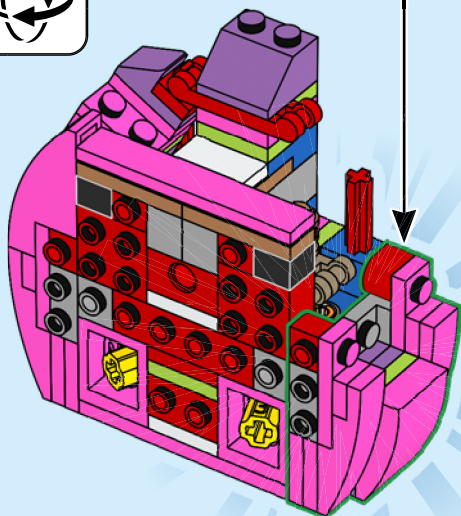

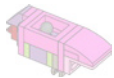

1x



1x

# 63

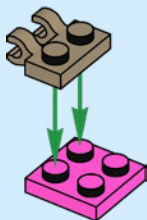

1x

# 64

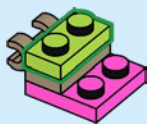



1x



1x



1x

# 65

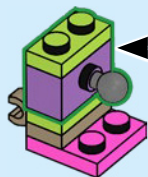
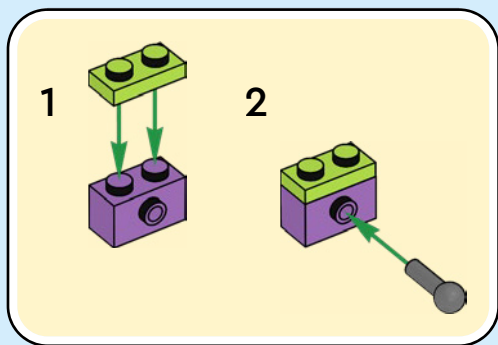

1x

# 66

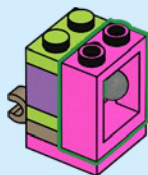



1x

67

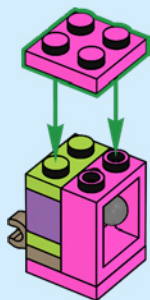

1x



1x



1x

68

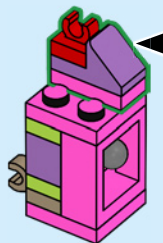

1



2



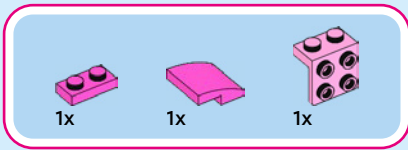

69

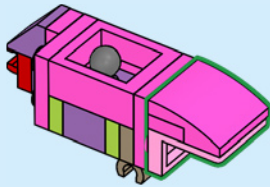
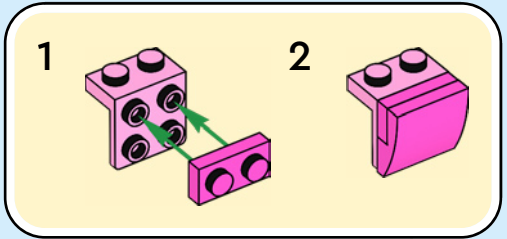

70

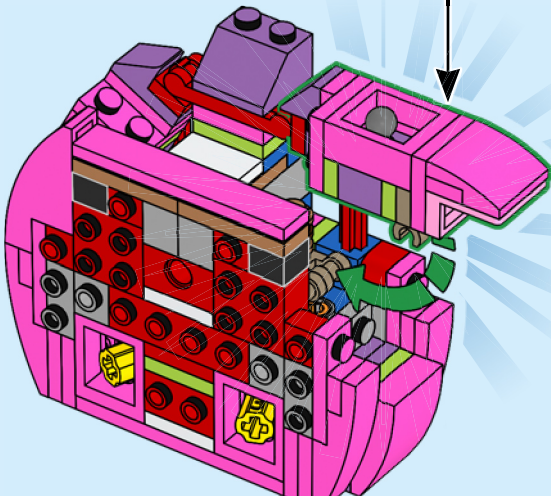



1x

71

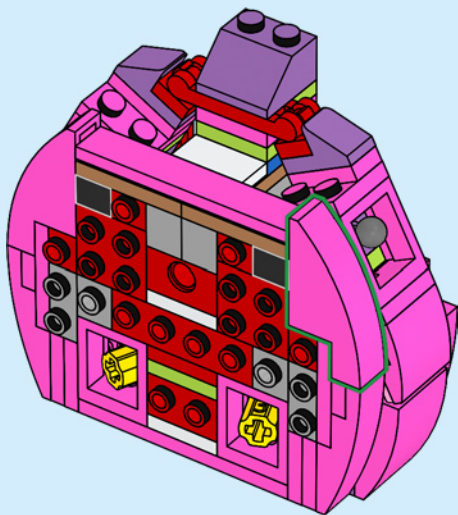

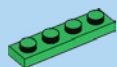

1x

72

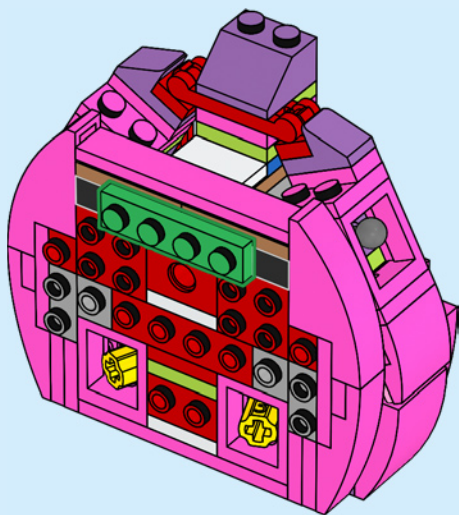



1x

73

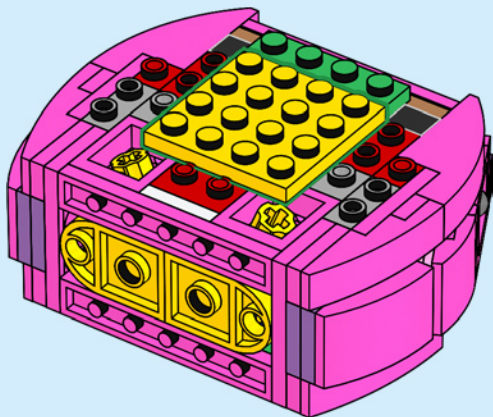



2x

74

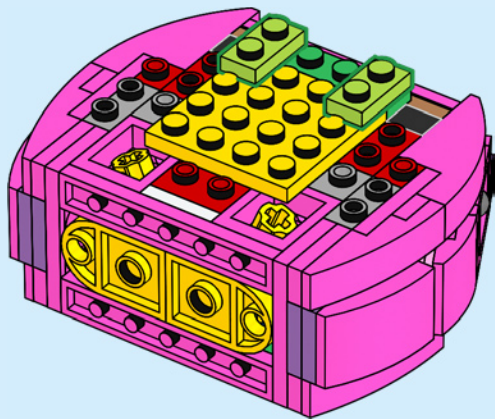



1x



1x

# 75

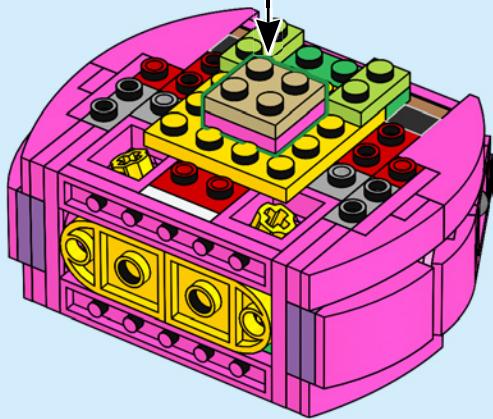
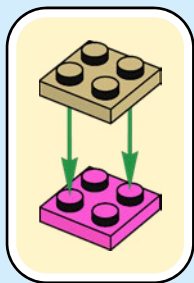

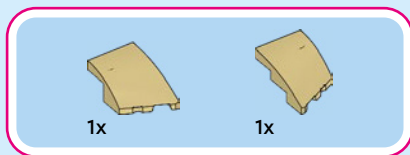

76

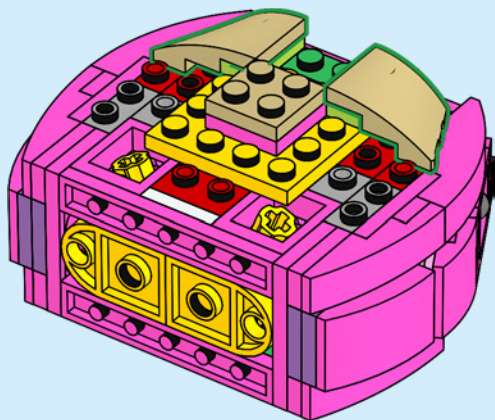



3x



2x

77

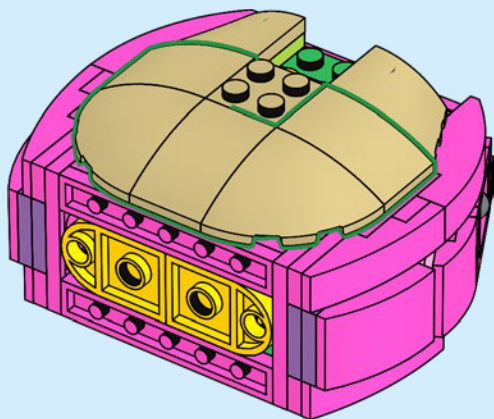

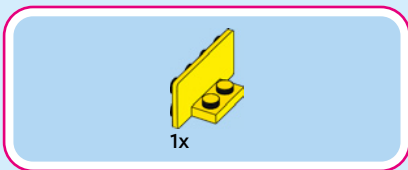
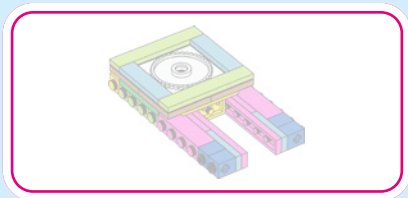

78

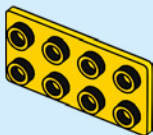



1x

# 79

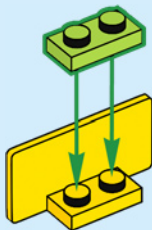
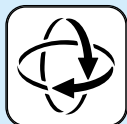

2x

# 80

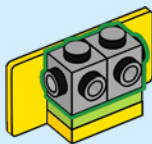



81

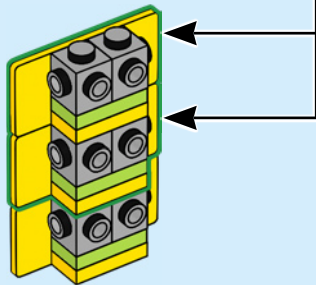
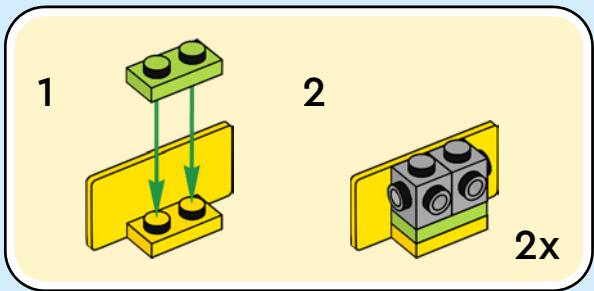

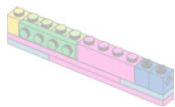

1x

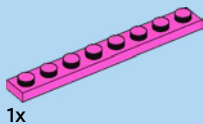

1x

# 82

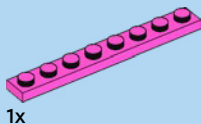
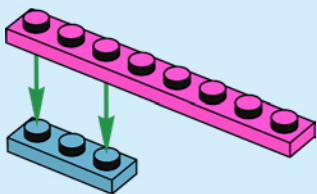

1x

# 83

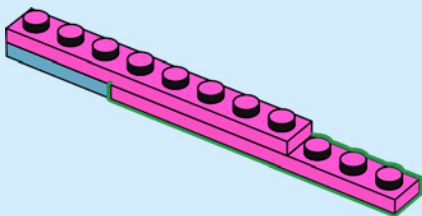



1x

# 84

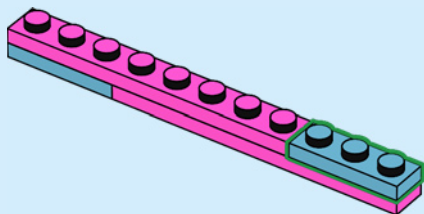

1x

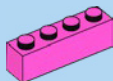

1x



4x

# 85

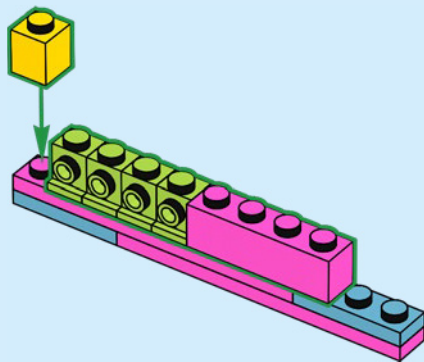



2x

# 86

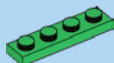
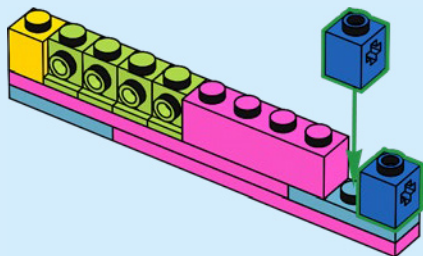

1x

# 87

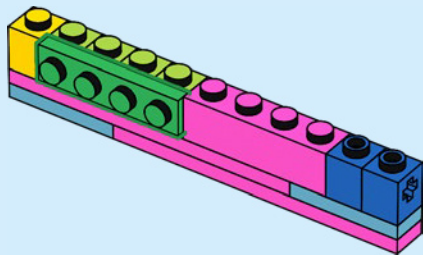

88

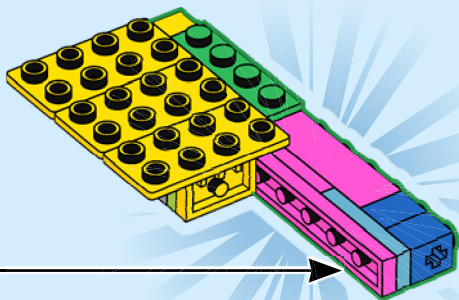

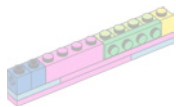

1x

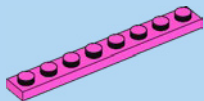

1x

# 89

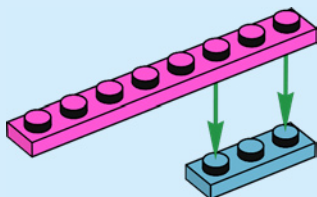

1x

# 90

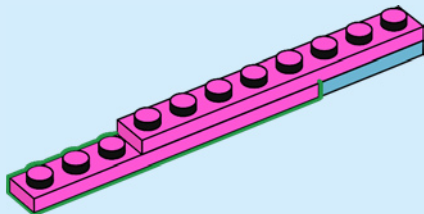



1x

91

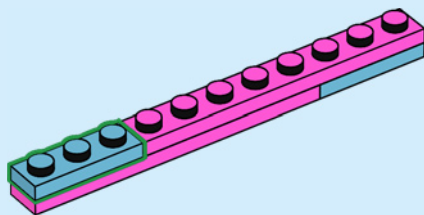

1x

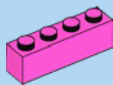

1x



4x

92

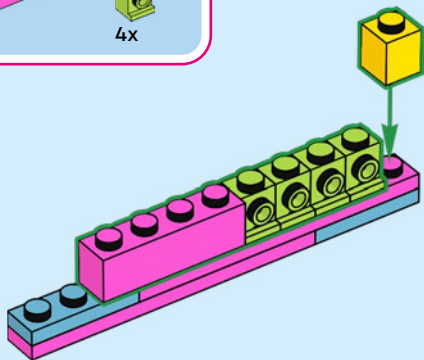



2x

# 93

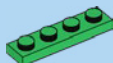
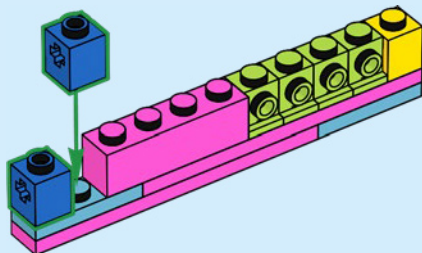

1x

# 94

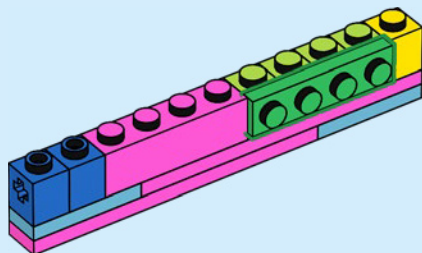

95

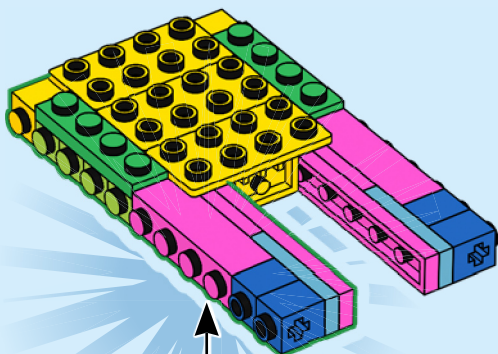



4x

96

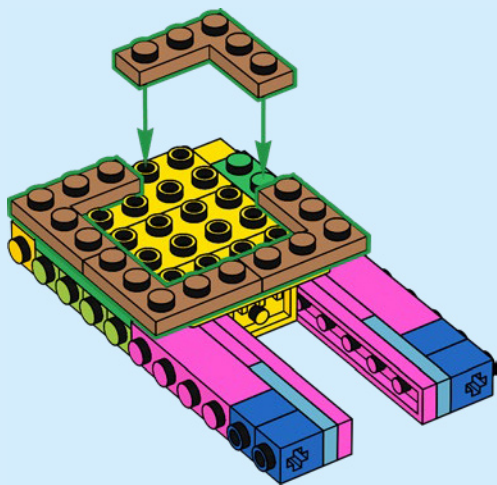

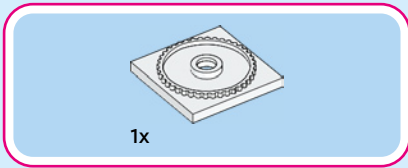

97

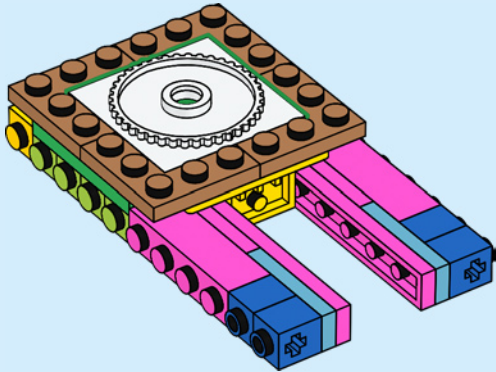

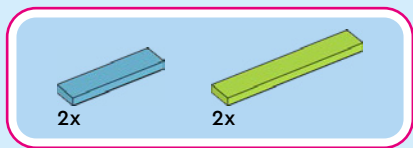

98

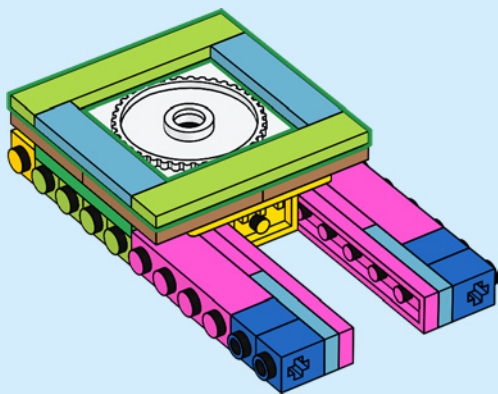

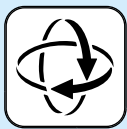

99

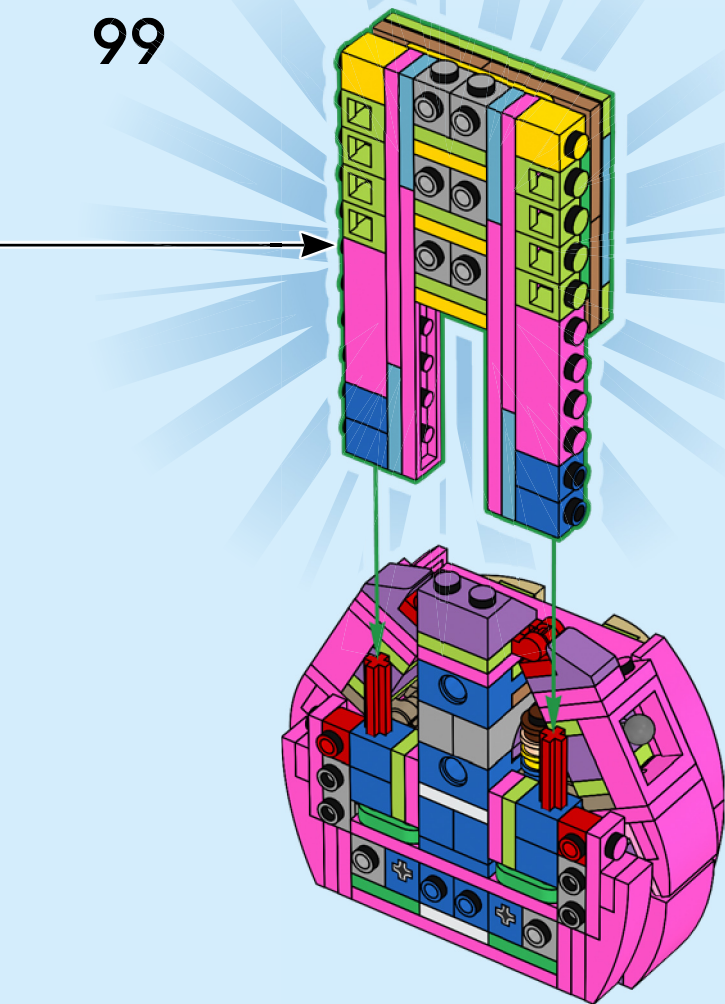



1x



2x

# 100

1

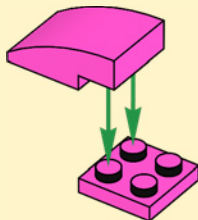

2

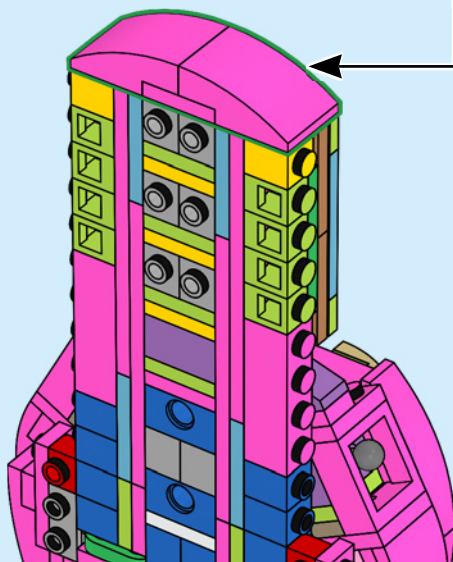
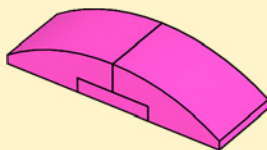

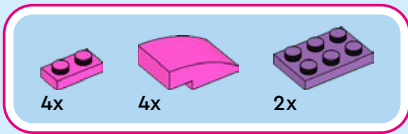

# 101

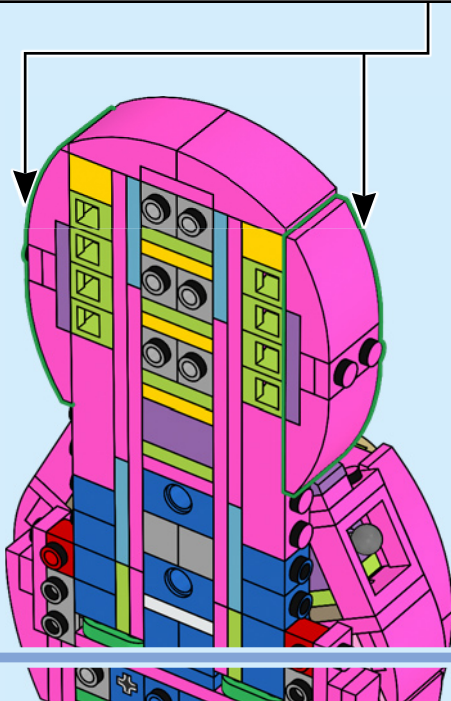
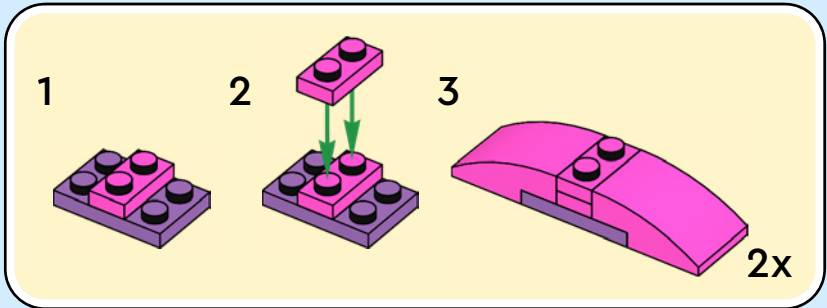



2x

102



2x

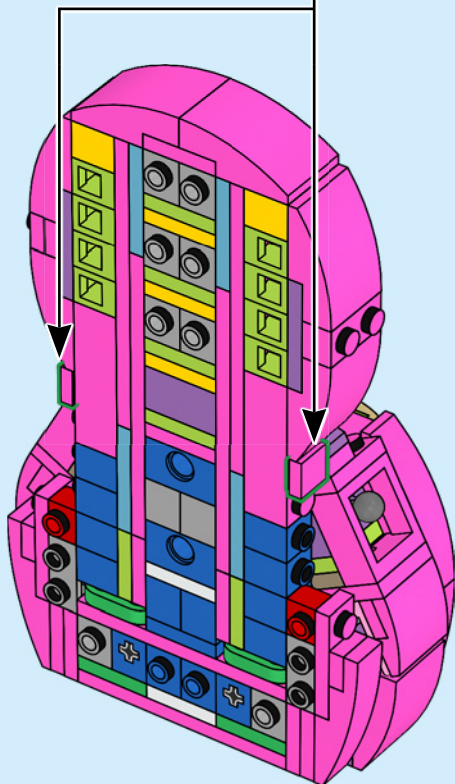

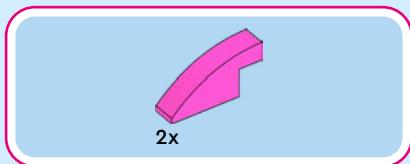

103

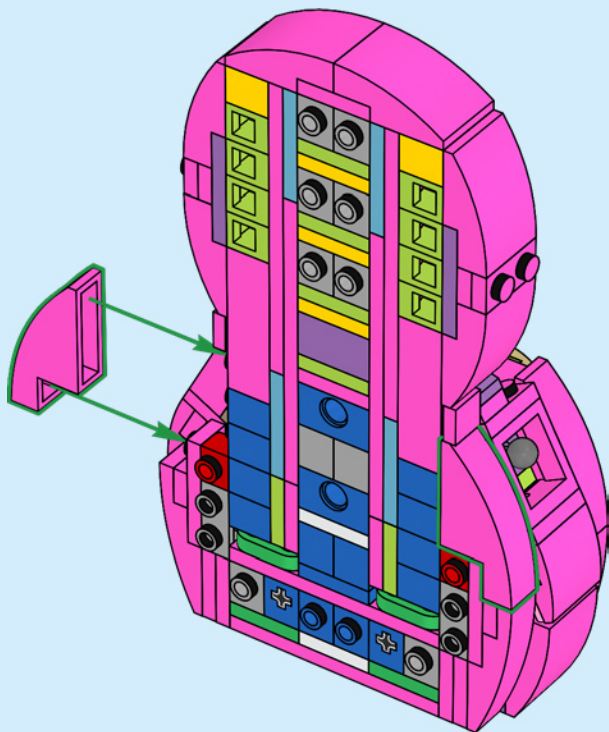



1x



1x

# 104

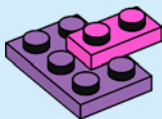

1x

# 105

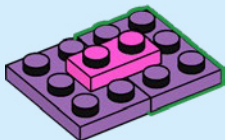



2x

# 106

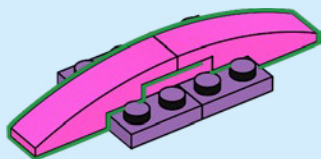

2x

# 107

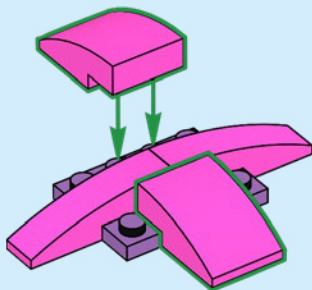

108

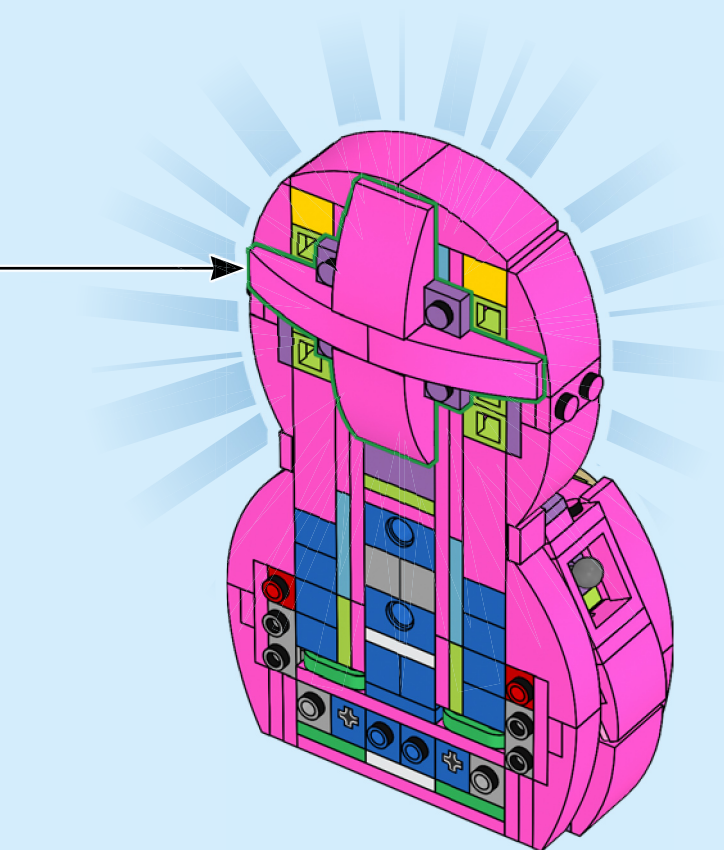

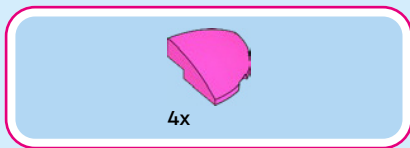

109

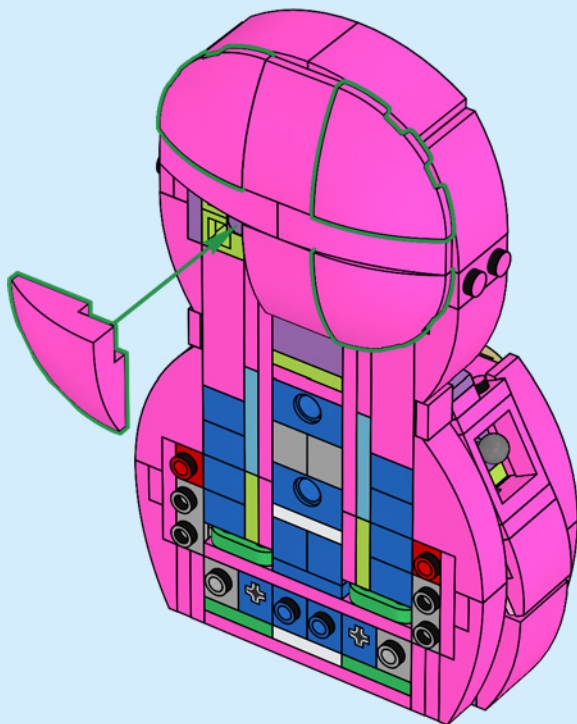

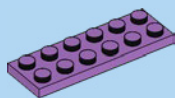

1x



1x

# 110

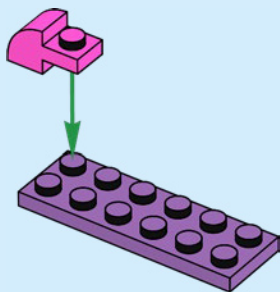

2x



1x



1x

# 111

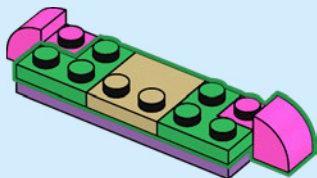

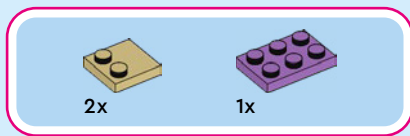

112

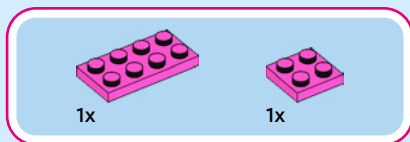
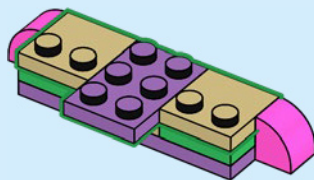

113

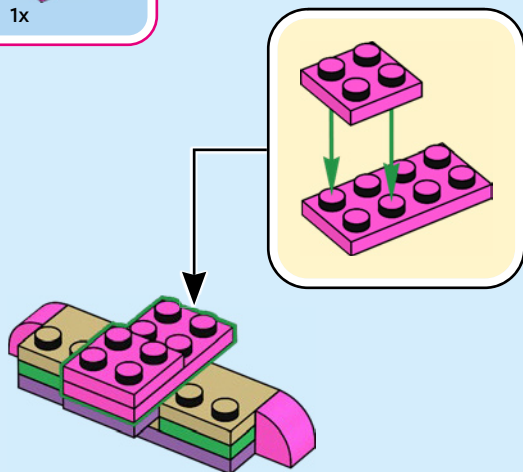

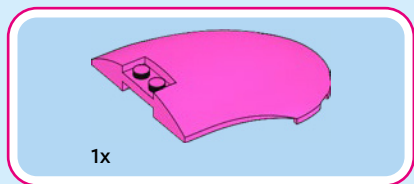

114

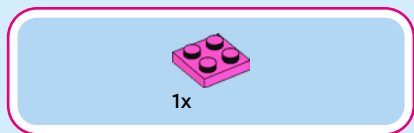
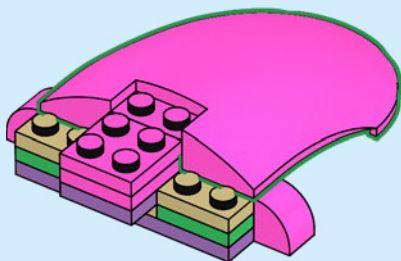

115

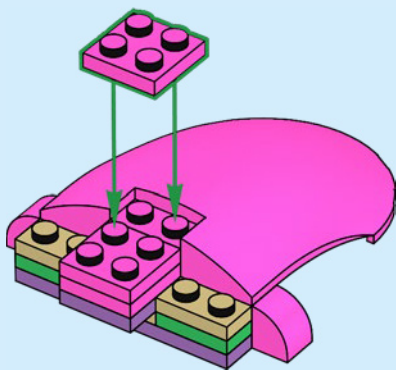

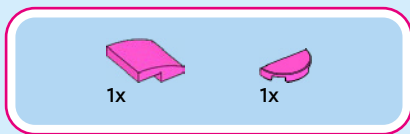

116

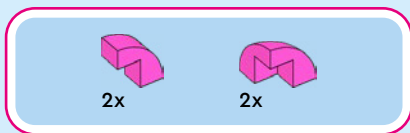
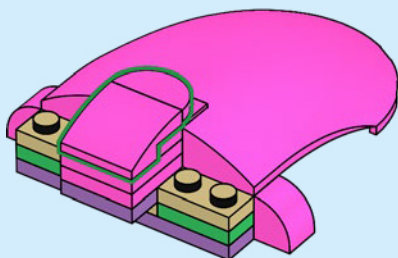

117

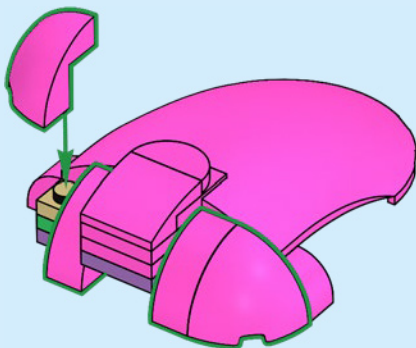

118

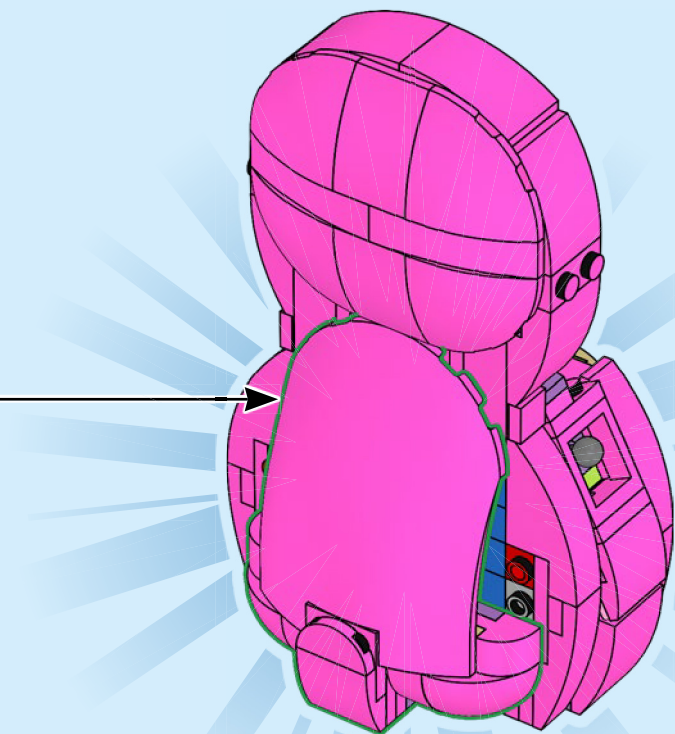

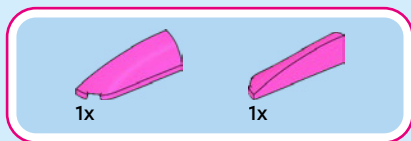

119

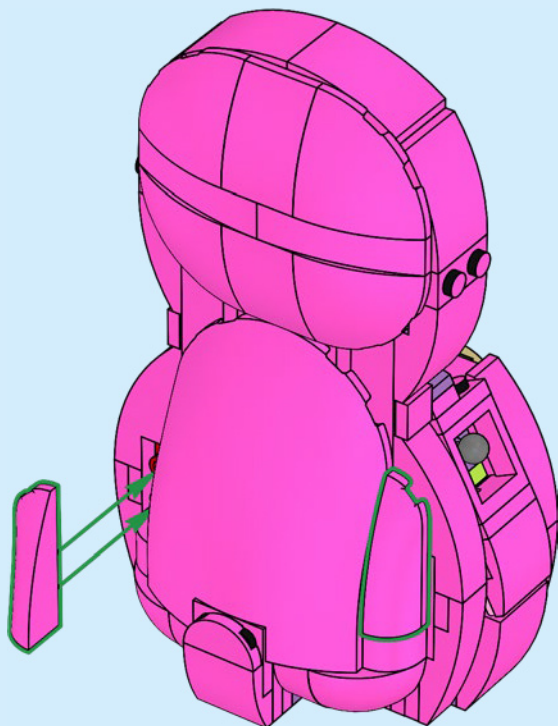

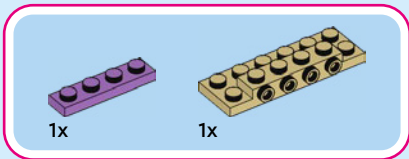
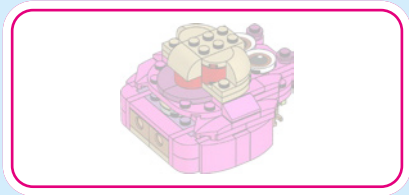

120

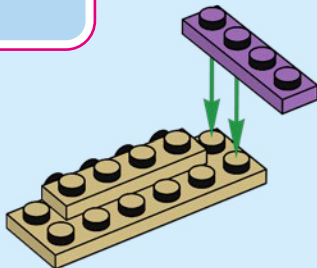

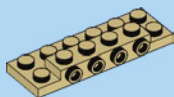

1x

# 121

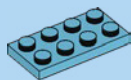
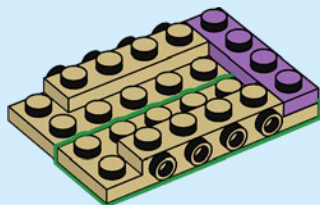

1x

# 122

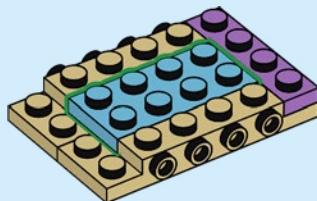



1x



4x

# 123

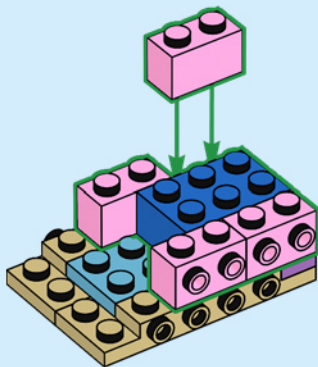

2x

# 124

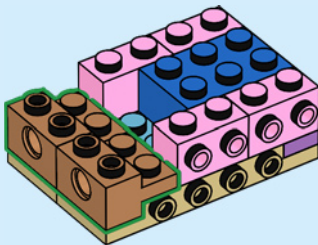



1x

# 125

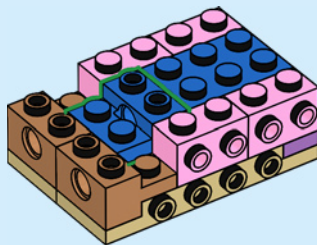

2x

# 126

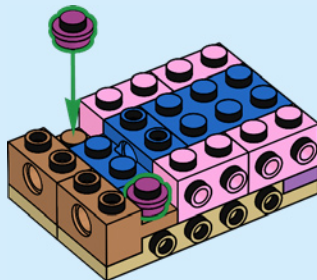



1x



1x

# 127

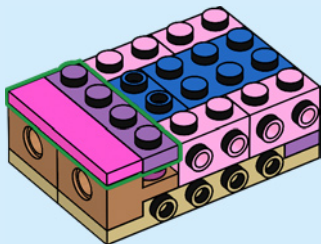

1x

# 128

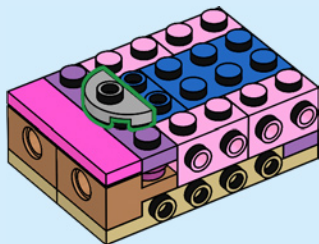



2x



1x



1x

129

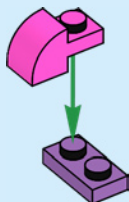

1x

130





1x

# 131

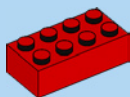
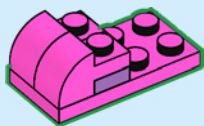

1x

# 132

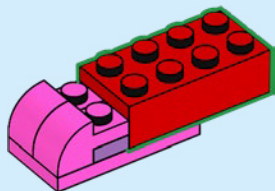



1x

# 133

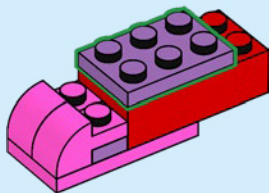

1x

# 134

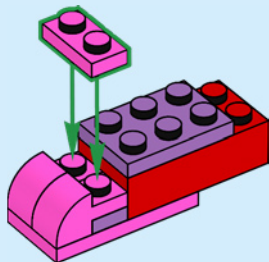



1x

# 135

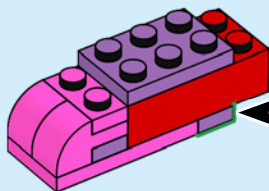

1x



2x

# 136

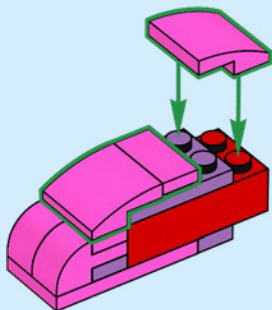

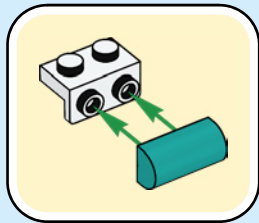
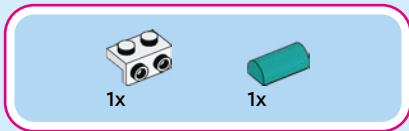

137

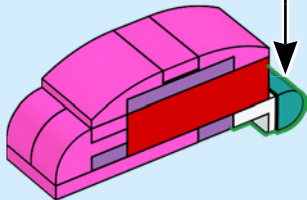

2x

138

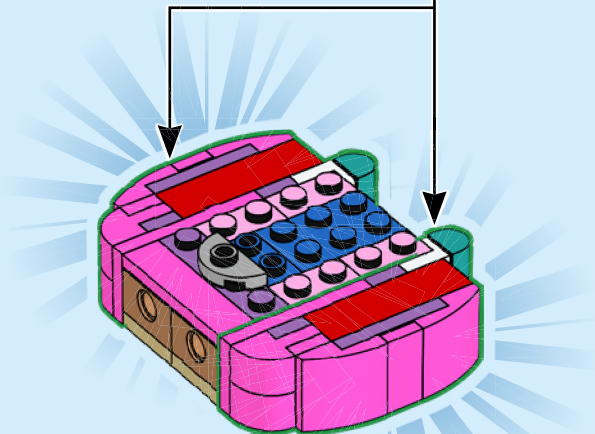



4x

139

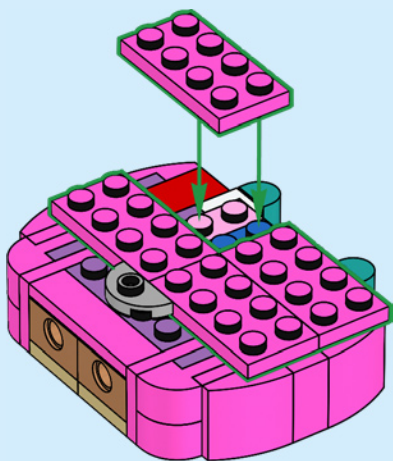



1x



1x

# 140

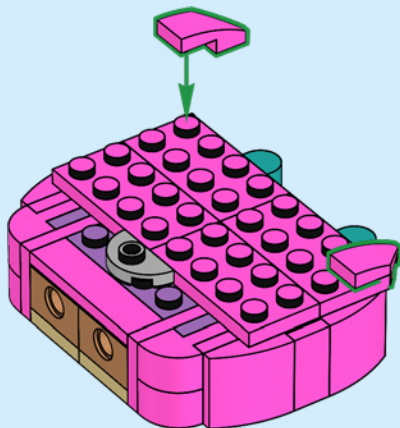

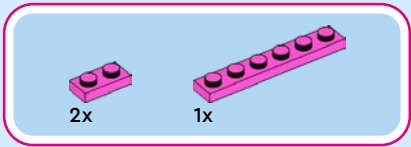

# 141

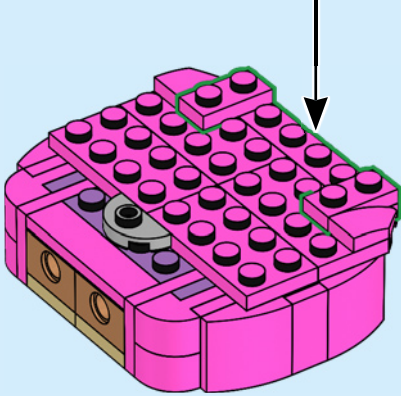
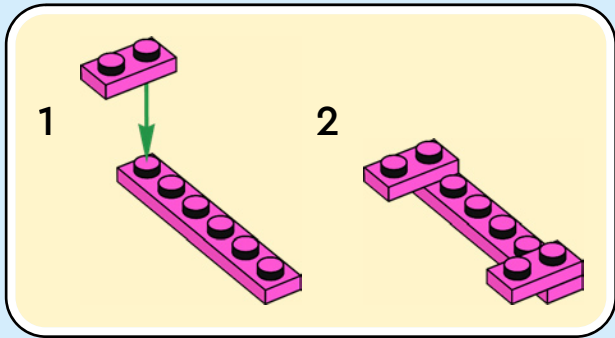

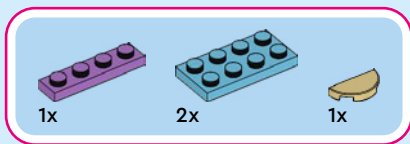

142

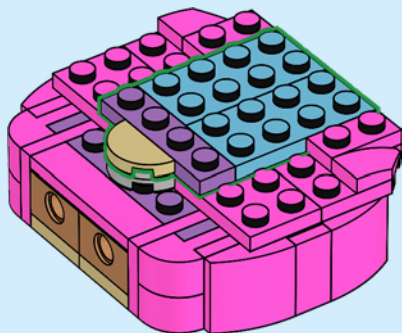



2x



2x



2x

# 143

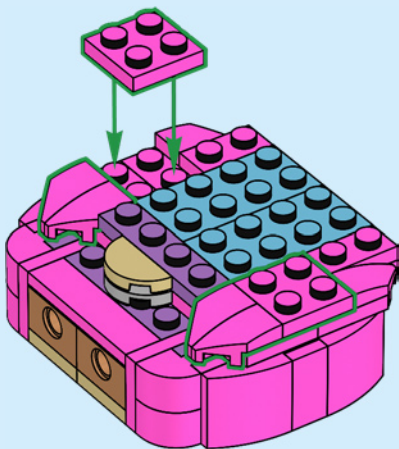



1x



2x

# 144

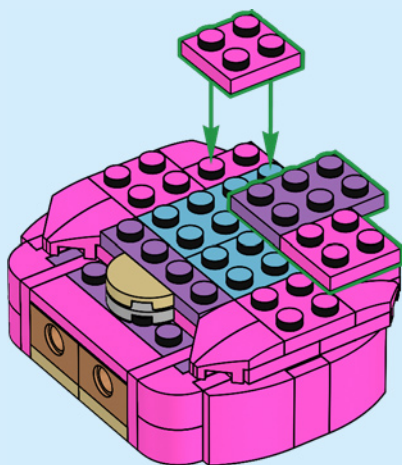

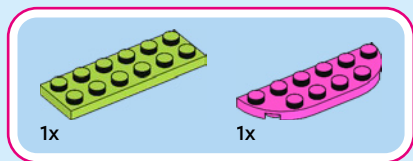

145

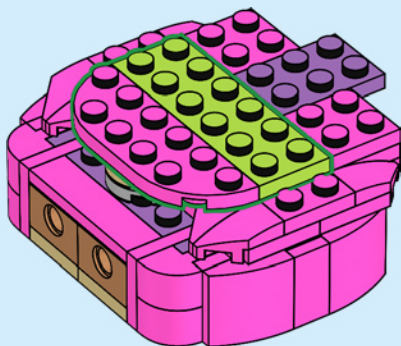

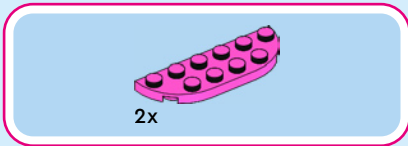

146

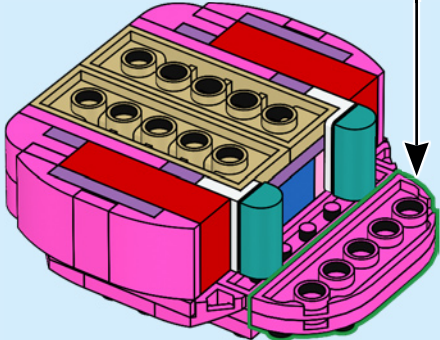
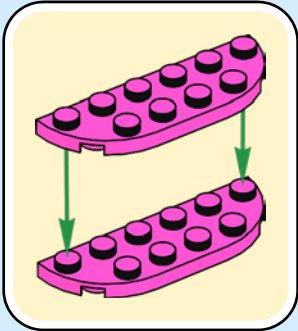



1x



1x

# 147

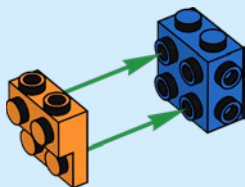

1x

# 148

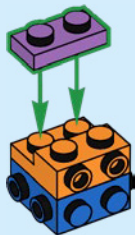
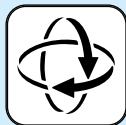



1x

149



2x

150





2x



2x

# 151

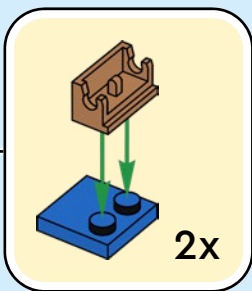
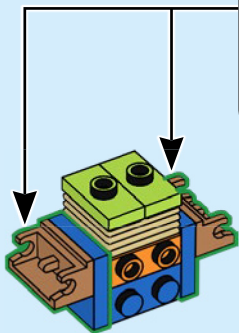

# 152

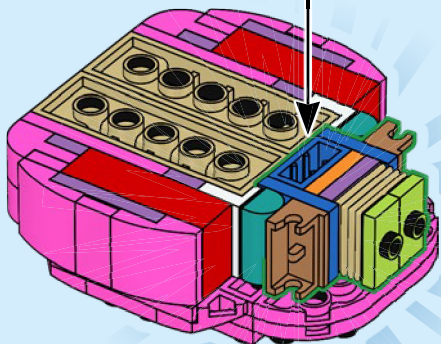



1x

153

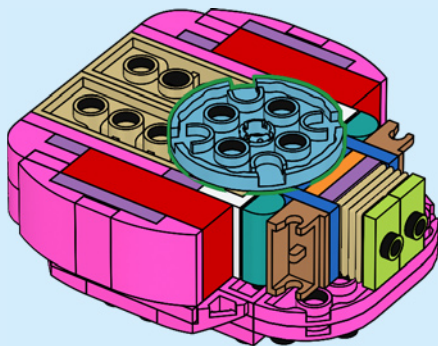



1x

# 154

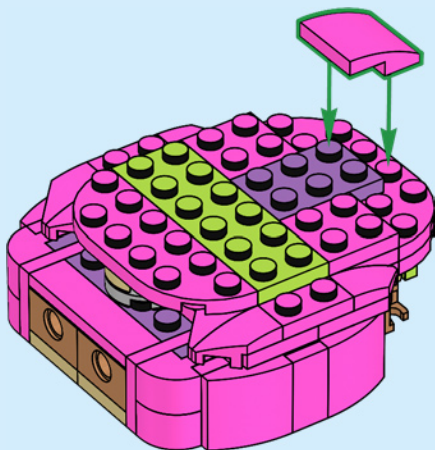

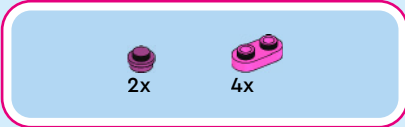

# 155

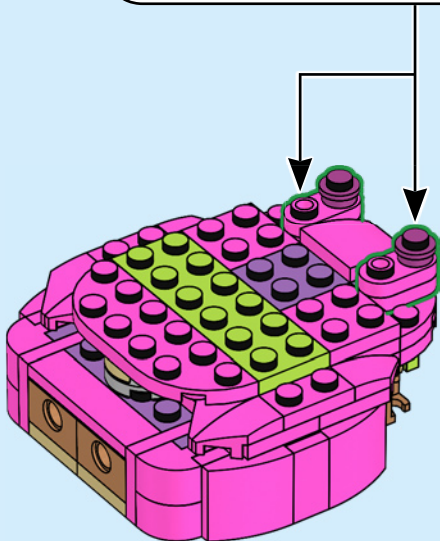
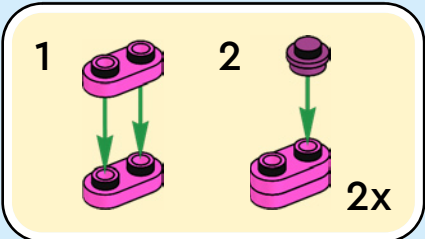

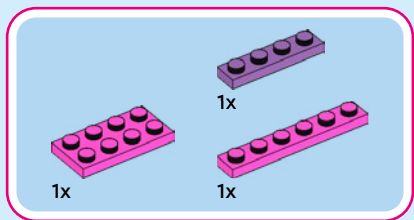

# 156

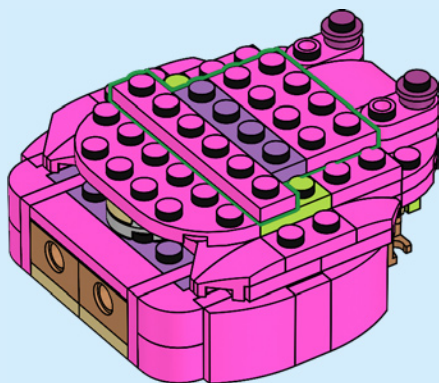



2x



1x



1x

# 157

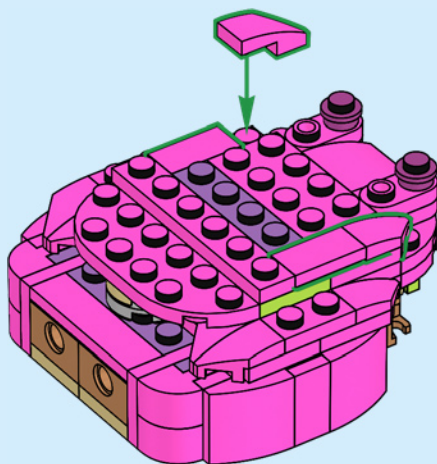



2x

# 158

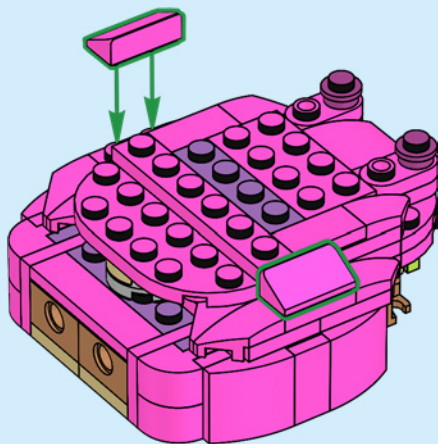



2x



1x

# 159

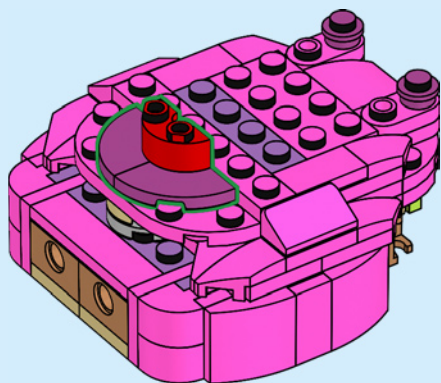



2x

160

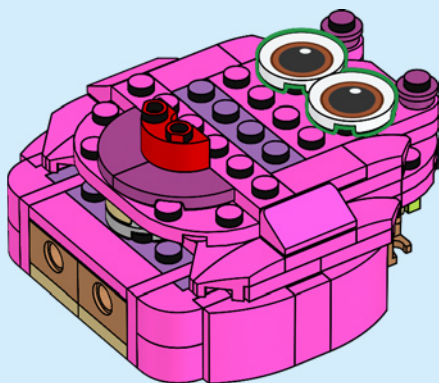



2x

161

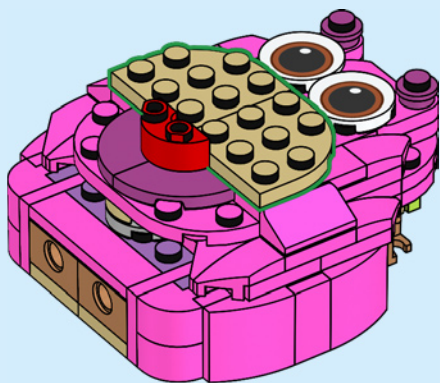



2x



1x

# 162

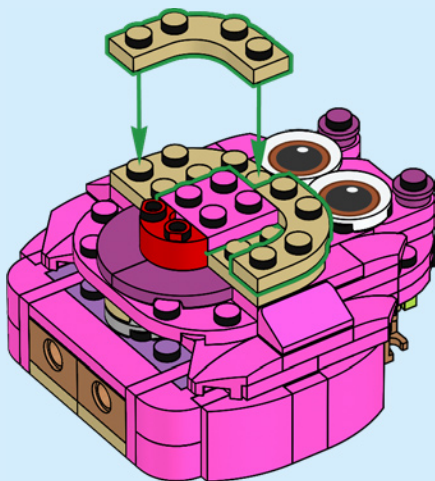



2x

# 163

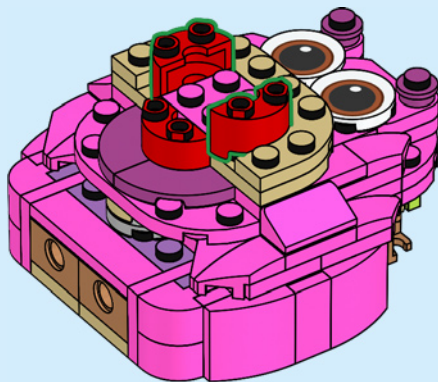



1x



1x

# 164

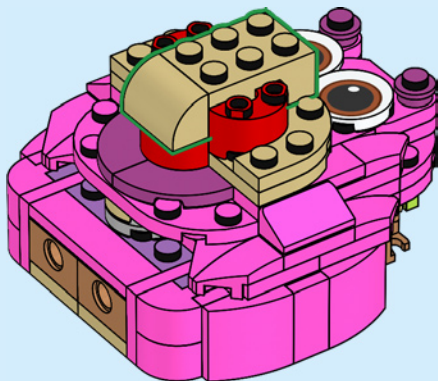



2x

# 165

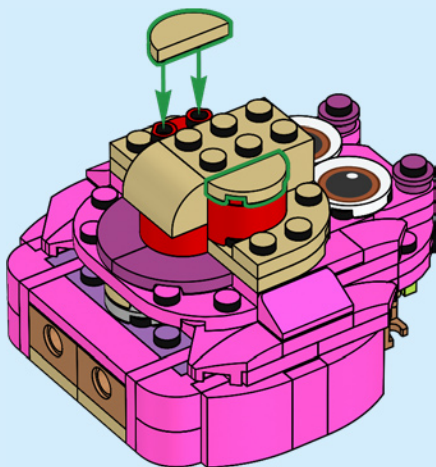



2x

166

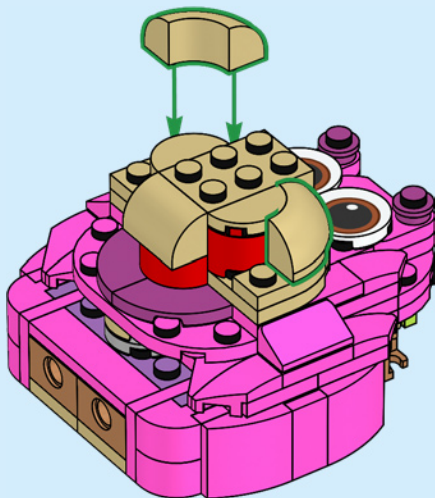

167

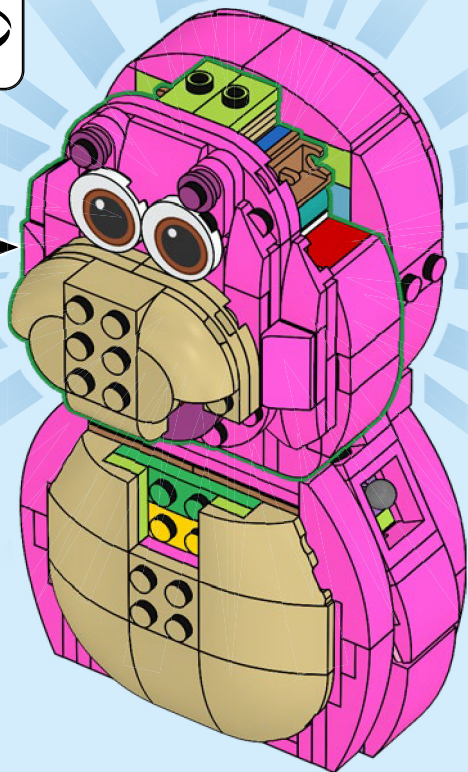

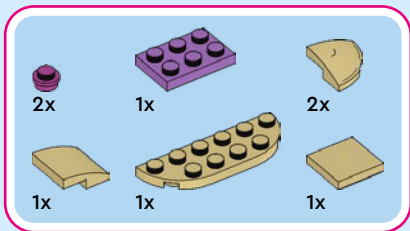

168

1

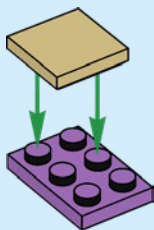

2

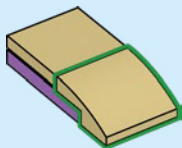

3

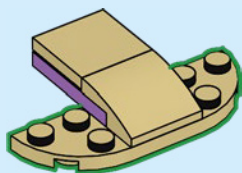

4

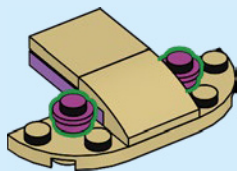

5

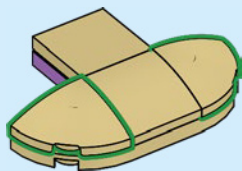

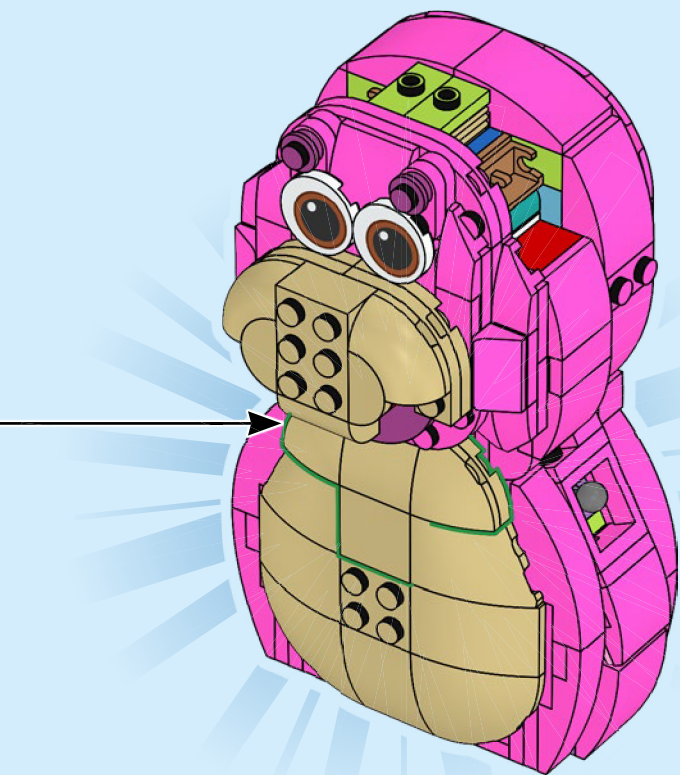



2x

169

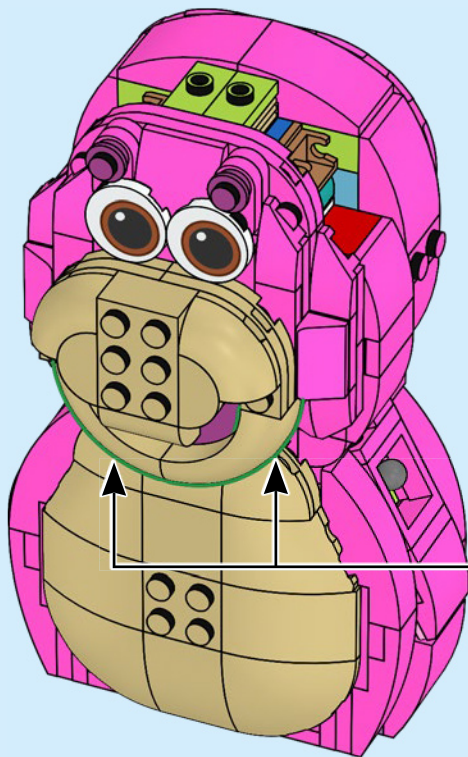

2x





2x

170

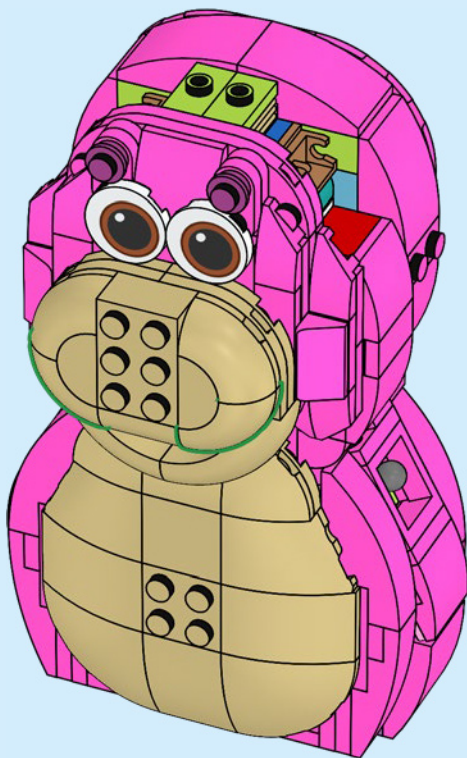





1x

171

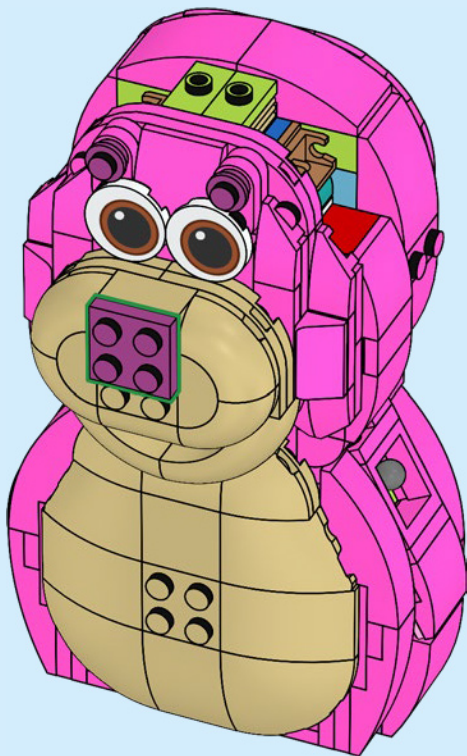



2x



1x



1x

# 172

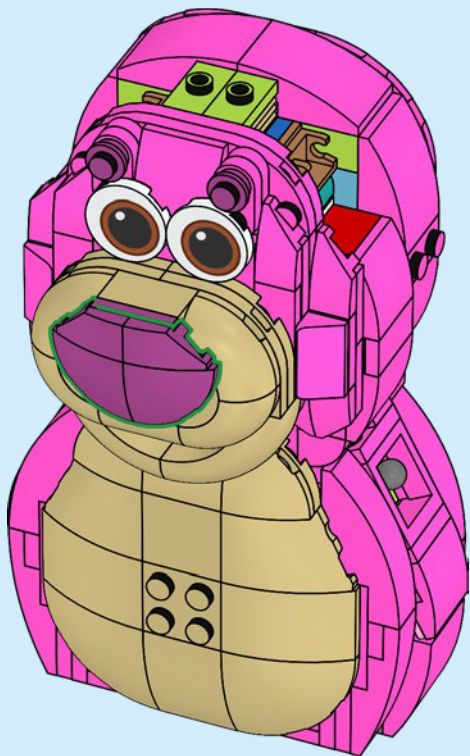



2x

173

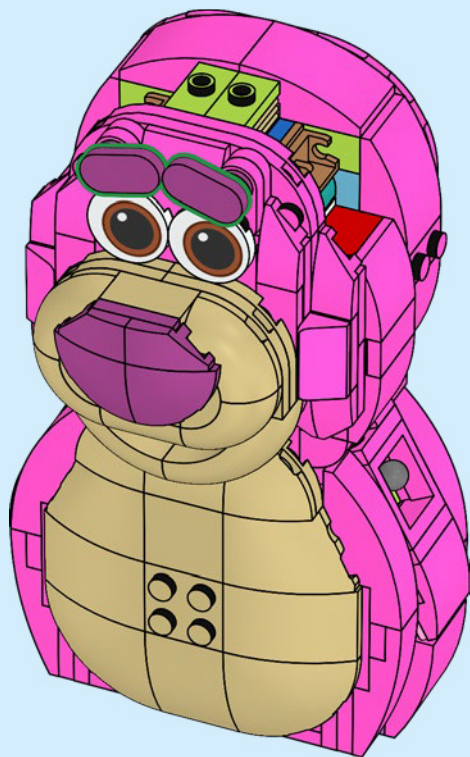



1x

174

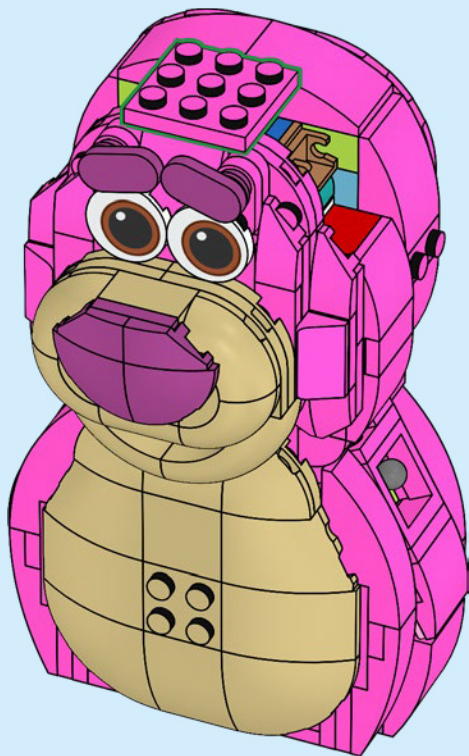



2x



1x



1x

175

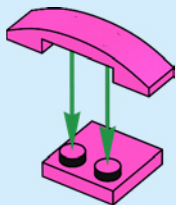

2x

176

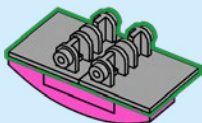



177

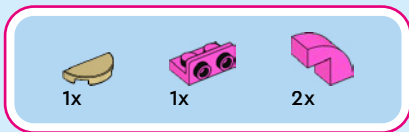
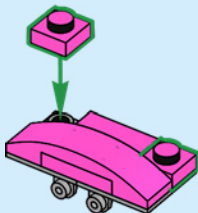

178

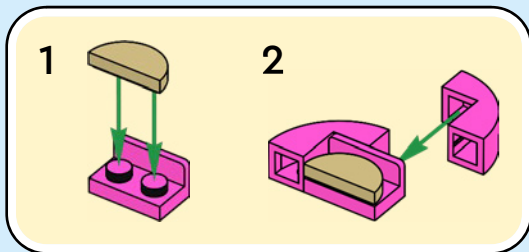

2x



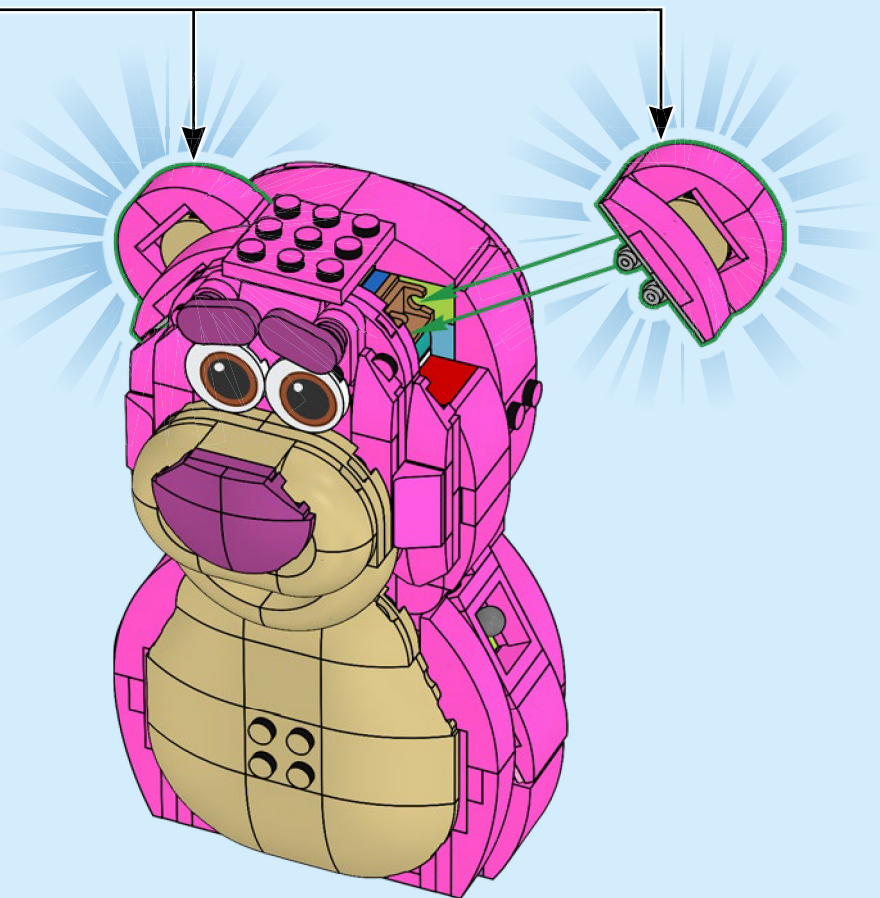

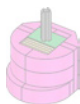

2x



1x



1x

180

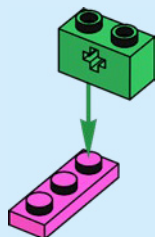

1x

181

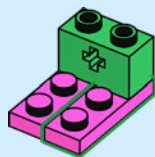



1x

# 182

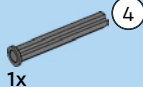
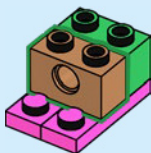

1x

# 183

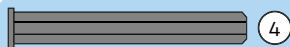
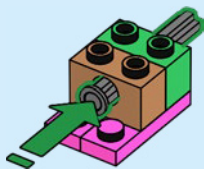

1:1

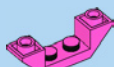

3x

# 184

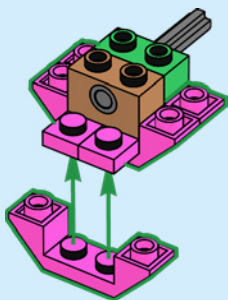

2x

# 185

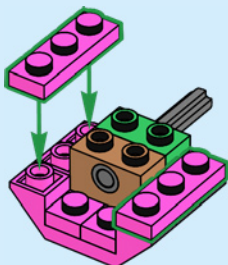



1x

# 186

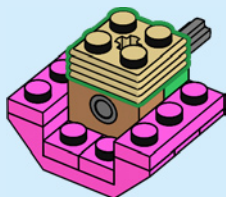

1x

# 187

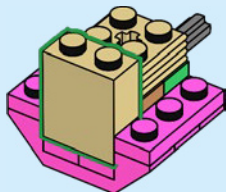



4x

188

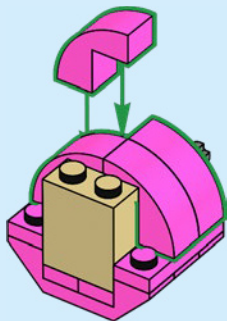

2x

189



2x

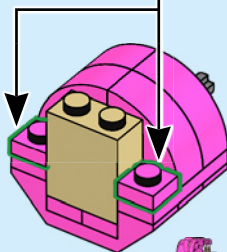



2x

190

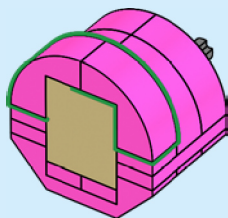

2x

191

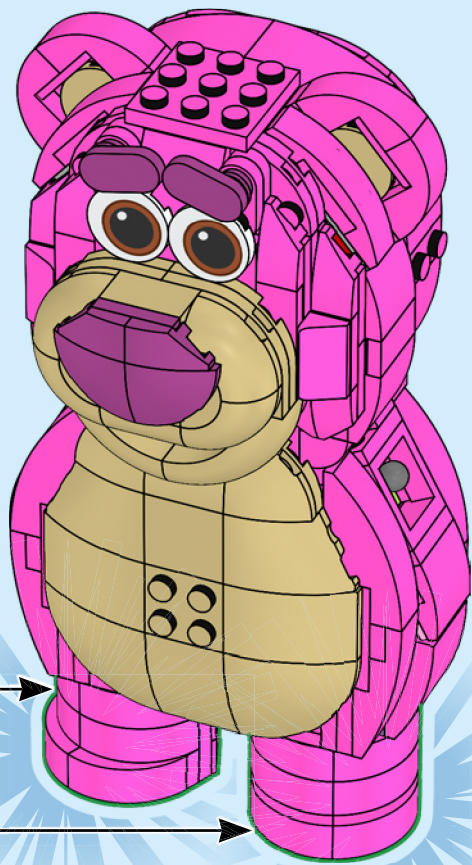

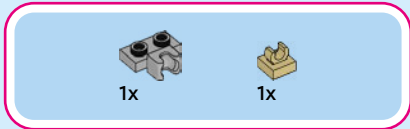
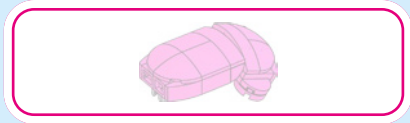

192

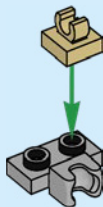



1x

# 193

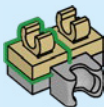

2x

# 194

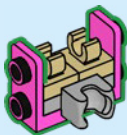

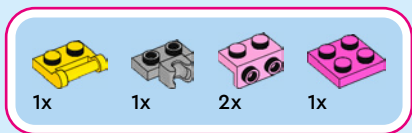

# 195

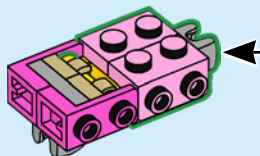
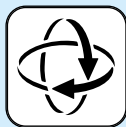
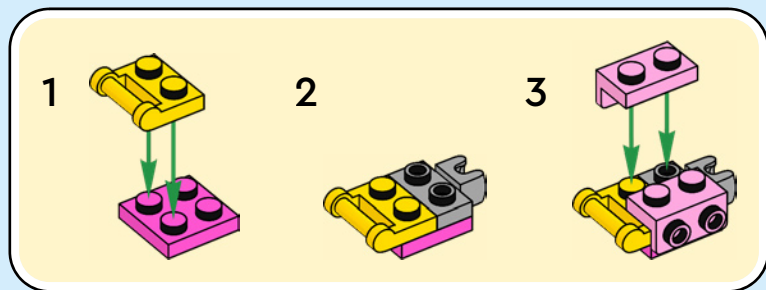

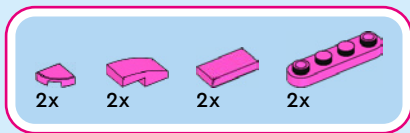

196

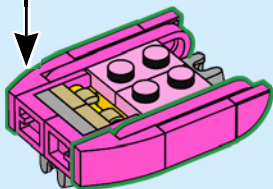
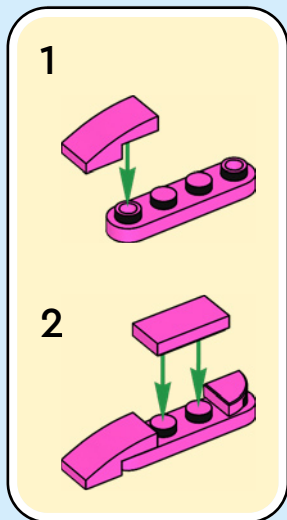
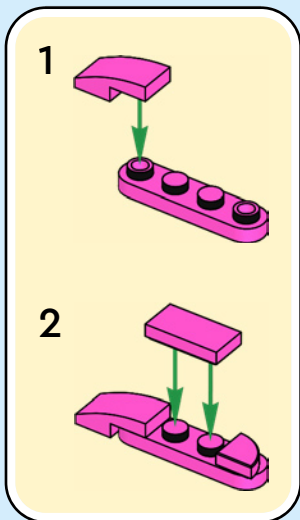



1x

# 197

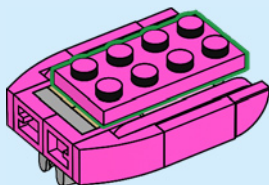

2x



1x



2x

# 198

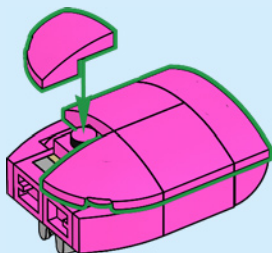



1x



1x

# 199

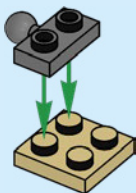

1x

# 200





1x



1x

# 201

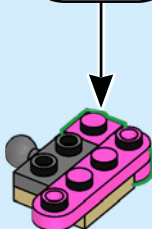
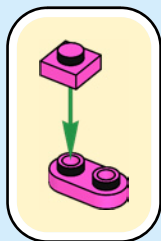

1x



1x



1x

# 202

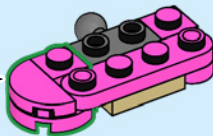
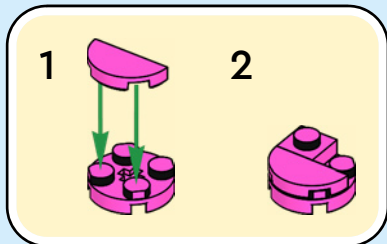



1x

# 203

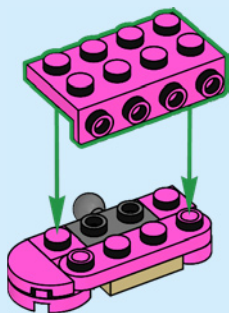



1x



1x

# 204

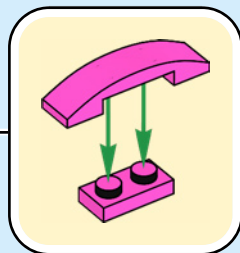
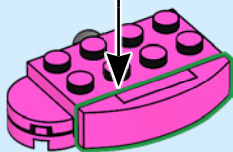

1x

# 205

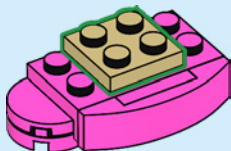

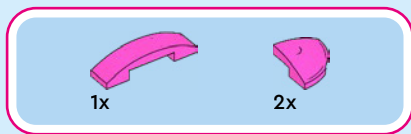

206

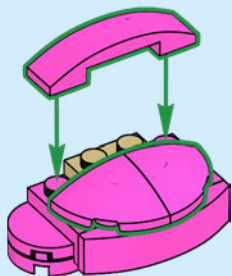

207

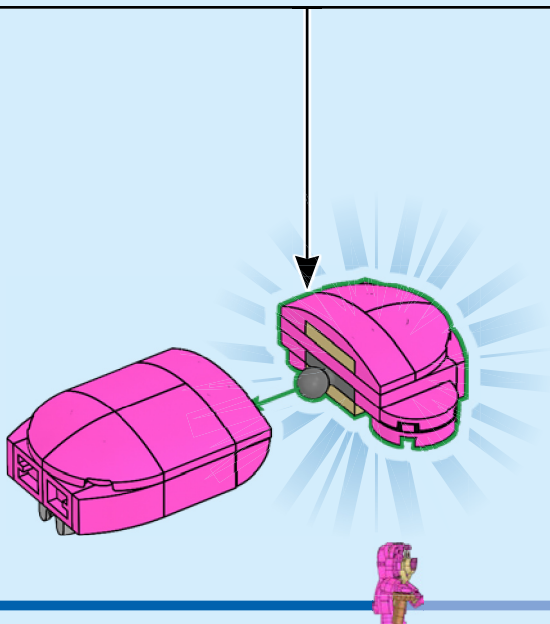

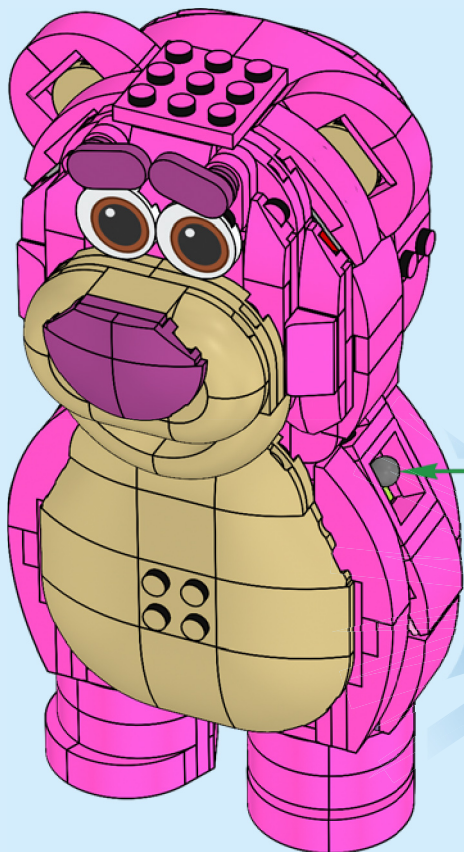



1x



1x

# 209

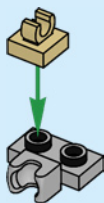

1x

# 210

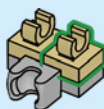



2x

# 211

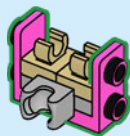

1x



1x



2x



1x

# 212

1

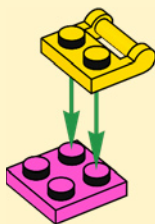

2



3

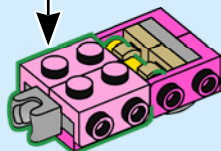
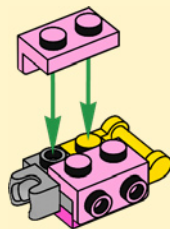

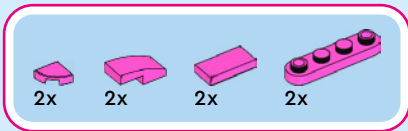

# 213

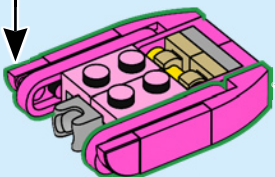
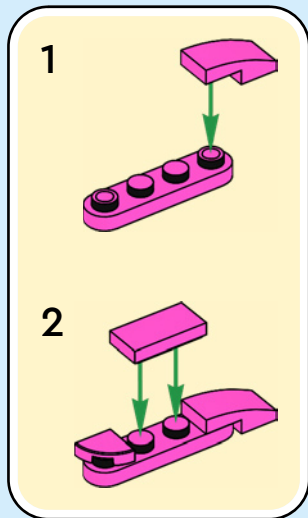
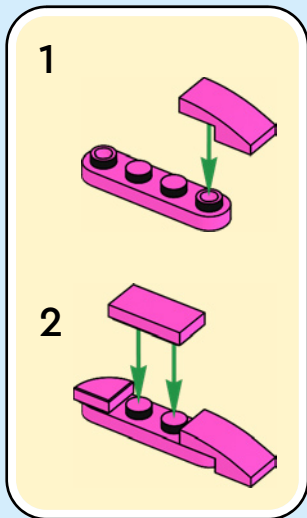



1x

# 214

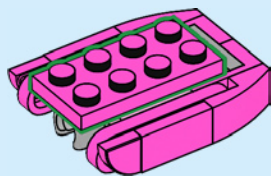

2x



1x



2x

# 215

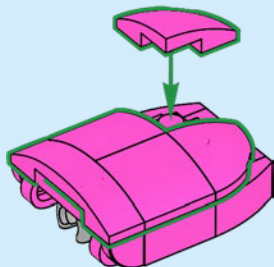



1x



1x

# 216

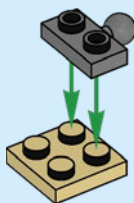

1x

# 217

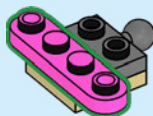



# 218

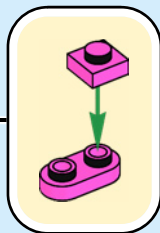
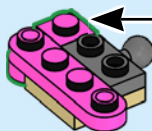

# 219

1



2



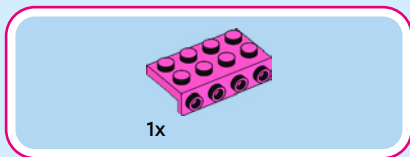

# 220

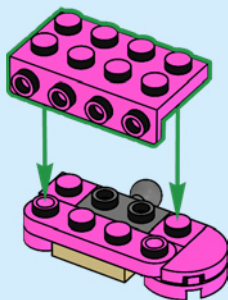



1x



1x

# 221

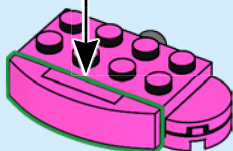
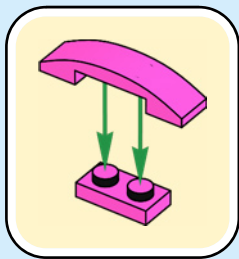

1x

# 222

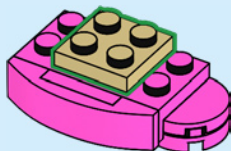

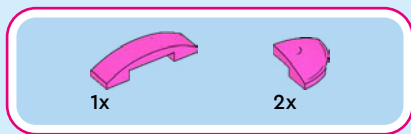

223

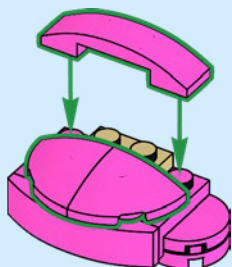

224



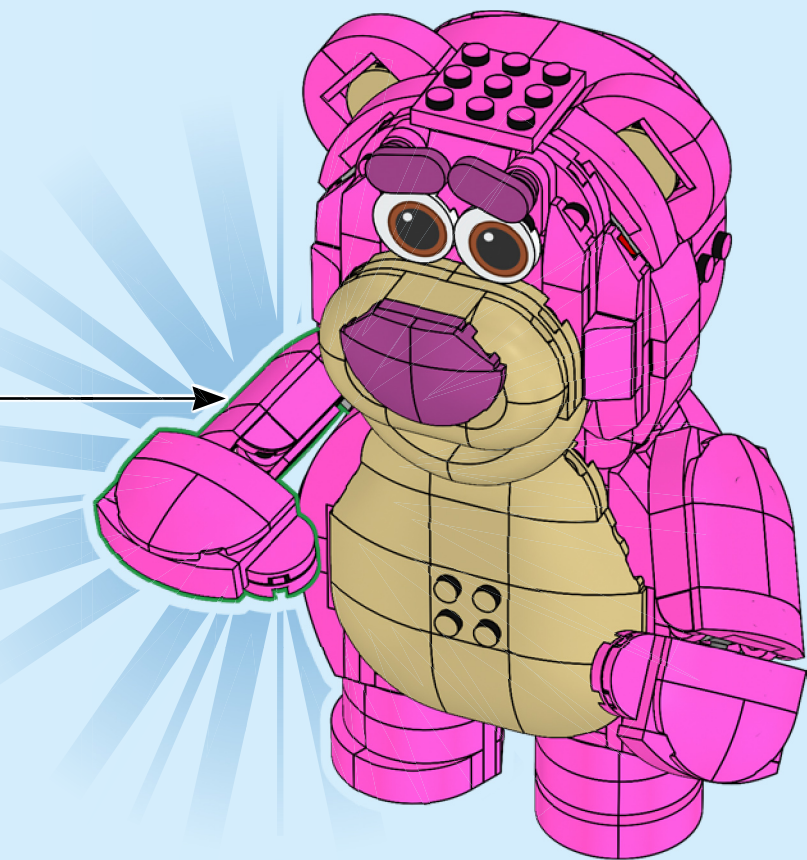

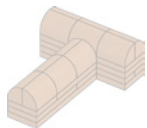

2x



1x

# 226

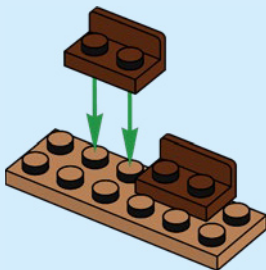

2x

# 227

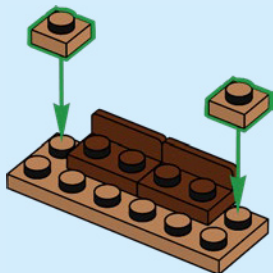



2x

# 228

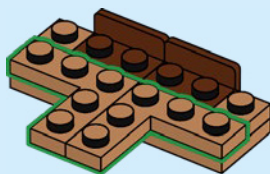

1x

# 229

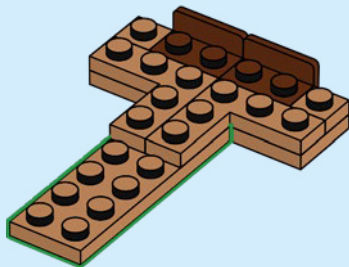

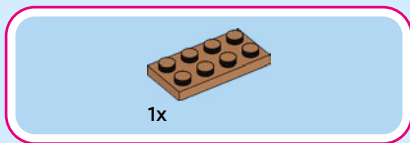

230

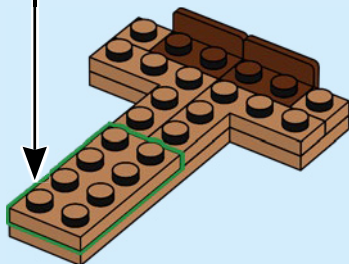
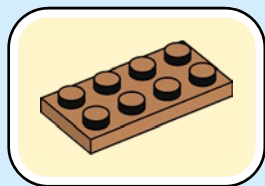

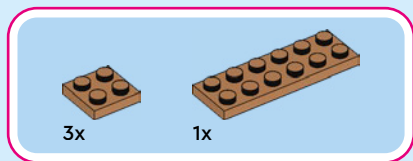

231

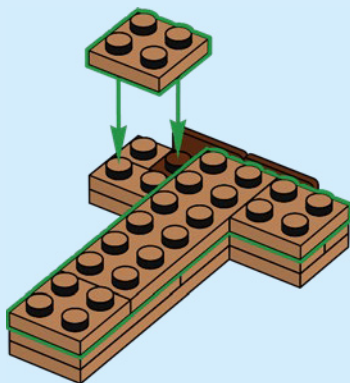

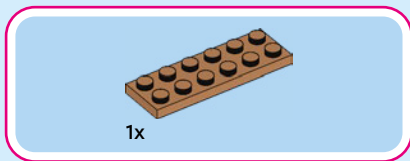

232

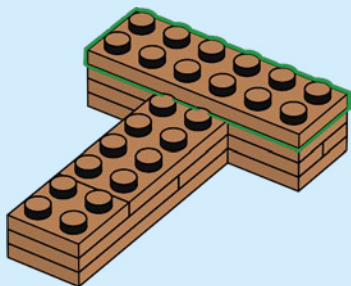



12x

# 233

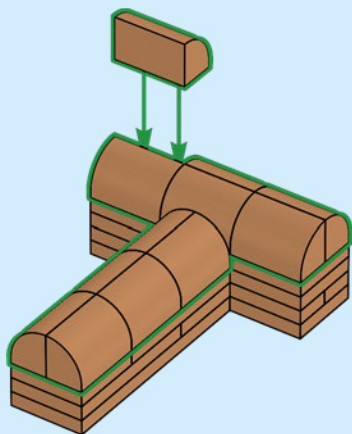

234

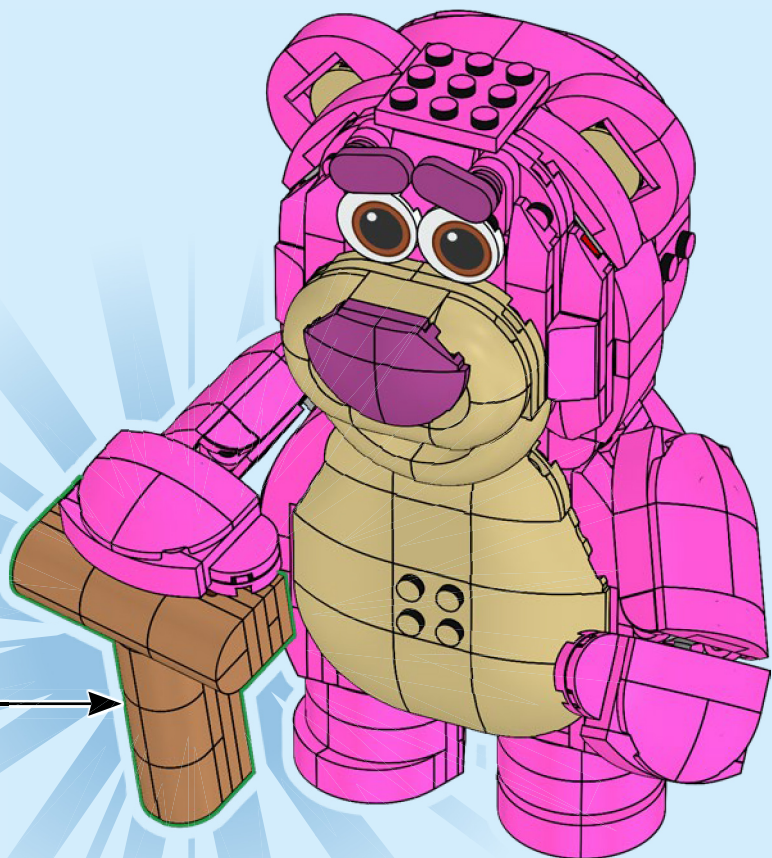





1

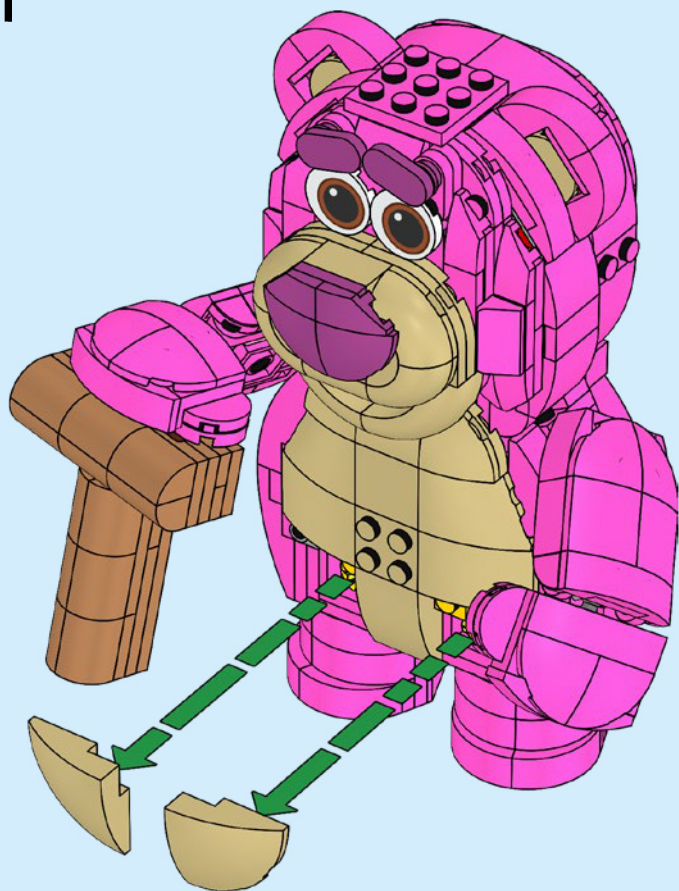

2

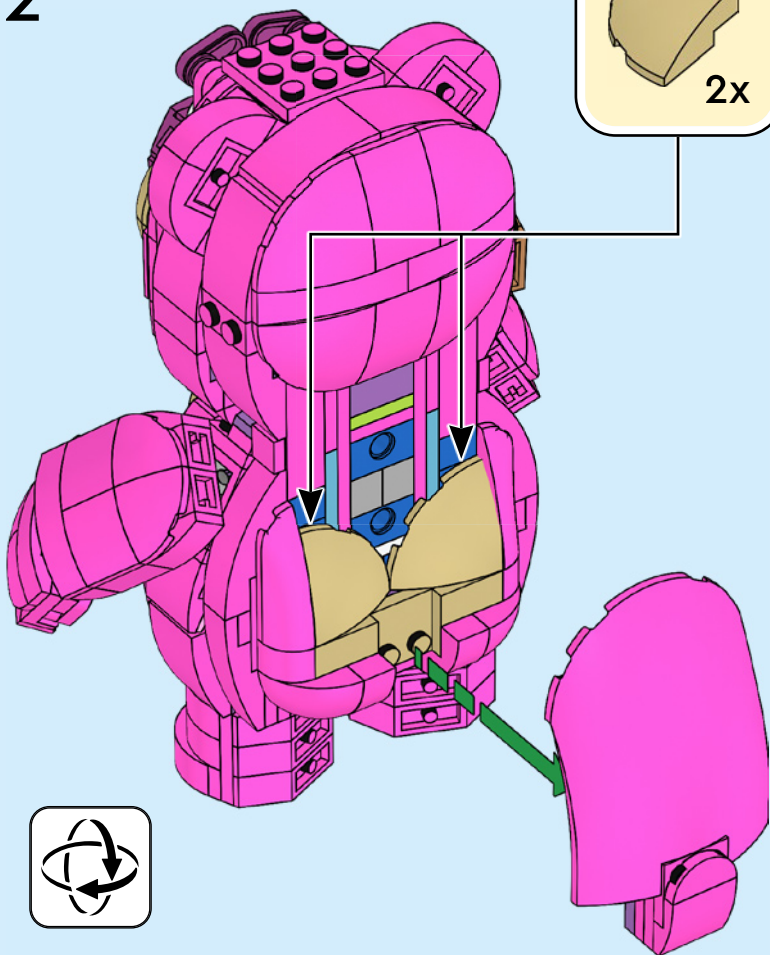
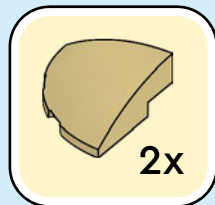

3

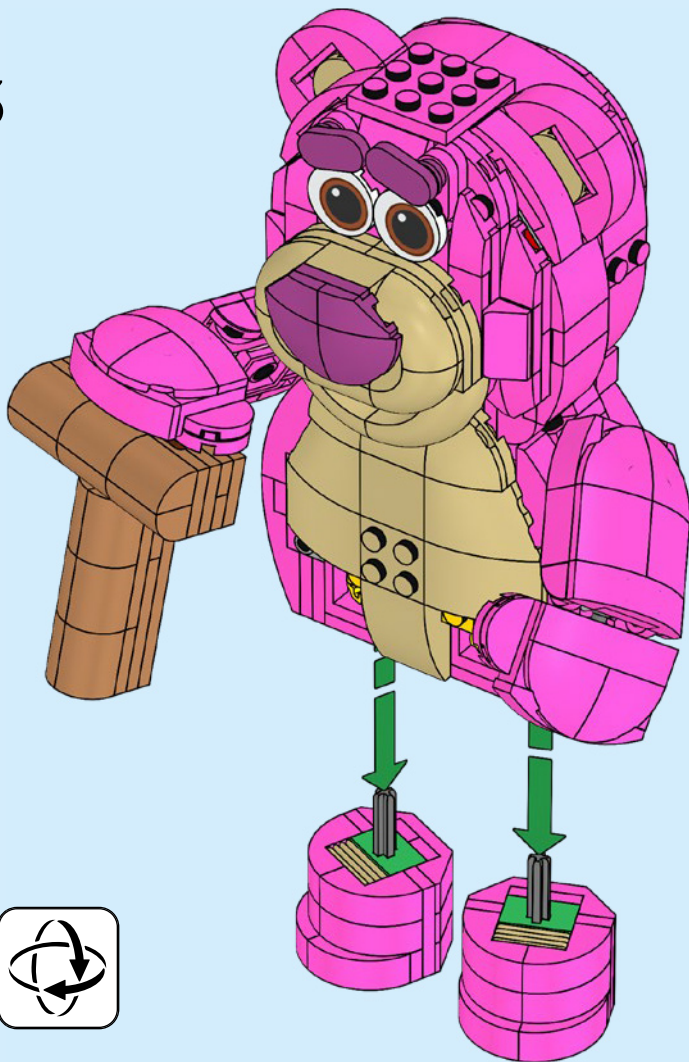

4

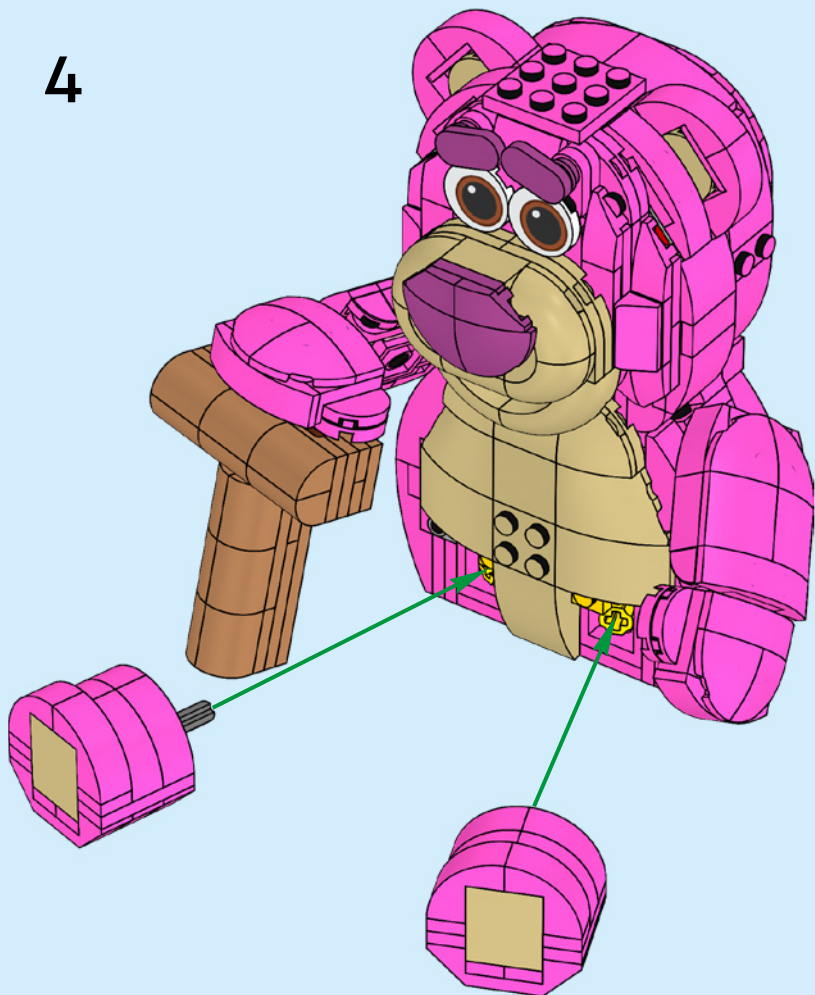

5





**LEGO**

Disney

Disney  
**Winnie  
the Pooh**

43305



Disney  
TIM BURTON'S  
**THE  
NIGHTMARE  
BEFORE  
CHRISTMAS**

43288



Disney · PIXAR

**UP**

43290



Disney · PIXAR  
**TOY  
STORY**

43307



© Disney

© Disney/Pixar

© Disney. Winnie the Pooh elements are based on the "Winnie the pooh" works by A.A. Milne and E.H. Shepard.

[LEGO.com/disney](http://LEGO.com/disney)

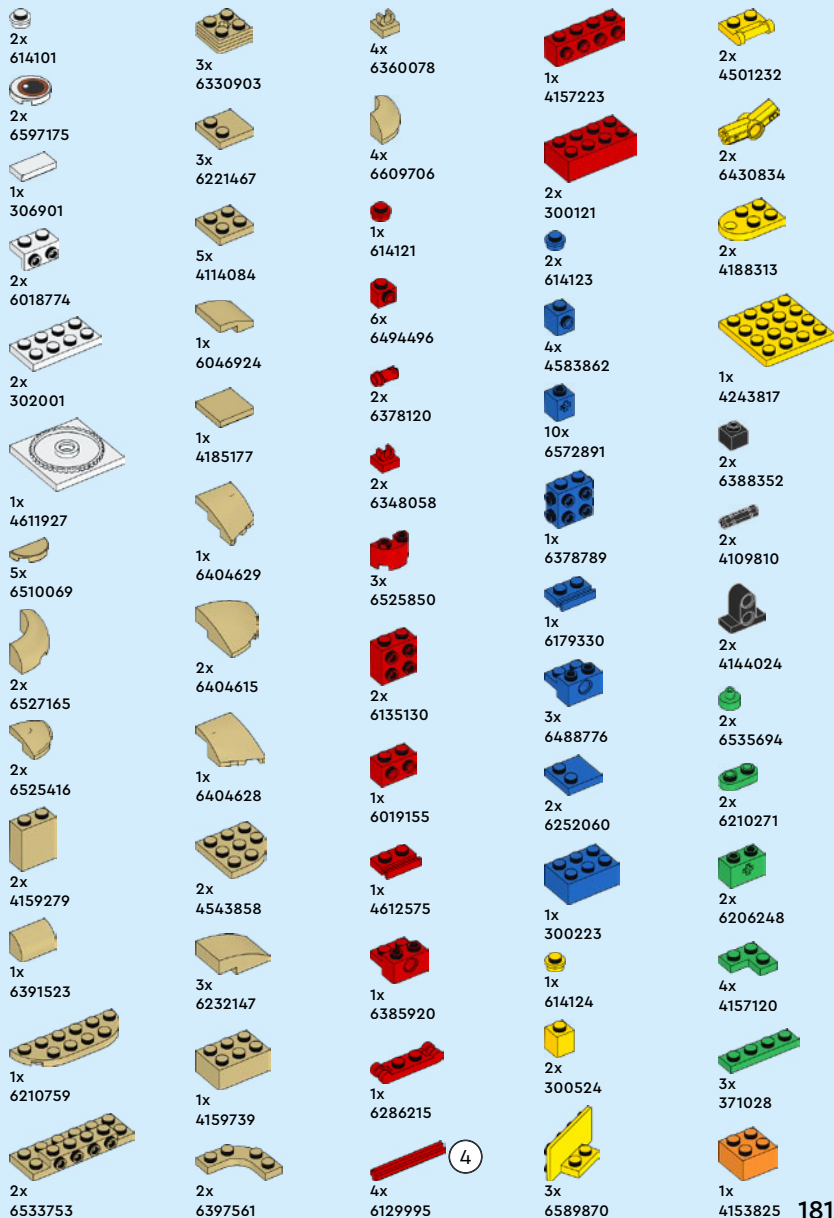



1x  
6469462



2x  
6347790



2x  
6466044



1x  
4183133



8x  
6315194



18x  
4164037



2x  
6092592

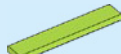

2x  
6167465

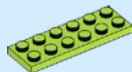

1x  
4621548



6x  
6248970



1x  
6609294



1x  
6609293



2x  
6609613



2x  
6560052



1x  
6109930



2x  
6177824



2x  
4216581



2x  
6174856



4x  
6296859



10x  
6267495



1x  
6510058



4x  
6043656



4x  
4211881



4x  
6469440



2x  
4211435



2x  
6474324



4x  
6135607



2x  
6083620



2x  
6364352



2x  
6039479



2x  
6133726



16x  
6217797



4x  
6240462



4x  
6553415



4x  
6481634



4x  
6481633



3x  
6529298



6x  
6271374



2x  
6178247



2x  
6326495



8x  
6609335



18x  
6596894



4x  
6466040



21x  
6057387



6x  
6553413



8x  
6056381



4x  
6132918



2x  
6099449



16x  
6549101



12x  
6222189



2x  
6609337



2x  
6293401



4x  
6554315



12x  
6404150



1x  
6609339



6x  
6610702



10x  
6599554



6x  
6609336



6x  
6578748



2x  
4621542



4x  
6608405



1x  
6609338



1x  
6147732



8x  
6486716



1x  
6602936



12x  
6056263



2x  
6468165



3x  
6553410

4



5x  
6097094



1x  
4649764



4x  
6548252



1x  
6605741



1x  
6287844



4x  
6353192



4x  
6353189



2x  
6490206



1x  
4566522



2x  
6517733



2x  
6167641



2x  
6215606



2x  
6192920



2x  
6167642



12x  
6334102



2x  
6586095



3x  
6056383



8x  
6431822



1x  
6093494



4x  
6313600



4x  
6119107



2x  
4624705



1x  
6102828



3x  
4655256



5x  
4619512



2x  
6590532



2x  
6537998



1x  
6177195



1x  
6022023



13x  
6344844



4x  
4619524



1x  
4625027



LEGO.com/service

YOU COULD

WIN



Scan this QR code or go to  
**LEGO.COM/PRODUCTFEEDBACK**  
and give us your short feedback  
about this LEGO® set for a chance  
to win a cool LEGO prize.

Terms and Conditions apply\*

**EN: YOU COULD WIN.** Terms and Conditions apply\* **DE: Du könntest GEWINNEN.** Es gelten die Teilnahmebedingungen\* **FR: TU POURRAIS GAGNER.** Des conditions s'appliquent\* **IT: Potresti VINCERE tu.** Termini e condizioni sono applicabili\* **ES: PUEDES GANAR.** Aplican términos y condiciones\* **PT: PODERÁ GANHAR.** Aplicam-se Termos e Condições\* **ZH: 轻松获奖.** 条款和条件适用\* **PL: Szansa na WYGRANAŃ.** Obowiązuje regulamin\* **CS: Máte šanci VYHRÁT.** Platí všeobecné smluvní podmínky\* **SK: Máte šancu VYHRÁŤ.** Platia všeobecné zmluvné podmienky\* **HU: TE IS NYERHETSZ!** Felhasználási feltételek érvényesek\* **UA: ВИ МОЖЕТЕ ВИГРАТИ.** Застосовуються загальні положення та умови\* **RO: Ai putea CĂȘTIGA.** Se aplică termeni și condiții\* **BG: Можете да СПЕЧЕЛИТЕ.** Има определени правила и условия\* **LV: Tu vari LAIMĒT.** Ir spēkā noteikumi un nosacījumi.\* **ET: Sul on võimalus VÕITA.** Kehtivad tingimused\* **LT: Jūs galite LAIMĖTI.** Taikomos sąlygos\* **TR: KAZANABİLİRSİN.** Şartlar ve Koşullar geçerlidir\*

\*[LEGO.com/productfeedback-terms](https://www.lego.com/productfeedback-terms)

LEGO and the LEGO logo are trademarks of the LEGO Group.  
©2026 The LEGO Group.

© Disney/Pixar



6648127