



Disney

43307



LEGO® Builder



### **Get excited about our new packaging!**

We're switching from plastic to paper-based packaging. That's why you might find a mix of paper and plastic in our boxes!

### **Nos nouveaux emballages vous emballeront !**

Nous passons des emballages en plastique aux emballages à base de papier. C'est pourquoi vous pourriez trouver un mélange de papier et de plastique dans nos boîtes !

### **¡Te presentamos nuestros nuevos empaques!**

Estamos sustituyendo las bolsas de plástico por bolsas con base de papel. ¡Por eso, puedes encontrar una mezcla de papel y de plástico en nuestras cajas!

**[LEGO.com/sustainable-packaging](https://www.lego.com/sustainable-packaging)**

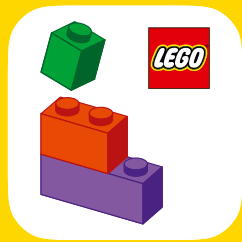

LEGO® Builder



# BUILDER



Apple and the Apple logo are trademarks of Apple Inc., registered in the U.S. and other countries and regions. App Store is a service mark of Apple Inc. Google Play and the Google Play logo are trademarks of Google LLC. Tencent and the Tencent logo are trademarks of Tencent Inc.

[LEGO.com/devicecheck](http://LEGO.com/devicecheck)

EN Ask parents' permission before going online | DE Eltern um Erlaubnis bitten, bevor du online gehst | FR Demande l'autorisation d'un parent avant d'aller en ligne | IT Chiedi il permesso ai tuoi genitori prima di andare online | ES Pídeles permiso a tus papás antes de conectarte a Internet | PT Pede autorização aos teus pais antes de ficares online | ZH 上网前应先征得父母的同意 | PL Poproś rodziców o zgodę, zanim wejdiesz do Internetu | CS Než půjdeš na internet, požádej rodiče o svolení | SK Skôr než pôjdeš na internet, vypýtaj si povolenie od rodičov | HU Kérj szülői engedélyt, mielőtt online csatlakoznál! | UA Запитуйте дозволу батьків, перш ніж користуватися інтернетом | RO cere permisiunea părinților înainte de a te conecta online | BG Поискайте разрешение от родител, преди да влезете онлайн | LV Pirms došanās tiešsaistē palūdz atļauju vecākiem | ET Enne Interneti kasutamist küsi vanematelt luba | LT Prieš prisijungdami prie interneto, atsiklauskite tėvų | TR İnternete girmeden önce anne babandan izin iste

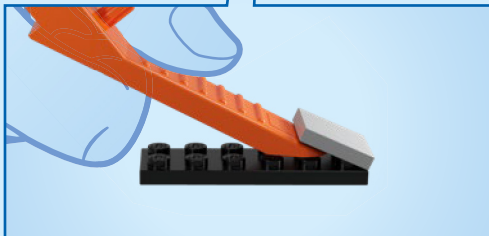
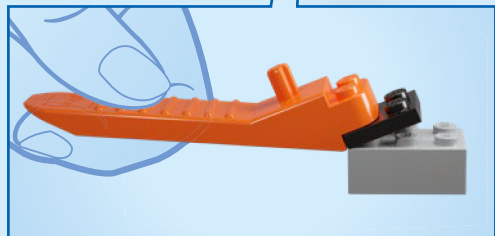
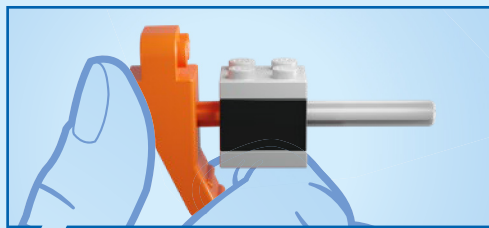
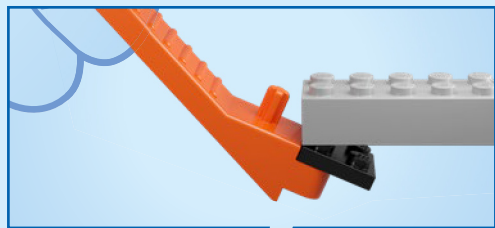



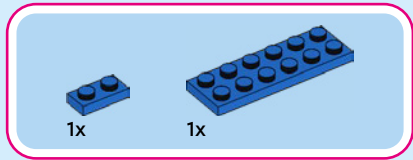

1

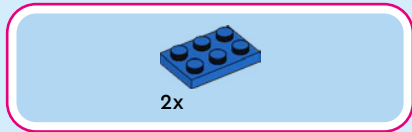
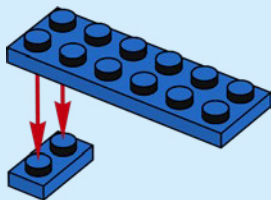

2

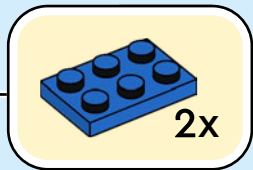
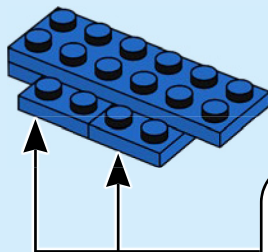

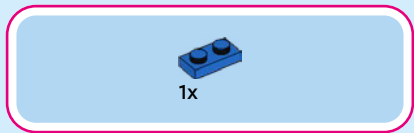

3

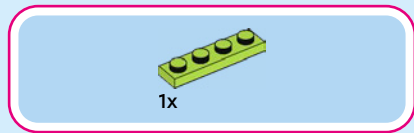
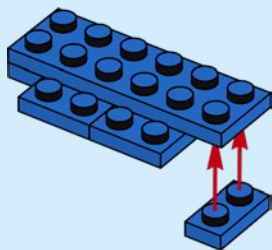

4

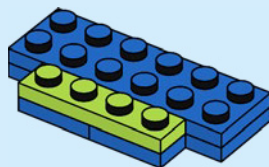



1x



2x

5

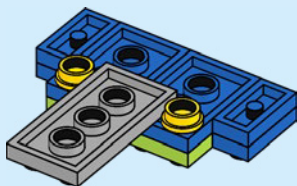

3x

6

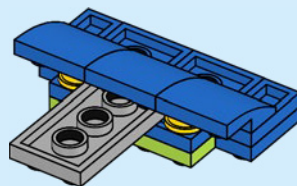

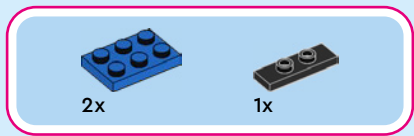

7

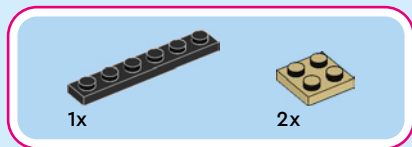
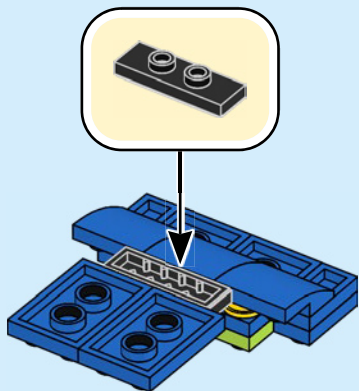

8

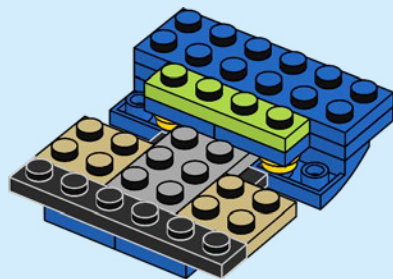



1x



2x

9

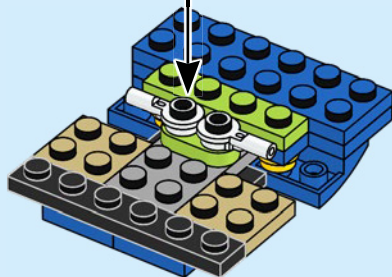
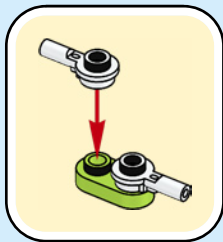



2x

10

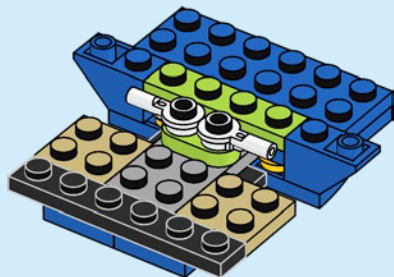

2x



2x

11

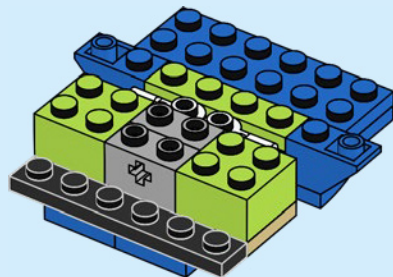



2x



1x



2x

# 12

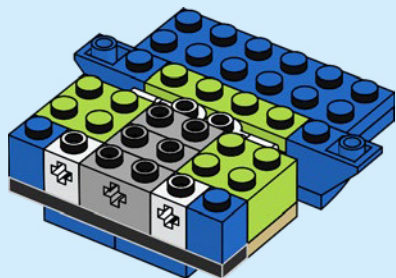

1x



1x

# 13

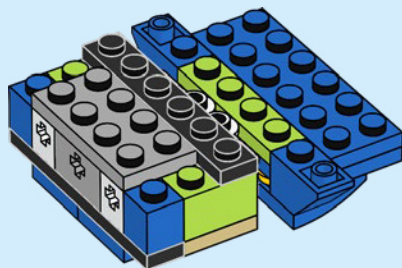

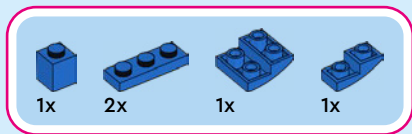

14

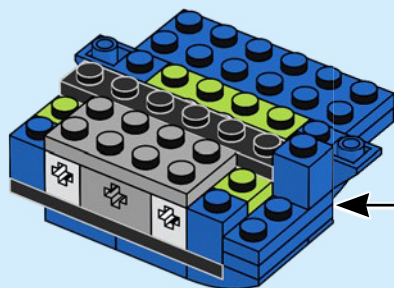
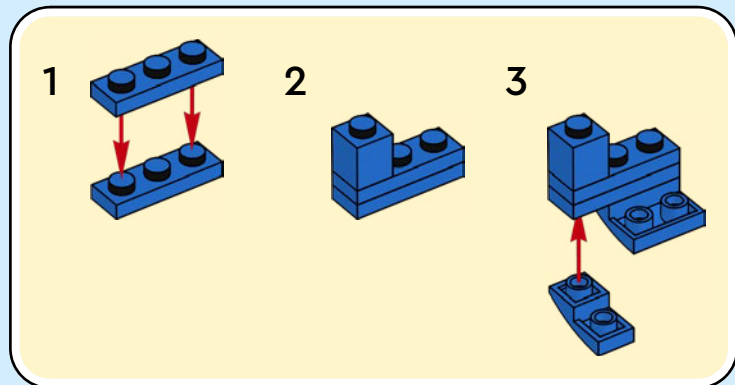

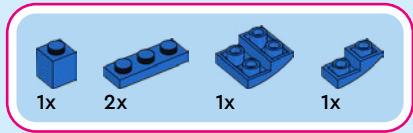

15

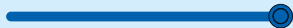
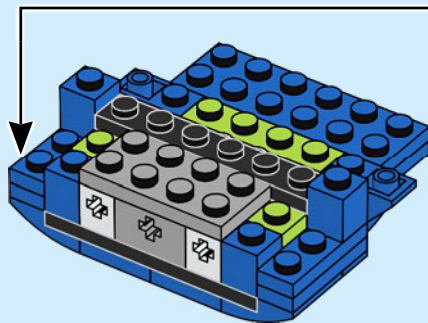
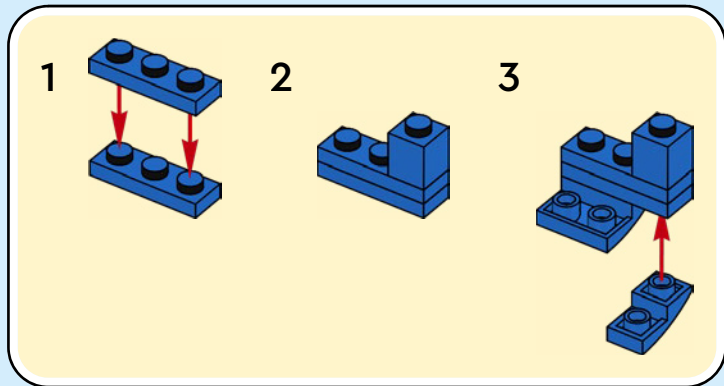



2x

16

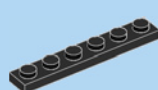
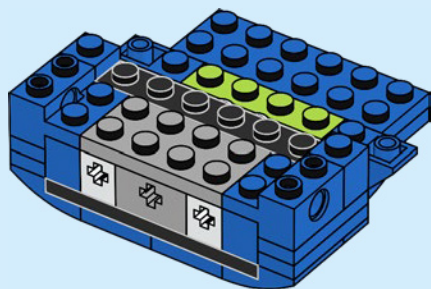

1x

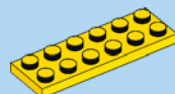

1x

17

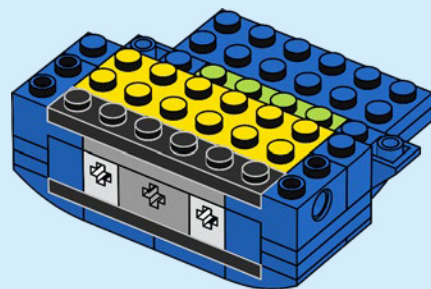



3x

18

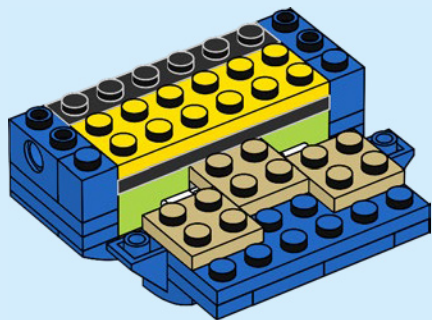
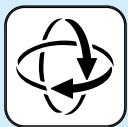

1x



1x

19

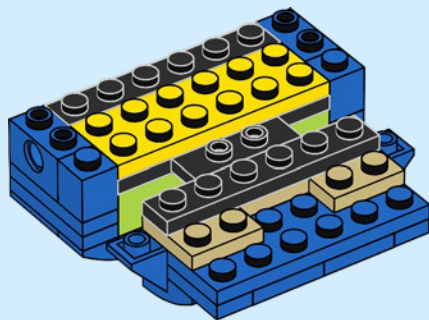

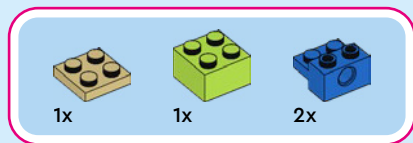

20

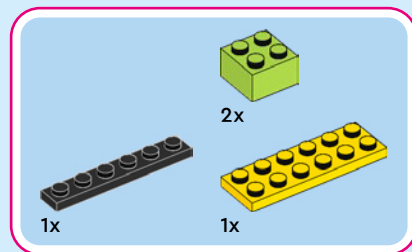
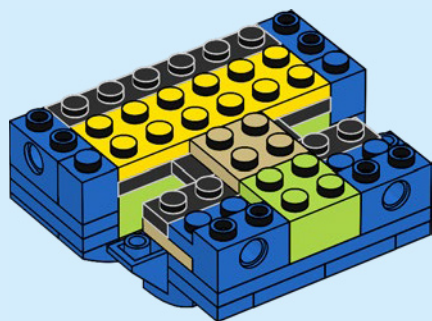

21

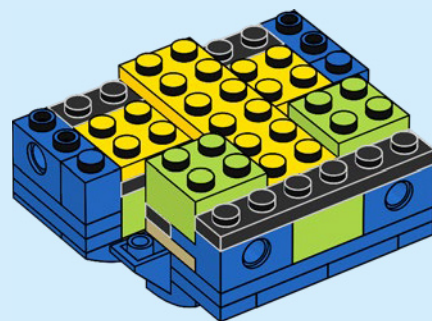

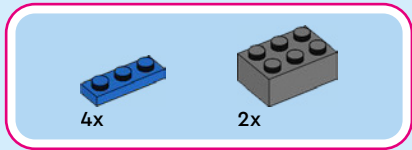

22

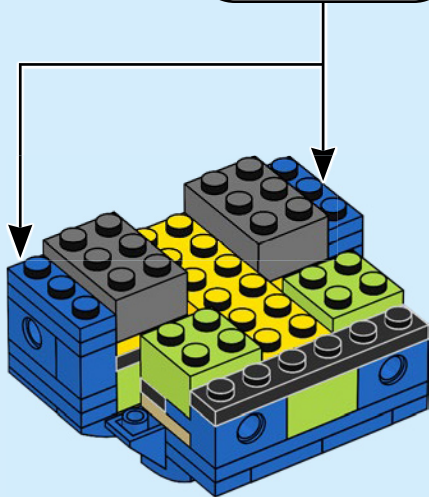
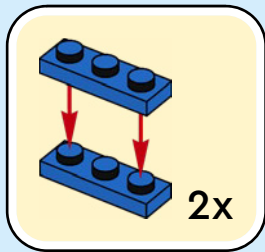

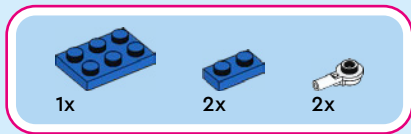

23

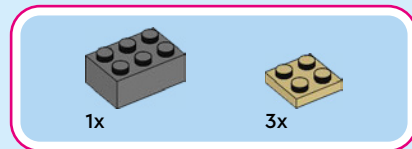
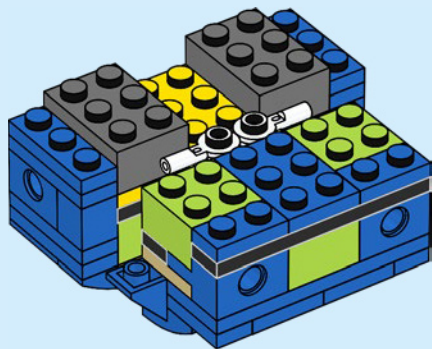

24

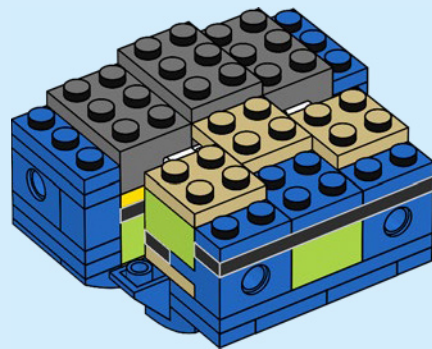



2x



1x



1x

25

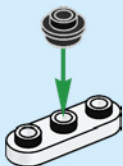

1x



1x

26

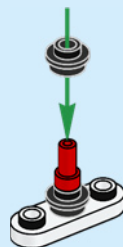



2x

27

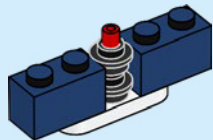

1x

28

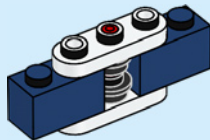



1x



2x

29

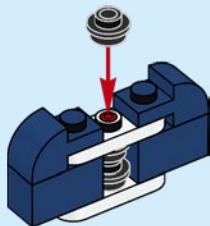

1x

30

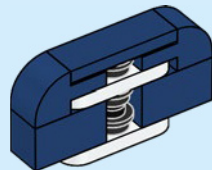



2x



2x

31



2x

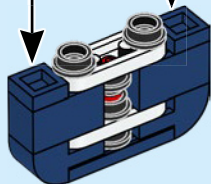

2x

32

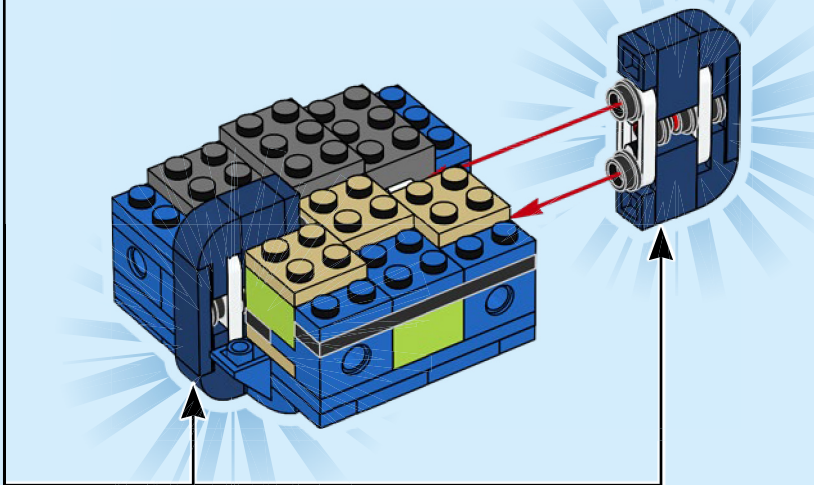

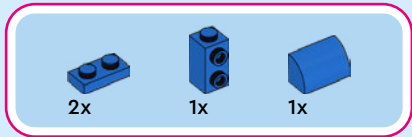

33

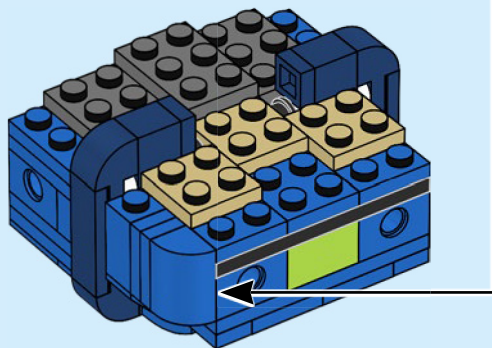
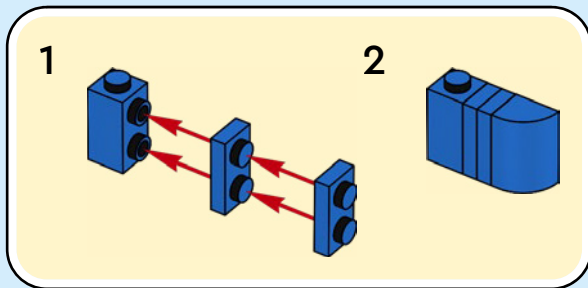

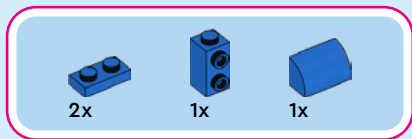

34

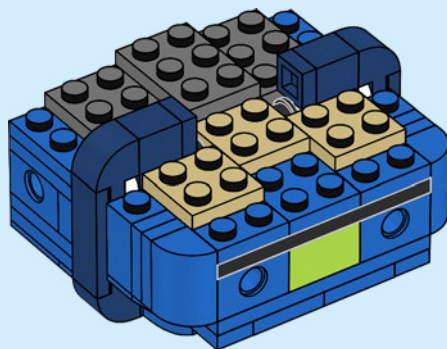
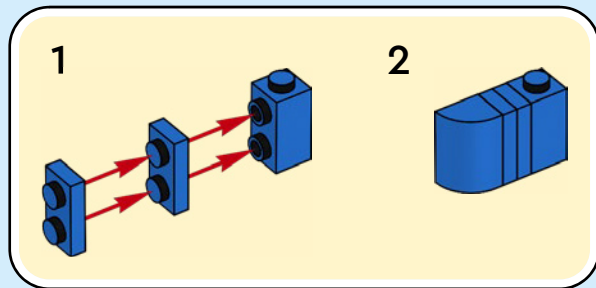



2x



1x

# 35

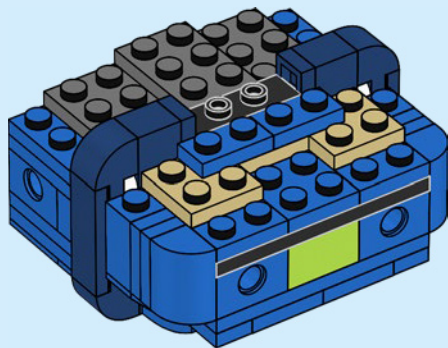



6x

36

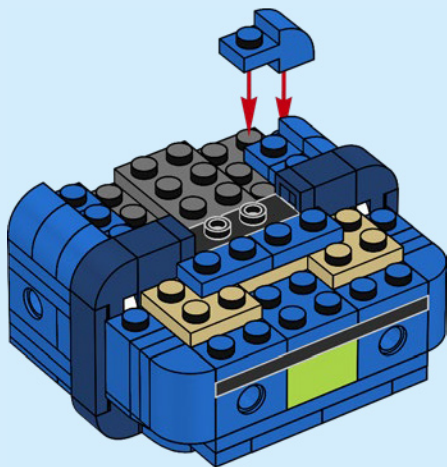

2x



4x

37

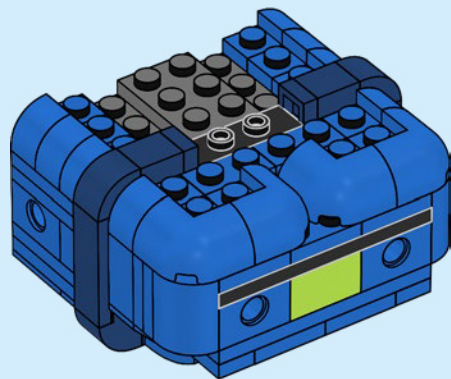

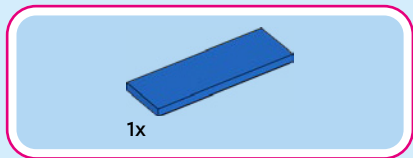

38

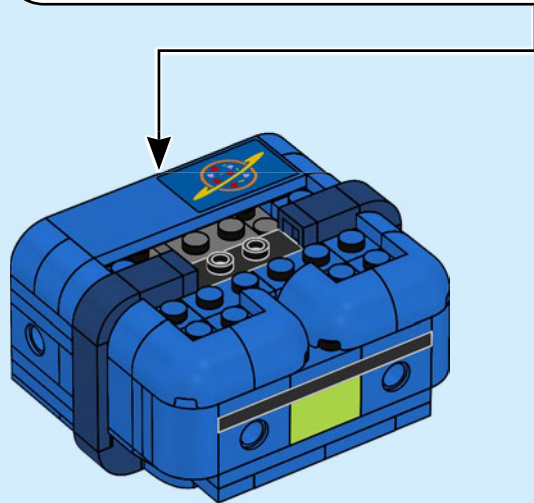
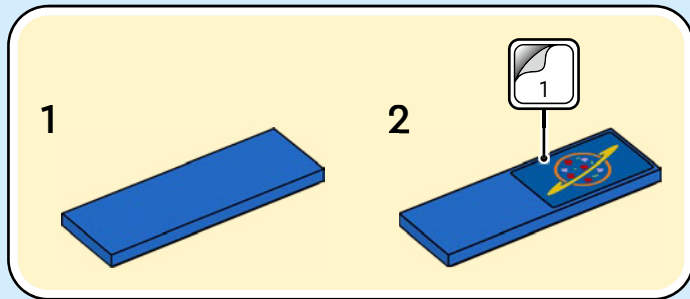

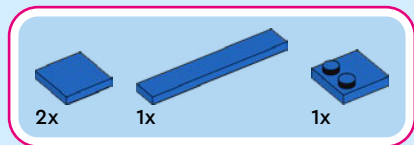

39

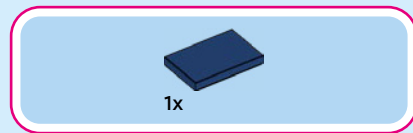
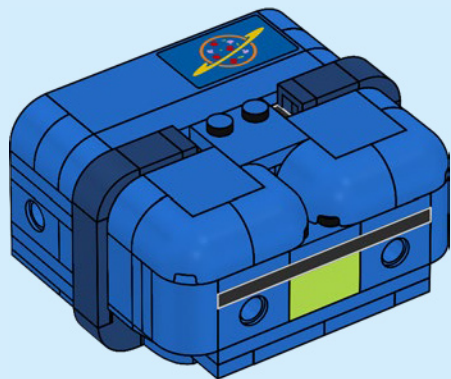

40

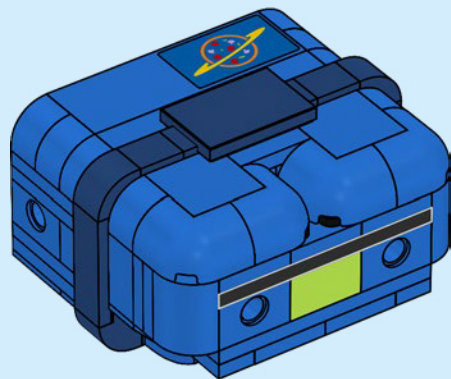





1x



1x

42

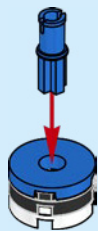

2x

43

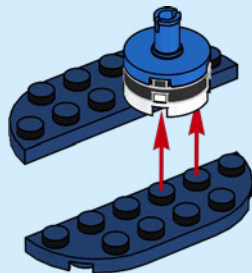

2x

44

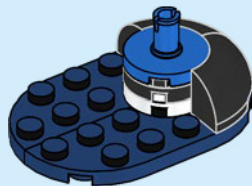



1x



1x

# 45

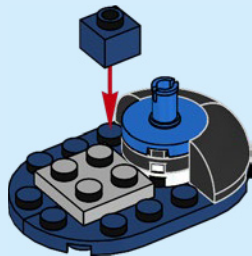

1x



1x

# 46

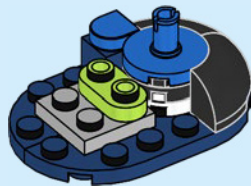



47



48

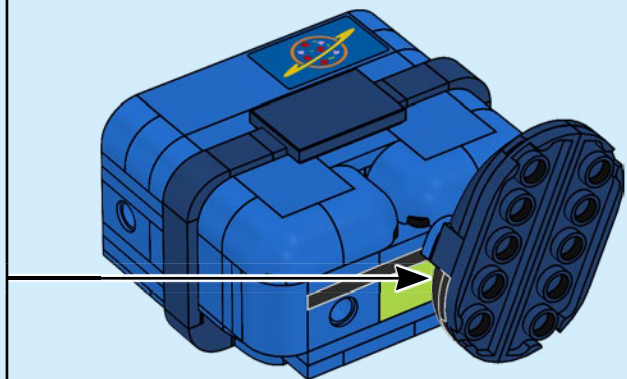



1x



1x

49

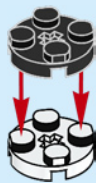

1x



1x

50

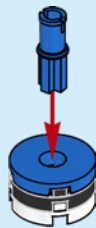



2x

51

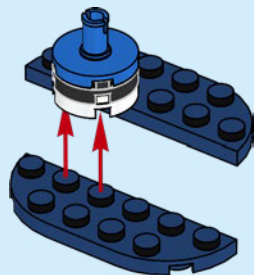

2x

52

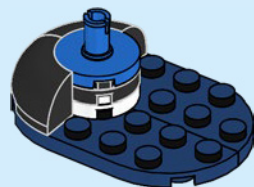



1x



1x

# 53

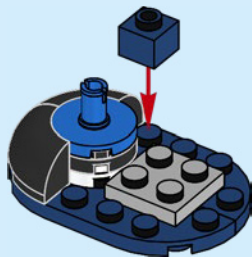

1x



1x

# 54

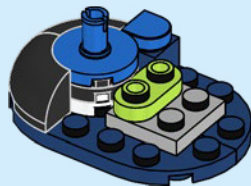



55



56

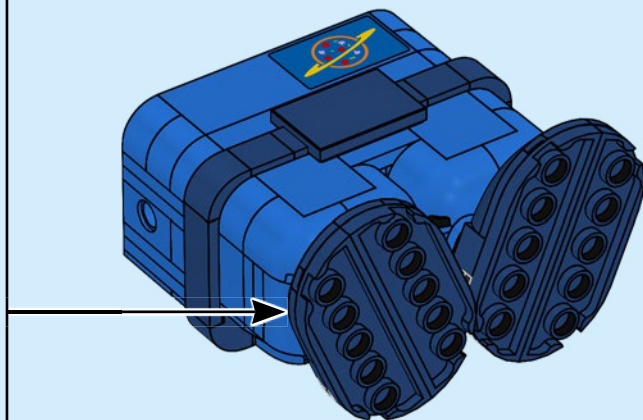



2x



1x



1x

57

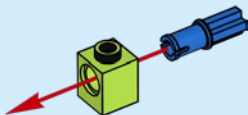

1x



1x

58

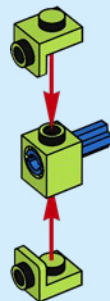



1x

59

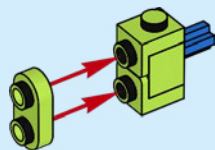

2x

60

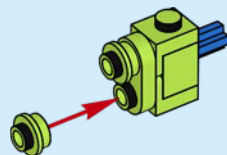



61

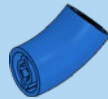
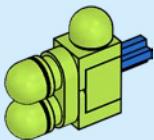

62

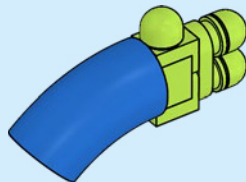

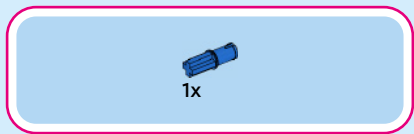

63

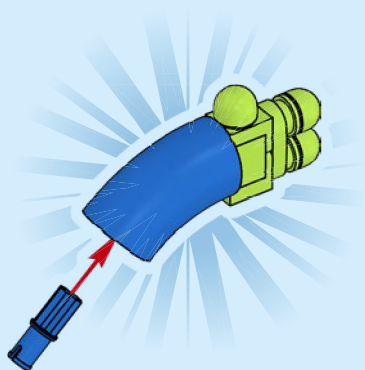

2x

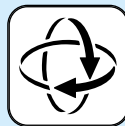

64

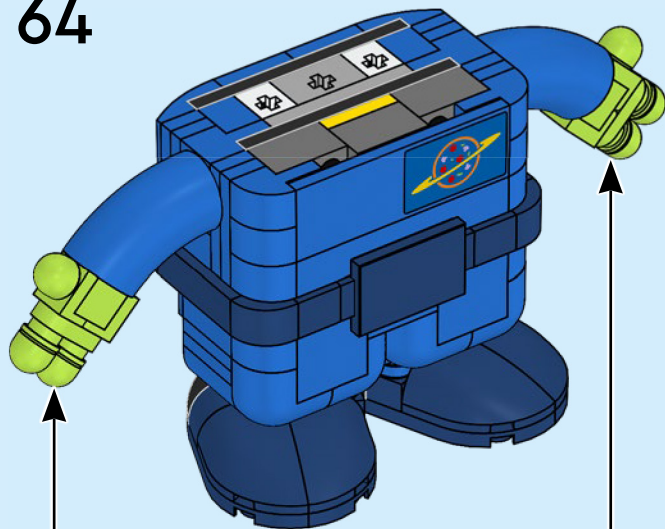

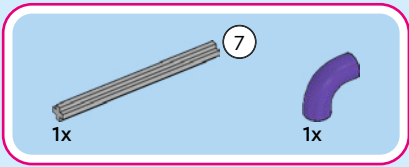
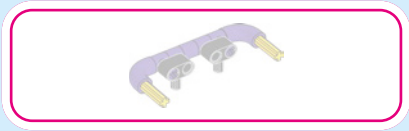

65

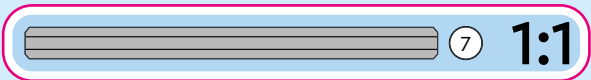
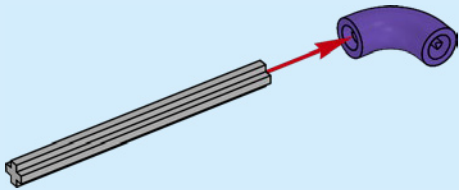

66

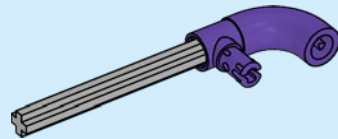



1x



3x

67

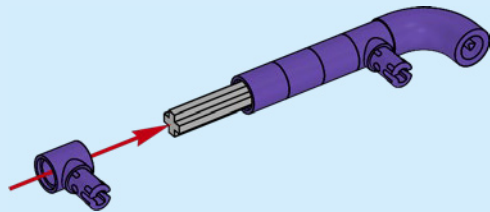

1x

68

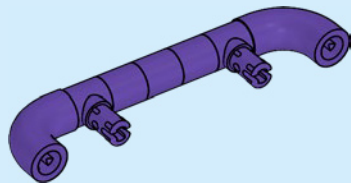

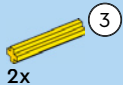

69

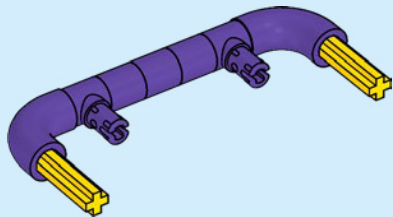

3

1:1



2x

70

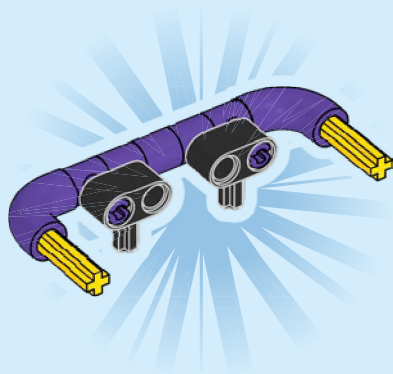

71

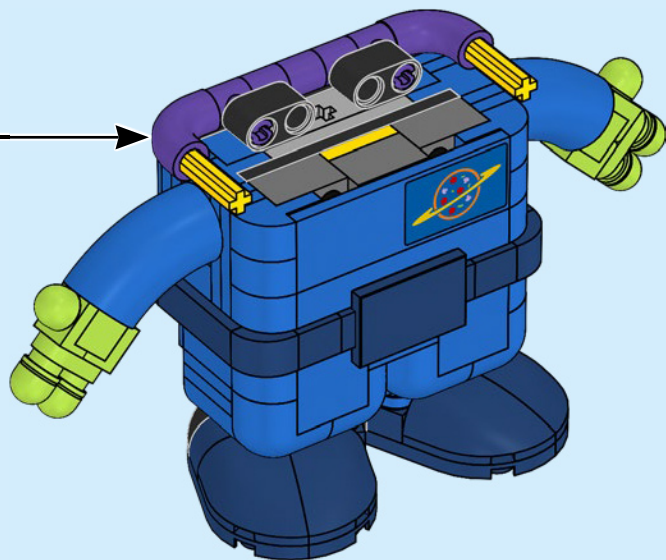

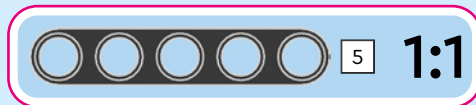
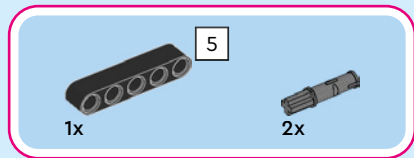

72

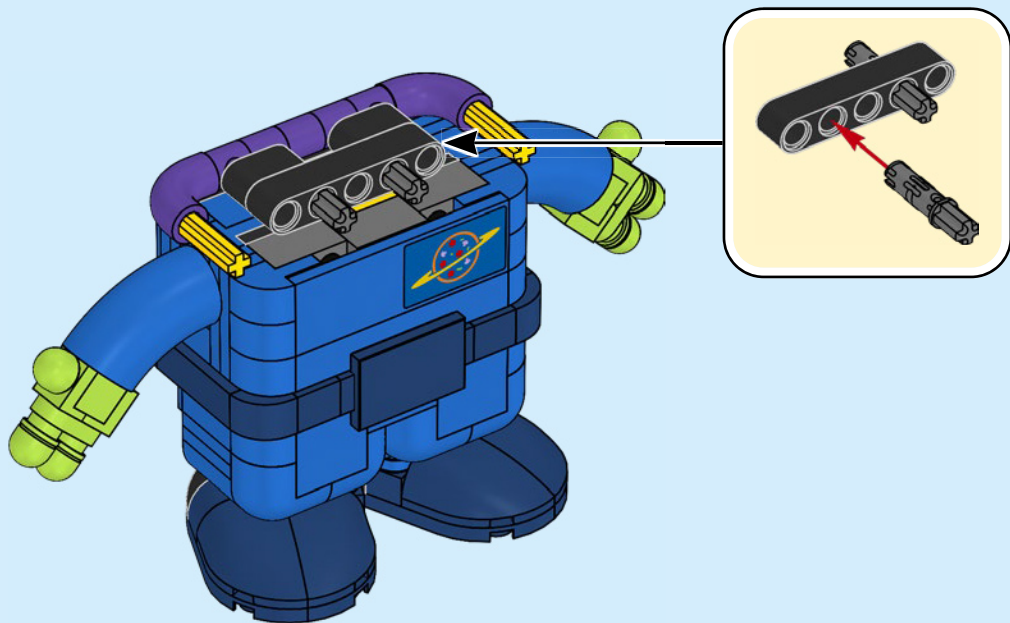



2x

73

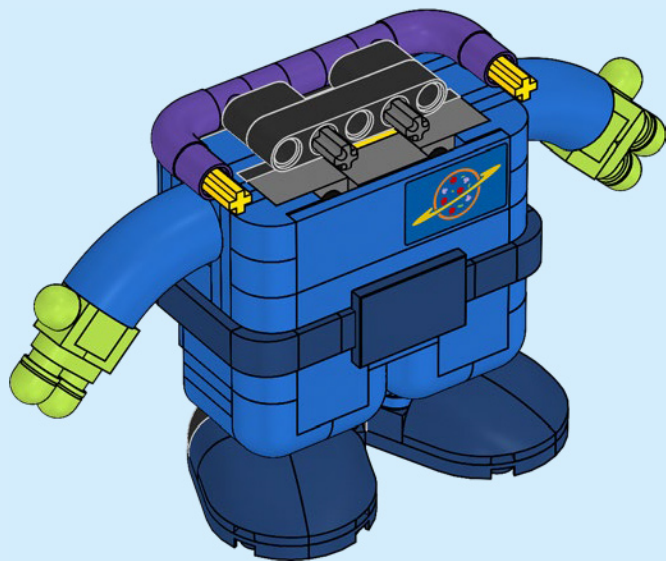

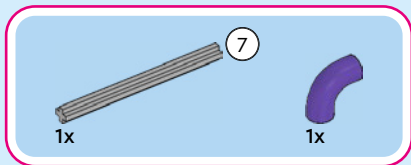

74

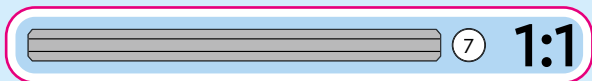
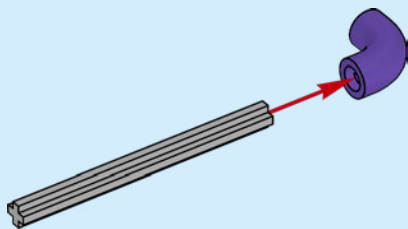

75

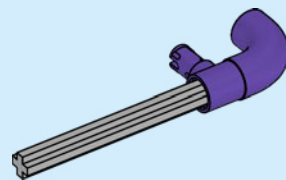



1x



3x

76

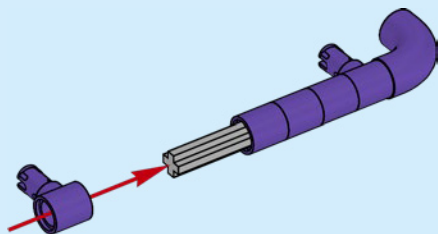

1x

77

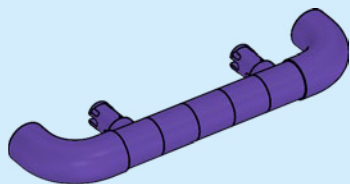

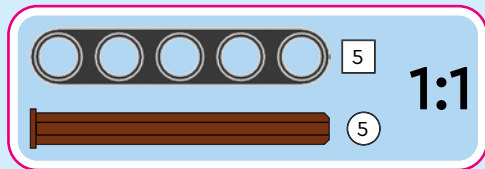
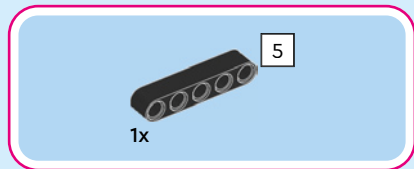

78



79

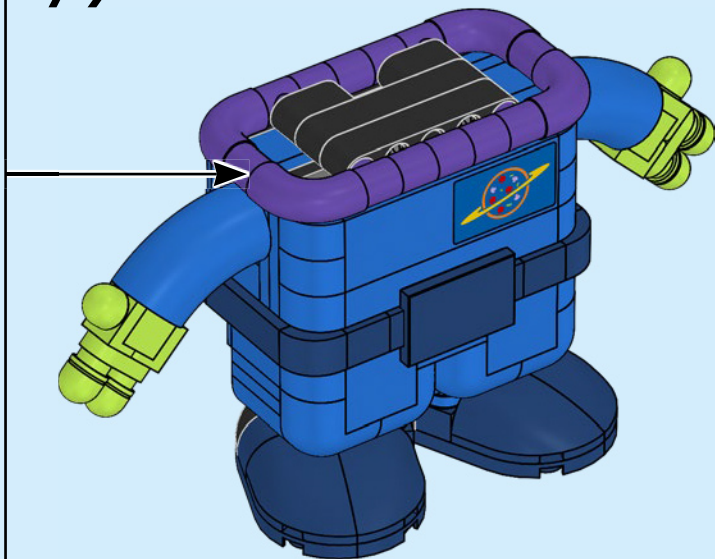

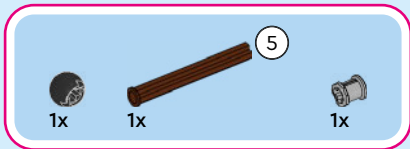

80

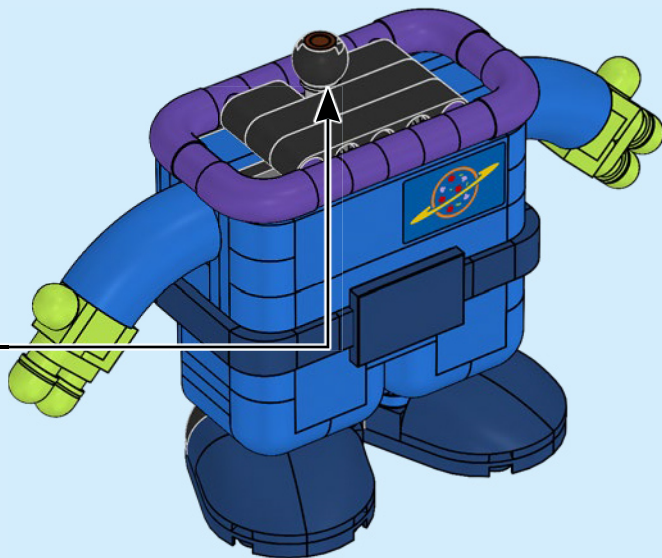
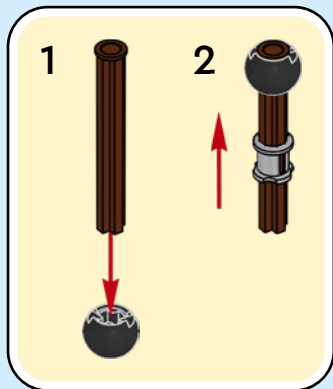

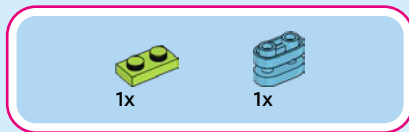
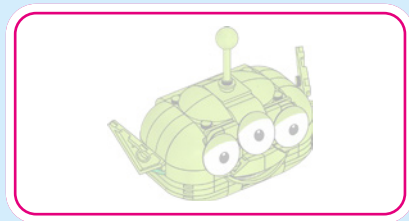

81

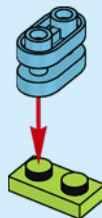

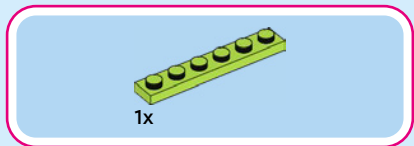

82

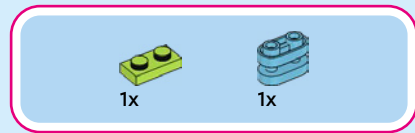
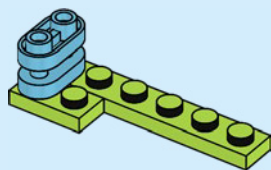

83

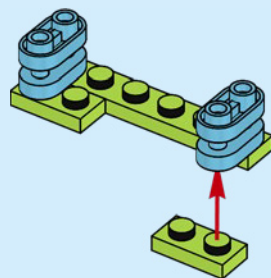



2x

84

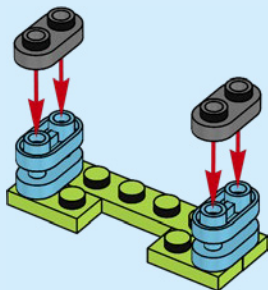

4x

85

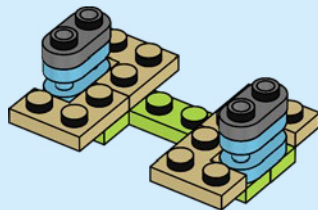



1x

86

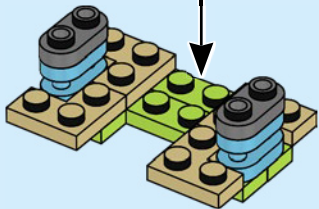
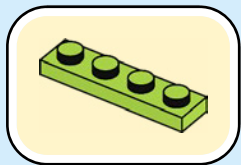

1x

87

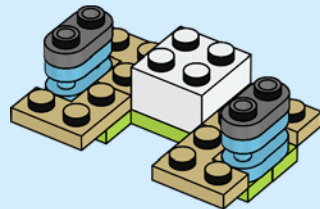

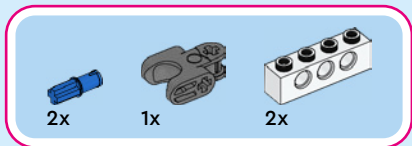

88

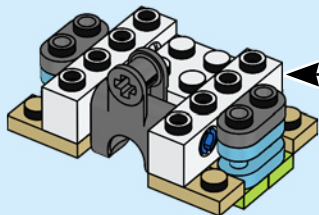
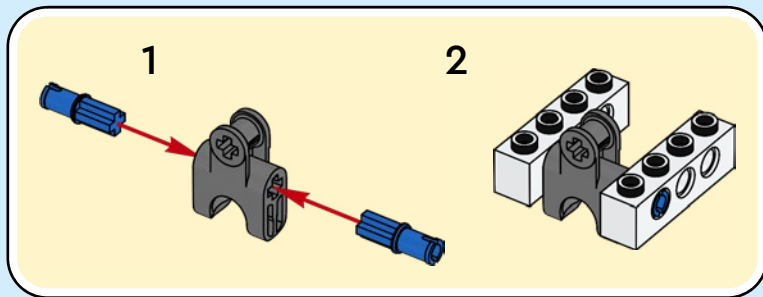



2x



2x

89

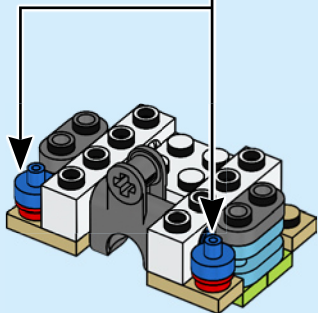
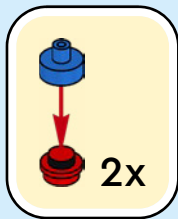

2x

90

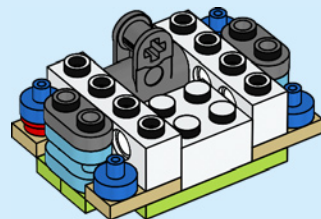
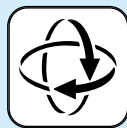



4x

91

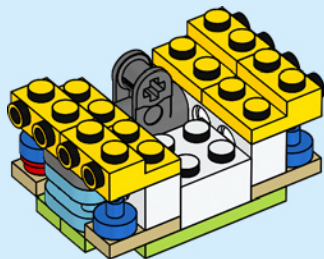

2x

92

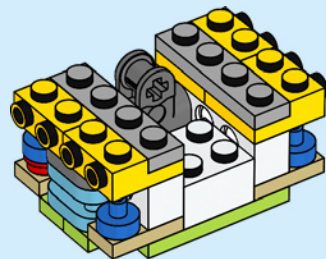

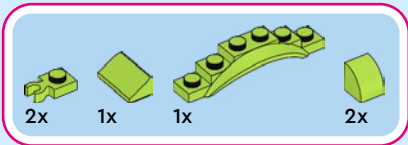

93

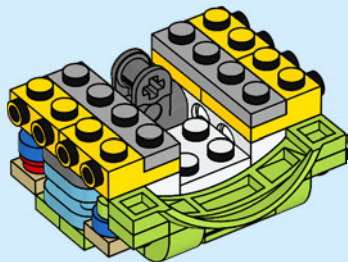
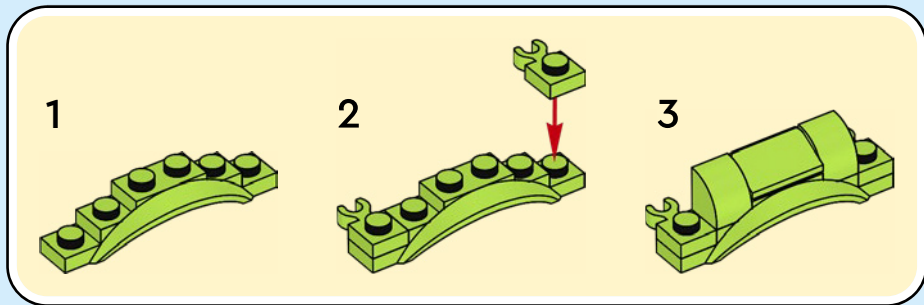

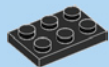

1x



1x

94

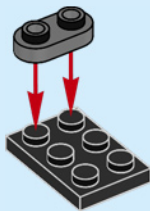

1x



1x

95

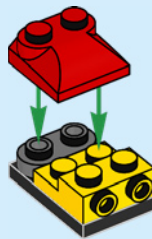



2x

96



1x

97





4x



2x



2x

# 98

1

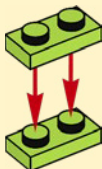

2



3



2x

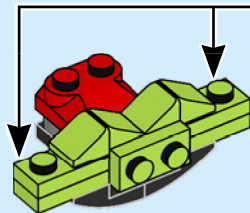

1x



1x

# 99

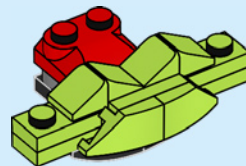

100

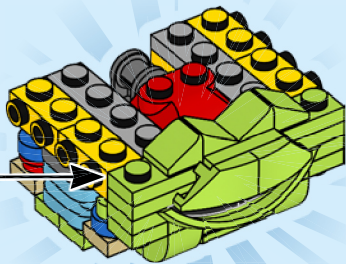

101

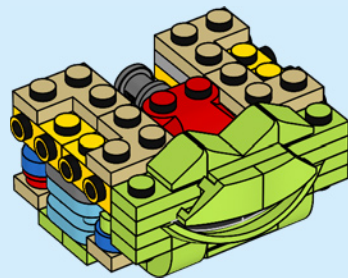
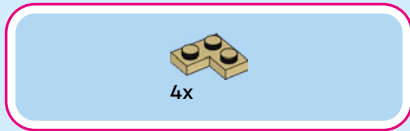



2x

102

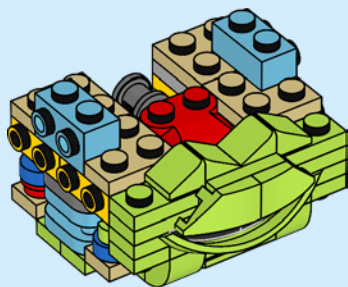

1x

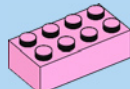

1x



2x

103

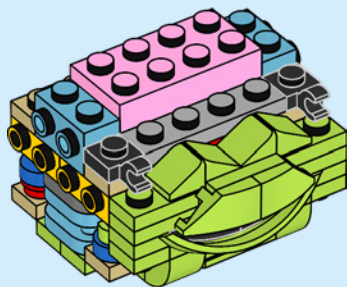



2x



1x

# 104



1x



2x



2x

# 105

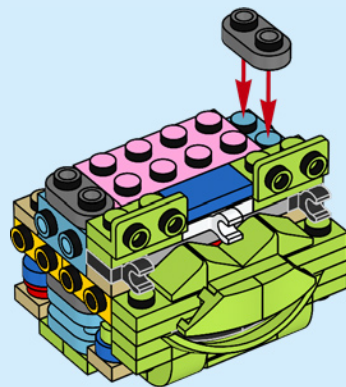



2x

106

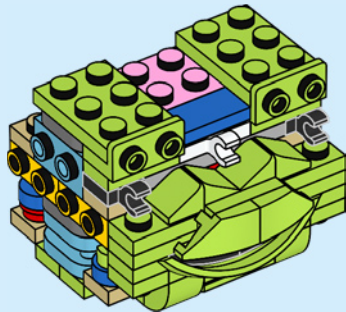

2x



2x

107

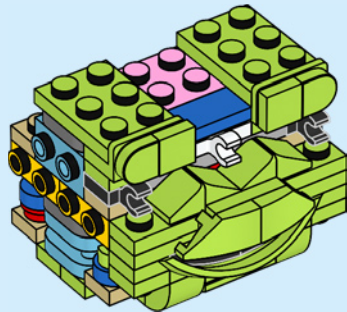

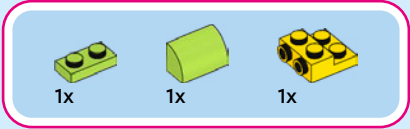

108

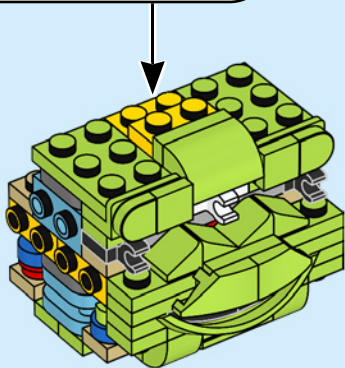
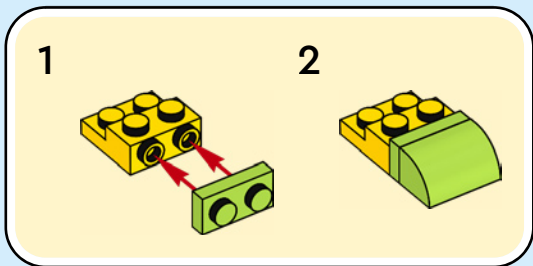

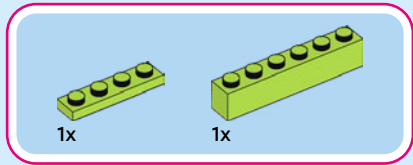

109

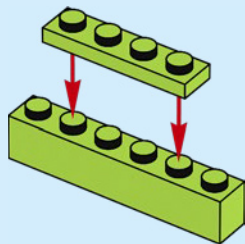

110

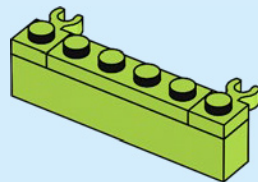



3x

111

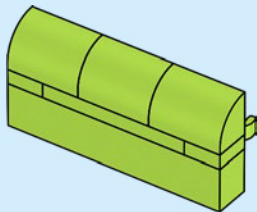

112

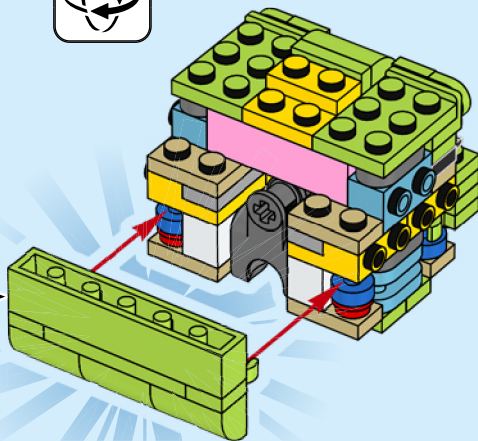

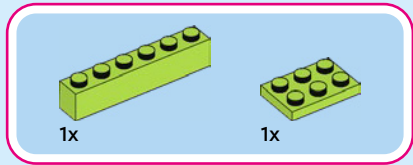

113

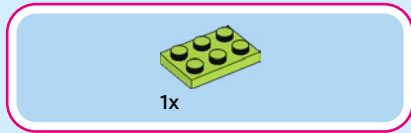
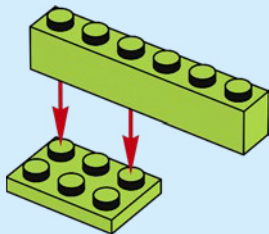

114

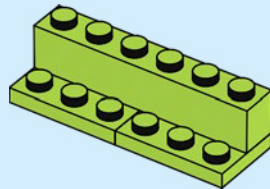

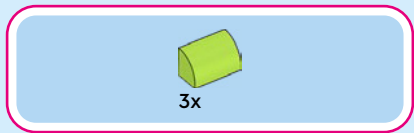

115

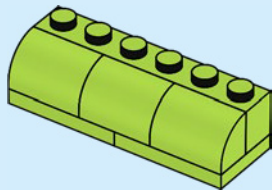

116

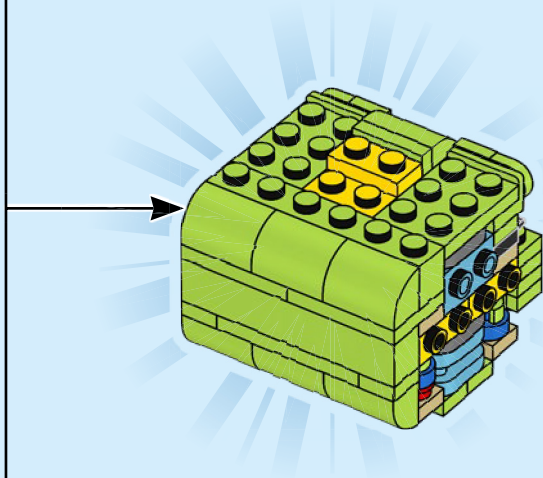



2x

117

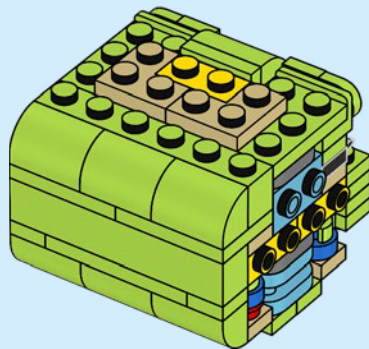



1x



1x

# 118

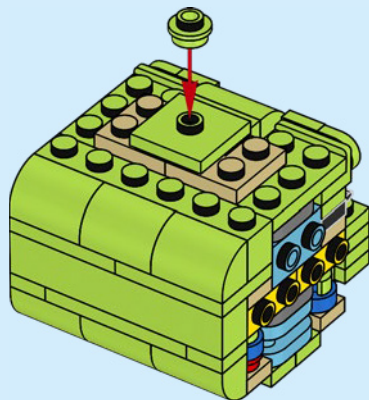

2x



4x

# 119

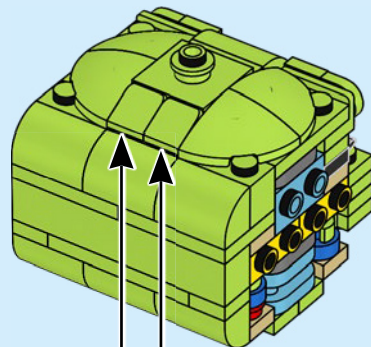

2x

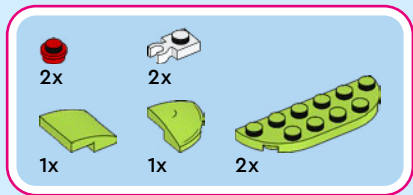

120

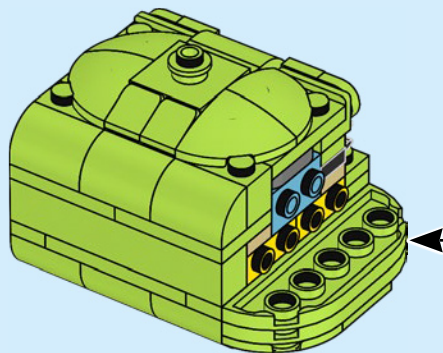
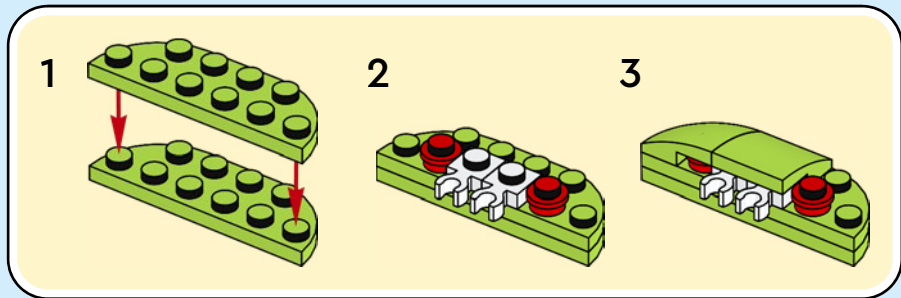

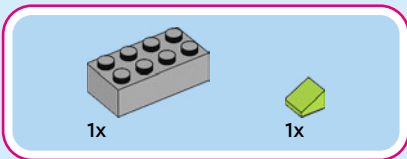

121

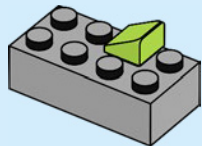

122

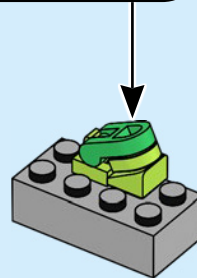
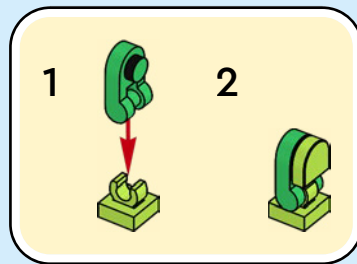



4x

123

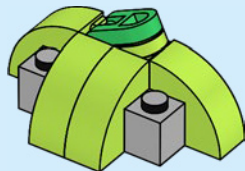

2x

124

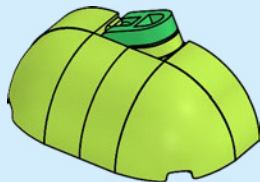

125

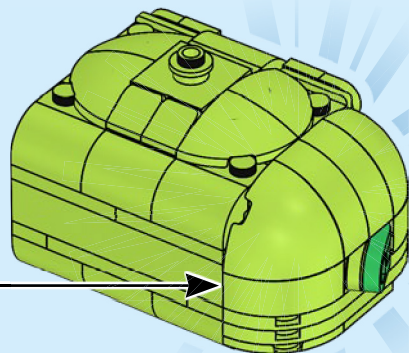

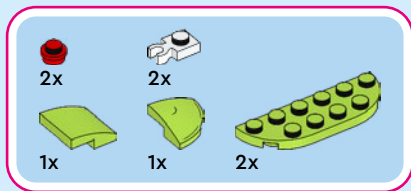

126

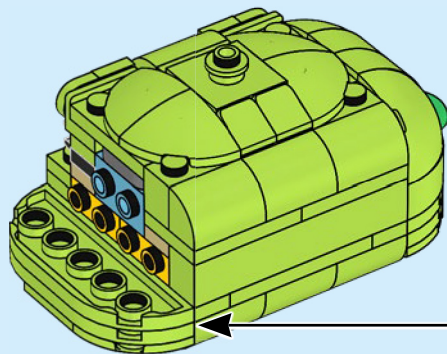
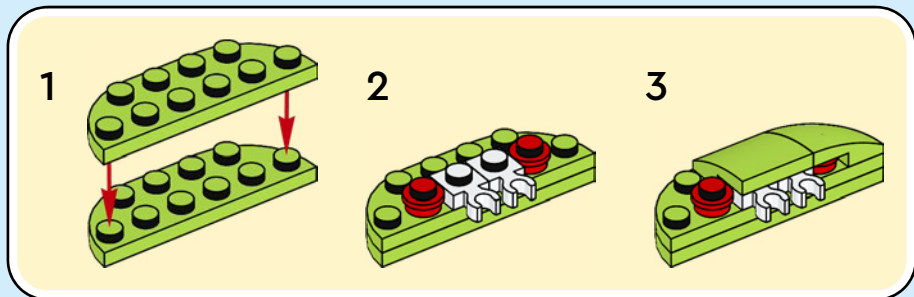



1x

1x

127

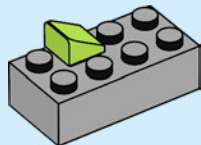

1x



1x



1x

128

1

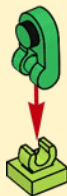

2

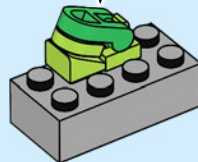



4x

129

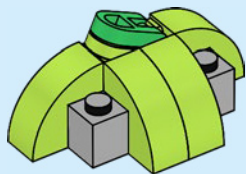

2x

130

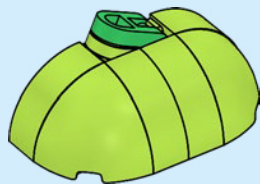

131

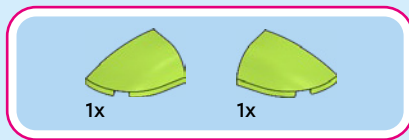
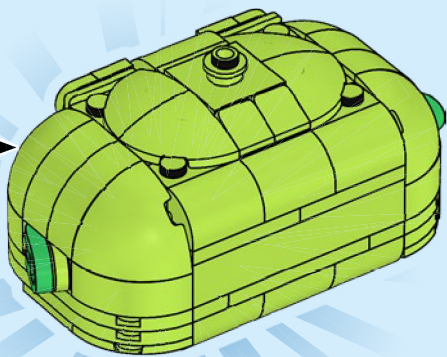

132

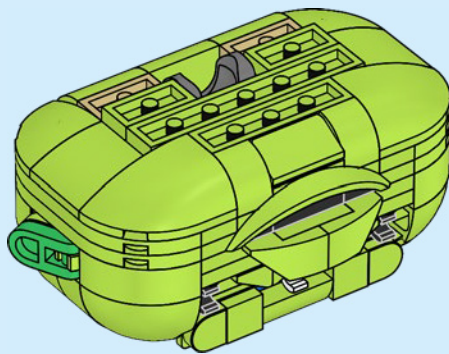



2x

133

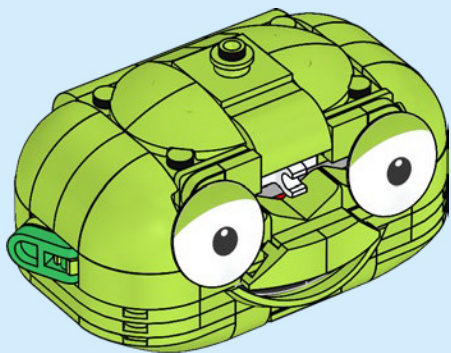
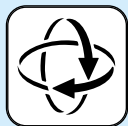

1x

134

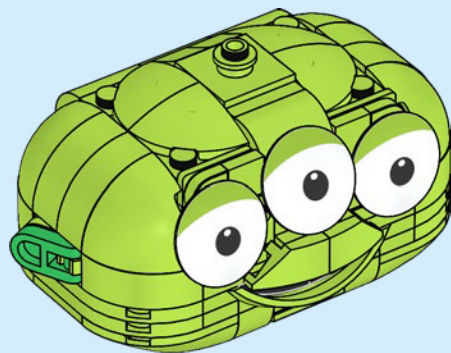

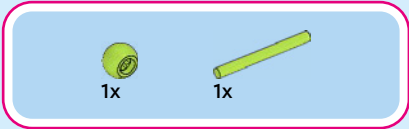

135

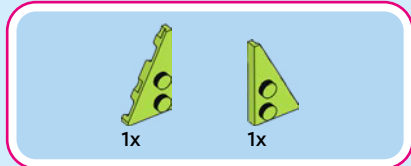
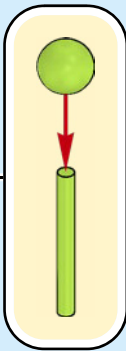
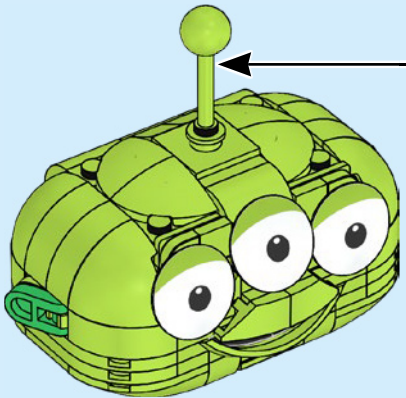

136

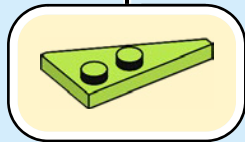
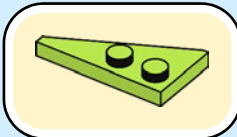
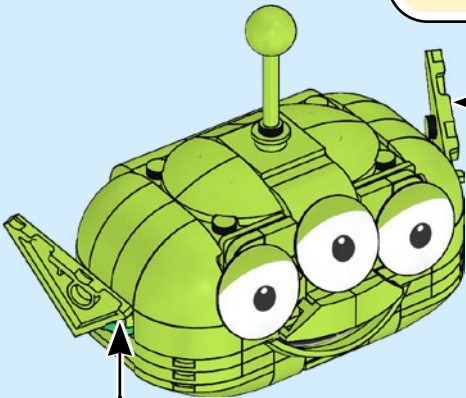

137

