



Disney

43307



2



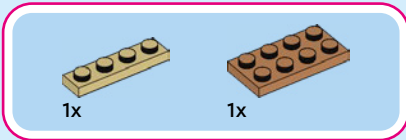
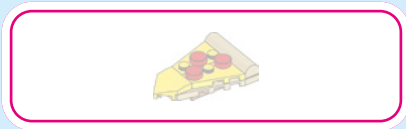

1

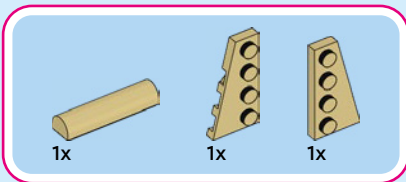
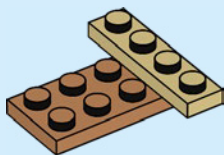

2

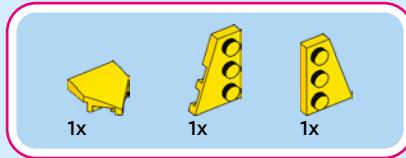
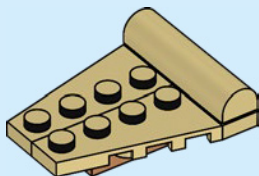

3

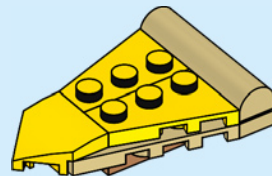

4

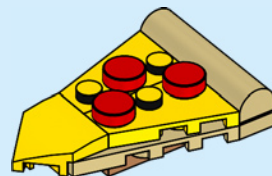

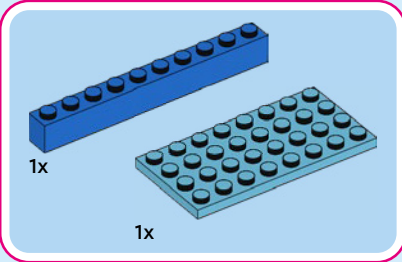
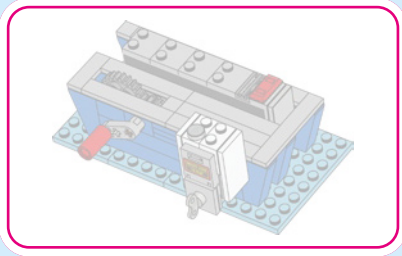

1

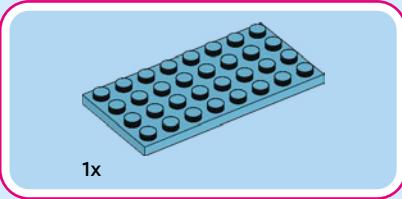
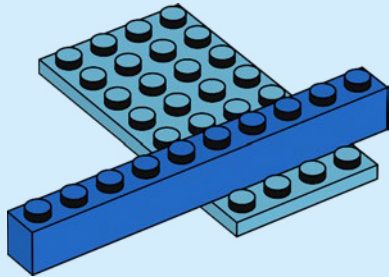

2

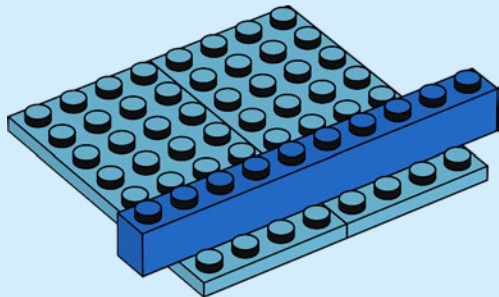

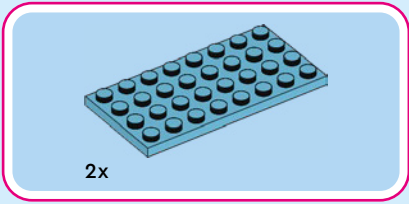

3

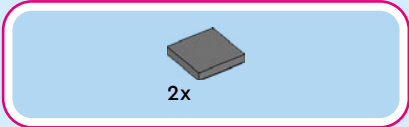
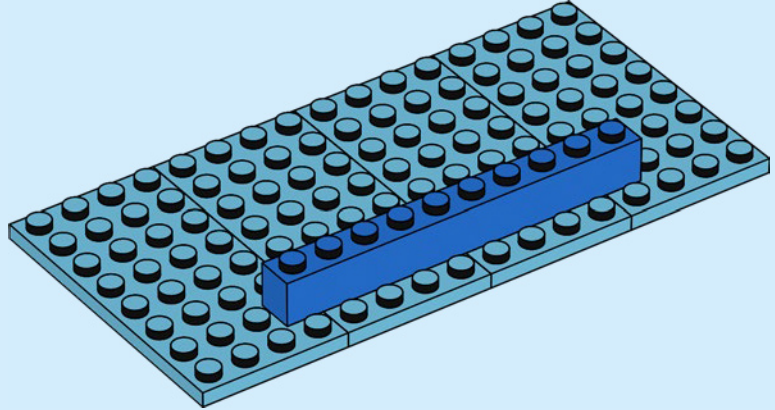

4

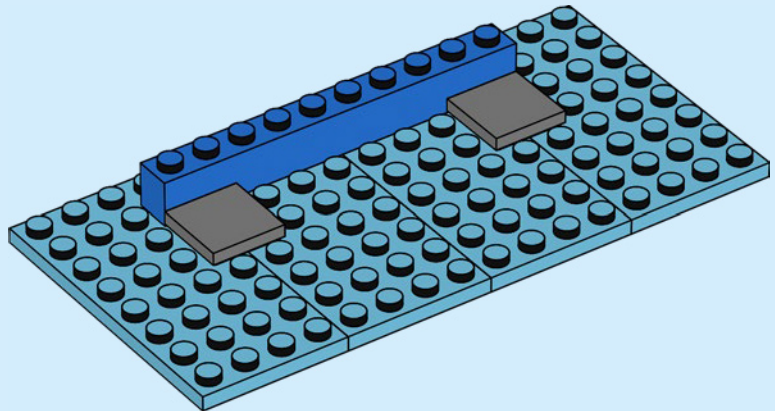



2x

5

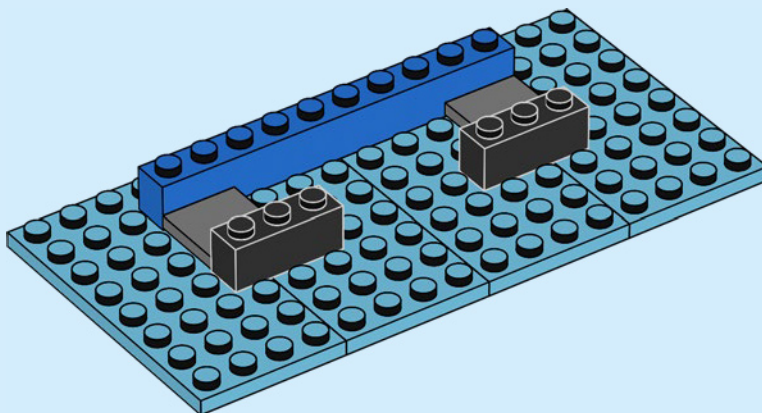

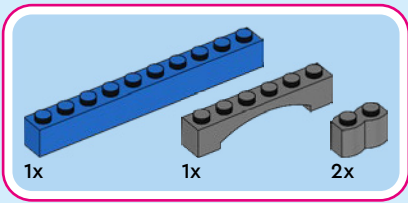

6

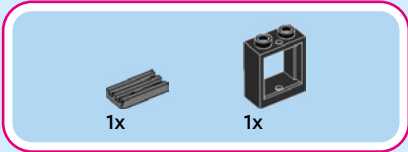
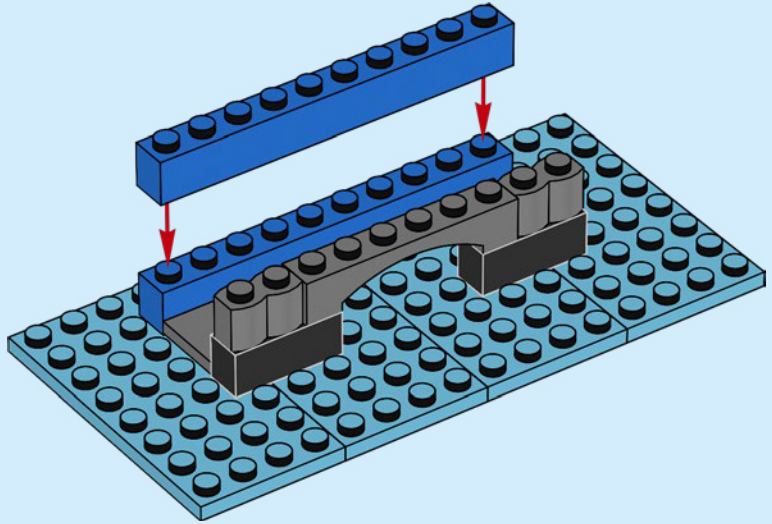

7

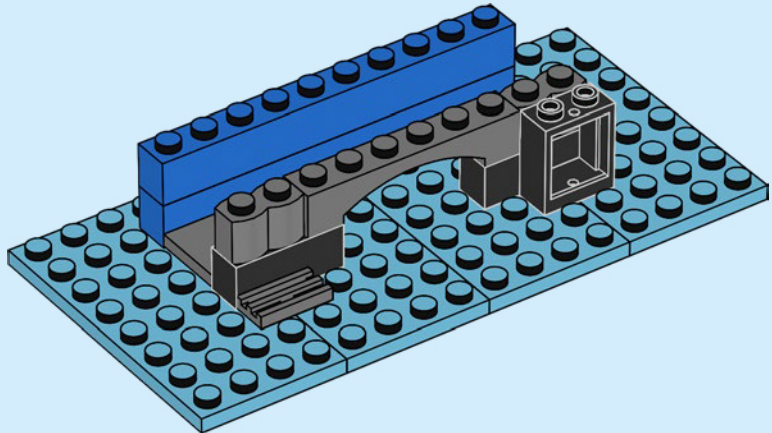

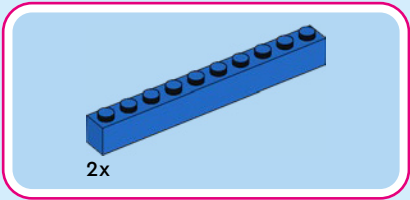

8

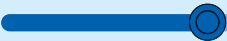
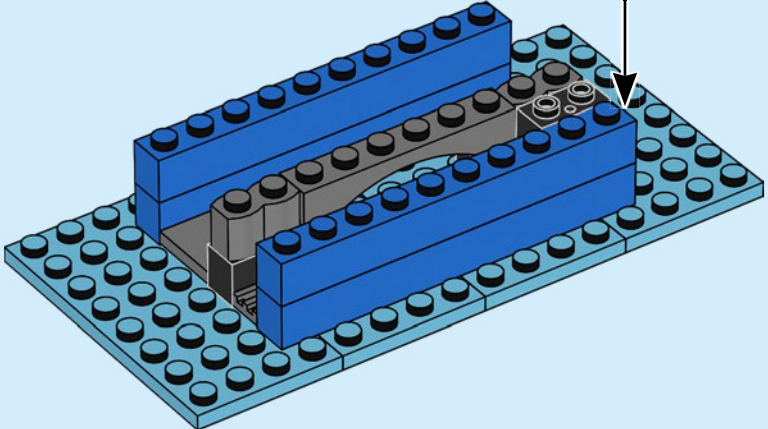
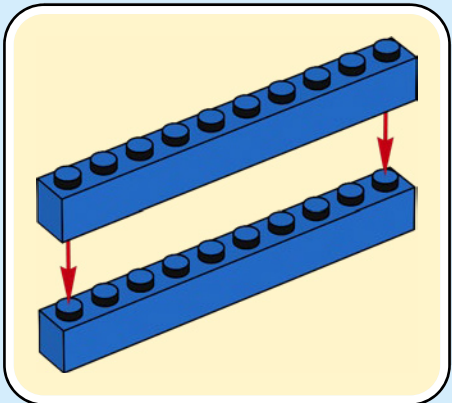

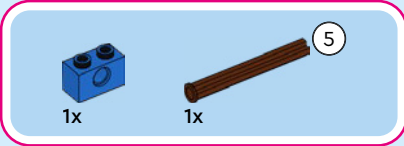
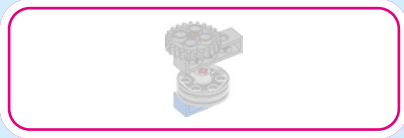

9

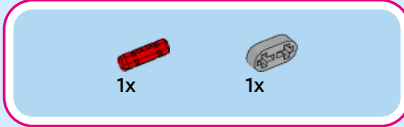
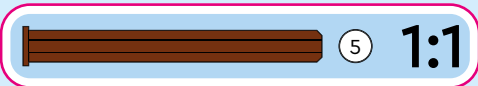
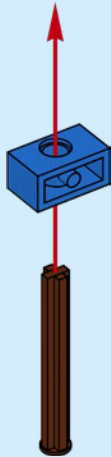

10

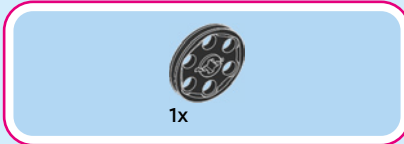
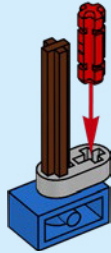

11





1x

12

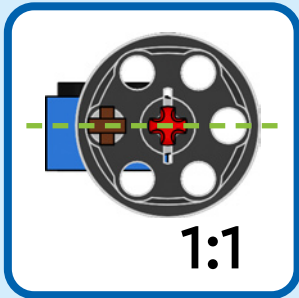
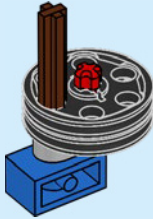

1:1



1x

13

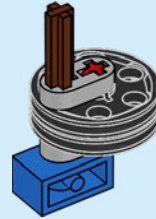

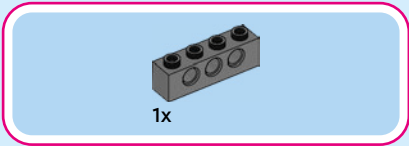

14

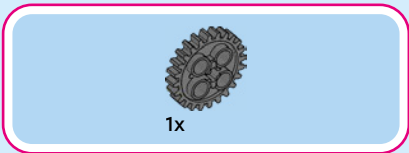
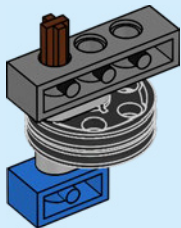

15

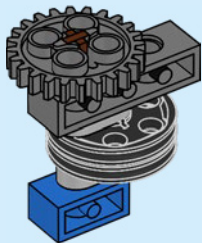

16

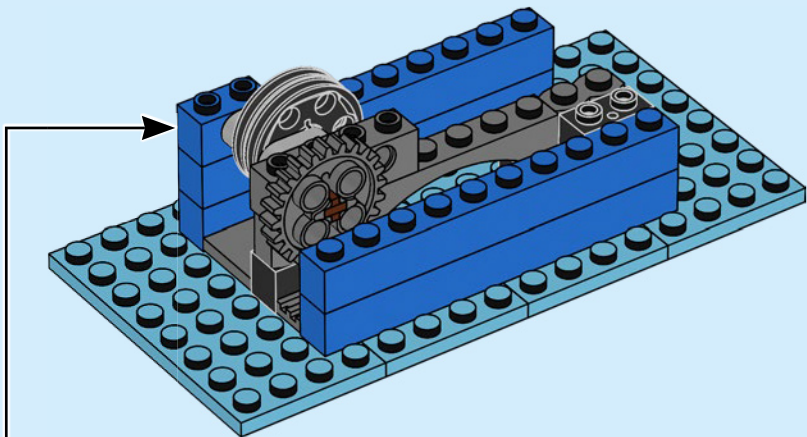

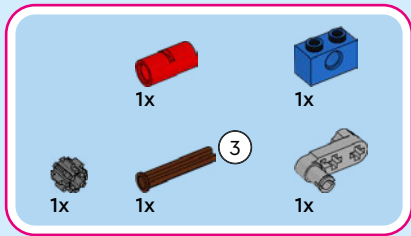

17

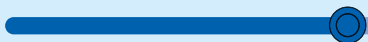
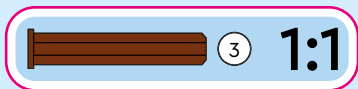
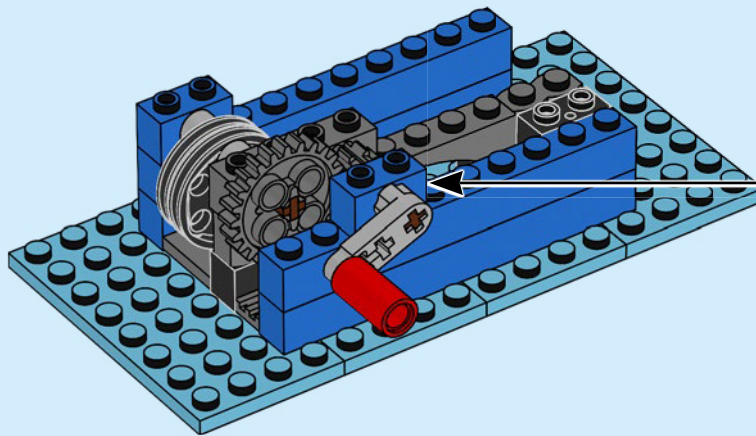
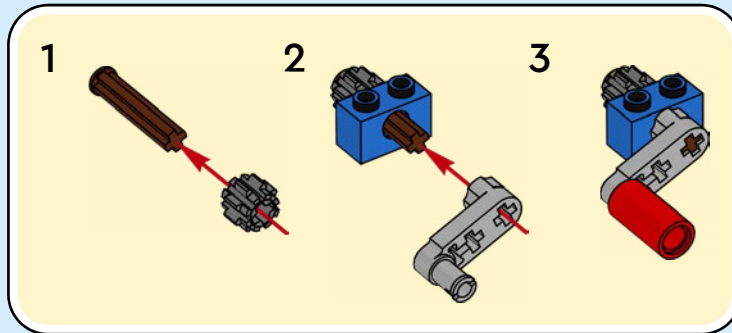

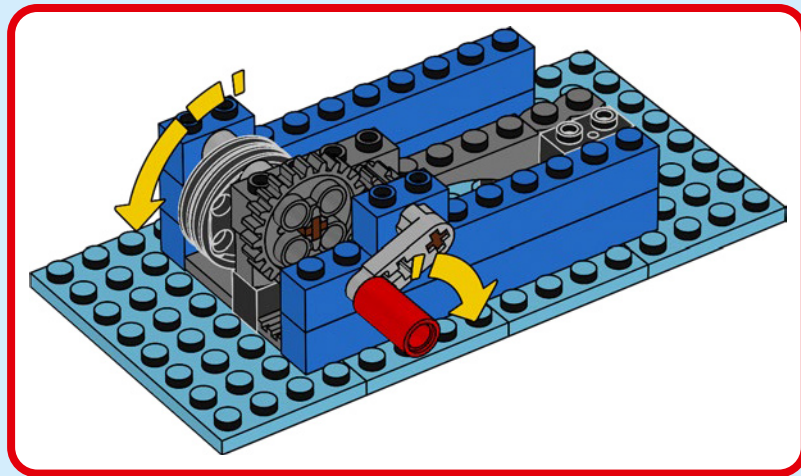

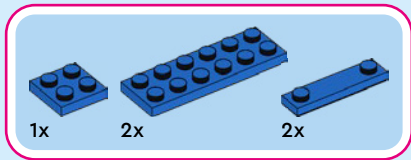

18

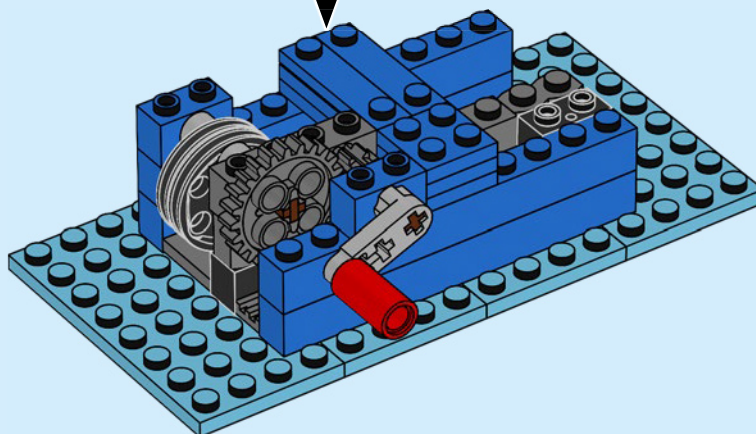
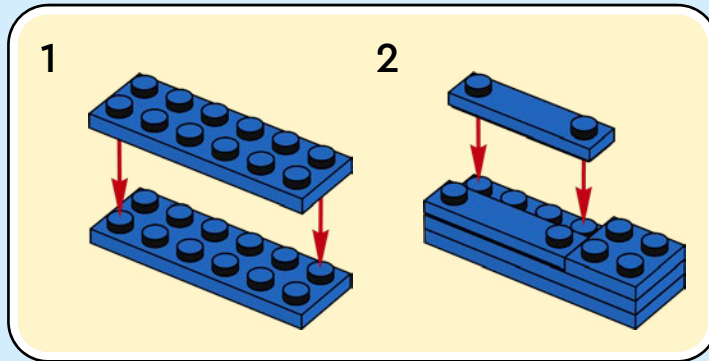



2x

19

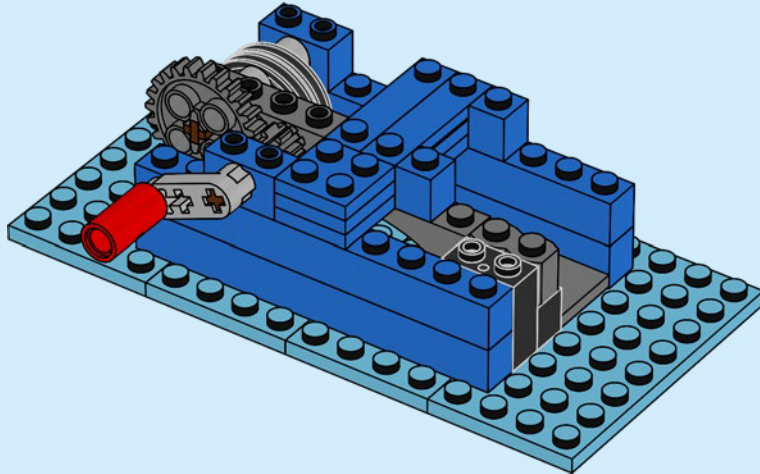

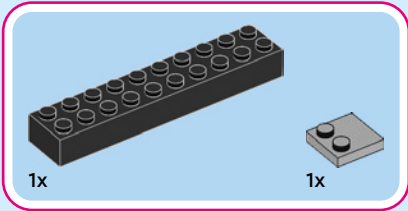
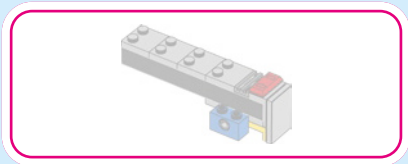

20

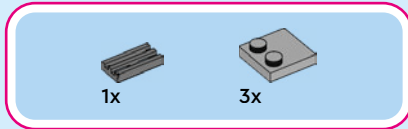
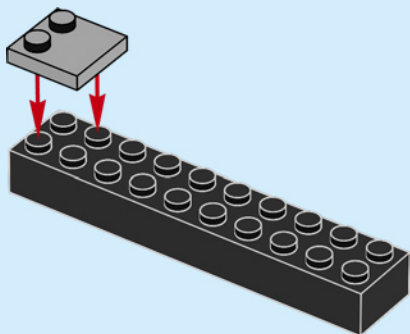

21

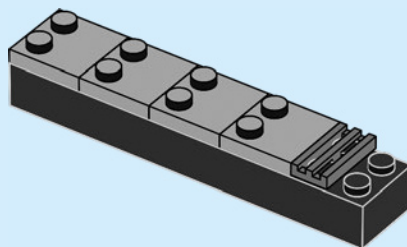

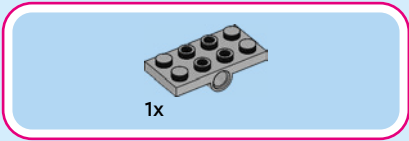

22

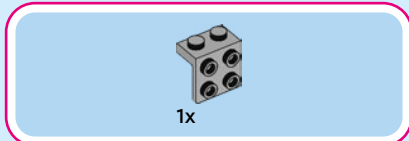
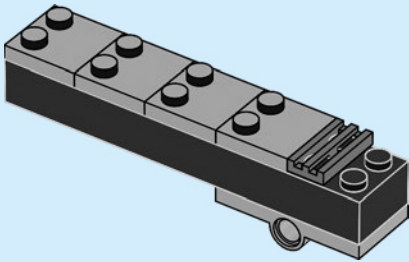

23

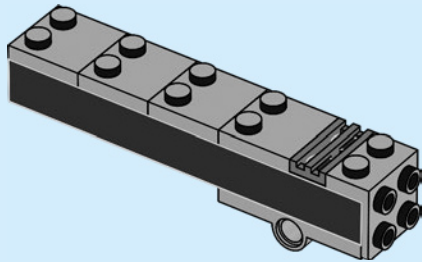



1x

24

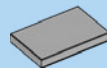
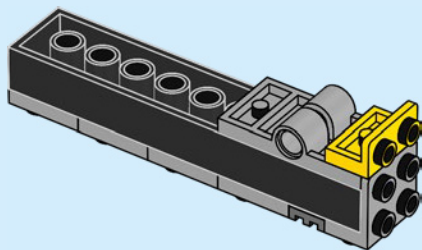

1x

25

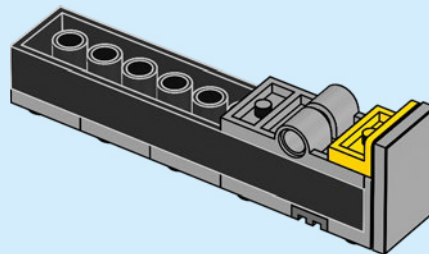



2x

26

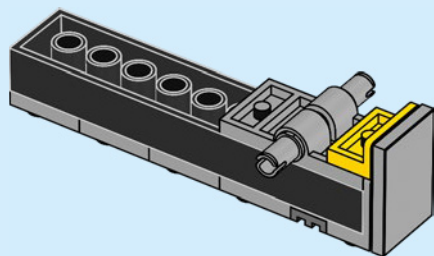

2x

27

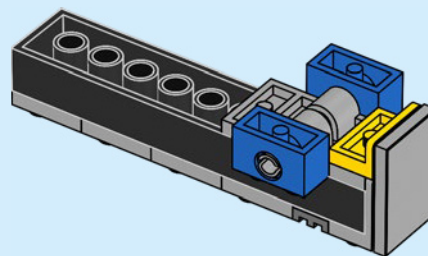



1x

28

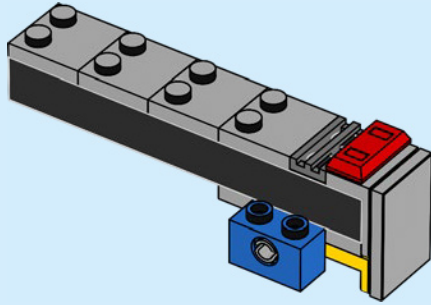

29

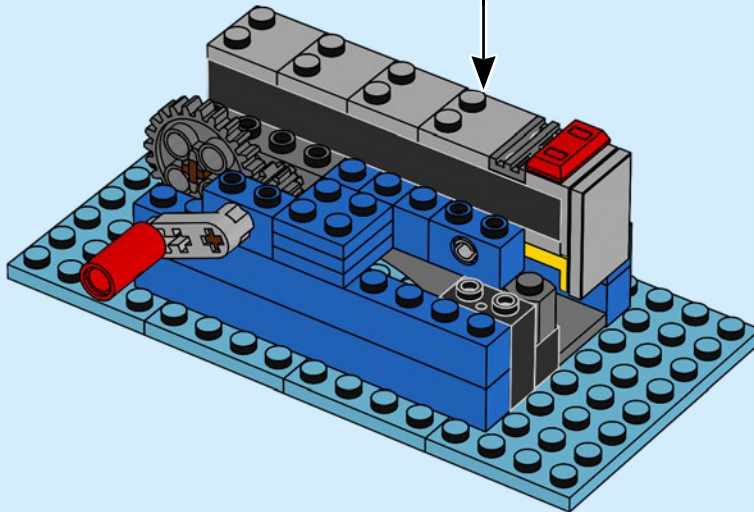



30

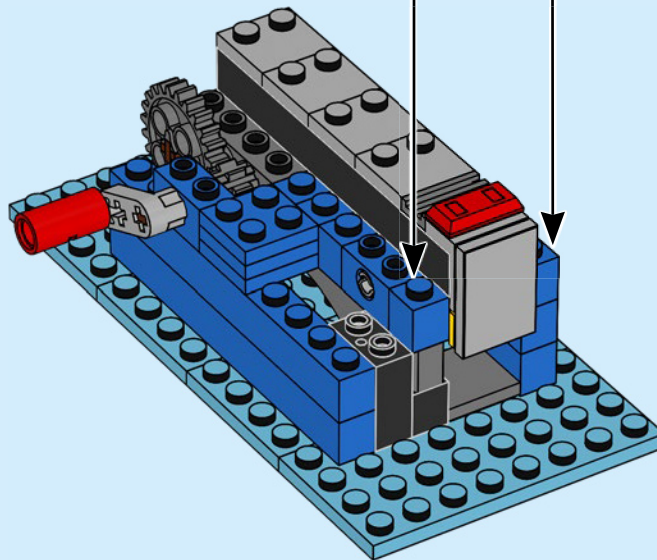
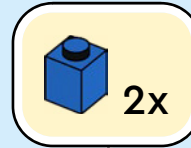



3x

31

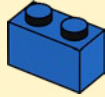

3x

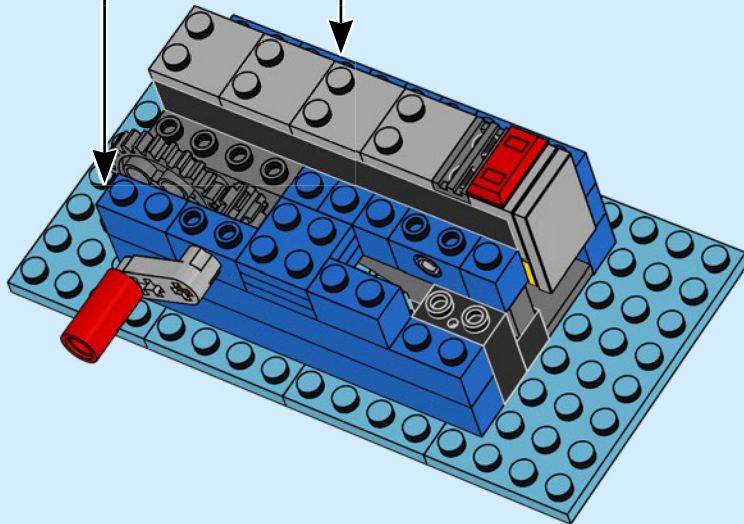

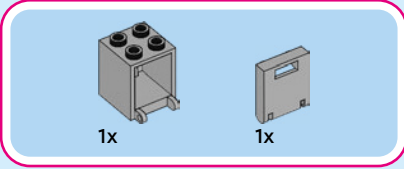
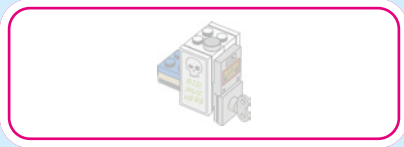

32

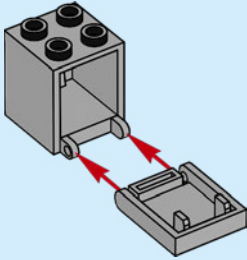

33

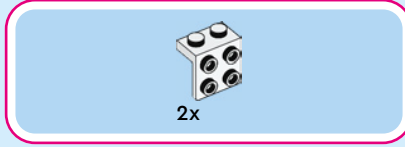
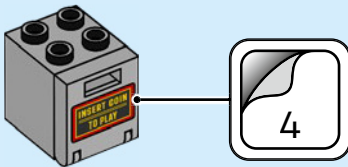

34

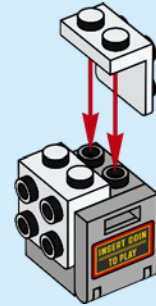

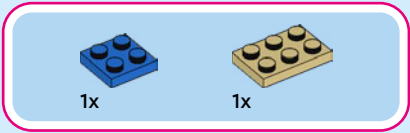

35

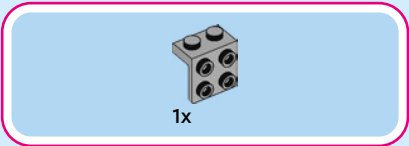
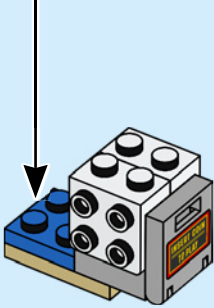
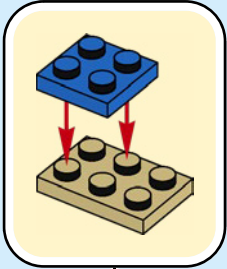

36

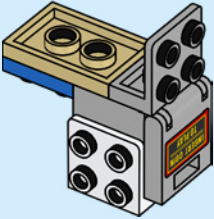

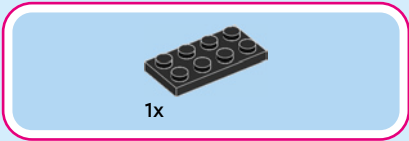

37

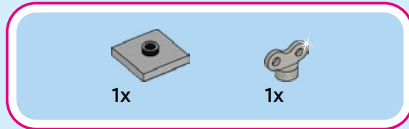
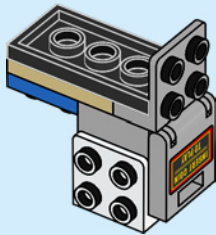

38

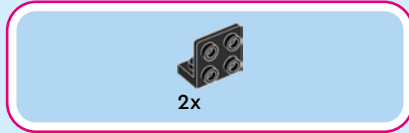
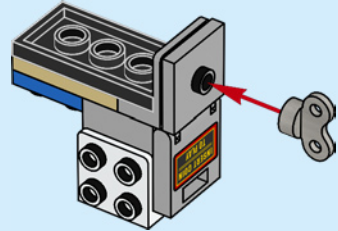

39

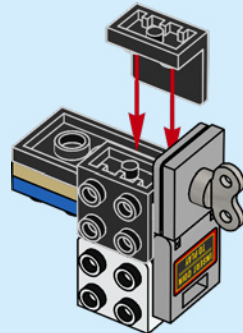

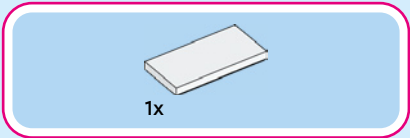

40

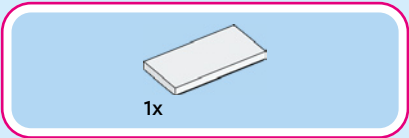
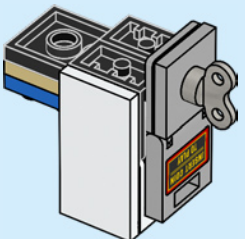

41

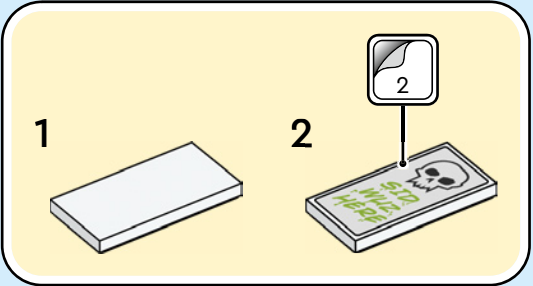

2x

42

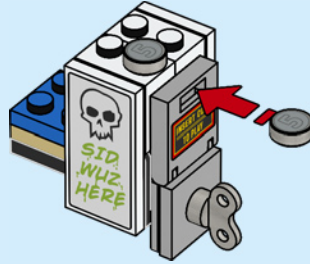

43

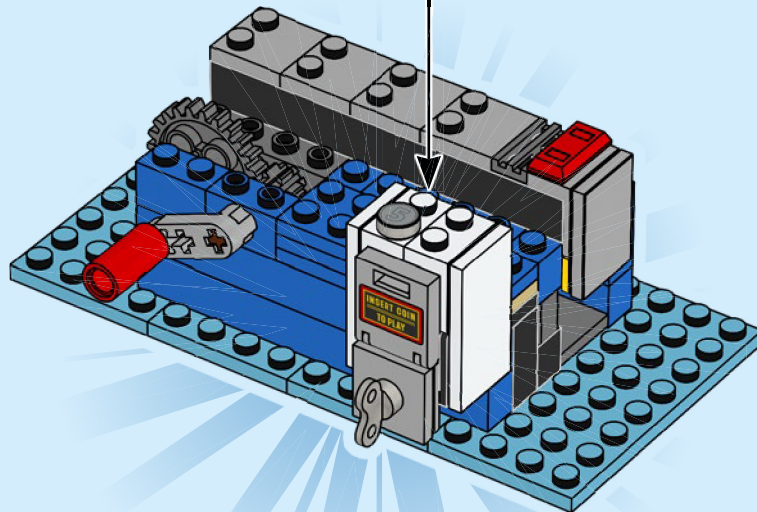



6x

44

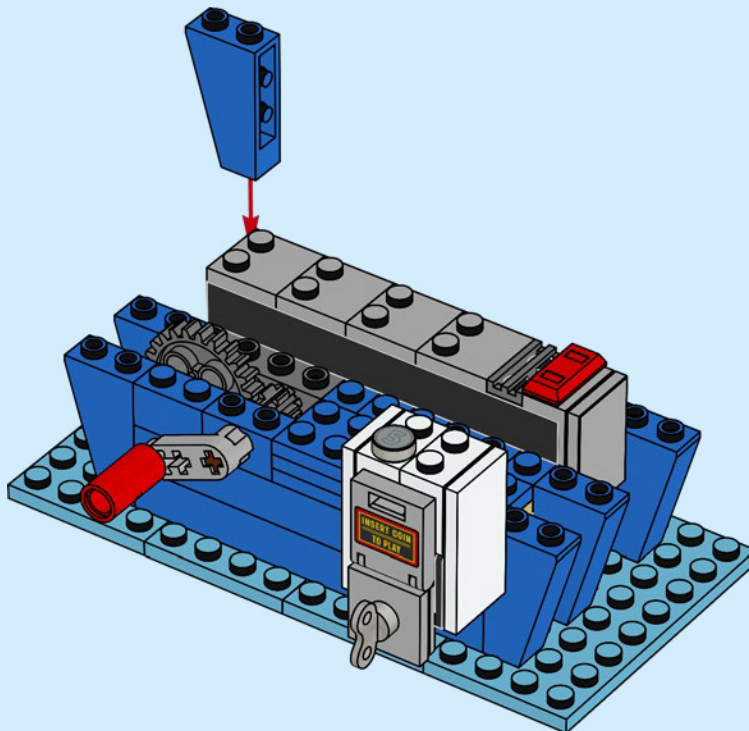

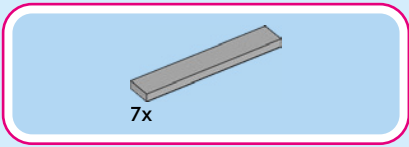

45

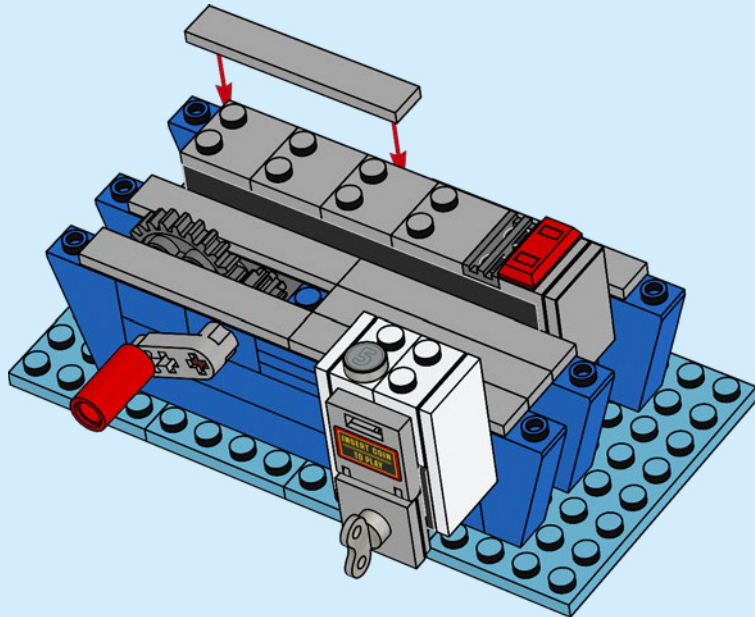

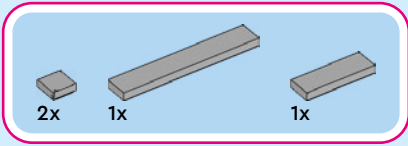

46

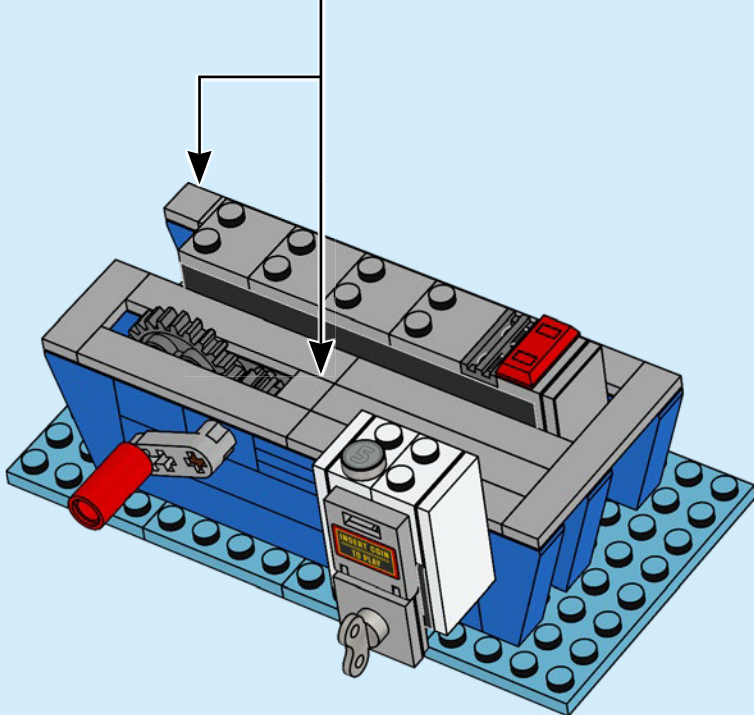
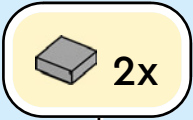

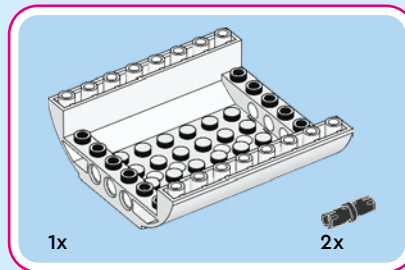
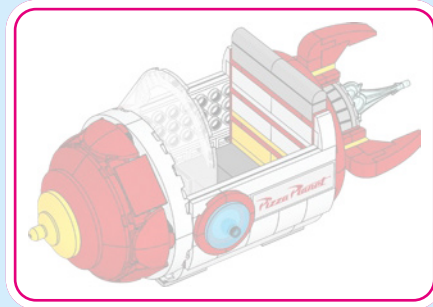

47

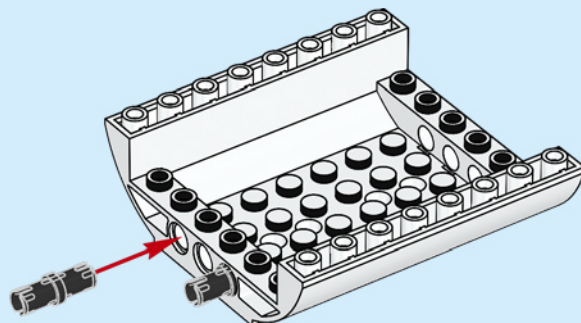

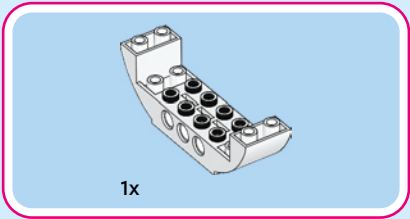

48

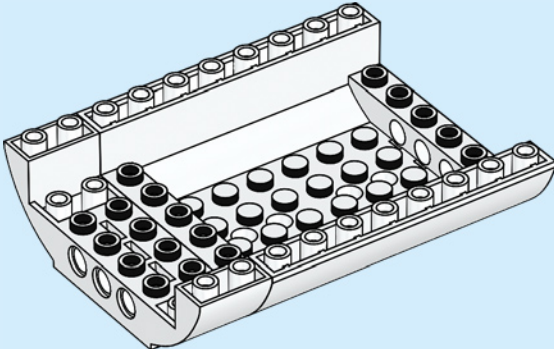

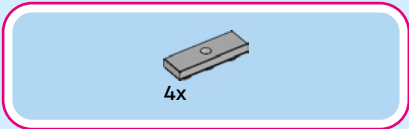

49

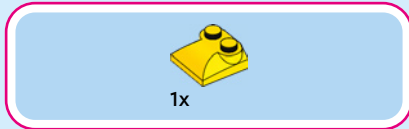
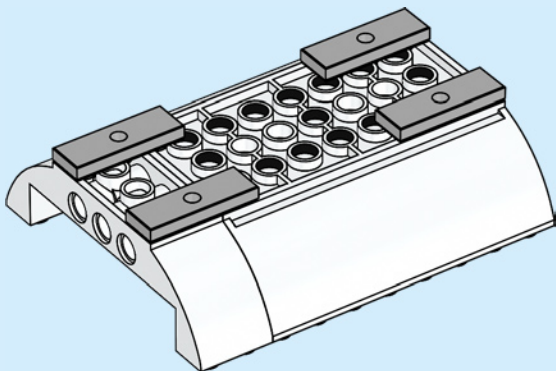

50

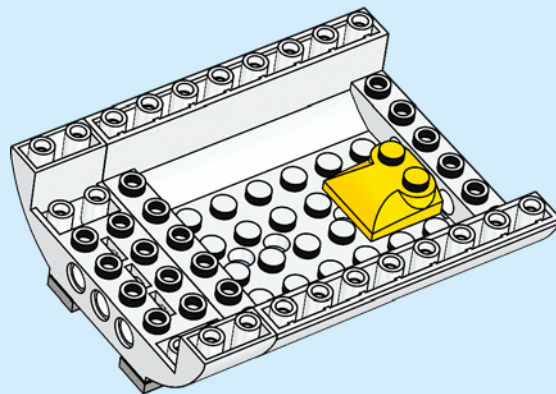
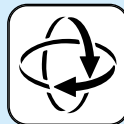

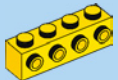

1x

51

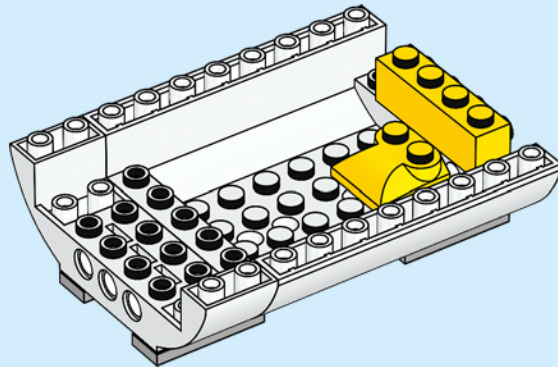

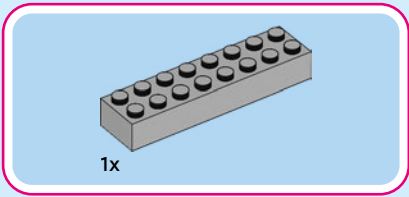

52

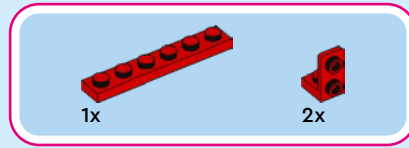
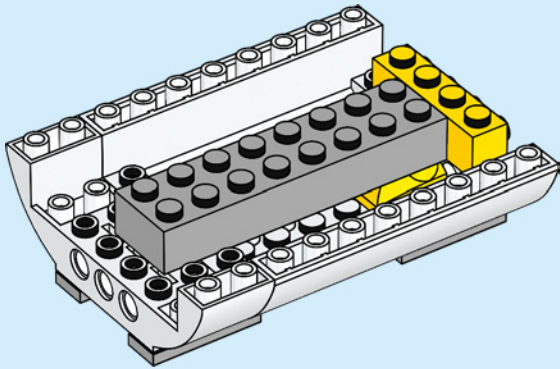

53

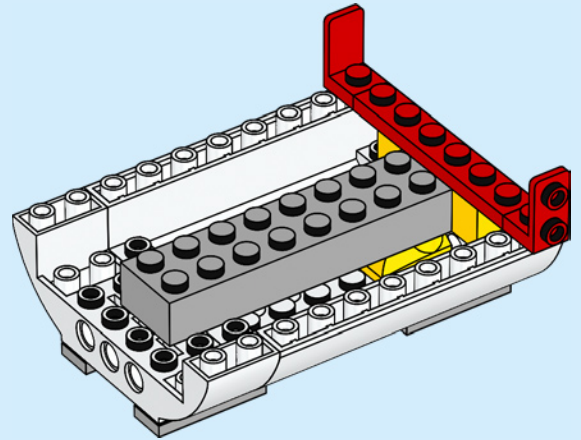

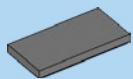

8x

54

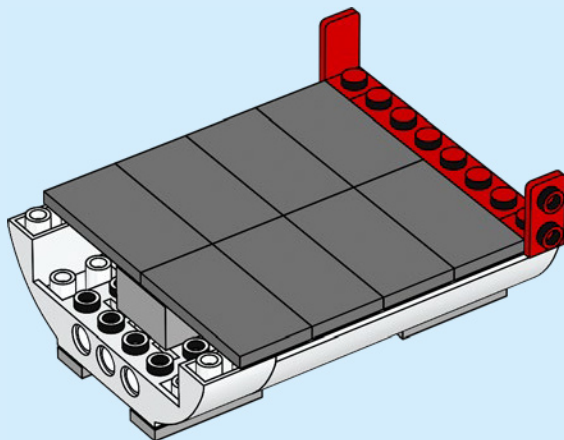

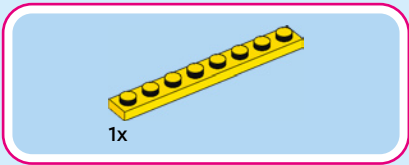

55

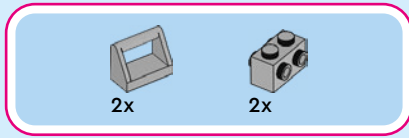
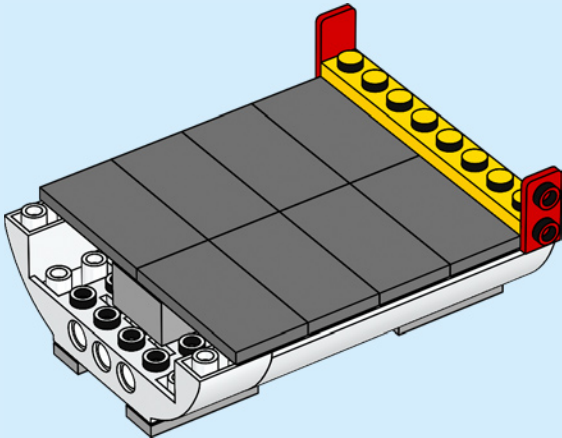

56

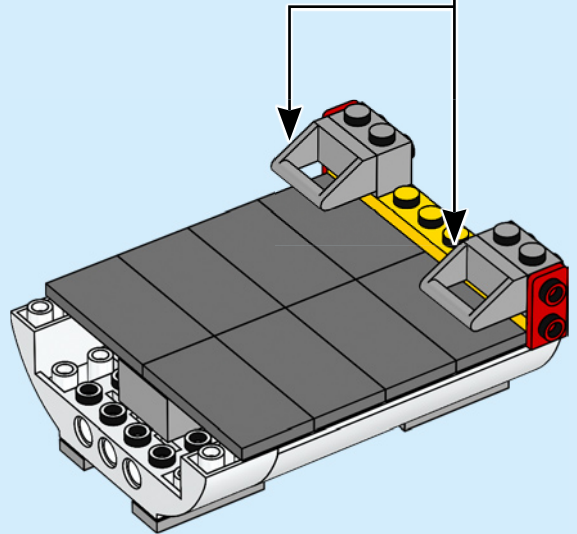
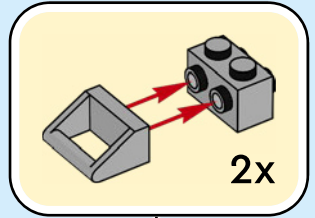

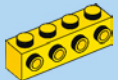

1x

57

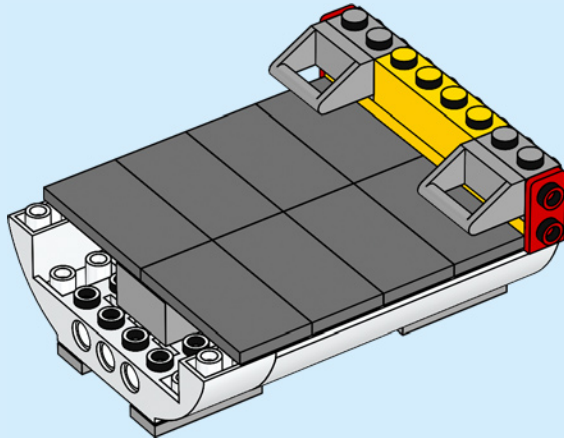

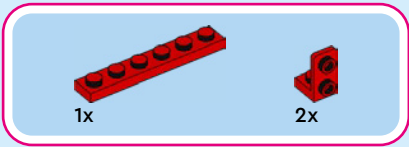

58

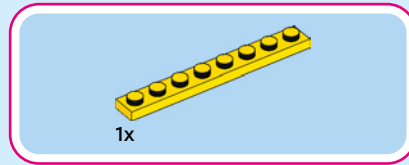
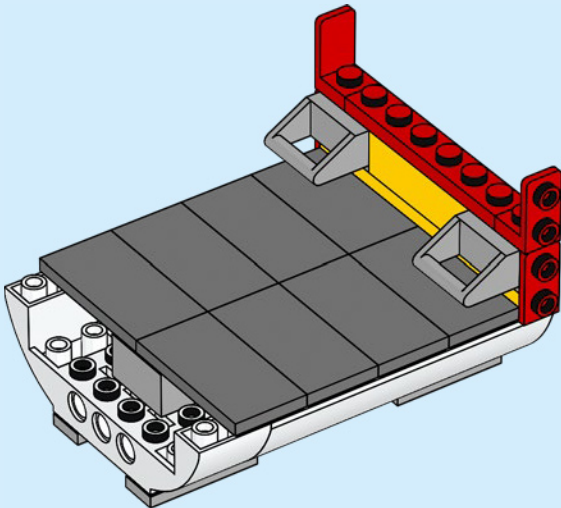

59

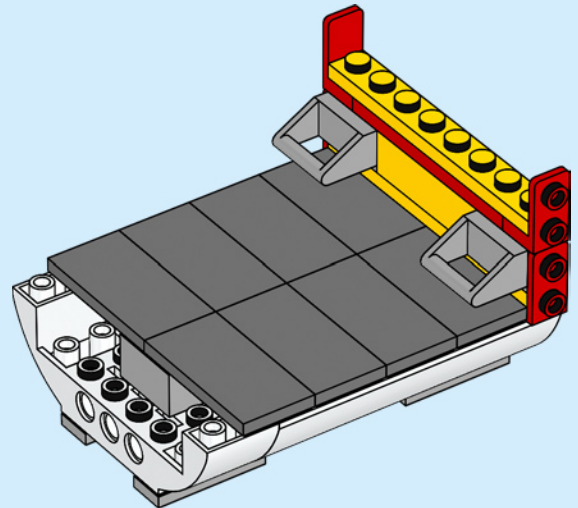

2x 2x 2x

60

2x

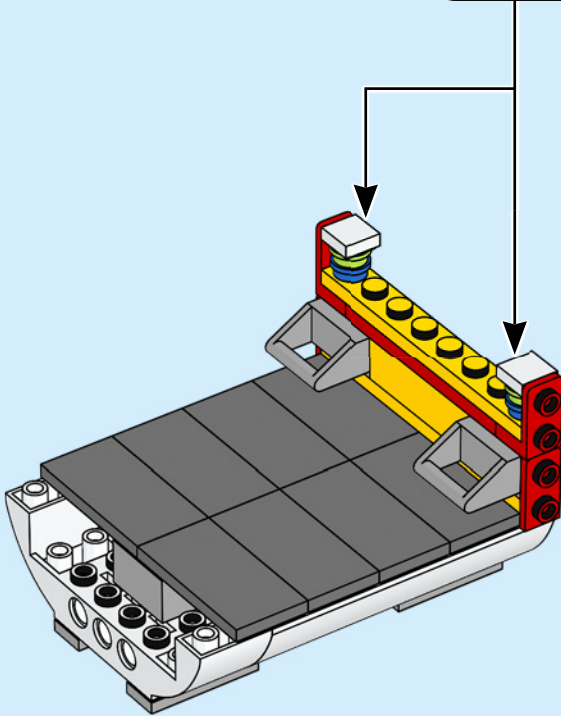

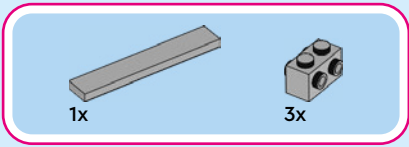

61

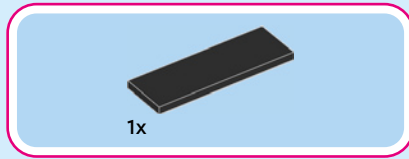
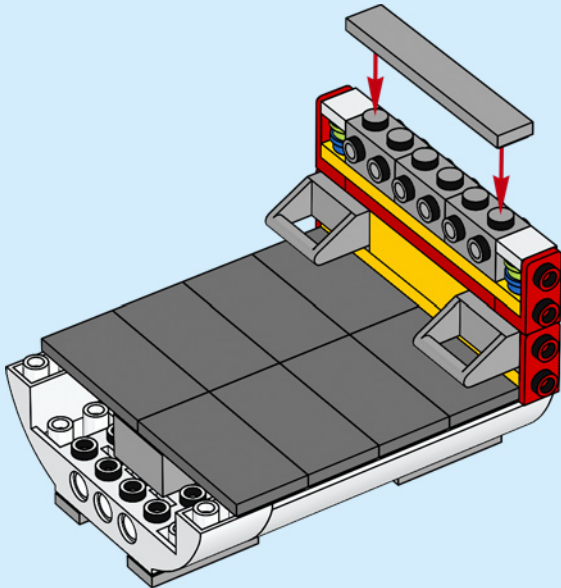

62

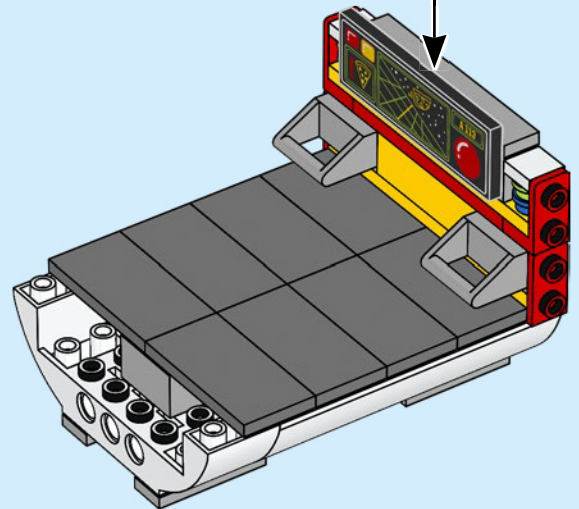
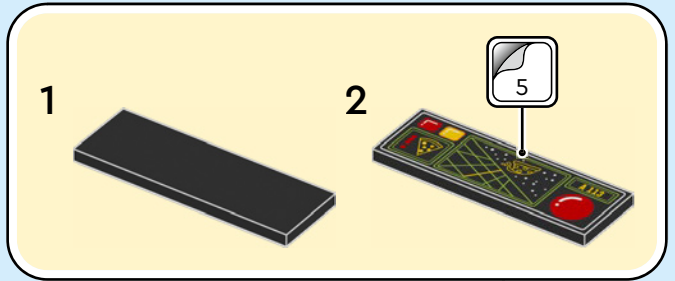

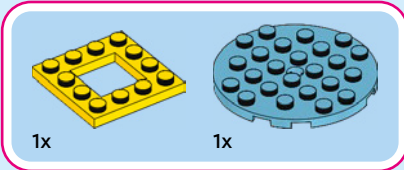
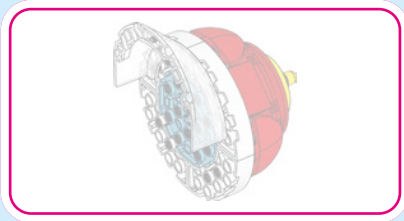

63

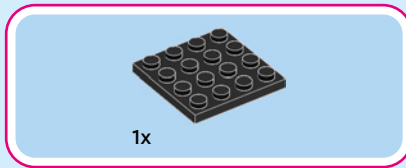
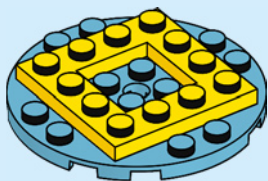

64

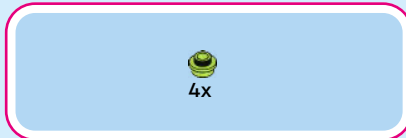
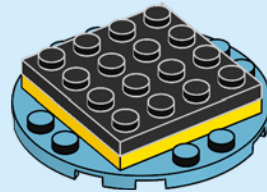

65

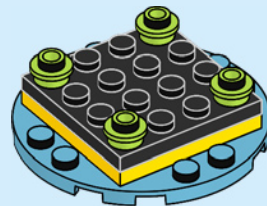



1x

66

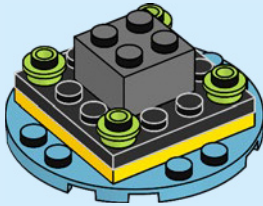

4x

67

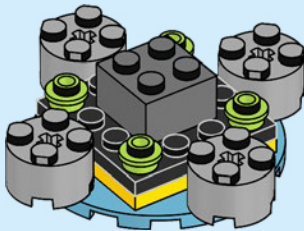

4x

68

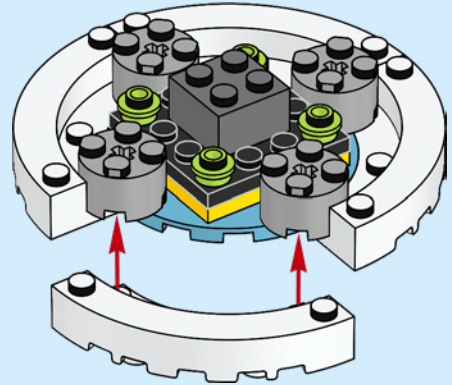

4x

69

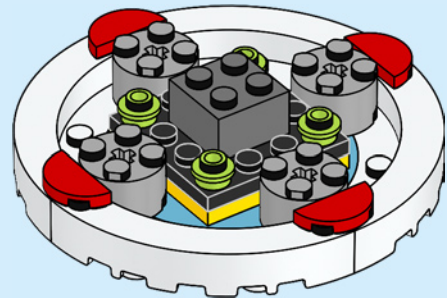



4x



8x



8x



4x



8x



4x

70

1

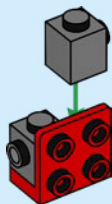

2

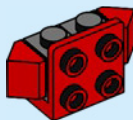

3

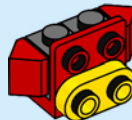

4

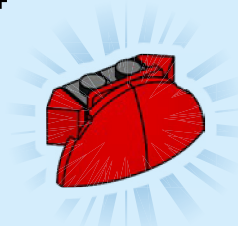

4x

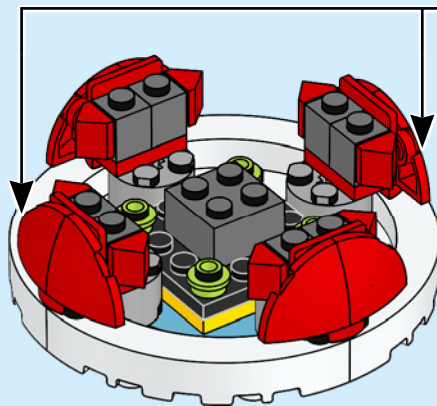

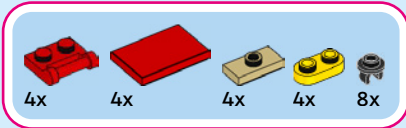

71

1

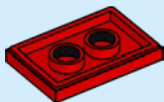

2



3



4

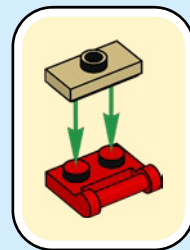

4x

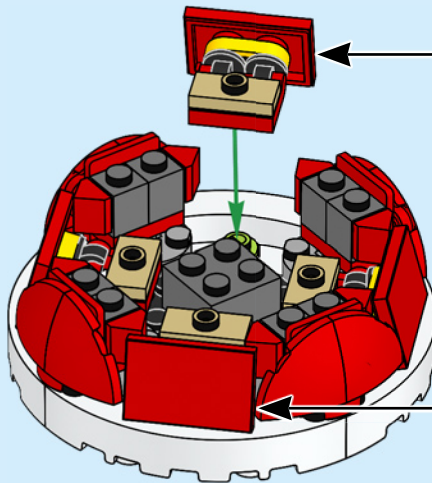

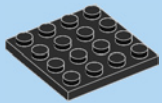

1x

72

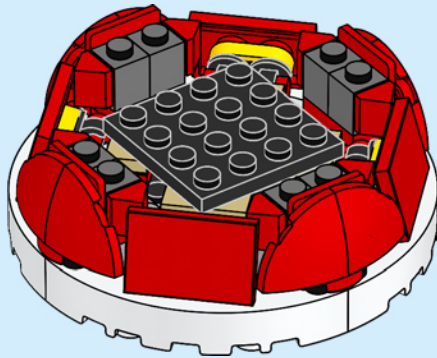

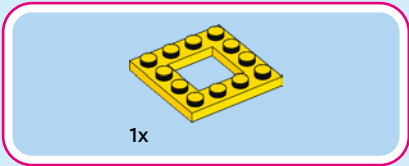

73

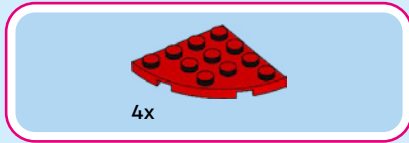
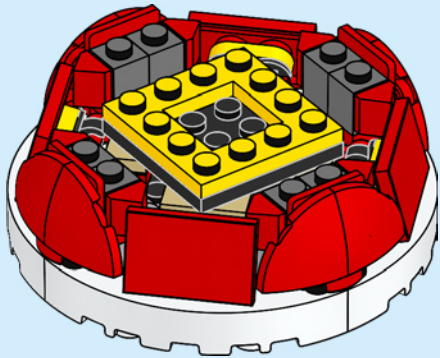

74

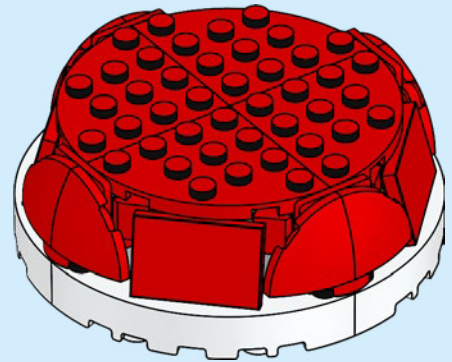

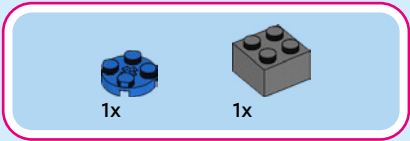

75

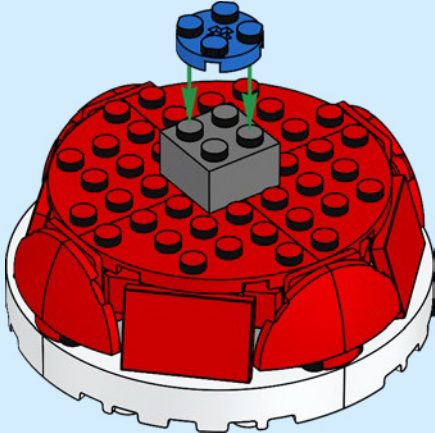

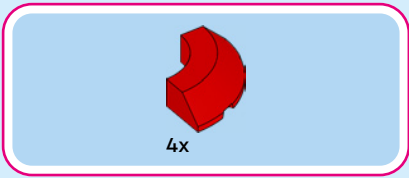

76

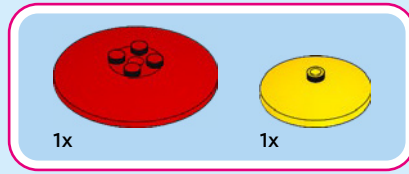
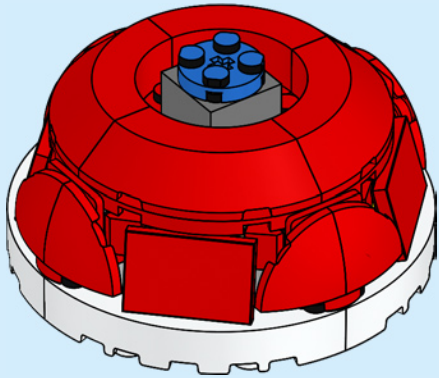

77

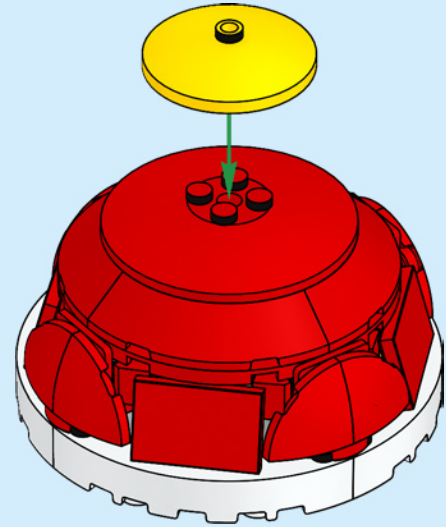



1x



1x

78

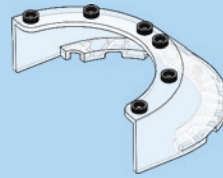
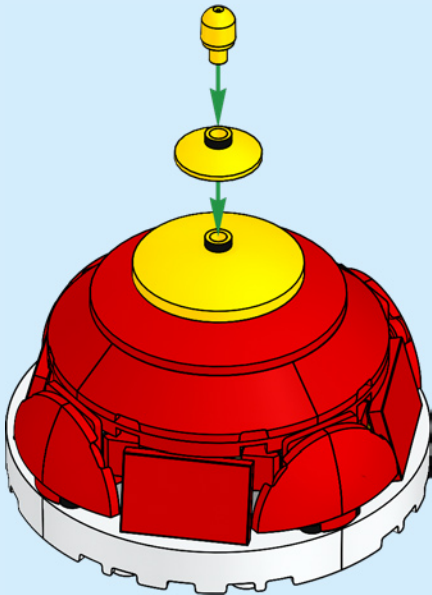

1x

79

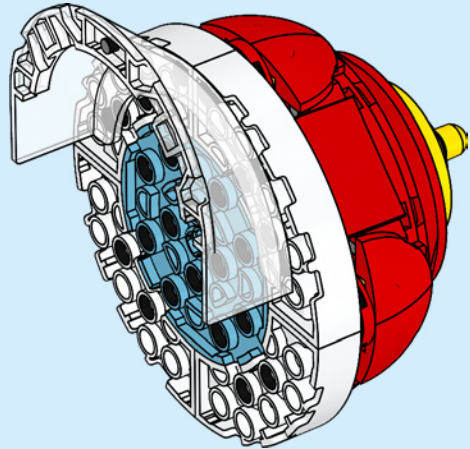

80

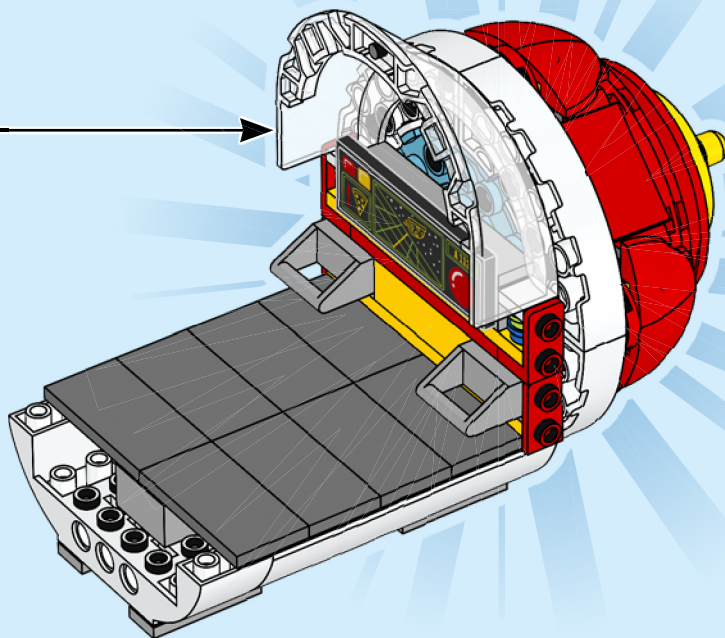

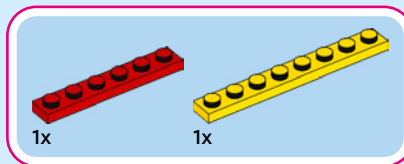
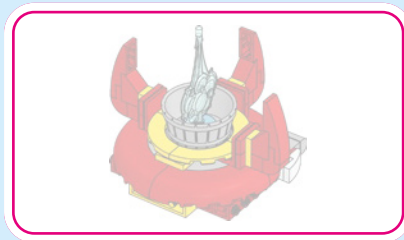
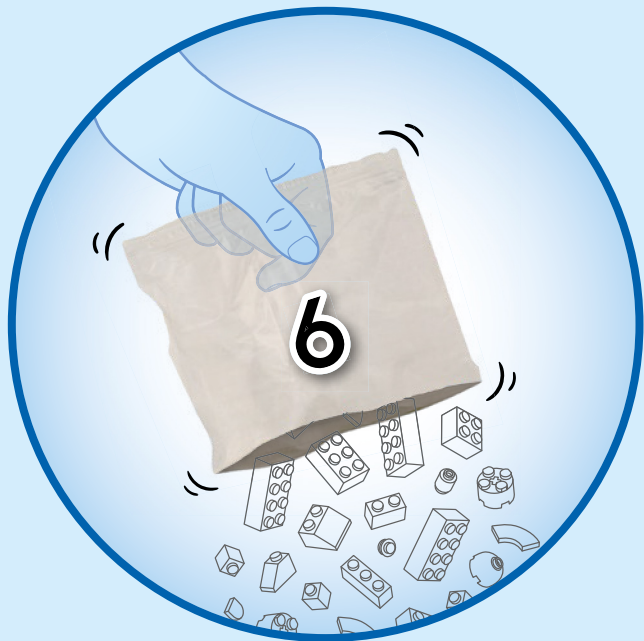

81

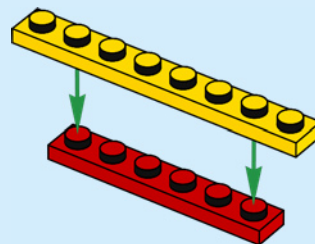



2x

82

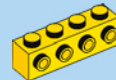
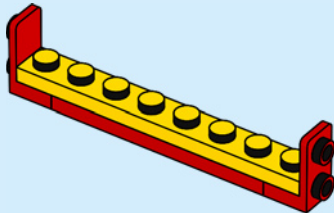

2x

83

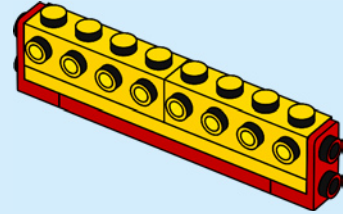

1x



2x

84

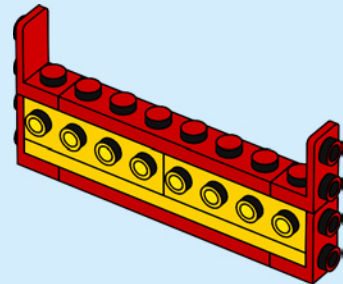

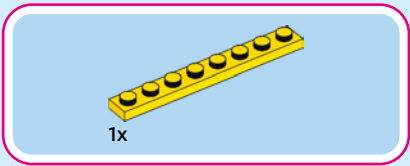

85

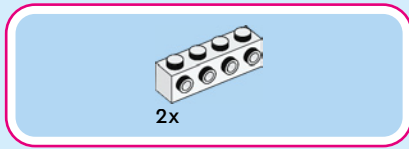
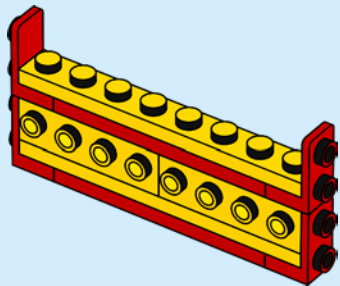

86

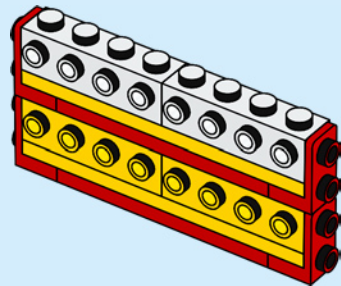

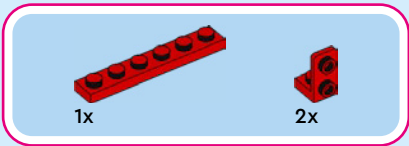

87

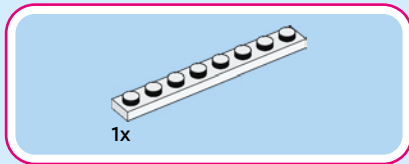
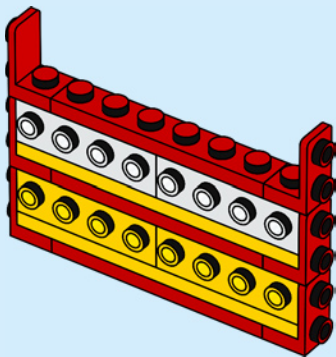

88

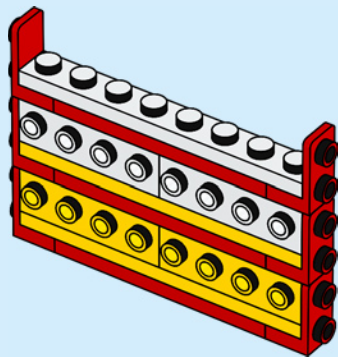



2x

89

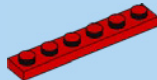
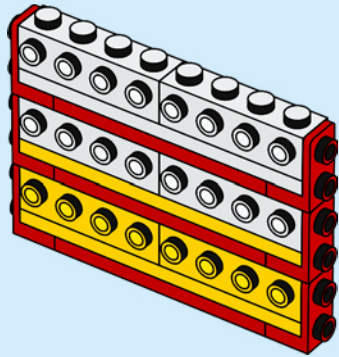

1x



2x

90

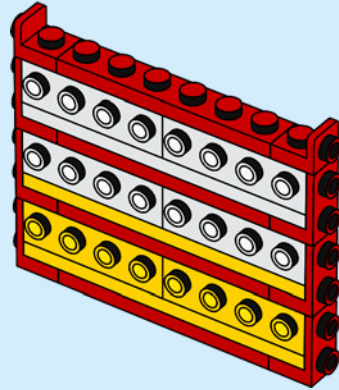

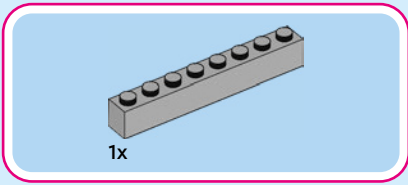

91

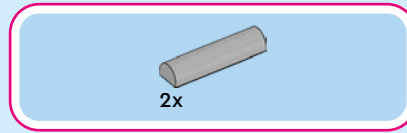
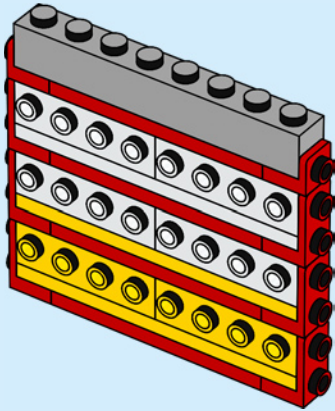

92

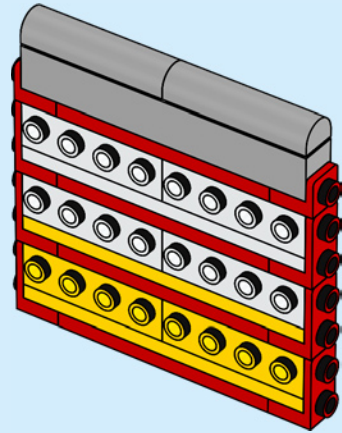



2x



2x

93

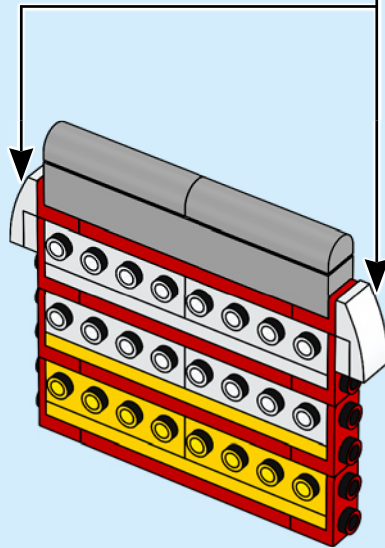
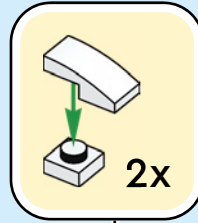

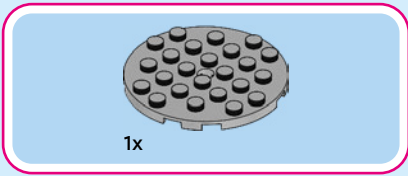

94

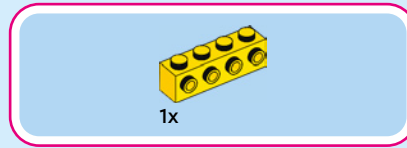
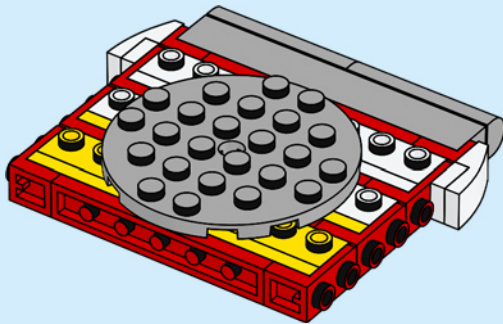

95

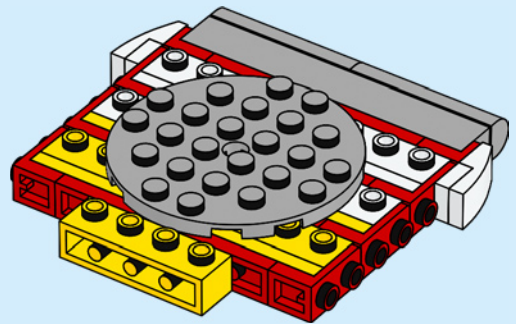



4x

96

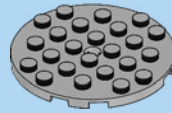
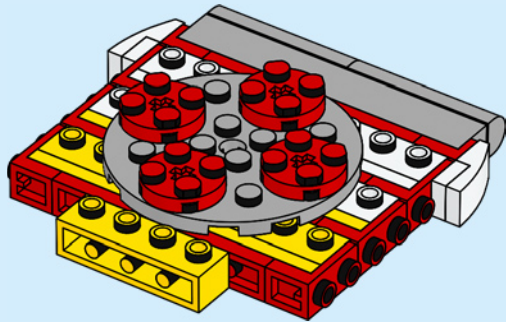

1x

97

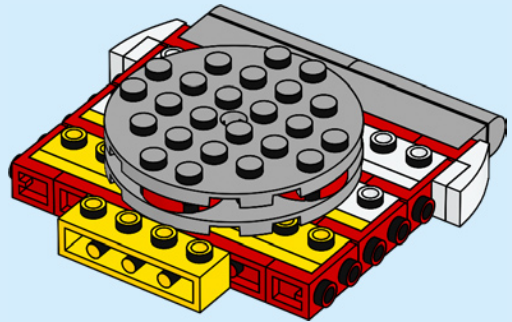

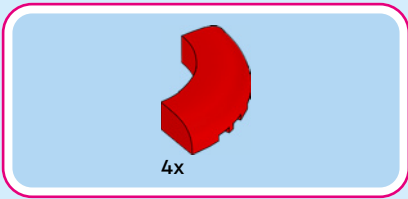

98

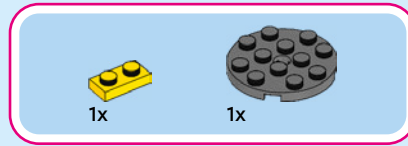
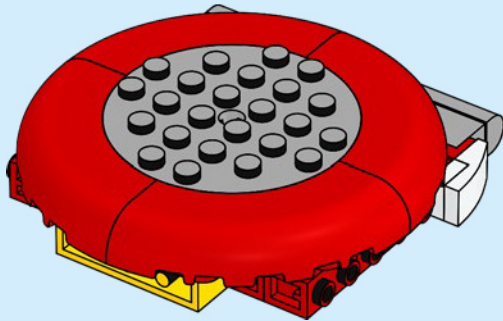

99

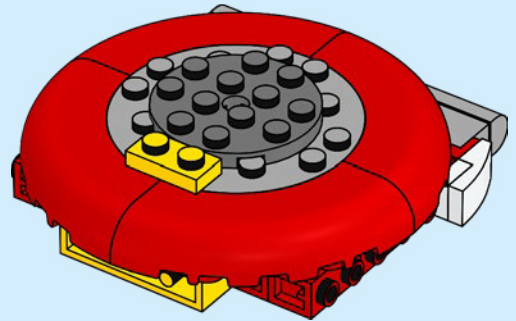



3x



3x



3x



3x



3x



3x

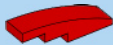

3x



6x

100

1

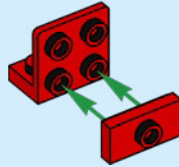

2

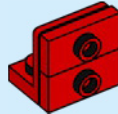

3

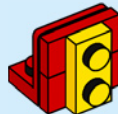

4

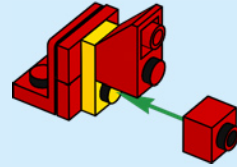

5

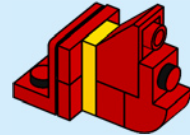

6

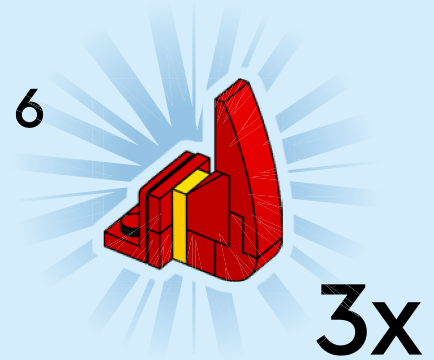

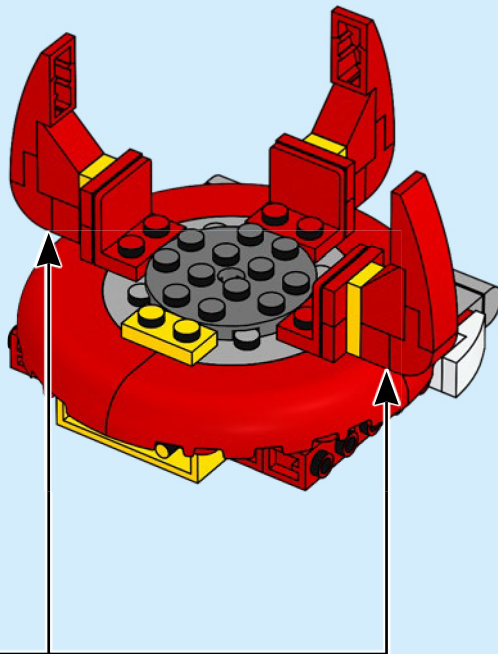



4x

101

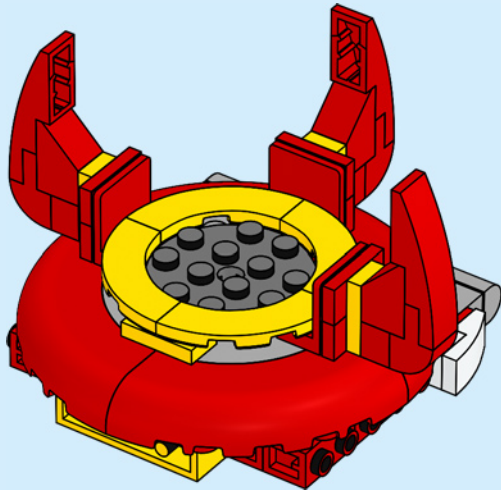

1x

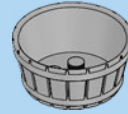

1x

102

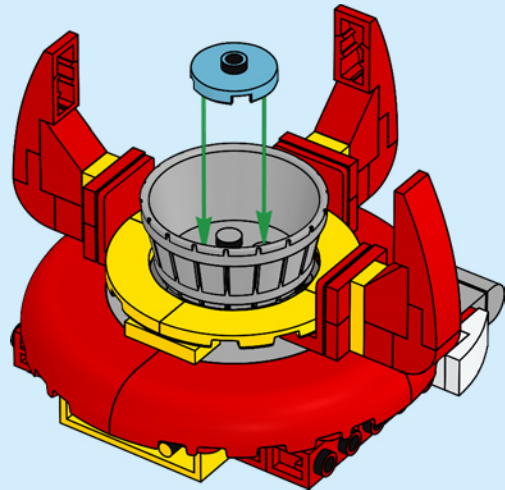



1x

103

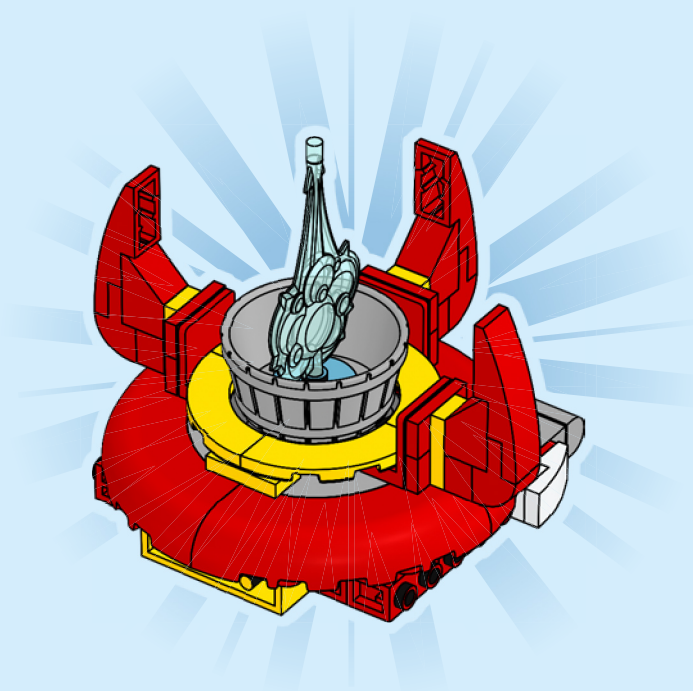

104

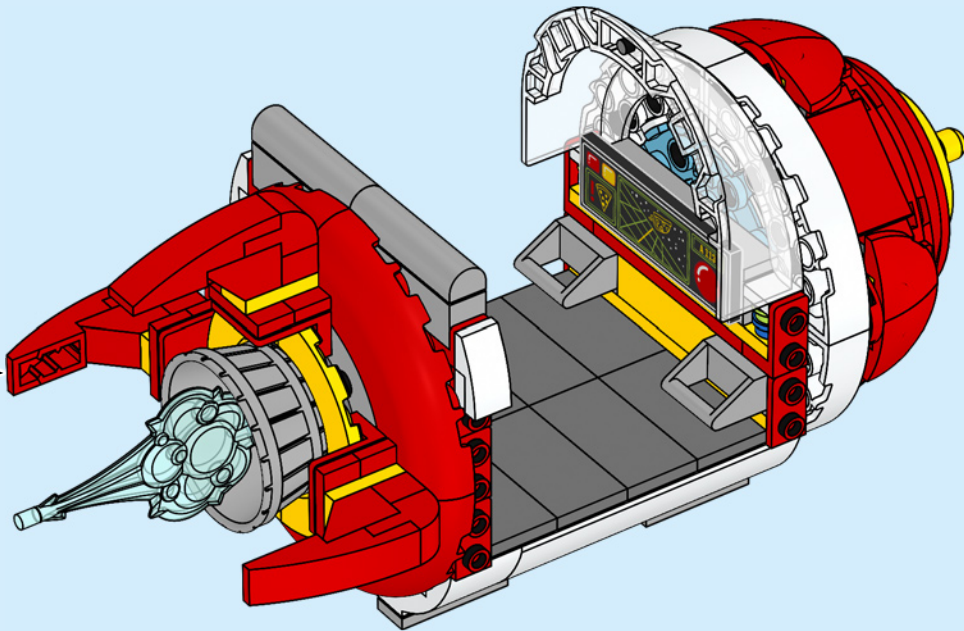

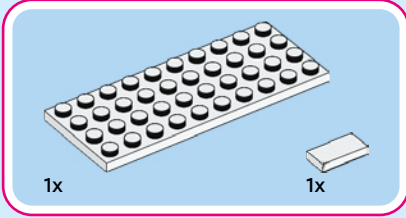
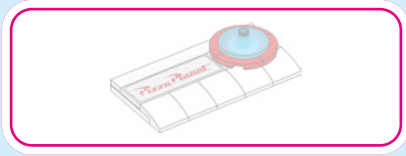

105

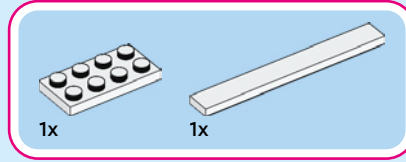
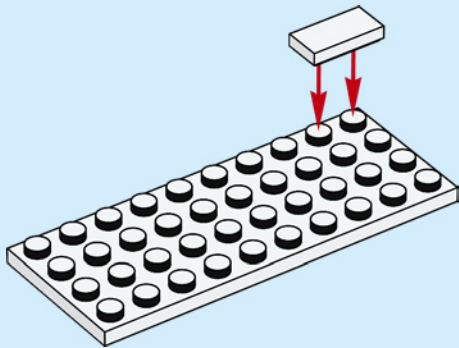

106

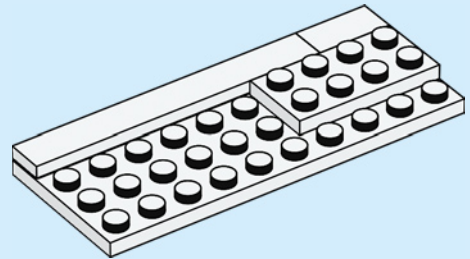

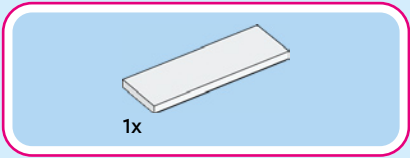

107

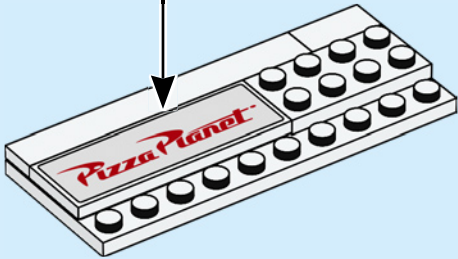
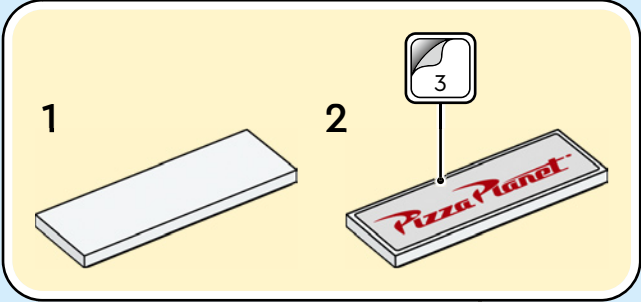



5x

108

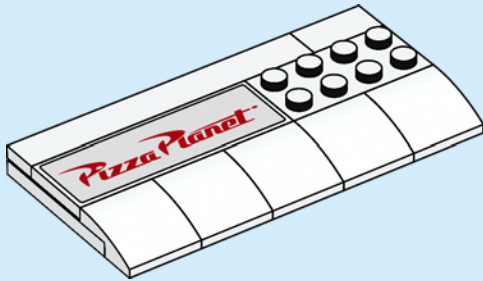

1x



1x

109

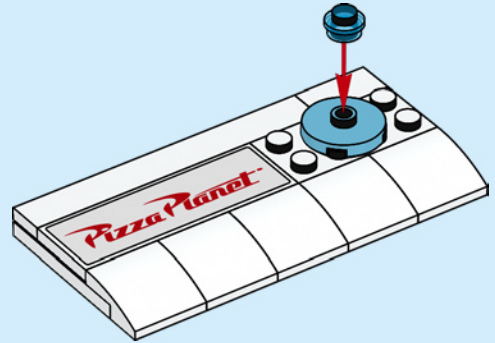



4x

110

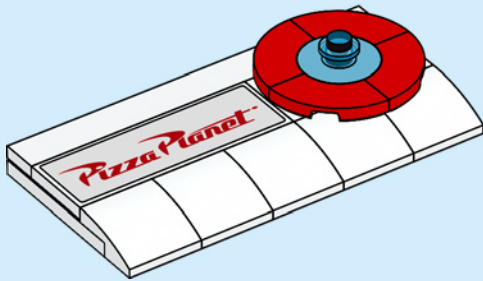

1x

111

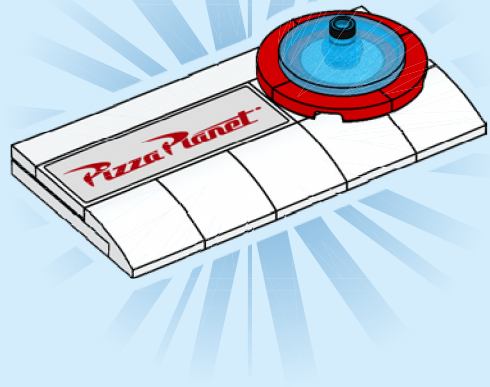

112

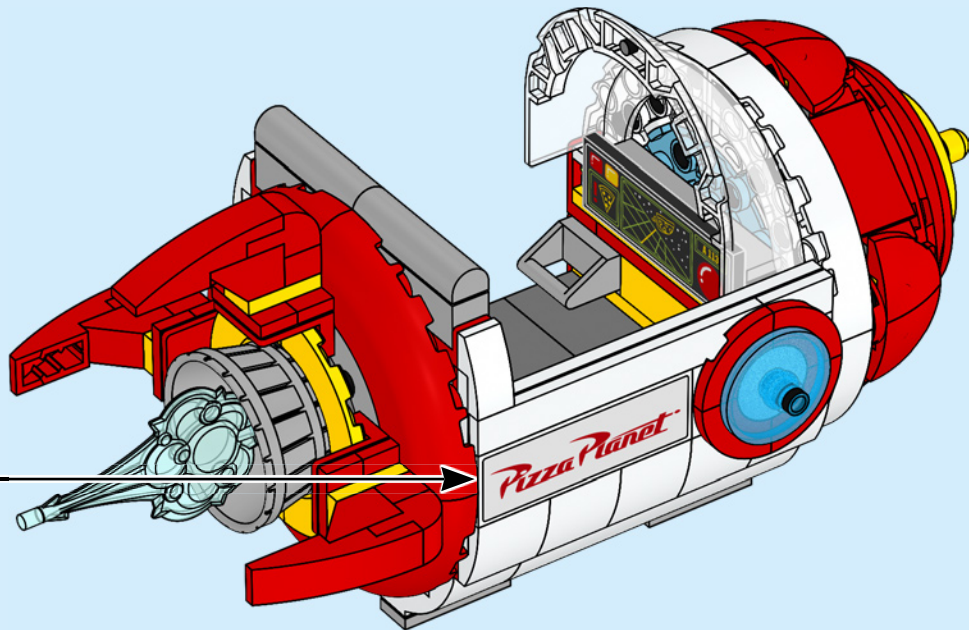

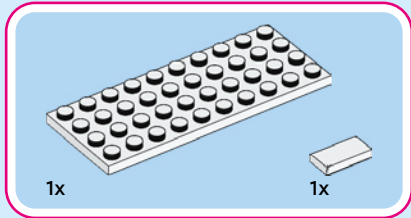
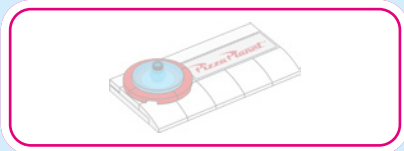

113

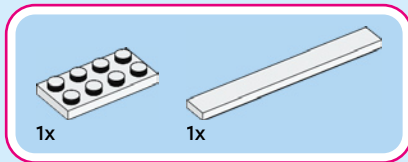
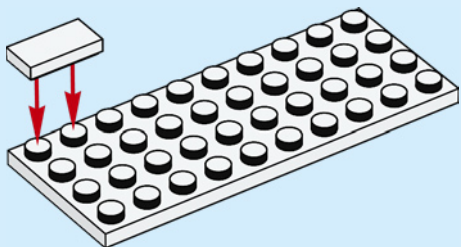

114

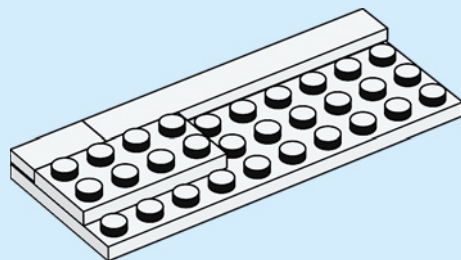

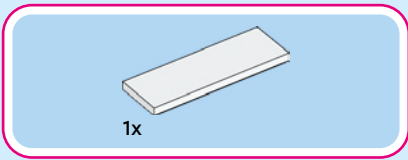

115

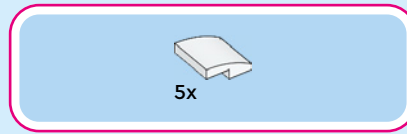
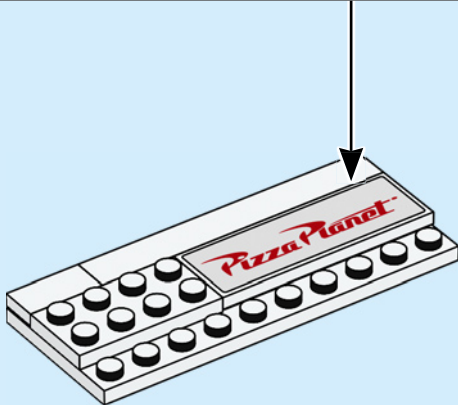
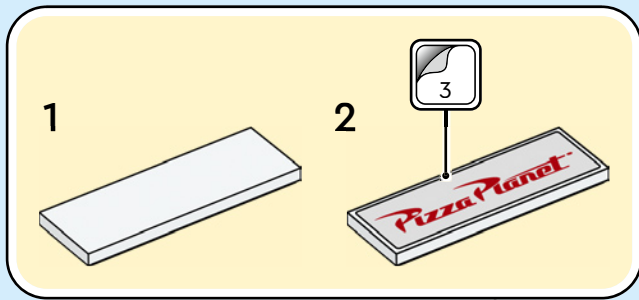

116

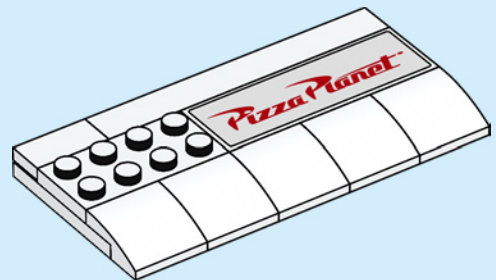



1x



1x

117

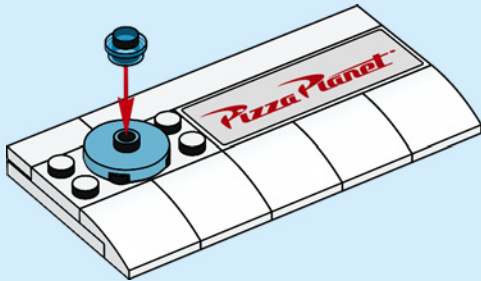

4x

118

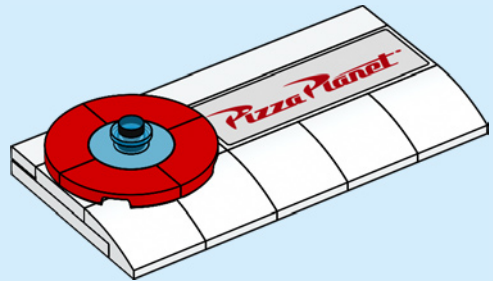

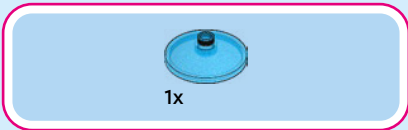

119

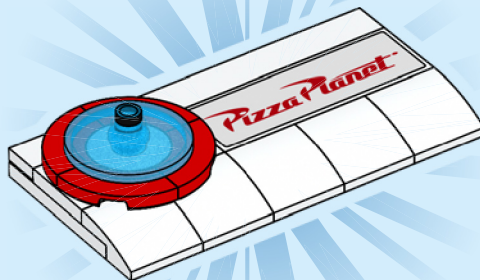

120

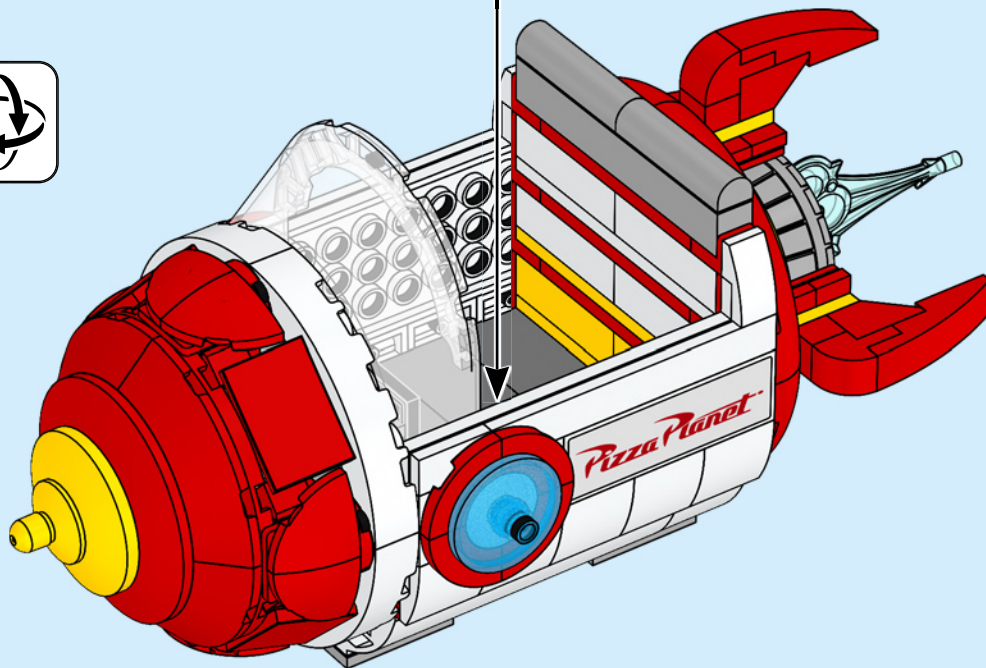

121

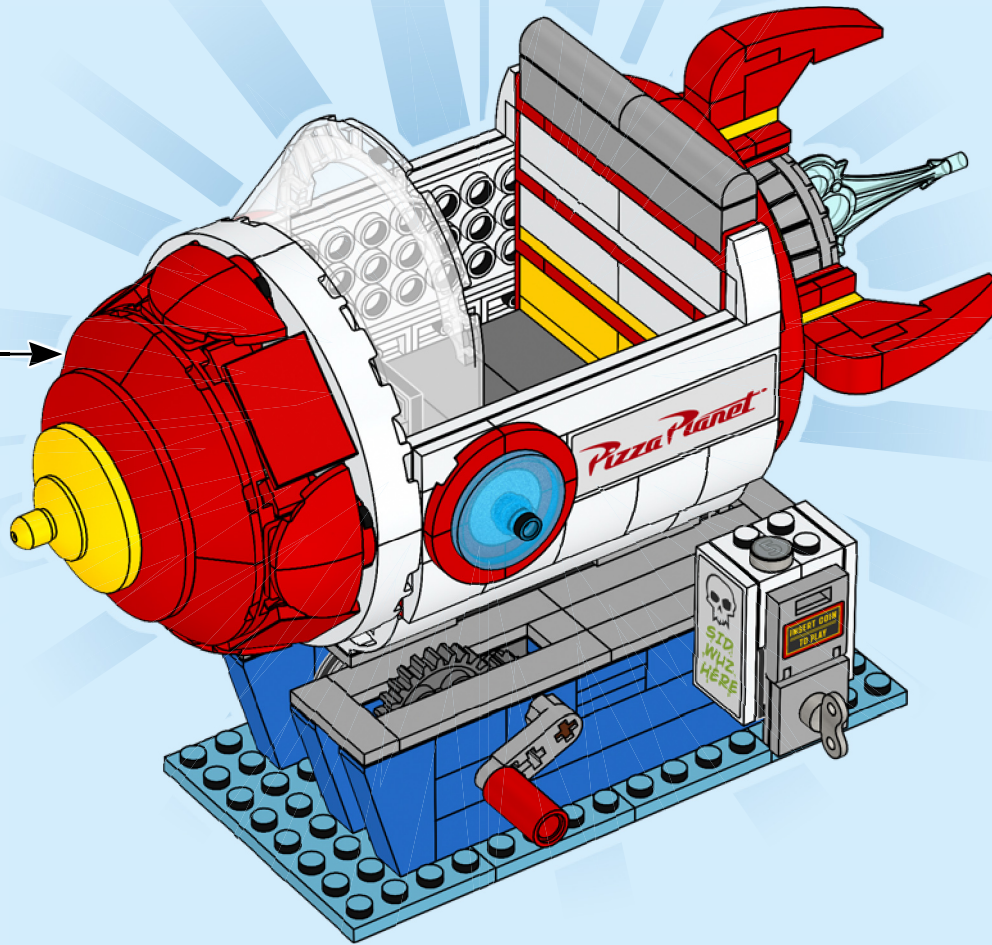

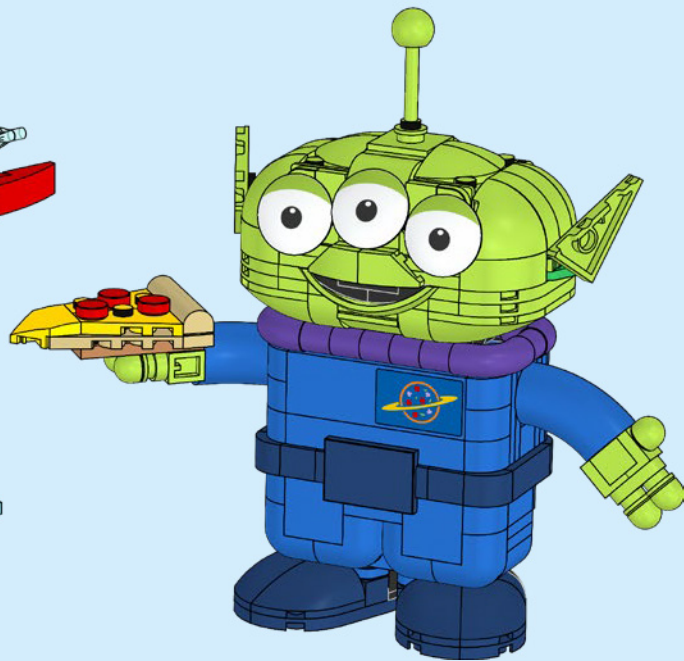
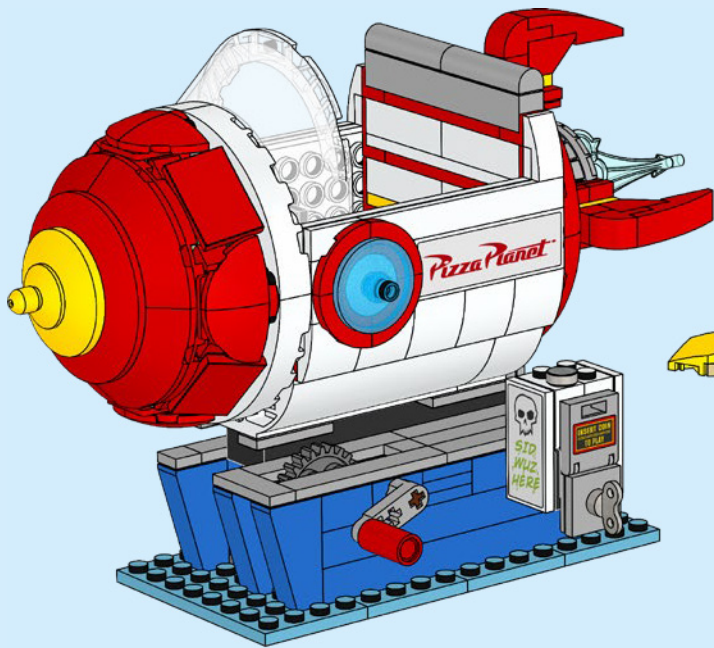

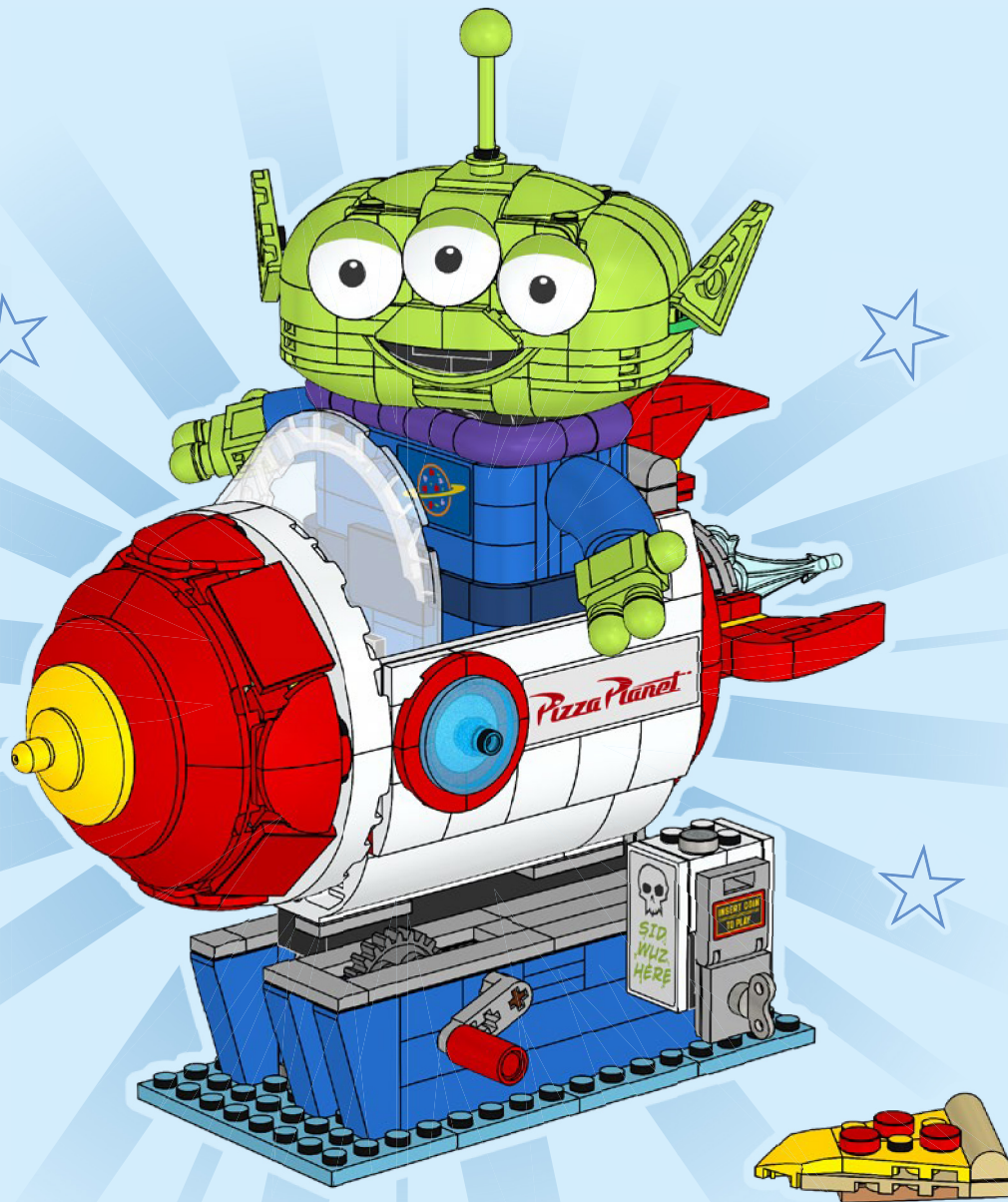



Disney

Disney
**Winnie
the Pooh**

43305



Disney
TIM BURTON'S
**THE
NIGHTMARE
BEFORE
CHRISTMAS**

43288



Disney · PIXAR

UP

43290



Disney · PIXAR

**TOY
STORY**

43307



© Disney

© Disney/Pixar

© Disney. Winnie the Pooh elements are based on the "Winnie the pooh" works by A.A. Milne and E.H. Shepard.

[LEGO.com/disney](https://www.lego.com/disney)



**Rebuild
the
World™**



2x
302401

2x
307001

2x
6345886

4x
6449593

4x
6330191

2x
403201

3x
6597176

2x
306901

2x
6034044

1x
6313115

2x
6117940

4x
6450820

10x
6047220

1x
300301

4x
4143254

2x
370101

2x
302001

2x
4560178

2x
6332042

1x
6265642

4x
6617727

1x
346001

2x
416201

2x
4503008

1x
6458576

1x
6177891

1x
6177890

4x
6092587

9x
4114084

10x
4114077

1x
4118790

1x
6375672

1x
4113233

3x
6284574

6x
614121

8x
6224794

3x
6397571

10x
6345637

2x
6249907

4x
6516544

2x
6399645

1x
4142865

4x
403221

8x
6547139

1x
6173126

3x
366521

3x
6544439

6x
6092565

1x
6394880

7x
6001806

4x
4226876

8x
6310198

1x
4220515

4x
6617726

4x
6191995

4x
6189130

3x
6583512

6x
366621

4x
6297811

1x
6156534

2x
614123

4x
6482748

2x
6268862

8x
300523

2x
6290531

1x
403223

8x
4206482

2x
6535451

3x
300423

4x
370023

10x
302323

2x
6308097

8x
6547143

2x
366523

2x
6290532

1x
306923

6x
6567036

4x
6552529

2x
302223

1x
6252060

4x
6488776

2x
306823

5x
6307924

8x
362323

5x
302123

2x
6473702

2x
6292291

1x
4118785

3x
379523

1x
6410028

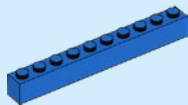

4x
6057905



1x
6518937



2x
614124



8x
6248971



1x
4179095



1x
4179094



1x
4169960



1x
6565418



4x
302324



1x
6185994



1x
4218699



2x
6130007



6x
6469455



5x
4164073



1x
6636769



4x
6382558

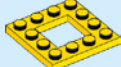

2x
4549896



2x
379524



4x
346024



8x
6534180



10x
6168646



1x
4286267



4x
6572775



2x
6308000



2x
6279875



2x
403226



2x
6542617



1x
6382697



2x
6147050



2x
6000650



2x
6323668



2x
362226



3x
6199908



1x
302126



1x
302026



2x
4142135



5x
366626



2x
4243819



1x
6318582

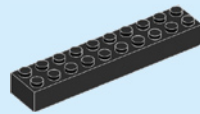

1x
4617860



2x
6253140

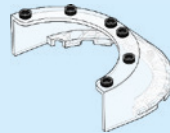

1x
6589819



1x
6568026



2x
6514055

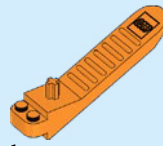

1x
6240515



11x
6190251



6x
6610658



4x
6250601



1x
4624381



2x
4537251



8x
4504372



2x
6617729



2x
6584891



2x
6310282



2x
6384590



2x
6365620



1x
6296104



1x
6296103



1x
6341762



1x
6341764



5x
6264062



4x
6533509



1x
6025026



6x
6541445



10x
4164037



7x
6310290



8x
6610652



2x
6218266



5x
4220632



1x
6056291



4x
6610649



2x
6138661



1x
6610650



1x
6327442



1x
6617733

4x
6013530

1x
6610653



3x
4187743



4x
6173012

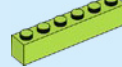

2x
4537919

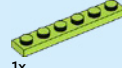

1x
4529160



1x
6534925



4x
4184108



2x
6536141



2x
6572735



4x
6536123



4x
4249891



2x
6617733



2x
6132566



1x
6186974

5

3



2x
6617732



4x
6362374



1x
6135494



2x
6159763



1x
6275844



2x
4211415



2x
6348143



1x
4211492



2x
4211807



4x
4211526



5x
4657459



2x
4211357



3x
6206249



2x
6117967



1x
6331859



4x
6212077



1x
6126082



2x
4211397



1x
4211491



4x
6251044



1x
4558169



1x
6171894



2x
6402876



3x
4211445



1x
6262086



1x
6176242



2x
4211395



2x
4211385



9x
4211549



2x
6015349



2x
4211805



1x
4211392



1x
6037399



1x
4520632



1x
6631413



8x
4558955



2x
4211060



2x
4211055



2x
6015356



1x
6133119



1x
6360824



3x
4211105



1x
4213607



1x
4528323



8x
4560184



1x
4620760



5x
6221607



2x
4211095



2x
4210631



8x
6617731



4x
6461475



4x
6617730



1x
6093494



2x
6329604



1x
6363150



2x
6525399



3x
6136419



2x
6348142



1x
6029690



4x
6104130



2x
6507920

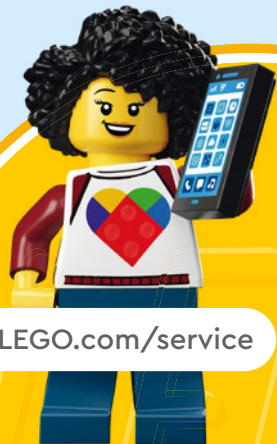

[LEGO.com/service](https://www.LEGO.com/service)

YOU COULD **WIN**

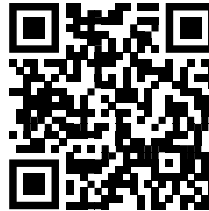

Scan this QR code or go to
LEGO.COM/PRODUCTFEEDBACK and give us
your short feedback about this LEGO® set
for a chance to win a cool LEGO prize.

Terms and Conditions apply*

EN: YOU COULD WIN. Terms and Conditions apply* **DE: Du könntest GEWINNEN.** Es gelten die Teilnahmebedingungen* **FR: TU POURRAIS GAGNER.** Des conditions s'appliquent* **IT: Potresti VINCERE tu.** Termini e condizioni sono applicabili* **ES: PUEDES GANAR.** Aplican términos y condiciones* **PT: PODERÁ GANHAR.** Aplicam-se Termos e Condições* **ZH: 轻松获奖. 条款和条件适用*** **PL: Szansa na WYGRANĄ.** Obowiązuje regulamin* **CS: Máte šanci VYHRÁT.** Platí všeobecné smluvní podmínky* **SK: Máte šancu VYHRÁŤ.** Platia všeobecné zmluvné podmienky* **HU: TE IS NYERHETSZ!** Felhasználási feltételek érvényesek* **UA: ВИ МОЖЕТЕ ВИГРАТИ.** Застосовуються загальні положення та умови* **RO: Ai putea CÂȘTIGA.** Se aplică termeni și condiții* **BG: Можете да СПЕЧЕЛИТЕ.** Има определени правила и условия* **LV: Tu vari LAIMĒT.** Ir spēkā noteikumi un nosacījumi.* **ET: Sul on võimalus VÕITA.** Kehtivad tingimused* **LT: Jūs galite LAIMĖTI.** Taikomos sąlygos* **TR: KAZANABİLİRSİN.** Şartlar ve Koşullar geçerlidir*

*[LEGO.com/productfeedback-terms](https://www.lego.com/productfeedback-terms)