

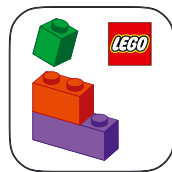

*Editions™*

43033



LEGO® Builder





### **Get excited about our new packaging!**

We're switching from plastic to paper-based packaging. That's why you might find a mix of paper and plastic in our boxes!

### **Nos nouveaux emballages vous emballeront !**

Nous passons des emballages en plastique aux emballages à base de papier. C'est pourquoi vous pourriez trouver un mélange de papier et de plastique dans nos boîtes !

### **¡Te presentamos nuestros nuevos empaques!**

Estamos sustituyendo las bolsas de plástico por bolsas con base de papel. ¡Por eso, puedes encontrar una mezcla de papel y de plástico en nuestras cajas!

**[LEGO.com/sustainable-packaging](https://www.lego.com/sustainable-packaging)**

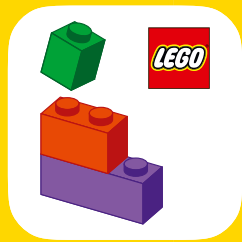

LEGO® Builder



# BUILDER



Apple and the Apple logo are trademarks of Apple Inc., registered in the U.S. and other countries and regions. App Store is a service mark of Apple Inc. Google Play and the Google Play logo are trademarks of Google LLC. Tencent and the Tencent logo are trademarks of Tencent Inc.

[LEGO.com/devicecheck](http://LEGO.com/devicecheck)

EN Ask parents' permission before going online | DE Eltern um Erlaubnis bitten, bevor du online gehst | FR Demande l'autorisation d'un parent avant d'aller en ligne | IT Chiedi il permesso ai tuoi genitori prima di andare online | ES Pídeles permiso a tus papás antes de conectarte a Internet | PT Pede autorização aos teus pais antes de ficares online | ZH 上网前应先征得父母的同意 | PL Poproś rodziców o zgodę, zanim wejdiesz do Internetu | CS Než půjdeš na internet, požádej rodiče o svolení | SK Skôr než pôjdeš na internet, vypýtaj si povolenie od rodičov | HU Kérj szülői engedélyt, mielőtt online csatlakoznál! | UA Запитуйте дозволу батьків, перш ніж користуватися інтернетом | RO cere permisiunea părinților înainte de a te conecta online | BG Поискайте разрешение от родител, преди да влезете онлайн | LV Pirms došanās tiešsaistē palūdz atļauju vecākiem | ET Enne Interneti kasutamist küsi vanematelt luba | LT Prieš prisijungdami prie interneto, atsiklauskite tėvų | TR İnternete girmeden önce anne babandan izin iste

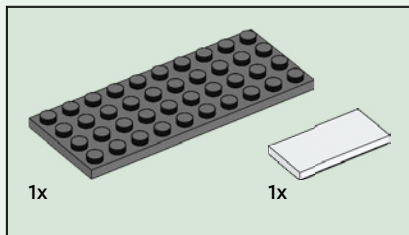

1

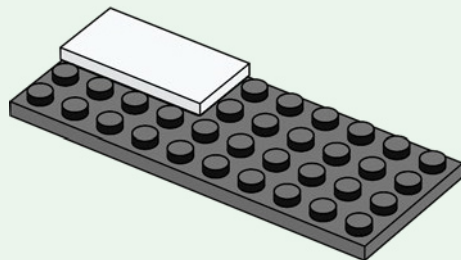

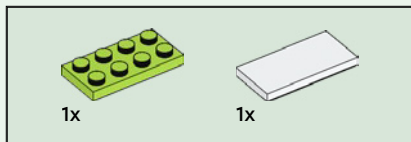

2

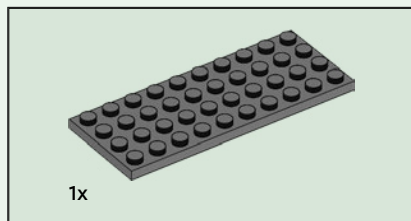
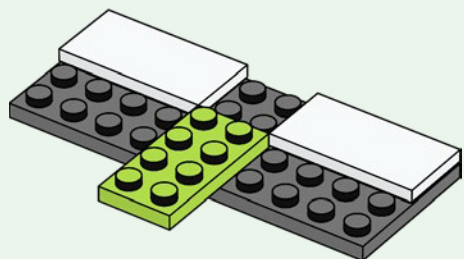

3

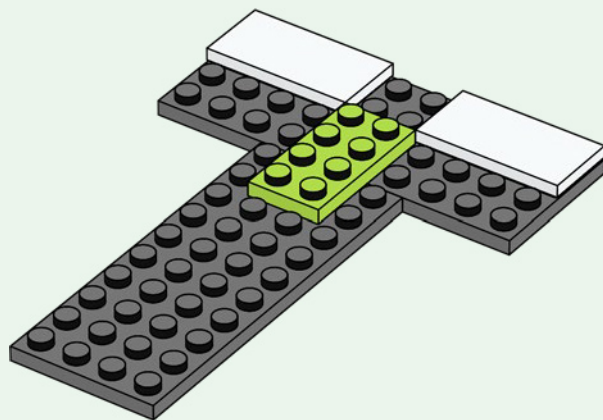

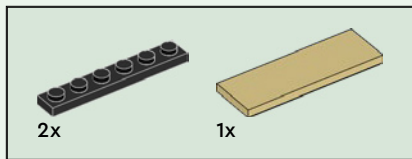

4

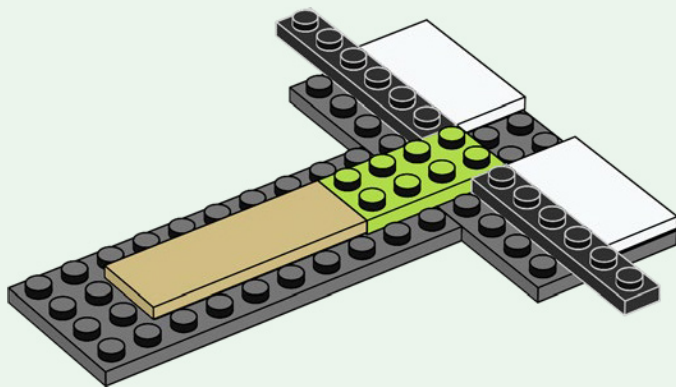

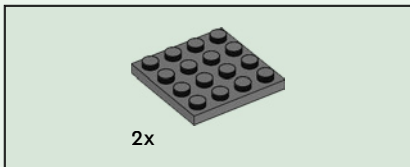

5

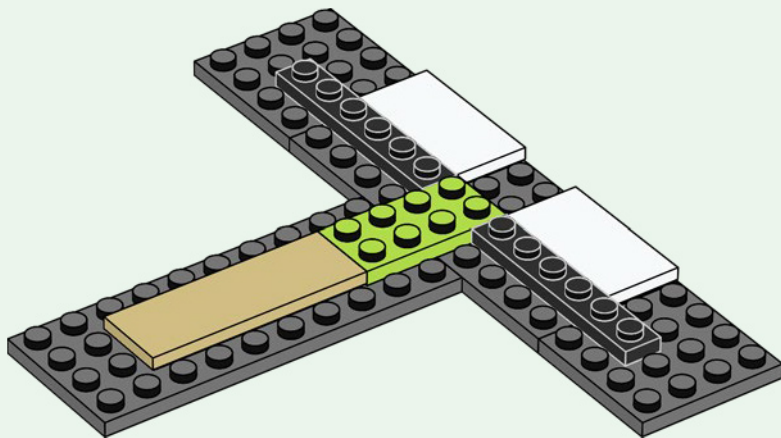

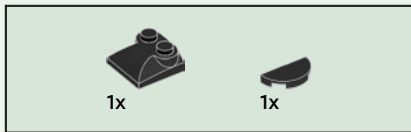

6

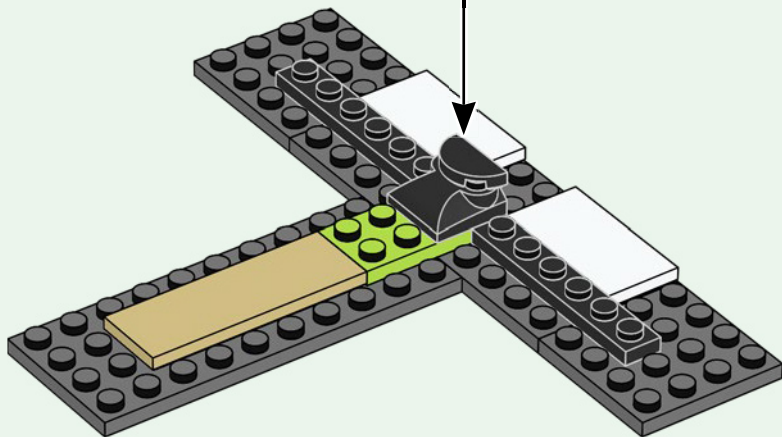
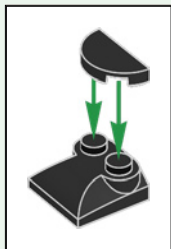

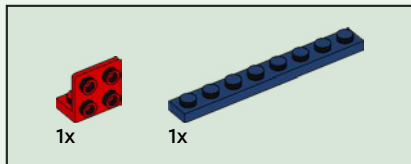
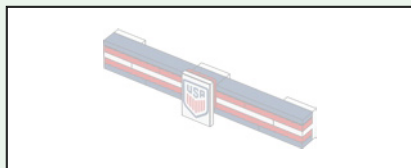

7

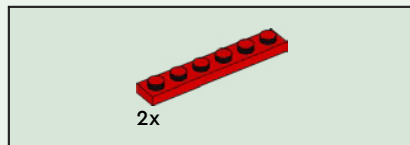
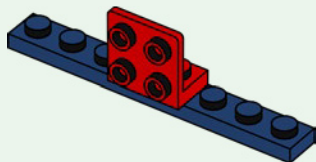

8

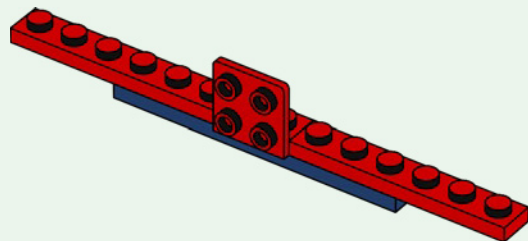

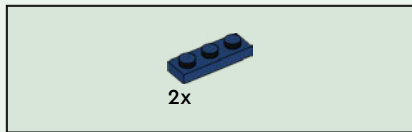

9

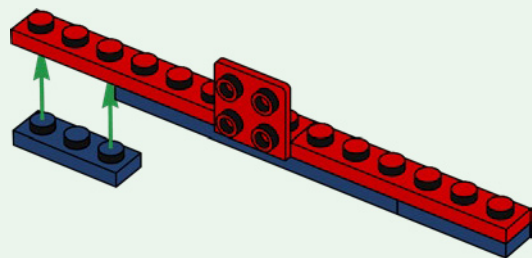

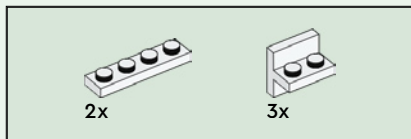

10

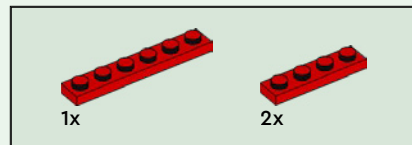
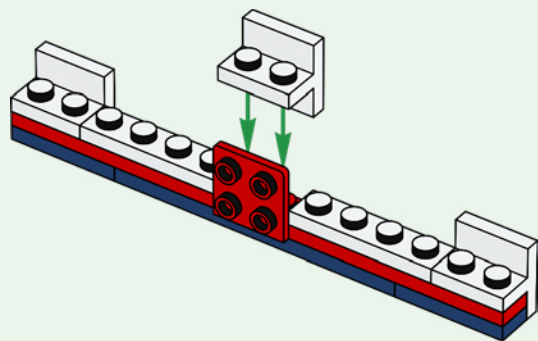

11

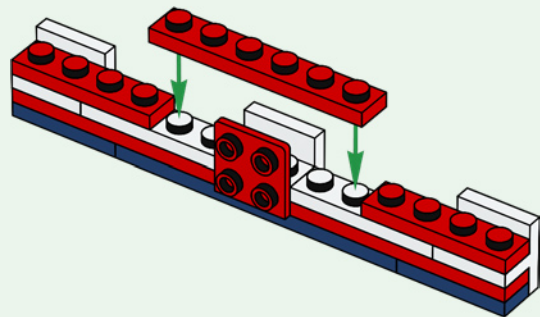

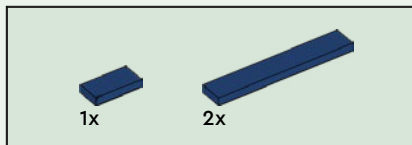

12

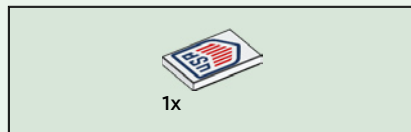
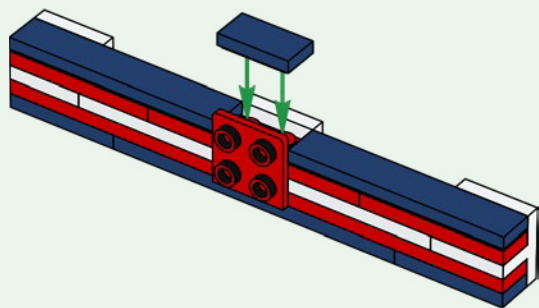

13

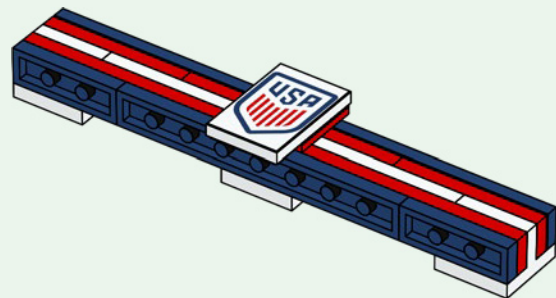

14

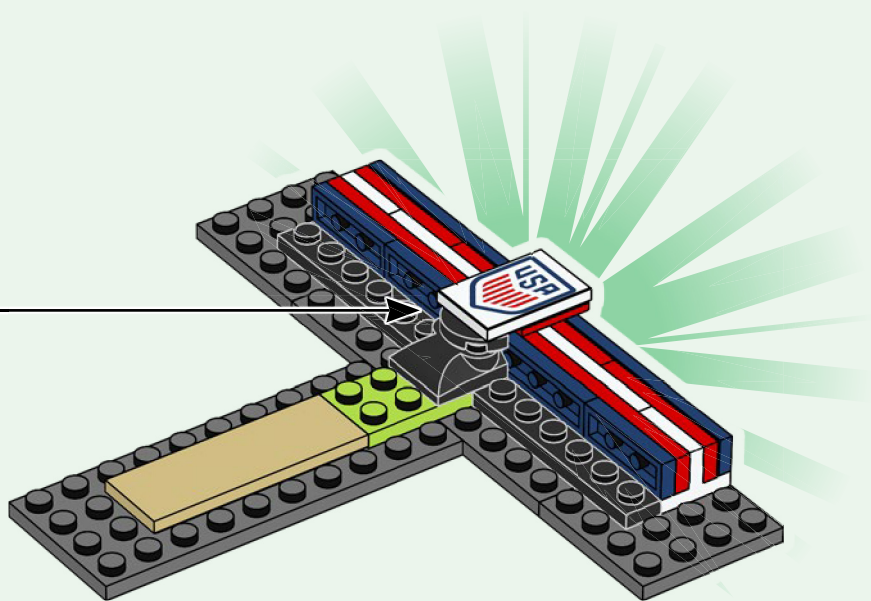

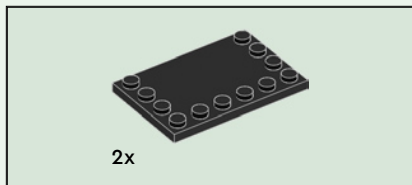

15

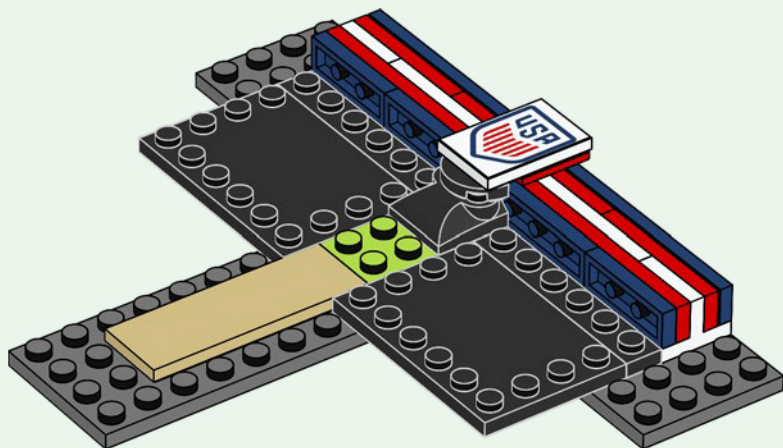

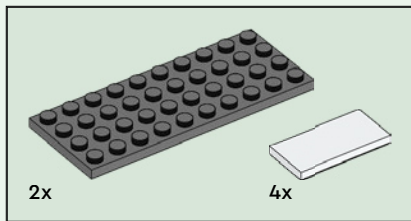

16

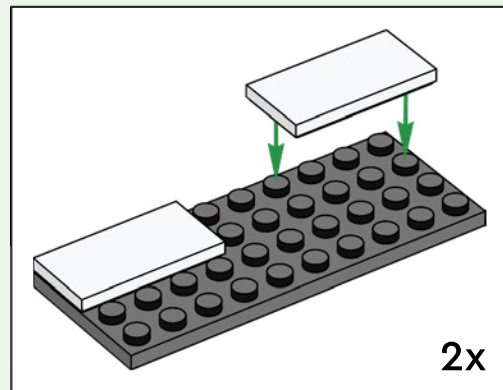
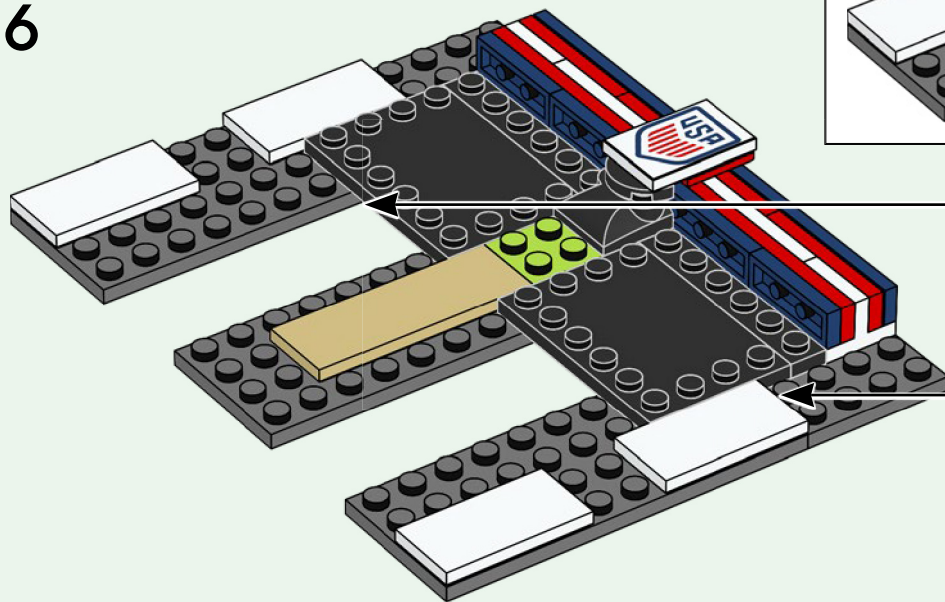

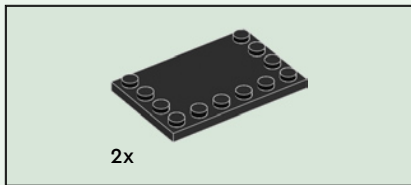

17

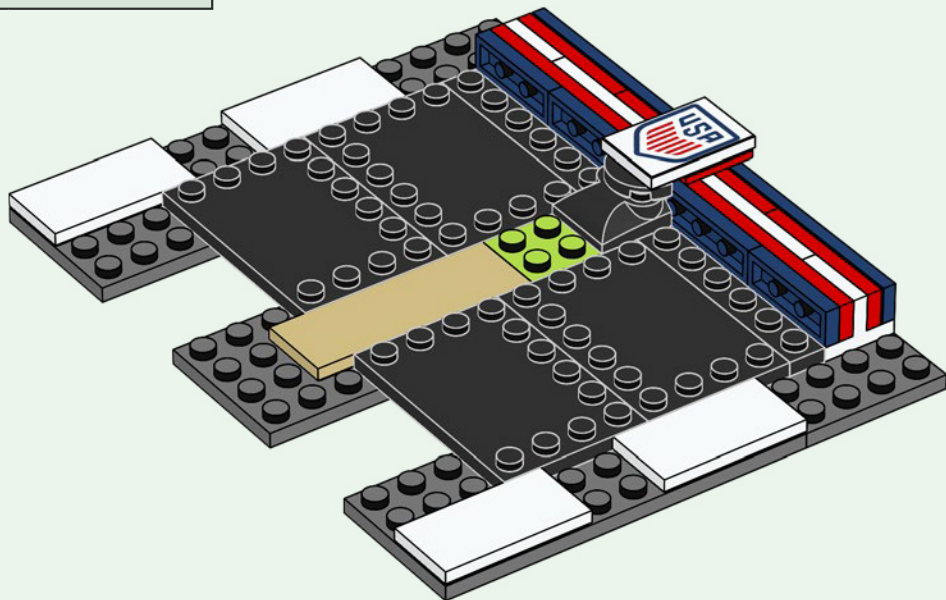

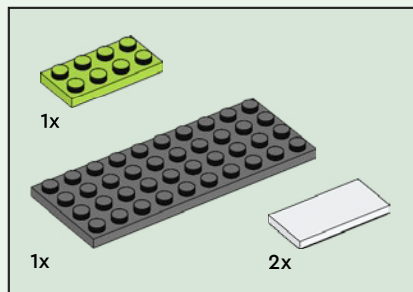

18

1

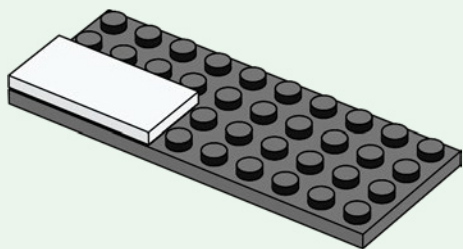

2

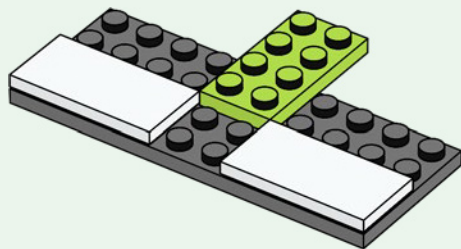

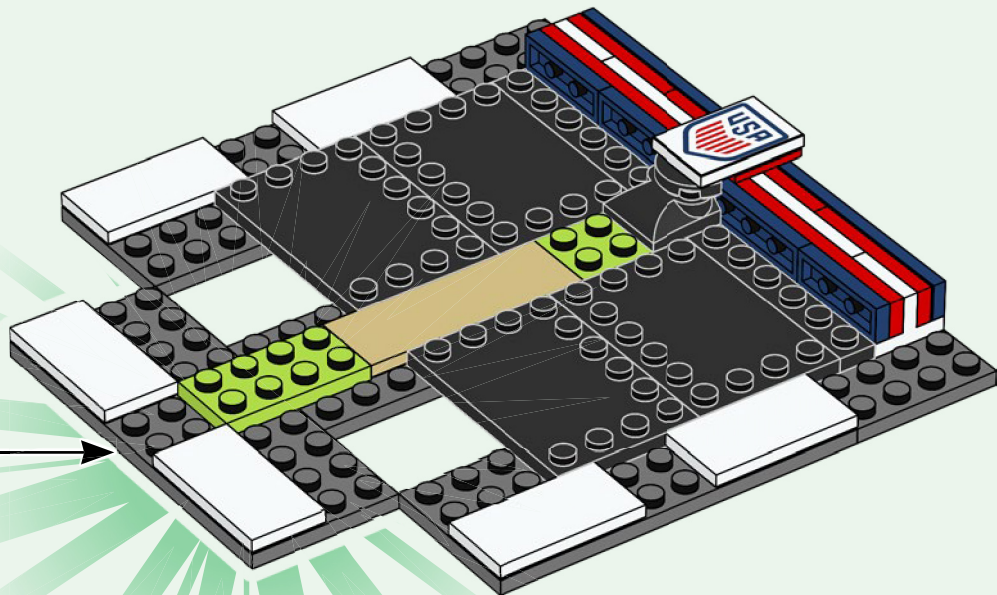

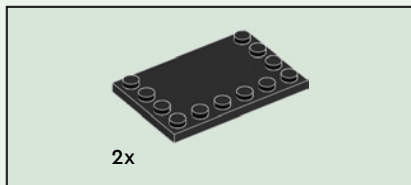

19

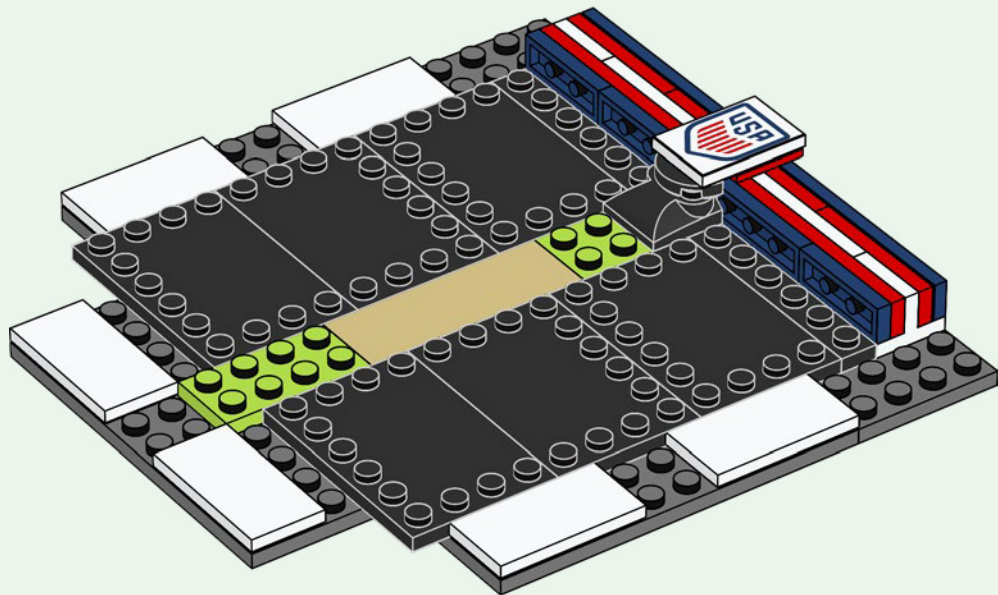

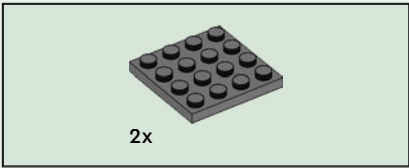

20

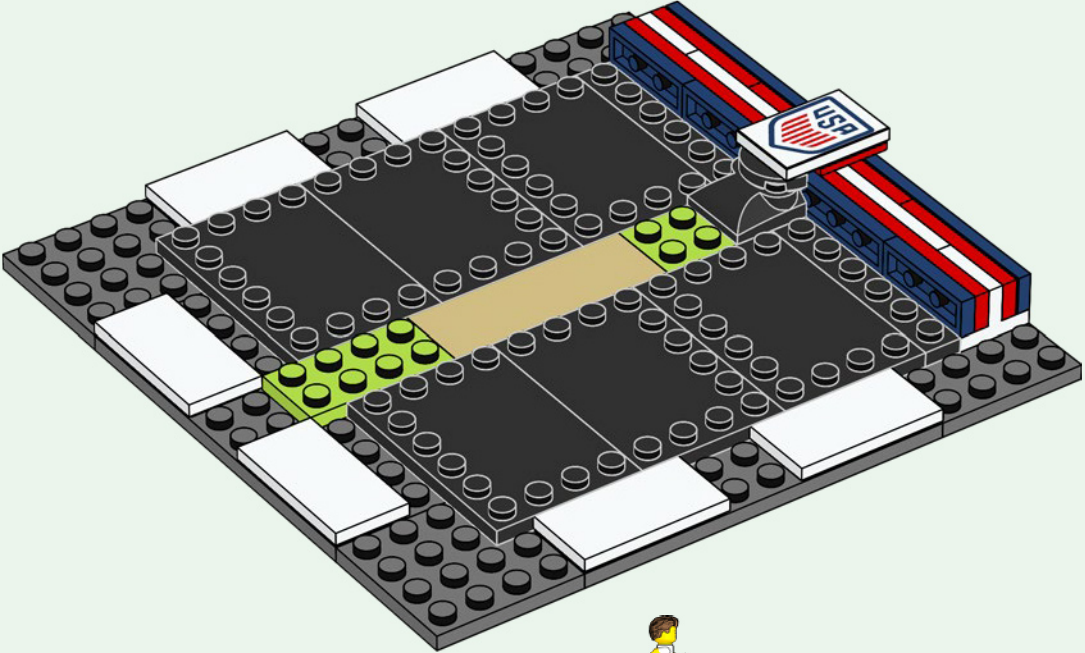

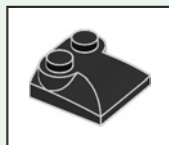
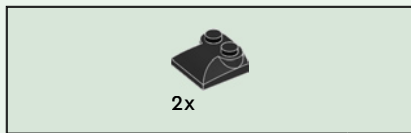

21

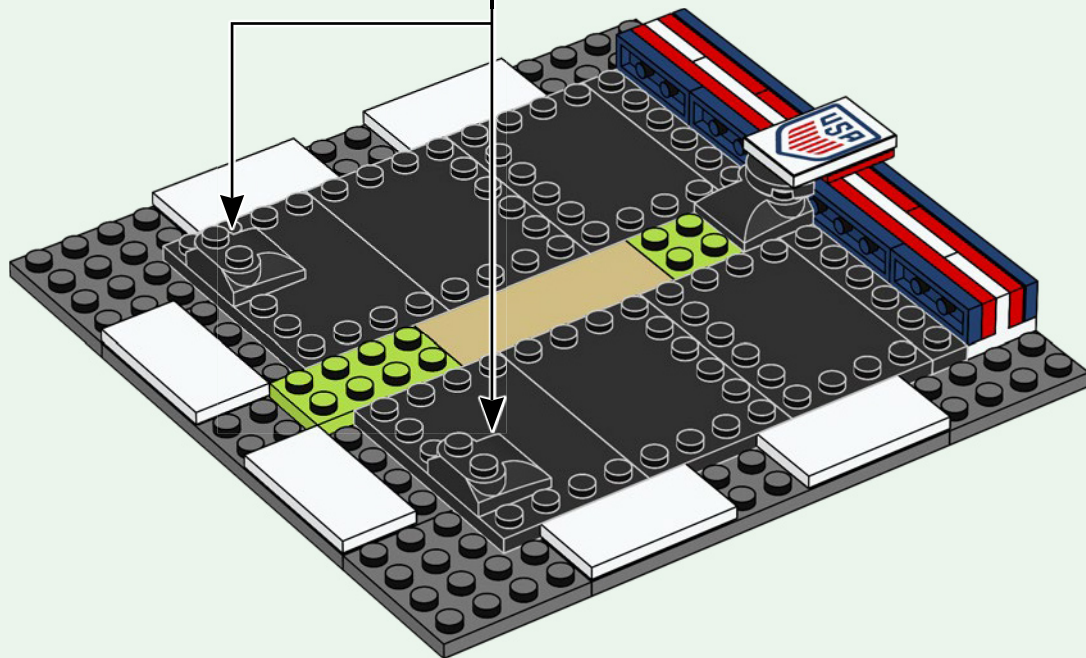

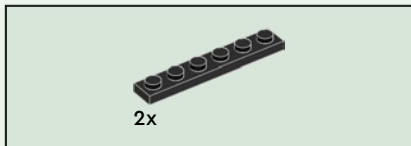

22

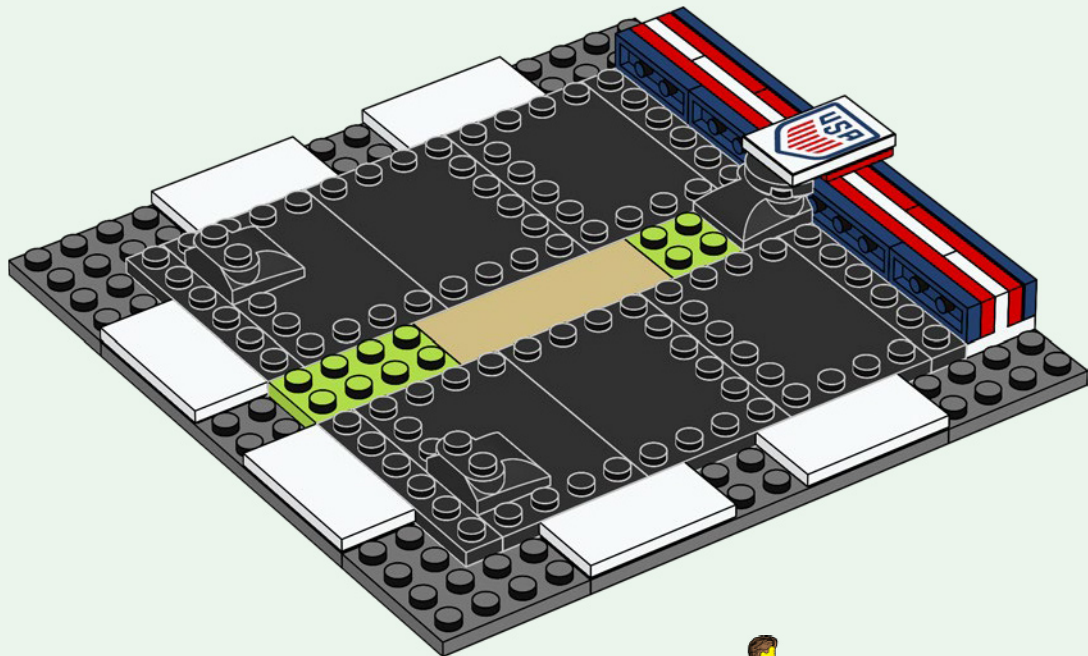

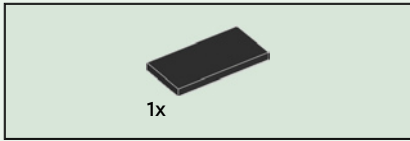

23

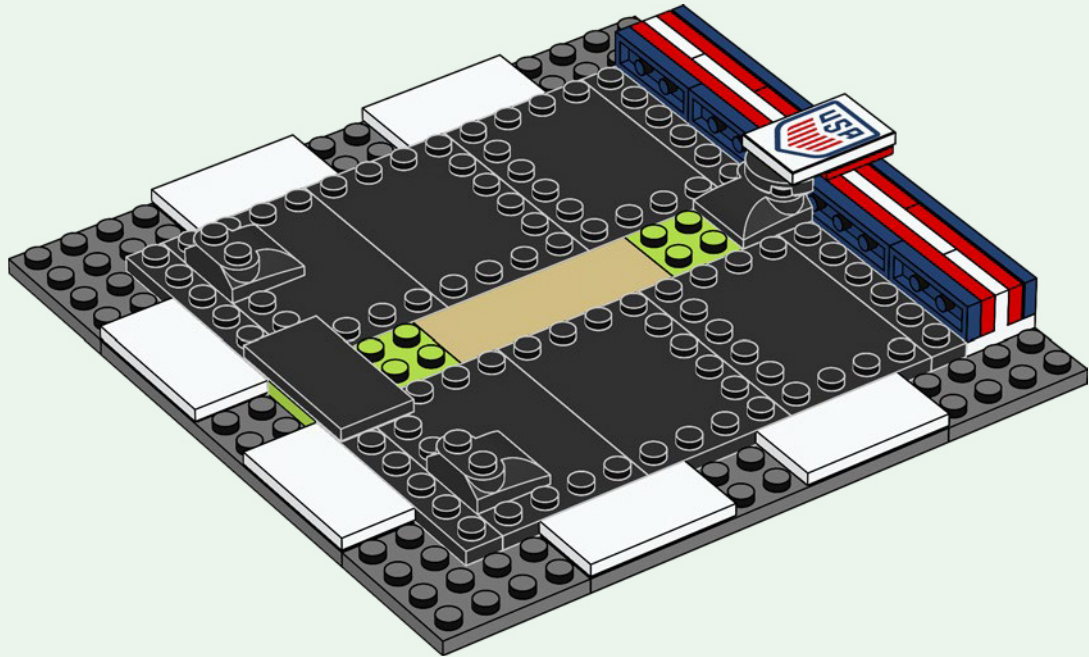

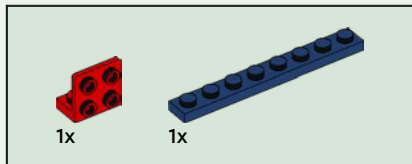
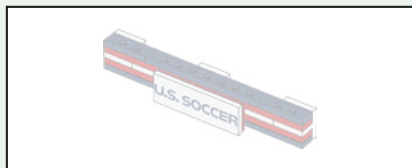

24

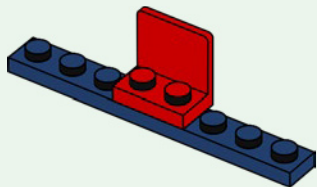

25

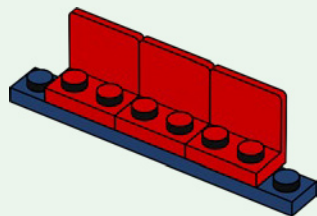

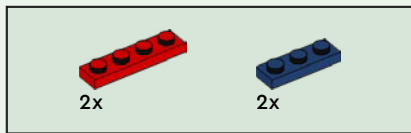

26

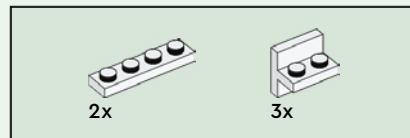
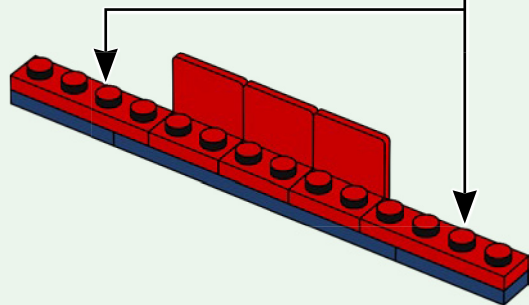
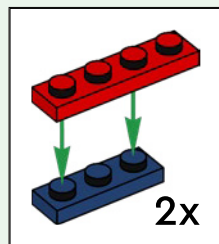

27

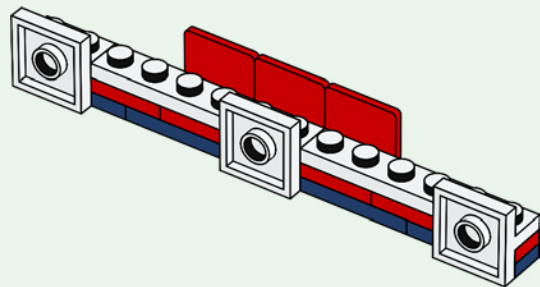

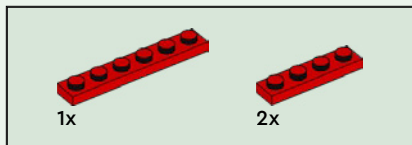

28

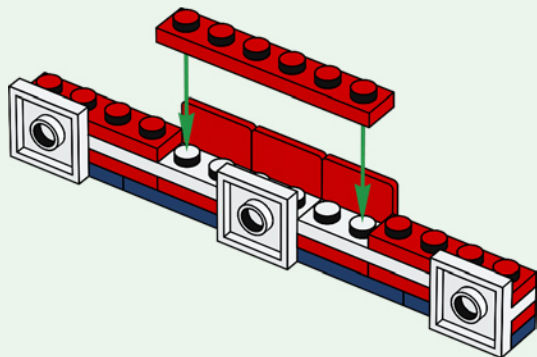

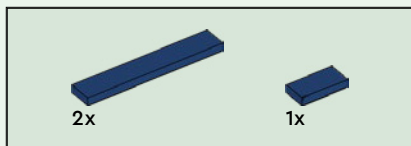

29

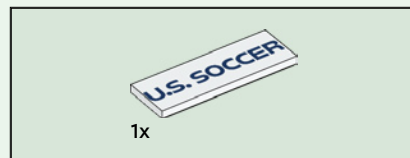
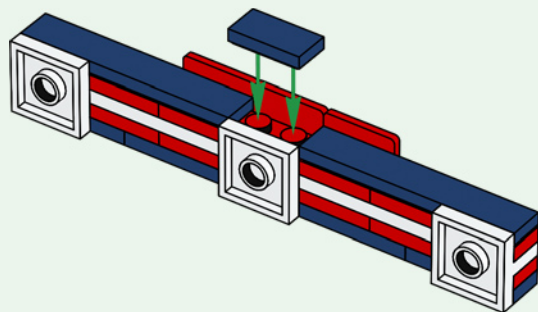

30

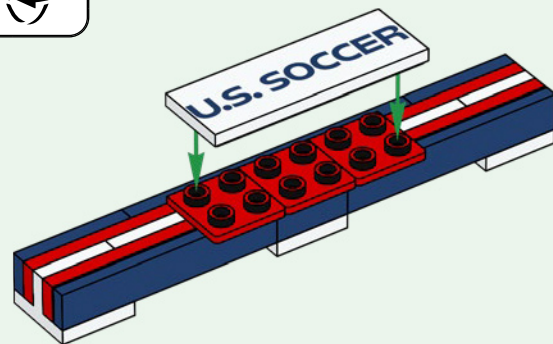

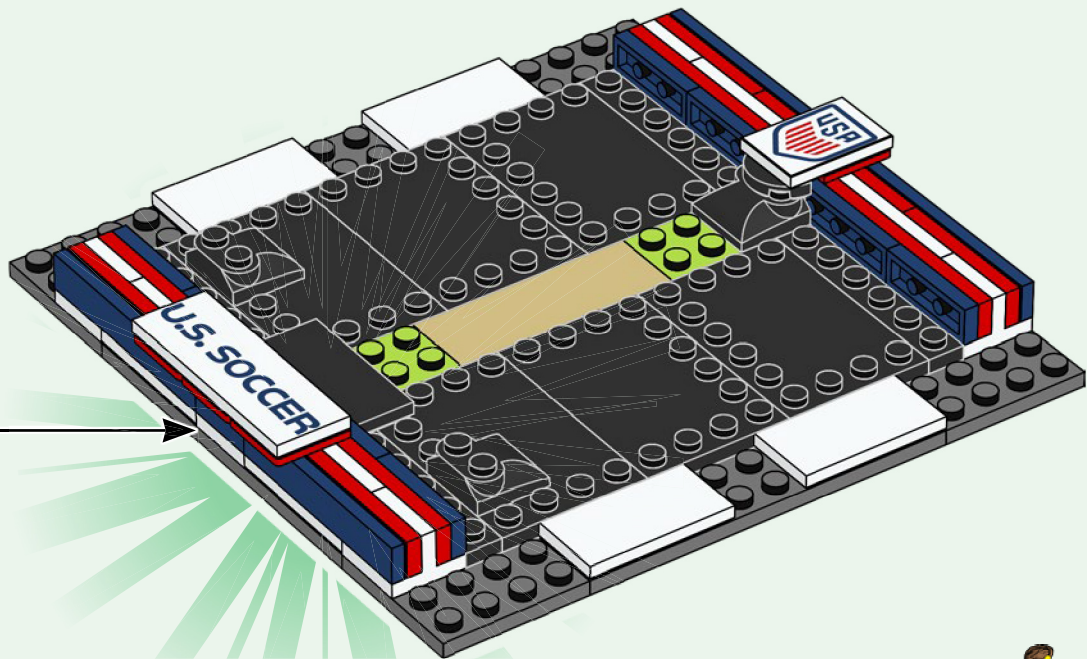



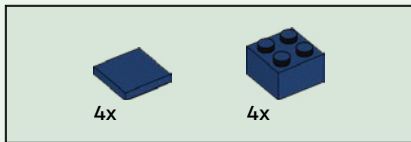

32

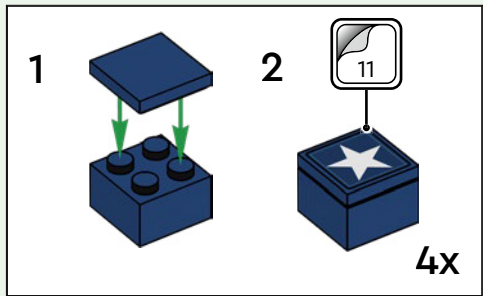
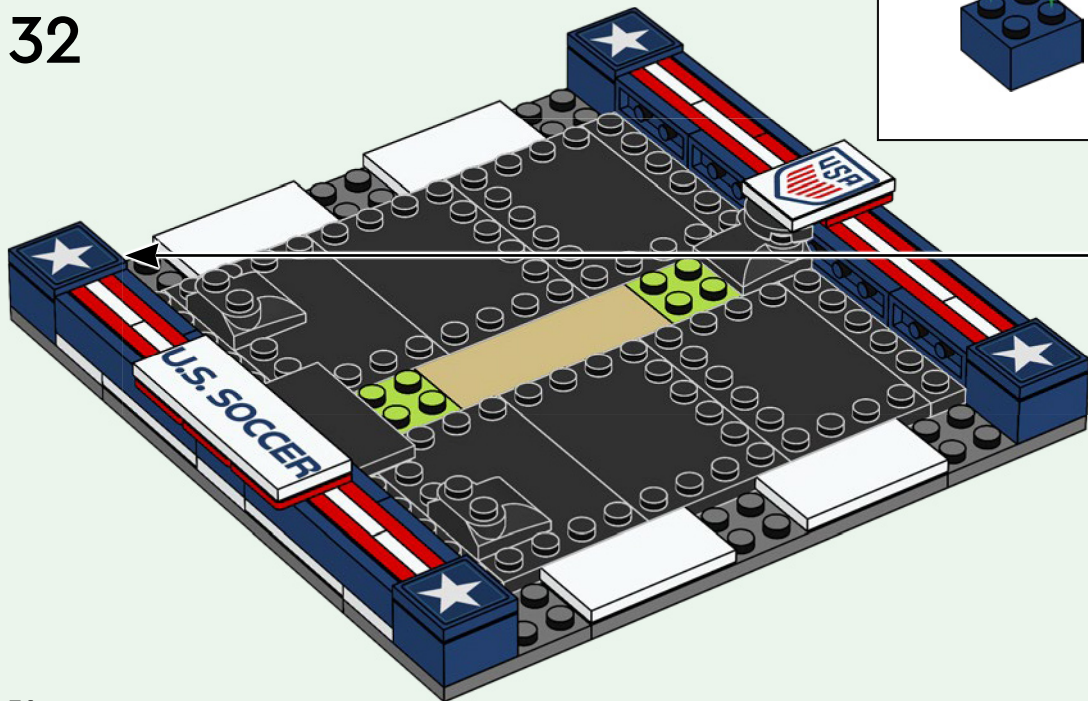

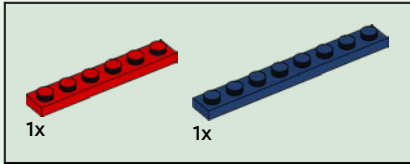
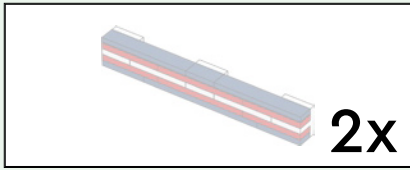

33

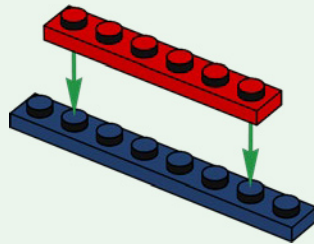

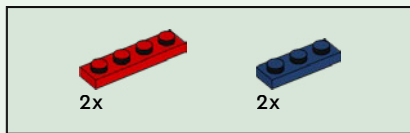

34

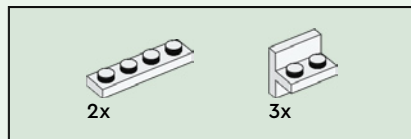
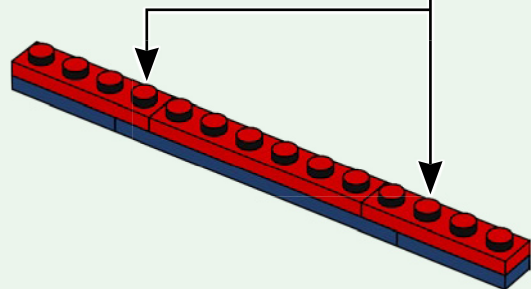
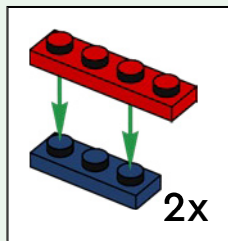

35

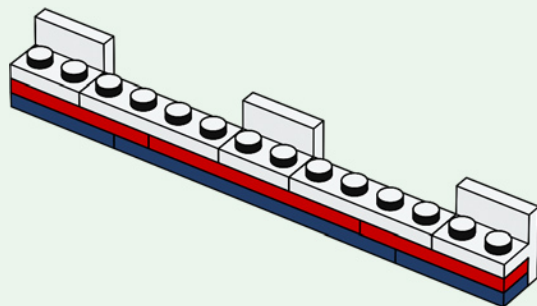

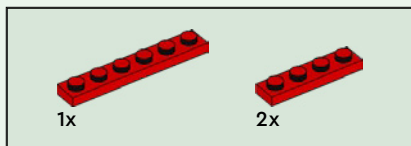

36

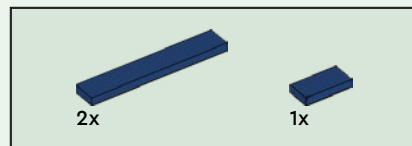
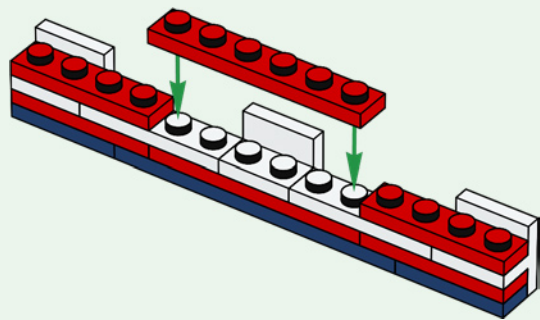

37

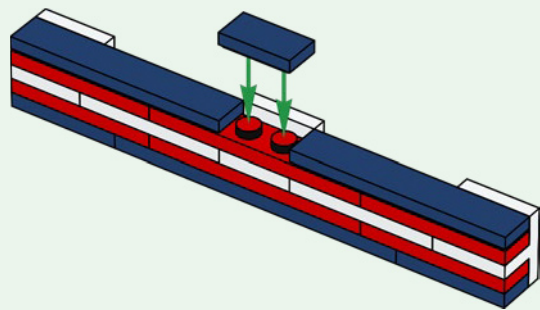

2x



38

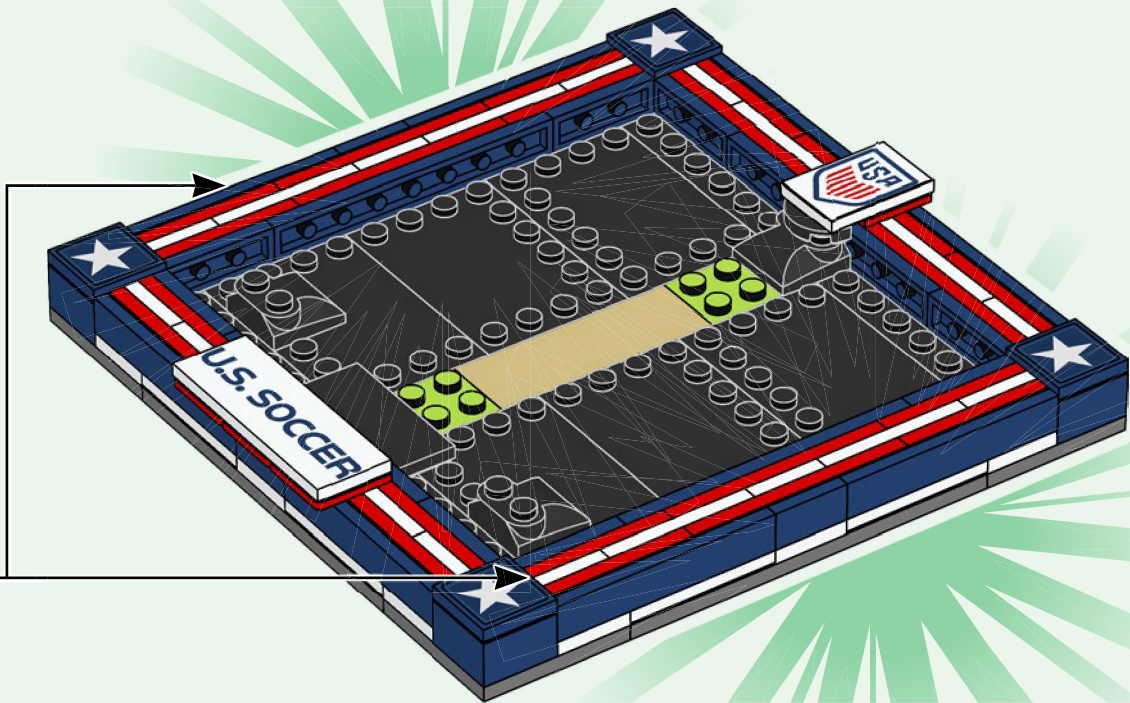



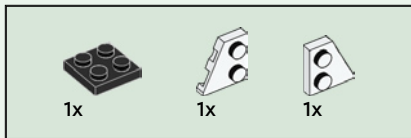

40

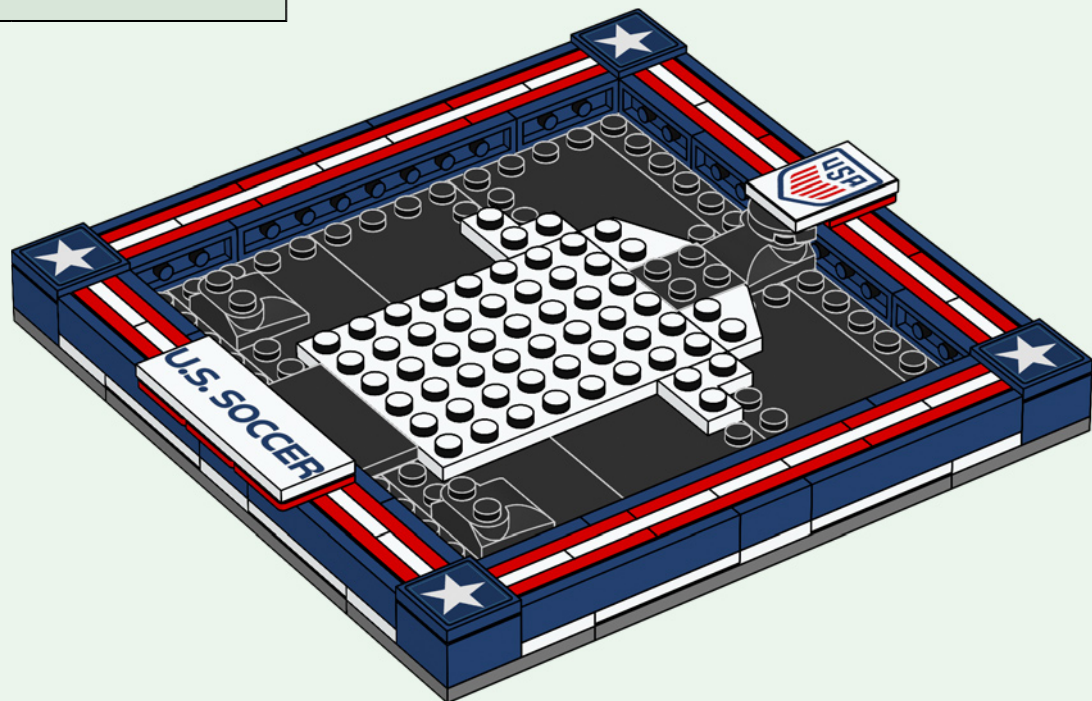

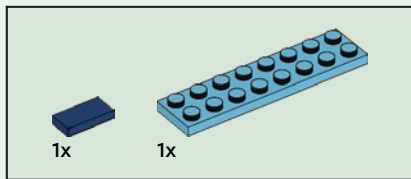

41

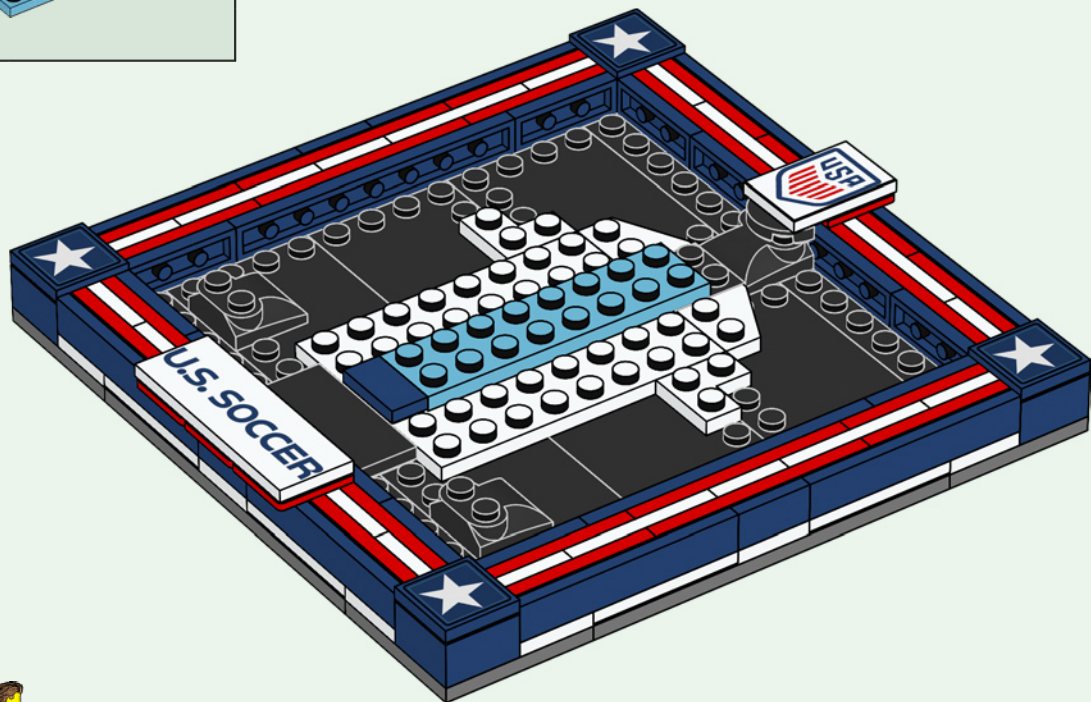

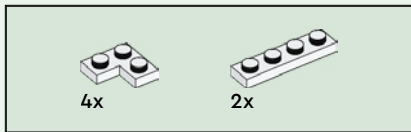

42

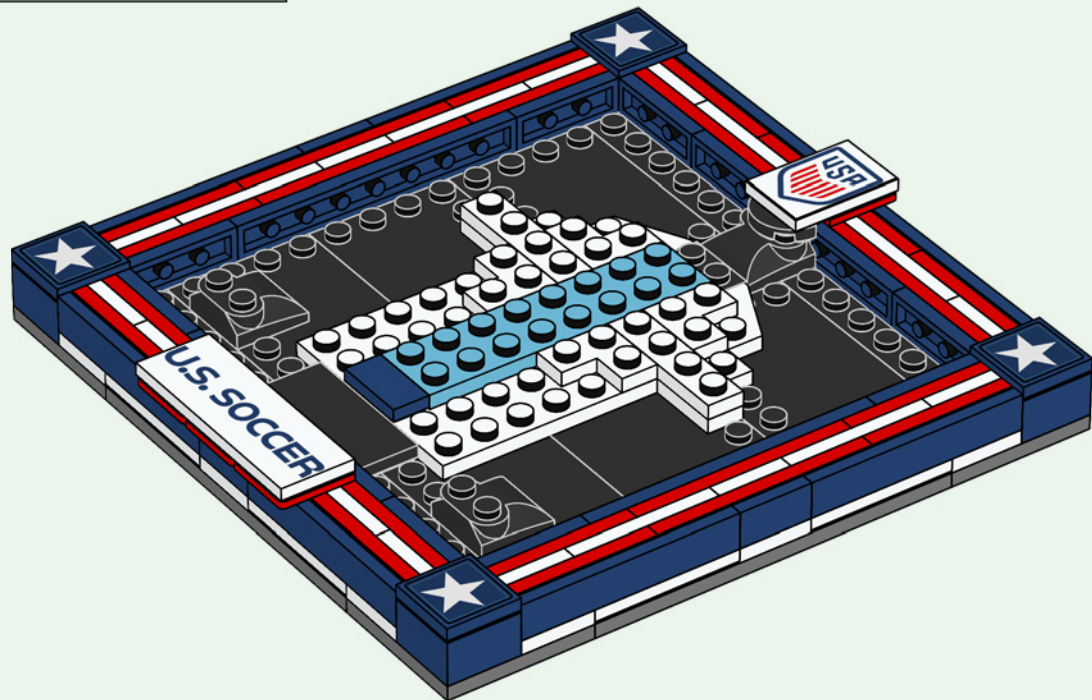

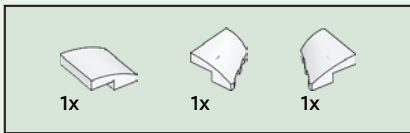

43

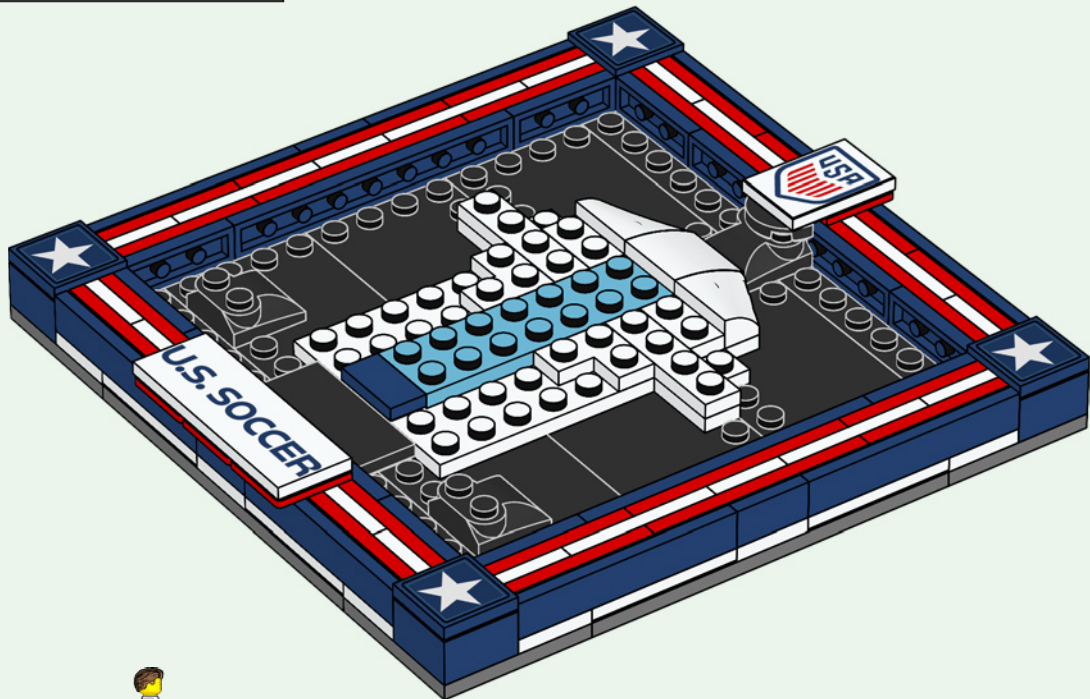

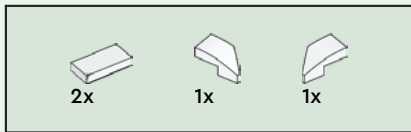

44

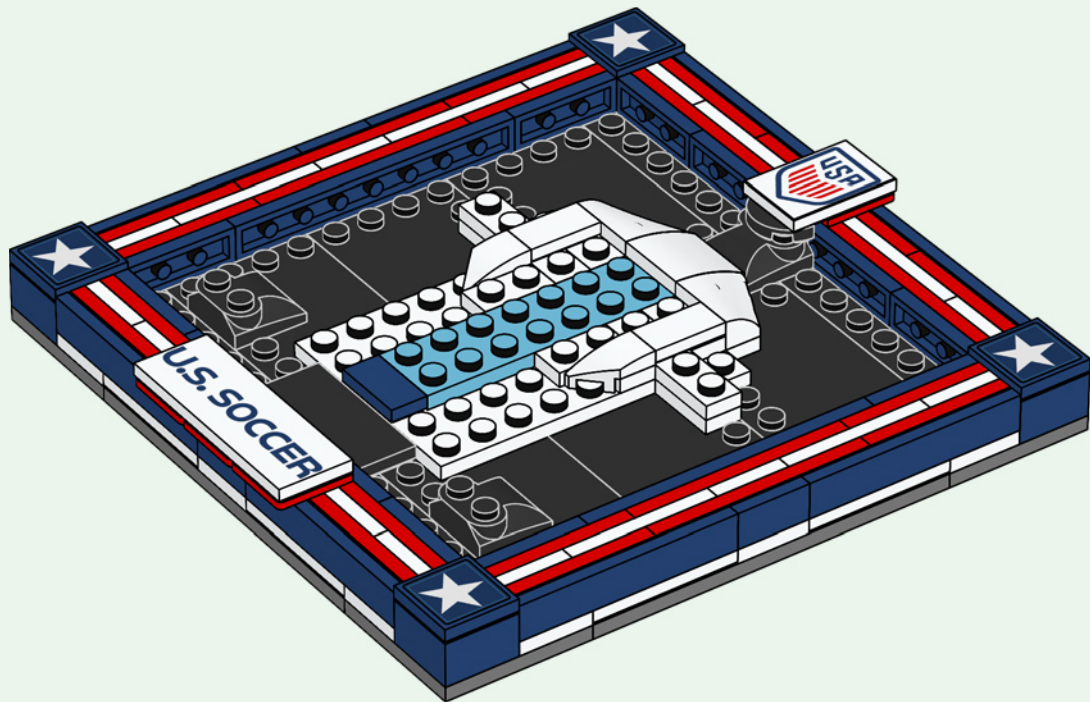

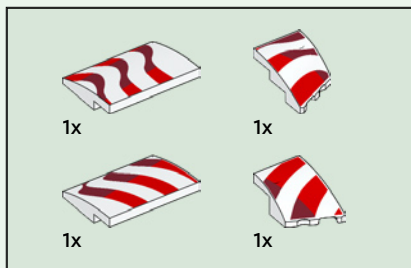

45

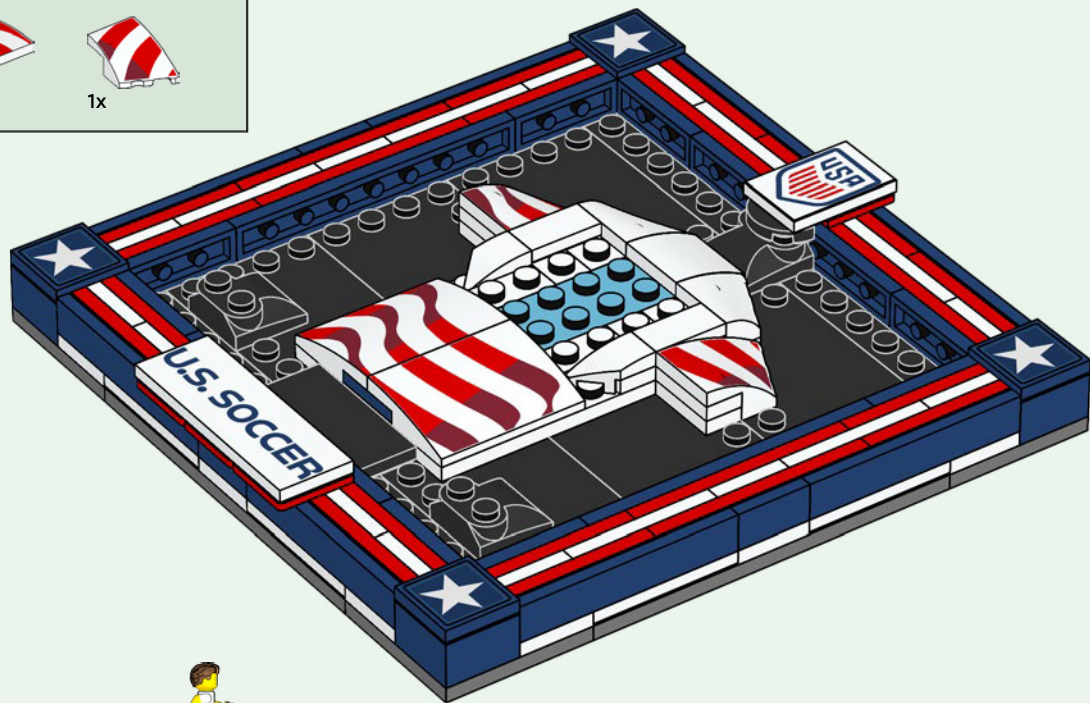

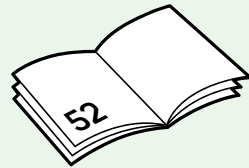
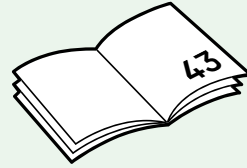





2x

46

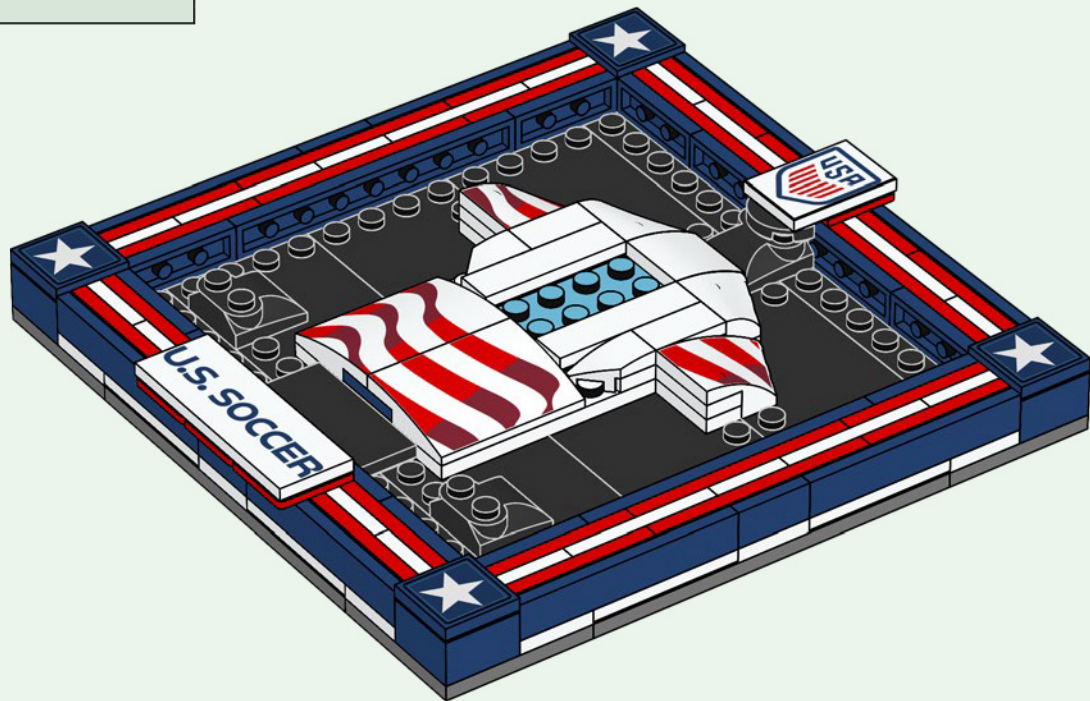

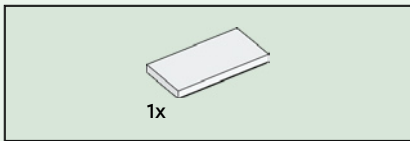

47

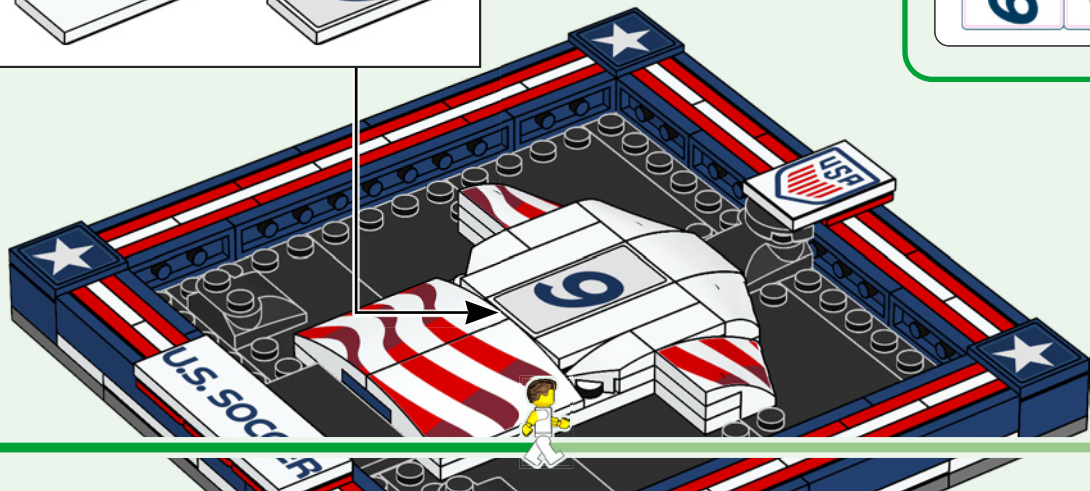
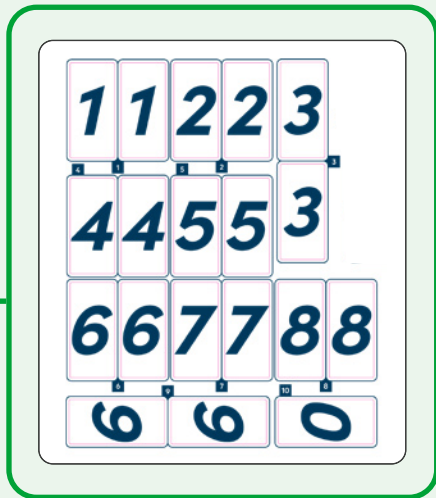
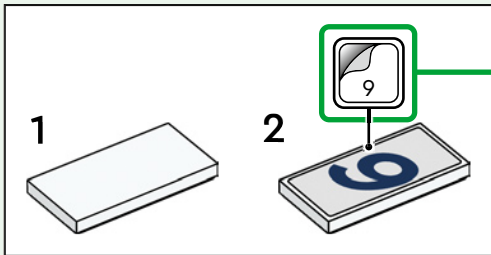

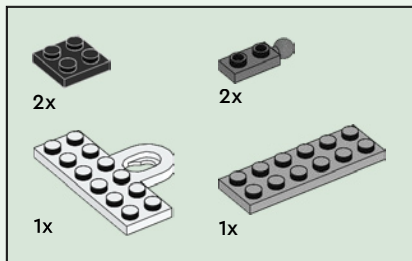

# 48

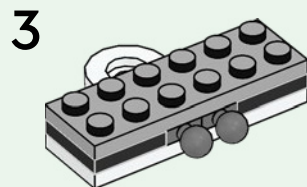
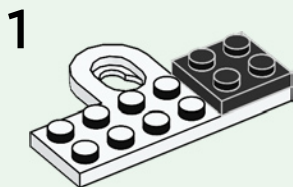

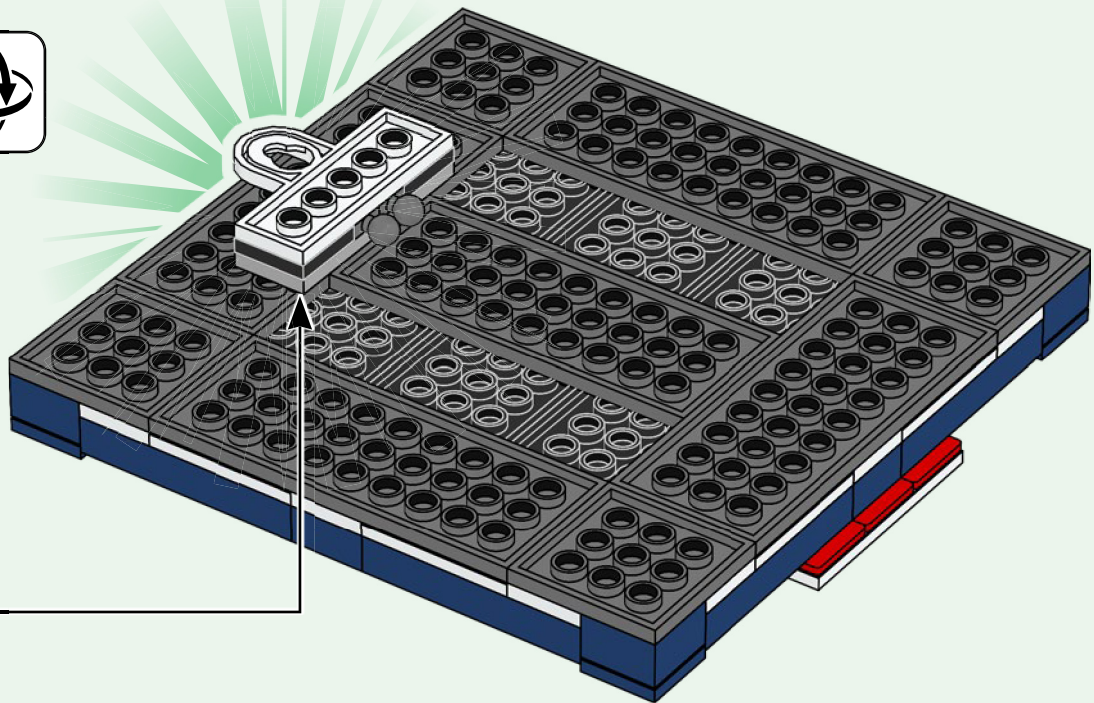

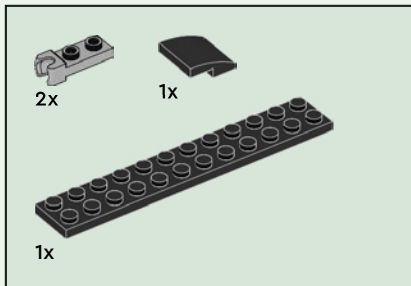

49

1

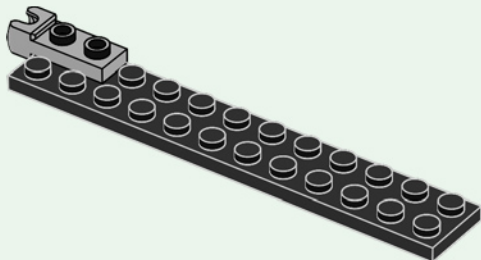

2

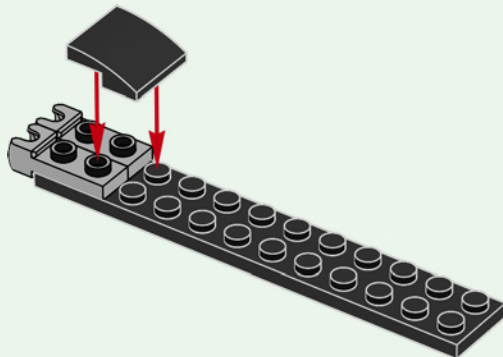

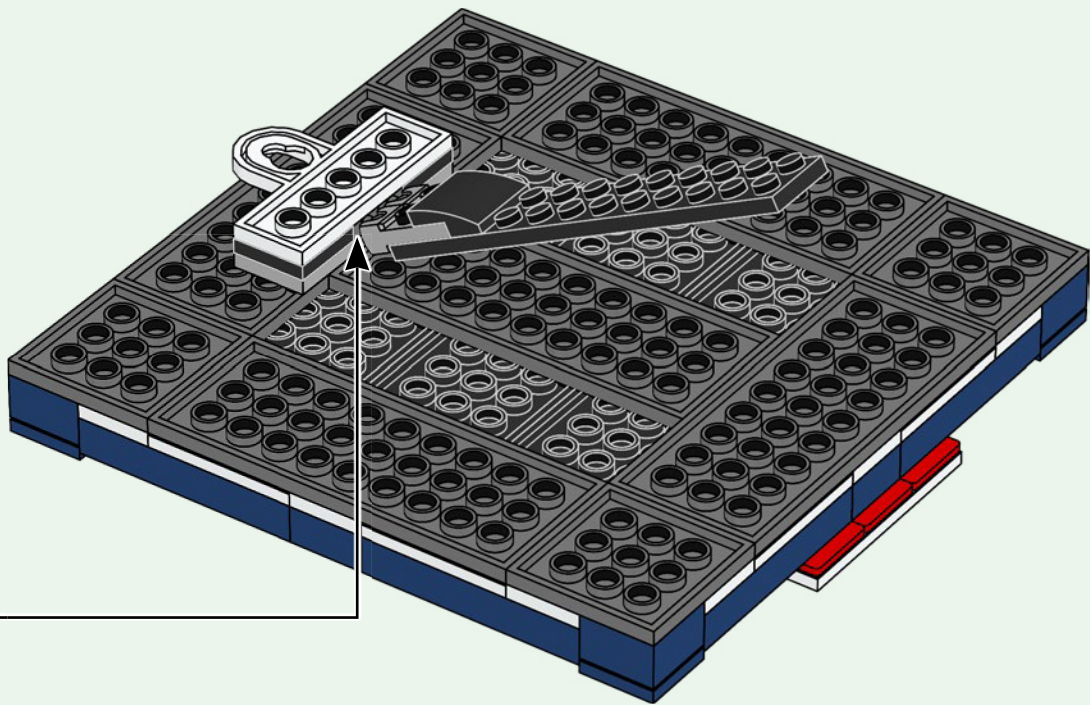

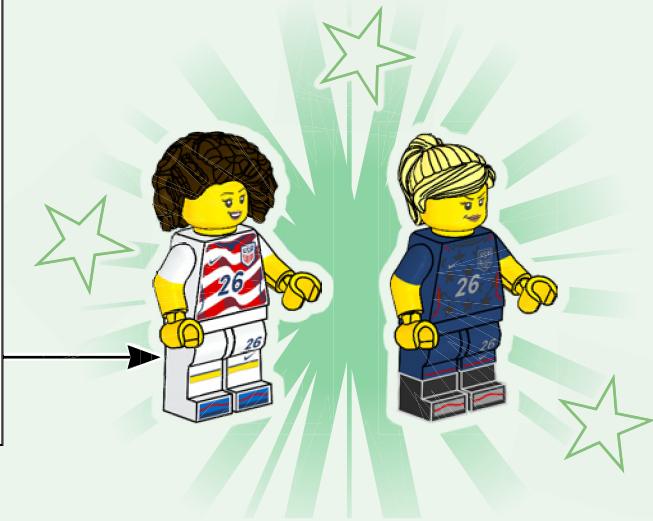
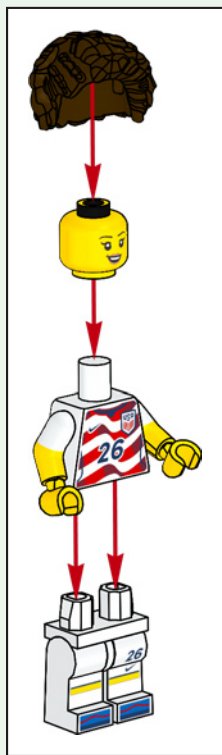





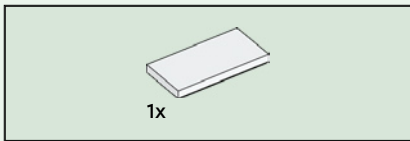

51

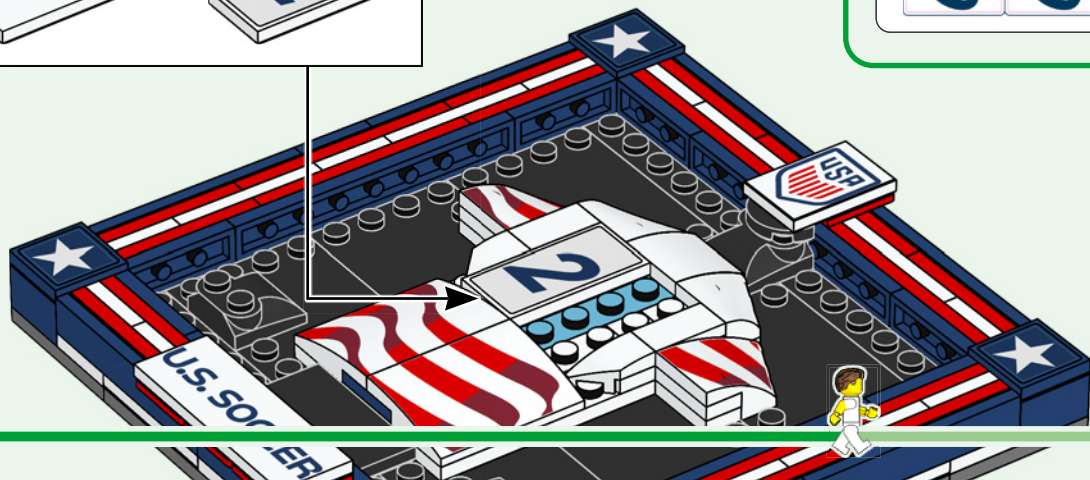
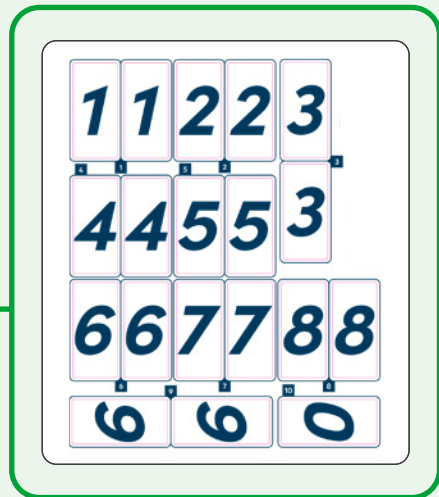
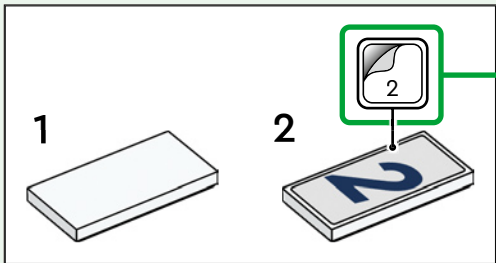

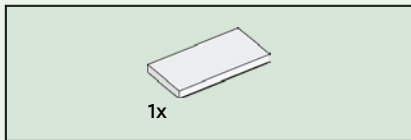

52

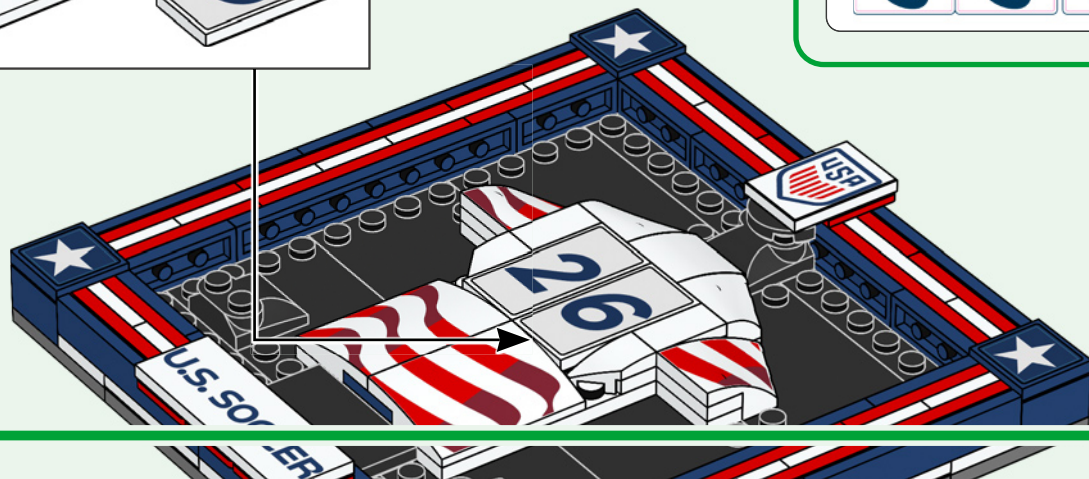
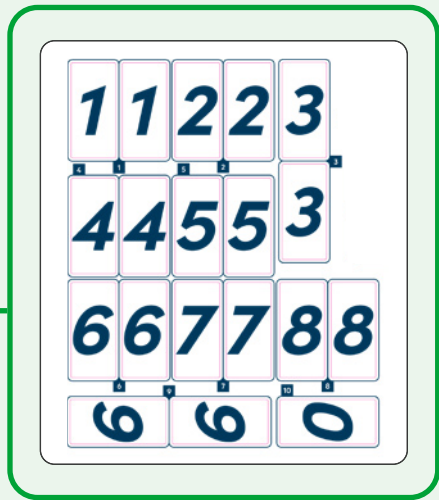
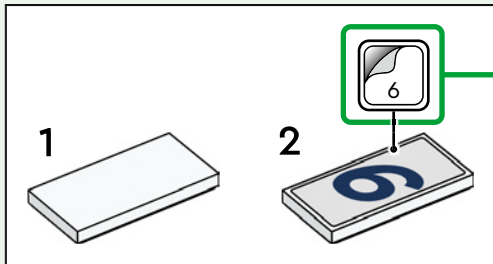

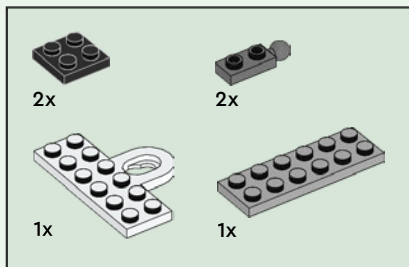

53

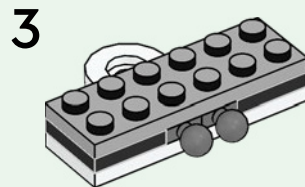
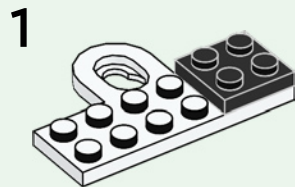

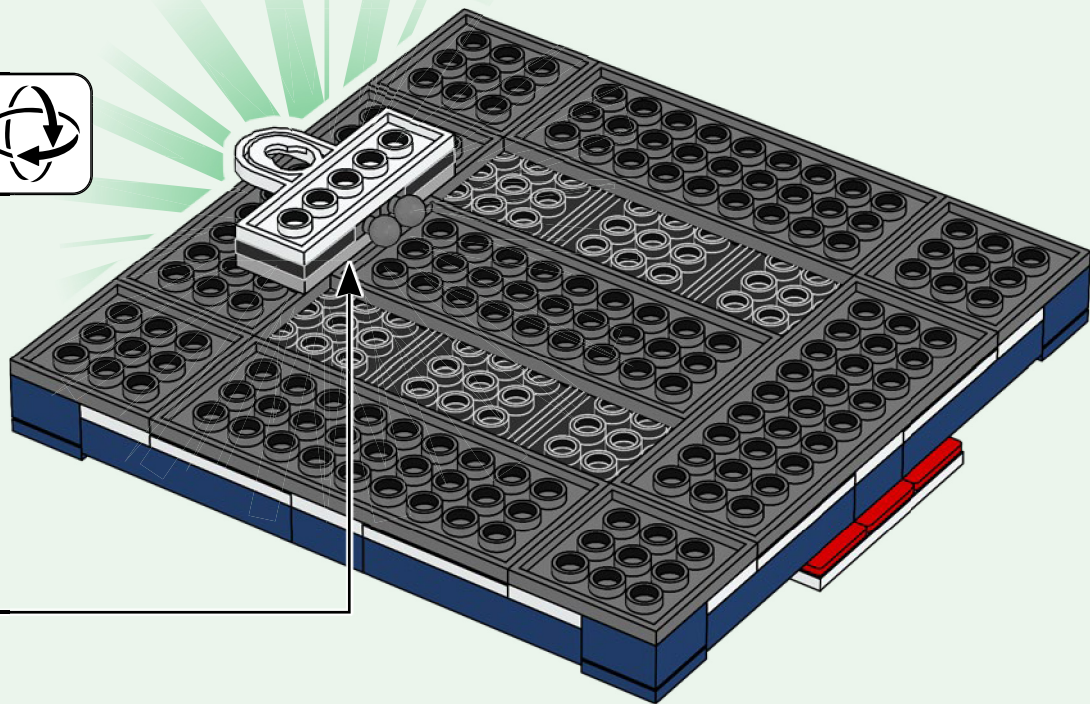

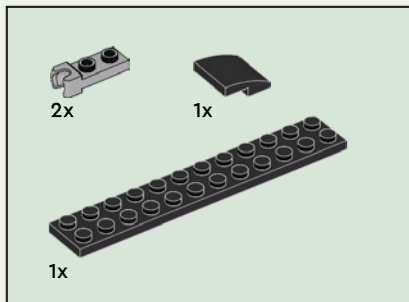

# 54

1

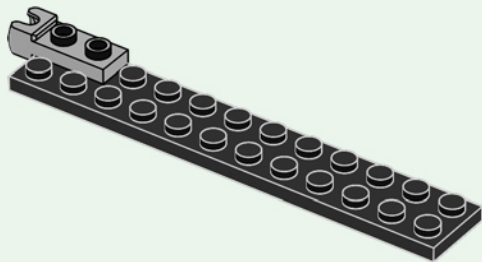

2

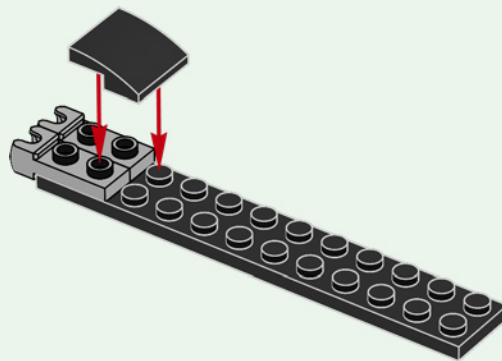

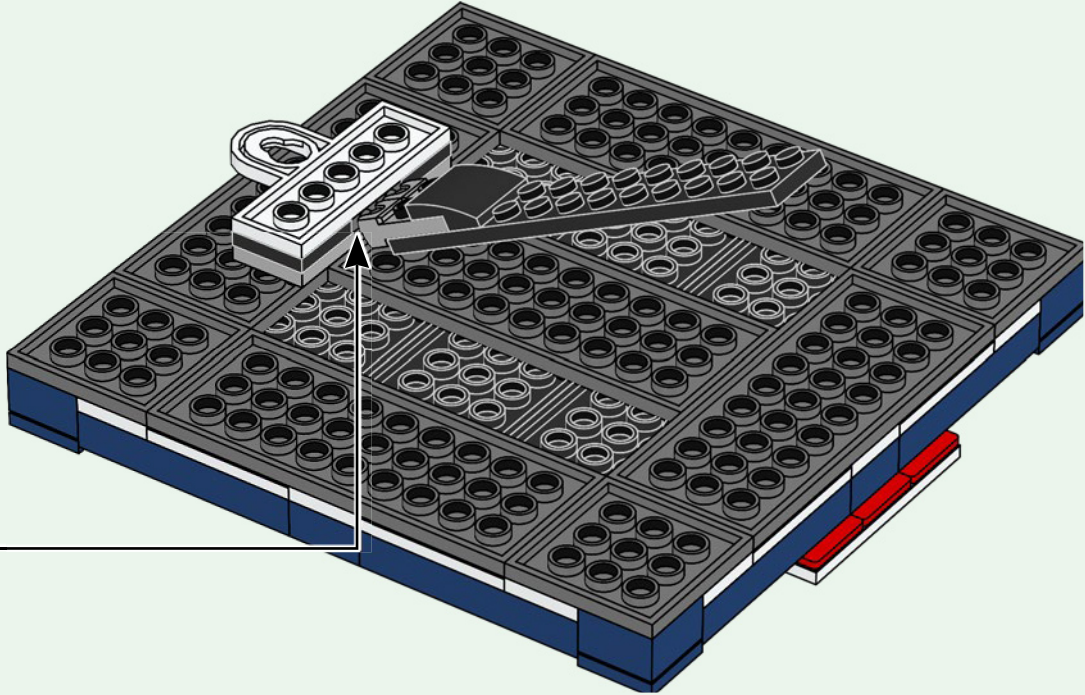

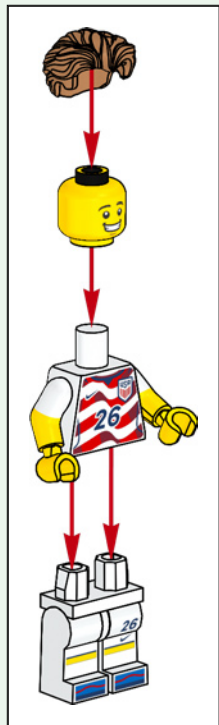





1x  
6213880



1x  
6213881



1x  
6132203



1x  
6132204



1x  
6513906



1x  
6507844



1x  
6605667



2x  
306901



12x  
6250019



6x  
242001



1x  
6606654



1x  
6047220



1x  
6606656



1x  
6626624



1x  
6606657



2x  
243101



10x  
371001



10x  
4560178



1x  
6606653



1x  
6606655



1x  
6378415



1x  
6605662



1x  
303601



1x  
6331158



4x  
6001806



14x  
371021



8x  
366621



1x  
6270320



1x  
6153335



1x  
6283884



1x  
6174813



1x  
6438933



1x  
6510071



3x  
6394979



1x  
4560182



3x  
302226



4x  
366626



1x  
6053077

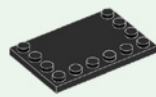

6x  
4100378

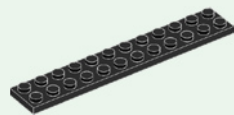

1x  
244526



2x  
4537936



1x  
6605666



5x  
4528488



4x  
4296785



4x  
4205004



8x  
4177735



1x  
6626589



8x  
4252437



4x  
6250216



2x  
6043639



1x  
4211452



2x  
6123814



1x  
6631414



1x  
6092833



1x  
6409768



5x  
4211122



1x  
6253666



4x  
4243831



 [LEGO.com/service](https://www.lego.com/service)

YOU COULD  
**WIN**

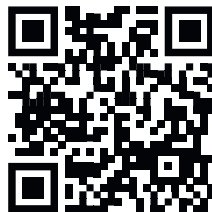

Scan this QR code or go to  
**LEGO.COM/PRODUCTFEEDBACK** and give us  
your short feedback about this LEGO® set  
for a chance to win a cool LEGO prize.

Terms and Conditions apply\*



**EN: YOU COULD WIN.** Terms and Conditions apply\* **DE: Du könntest GEWINNEN.** Es gelten die Teilnahmebedingungen\* **FR: TU POURRAIS GAGNER.** Des conditions s'appliquent\* **IT: Potresti VINCERE tu.** Termini e condizioni sono applicabili\* **ES: PUEDES GANAR.** Aplican términos y condiciones\* **PT: PODERÁ GANHAR.** Aplicam-se Termos e Condições\* **ZH: 轻松获奖.** 条款和条件适用\* **PL: Szansa na WYGRANĄ.** Obowiązuje regulamin\* **CS: Máte šanci VYHRÁT.** Platí všeobecné smluvní podmínky\* **SK: Máte šancu VYHRAŤ.** Platia všeobecné zmluvné podmienky\* **HU: TE IS NYERHETSZ!** Felhasználási feltételek érvényesek\* **UA: ВИ МОЖЕТЕ ВИГРАТИ.** Застосовуються загальні положення та умови\* **RO: Ai putea CÂȘTIGA.** Se aplică termenii și condiții\* **BG: Можете да СПЕЧЕЛИТЕ.** Има определени правила и условия\* **LV: Tu vari LAIMĒT.** Ir spēkā noteikumi un nosacījumi.\* **ET: Sul on võimalus VÕITA.** Kehtivad tingimused\* **LT: Jūs galite LAIMĖTI.** Taikomos sąlygos\* **TR: KAZANABİLİRSİN.** Şartlar ve Koşullar geçerlidir\*

\*[LEGO.com/productfeedback/terms](https://www.lego.com/productfeedback/terms)

*Editions™*

LEGO, the LEGO logo and the Editions logo are trademarks of the/son des marques de commerce du/son marcas registradas de LEGO Group.  
©2026 The LEGO Group. All rights reserved/Tous droits réservés/Todos los derechos reservados.

U.S. Soccer is a trademark of the United States Soccer Federation, Inc. All rights reserved.

© 2026 U.S. Soccer



6647416