

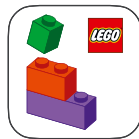

*Editions™*

43032



LEGO® Builder





### **Get excited about our new packaging!**

We're switching from plastic to paper-based packaging. That's why you might find a mix of paper and plastic in our boxes!

### **Nos nouveaux emballages vous emballeront !**

Nous passons des emballages en plastique aux emballages à base de papier. C'est pourquoi vous pourriez trouver un mélange de papier et de plastique dans nos boîtes !

### **¡Te presentamos nuestros nuevos empaques!**

Estamos sustituyendo las bolsas de plástico por bolsas con base de papel. ¡Por eso, puedes encontrar una mezcla de papel y de plástico en nuestras cajas!

**[LEGO.com/sustainable-packaging](https://www.lego.com/sustainable-packaging)**

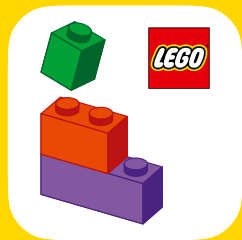

LEGO® Builder



# BUILDER



Apple and the Apple logo are trademarks of Apple Inc., registered in the U.S. and other countries and regions. App Store is a service mark of Apple Inc. Google Play and the Google Play logo are trademarks of Google LLC. Tencent and the Tencent logo are trademarks of Tencent Inc.

[LEGO.com/devicecheck](https://www.lego.com/devicecheck)

EN Ask parents' permission before going online | DE Eltern um Erlaubnis bitten, bevor du online gehst | FR Demande l'autorisation d'un parent avant d'aller en ligne | IT Chiedi il permesso ai tuoi genitori prima di andare online | ES Pídeles permiso a tus papás antes de conectarte a Internet | PT Pede autorização aos teus pais antes de ficares online | ZH 上网前应先征得父母的同意 | PL Poproś rodziców o zgodę, zanim wejdiesz do Internetu | CS Než půjdeš na internet, požádej rodiče o svolení | SK Skôr než pôjdeš na internet, vypýtaj si povolenie od rodičov | HU Kérj szülői engedélyt, mielőtt online csatlakoznál! | UA Запитуйте дозволу батьків, перш ніж користуватися інтернетом | RO cere permisiunea părinților înainte de a te conecta online | BG Поискайте разрешение от родител, преди да влезете онлайн | LV Pirms došanās tiešsaistē palūdz atļauju vecākiem | ET Enne Interneti kasutamist küsi vanematelt luba | LT Prieš prisijungdami prie interneto, atsiklauskite tėvų | TR İnternete girmeden önce anne babandan izin iste



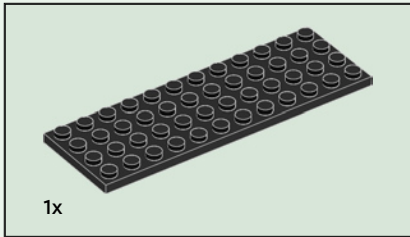

1

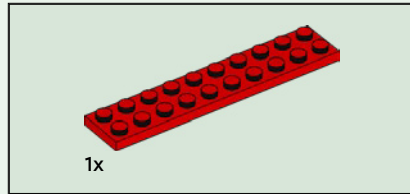
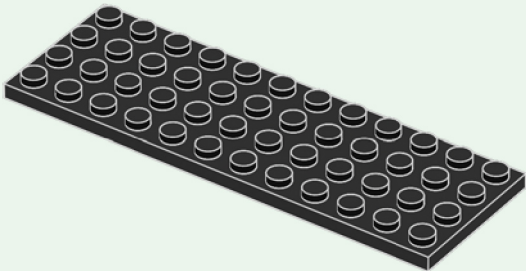

2

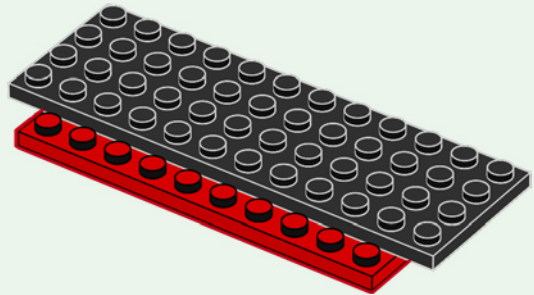

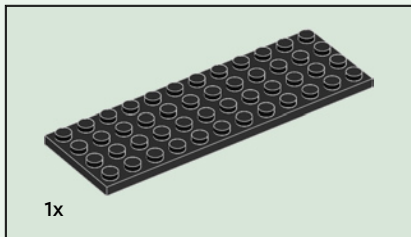

3

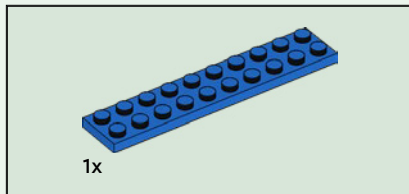
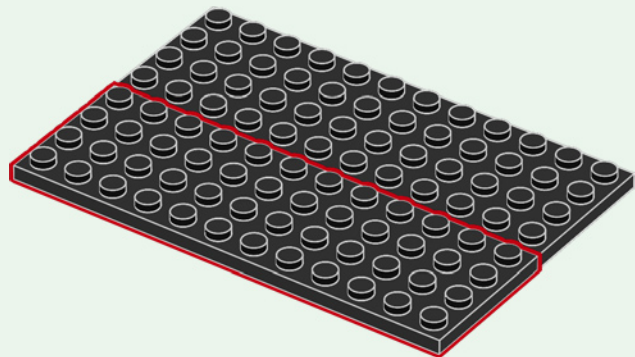

4

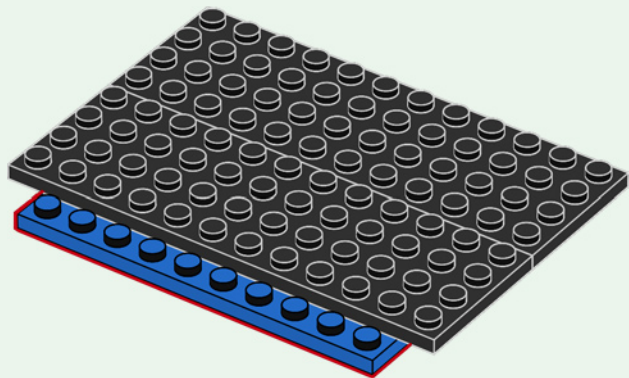

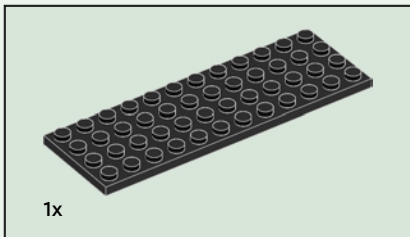

5

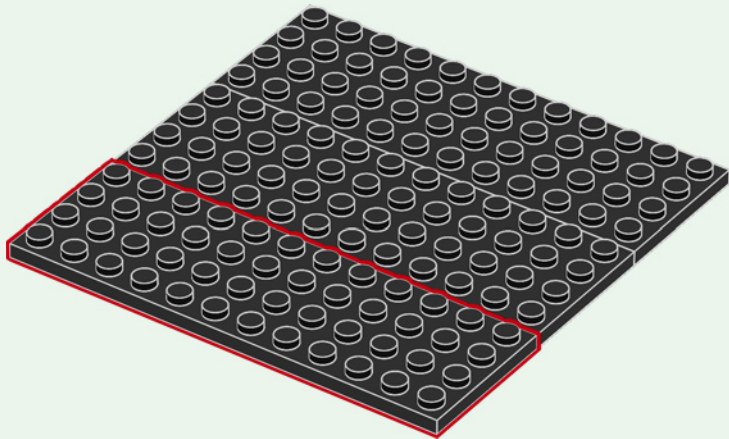

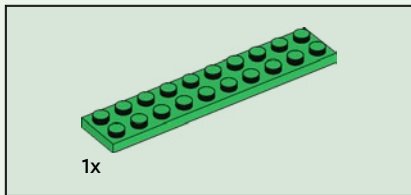

6

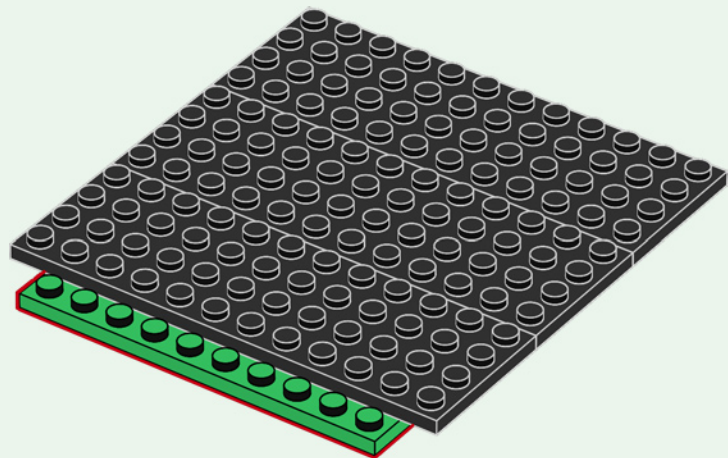

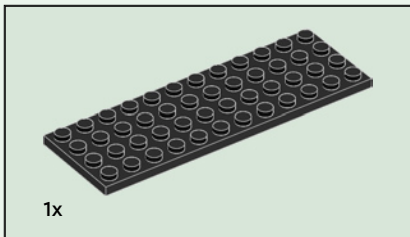

7

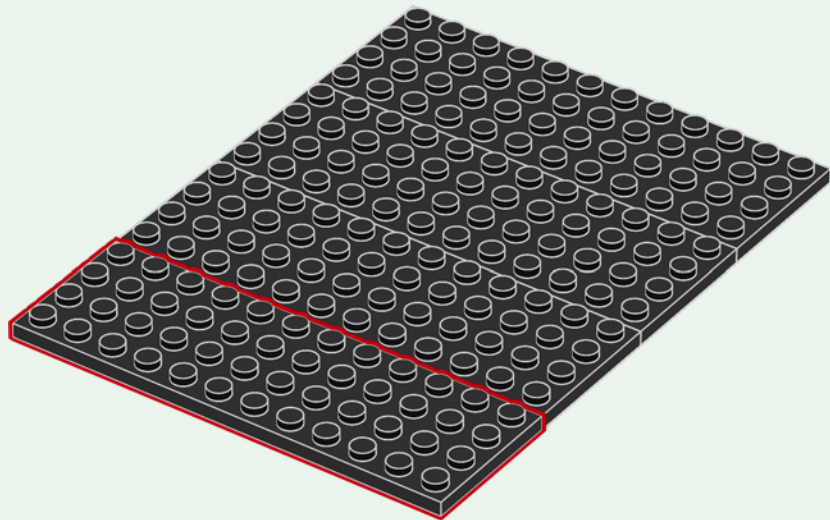

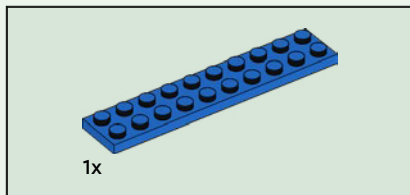

8

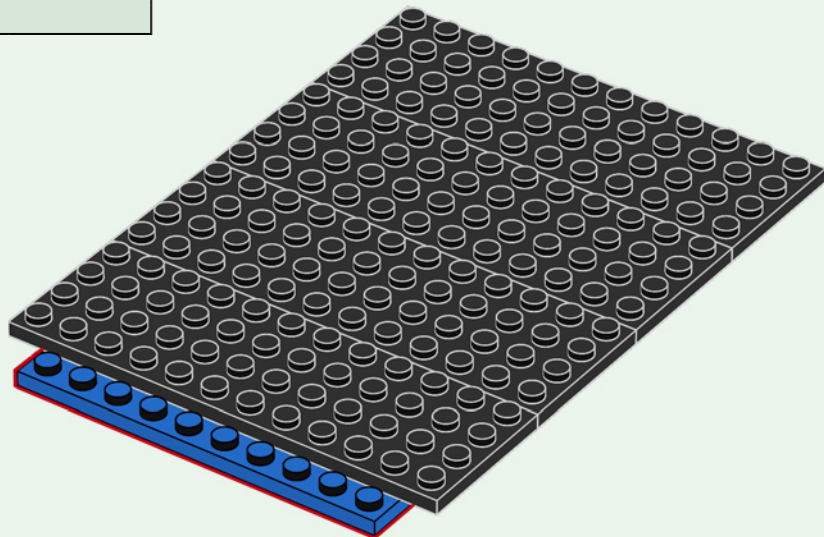

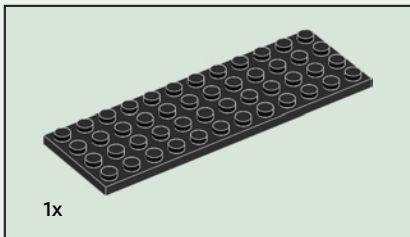

9

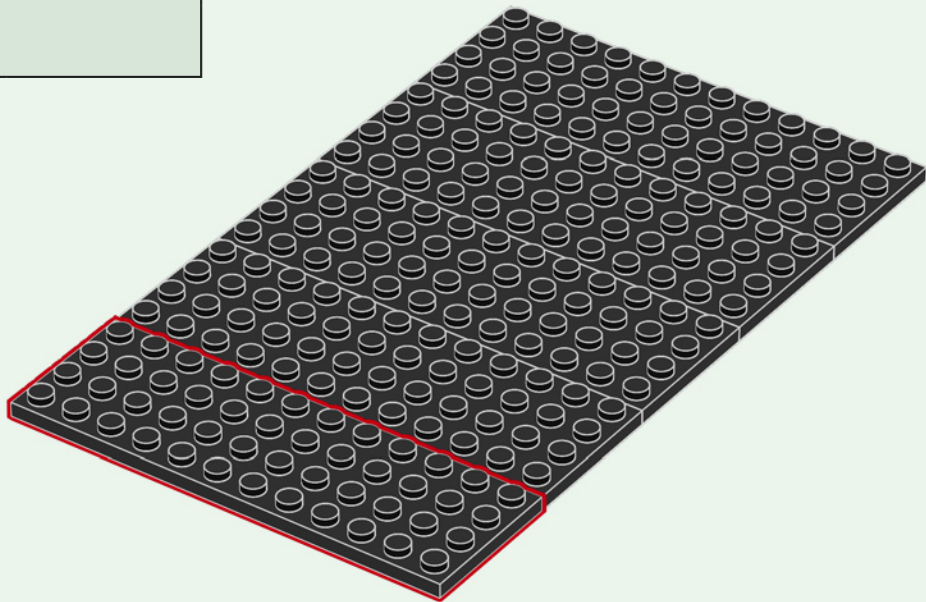

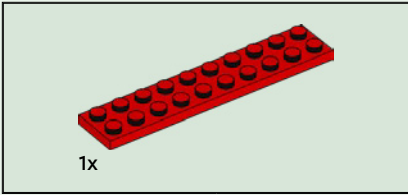

10

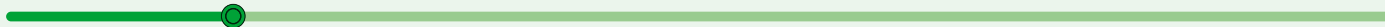
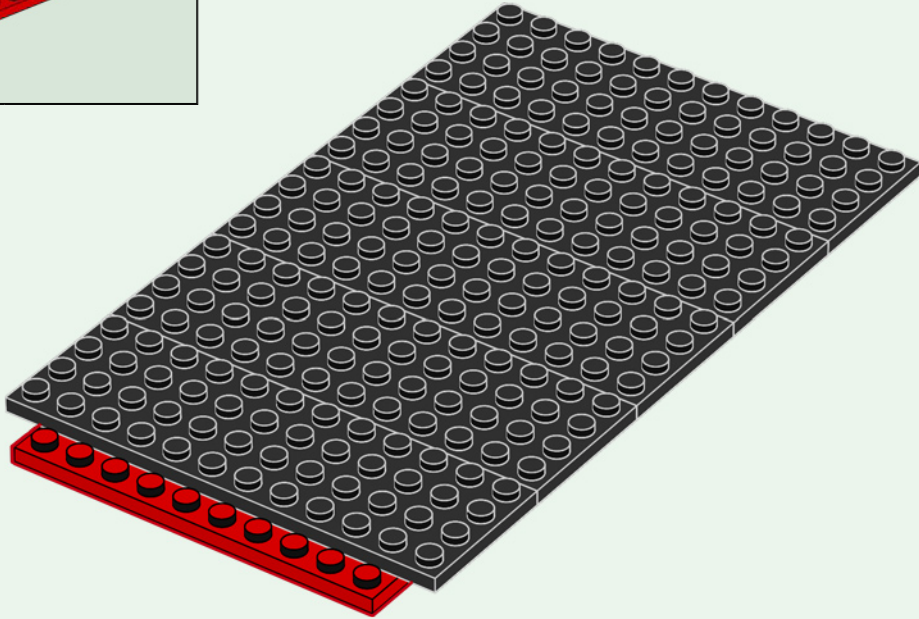

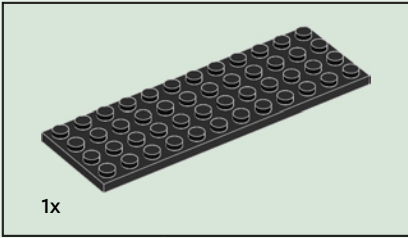

11

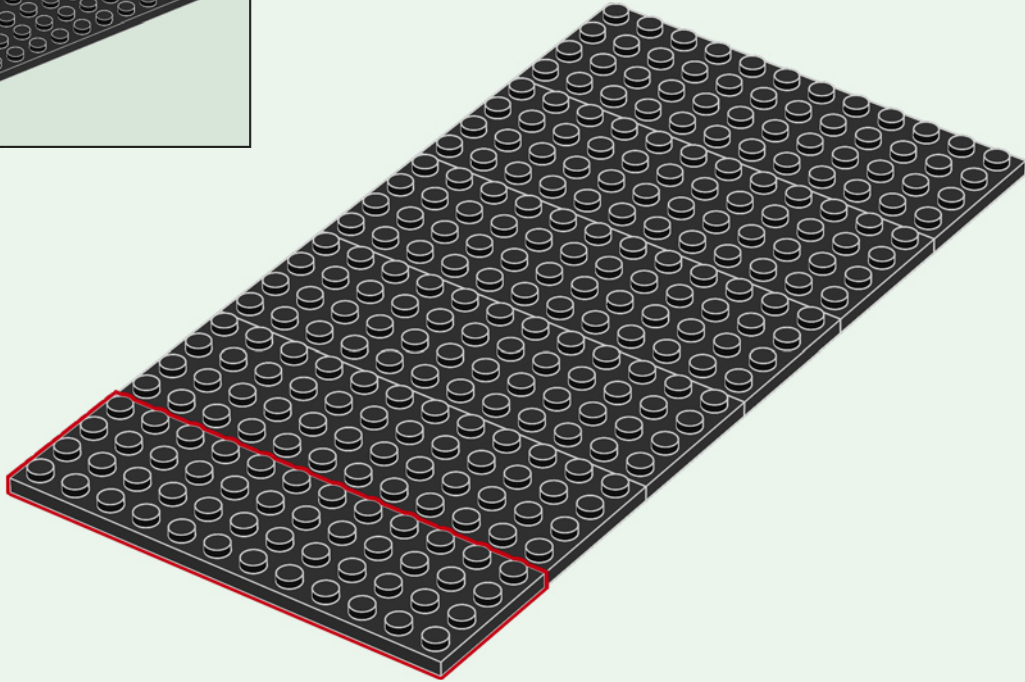

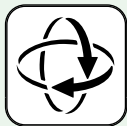
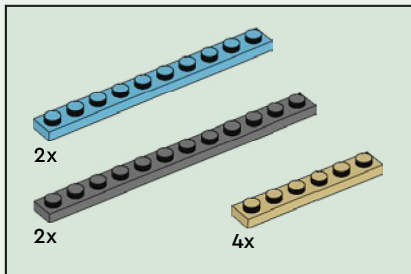

12

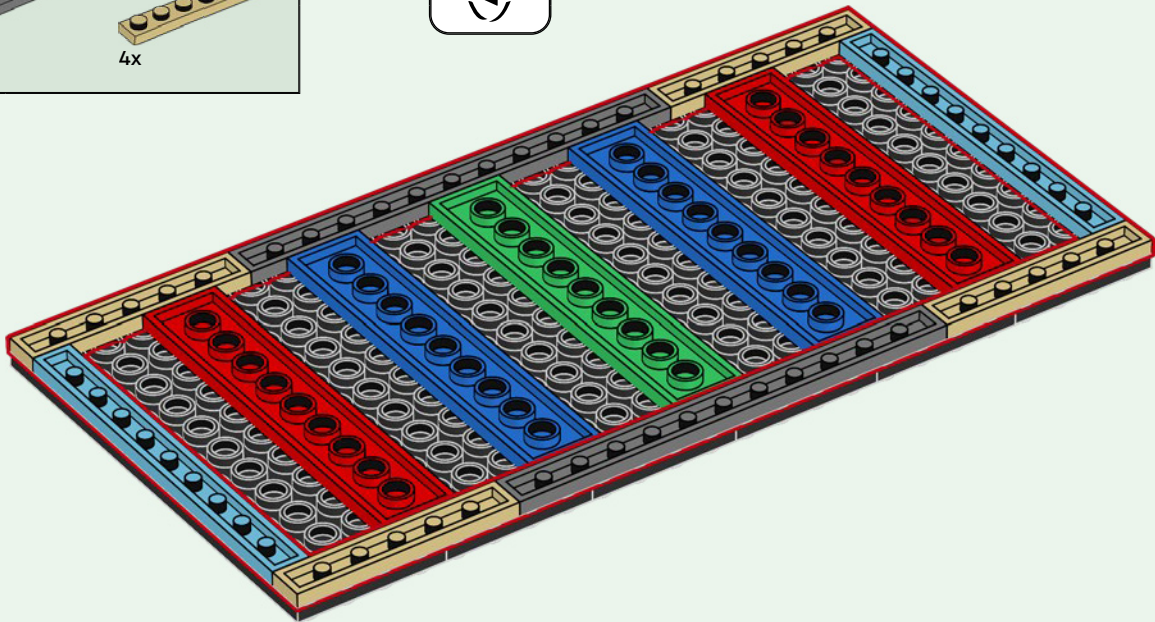



4x

13

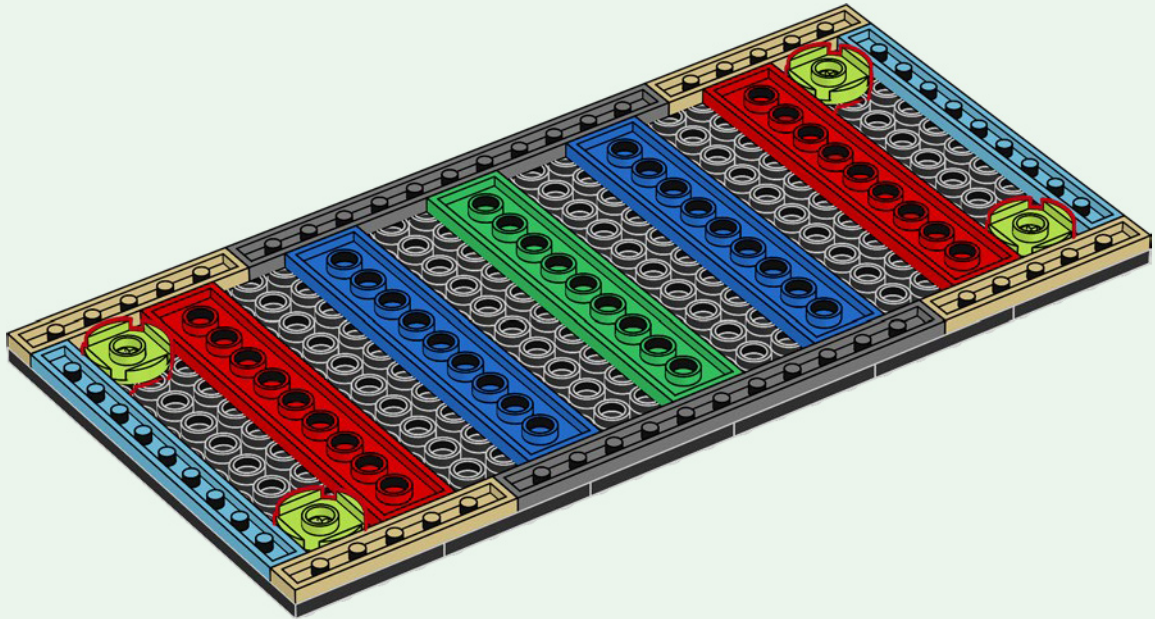

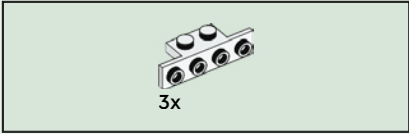

14

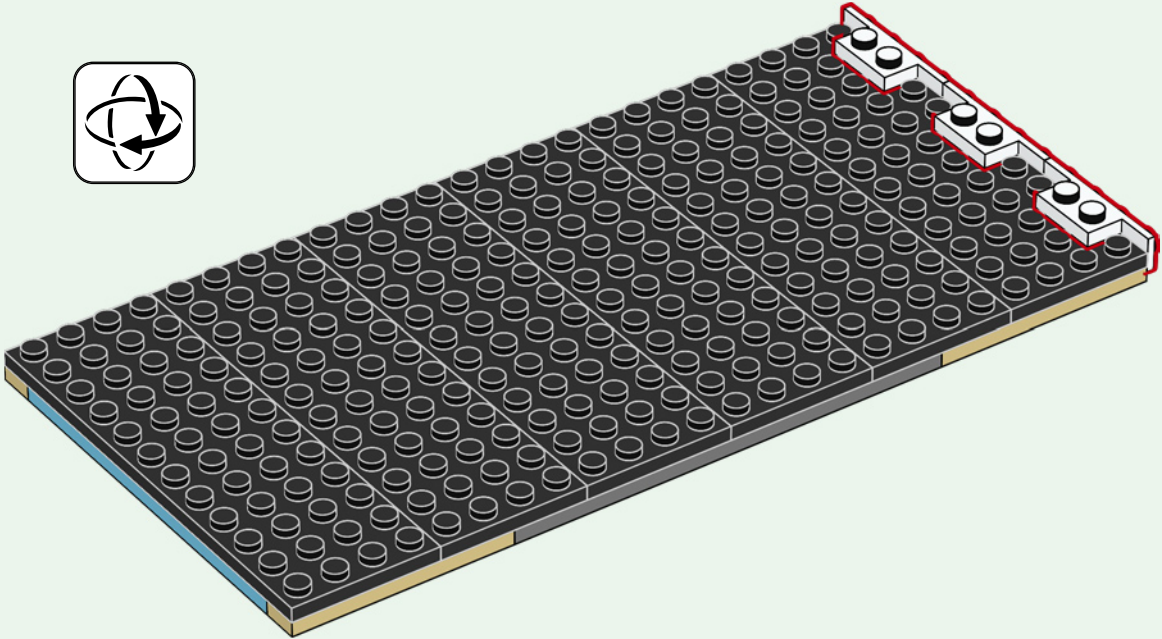

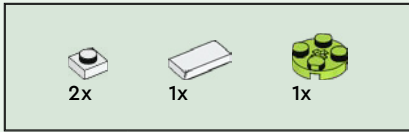

15

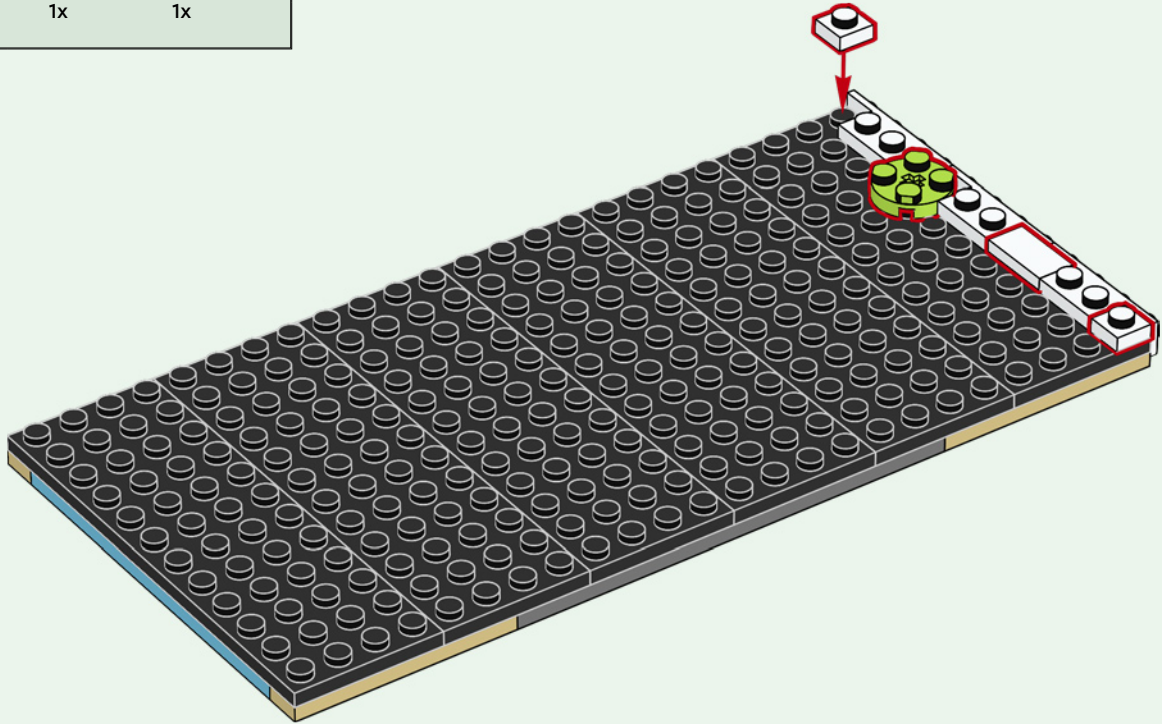

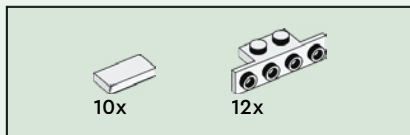

16

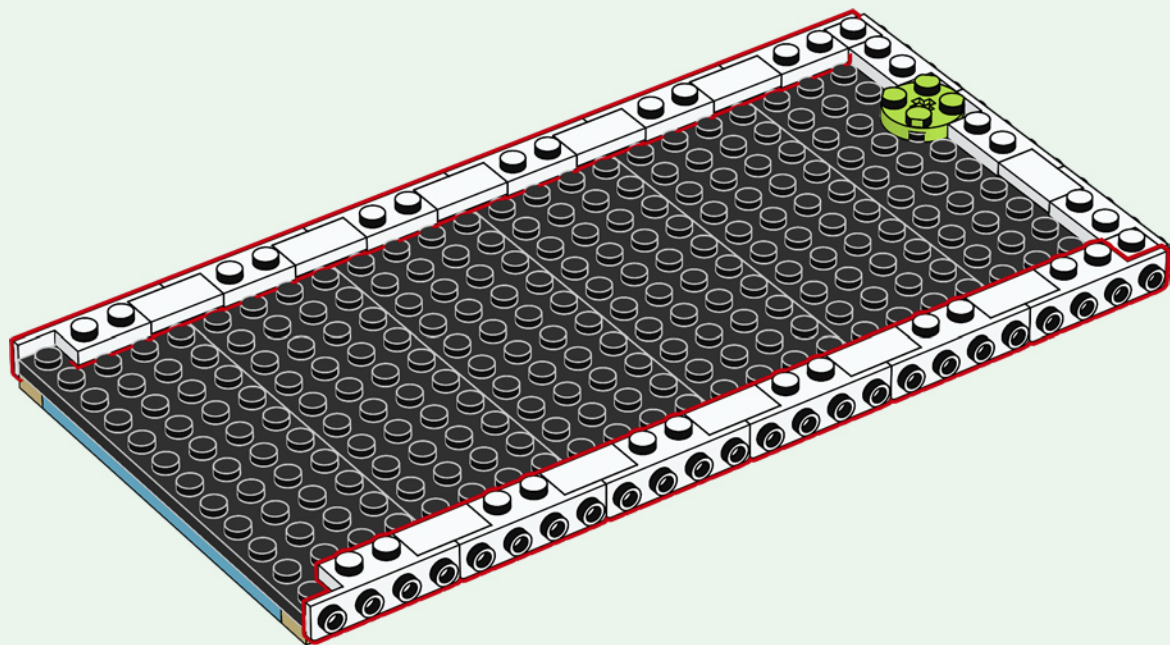

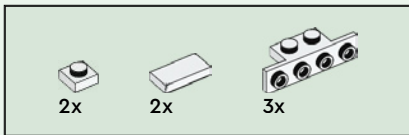

17

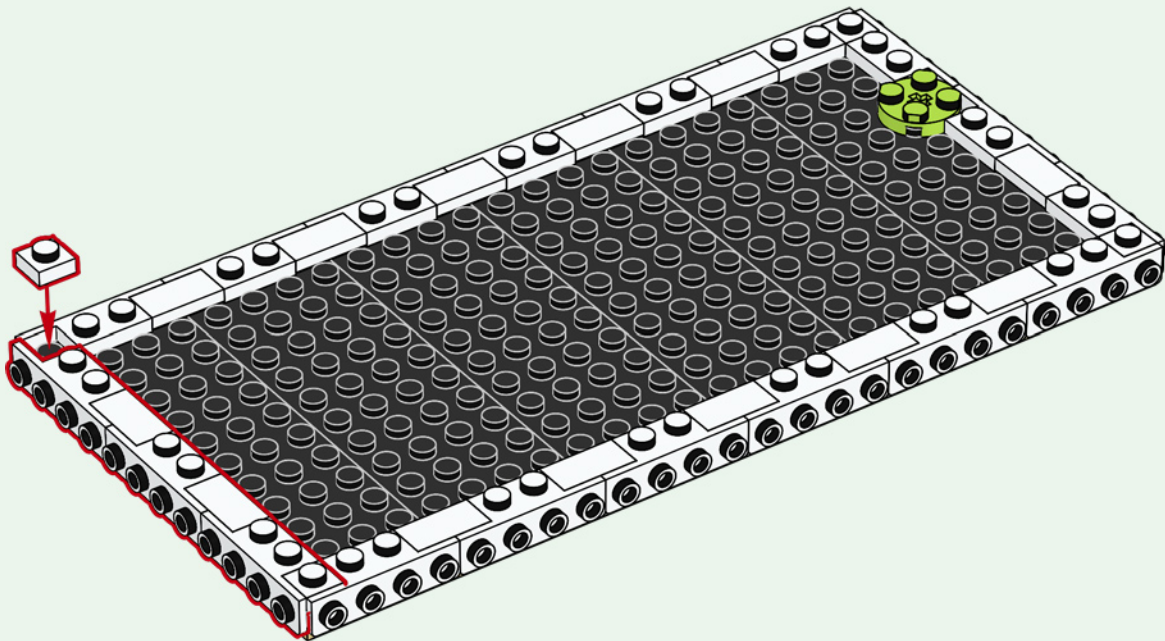

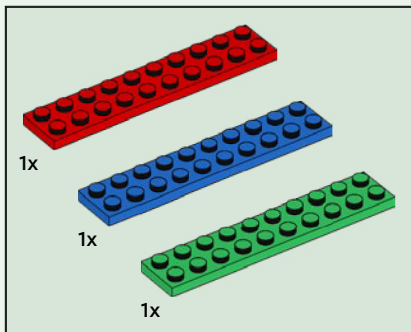

18

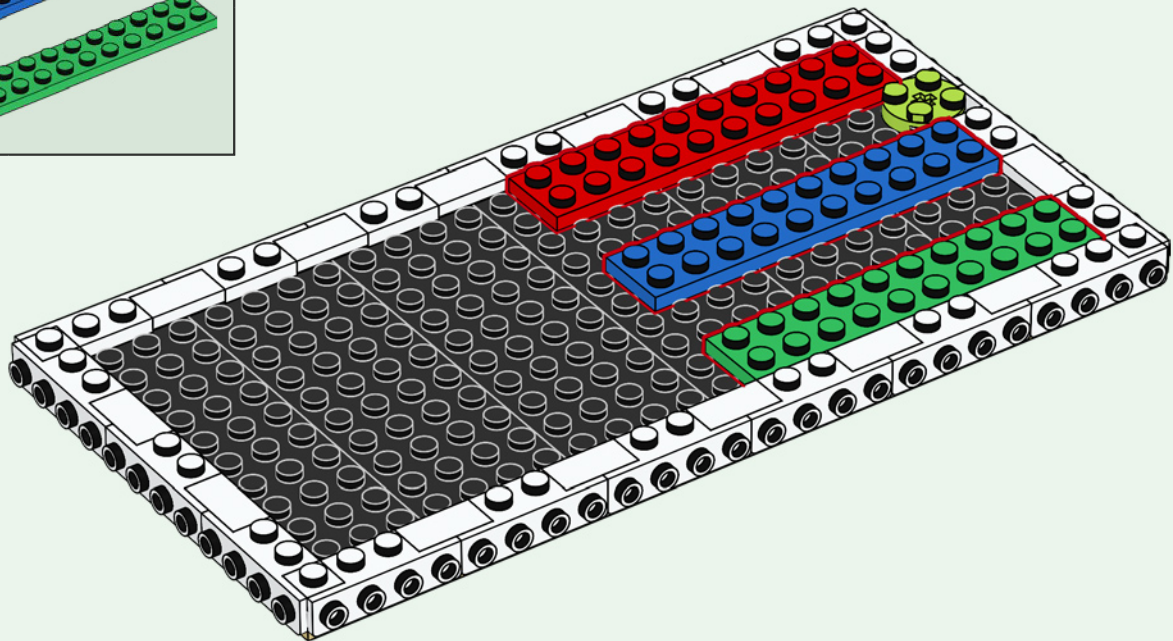



4x



1x

19

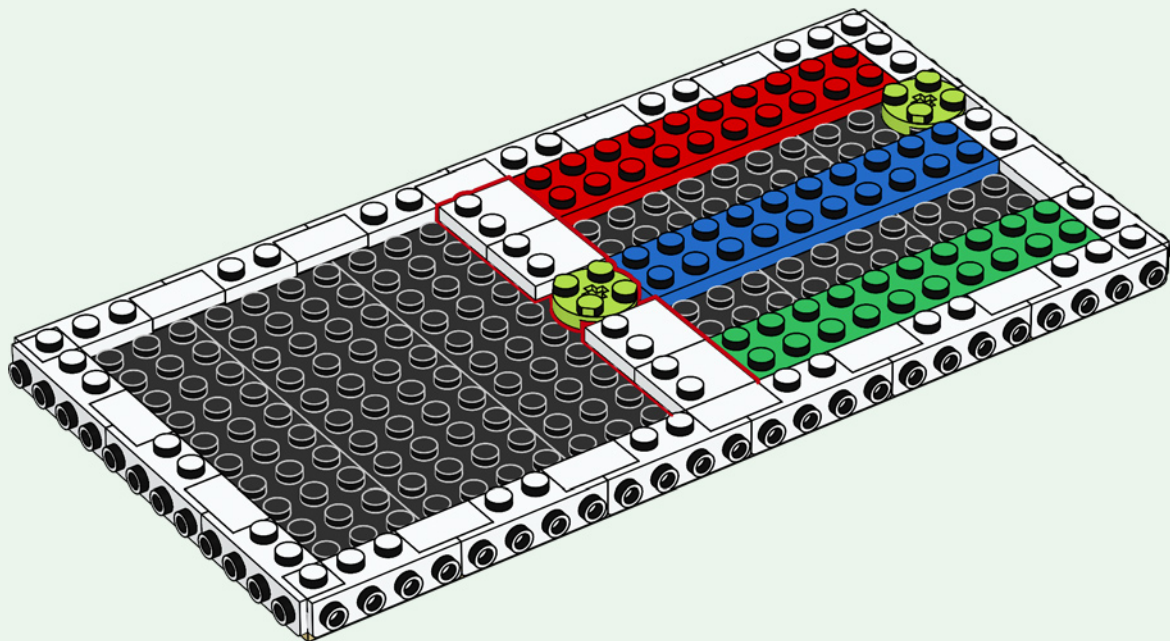

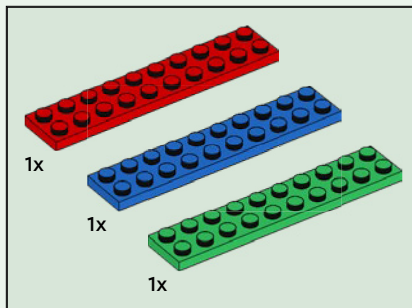

20

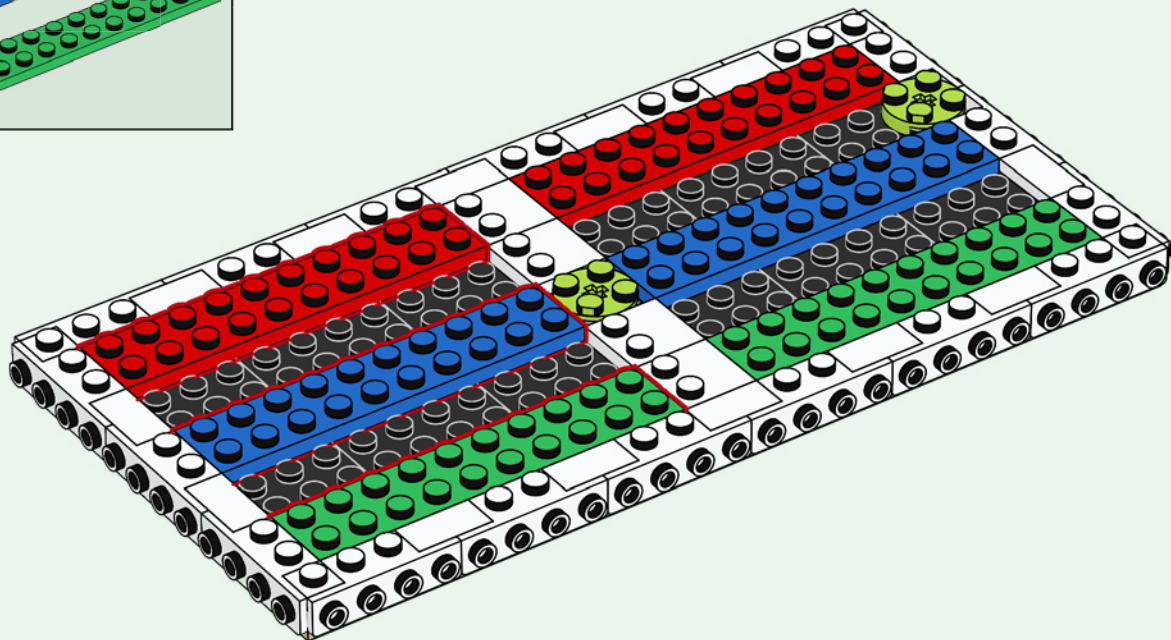





2x

21

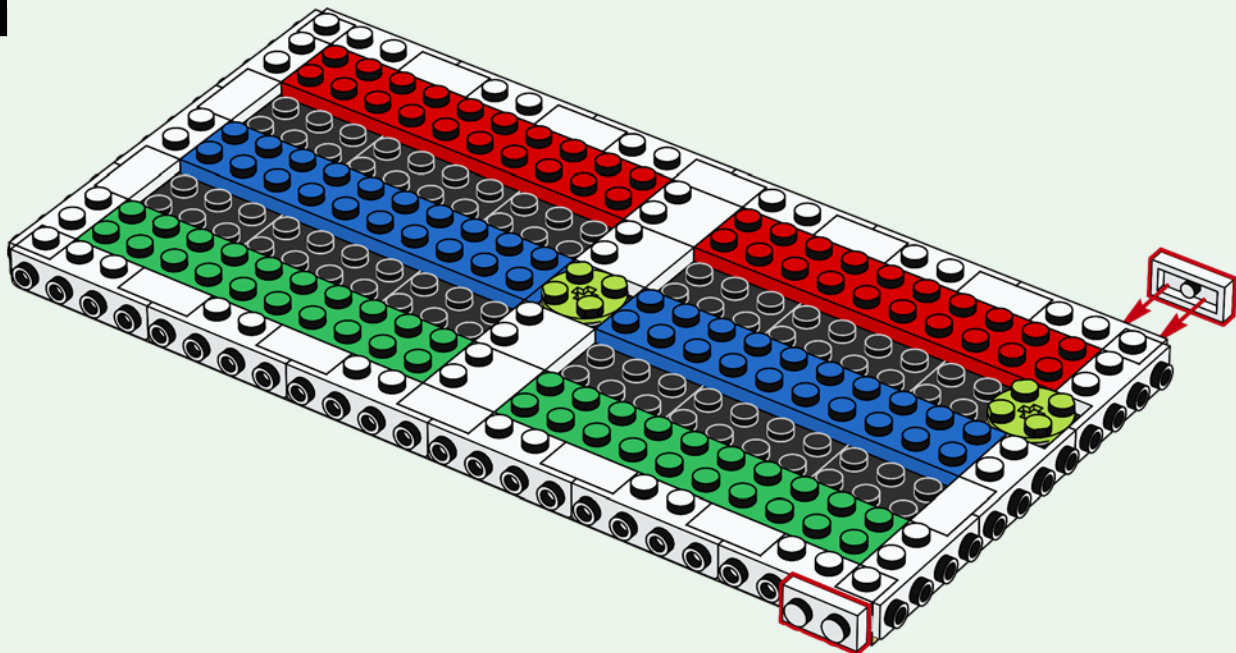



2x



2x

22

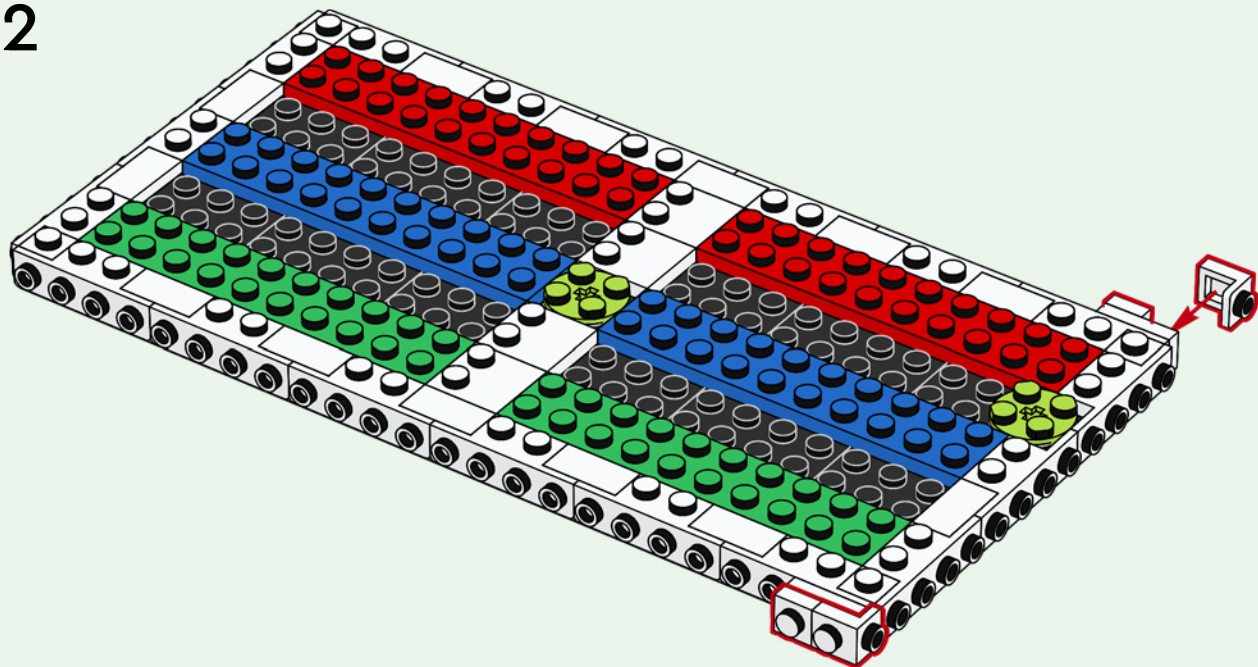



2x

23

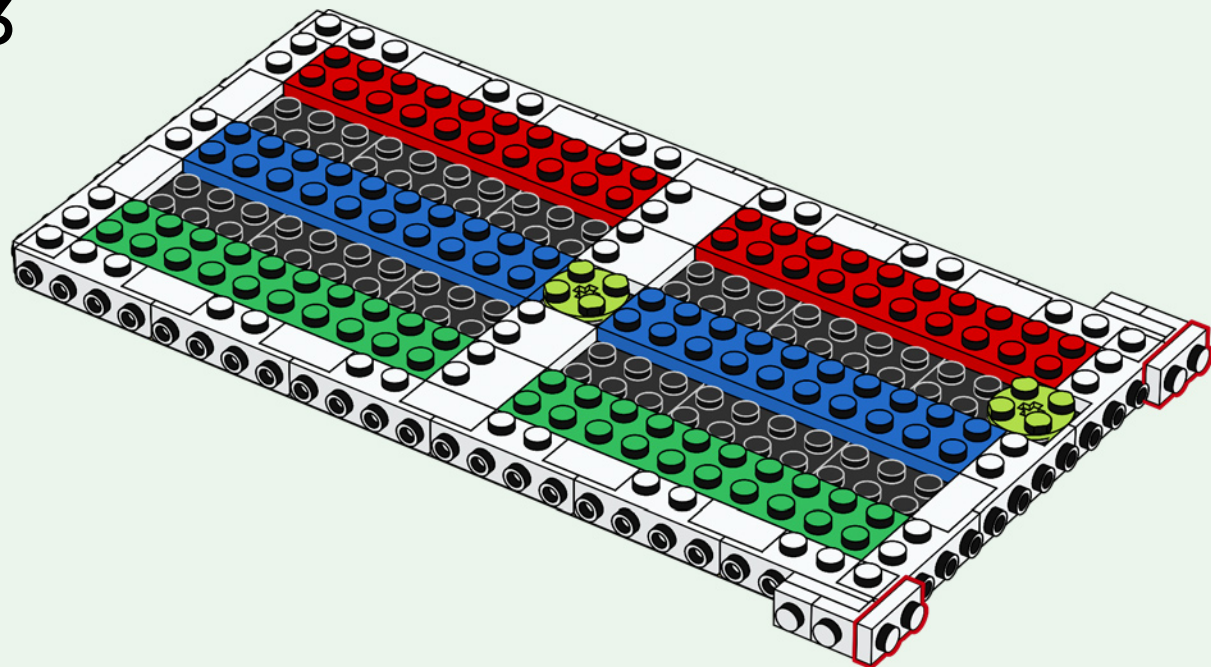

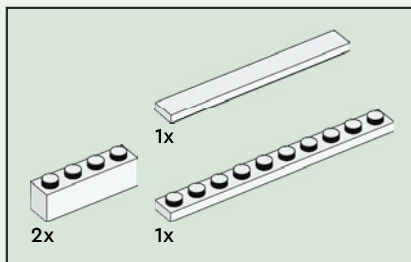

24

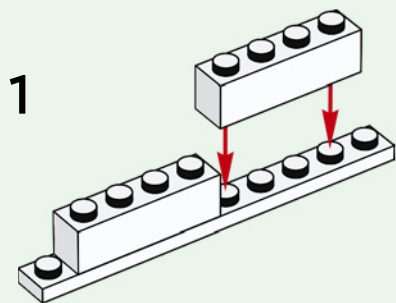

2

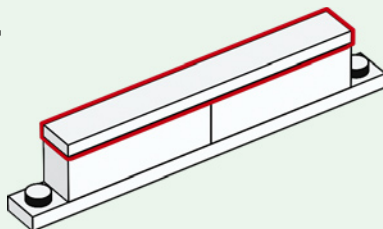

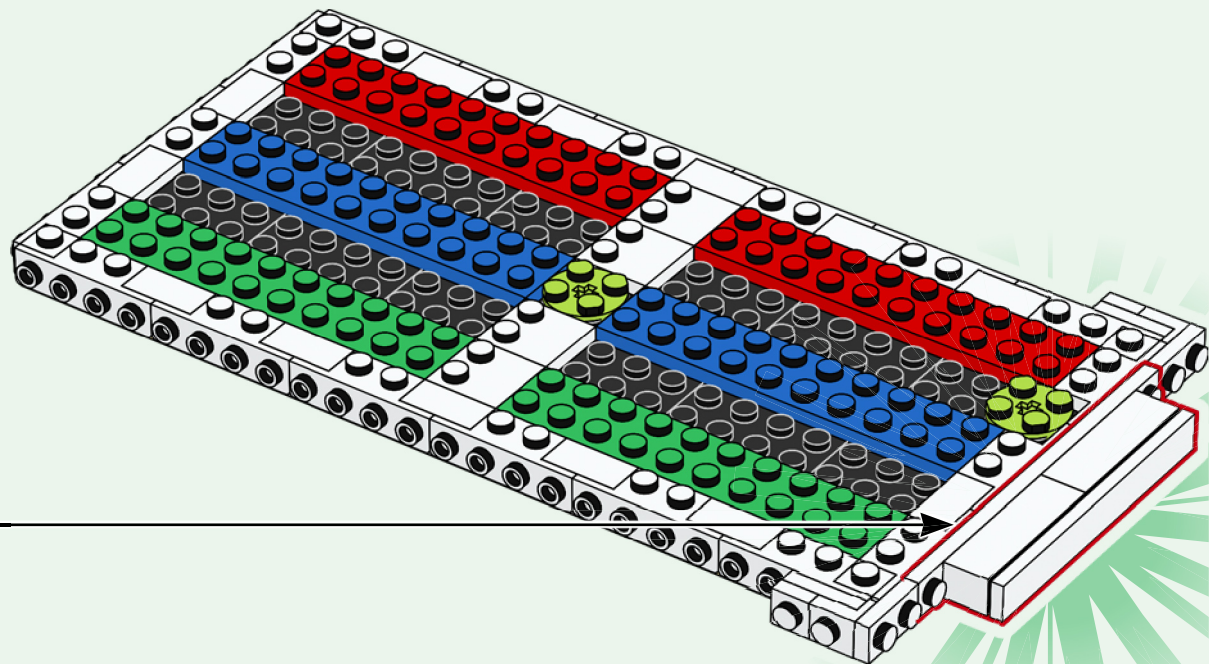

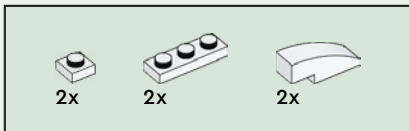

25

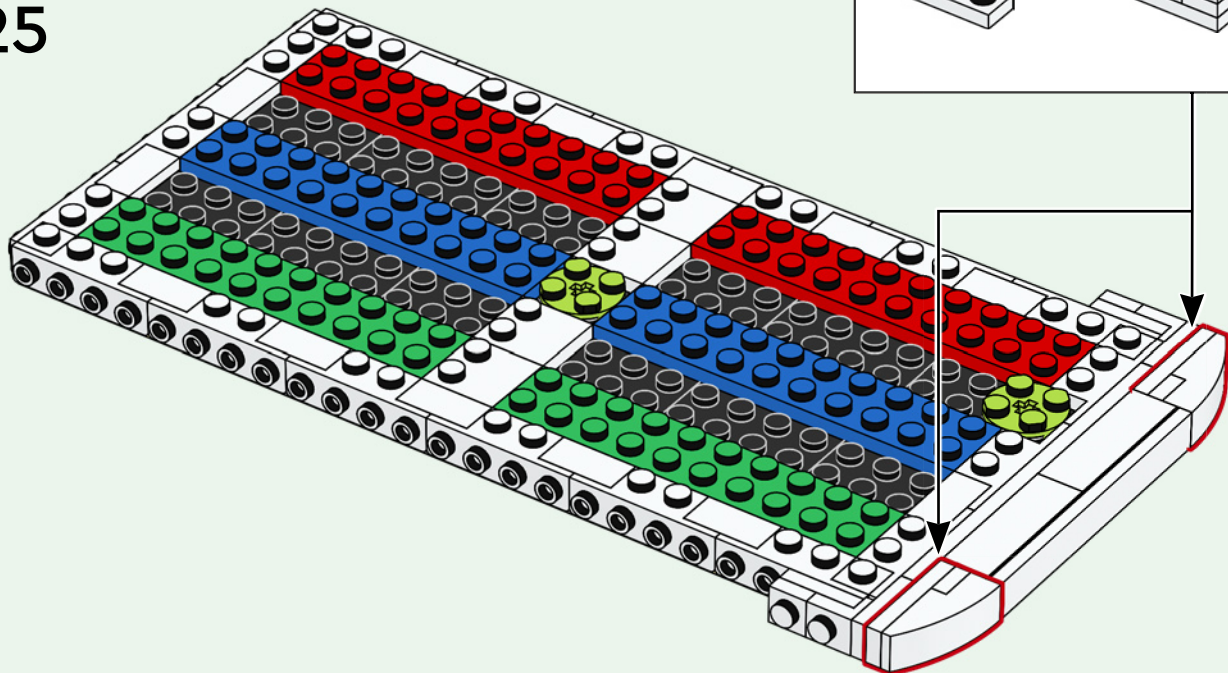
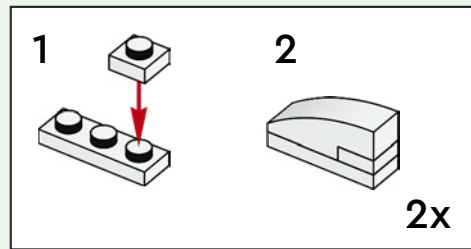

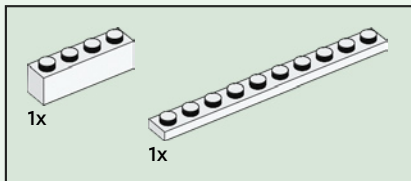
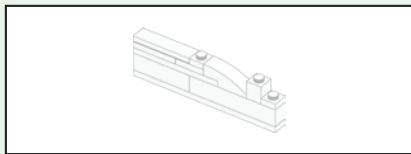

26

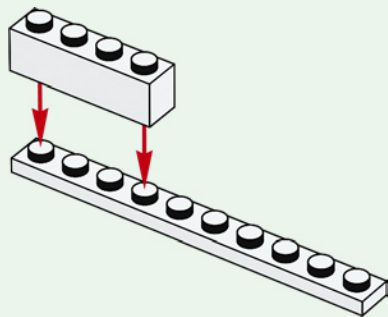

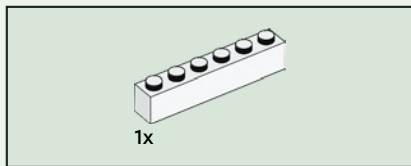

27

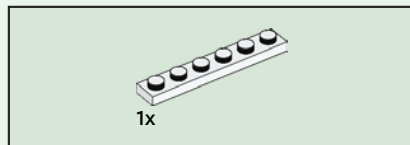
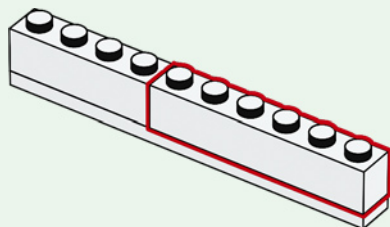

28

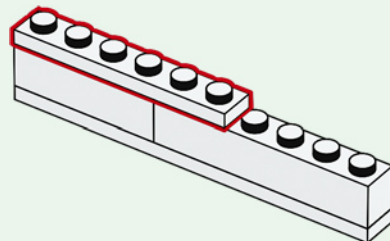

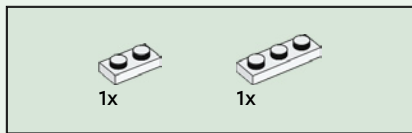

29

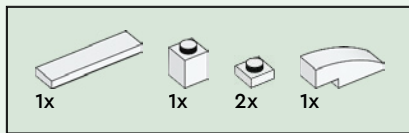
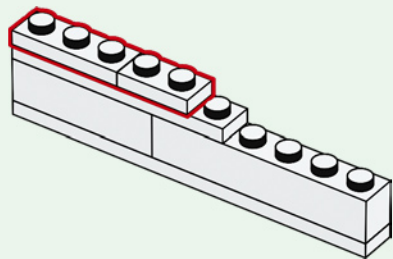

30

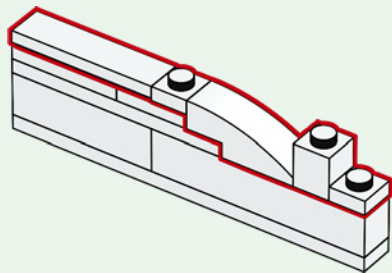

31

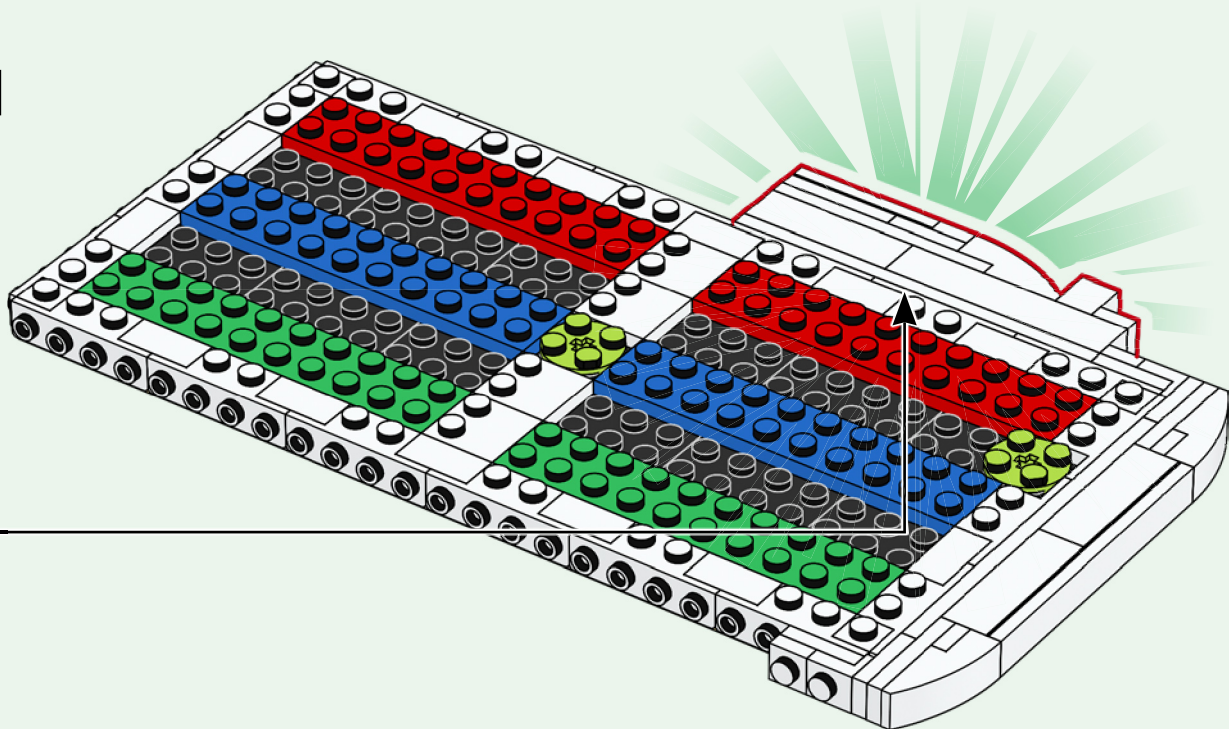

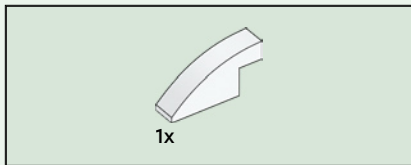

32

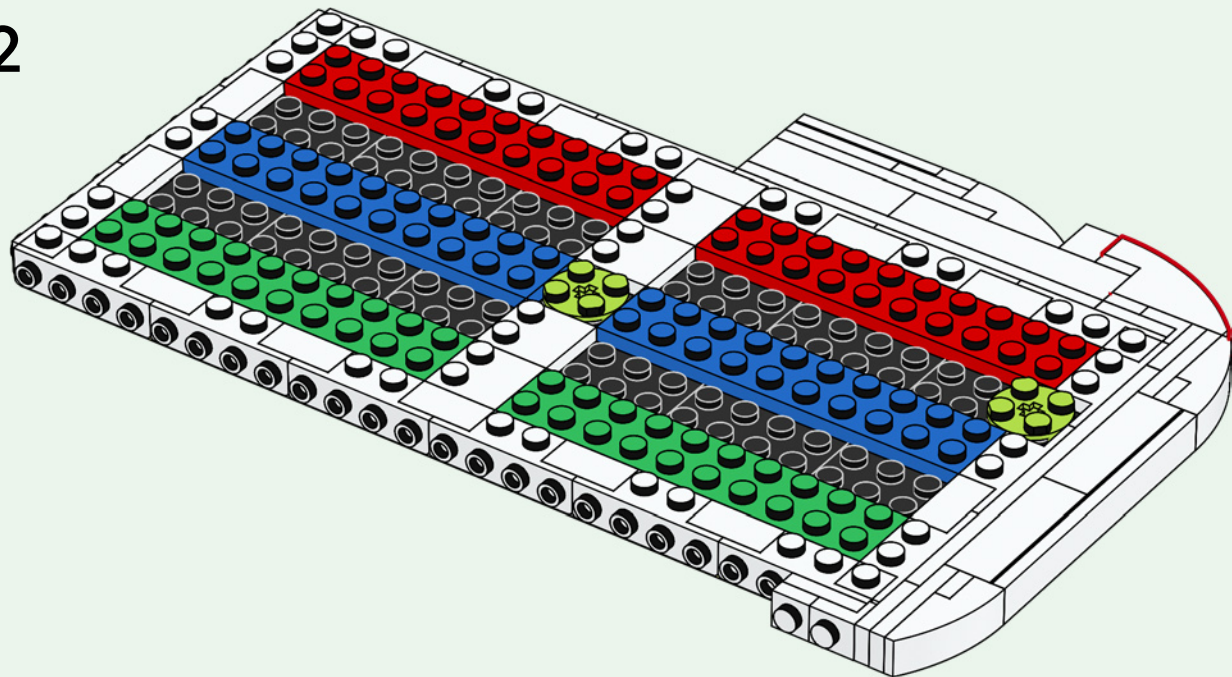

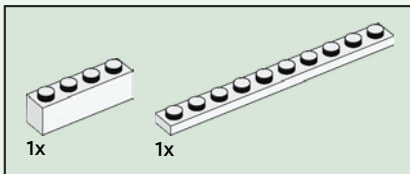
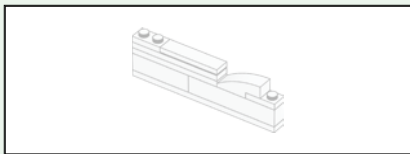

33

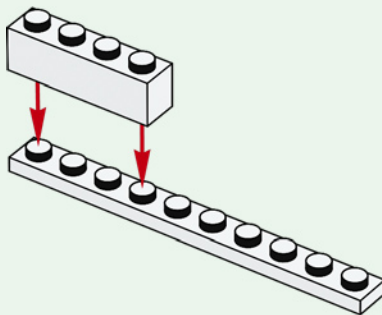

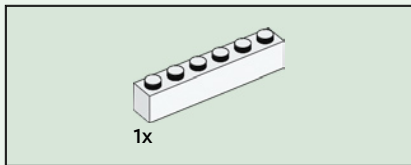

34

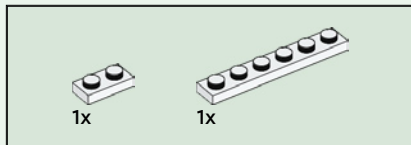
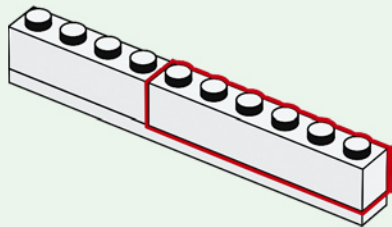

35

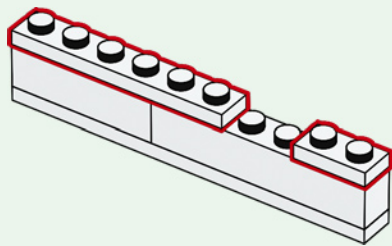

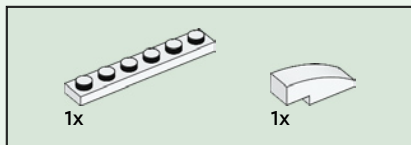

36

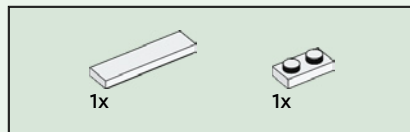
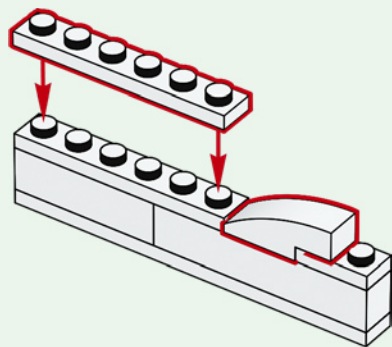

37

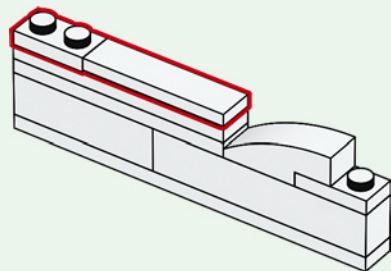

38

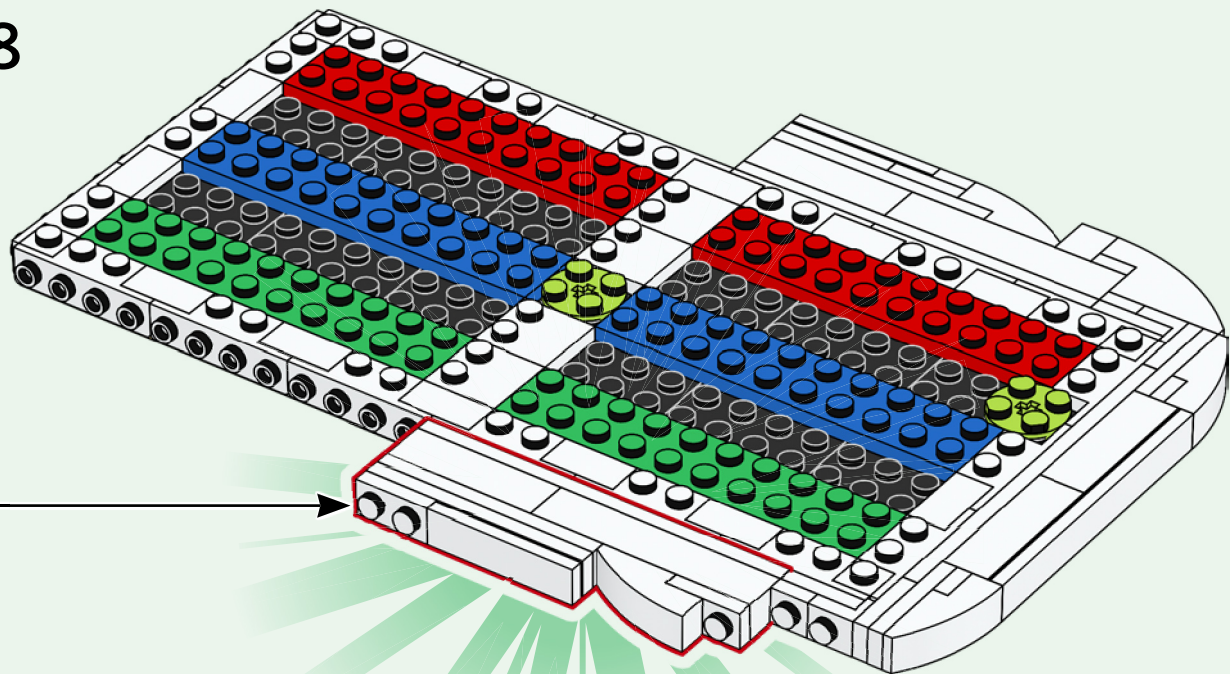

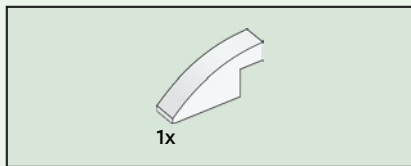

39

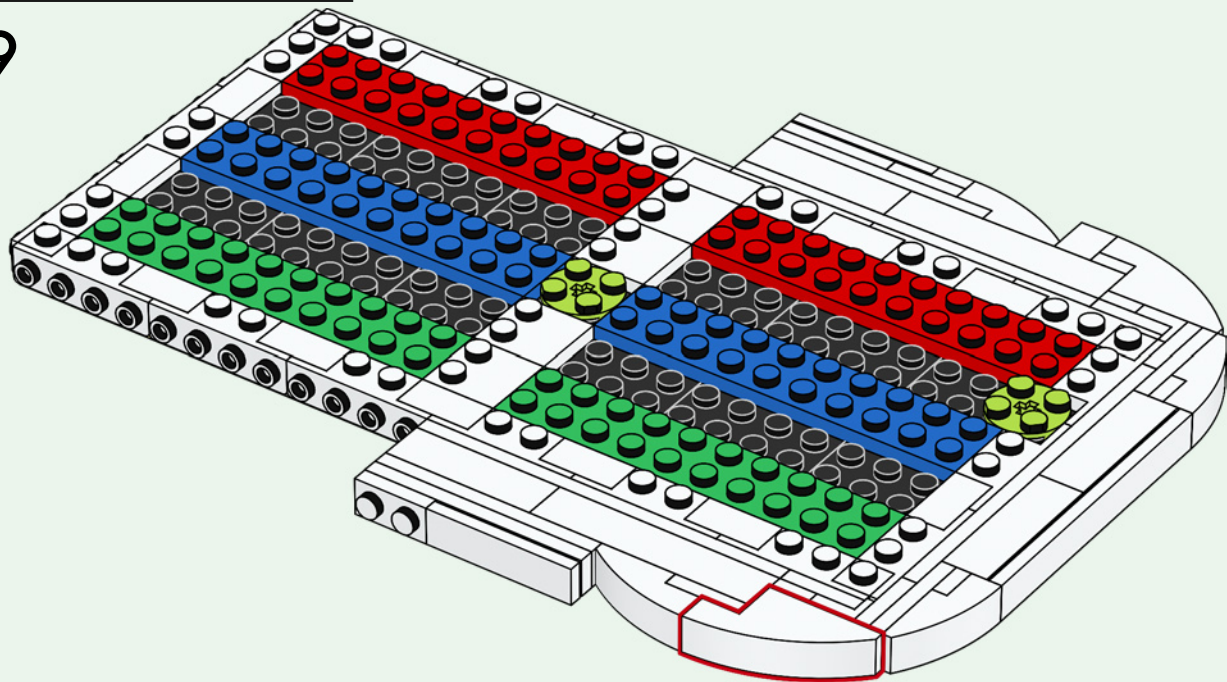

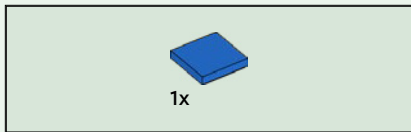

40

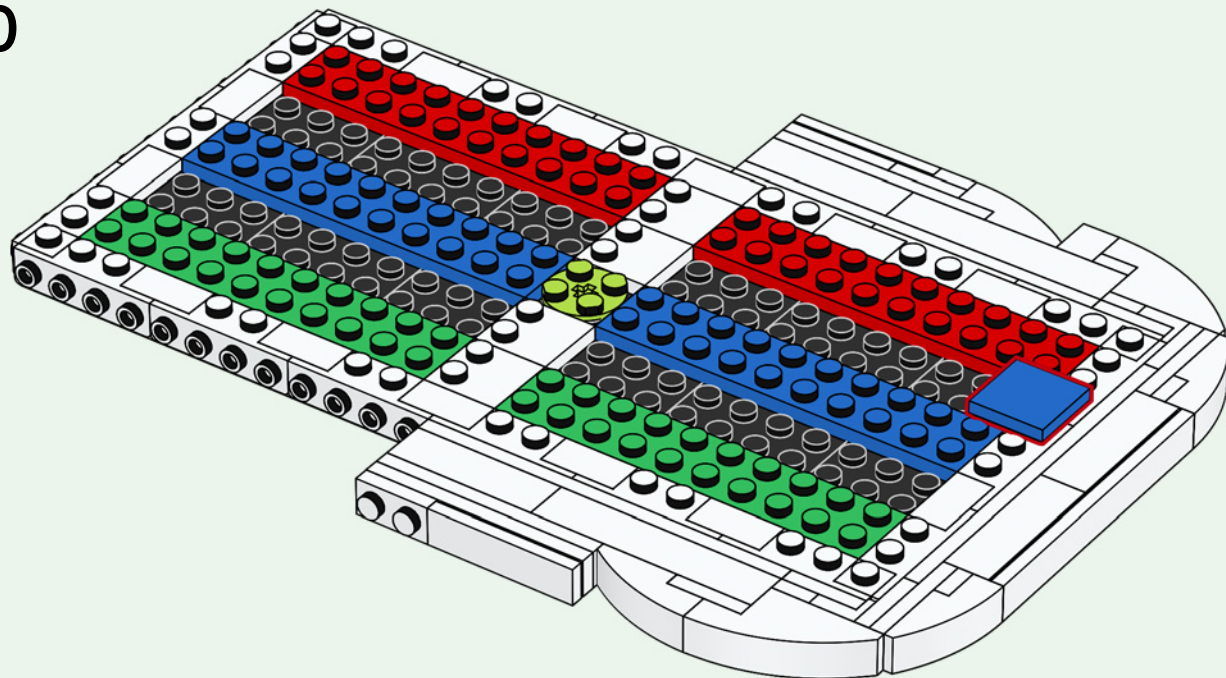

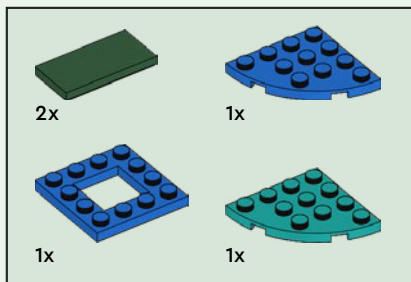

41

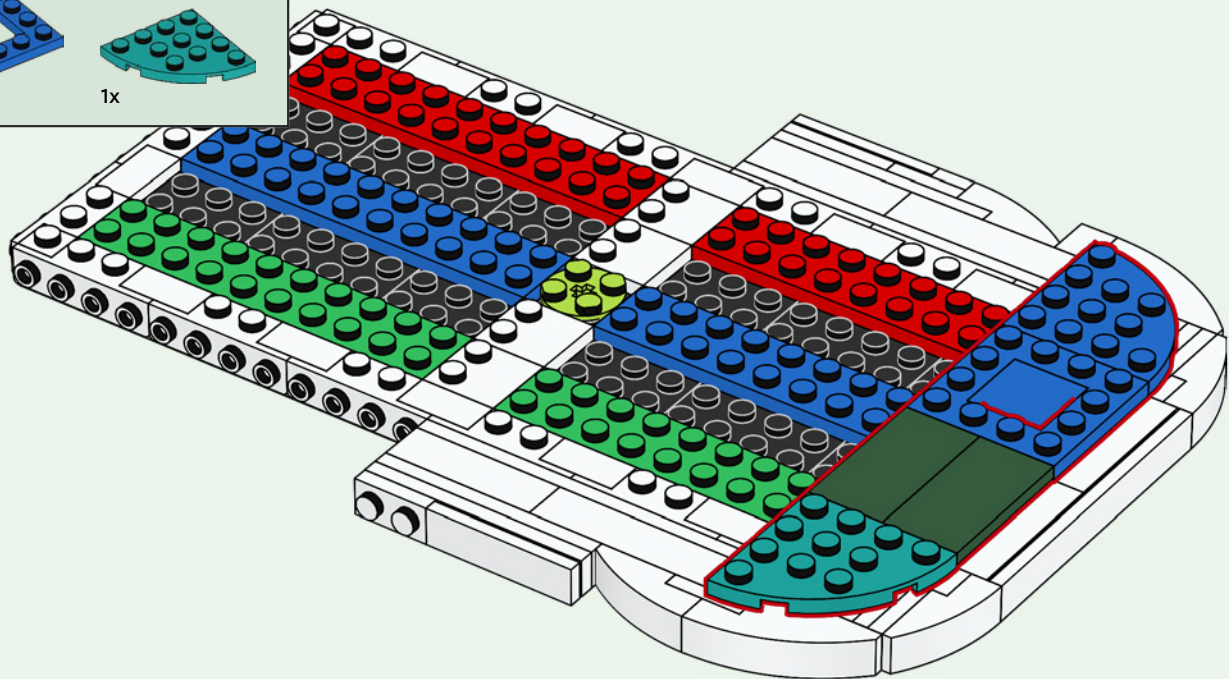

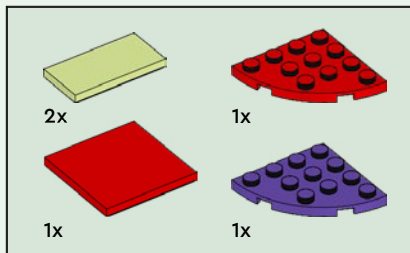

42

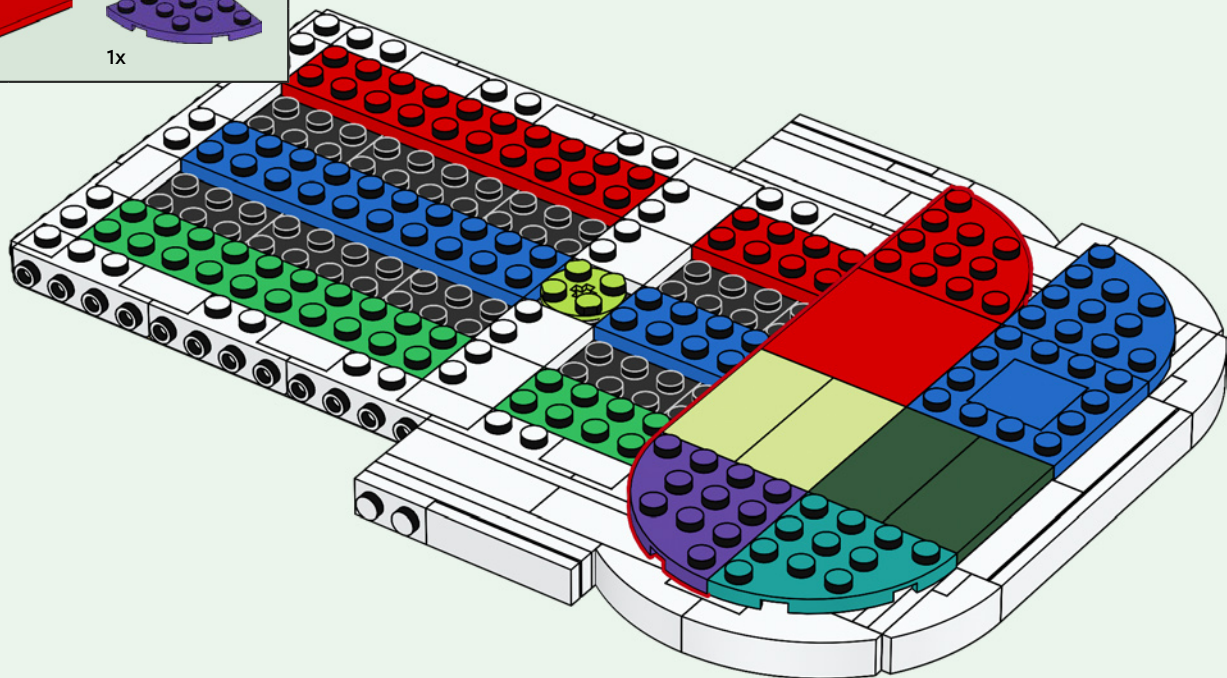







2x

44

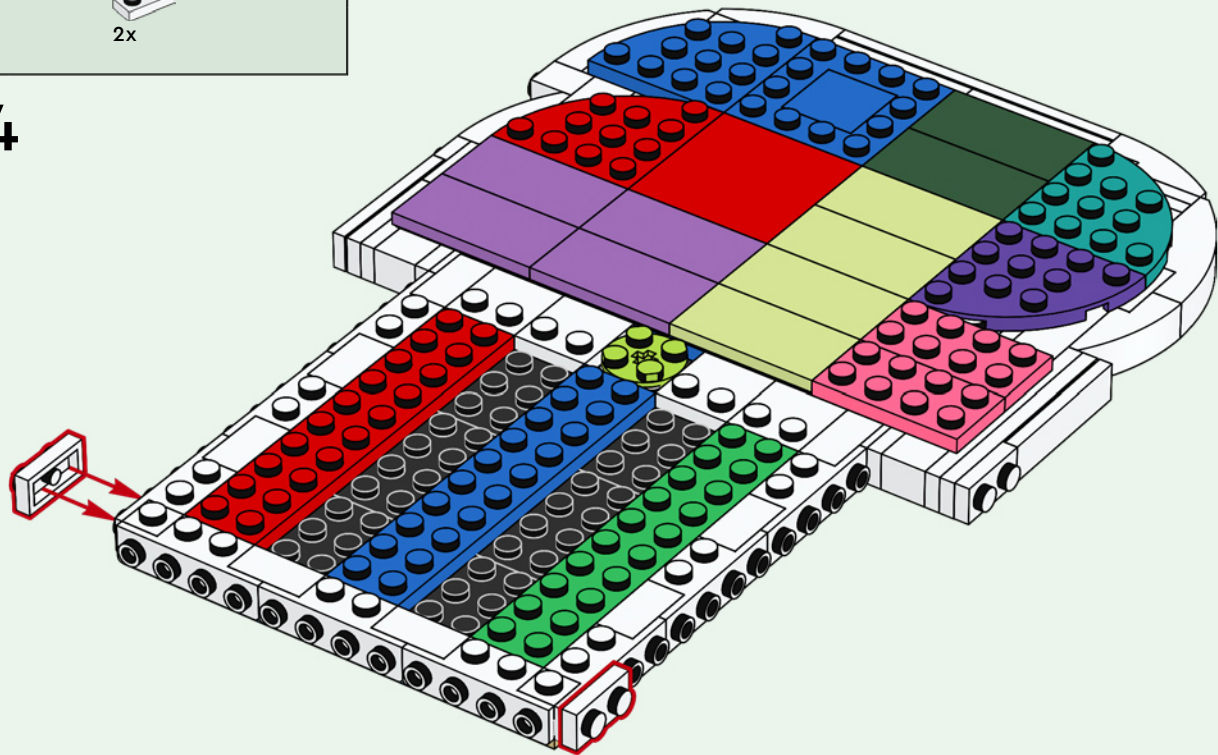



2x



2x

45

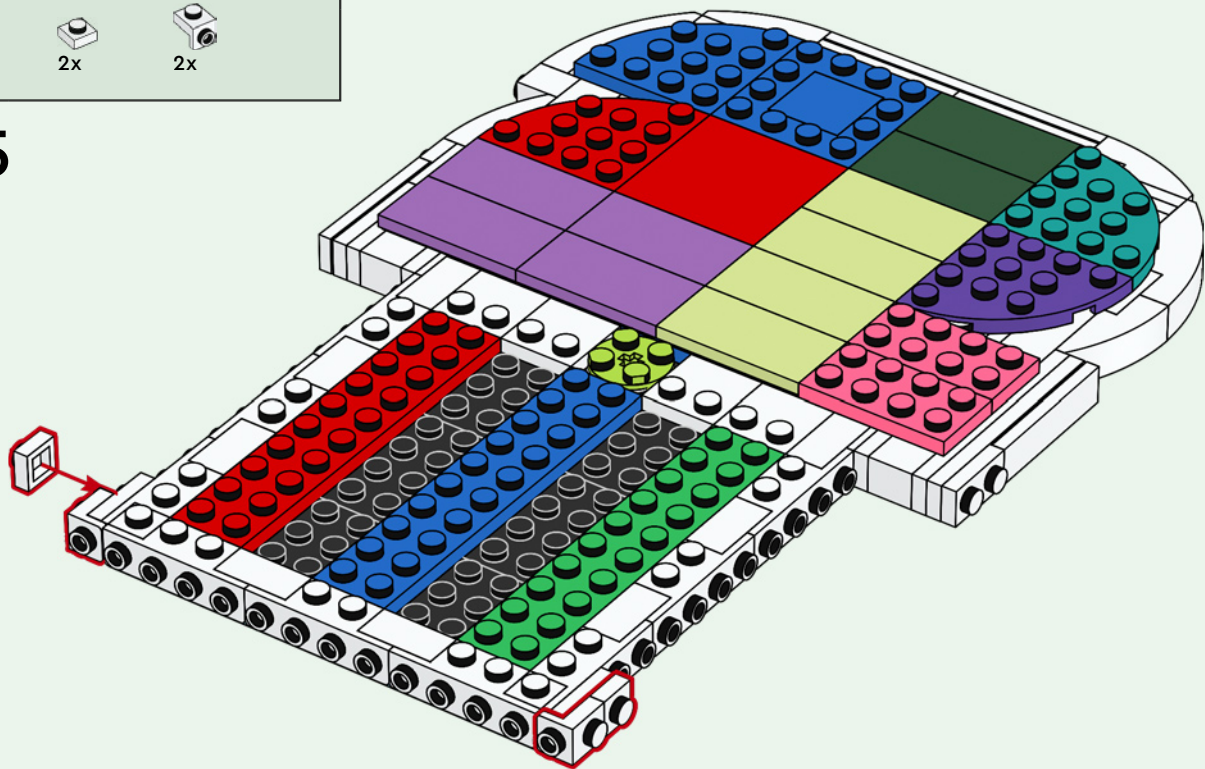

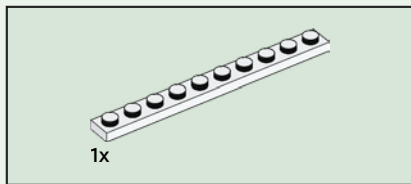

46

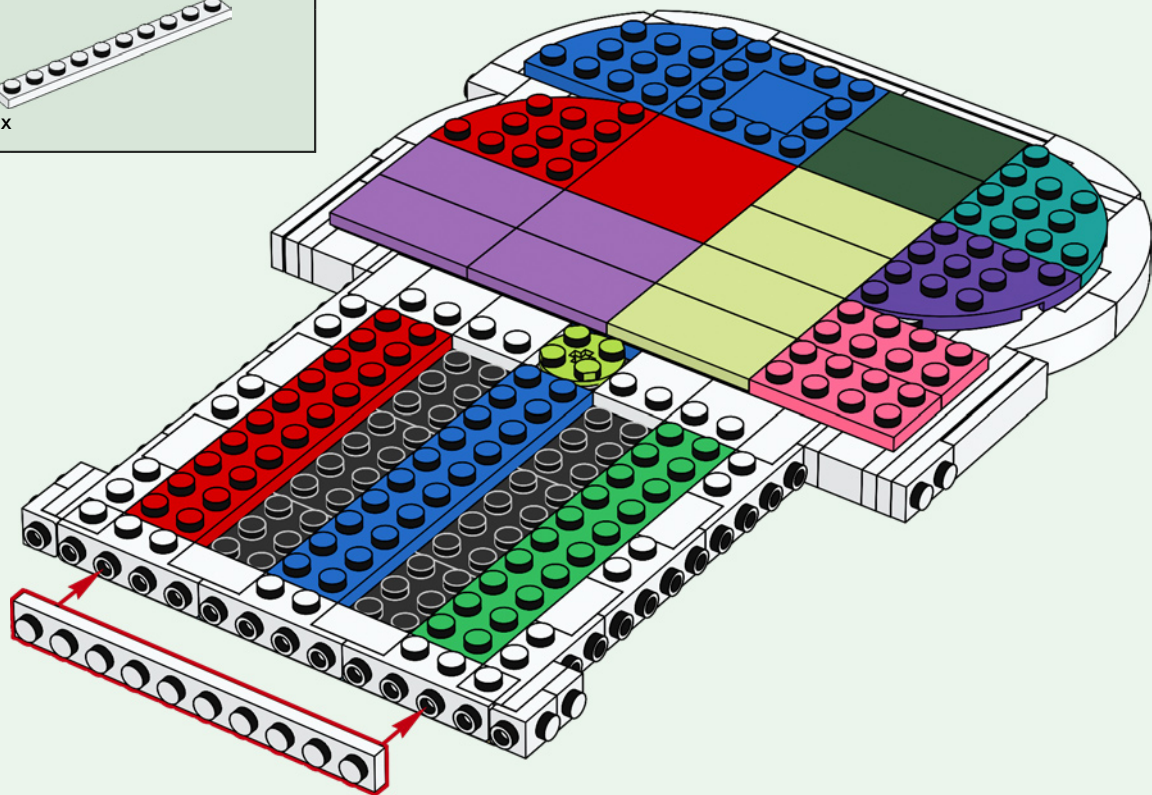



2x

47

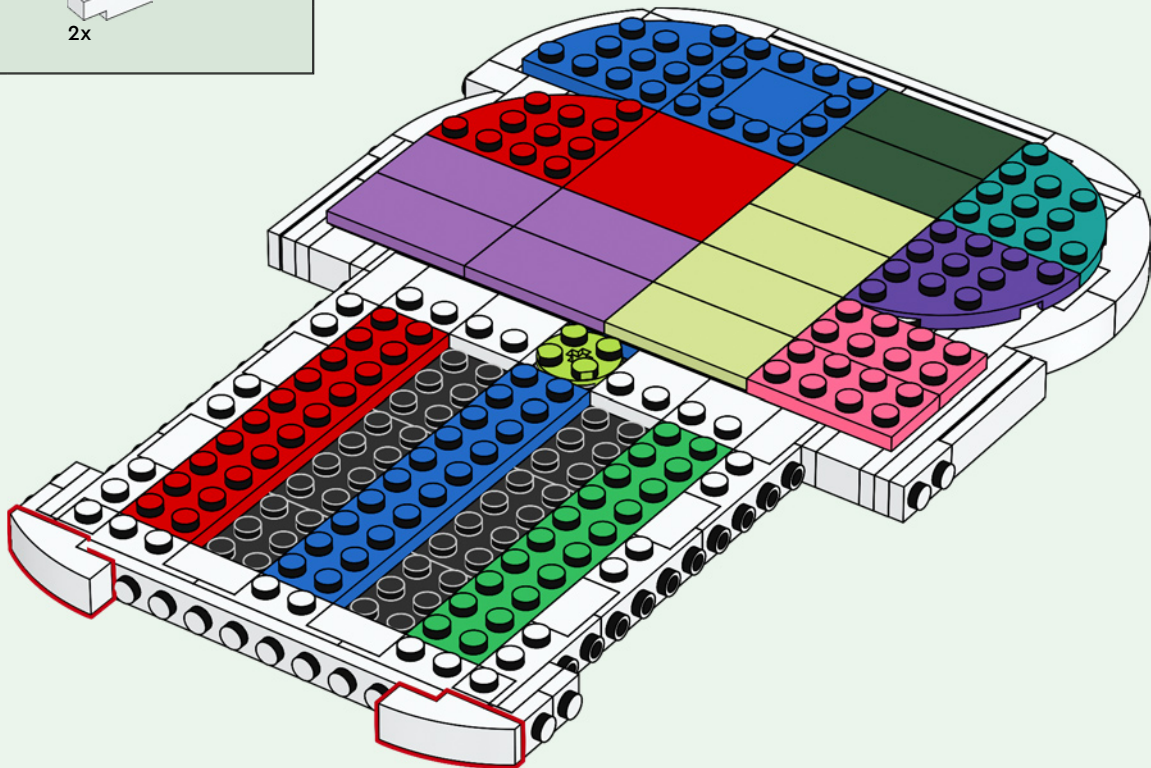

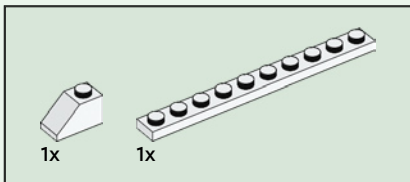
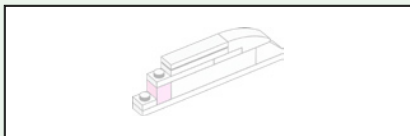

48

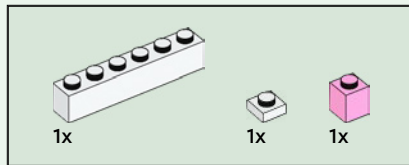
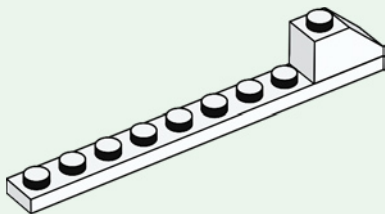

49

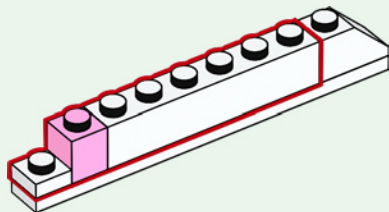

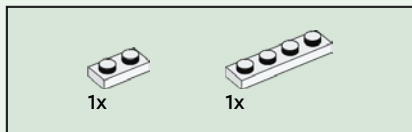

50

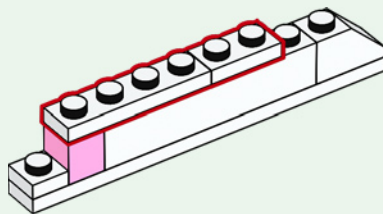

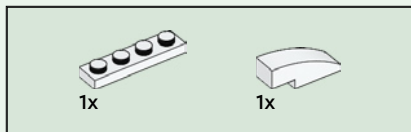

51

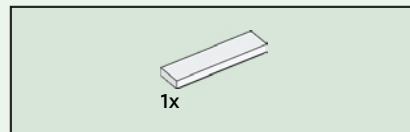
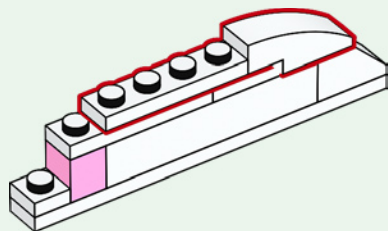

52

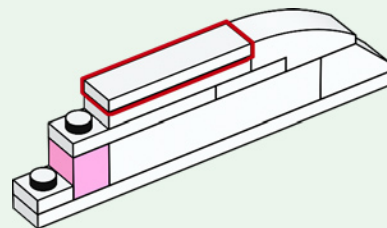

53

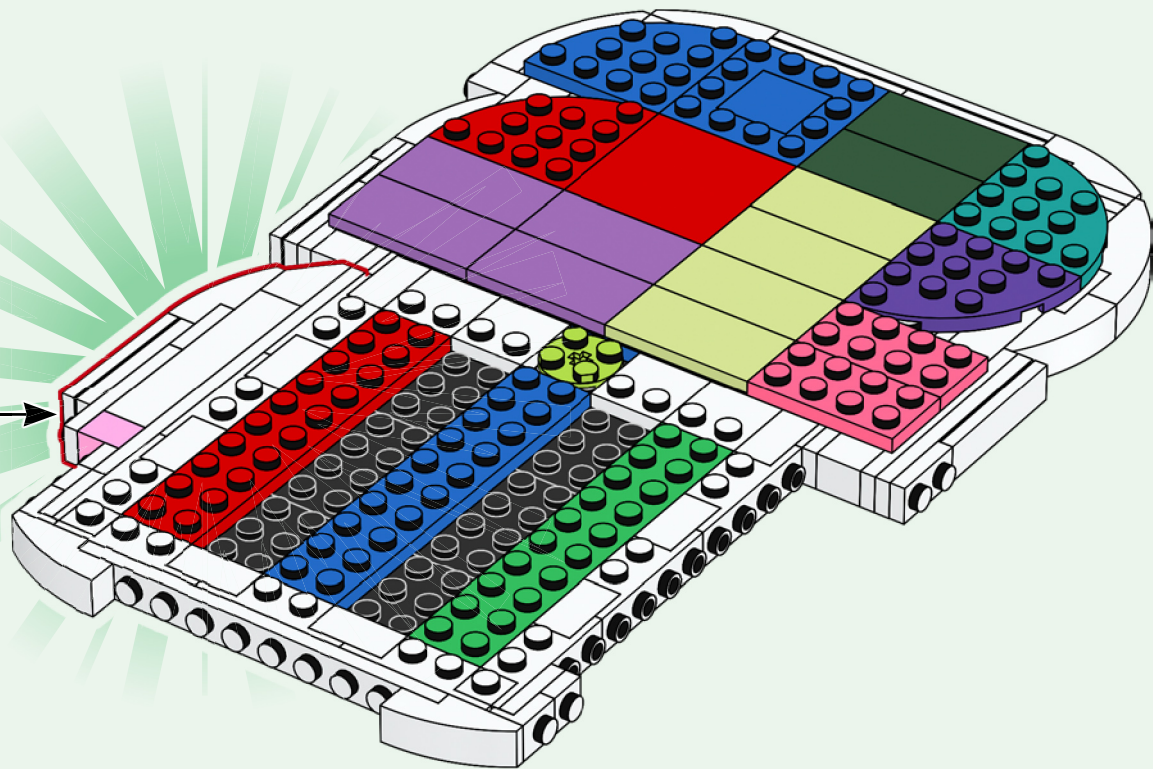

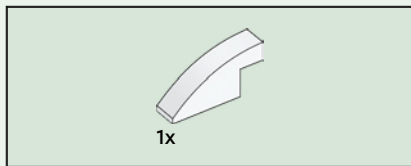

54

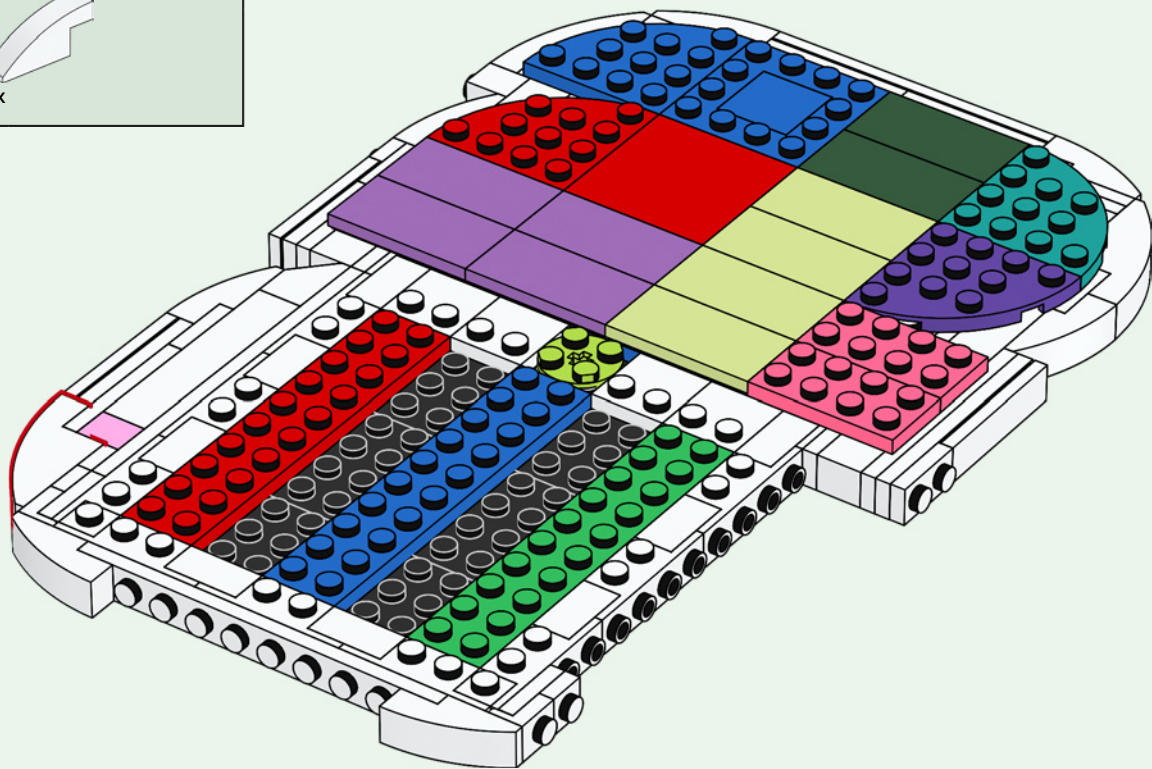





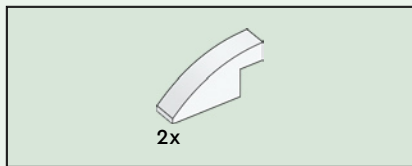

57

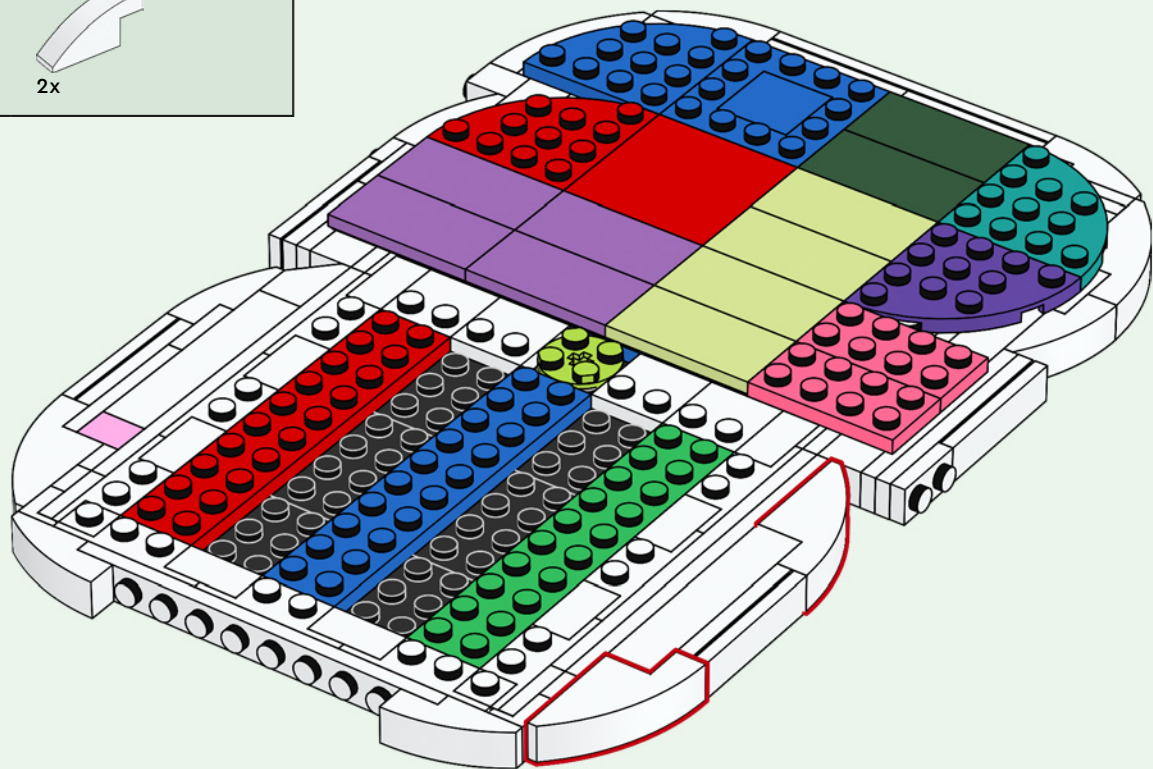

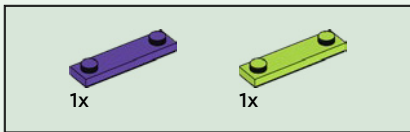

58

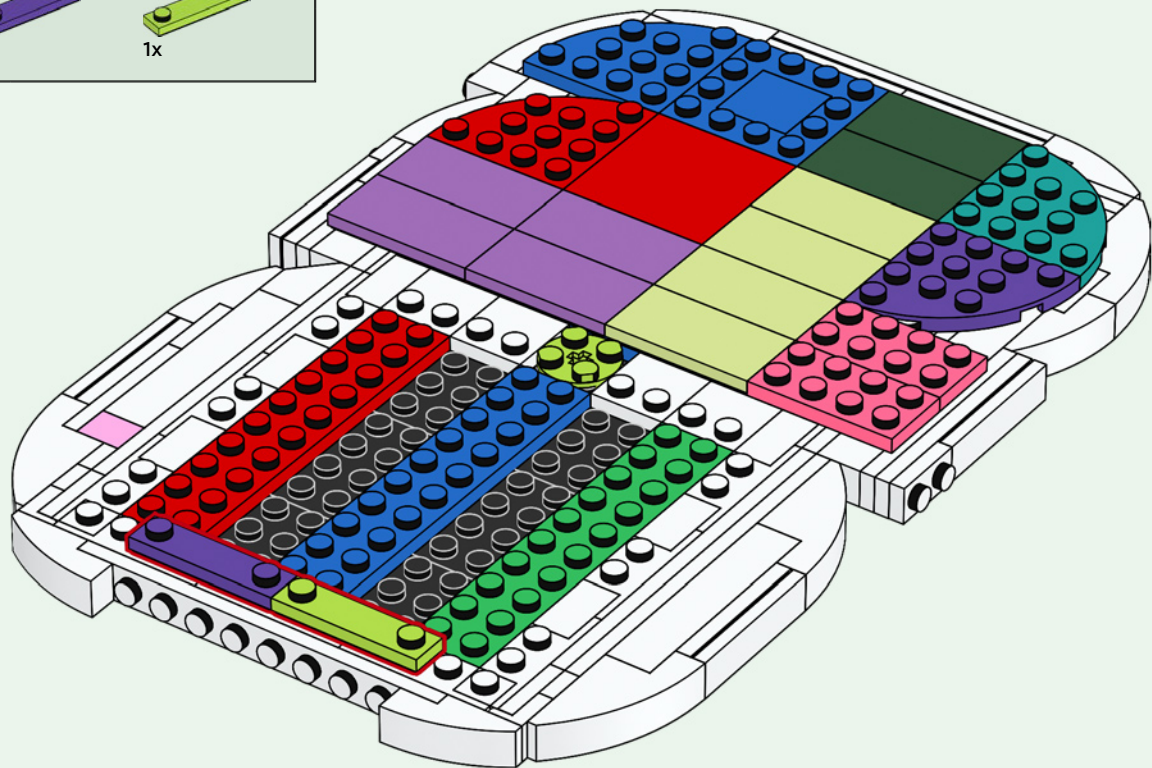

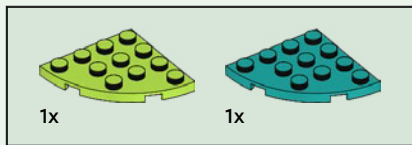

59

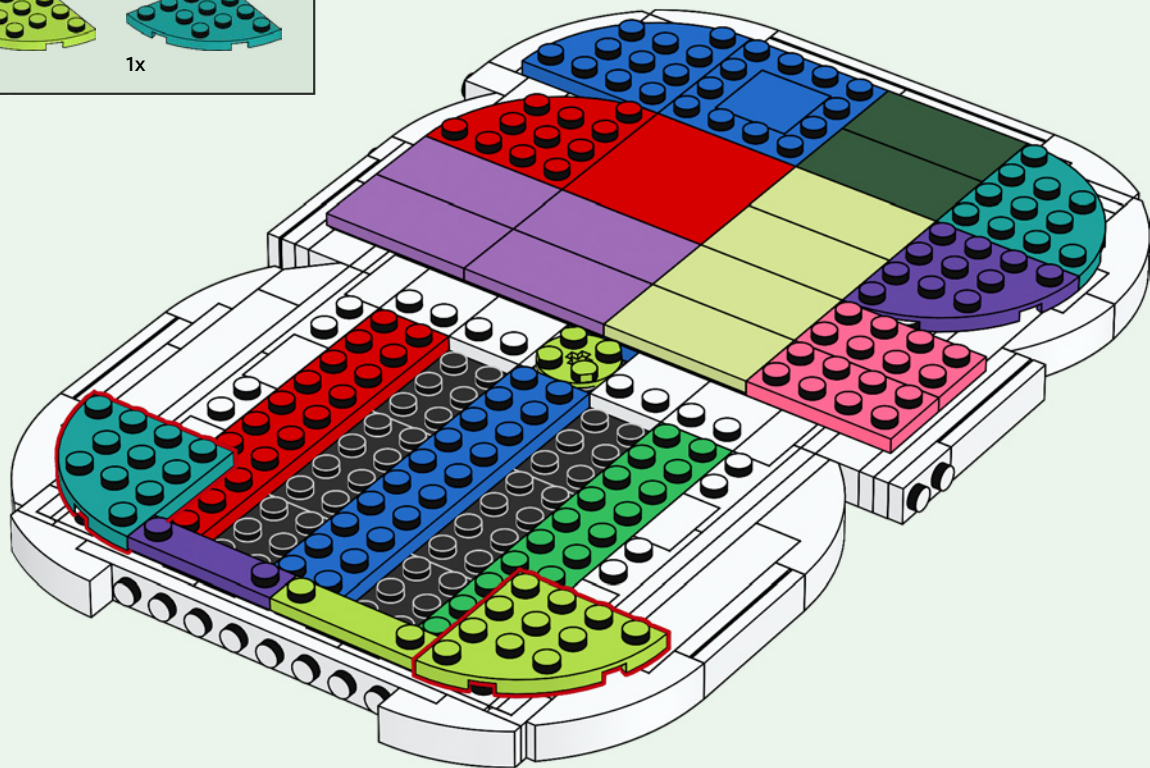

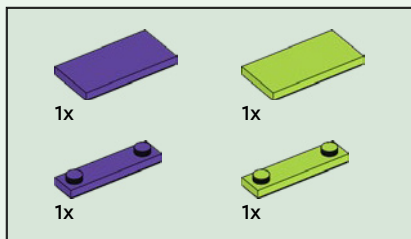

60

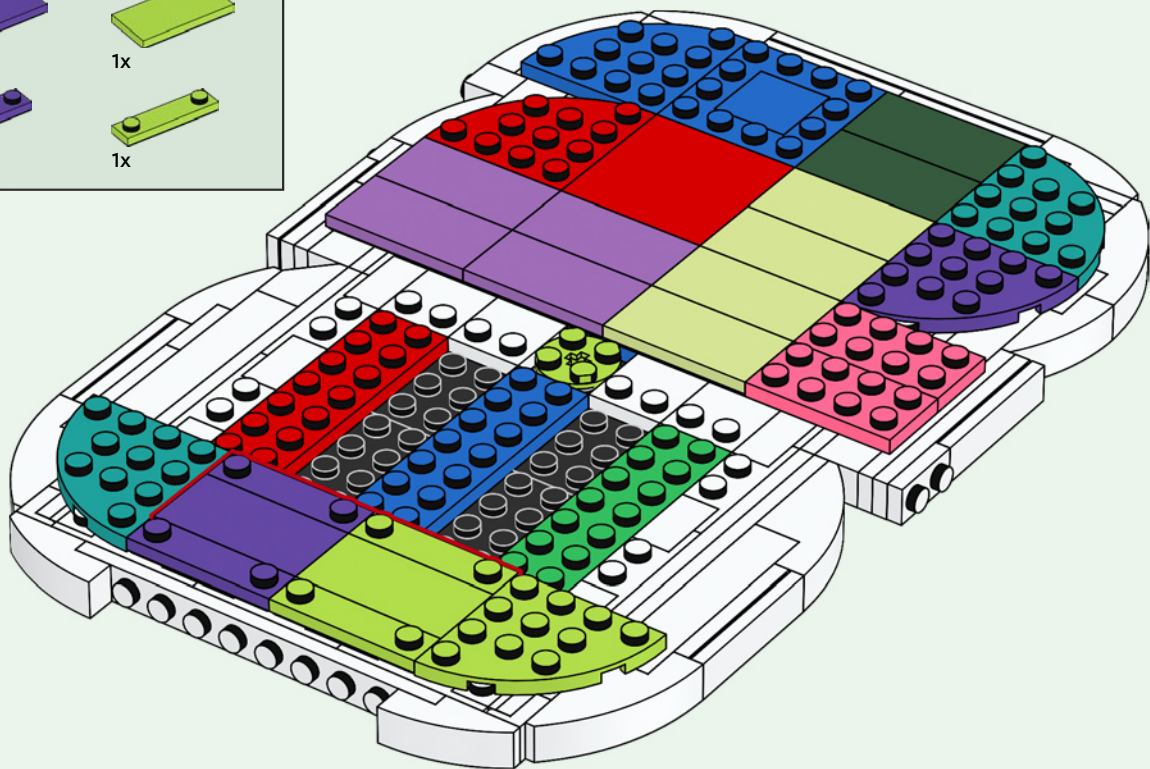

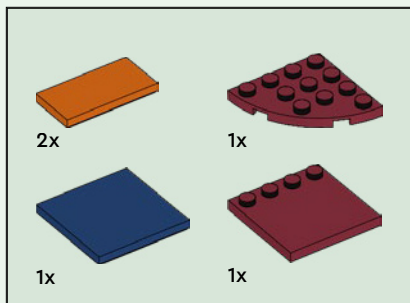

61

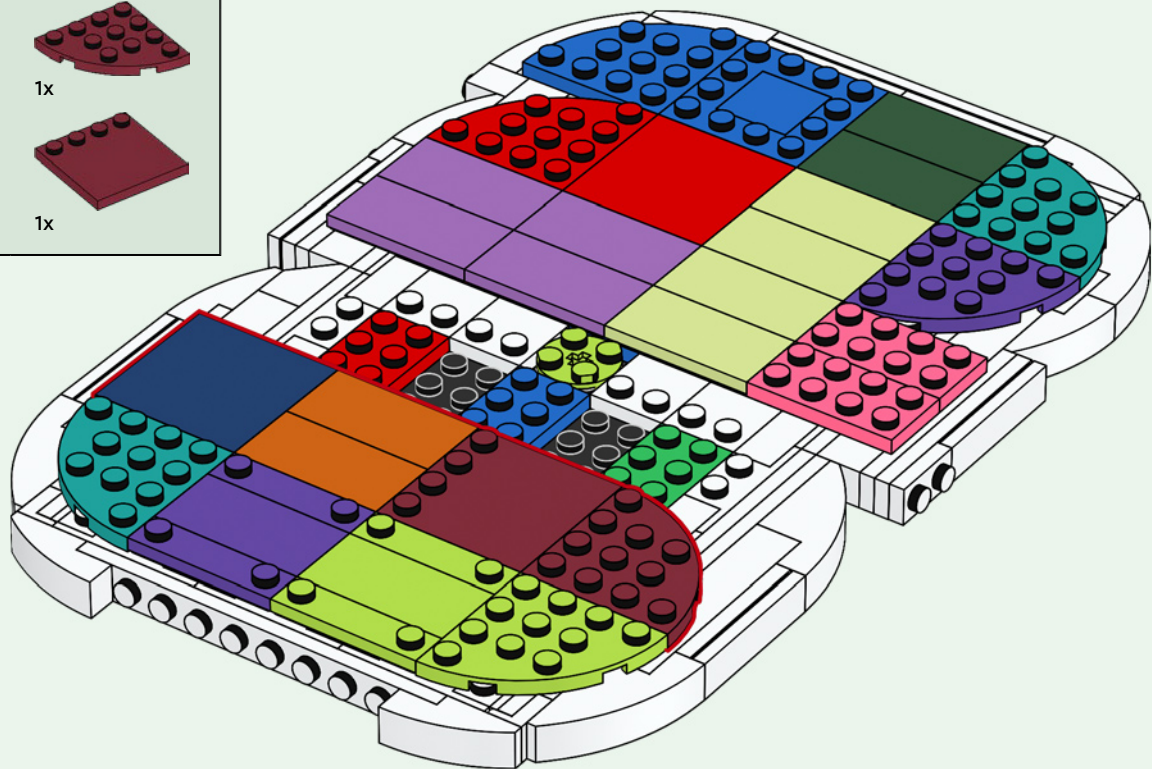

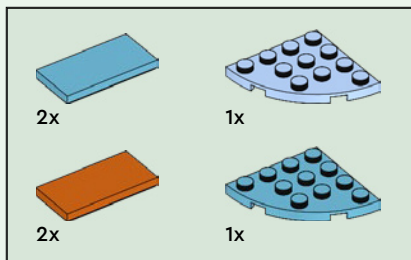

62

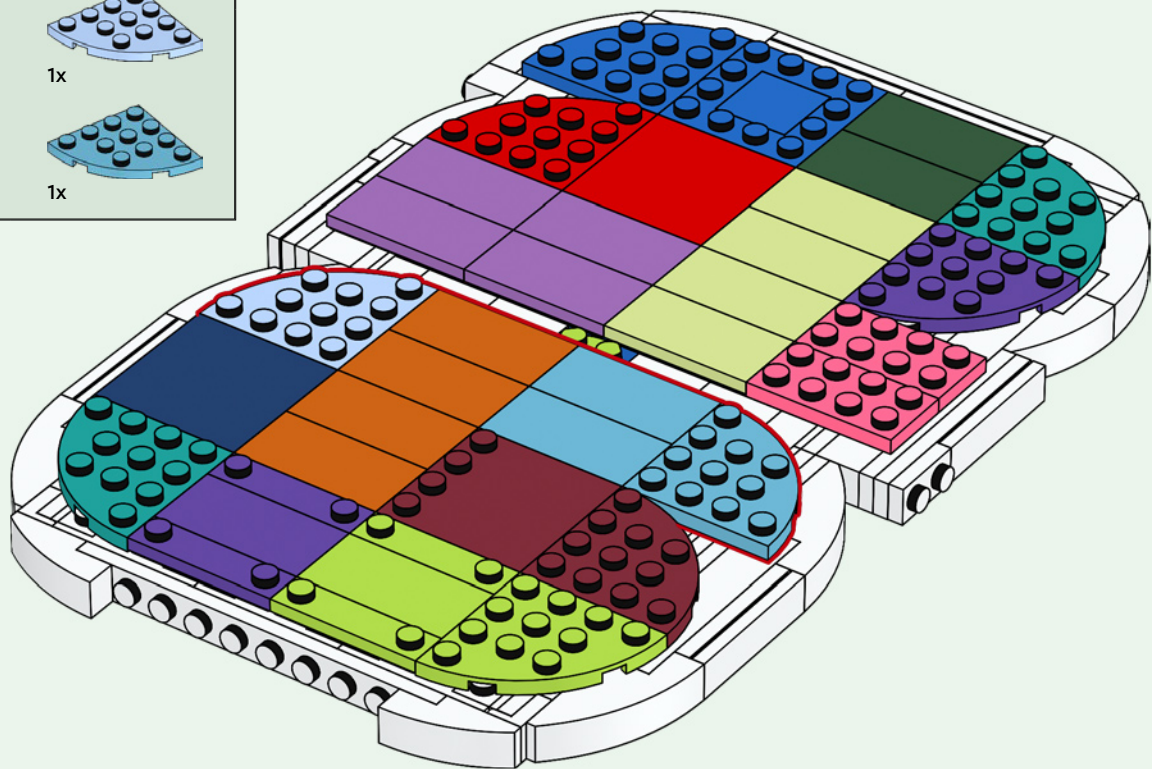

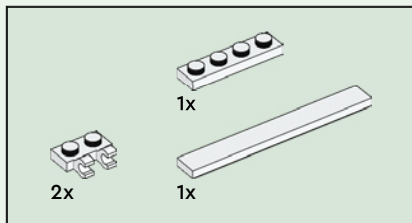

# 63

## 1

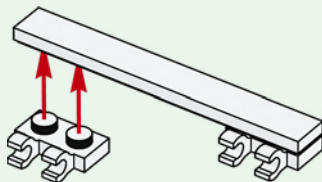

## 2

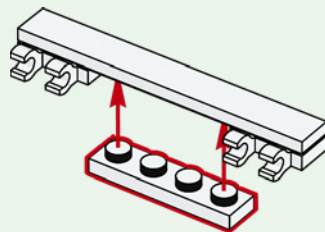

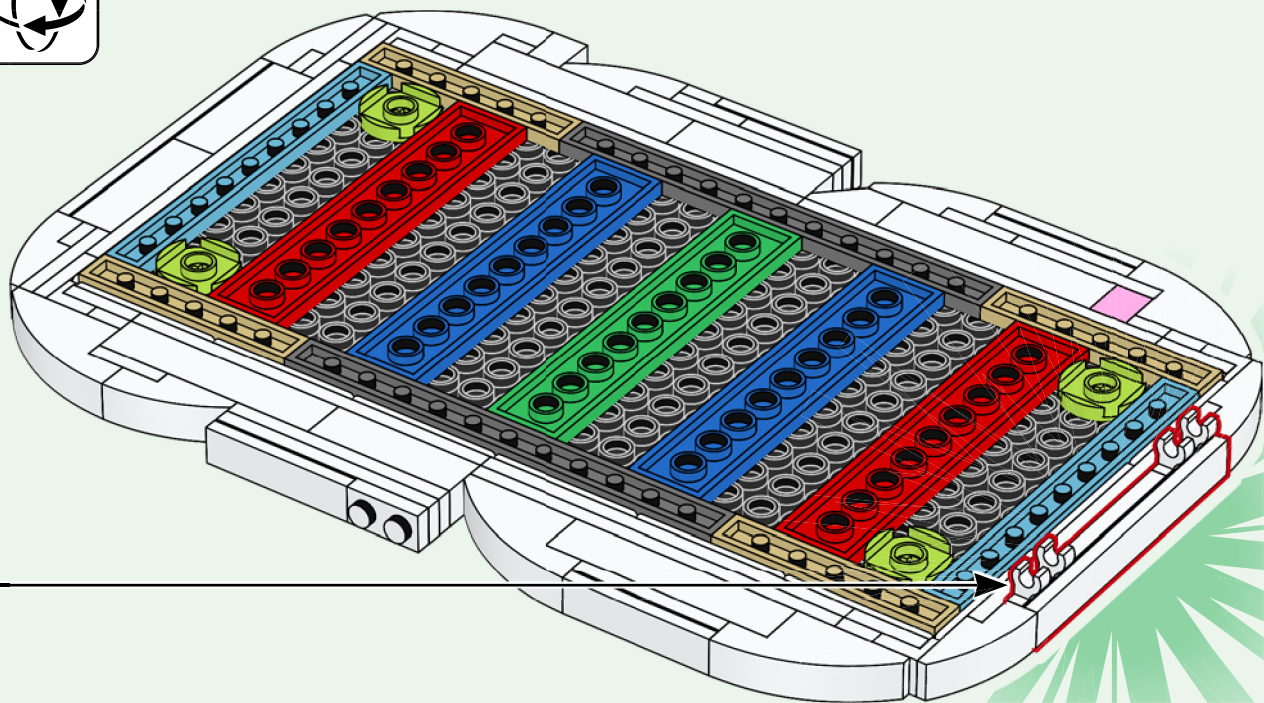
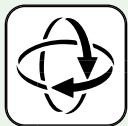



2x

64

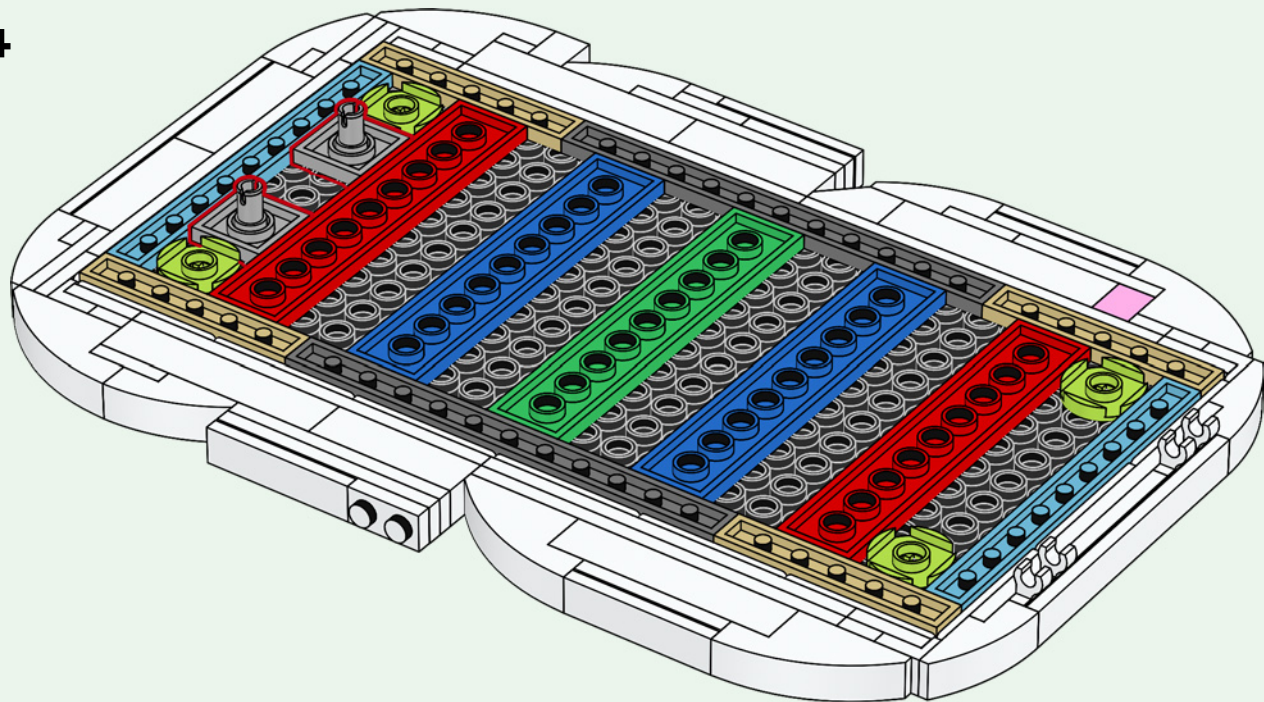

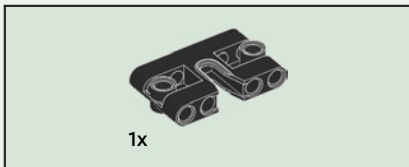

65

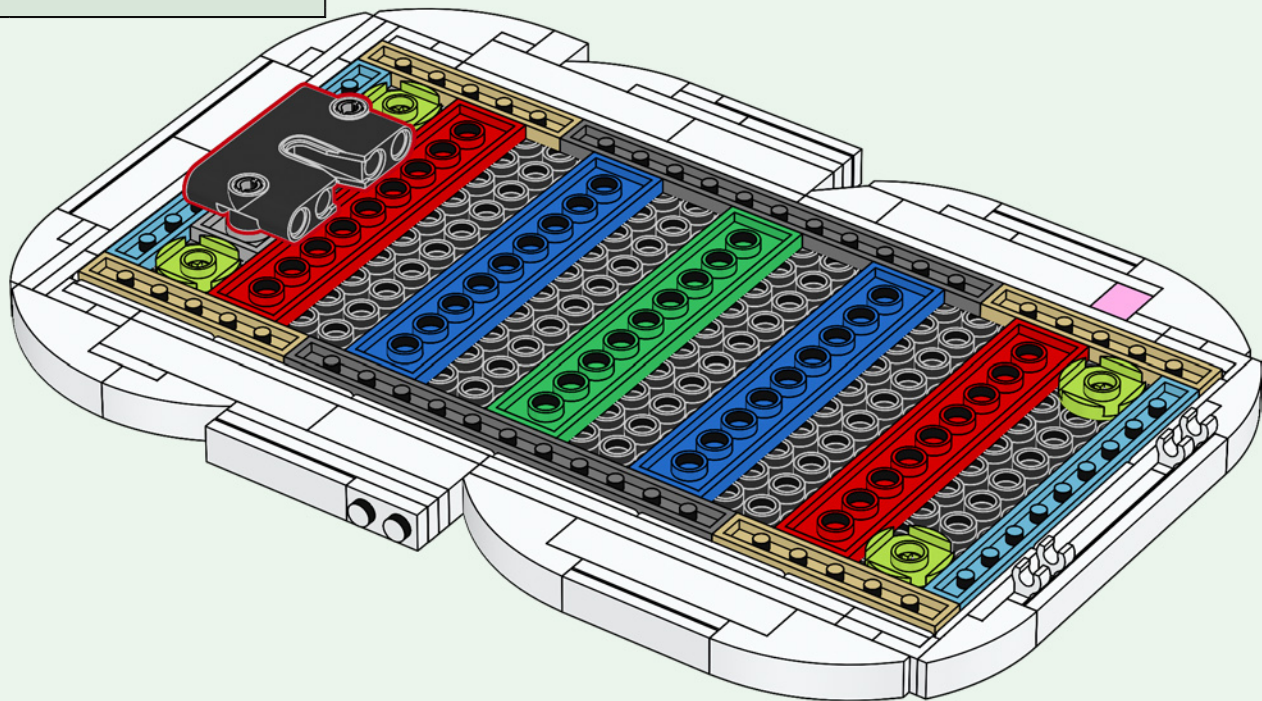

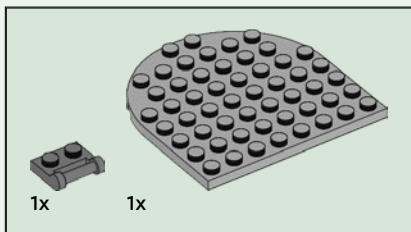
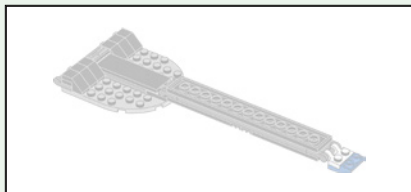

66

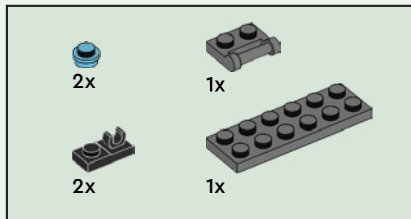
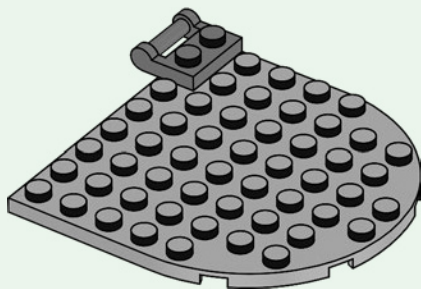

67

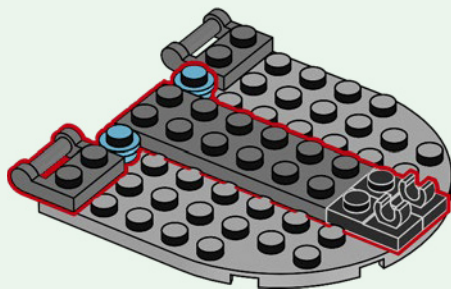



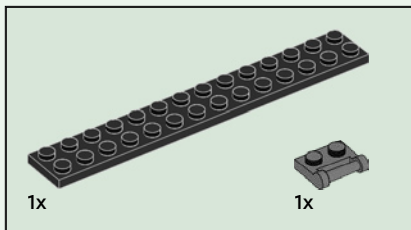
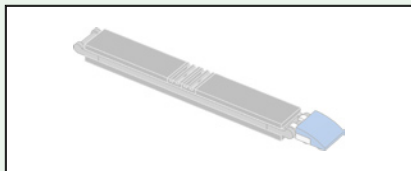

70

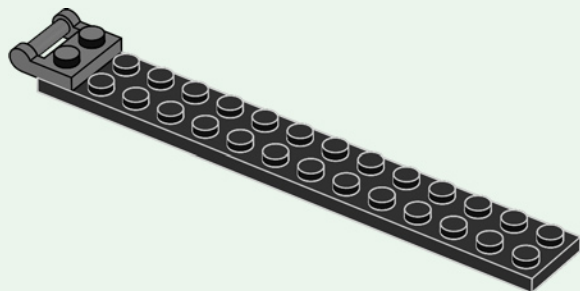

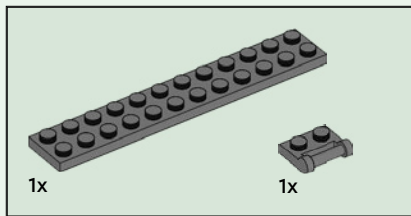

71

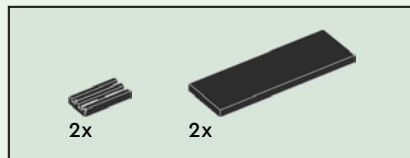
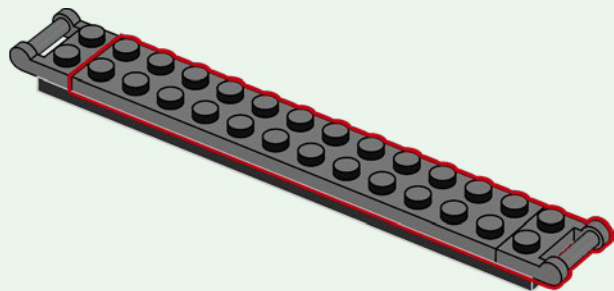

72

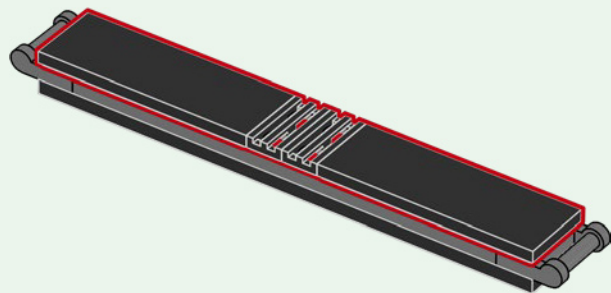

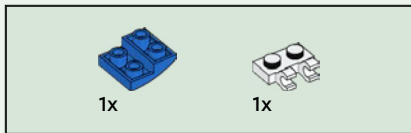

# 73

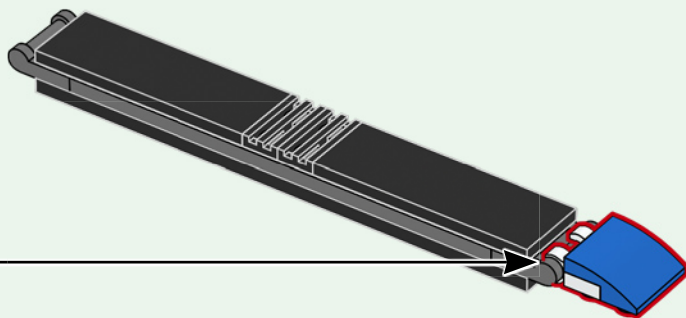
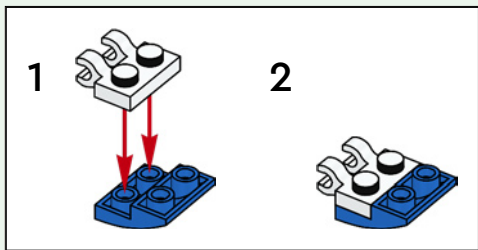

74

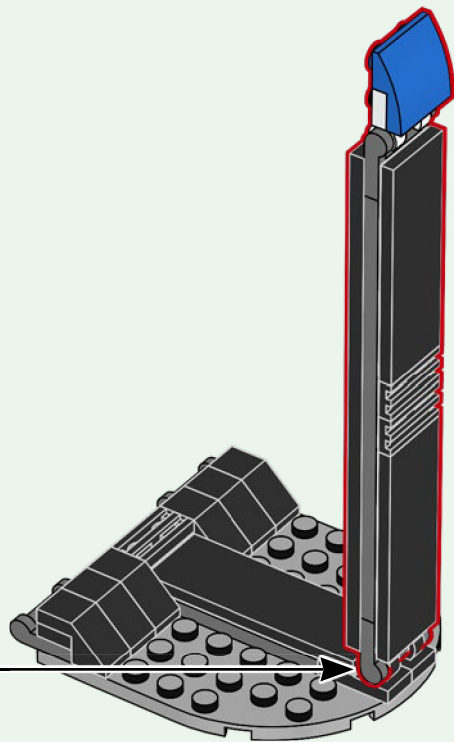

75

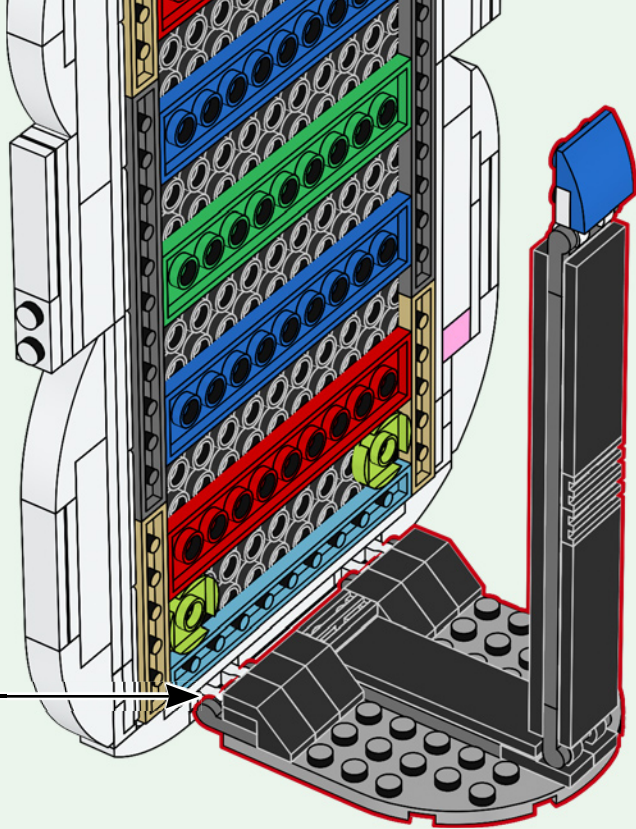

76

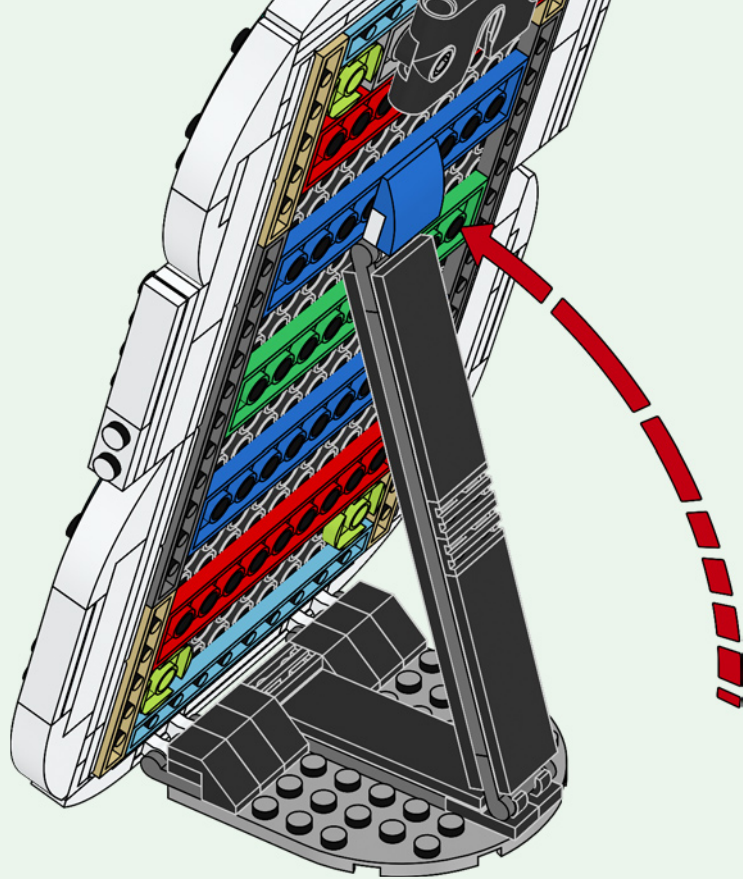

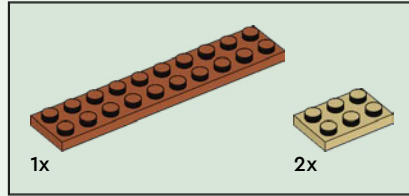
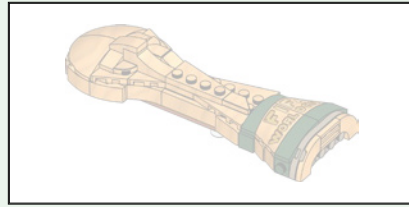

77

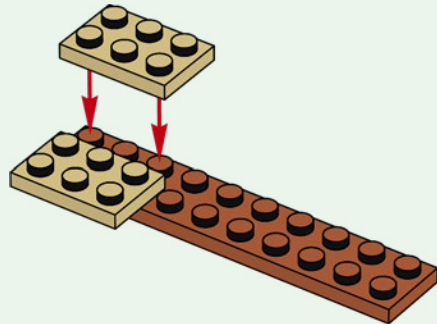

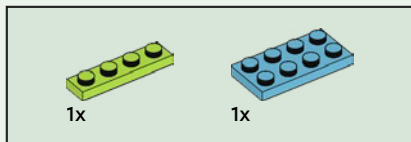

78

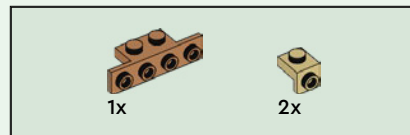
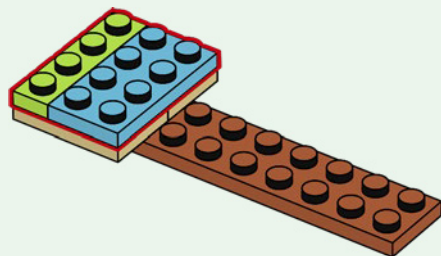

79

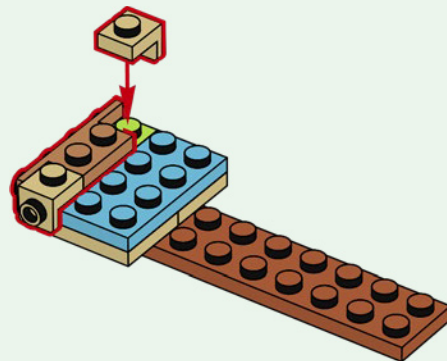



80

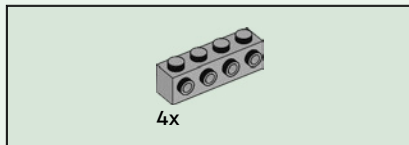
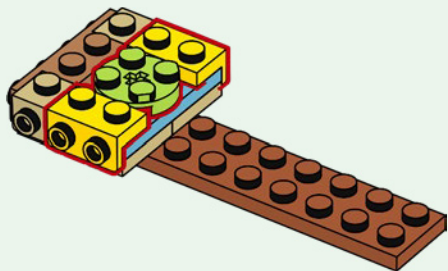

81

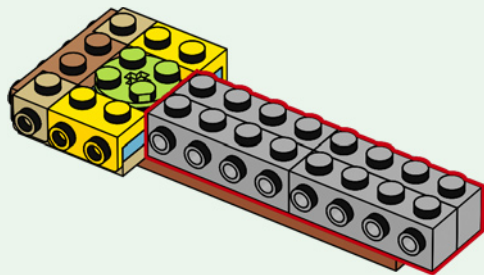

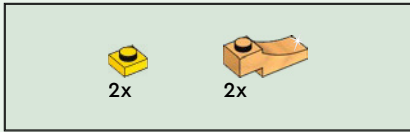

82

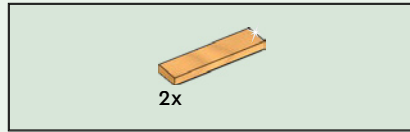
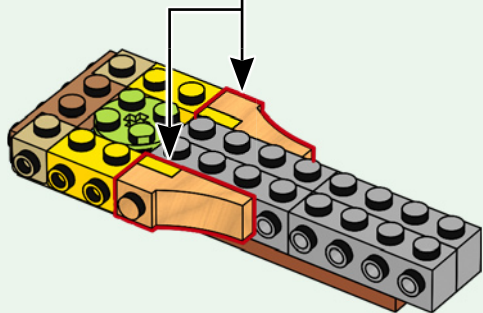
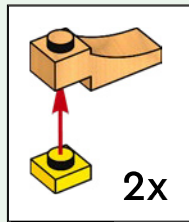

83

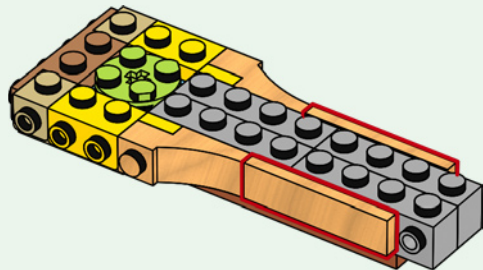

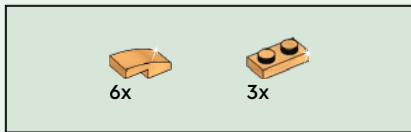

# 84

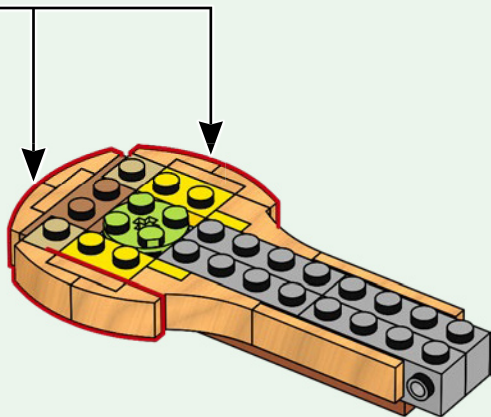
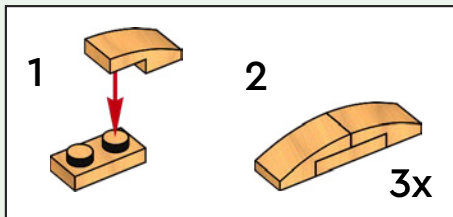

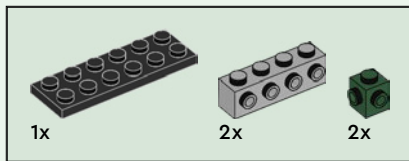

85

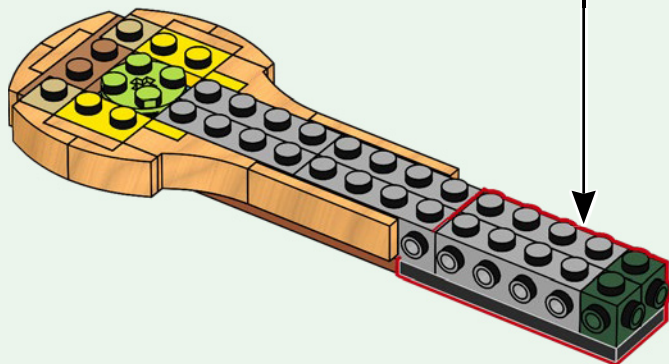
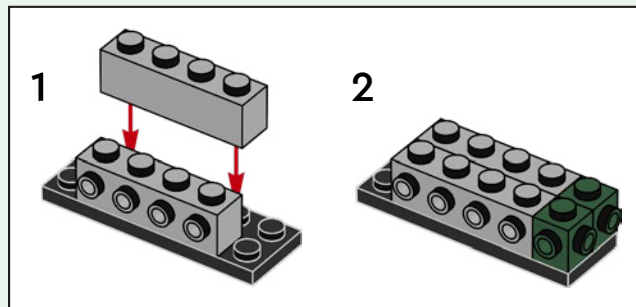

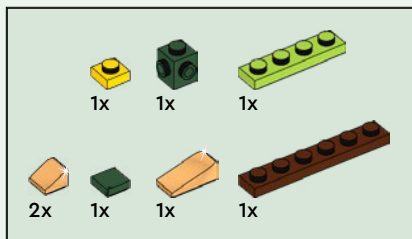

86

1

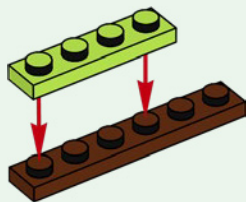

2

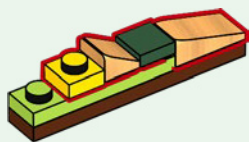

3

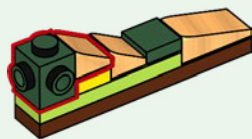

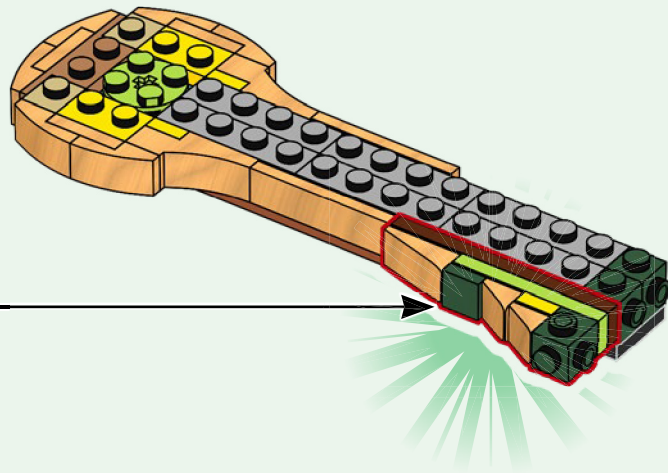

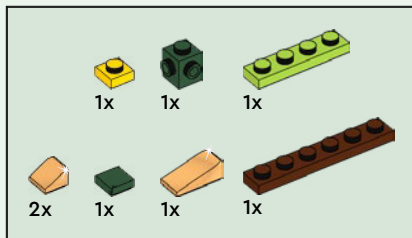

87

1

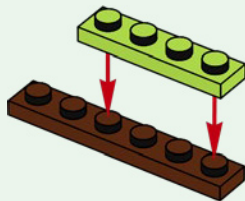

2

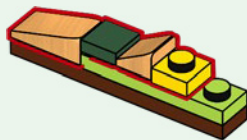

3

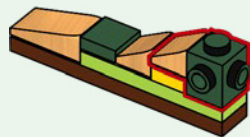

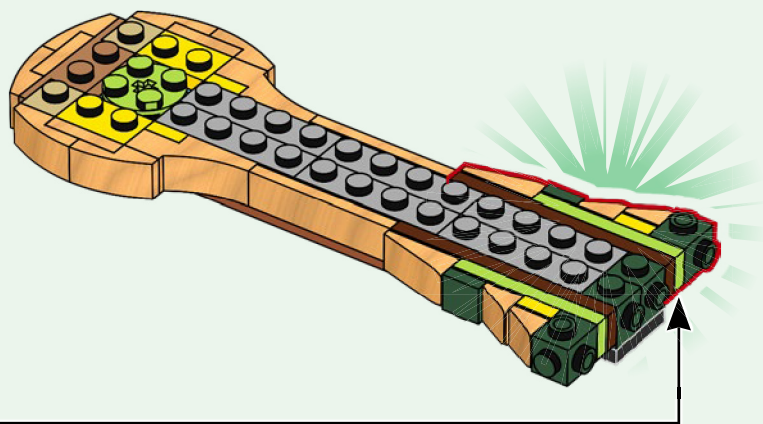

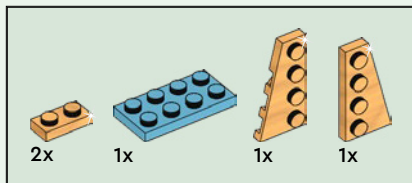

88

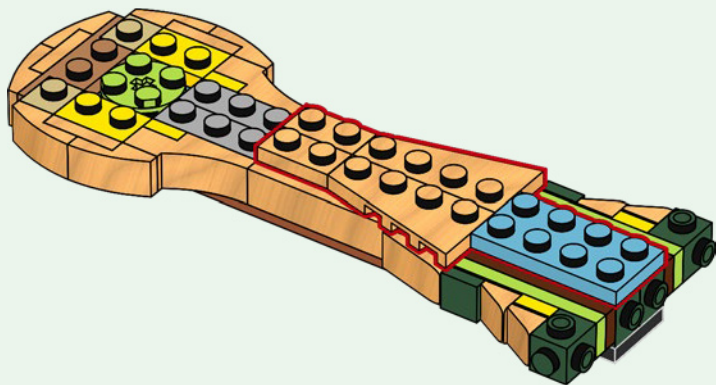

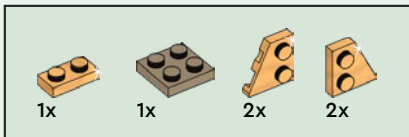

89

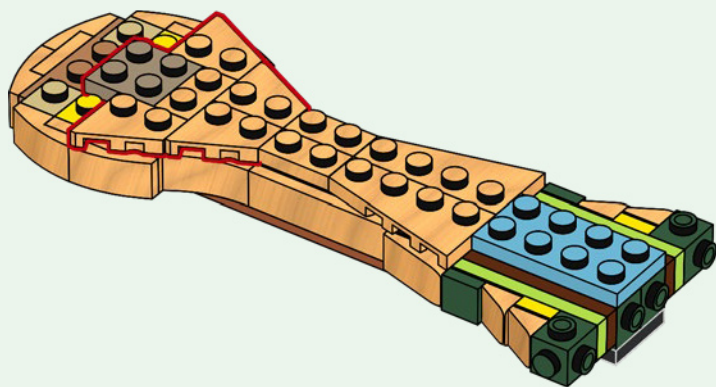

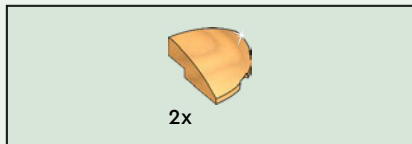

90

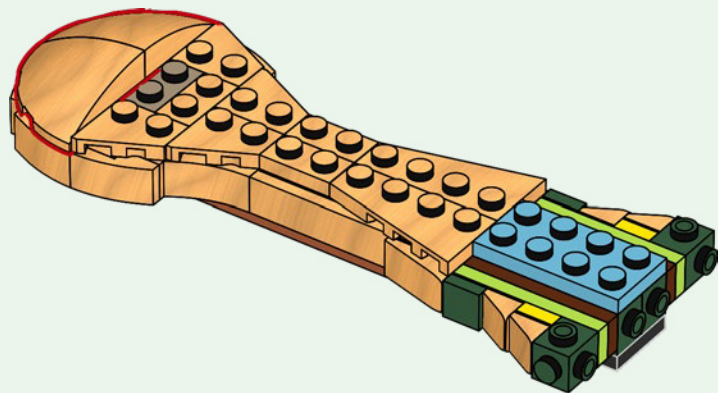

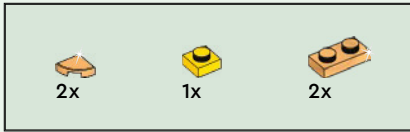

91

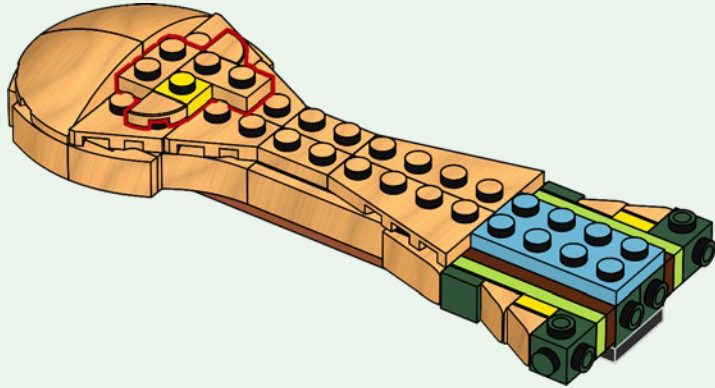

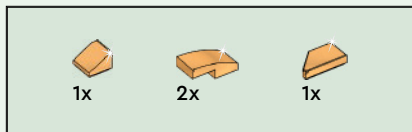

92

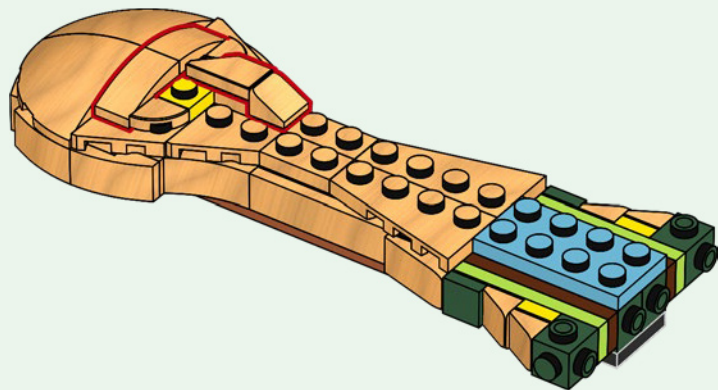

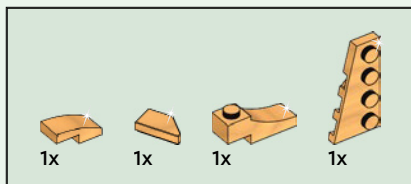

93

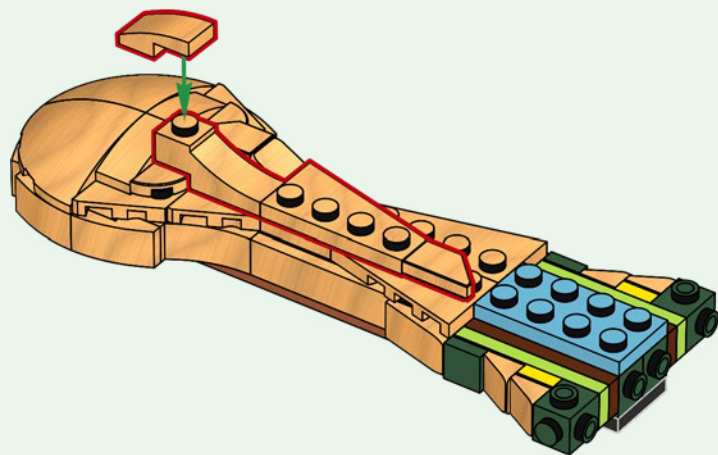

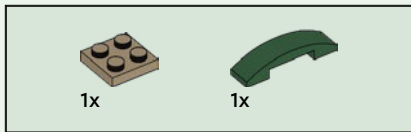

94

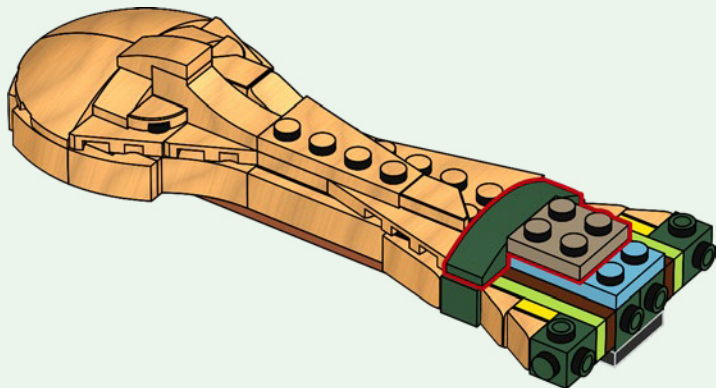

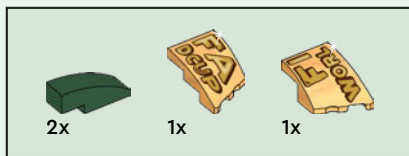

95

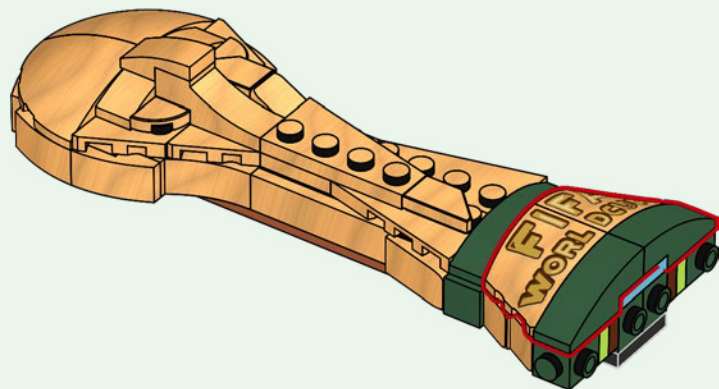

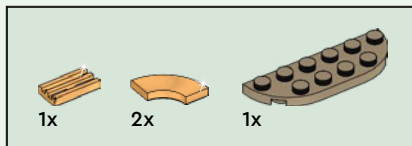

96

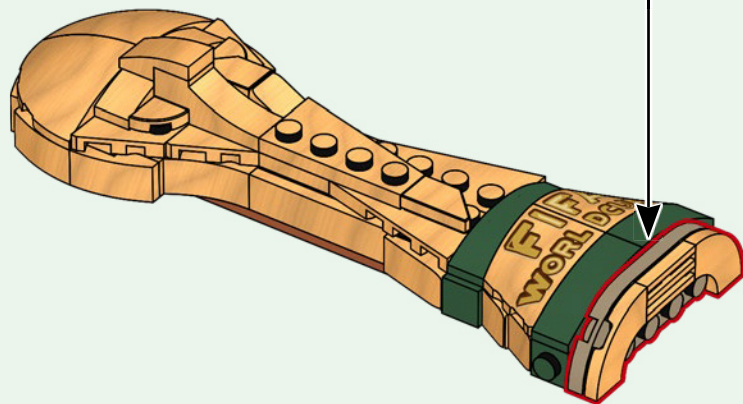
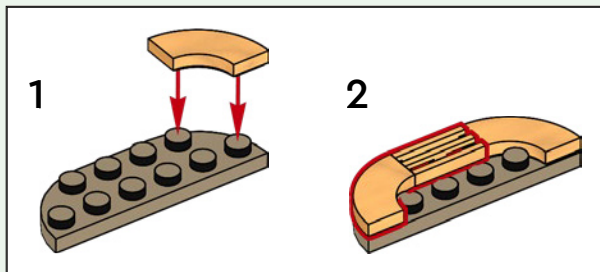



1x

97

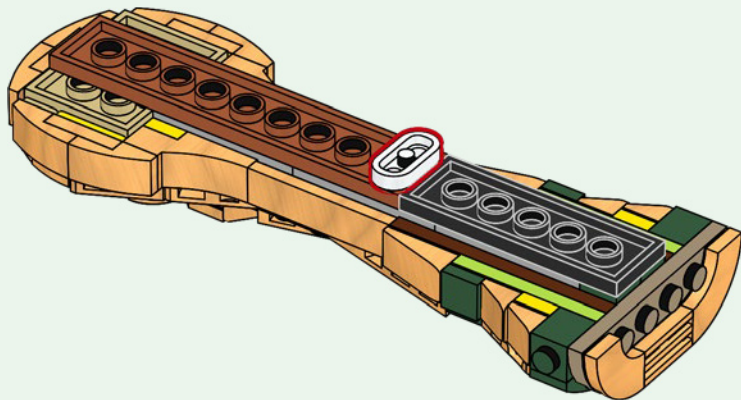

98

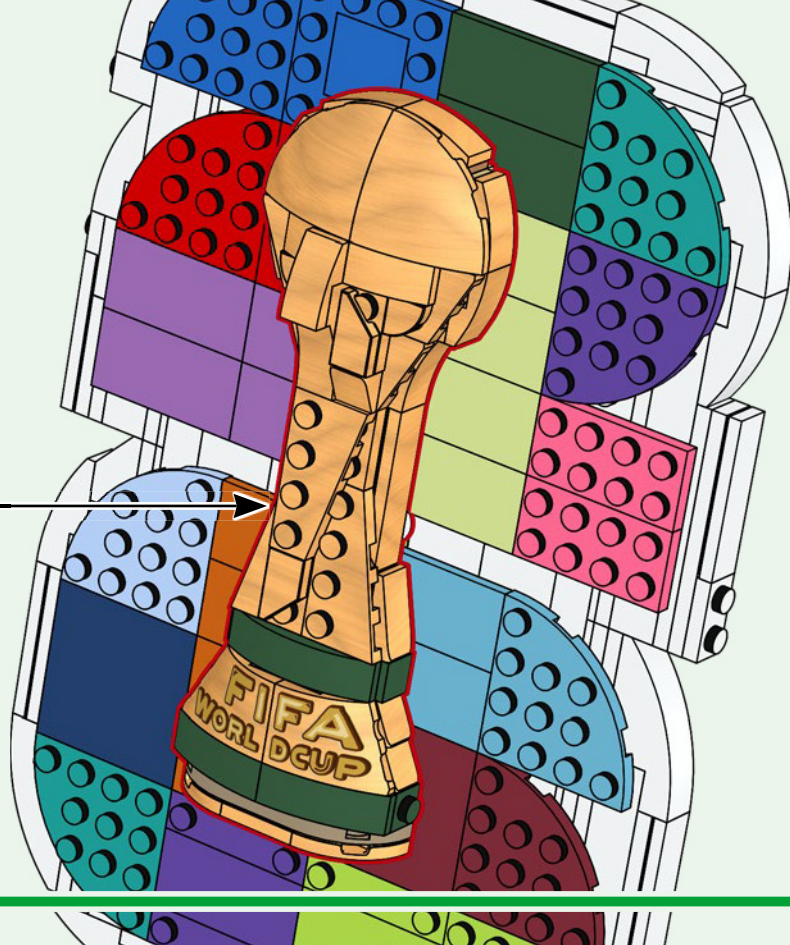



FIFA

1x

99





1x  
300501

13x  
302401

4x  
6296132

1x  
6210272

10x  
302301

13x  
306901

1x  
4121932

3x  
6347287

4x  
6218822

7x  
4249112

3x  
362301

18x  
6168618

5x  
6508109

4x  
301001

4x  
243101

4x  
371001

3x  
366601

4x  
300901

1x  
6605648

2x  
416201

7x  
447701

2x  
6374192

2x  
4118790

4x  
4124067

1x  
6588367

1x  
6297811

4x  
383221

1x  
306823

1x  
6307924

1x  
6339313

1x  
6146306

4x  
383223

5x  
302424

2x  
6185994

3x  
241226

2x  
6347310

6x  
6267487

1x  
6302094

1x  
379526

3x  
6318582

1x  
346026

7x  
6314224

6x  
302926

1x  
6001494

3x  
383228

1x  
6351327

2x  
6591524

3x  
4187743

2x  
6257597

1x  
6212989

1x  
4504705

2x  
6047415

1x  
6167854

1x  
6549659

2x  
6055171

4x  
6618248

2x  
4267850

1x  
6252623

2x  
6440430



1x  
6173167



1x  
6525479



1x  
4286050

2x  
4221590



2x  
6276848



6x  
4211636



1x  
6383102



4x  
6146321

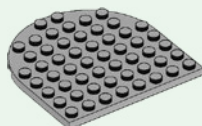

1x  
6474254



1x  
4211002



2x  
6133611



1x  
4211067



2x  
6253191



1x  
6167472



2x  
6305455



1x  
6584946



5x  
4587002



2x  
6508110



1x  
6508086



1x  
6508101



2x  
6498728



2x  
6498729



2x  
6493273



1x  
6493272

8x  
6218047



9x  
6132827



2x  
6533889



1x  
4490599



2x  
6173654



1x  
6605646



2x  
6618249



3x  
6600733



1x  
6605647



2x  
6478933

1x  
6292914



2x  
6102986



2x  
6097042



2x  
4655256



1x  
6481835



2x  
6423273



4x  
4651902



4x  
6405559



4x  
6626488



 [LEGO.com/service](https://www.lego.com/service)

YOU COULD  
**WIN**

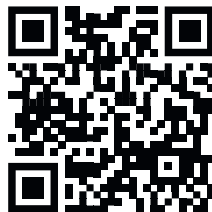

Scan this QR code or go to  
**LEGO.COM/PRODUCTFEEDBACK** and give us  
your short feedback about this LEGO® set  
for a chance to win a cool LEGO prize.

Terms and Conditions apply\*



**EN: YOU COULD WIN.** Terms and Conditions apply\* **DE: Du könntest GEWINNEN.** Es gelten die Teilnahmebedingungen\* **FR: TU POURRAIS GAGNER.** Des conditions s'appliquent\* **IT: Potresti VINCERE tu.** Termini e condizioni sono applicabili\* **ES: PUEDES GANAR.** Aplican términos y condiciones\* **PT: PODERÁ GANHAR.** Aplicam-se Termos e Condições\* **ZH: 轻松获奖.** 条款和条件适用\* **PL: Szansa na WYGRANĄ.** Obowiązuje regulamin\* **CS: Máte šanci VYHRÁT.** Platí všeobecné smluvní podmínky\* **SK: Máte šancu VYHRAŤ.** Platia všeobecné zmluvné podmienky\* **HU: TE IS NYERHETSZ!** Felhasználási feltételek érvényesek\* **UA: ВИ МОЖЕТЕ ВИГРАТИ.** Застосовуються загальні положення та умови\* **RO: Ai putea CÂȘTIGA.** Se aplică termenii și condiții\* **BG: Можете да СПЕЧЕЛИТЕ.** Има определени правила и условия\* **LV: Tu vari LAIMĒT.** Ir spēkā noteikumi un nosacījumi.\* **ET: Sul on võimalus VÕITA.** Kehtivad tingimused\* **LT: Jūs galite LAIMĖTI.** Taikomos sąlygos\* **TR: KAZANABİLİRSİN.** Şartlar ve Koşullar geçerlidir\*

\*[LEGO.com/productfeedback-terms](https://www.lego.com/productfeedback-terms)

*Editions™*

LEGO, the LEGO logo and the Editions logo are trademarks of the/son des marques de commerce du/son marcas registradas de LEGO Group.  
©2026 The LEGO Group. All rights reserved/Tous droits réservés/Todos los derechos reservados.

© FIFA, FIFA's Official Licensed Product Logos, and all brand elements, designs and trade names of FIFA and FIFAe tournaments,  
events and products are copyrights and / or trademarks of FIFA.

 6647415