

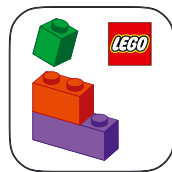

Editions™

43033



LEGO® Builder





LEGO.com/sustainable-packaging



 ^{FR} **DONNEZ**
OU
RECYCLEZ

 OU  OU 

ASSOCIATION MAGASIN DÉCHÈTERIE

Adresses sur quefairedemesdechets.fr

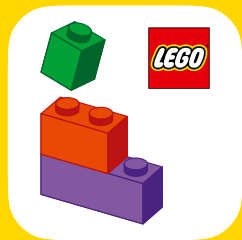

LEGO® Builder



BUILDER



Apple and the Apple logo are trademarks of Apple Inc., registered in the U.S. and other countries and regions. App Store is a service mark of Apple Inc. Google Play and the Google Play logo are trademarks of Google LLC. Tencent and the Tencent logo are trademarks of Tencent Inc.

LEGO.com/devicecheck

EN Ask parents' permission before going online | DE Eltern um Erlaubnis bitten, bevor du online gehst | FR Demande l'autorisation d'un parent avant d'aller en ligne | IT Chiedi il permesso ai tuoi genitori prima di andare online | ES Pídeles permiso a tus papás antes de conectarte a Internet | PT Pede autorização aos teus pais antes de ficares online | ZH 上网前应先征得父母的同意 | PL Poproś rodziców o zgodę, zanim wejdiesz do Internetu | CS Než půjdeš na internet, požádej rodiče o svolení | SK Skôr než pôjdeš na internet, vypýtaj si povolenie od rodičov | HU Kérj szülői engedélyt, mielőtt online csatlakoznál! | UA Запитуйте дозволу батьків, перш ніж користуватися інтернетом | RO cere permisiunea părinților înainte de a te conecta online | BG Поискайте разрешение от родител, преди да влезете онлайн | LV Pirms došanās tiešsaistē palūdz atļauju vecākiem | ET Enne Interneti kasutamist küsi vanematelt luba | LT Prieš prisijungdami prie interneto, atsiklauskite tėvų | TR İnternete girmeden önce anne babandan izin iste

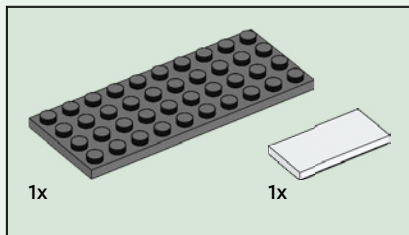

1

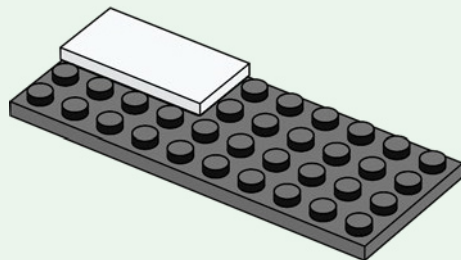

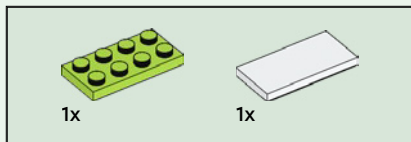

2

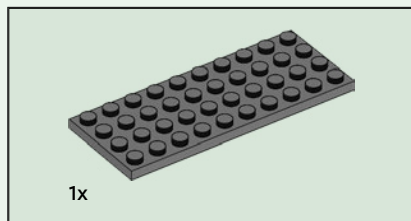
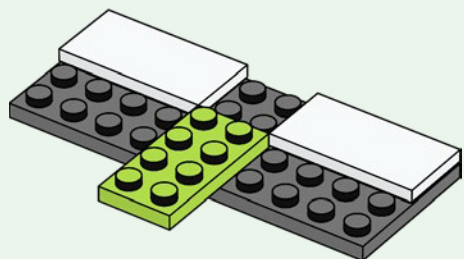

3

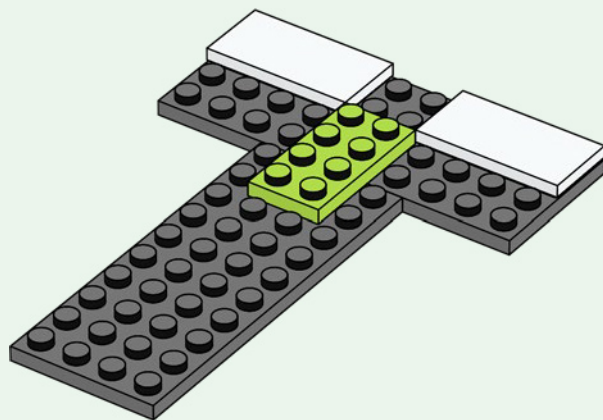

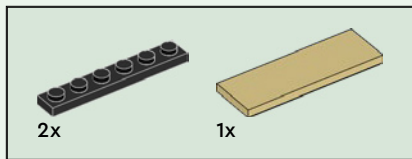

4

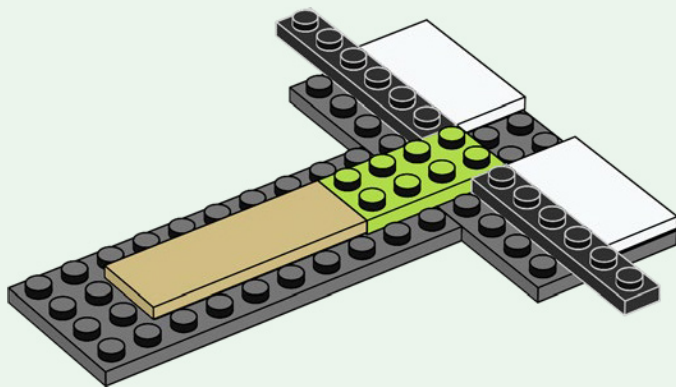

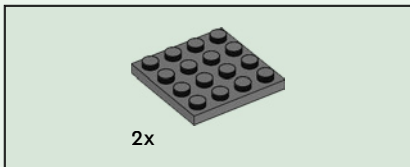

5

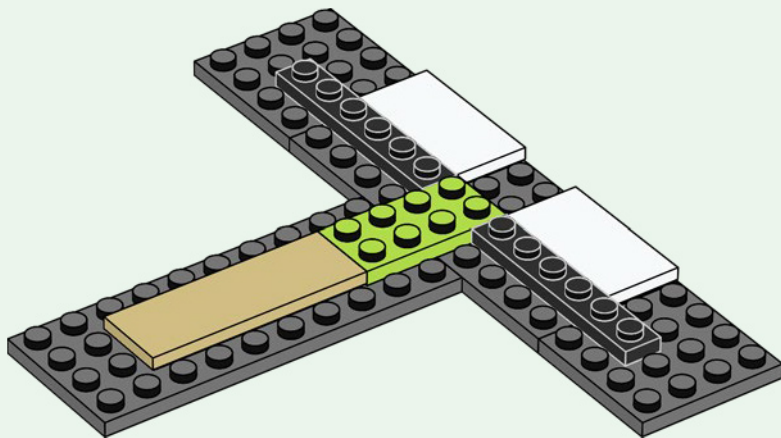

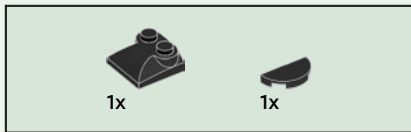

6

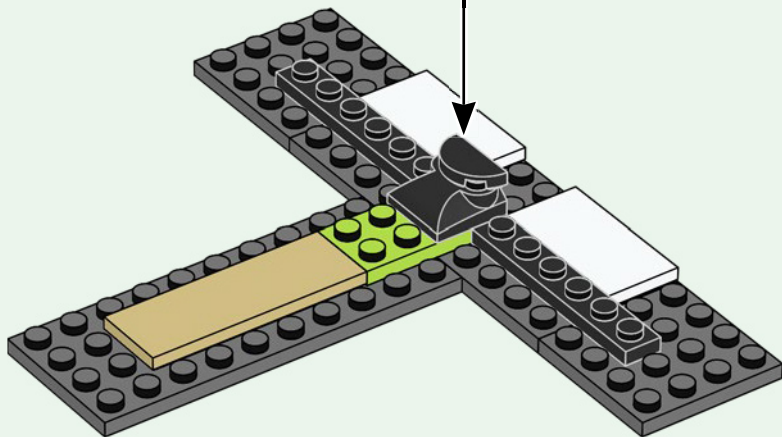
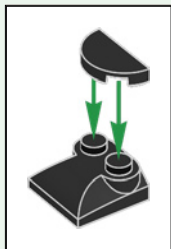

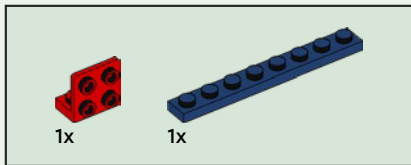
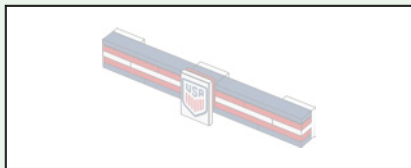

7

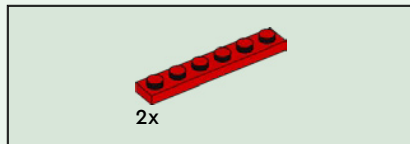
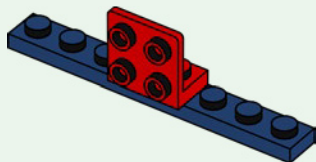

8

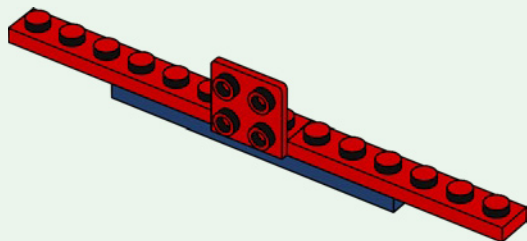

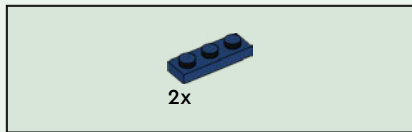

9

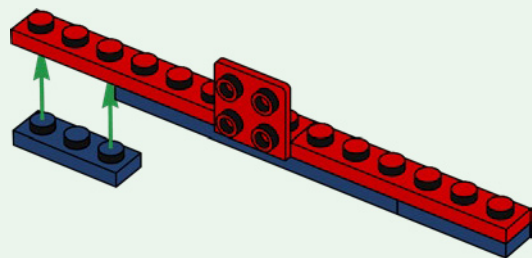

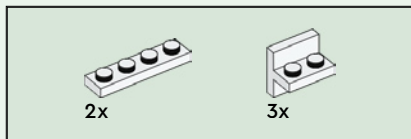

10

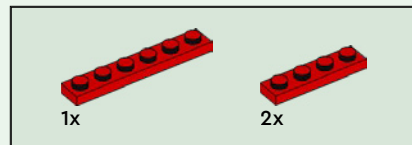
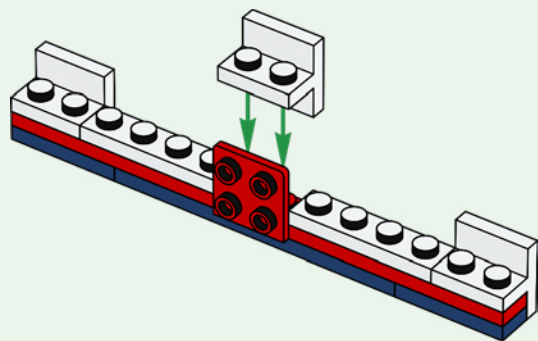

11

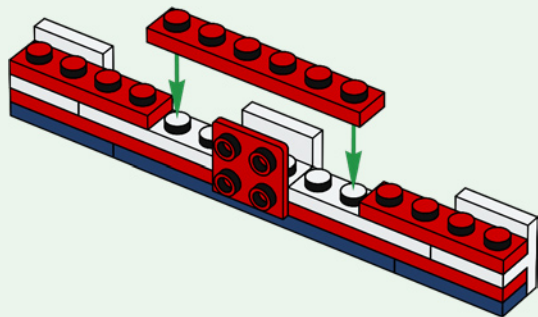

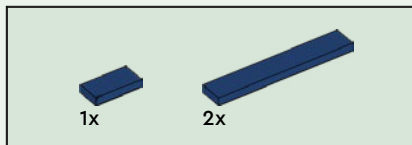

12

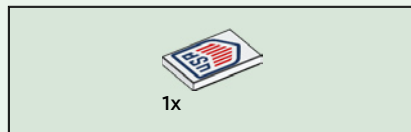
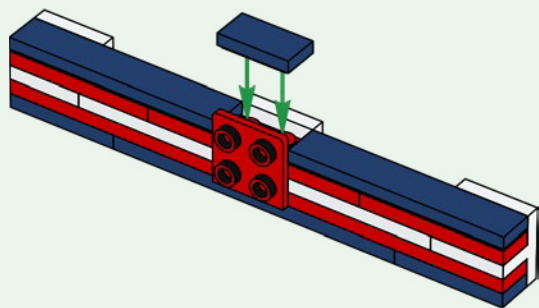

13

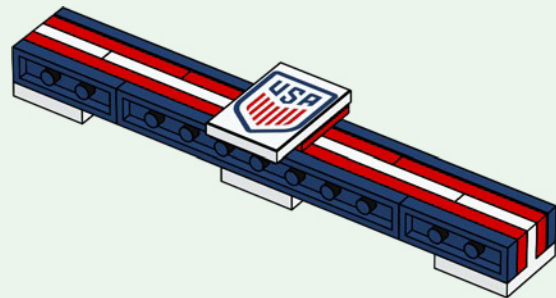

14

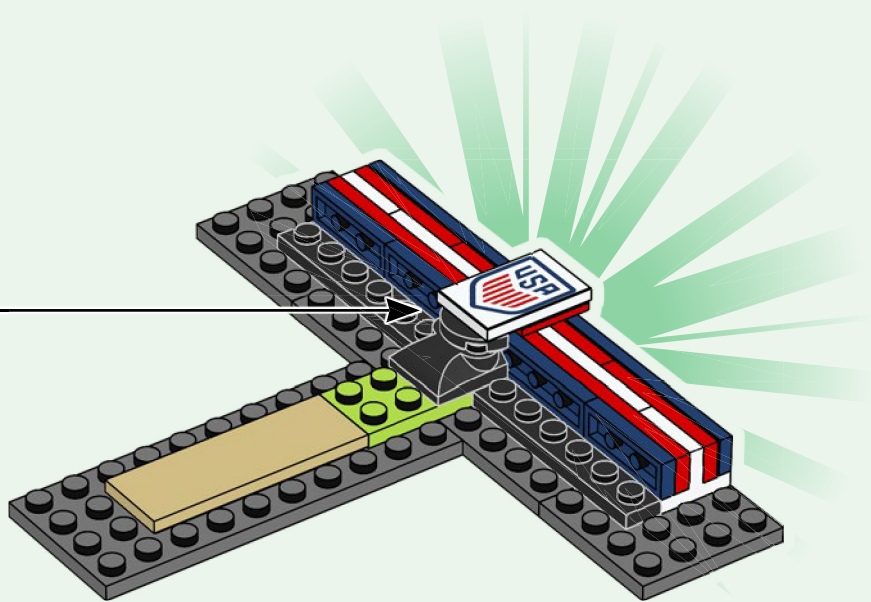

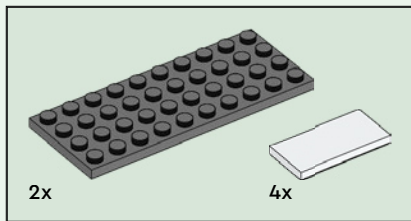

16

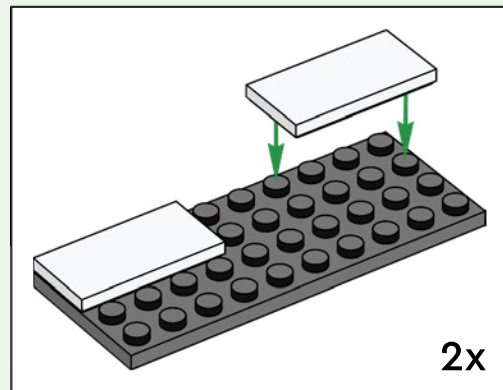
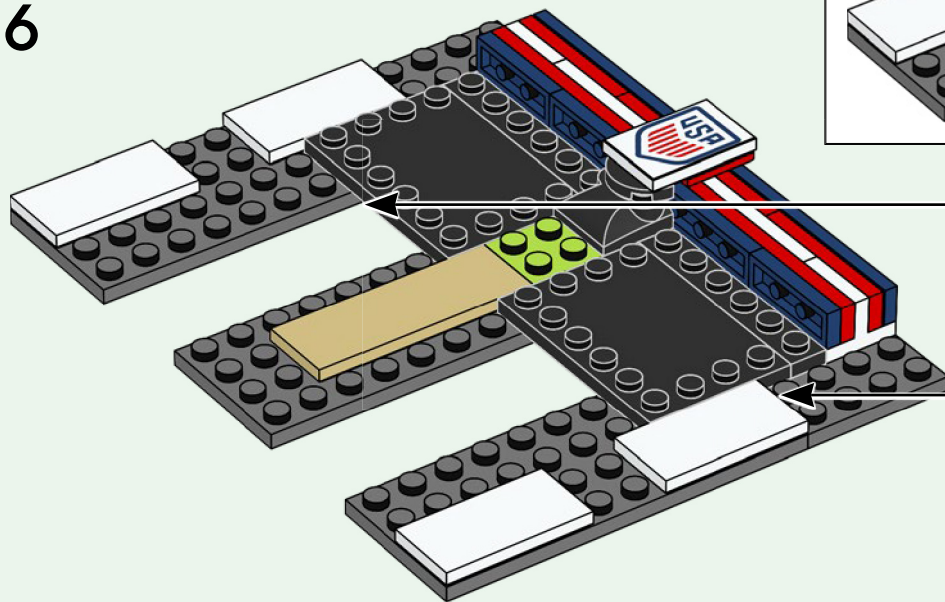

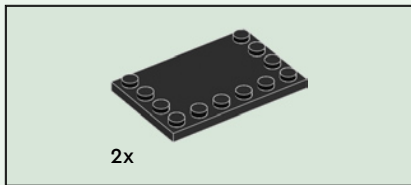

17

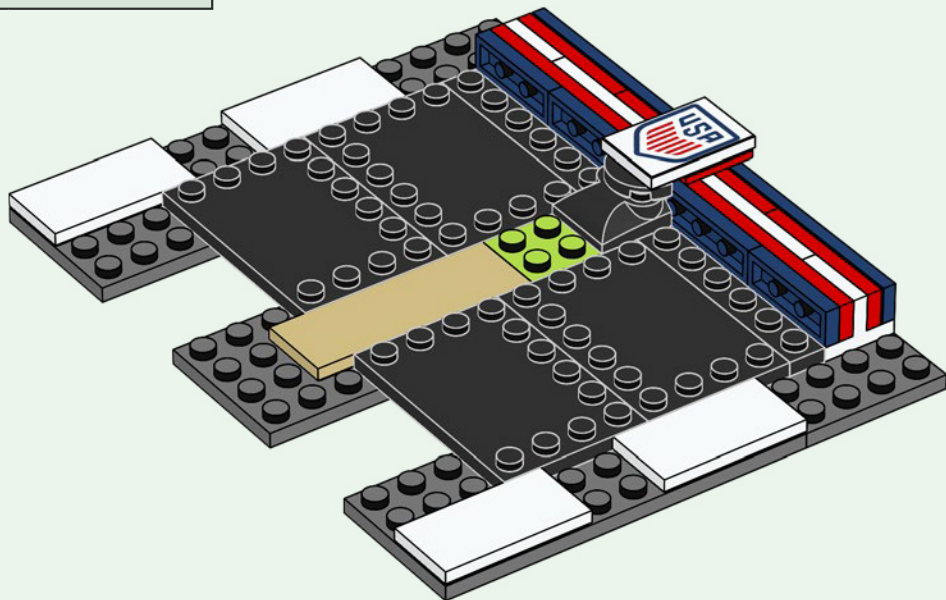

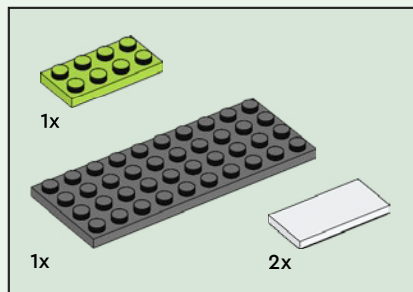

18

1

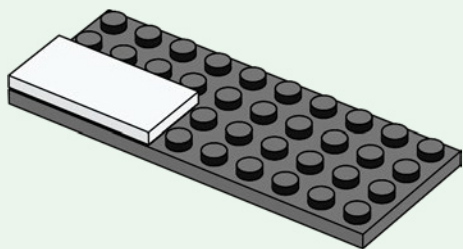

2

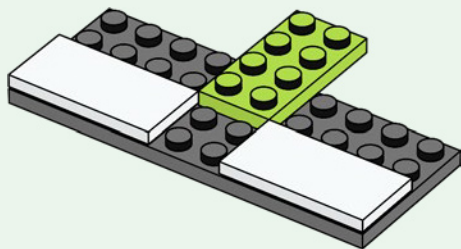

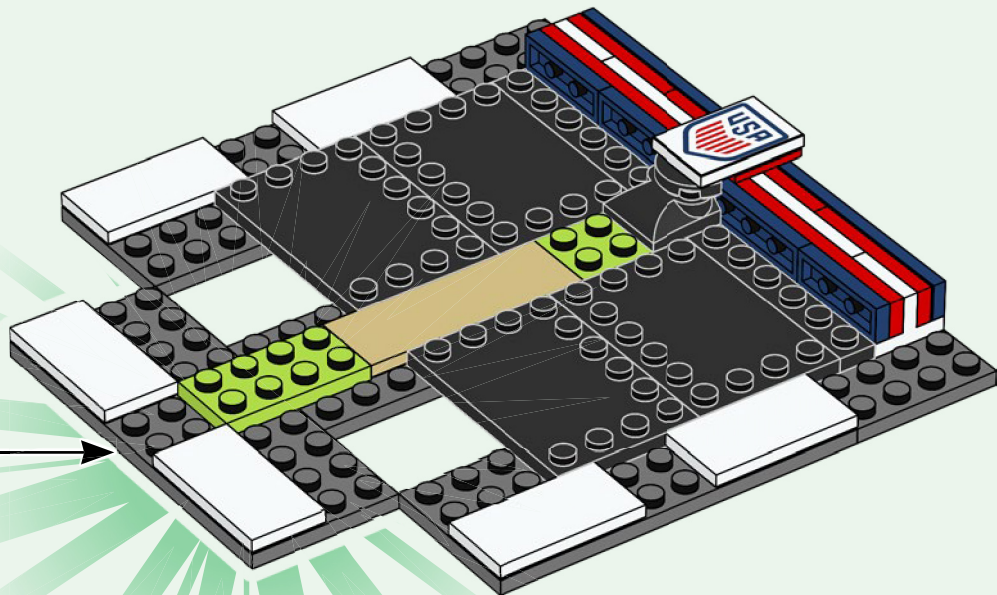

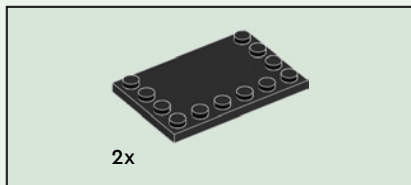

19

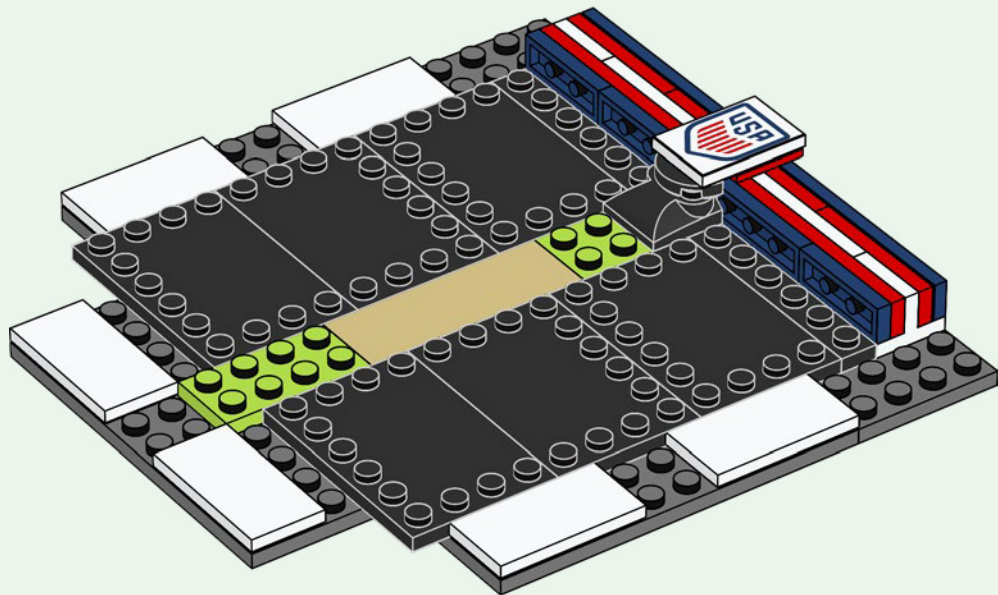

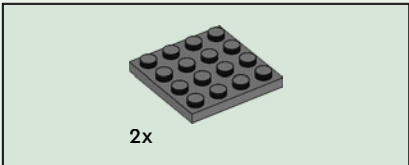

20

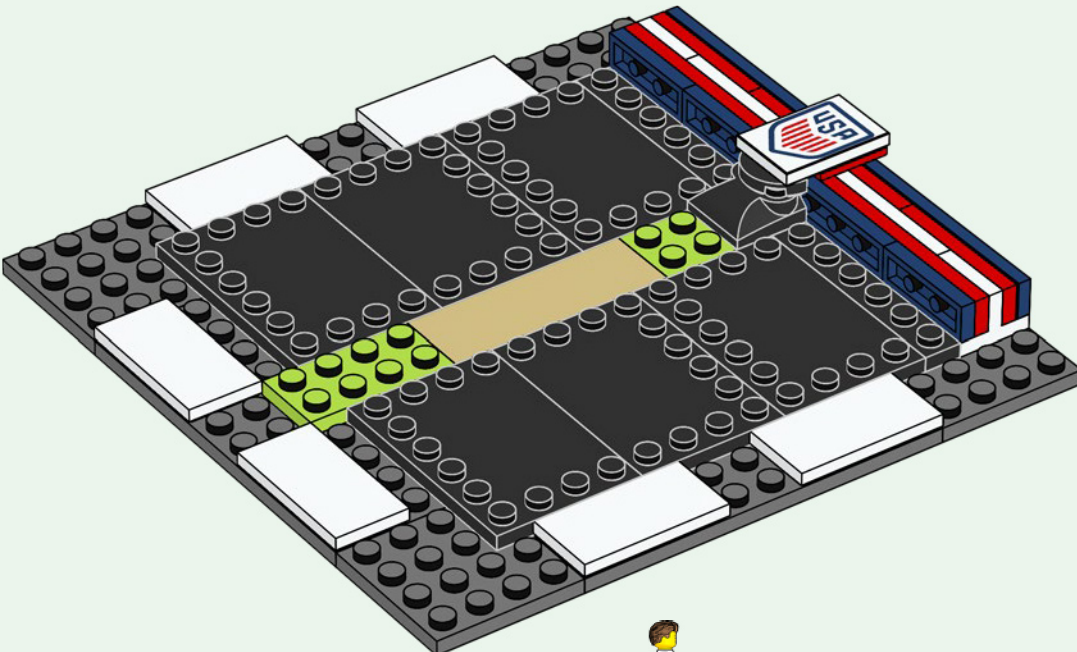

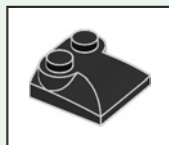
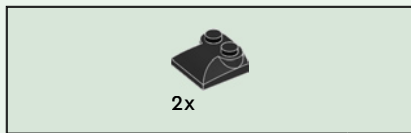

21

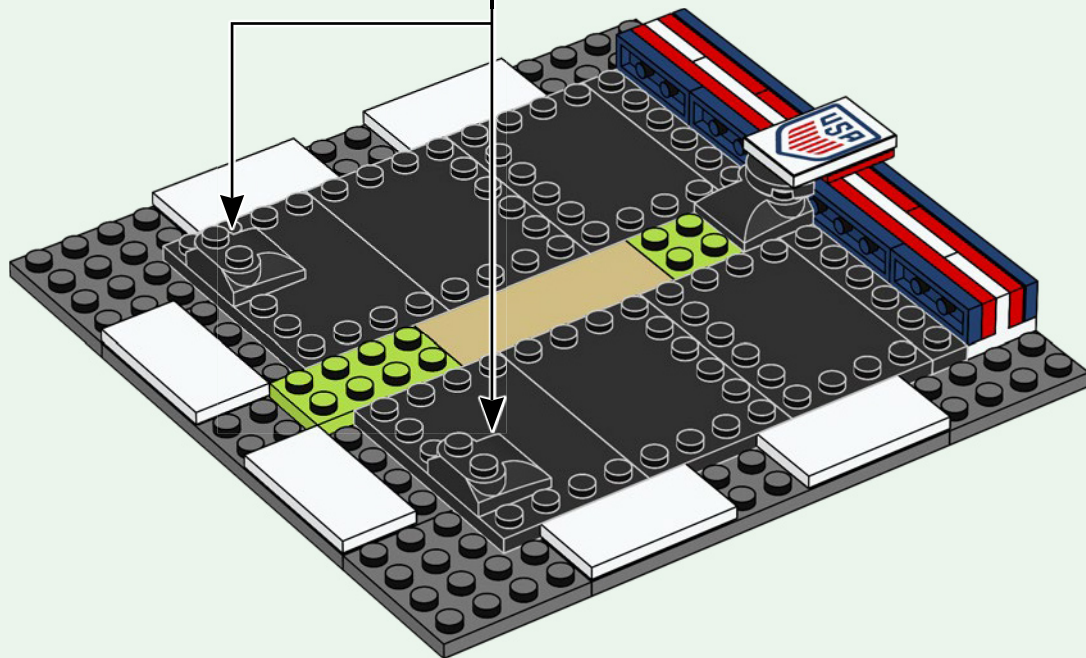

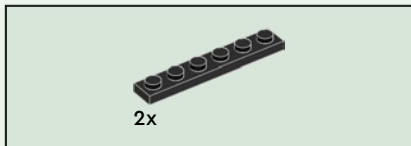

22

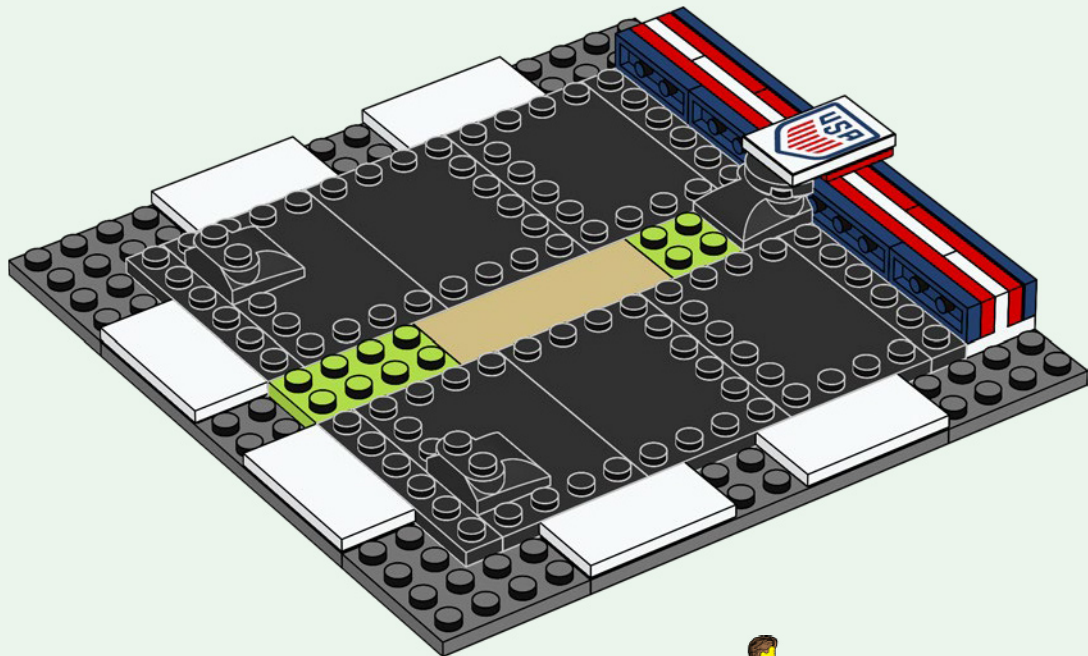

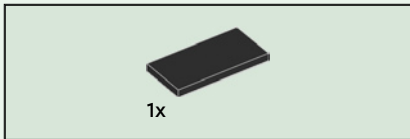

23

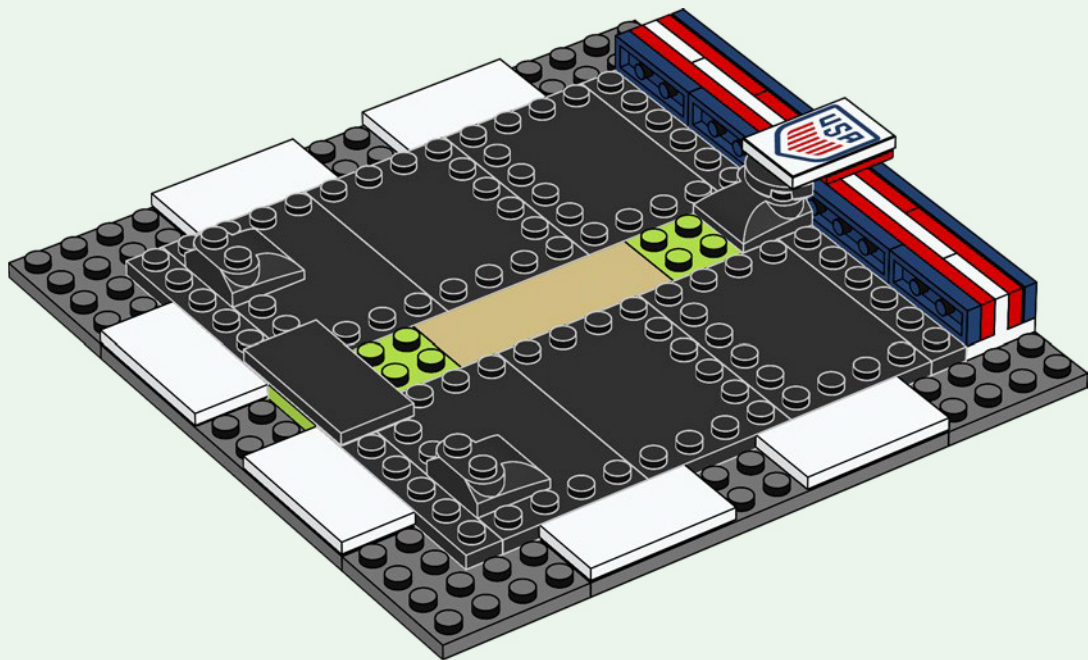

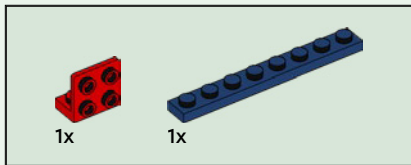

24

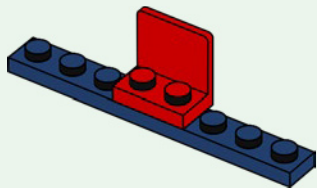

25

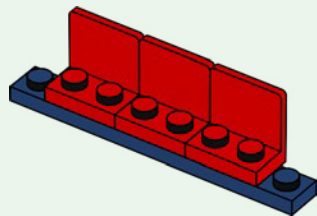

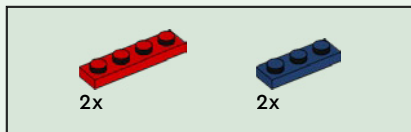

26

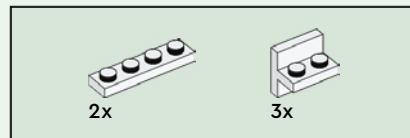
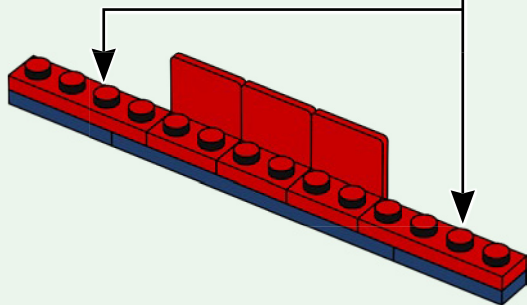
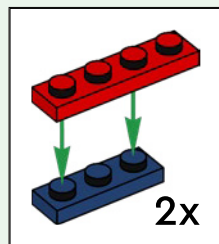

27

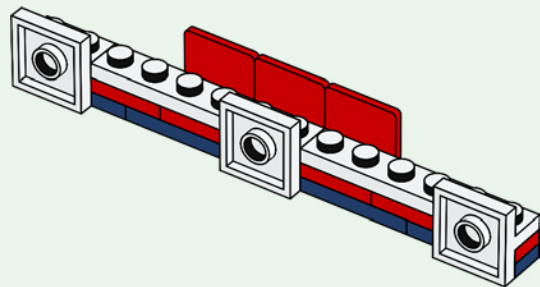

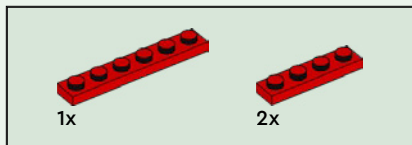

28

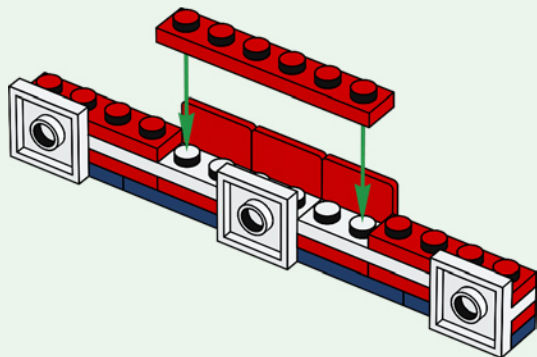

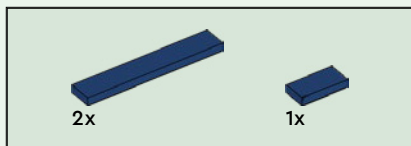

29

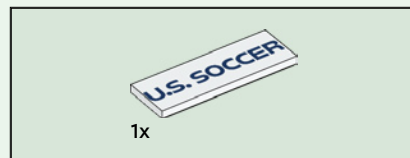
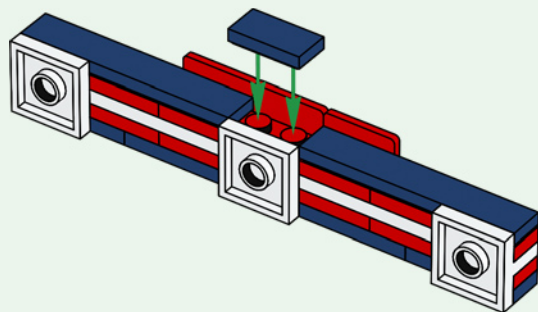

30

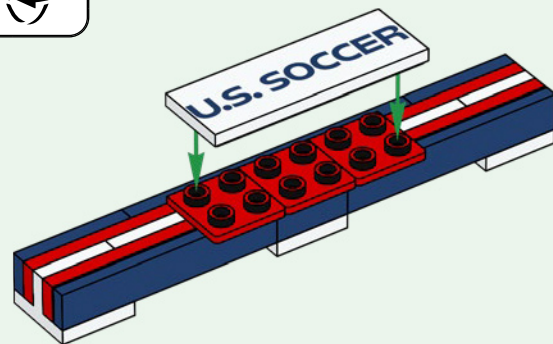

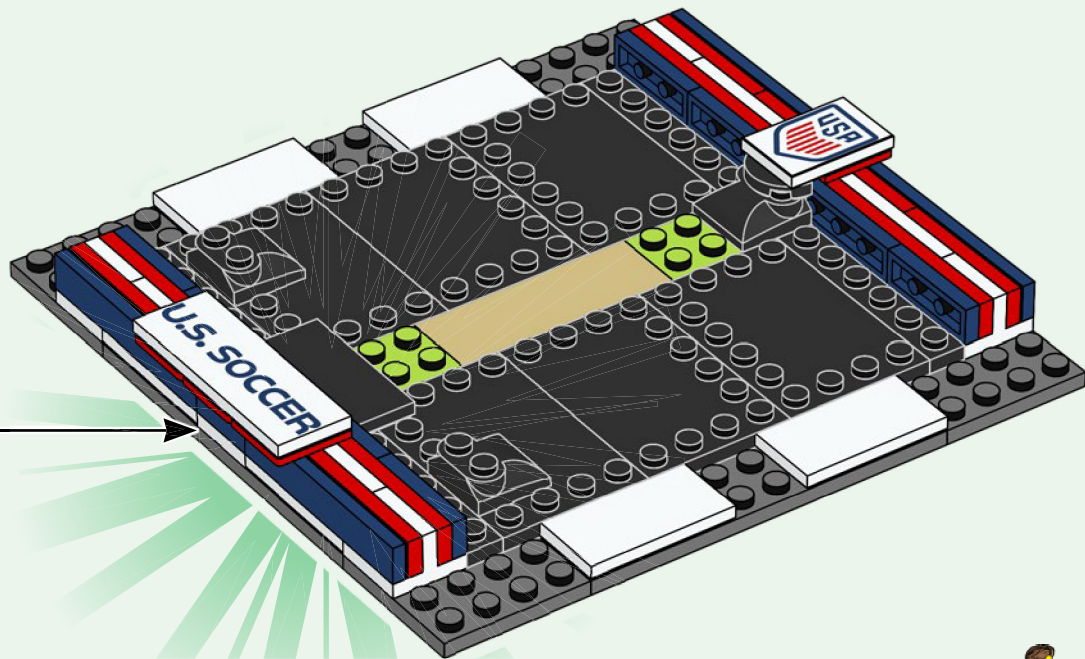



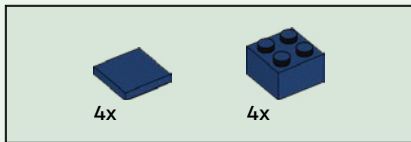

32

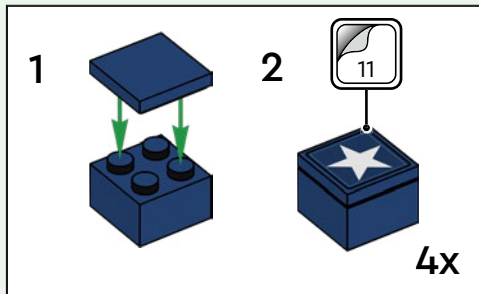
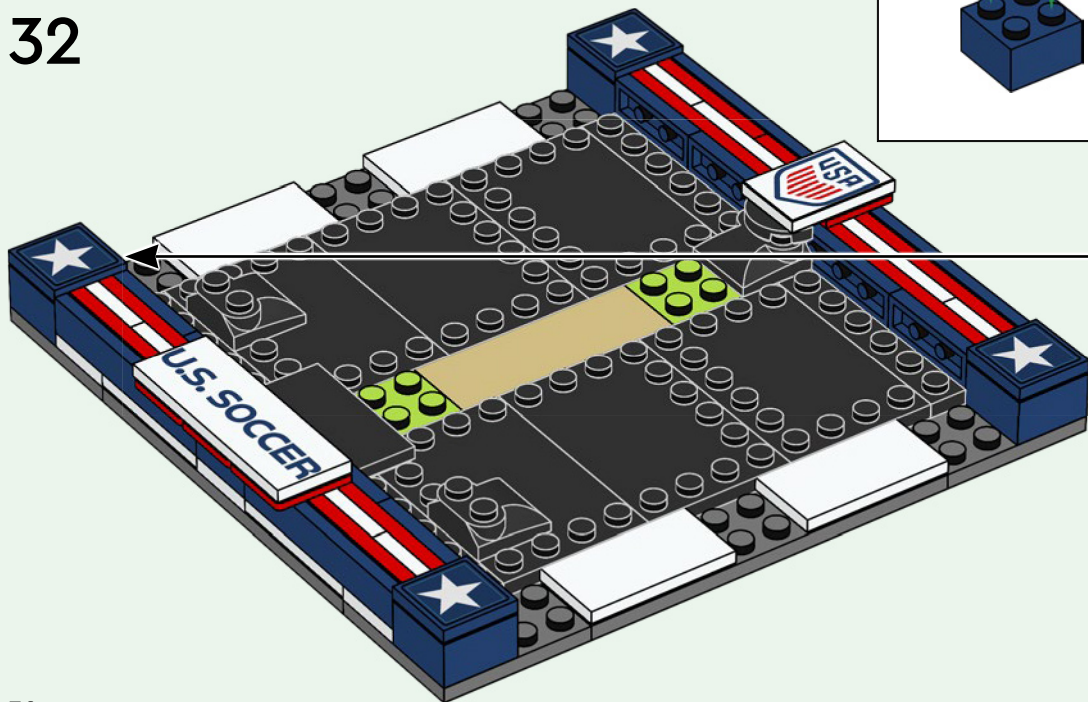

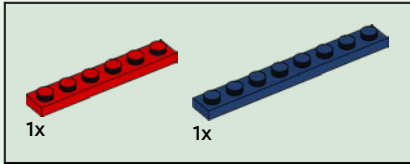
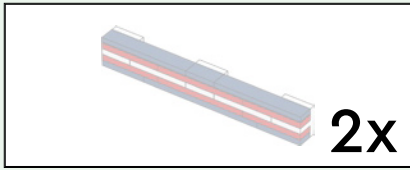

33

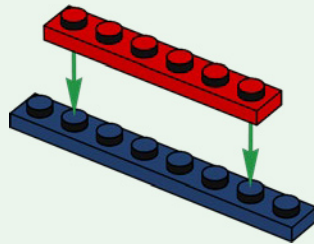

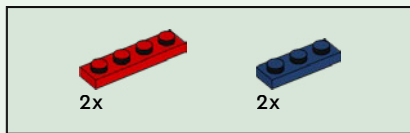

34

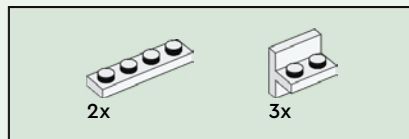
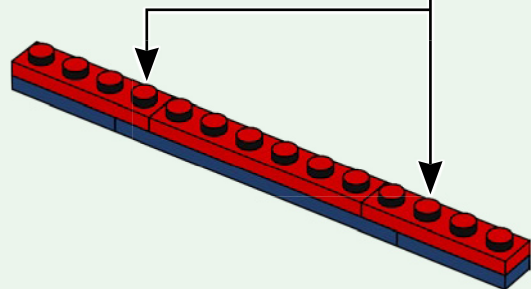
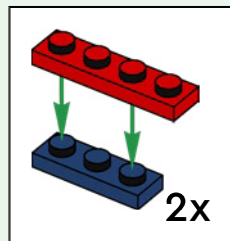

35

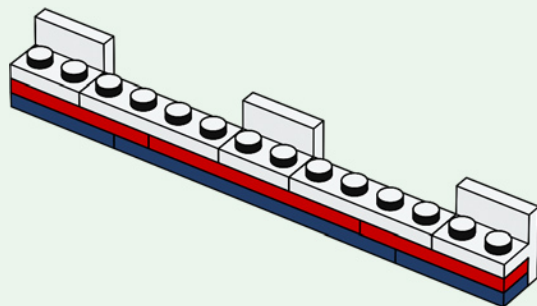

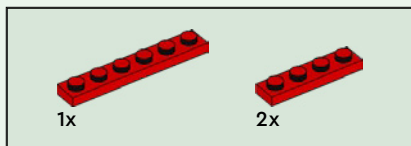

36

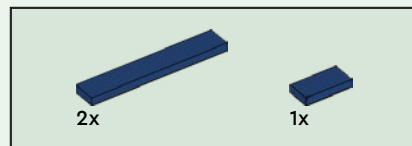
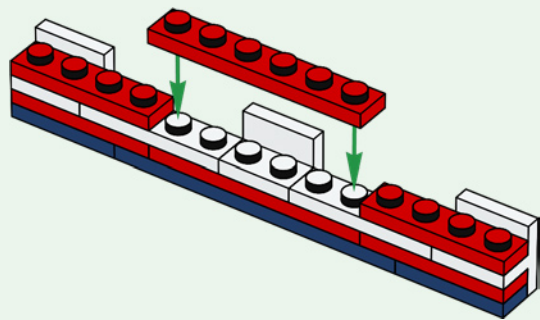

37

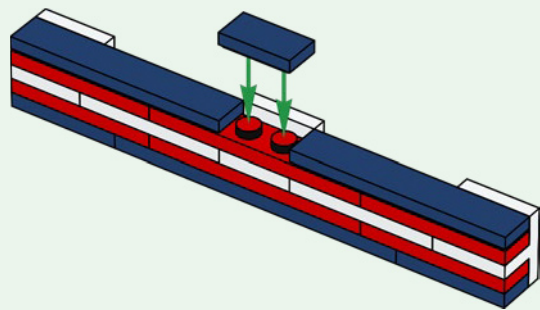

2x



38

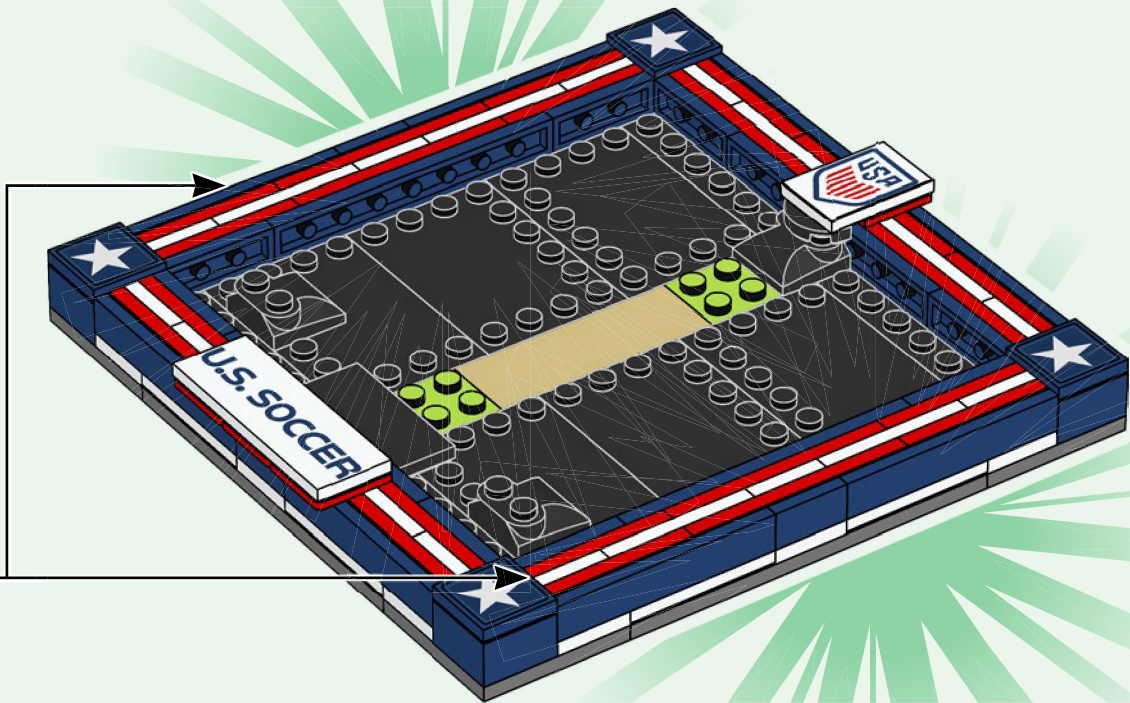

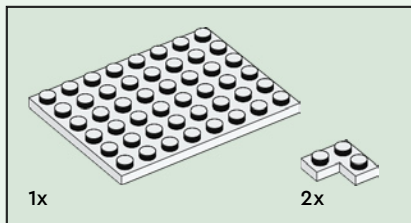

39

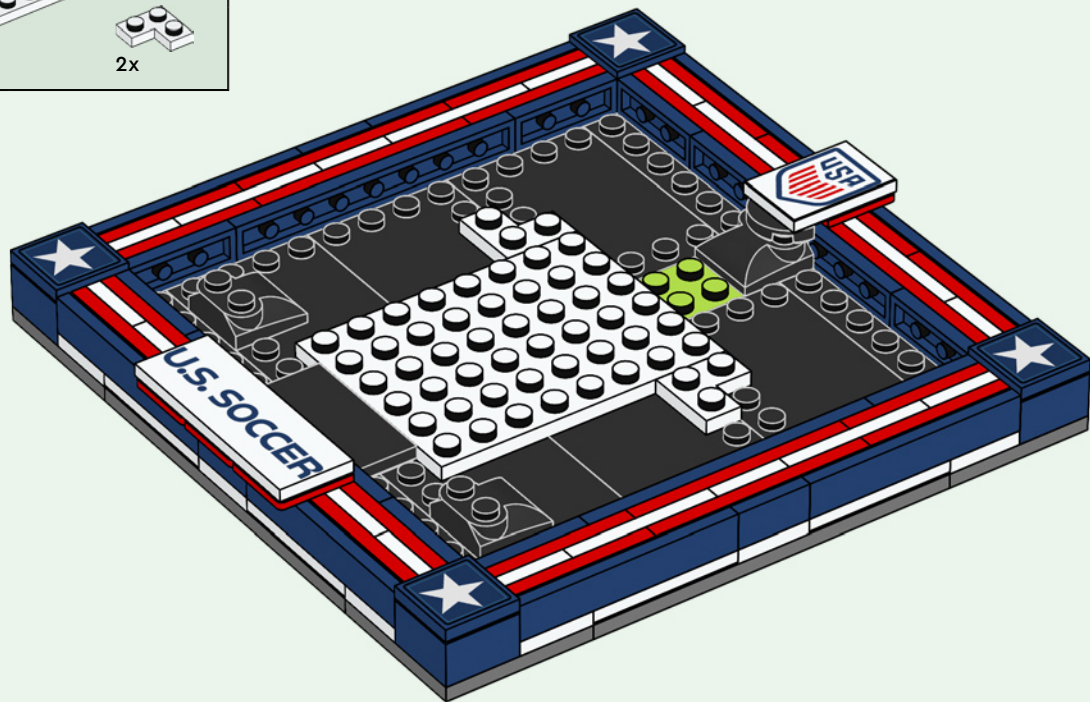

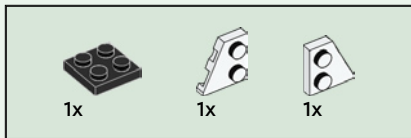

40

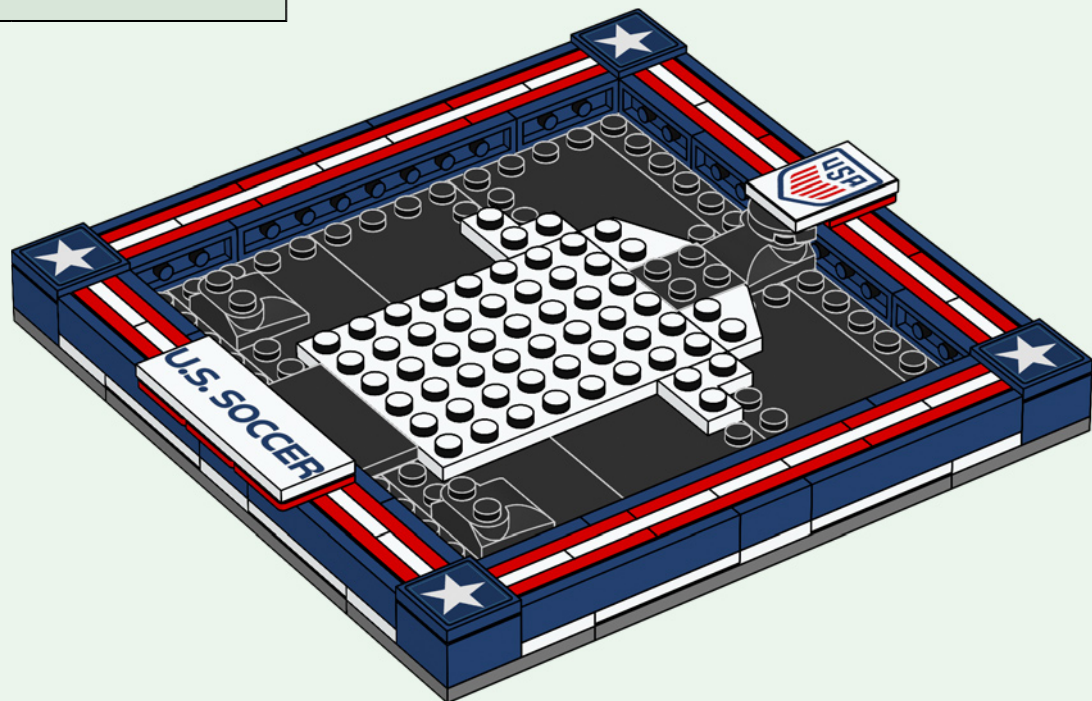

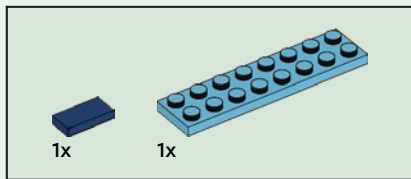

41

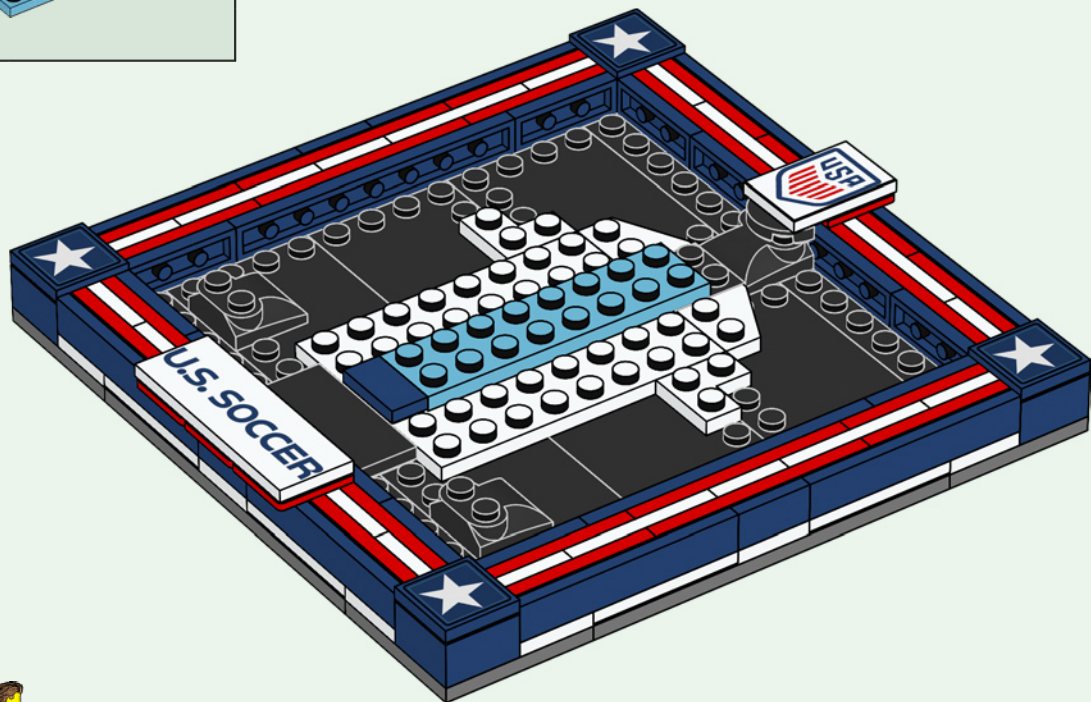

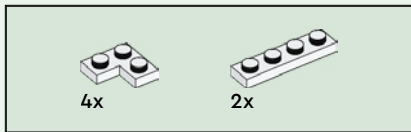

42

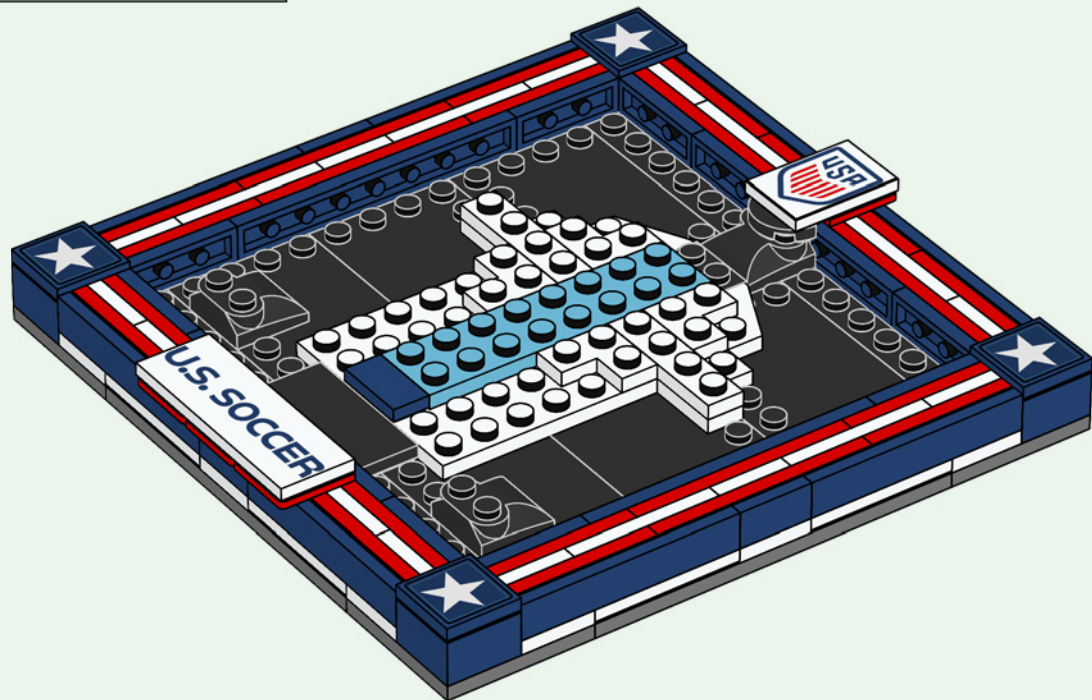

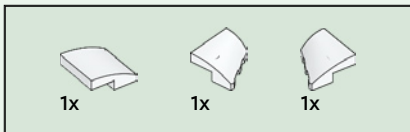

43

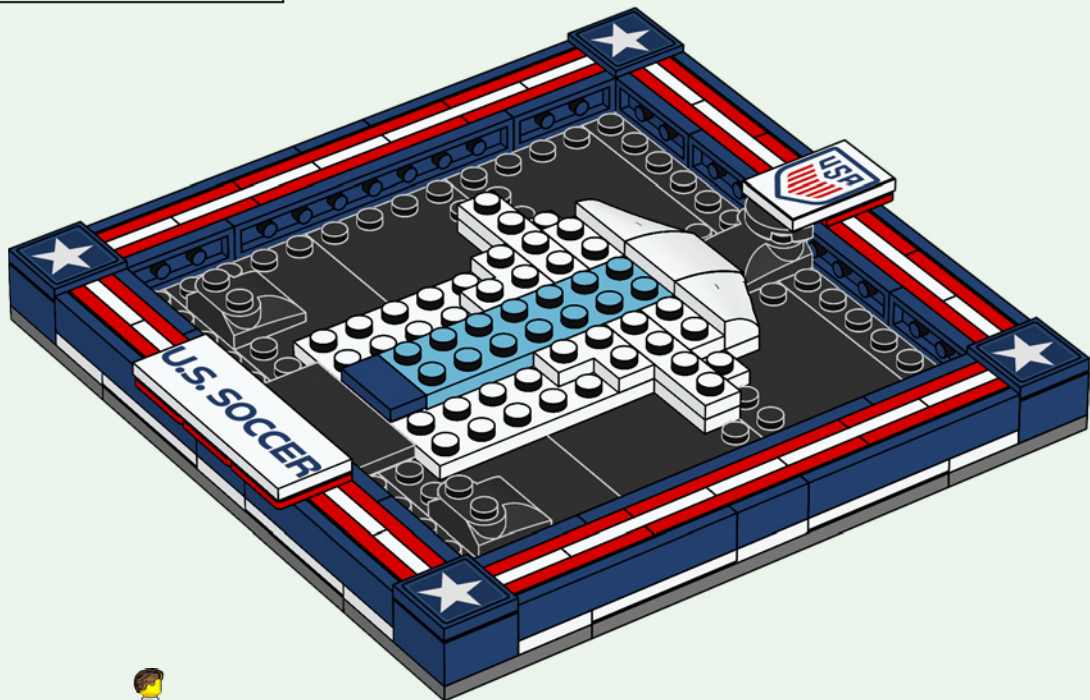

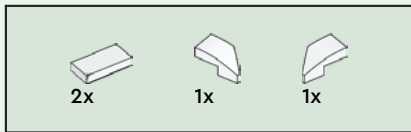

44

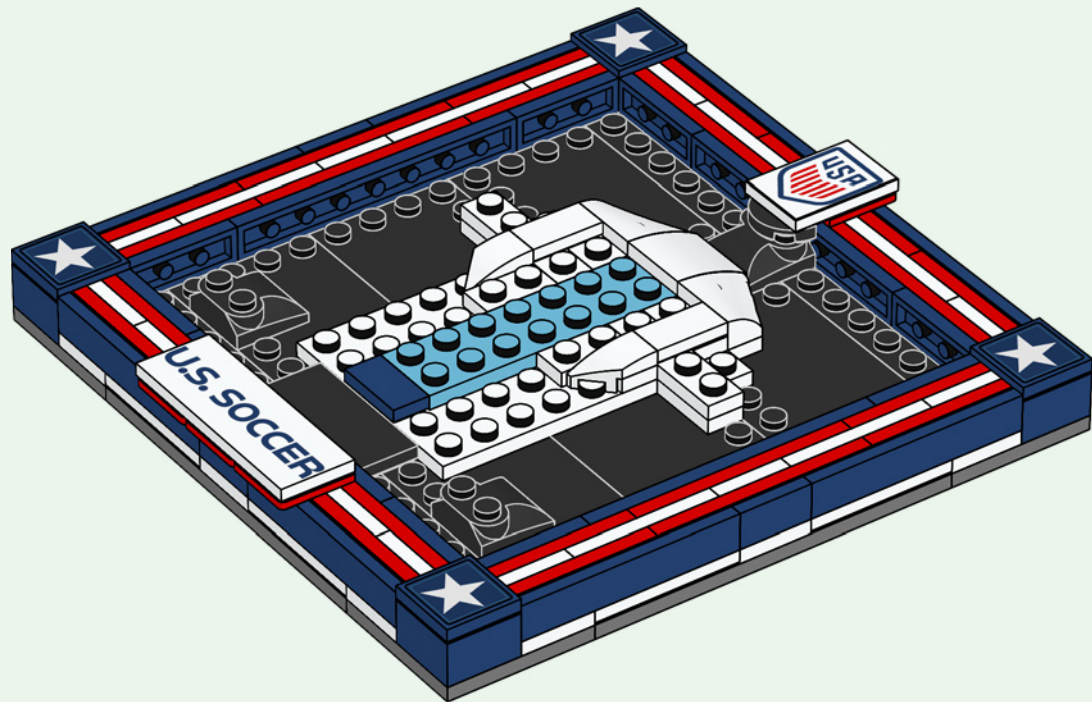

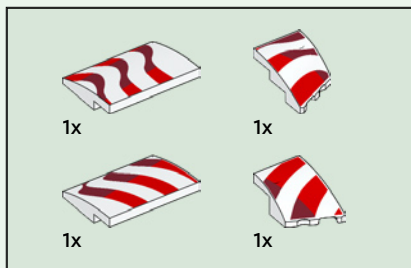

45

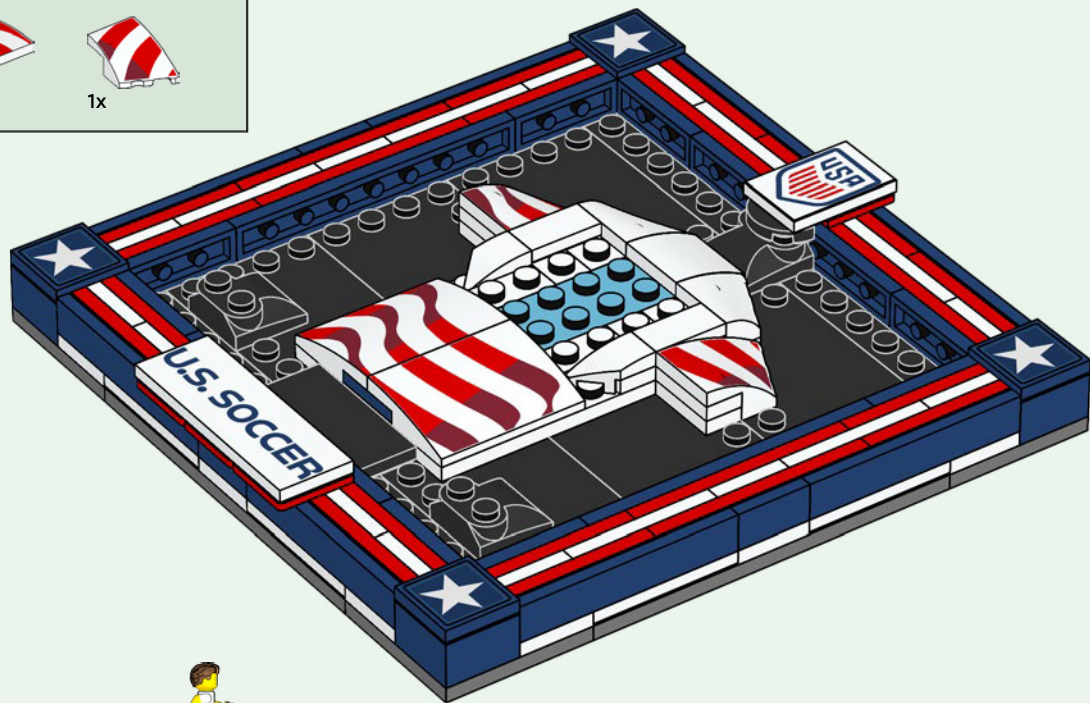

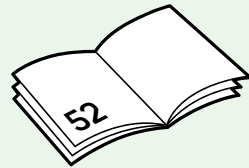
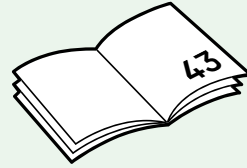





2x

46

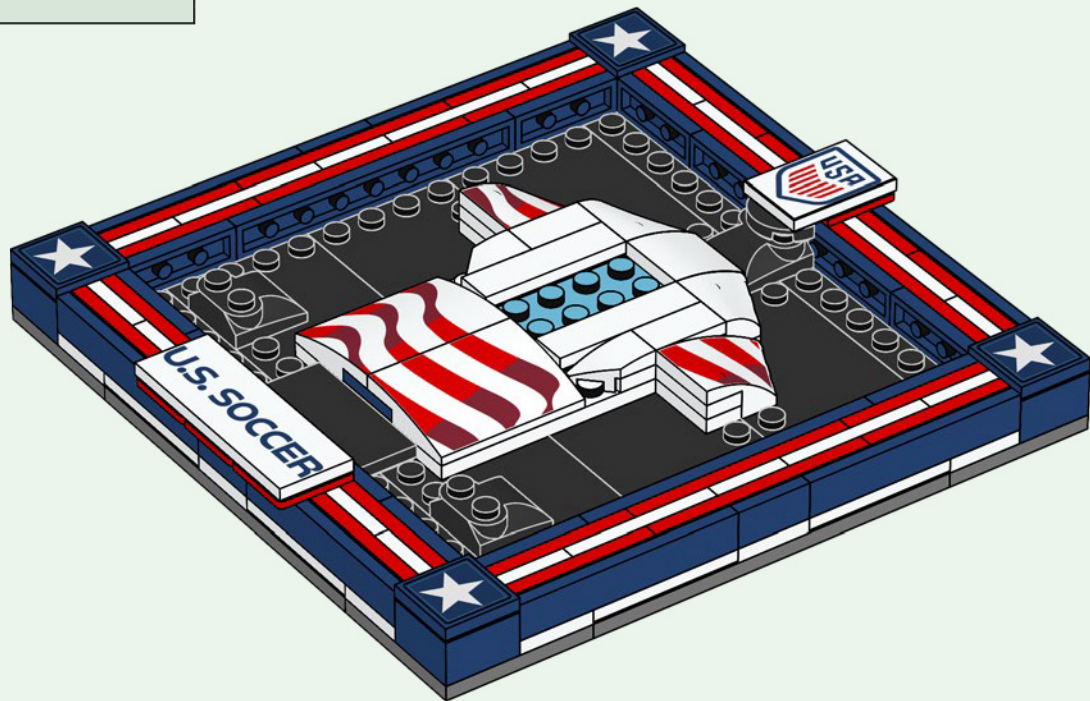

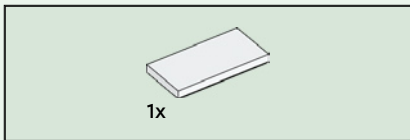

47

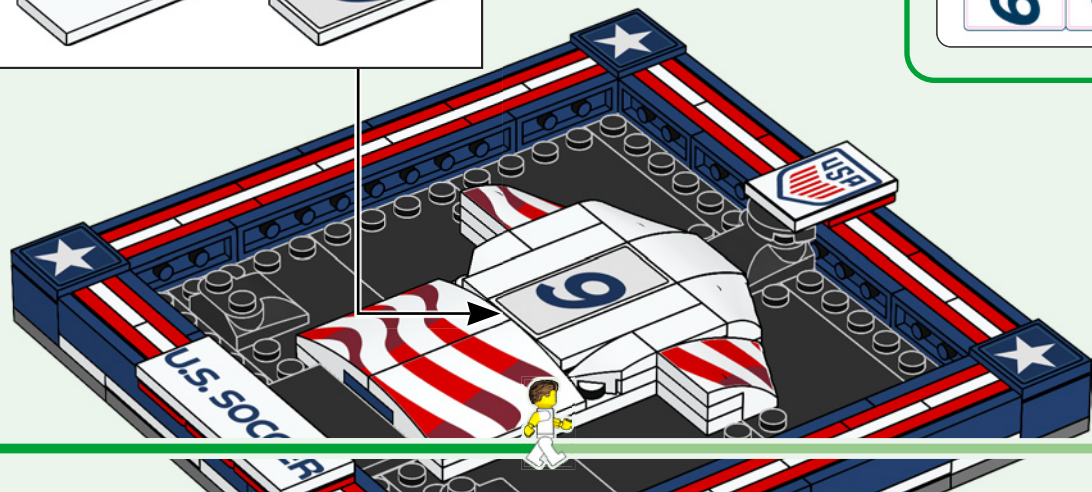
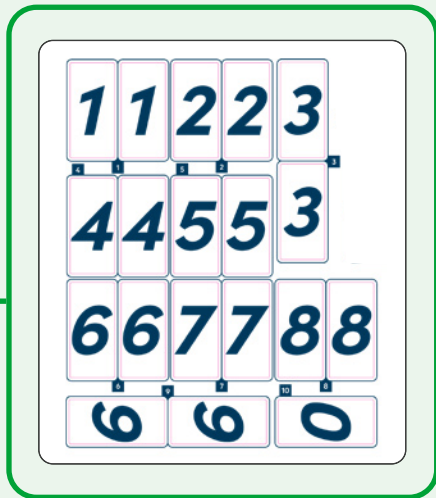
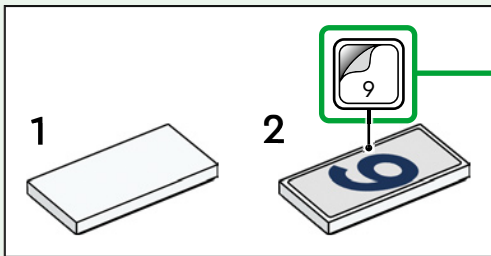

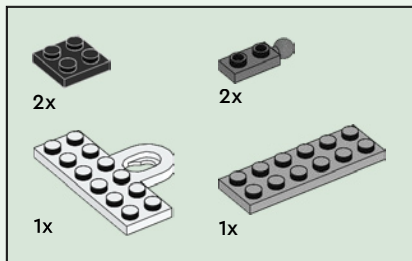

48

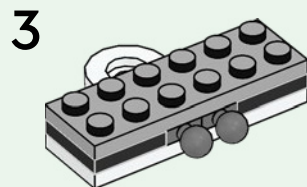
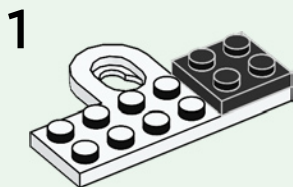

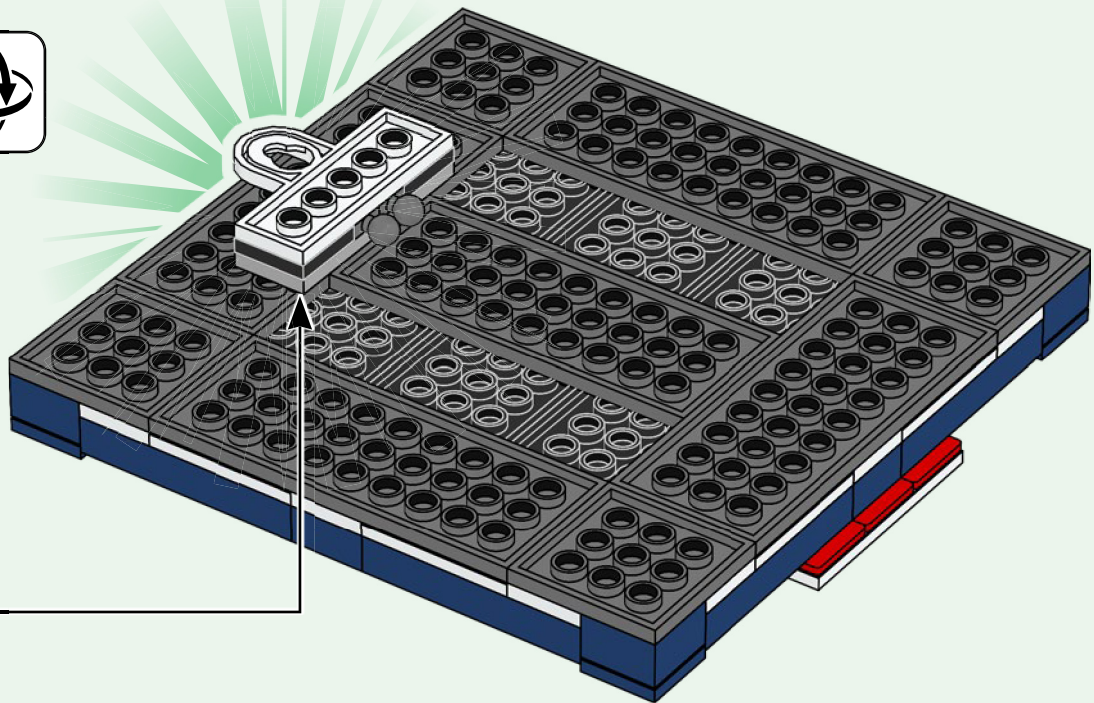

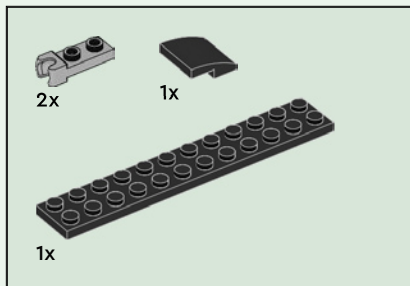

49

1

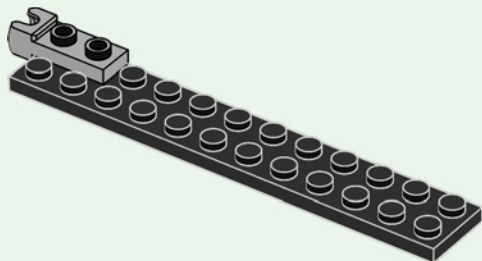

2

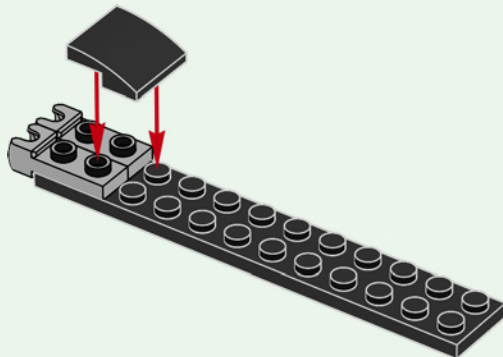

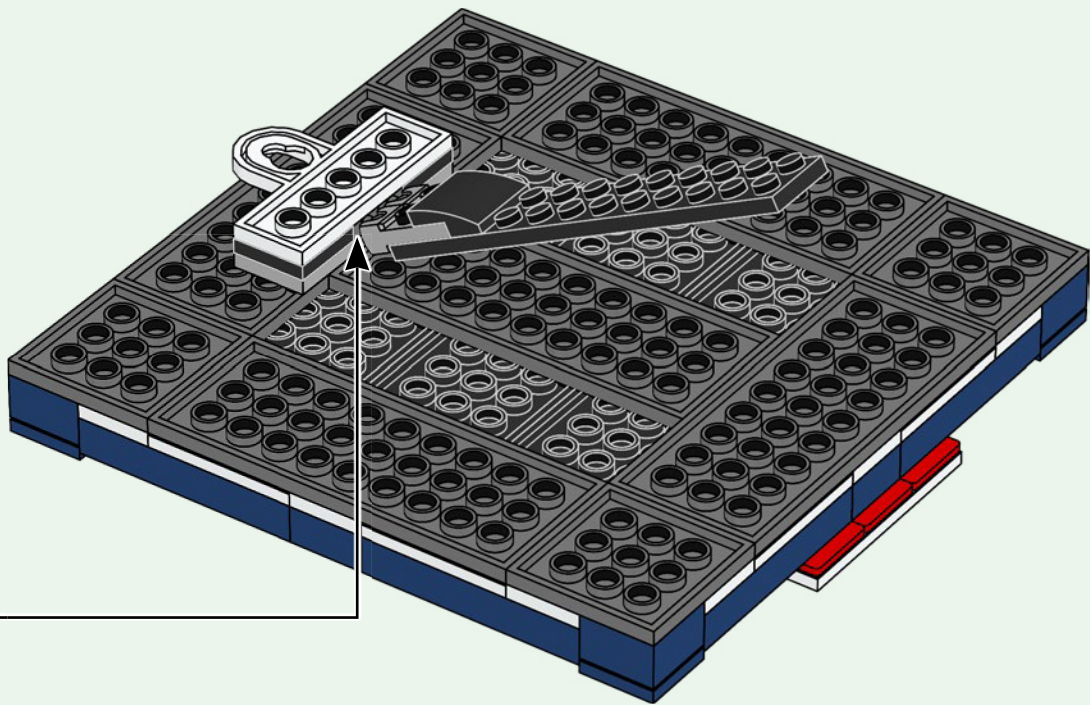

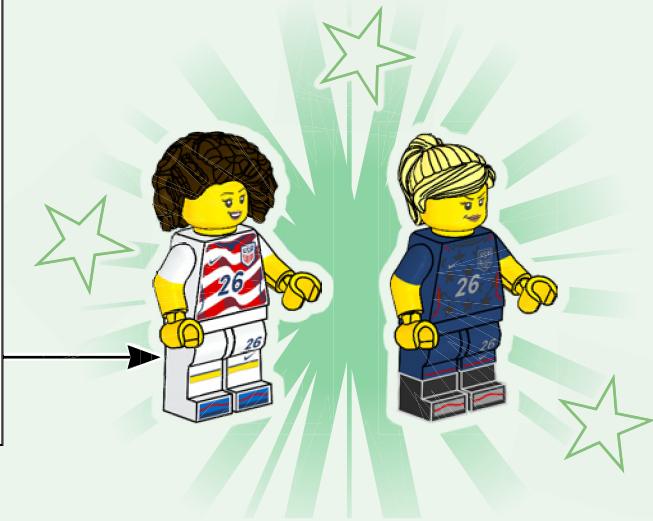
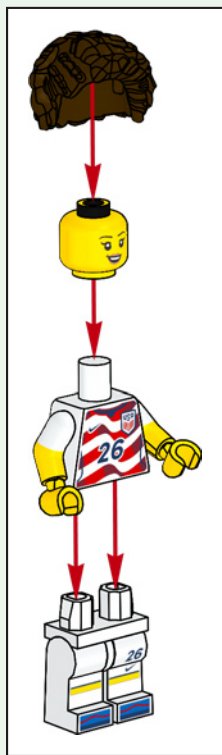





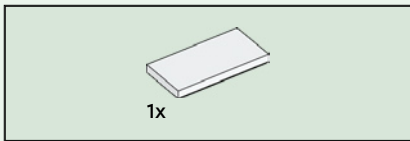

51

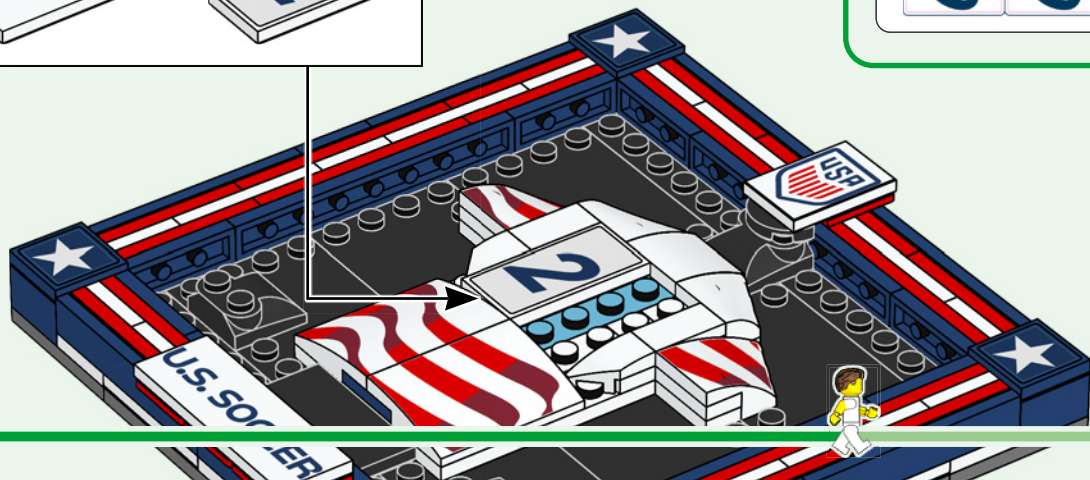
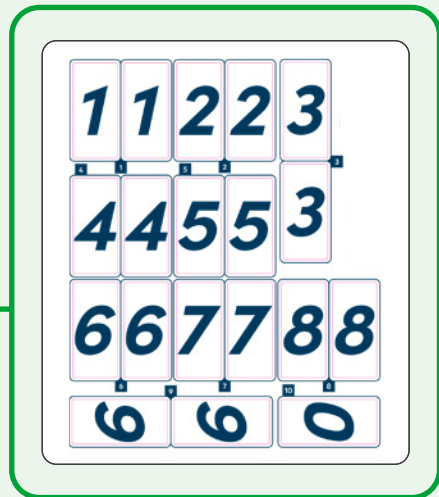
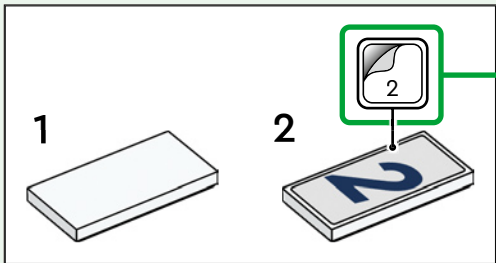

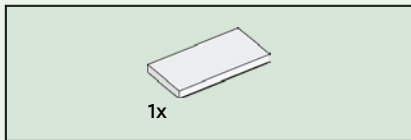

52

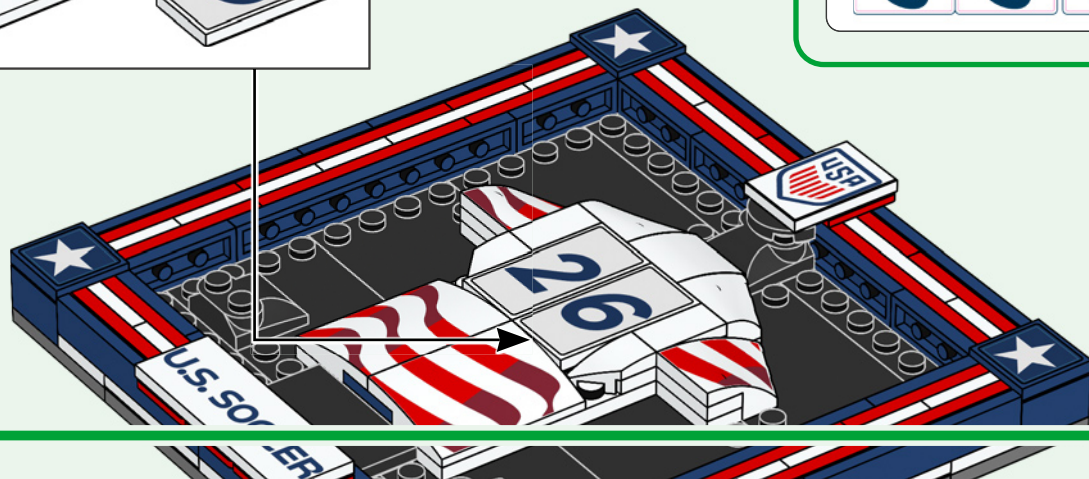
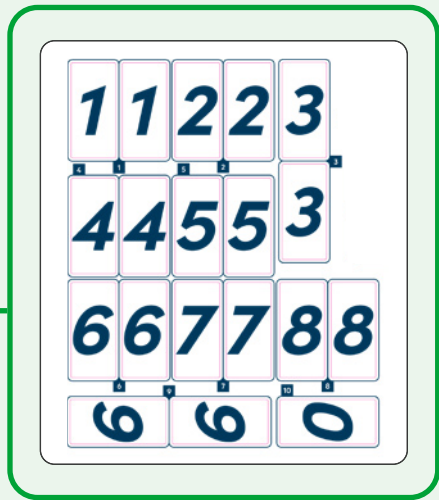
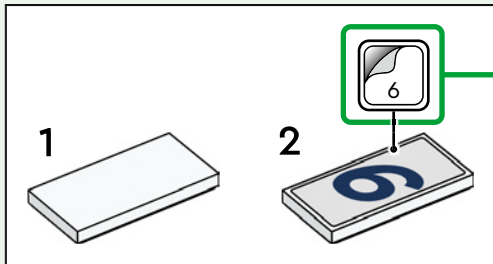

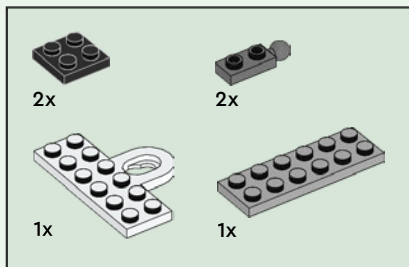

53

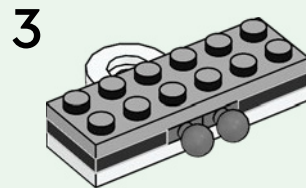
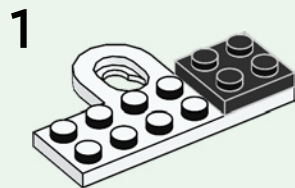

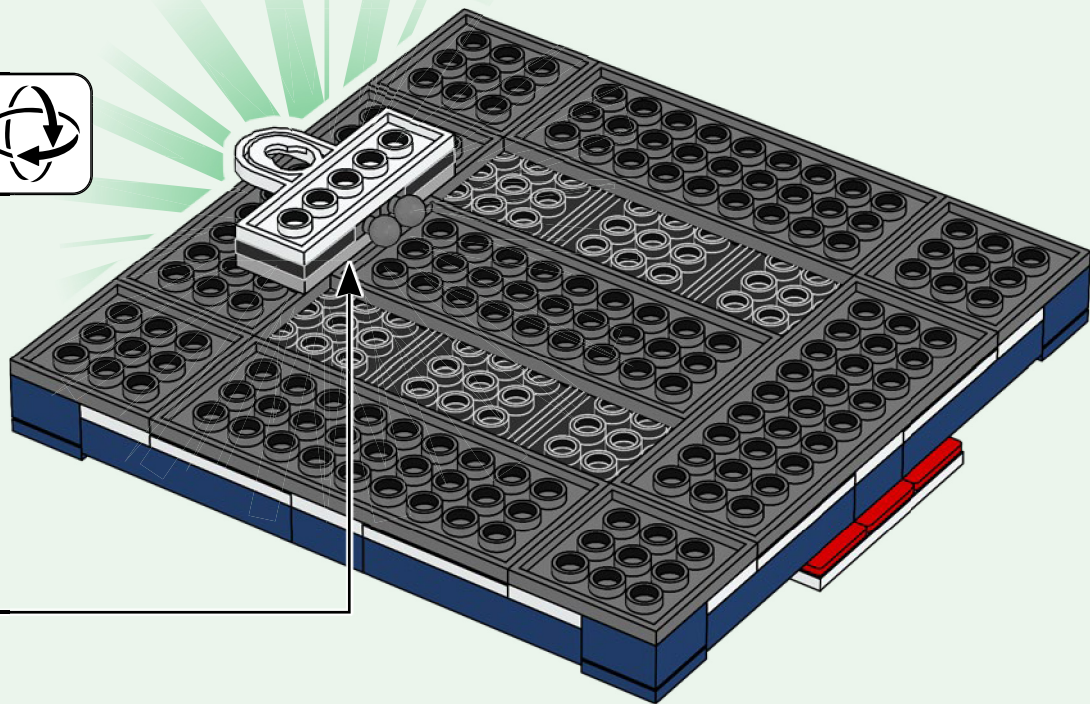

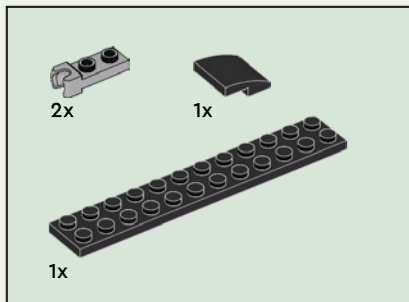

54

1

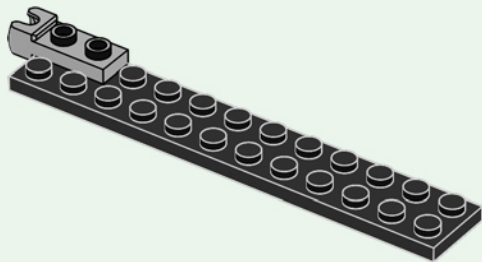

2

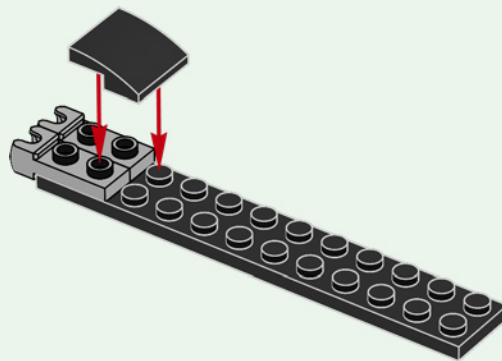

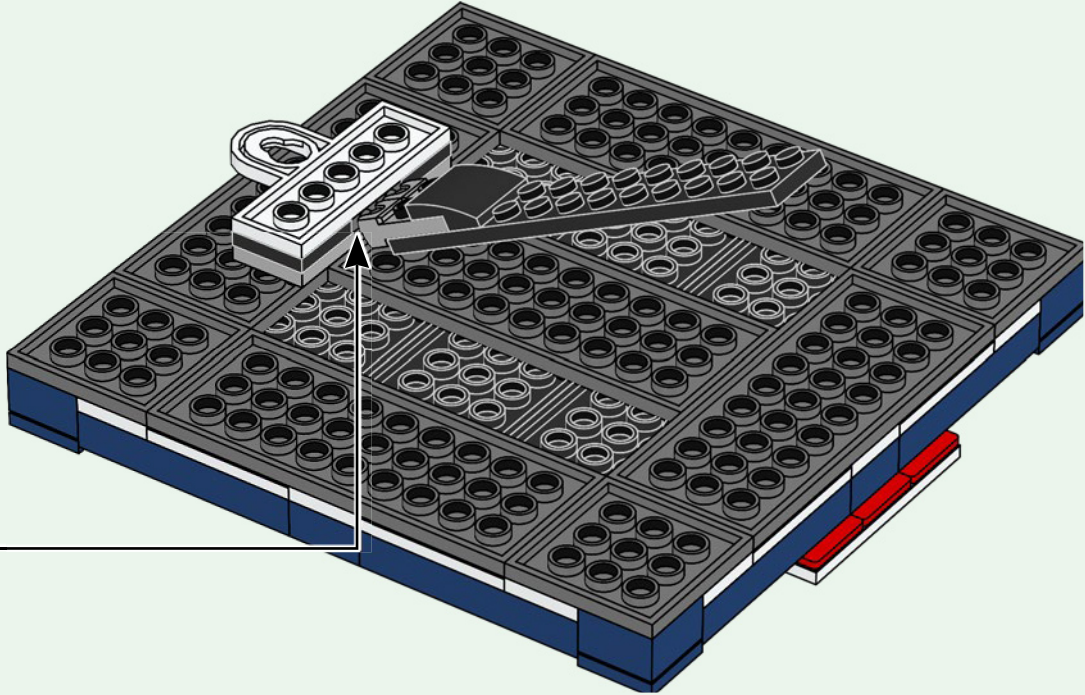

55

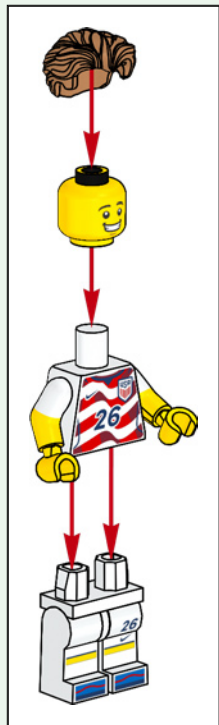





1x
6213880



1x
6213881



1x
6132203



1x
6132204



1x
6513906



1x
6507844



1x
6605667



2x
306901



12x
6250019



6x
242001



1x
6606654



1x
6047220



1x
6606656



1x
6626624



1x
6606657



2x
243101



10x
371001



10x
4560178



1x
6606653



1x
6606655



1x
6378415



1x
6605662



1x
303601



1x
6331158



4x
6001806



14x
371021



8x
366621



1x
6270320



1x
6153335



1x
6283884



1x
6174813



1x
6438933



1x
6510071



3x
6394979



1x
4560182



1x
244526



8x
4177735



1x
6631414



3x
302226



4x
366626



2x
4537936



1x
6626589



1x
6092833



1x
6053077

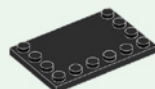

6x
4100378



1x
6605666



8x
4252437



1x
6409768



4x
6250216



5x
4211122



5x
4528488



2x
6043639



4x
4296785



1x
4211452



1x
6253666



4x
4205004



2x
6123814



4x
4243831



 [LEGO.com/service](https://www.lego.com/service)

YOU COULD
WIN

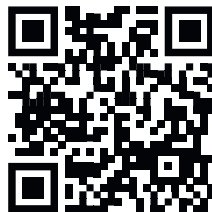

Scan this QR code or go to
LEGO.COM/PRODUCTFEEDBACK and give us
your short feedback about this LEGO® set
for a chance to win a cool LEGO prize.

Terms and Conditions apply*

EN: YOU COULD WIN. Terms and Conditions apply* **DE: Du könntest GEWINNEN.** Es gelten die Teilnahmebedingungen* **FR: TU POURRAIS GAGNER.** Des conditions s'appliquent* **IT: Potresti VINCERE tu.** Termini e condizioni sono applicabili* **ES: PUEDES GANAR.** Aplican términos y condiciones* **PT: PODERÁ GANHAR.** Aplicam-se Termos e Condições* **ZH: 轻松获奖.** 条款和条件适用* **PL: Szansa na WYGRANĄ.** Obowiązuje regulamin* **CS: Máte šanci VYHRÁT.** Platí všeobecné smluvní podmínky* **SK: Máte šancu VYHRAŤ.** Platia všeobecné zmluvné podmienky* **HU: TE IS NYERHETSZ!** Felhasználási feltételek érvényesek* **UA: ВИ МОЖЕТЕ ВИГРАТИ.** Застосовуються загальні положення та умови* **RO: Ai putea CÂȘTIGA.** Se aplică termenii și condiții* **BG: Можете да СПЕЧЕЛИТЕ.** Има определени правила и условия* **LV: Tu vari LAIMĒT.** Ir spēkā noteikumi un nosacījumi.* **ET: Sul on võimalus VÕITA.** Kehtivad tingimused* **LT: Jūs galite LAIMĖTI.** Taikomos sąlygos* **TR: KAZANABİLİRSİN.** Şartlar ve Koşullar geçerlidir*

*[LEGO.com/productfeedback-terms](https://www.lego.com/productfeedback-terms)

Editions™

LEGO, the LEGO logo and the Editions logo are trademarks of the LEGO Group. ©2026 The LEGO Group
U.S. Soccer is a trademark of the United States Soccer Federation, Inc. All rights reserved.

© 2026 U.S. Soccer



6647413