

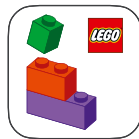

Editions™

43032



LEGO® Builder





LEGO.com/sustainable-packaging



 ^{FR} **DONNEZ**
OU
RECYCLEZ

 OU  OU 

ASSOCIATION MAGASIN DÉCHÈTERIE

Adresses sur quefairedemesdechets.fr

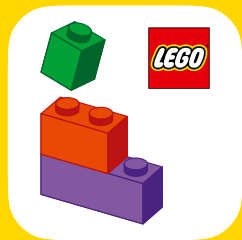

LEGO® Builder



BUILDER



Apple and the Apple logo are trademarks of Apple Inc., registered in the U.S. and other countries and regions. App Store is a service mark of Apple Inc. Google Play and the Google Play logo are trademarks of Google LLC. Tencent and the Tencent logo are trademarks of Tencent Inc.

LEGO.com/devicecheck

EN Ask parents' permission before going online | DE Eltern um Erlaubnis bitten, bevor du online gehst | FR Demande l'autorisation d'un parent avant d'aller en ligne | IT Chiedi il permesso ai tuoi genitori prima di andare online | ES Pídeles permiso a tus papás antes de conectarte a Internet | PT Pede autorização aos teus pais antes de ficares online | ZH 上网前应先征得父母的同意 | PL Poproś rodziców o zgodę, zanim wejdiesz do Internetu | CS Než půjdeš na internet, požádej rodiče o svolení | SK Skôr než pôjdeš na internet, vypýtaj si povolenie od rodičov | HU Kérj szülői engedélyt, mielőtt online csatlakoznál! | UA Запитуйте дозволу батьків, перш ніж користуватися інтернетом | RO cere permisiunea părinților înainte de a te conecta online | BG Поискайте разрешение от родител, преди да влезете онлайн | LV Pirms došanās tiešsaistē palūdz atļauju vecākiem | ET Enne Interneti kasutamist küsi vanematelt luba | LT Prieš prisijungdami prie interneto, atsiklauskite tėvų | TR İnternete girmeden önce anne babandan izin iste



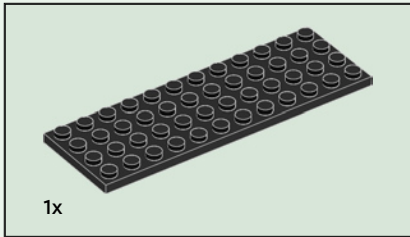

1

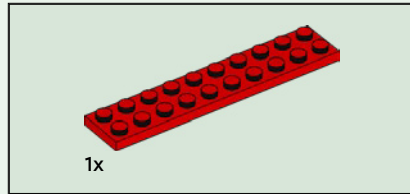
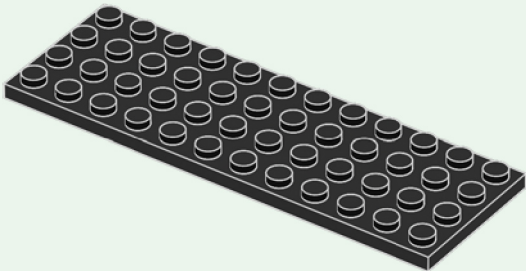

2

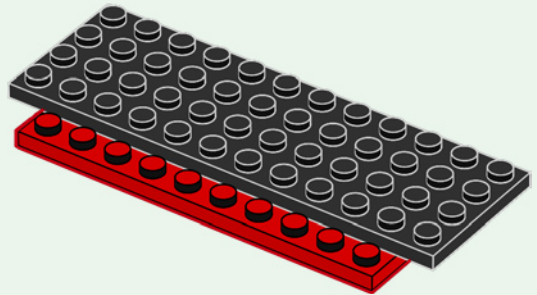

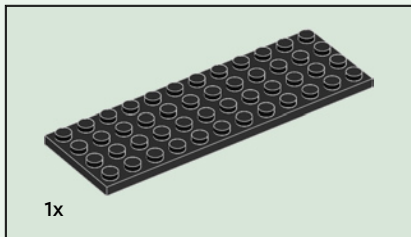

3

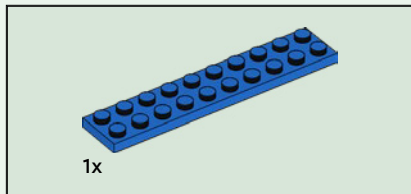
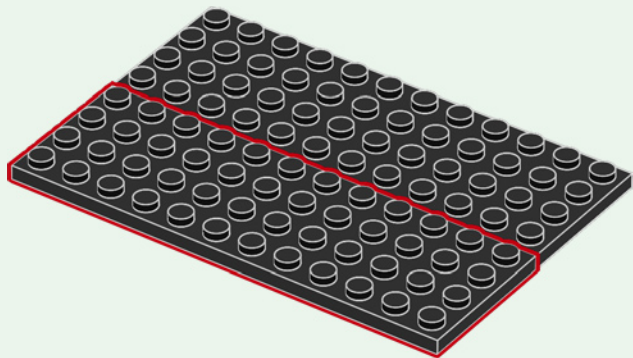

4

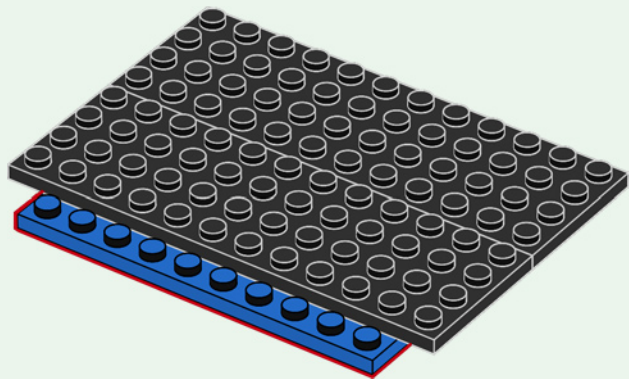

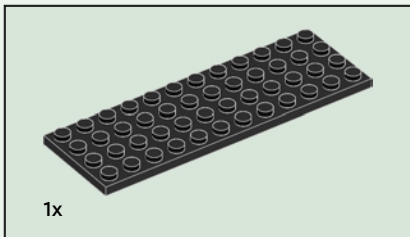

5

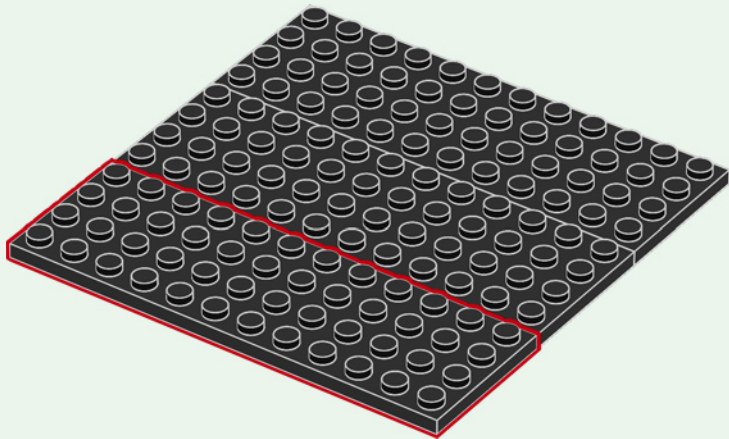

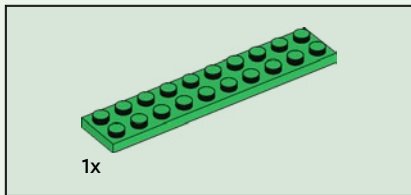

6

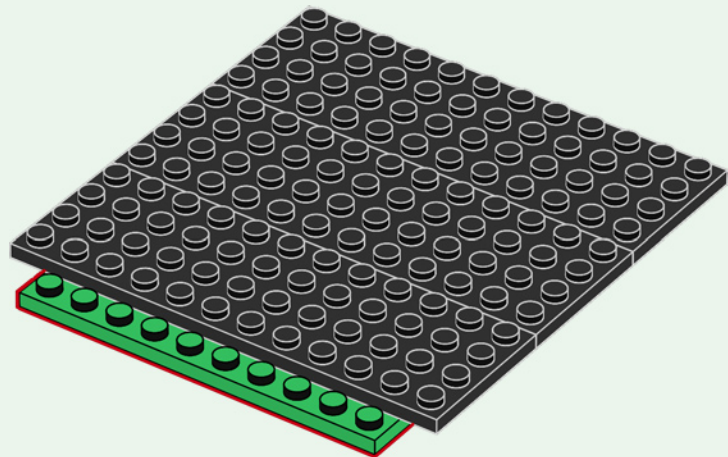

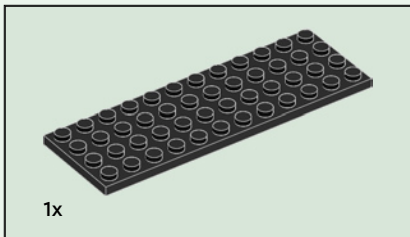

7

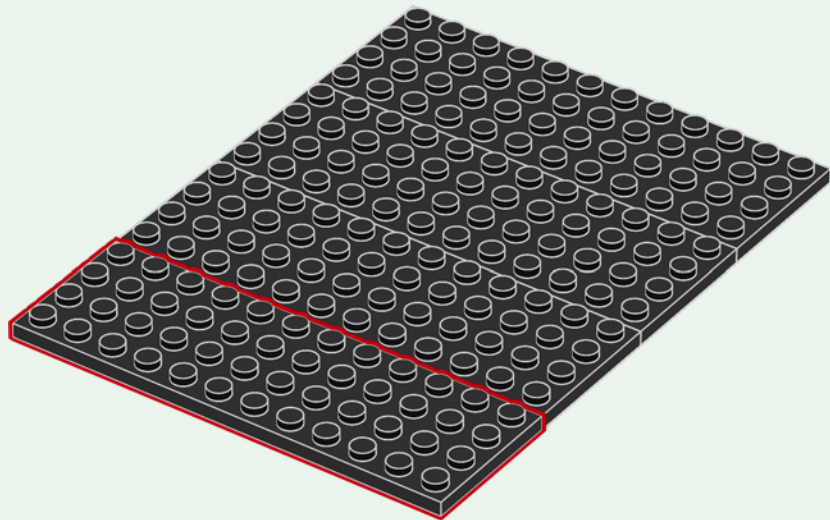

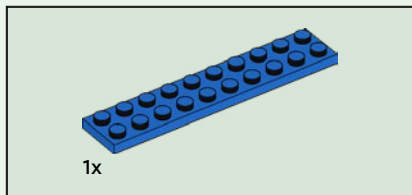

8

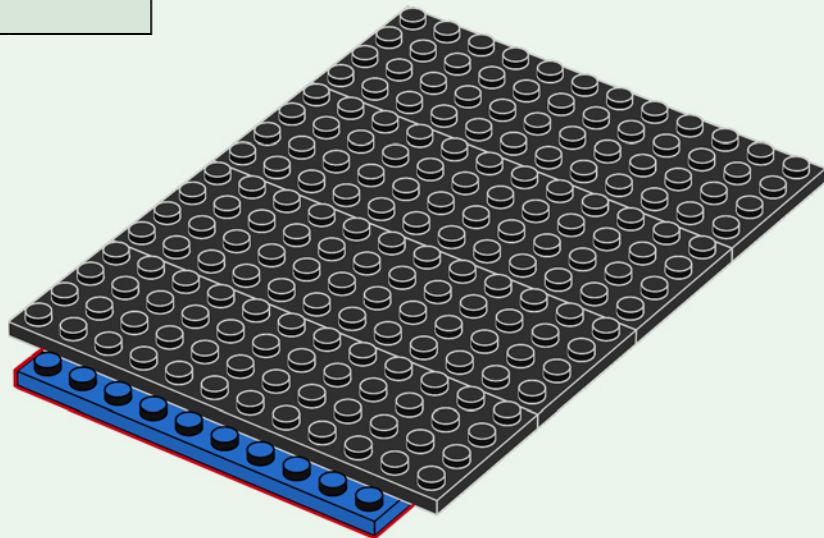

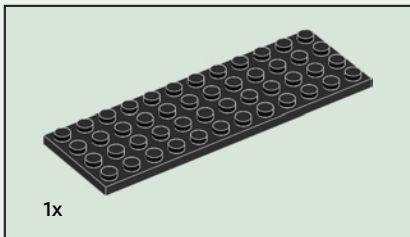

9

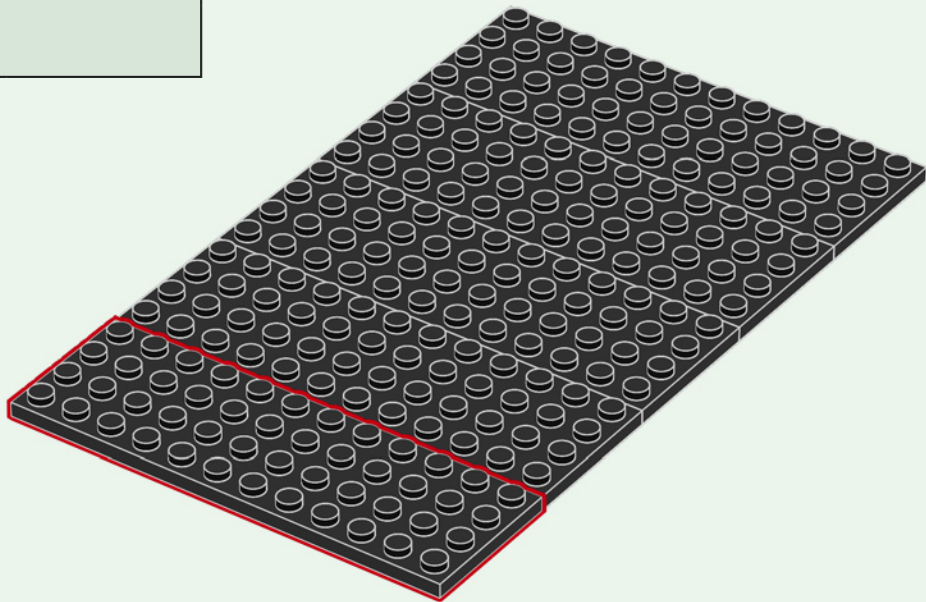

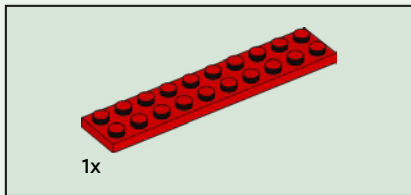

10

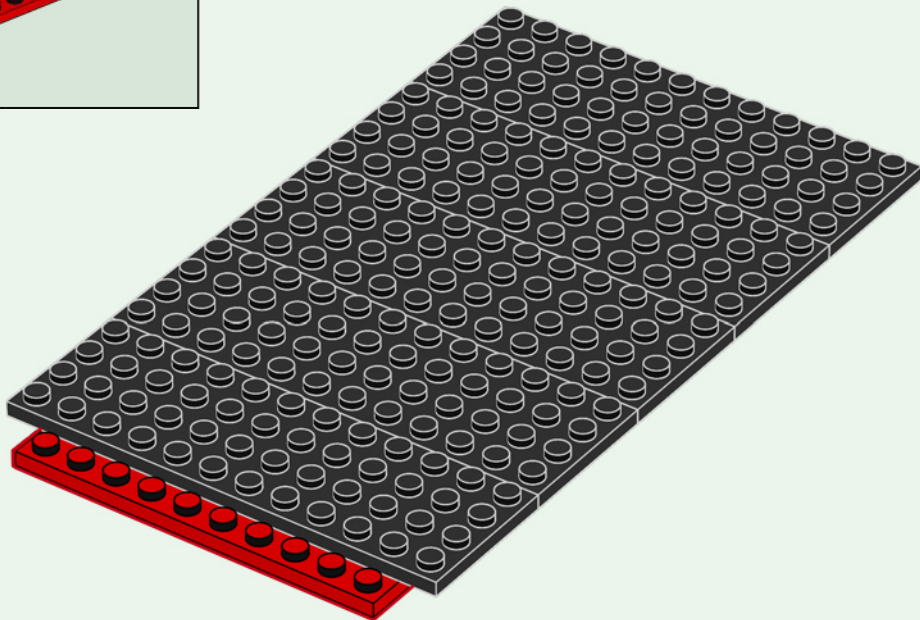

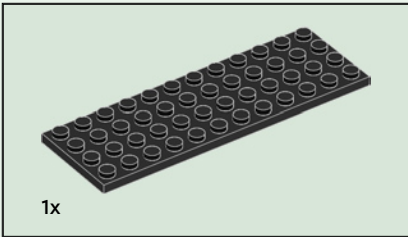

11

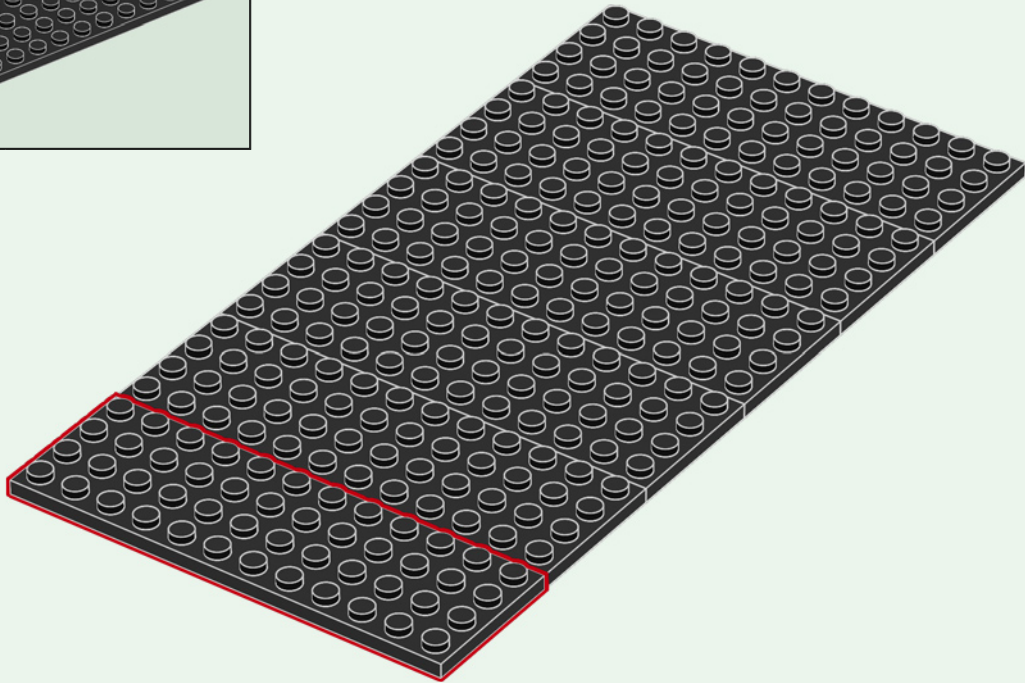

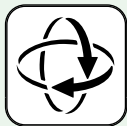
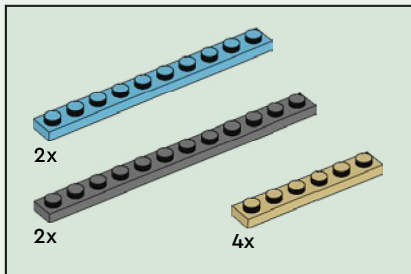

12

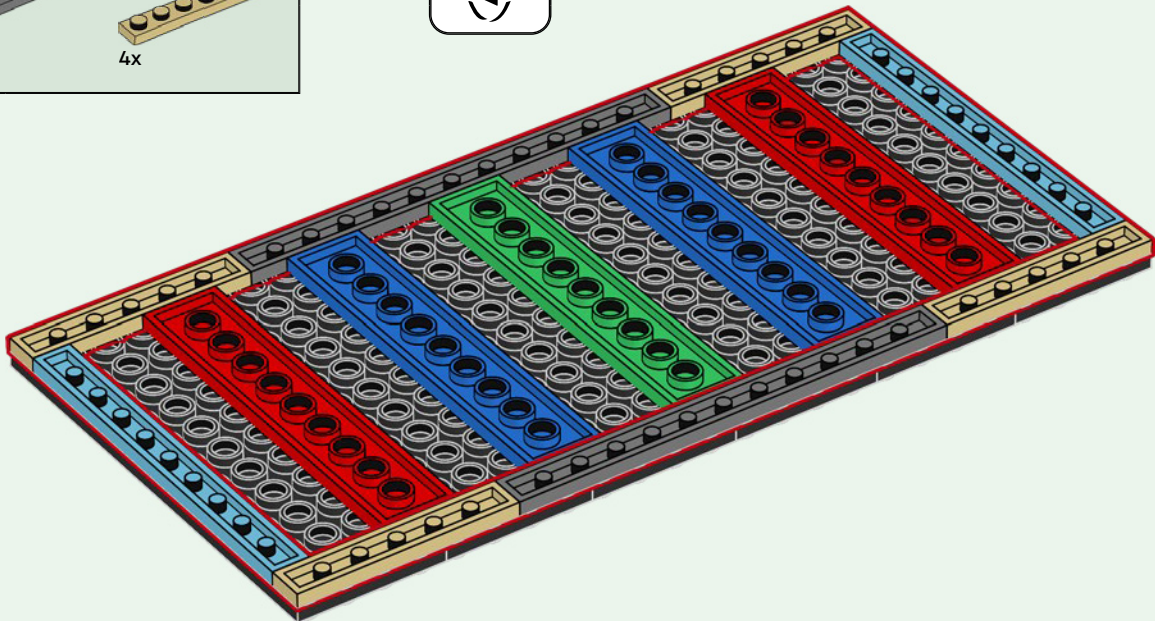



4x

13

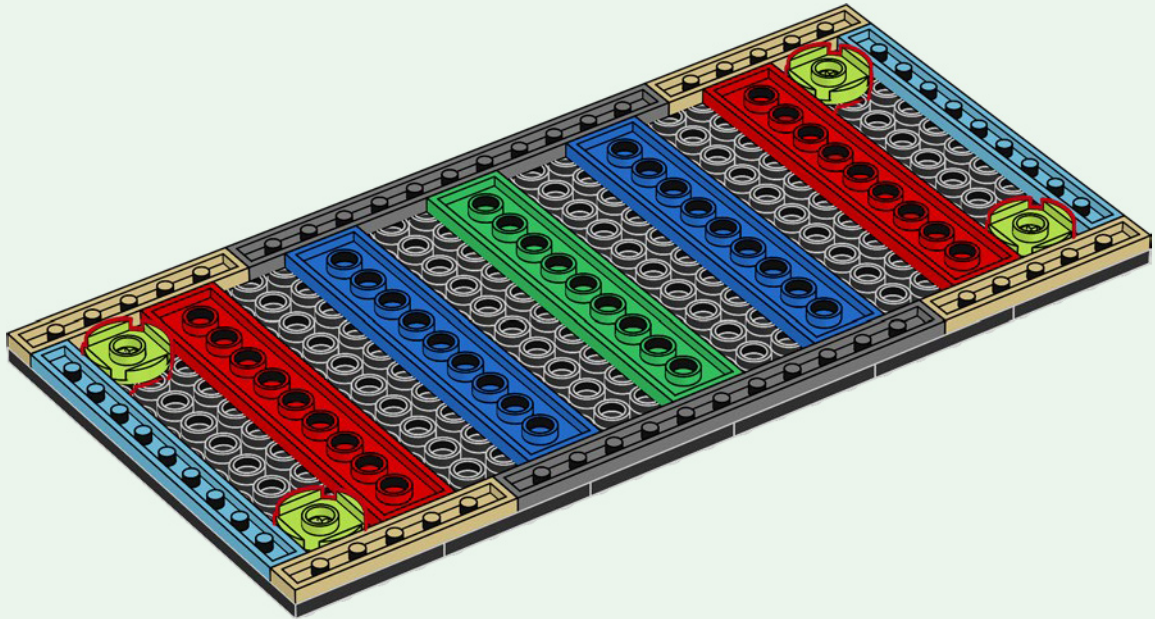

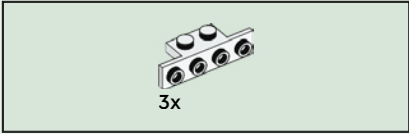

14

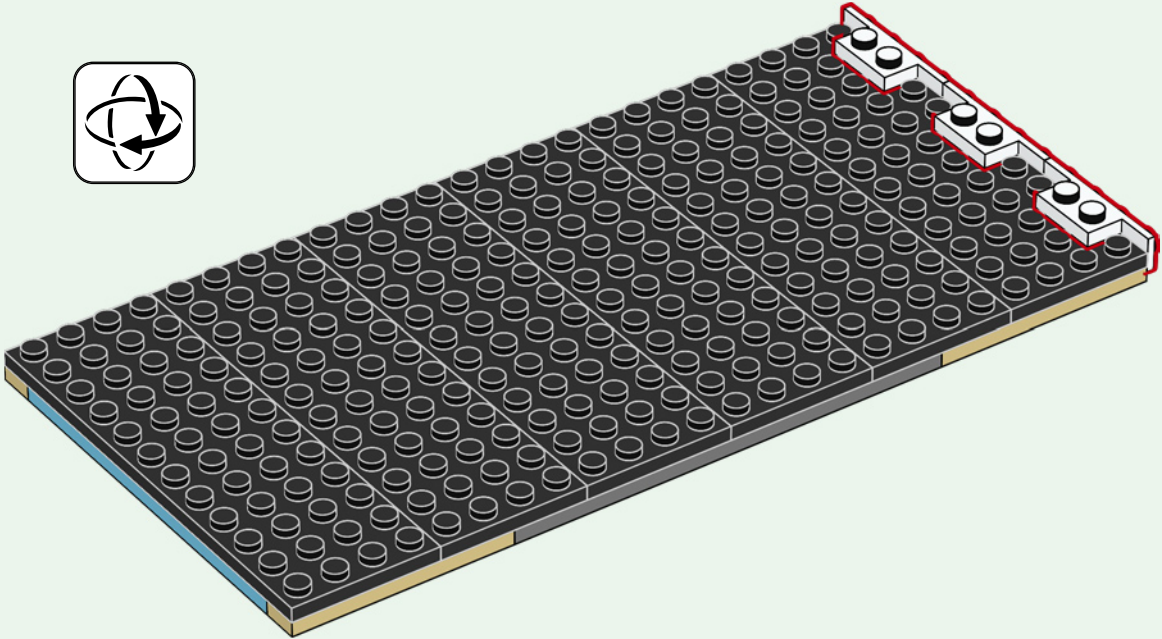

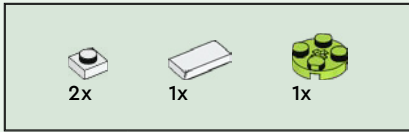

15

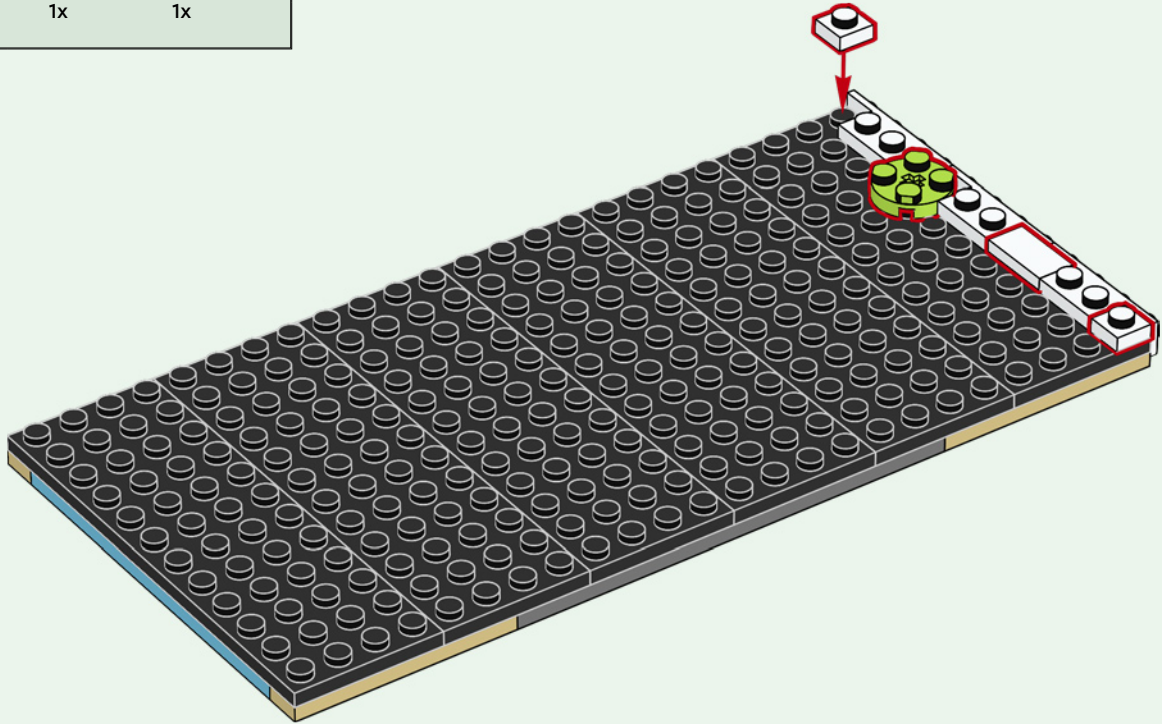

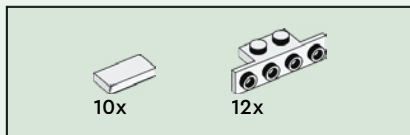

16

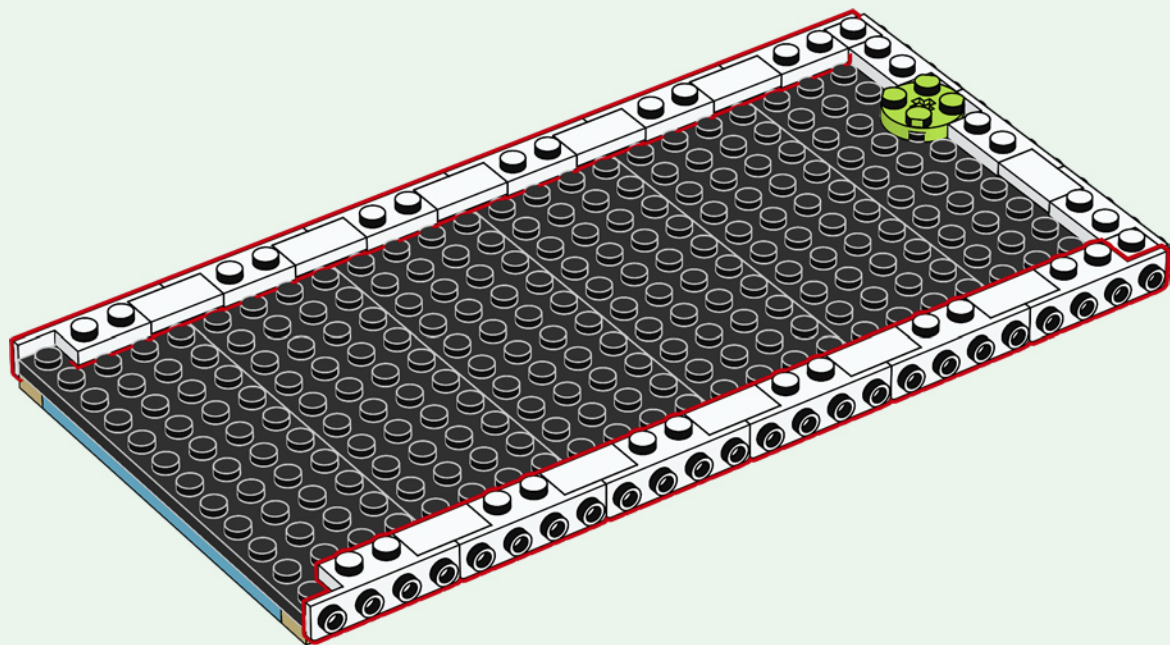

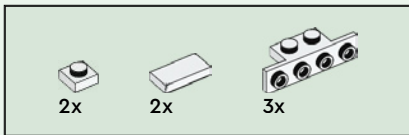

17

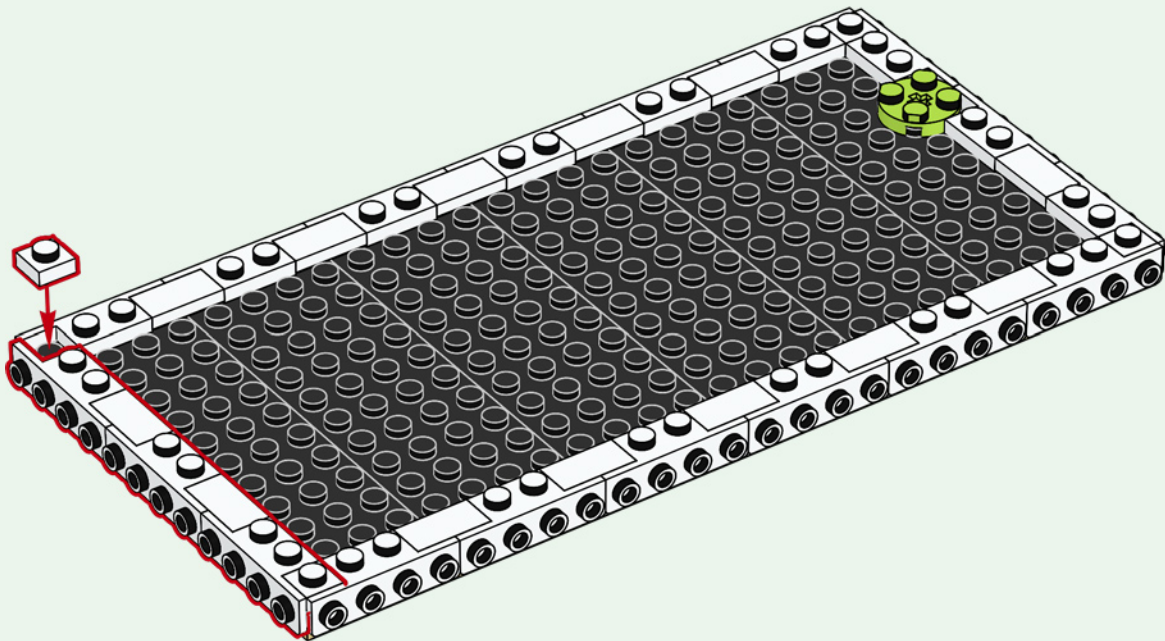

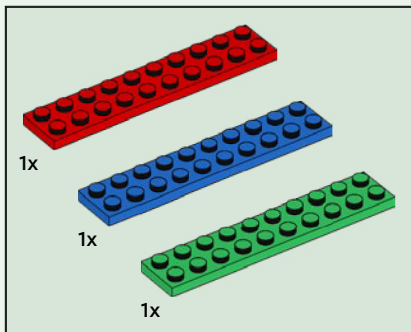

18

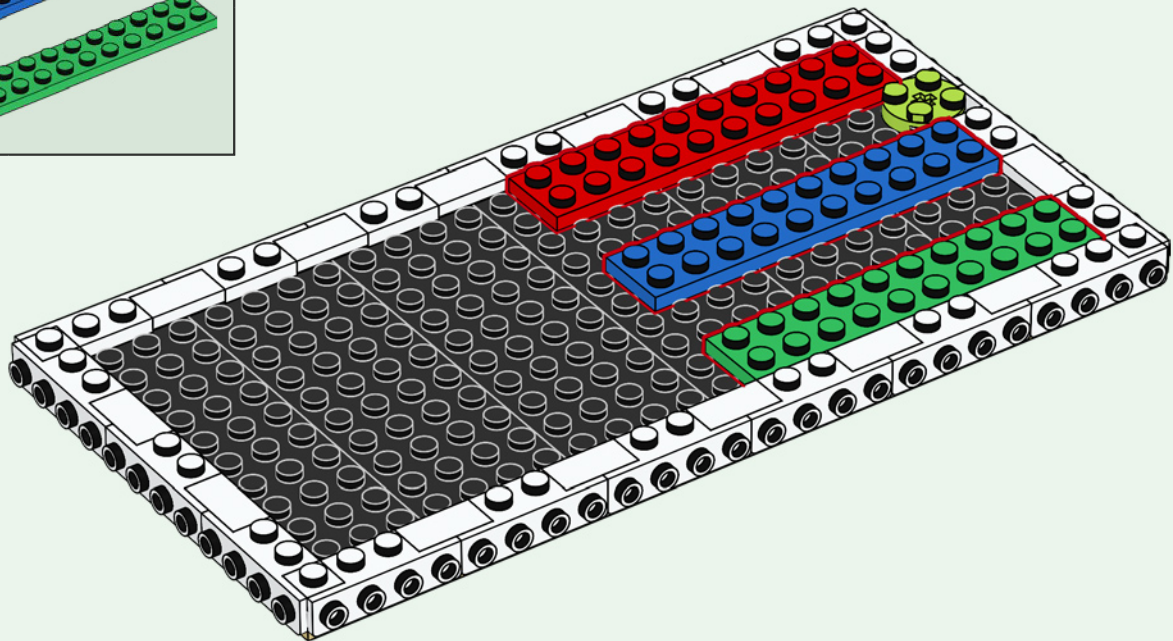



4x



1x

19

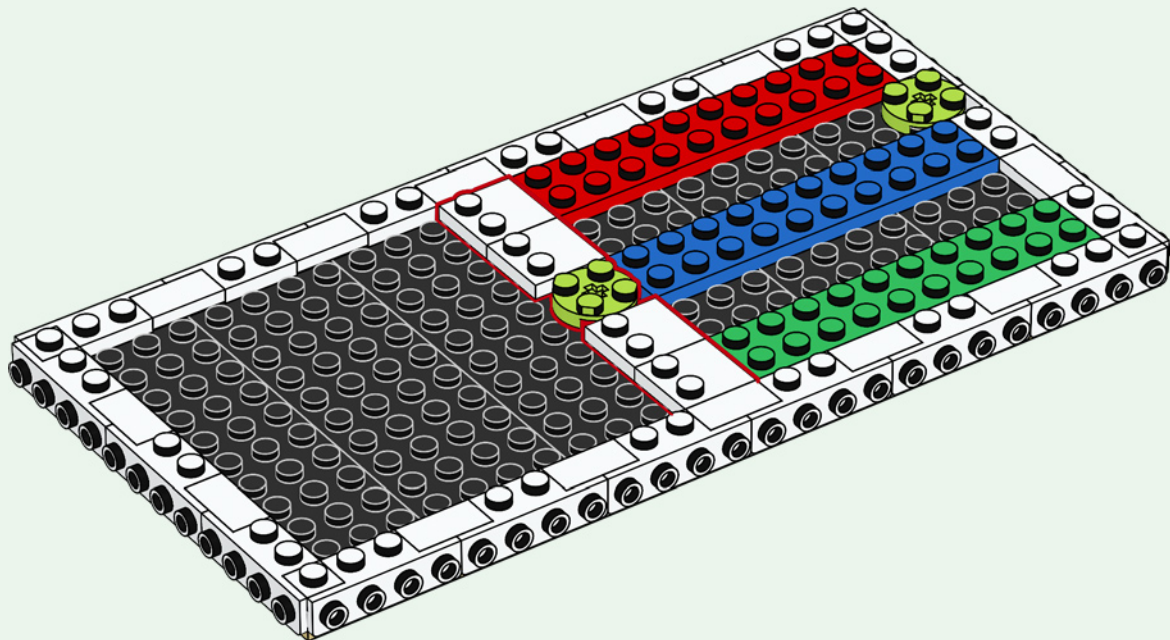

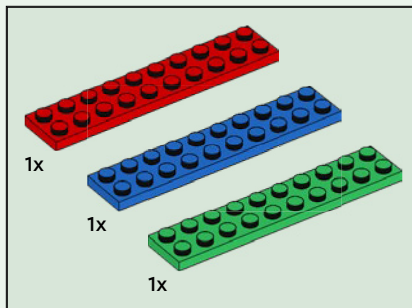

20

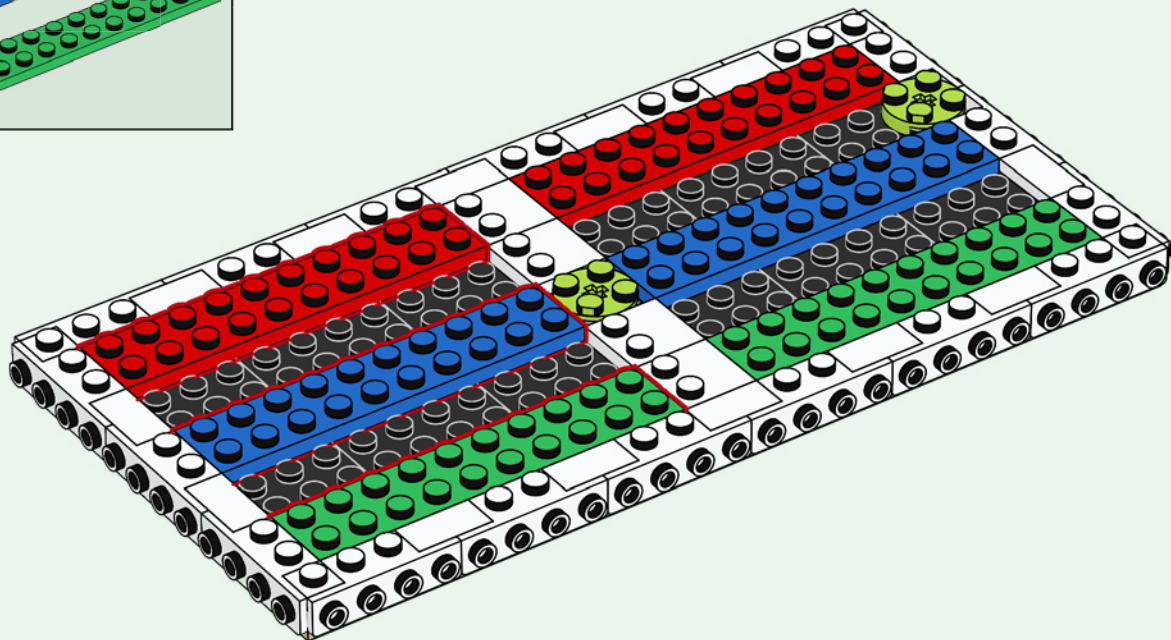





2x

21

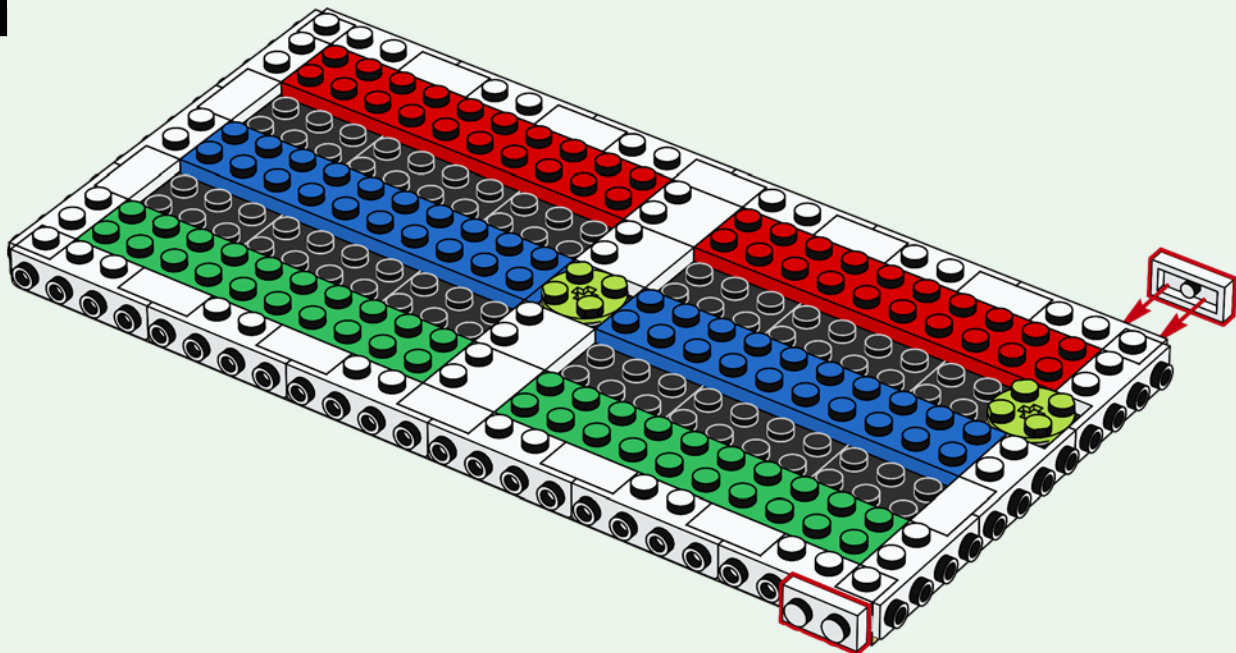



2x



2x

22

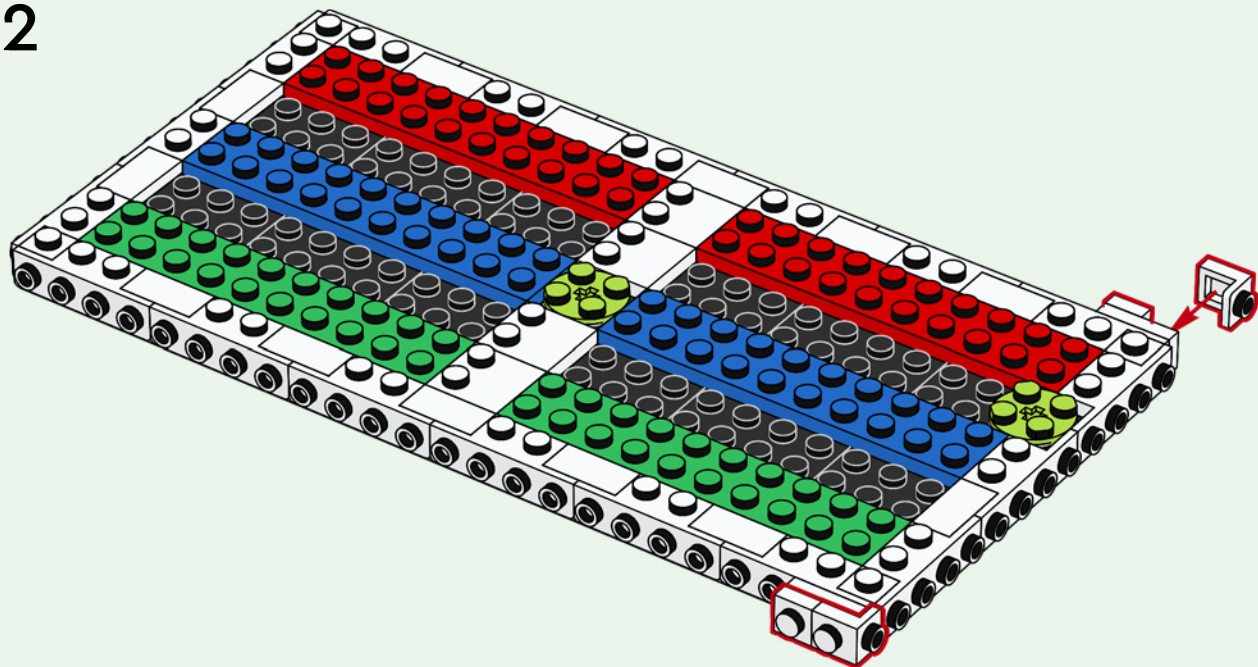



2x

23

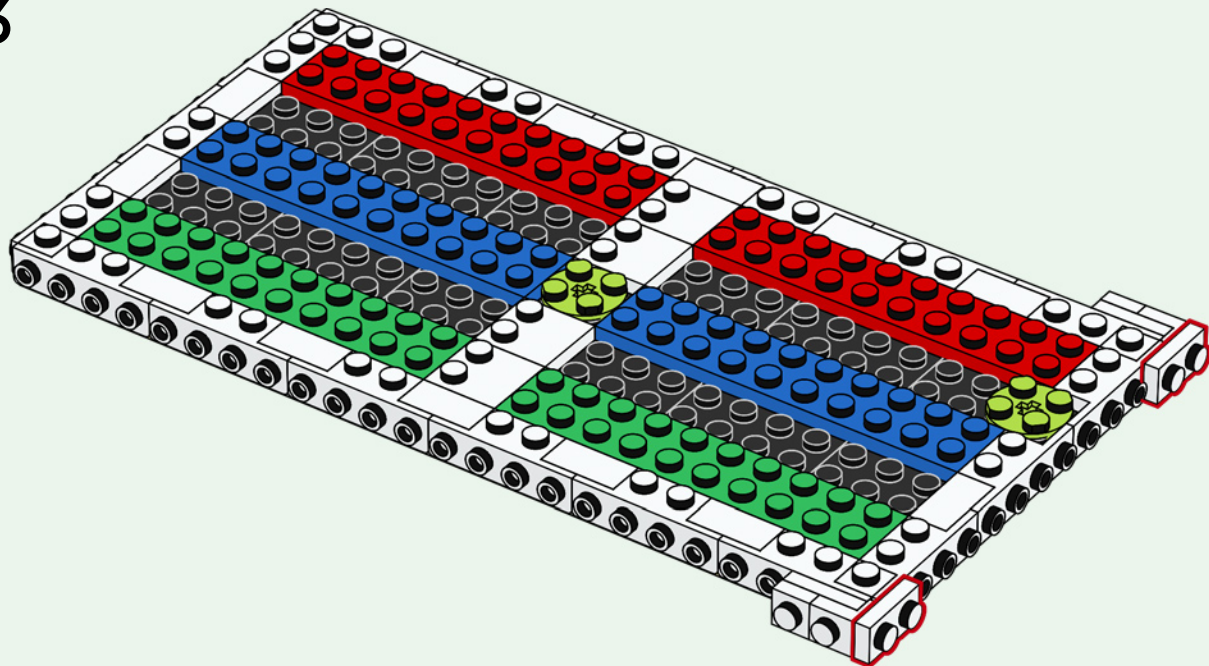

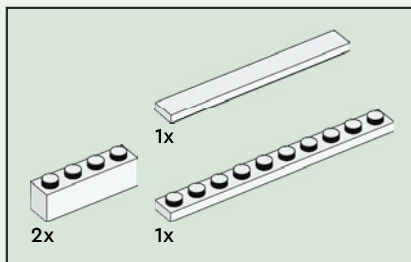

24

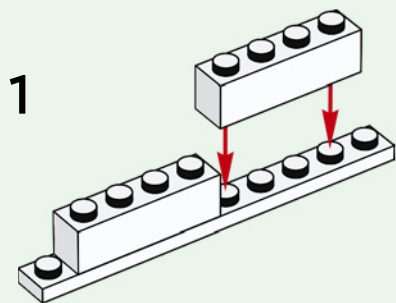

2

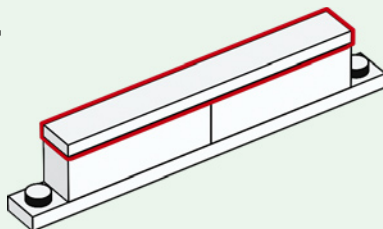

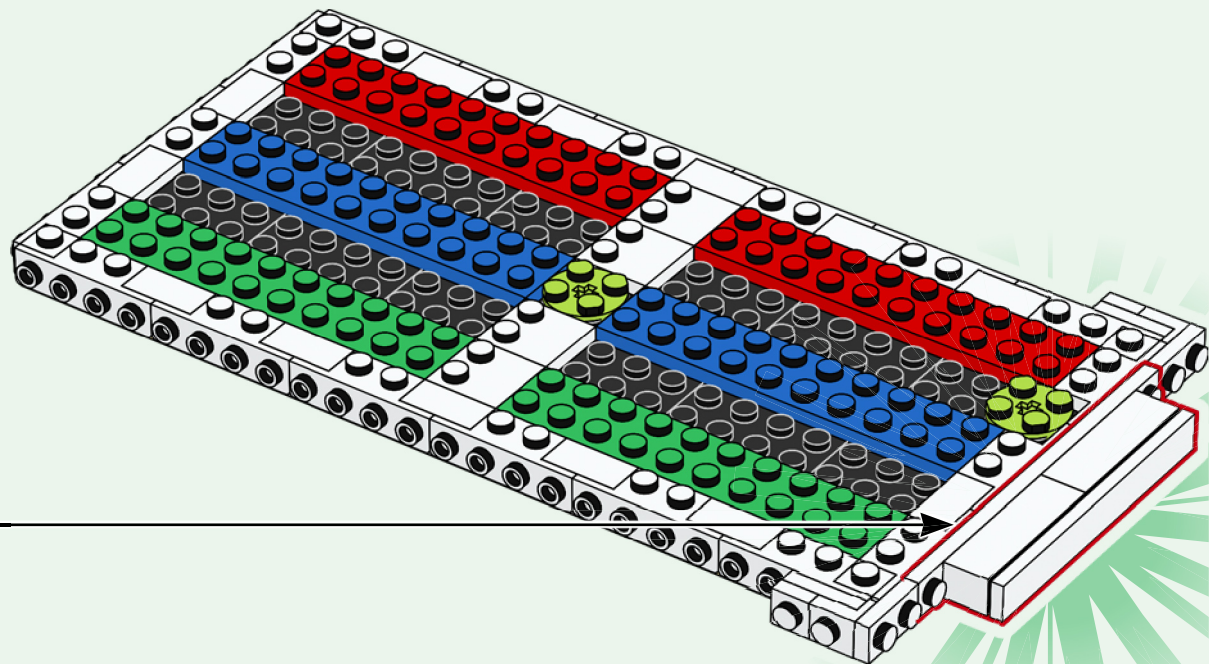

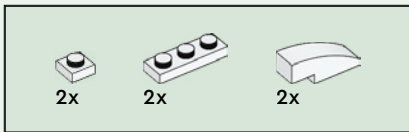

25

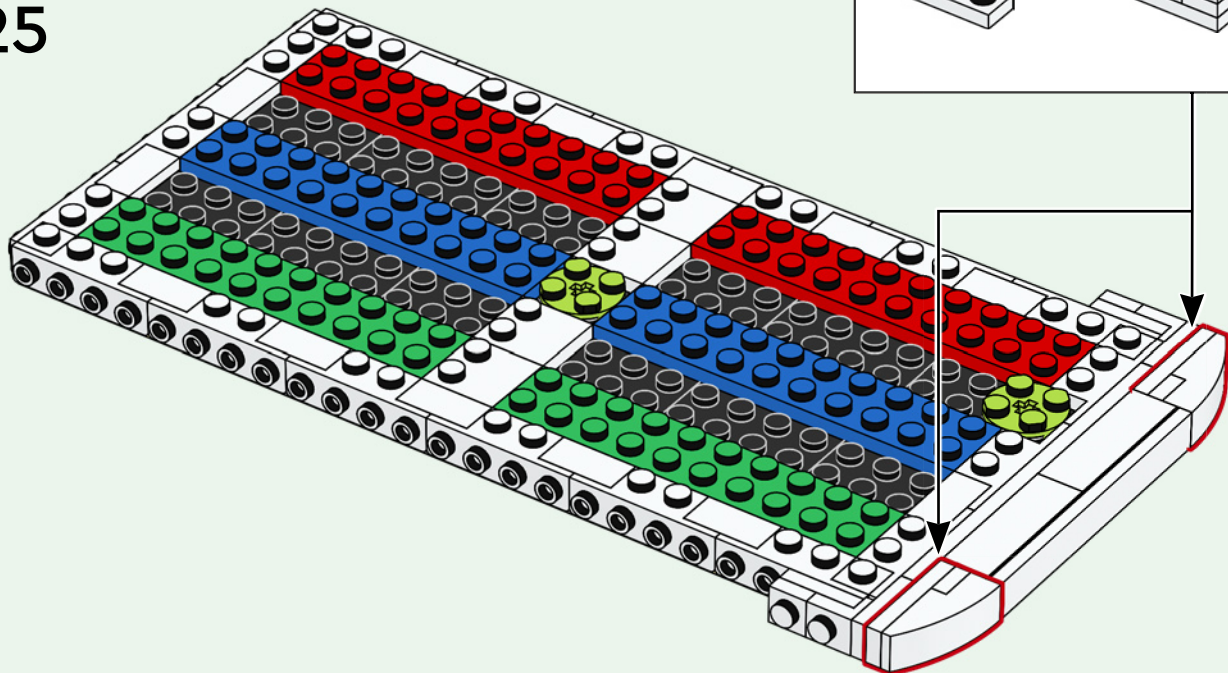
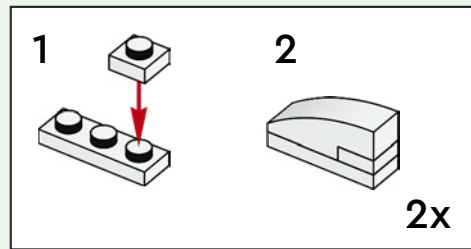

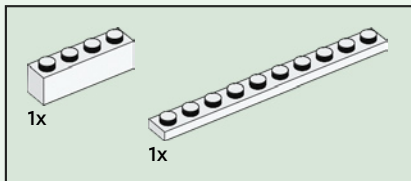
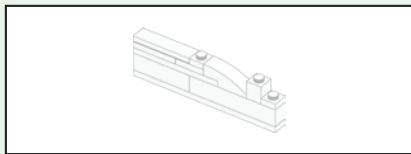

26

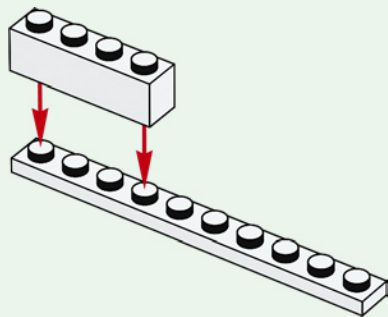

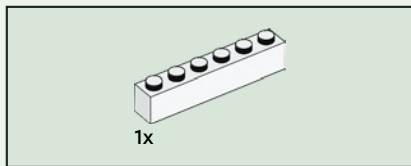

27

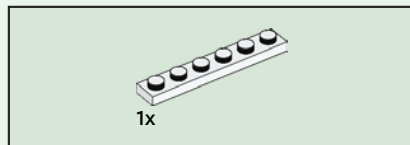
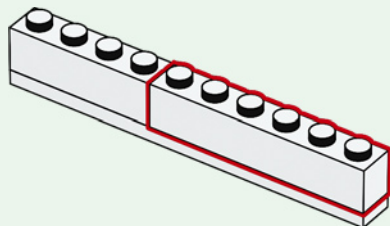

28

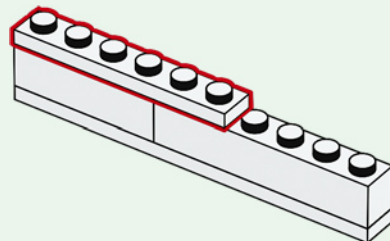

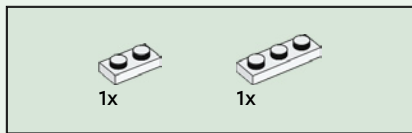

29

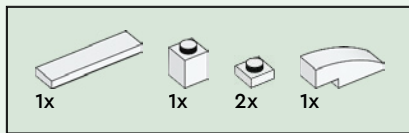
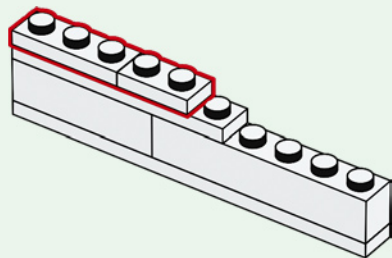

30

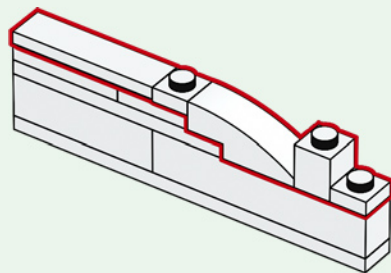

31

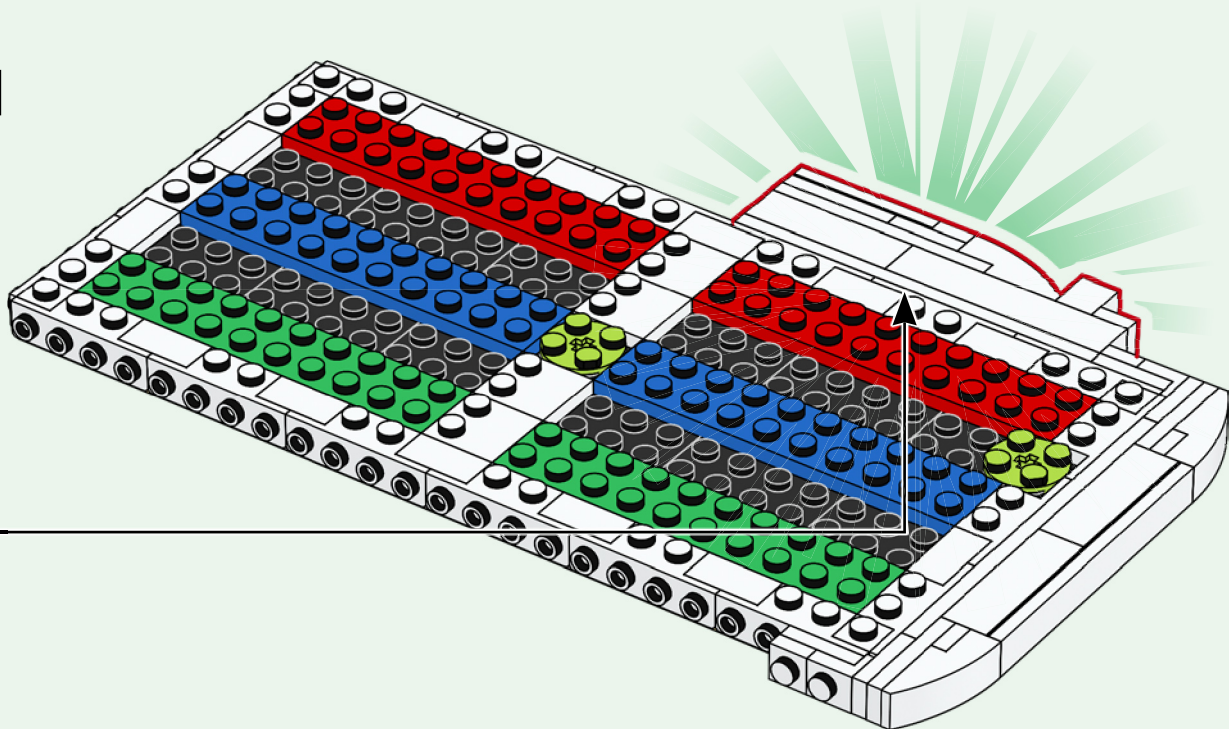

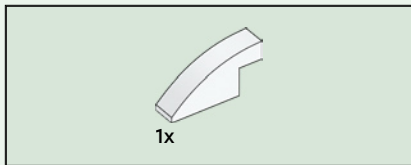

32

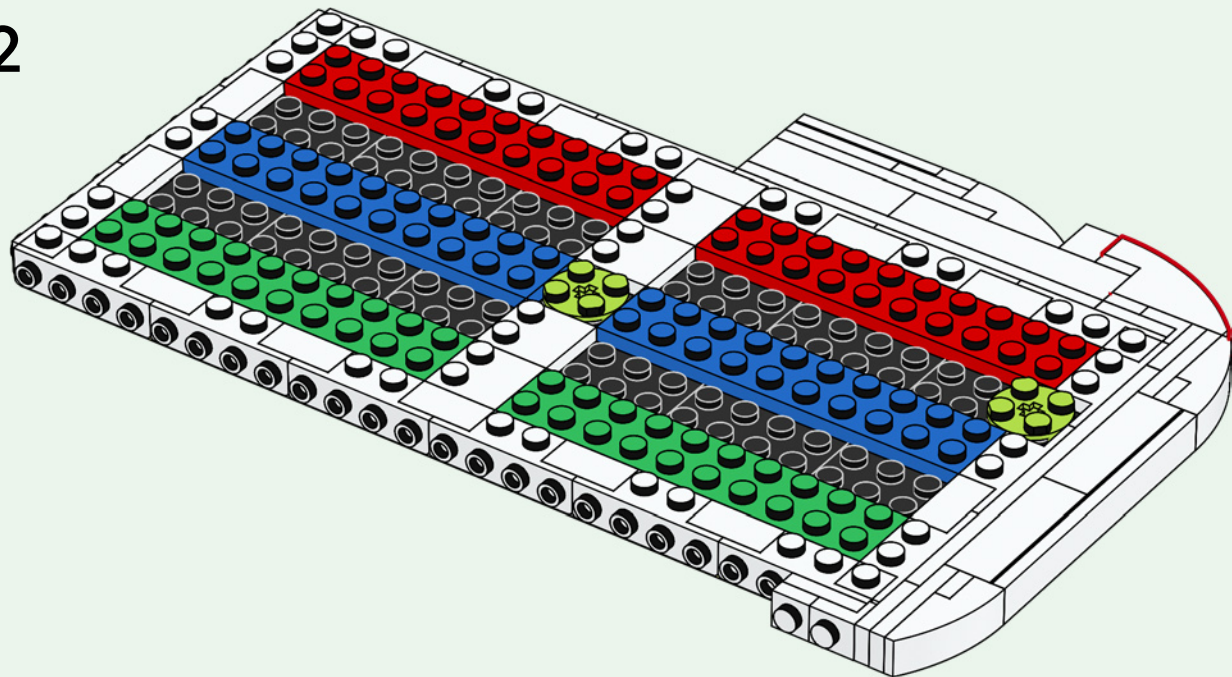

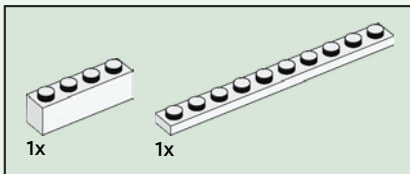
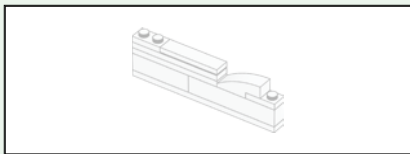

33

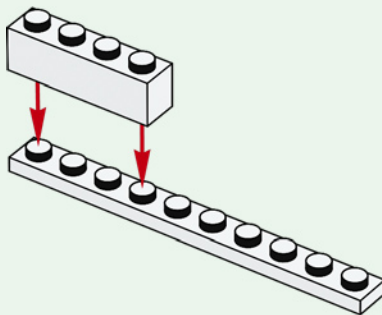

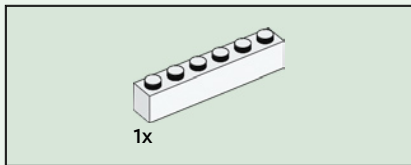

34

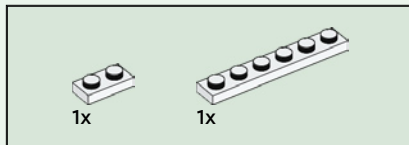
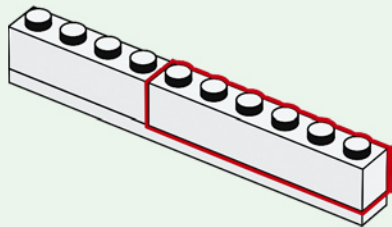

35

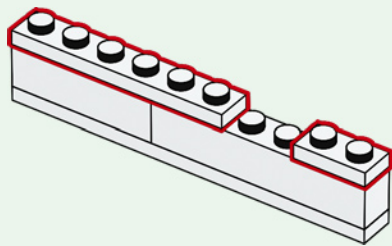

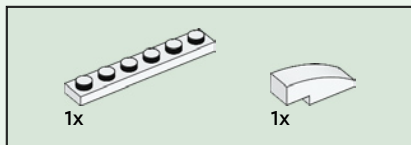

36

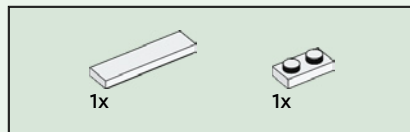
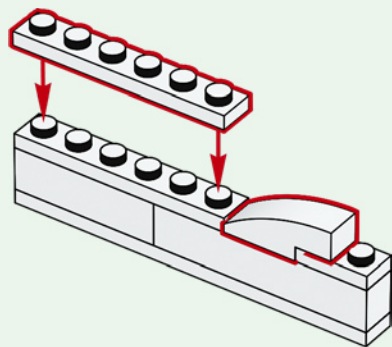

37

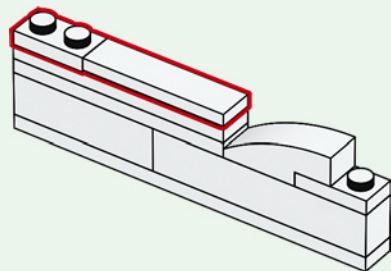

38

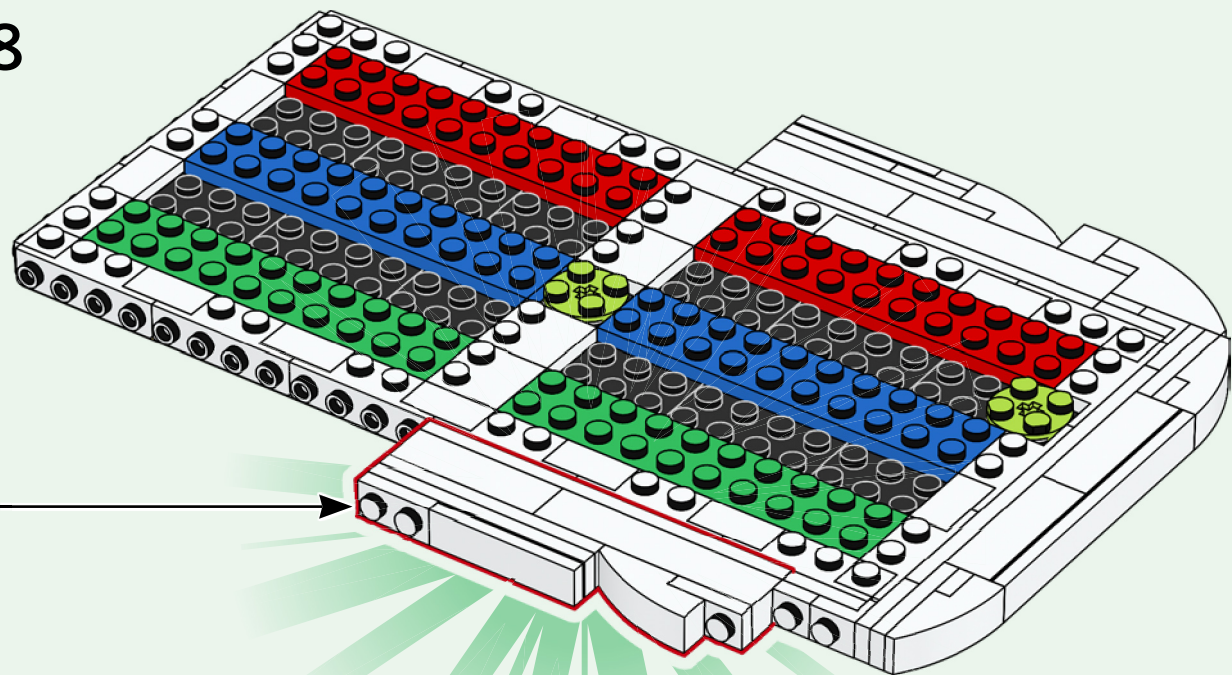

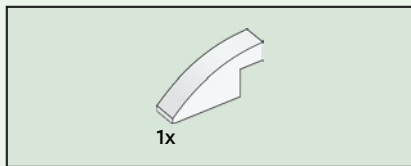

39

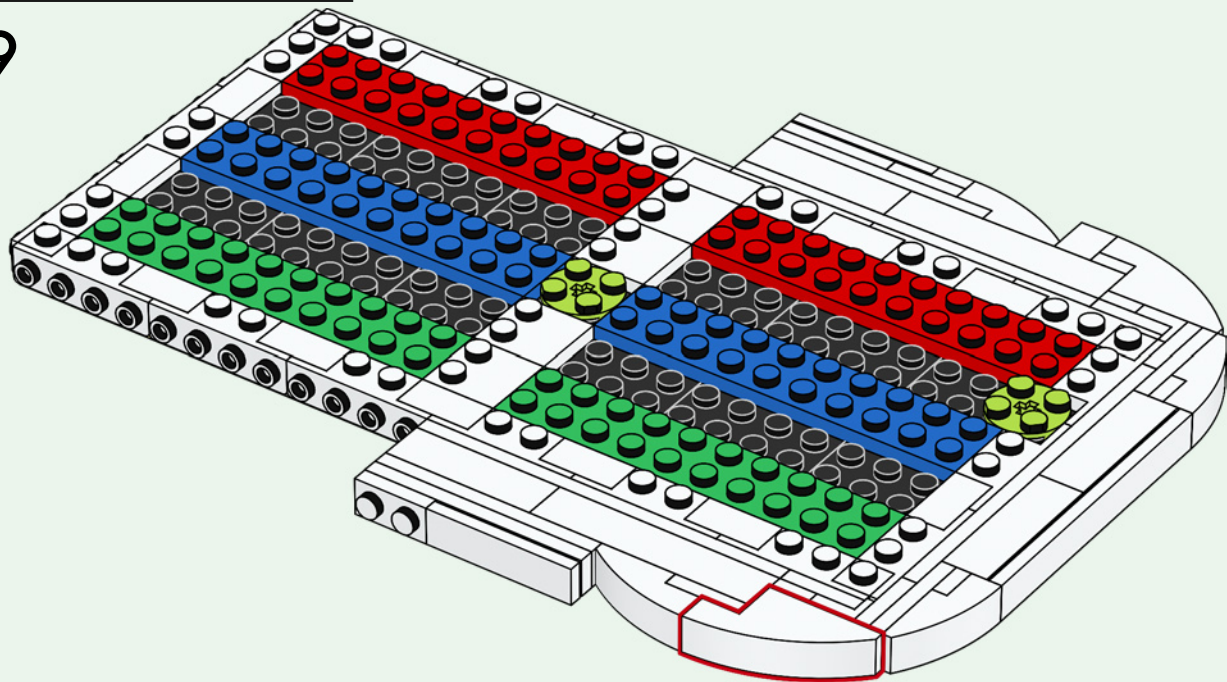

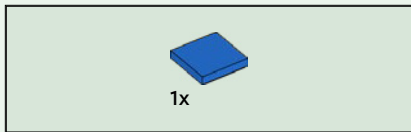

40

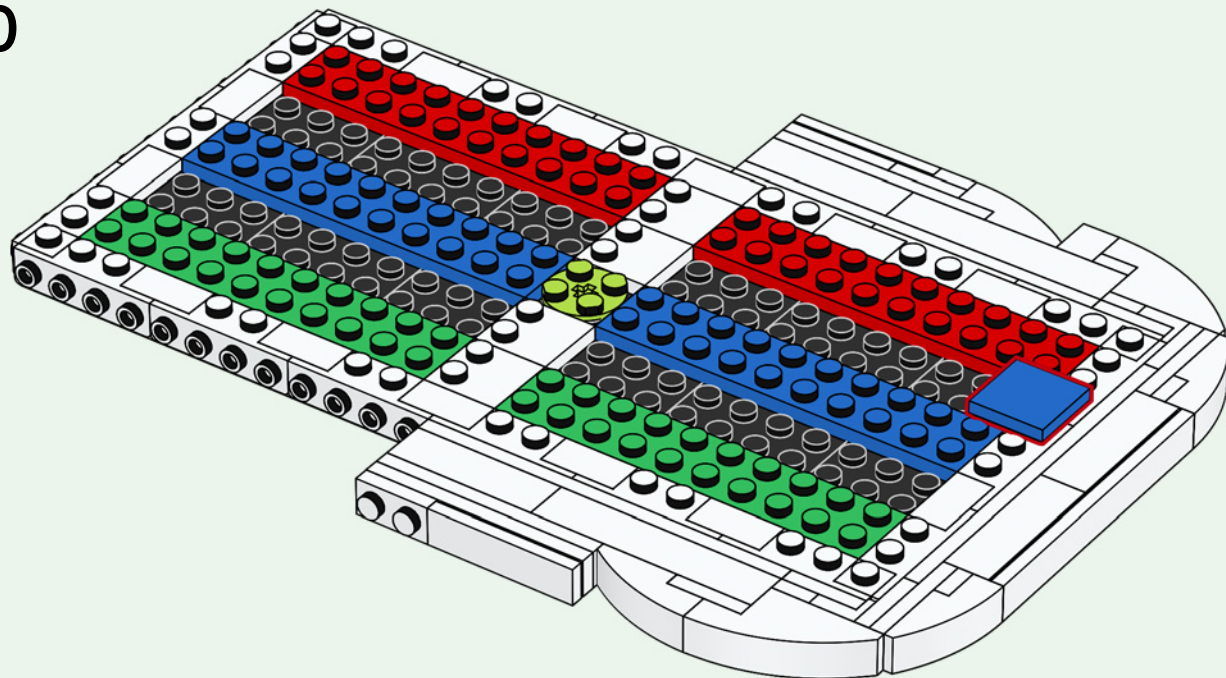

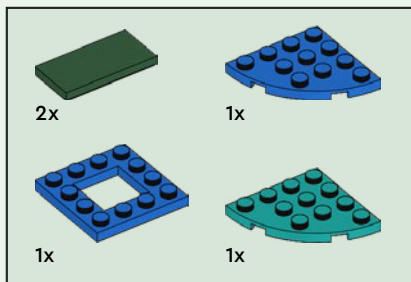

41

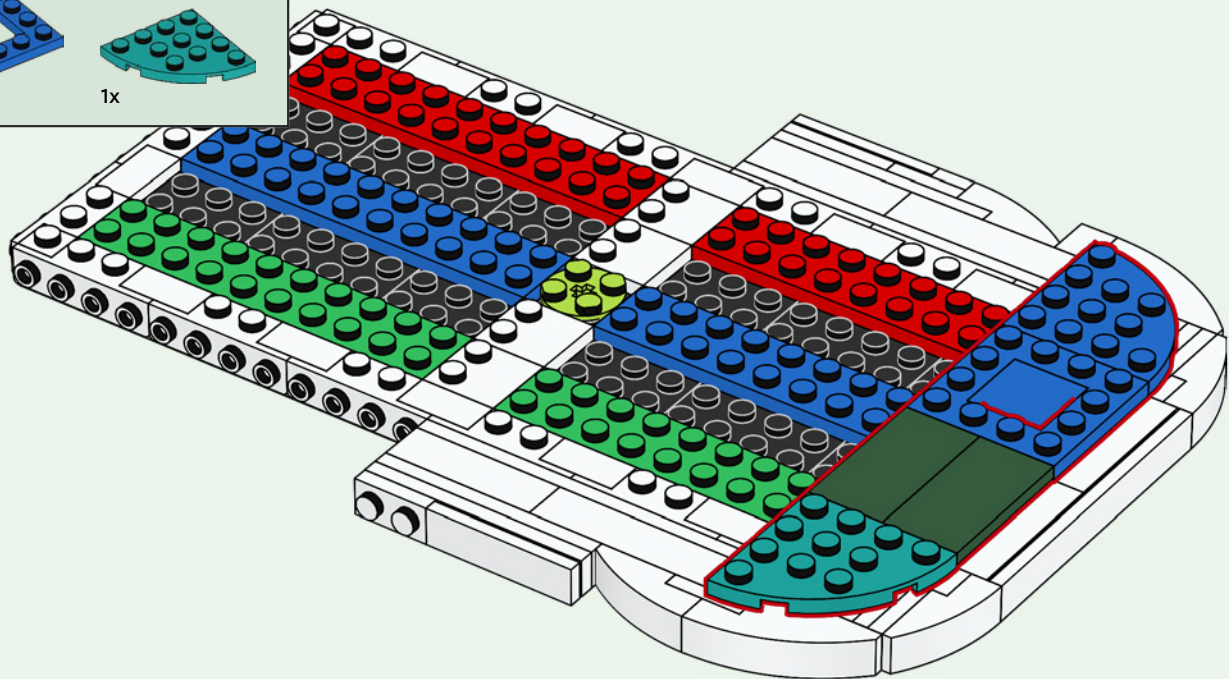

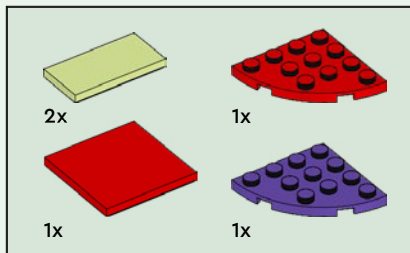

42

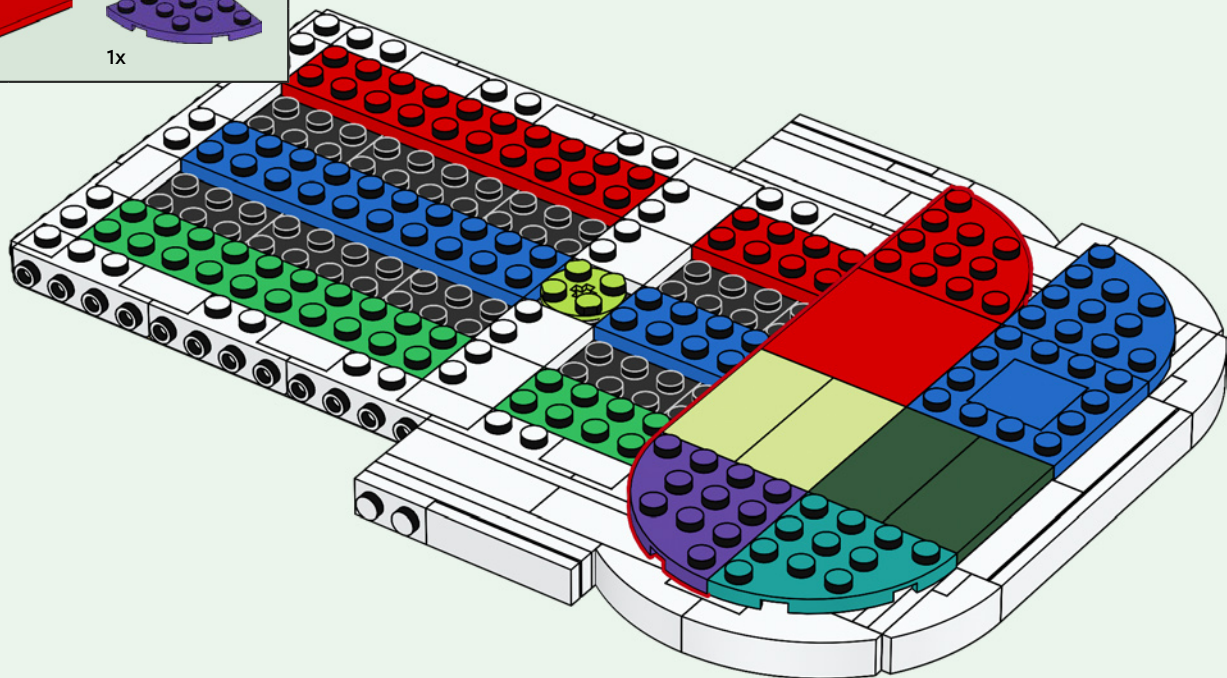





2x

44

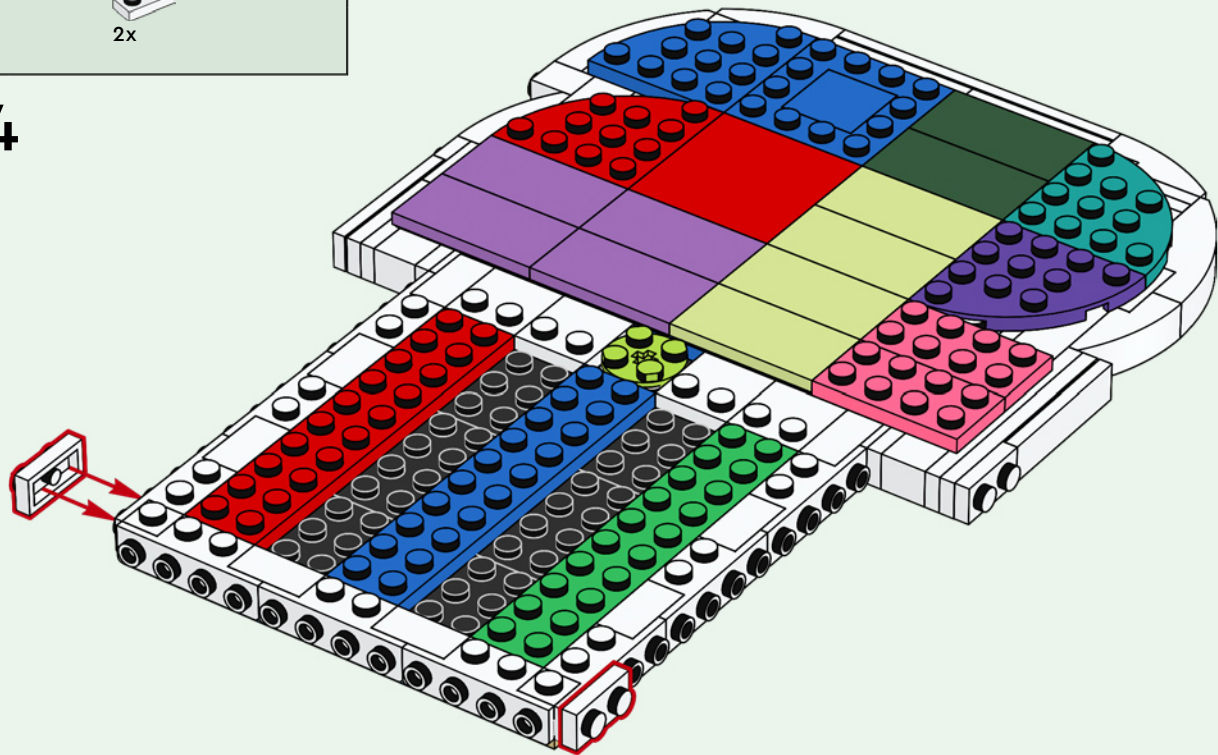



2x



2x

45

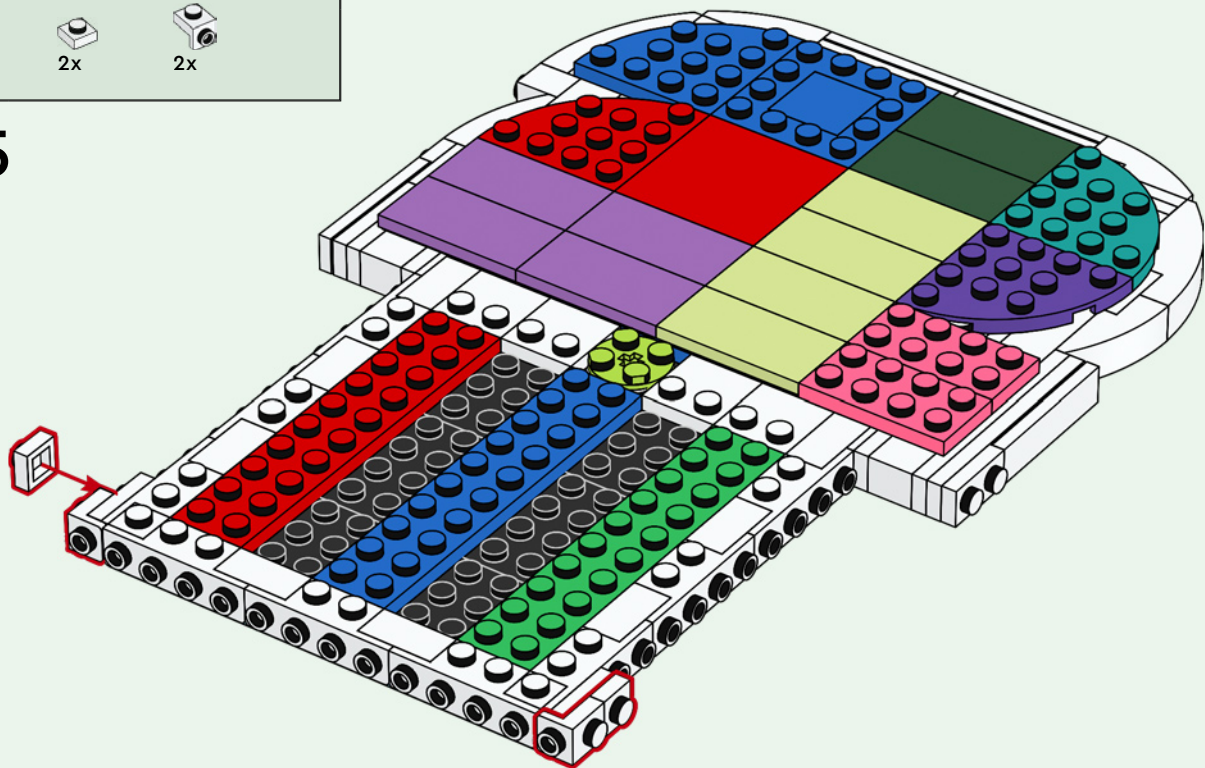

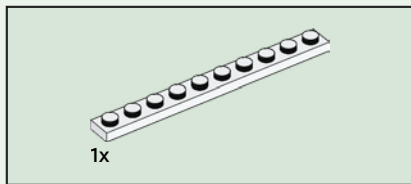

46

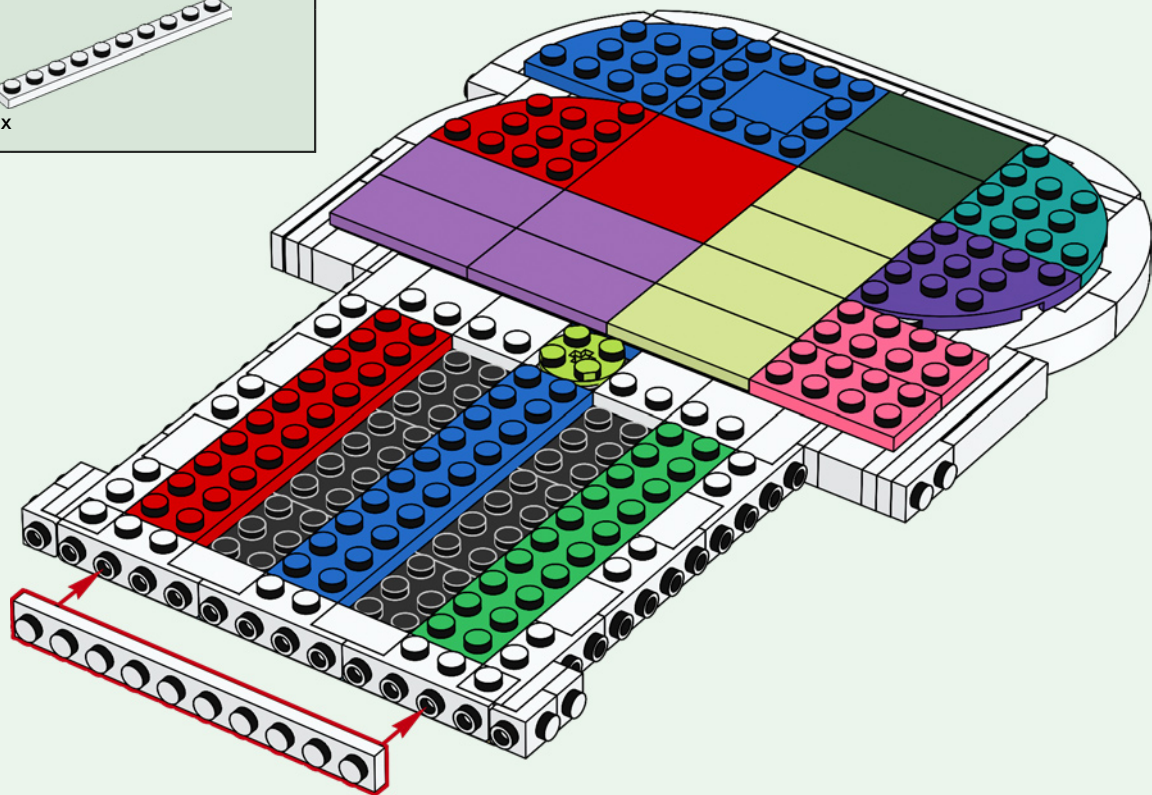



2x

47

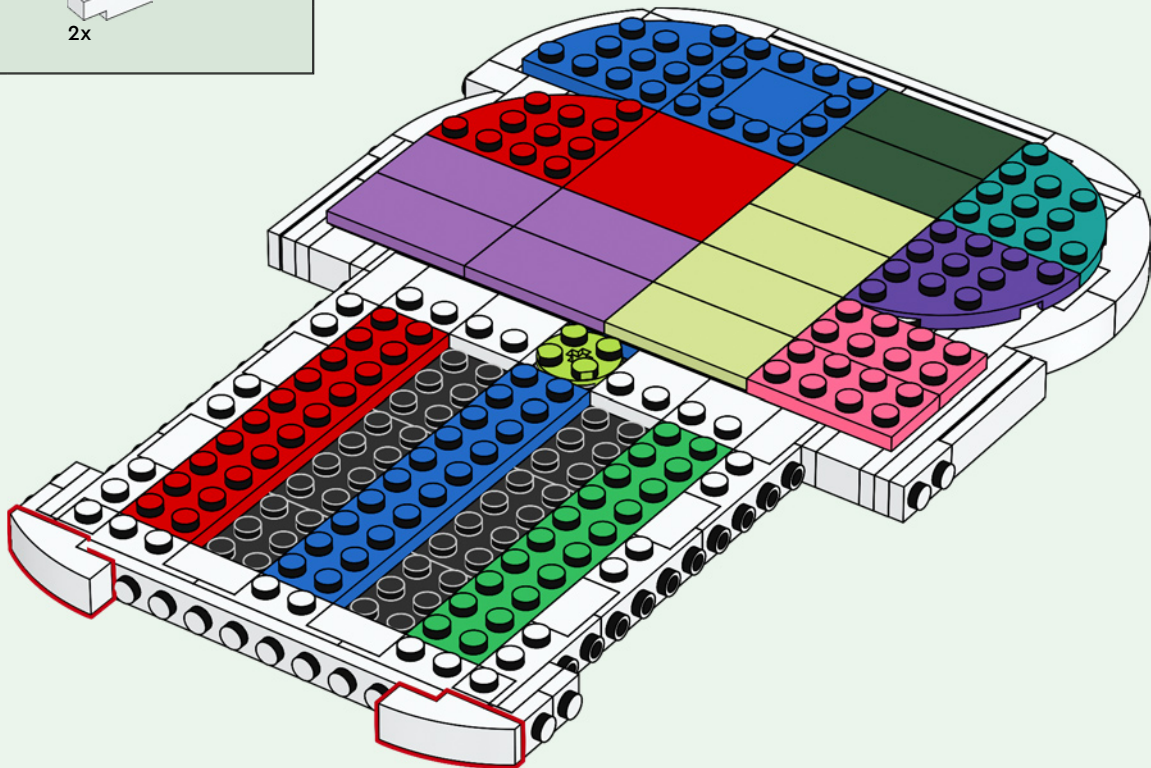

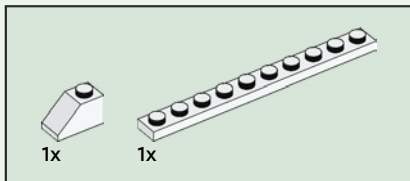
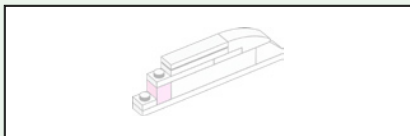

48

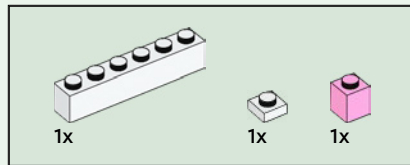
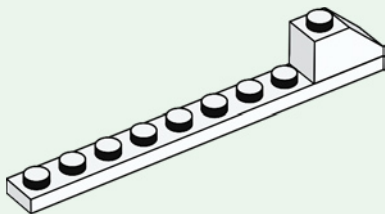

49

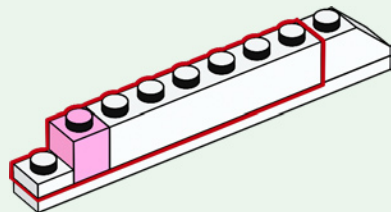

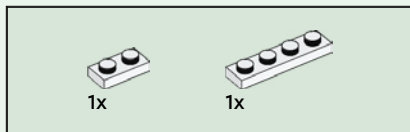

50

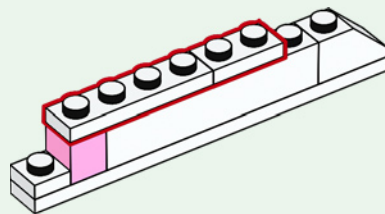

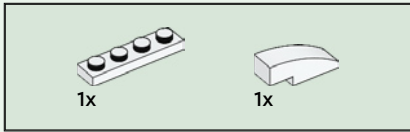

51

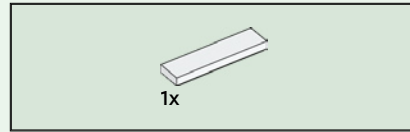
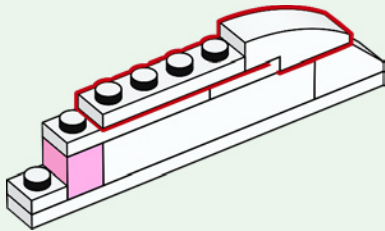

52

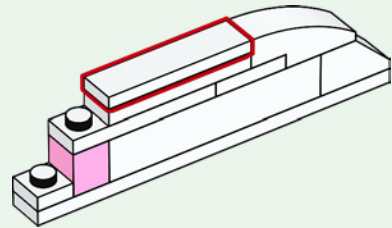

53

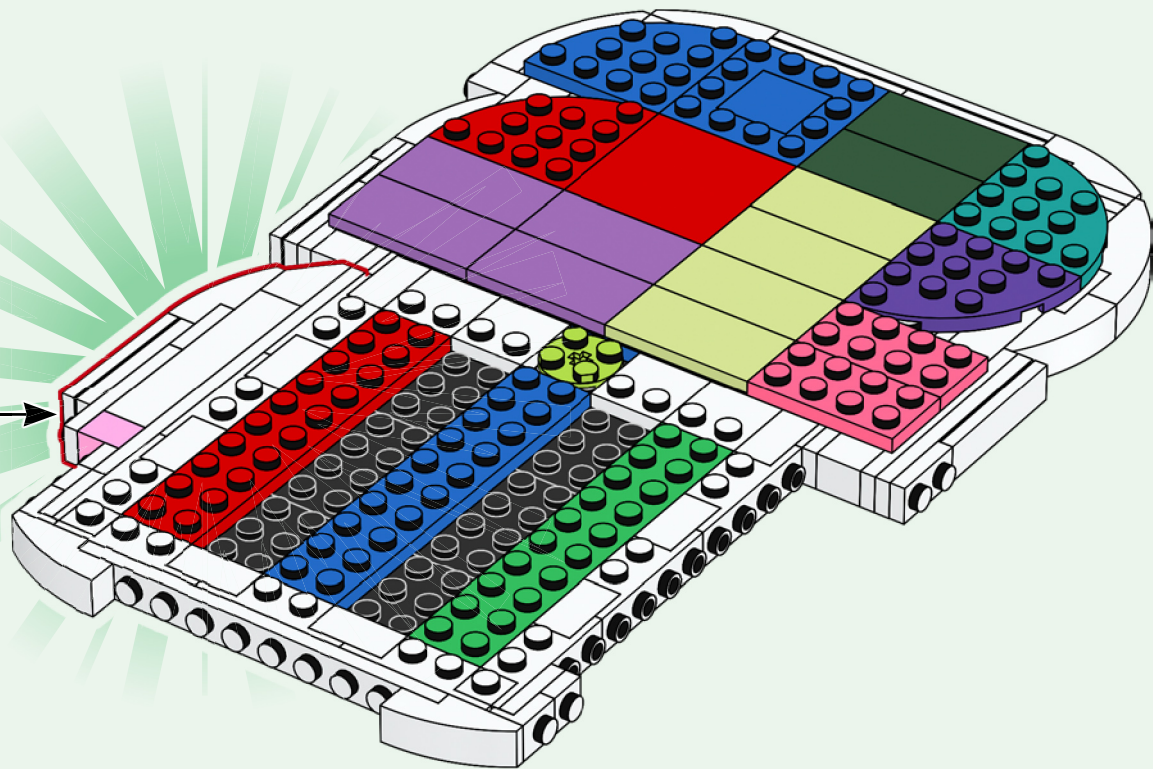

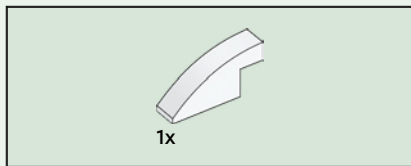

54

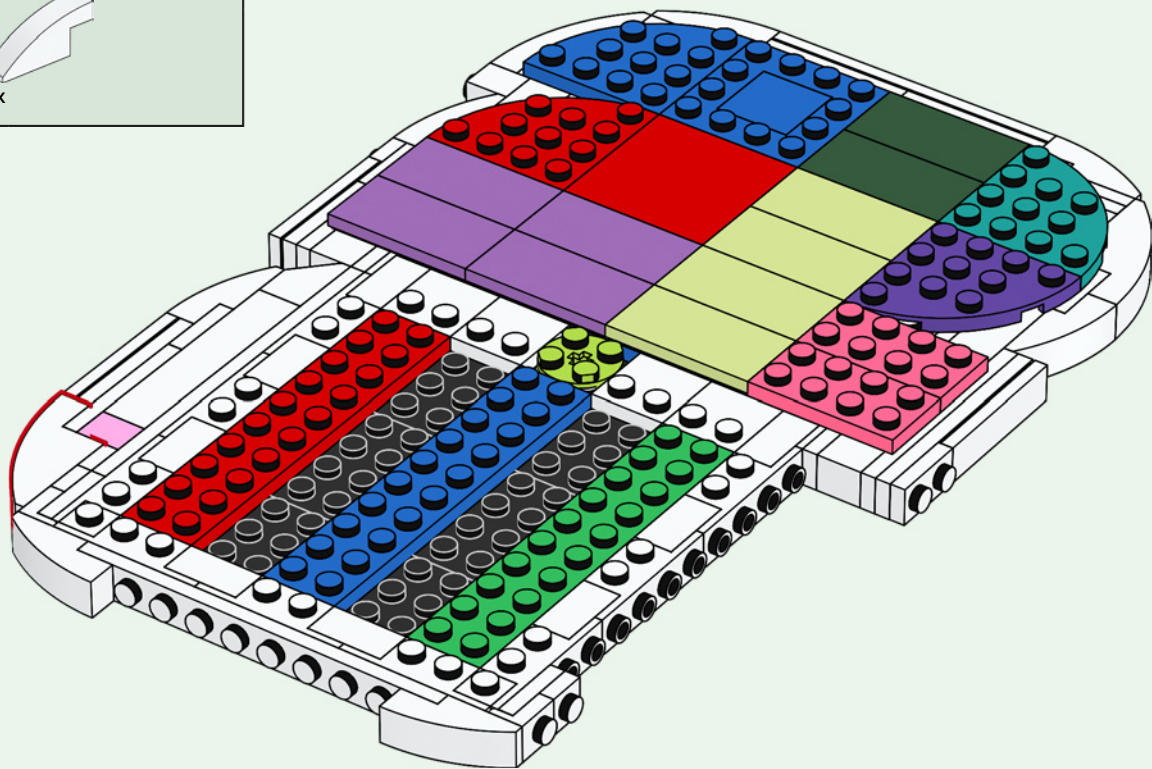

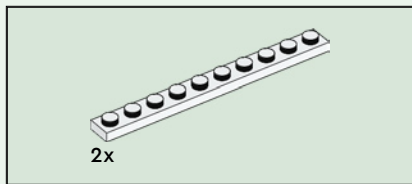

55

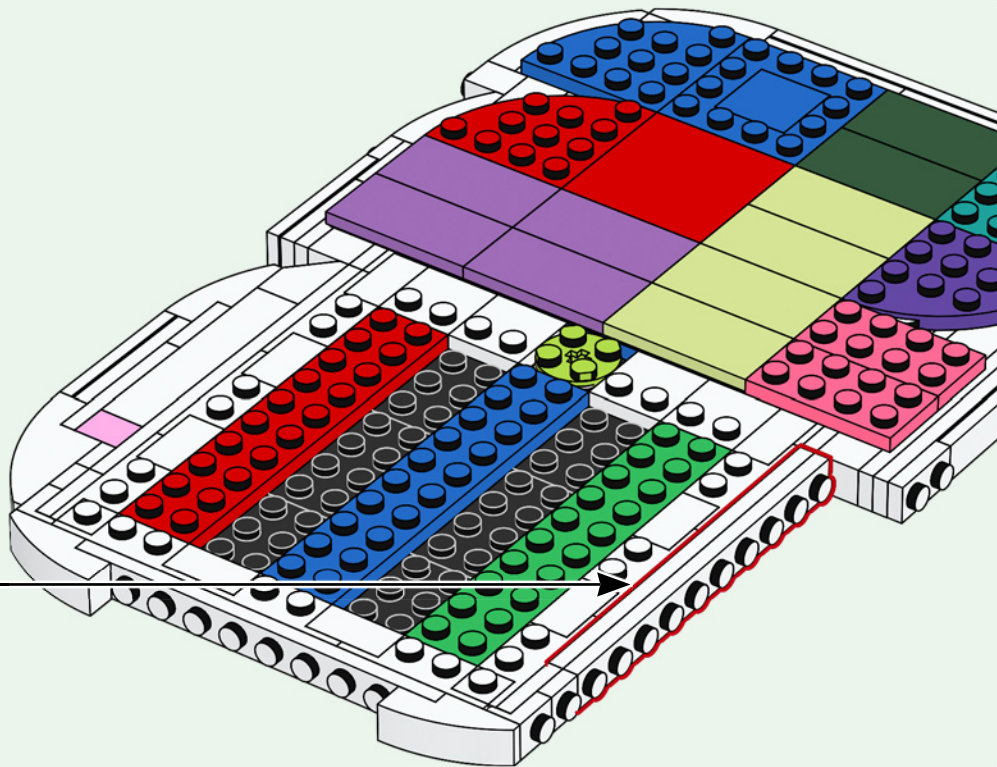
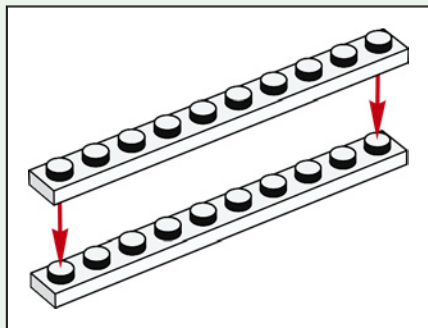

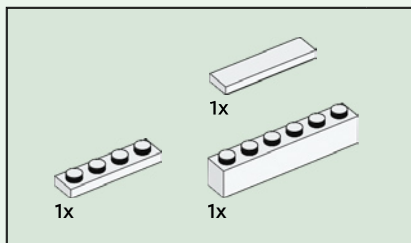

56

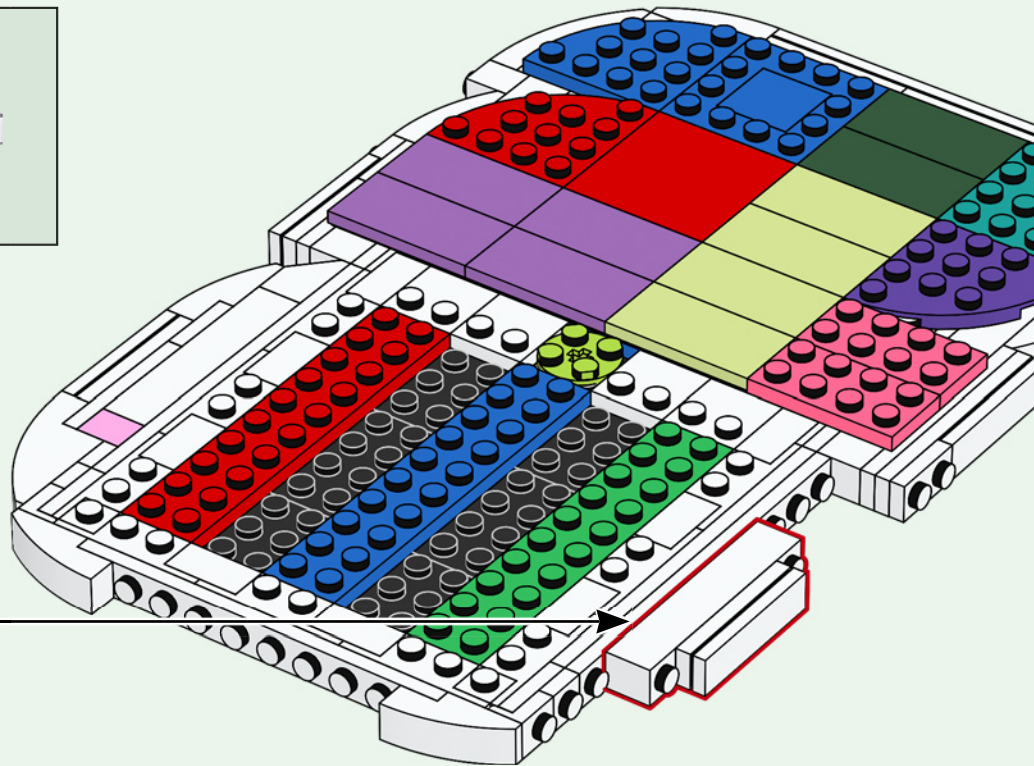
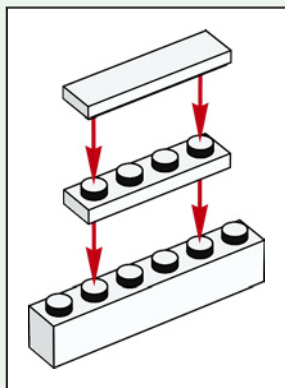

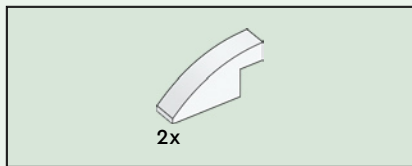

57

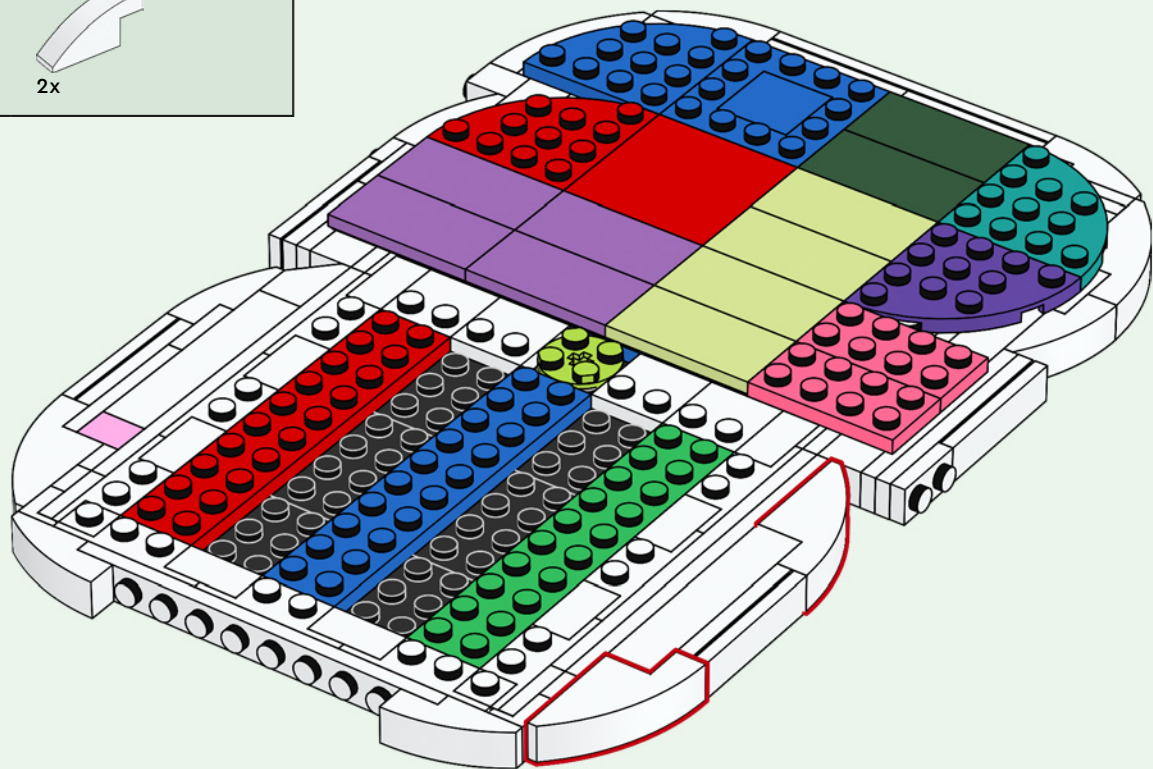

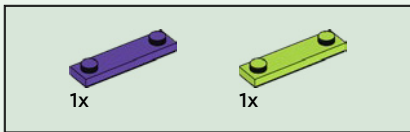

58

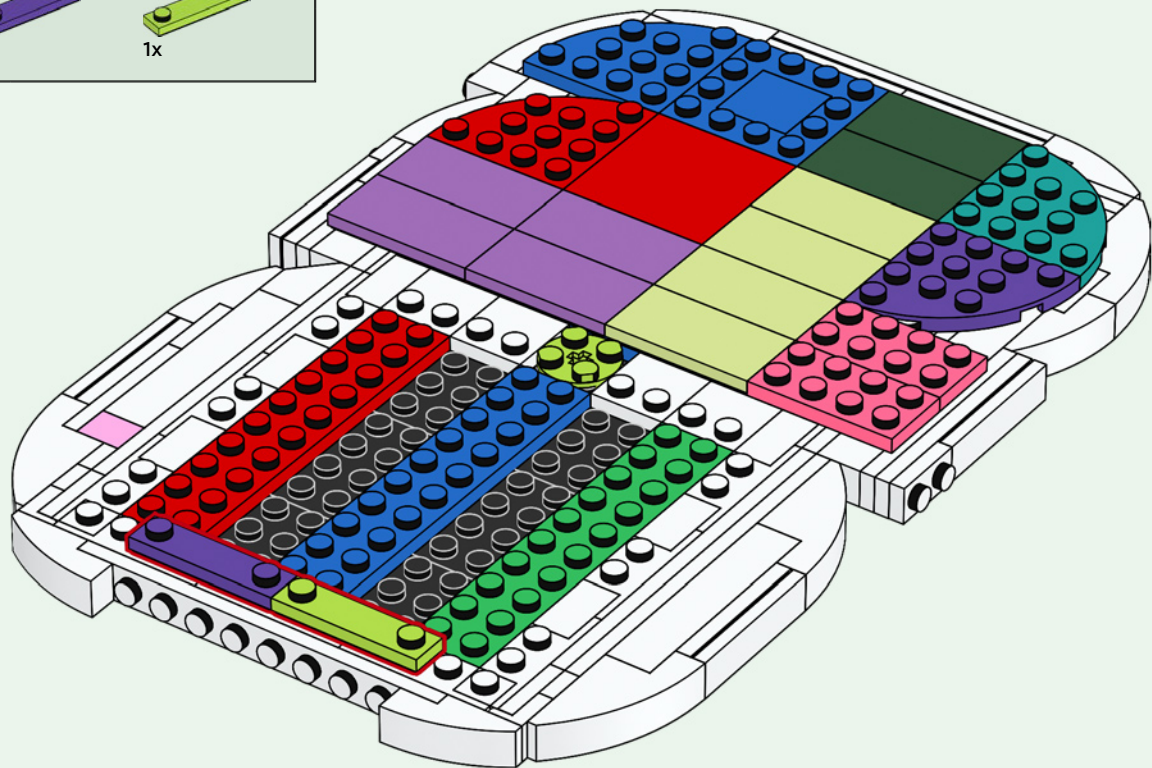

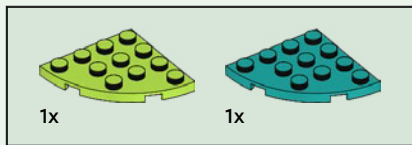

59

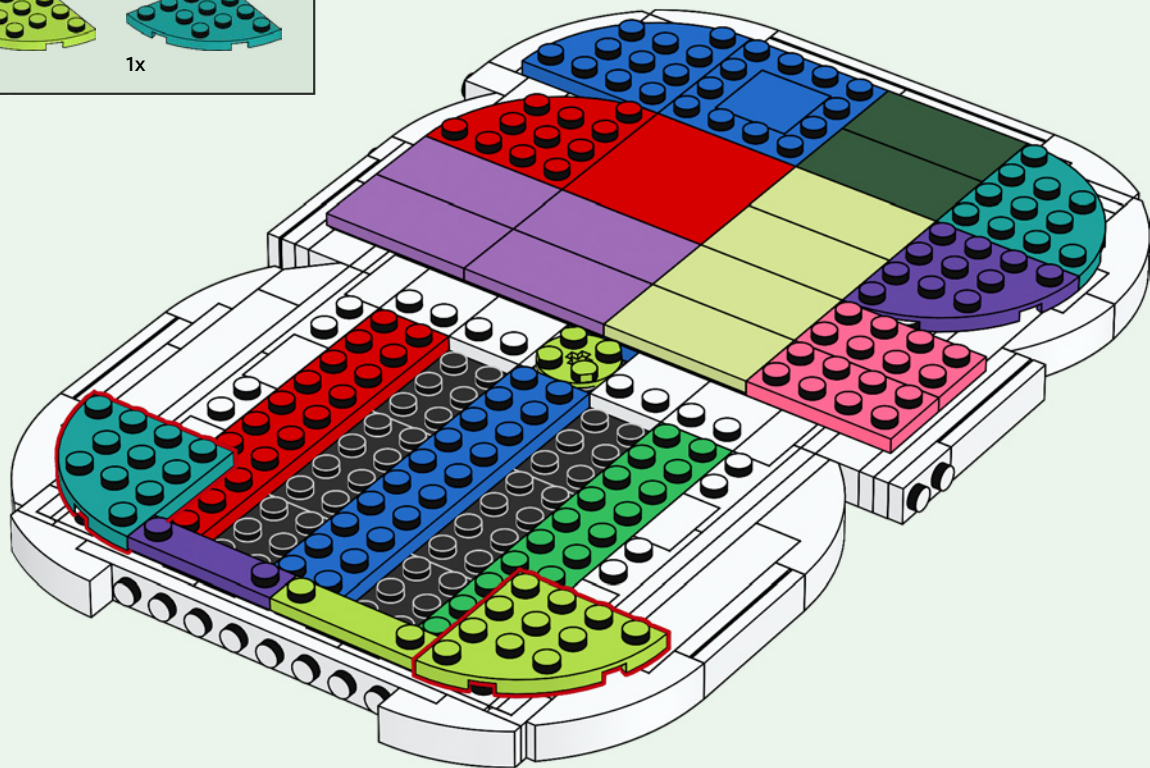

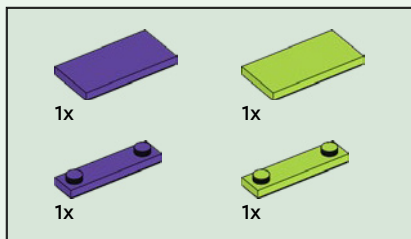

60

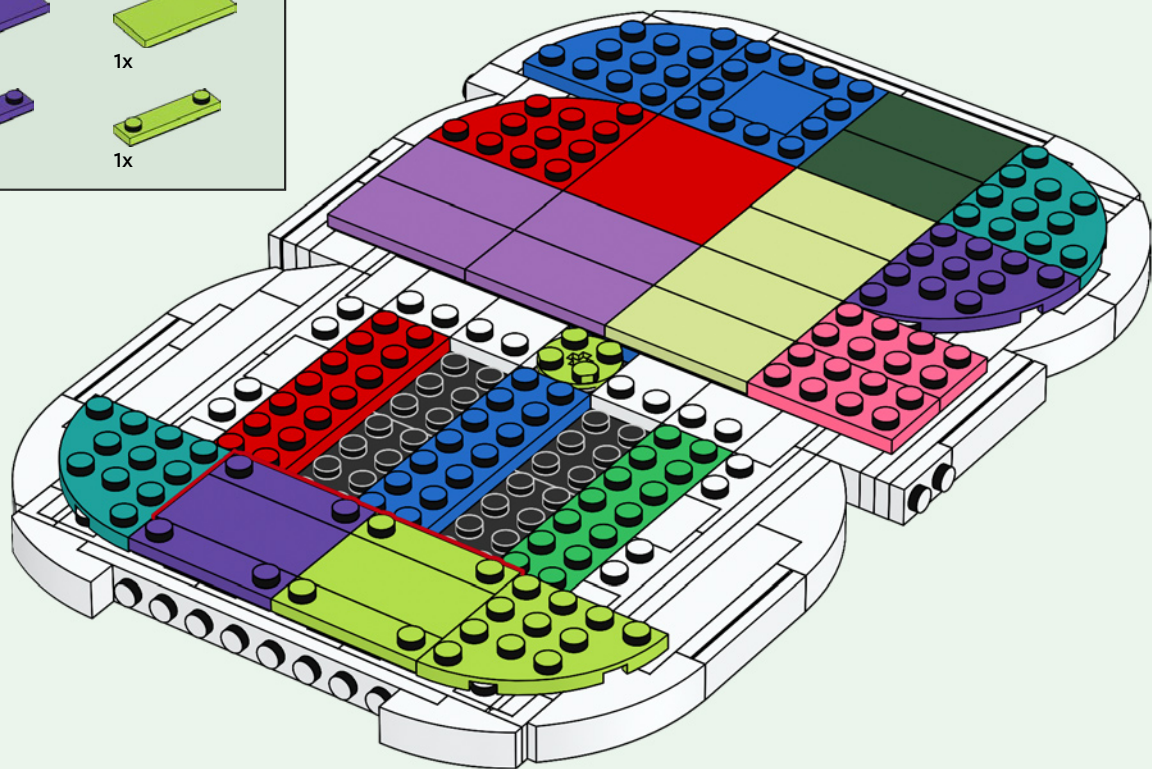

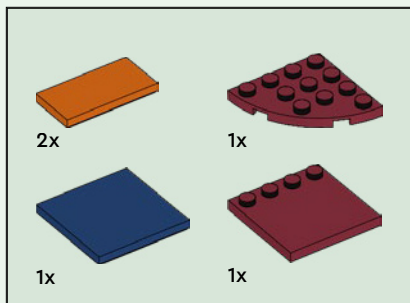

61

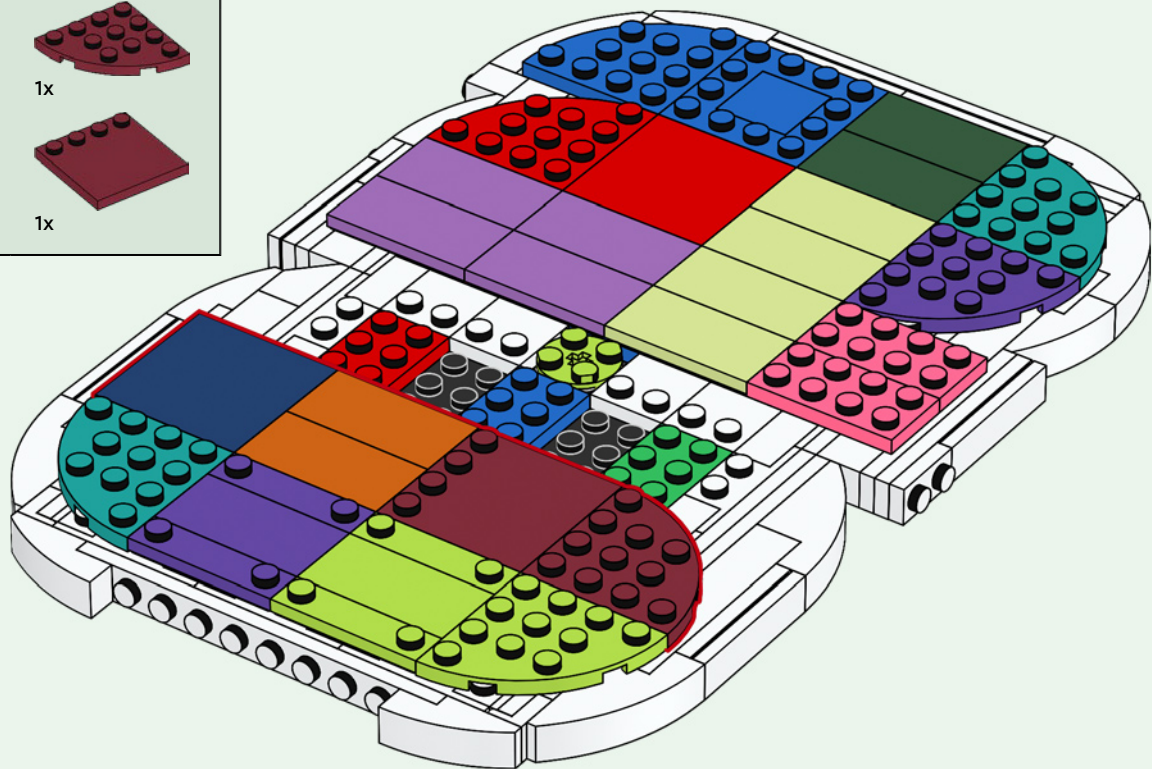

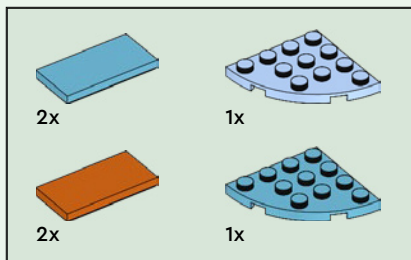

62

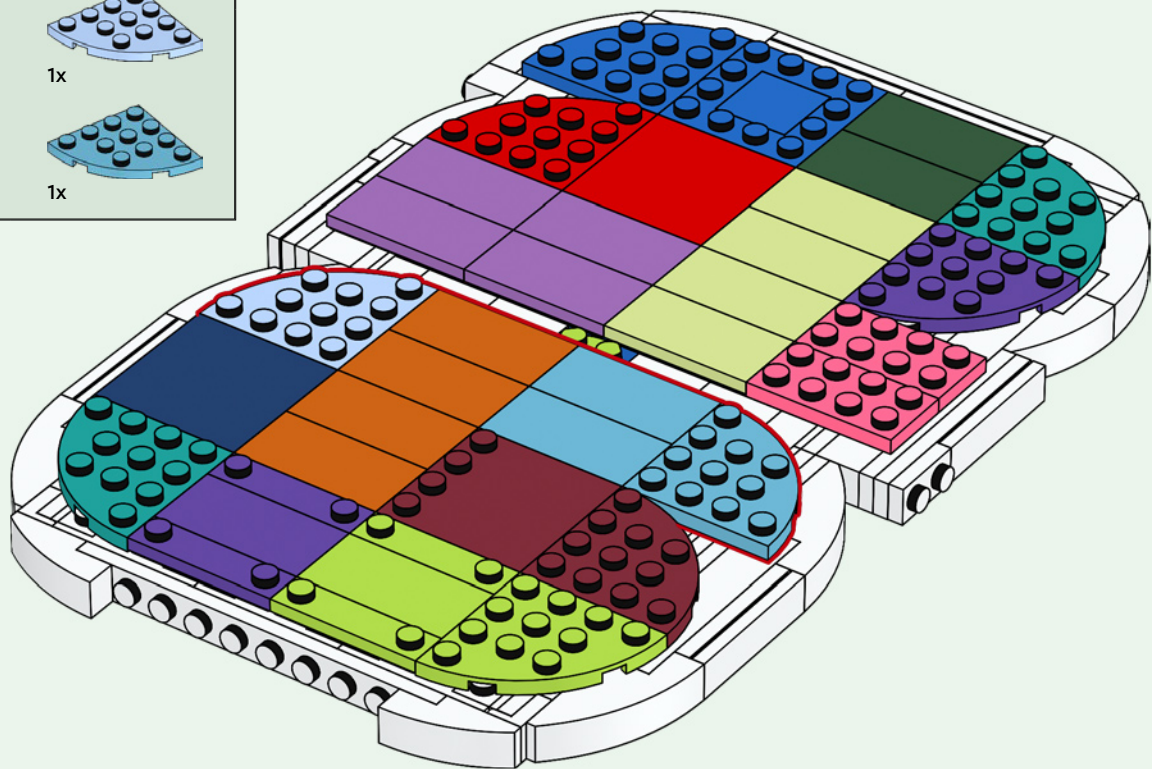

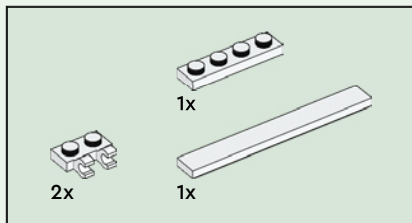

63

1

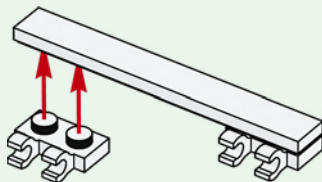

2

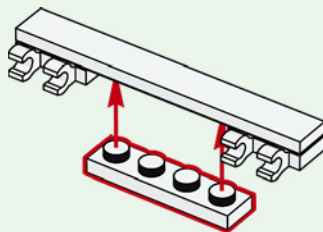

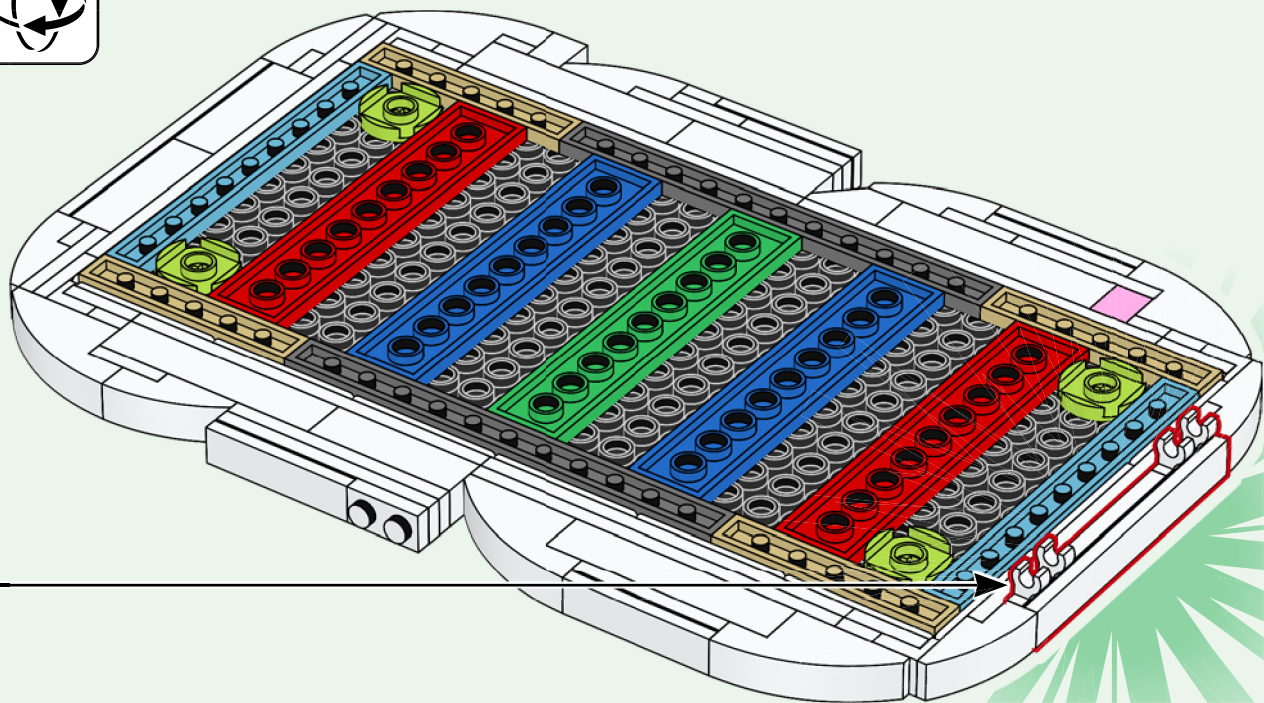
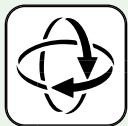

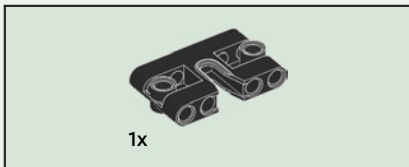

65

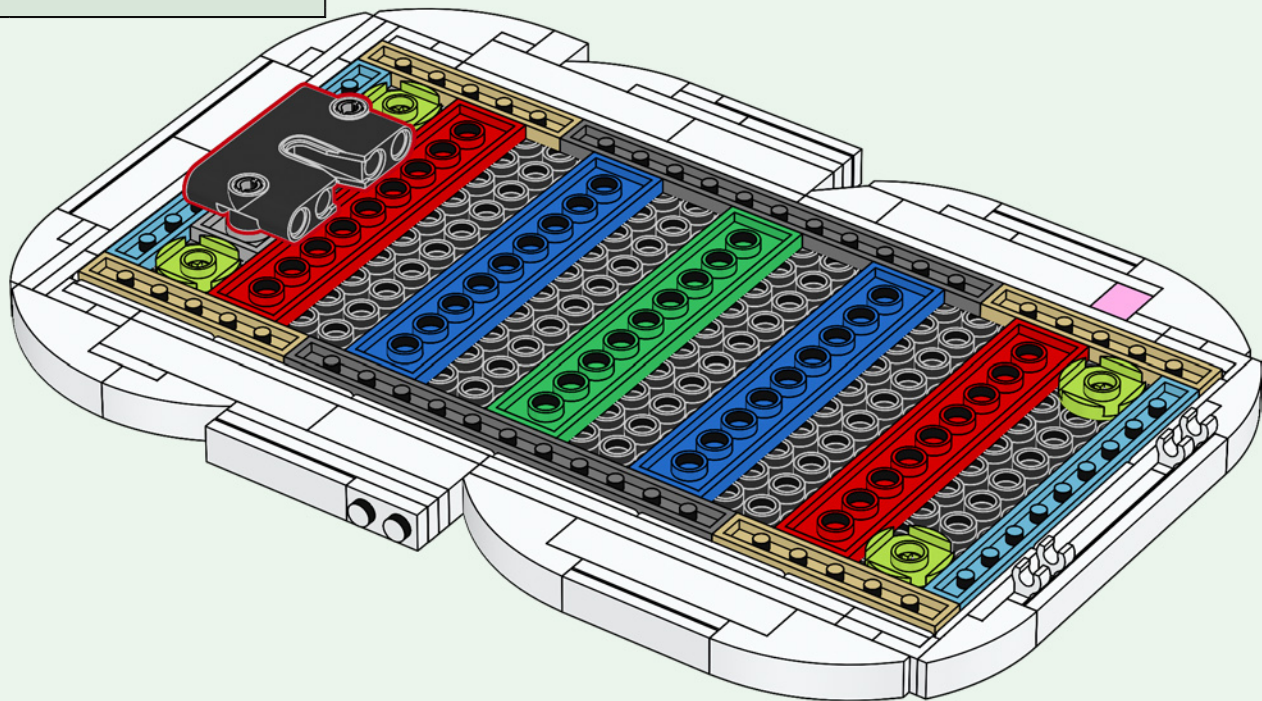

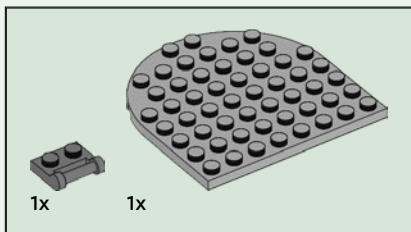
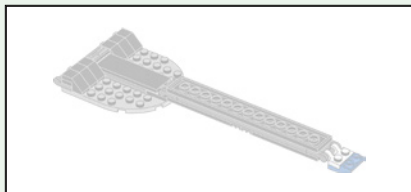

66

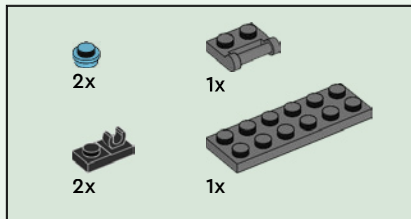
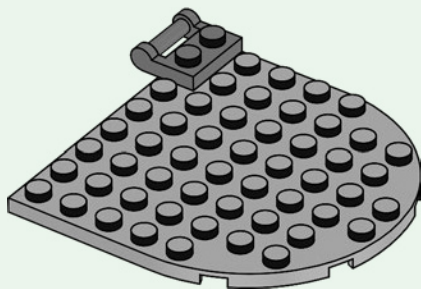

67

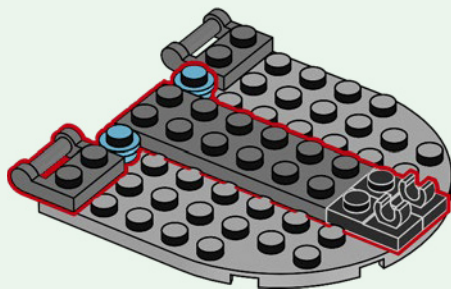

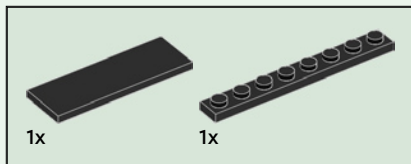

68

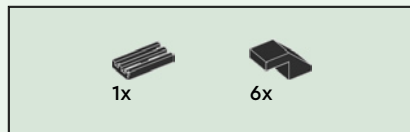
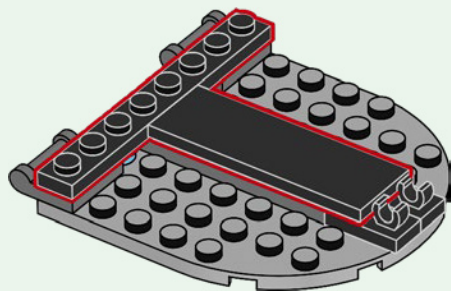

69

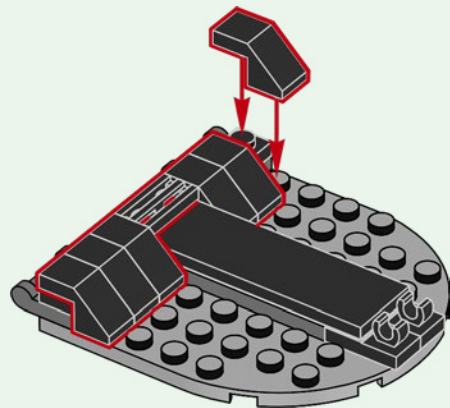

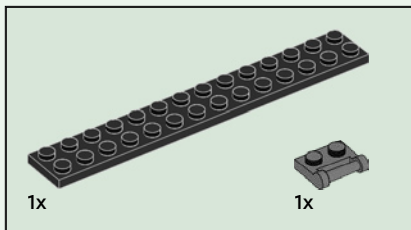
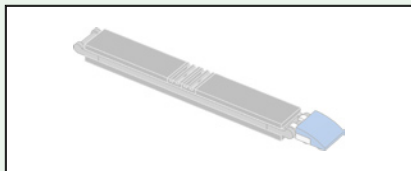

70

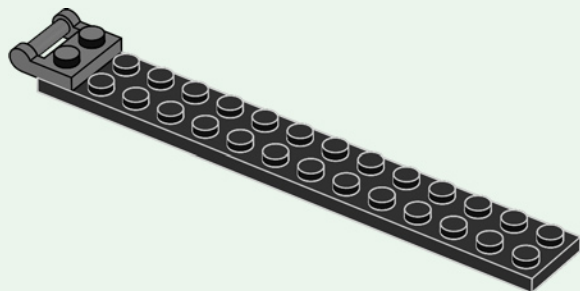

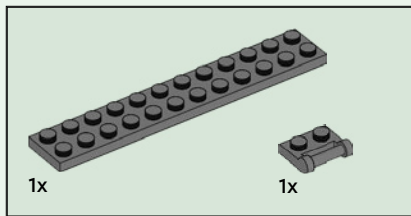

71

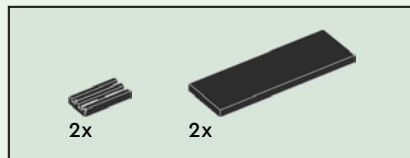
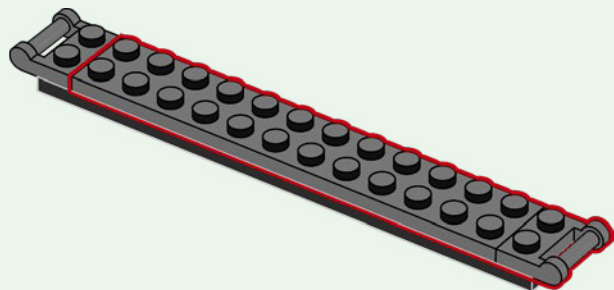

72

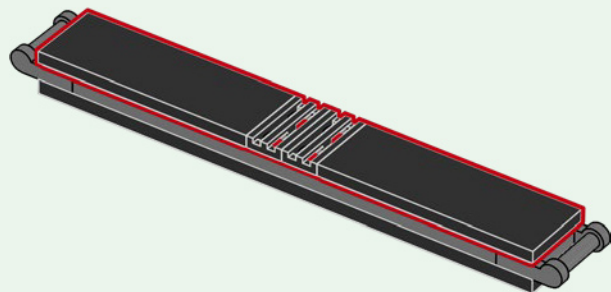

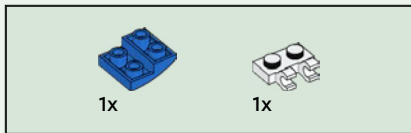

73

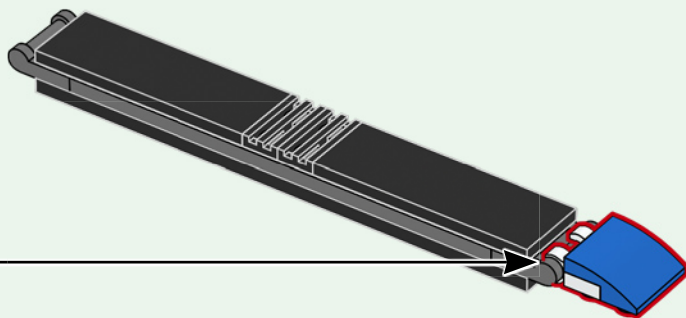
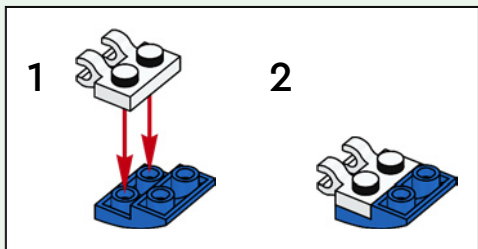

74

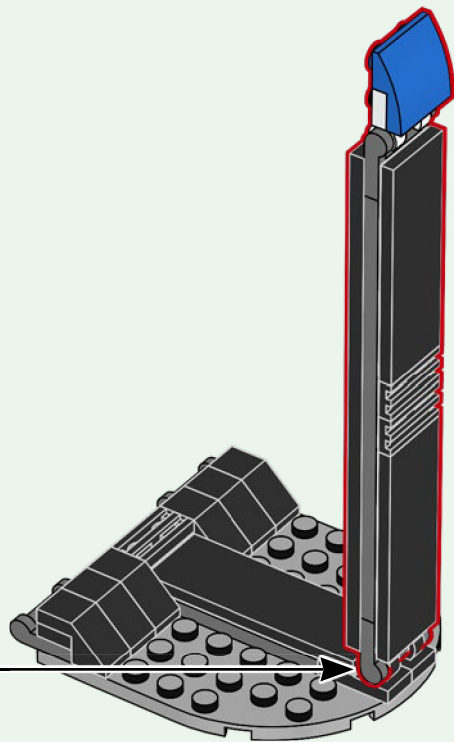

75

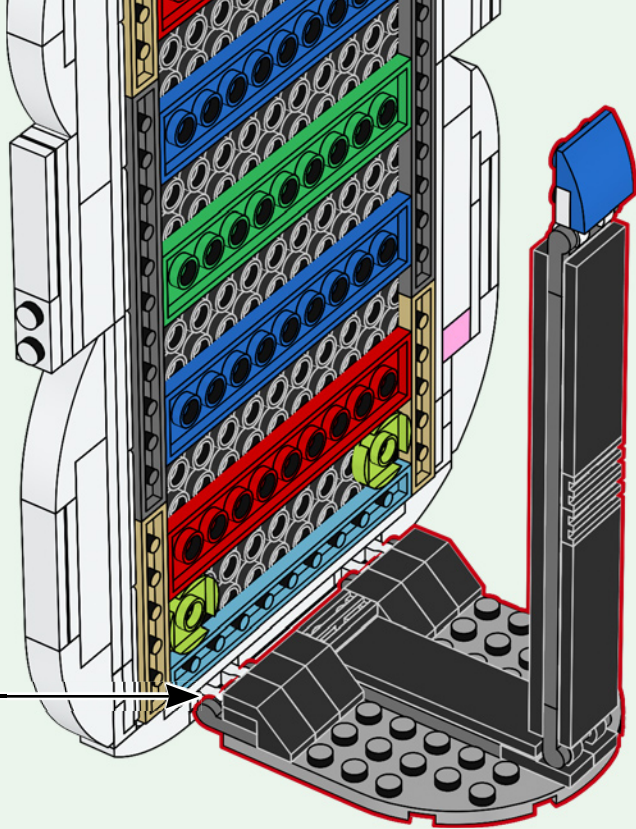

76

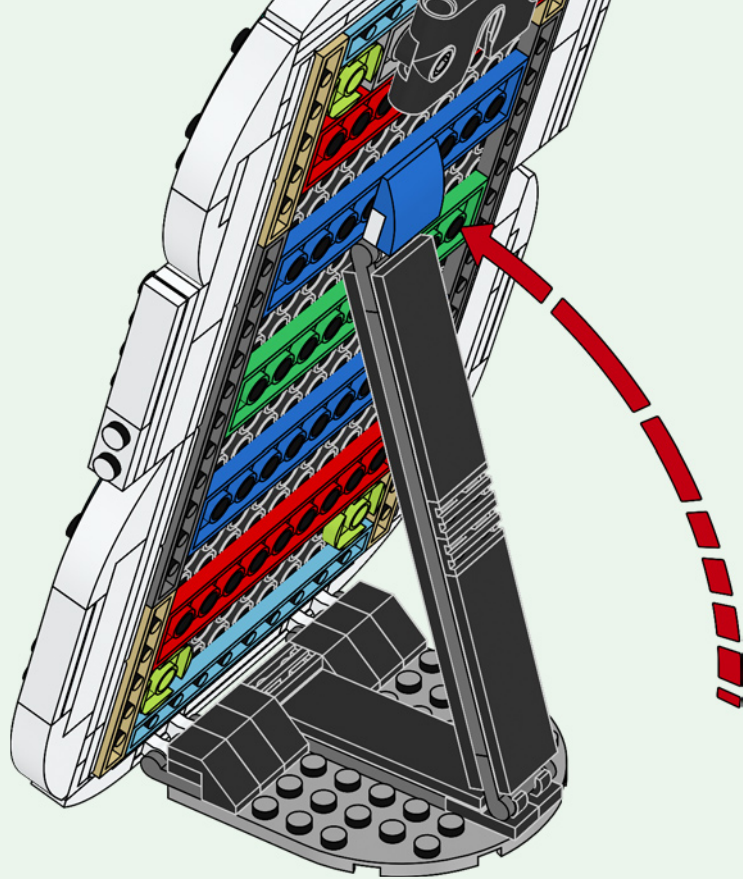

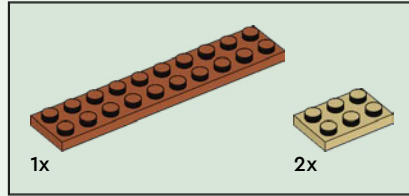
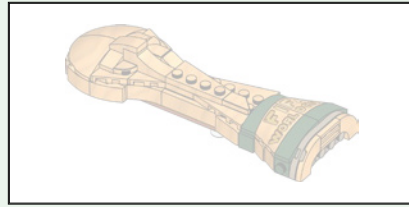

77

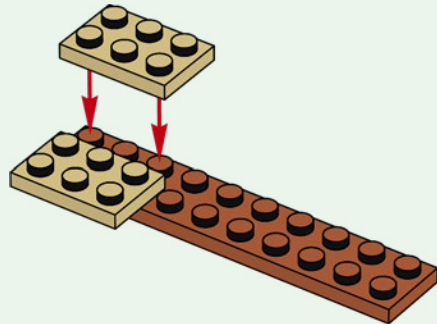

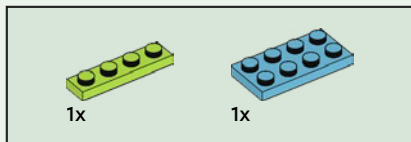

78

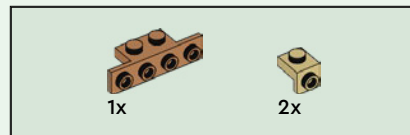
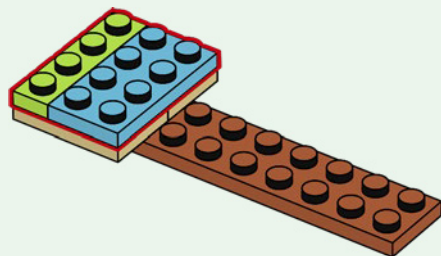

79

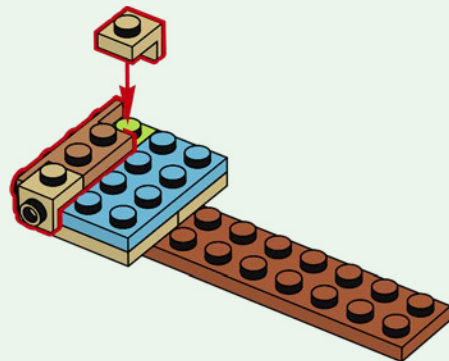



80

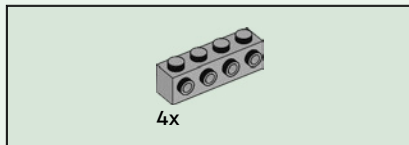
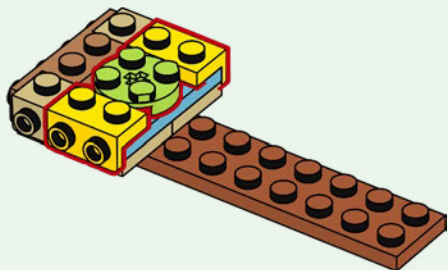

81

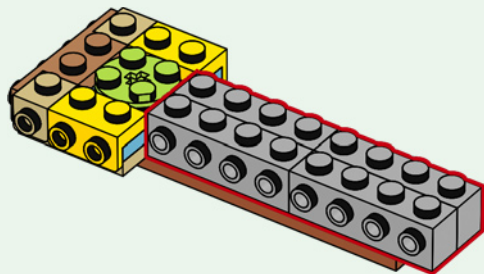

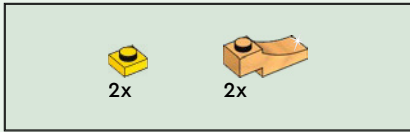

82

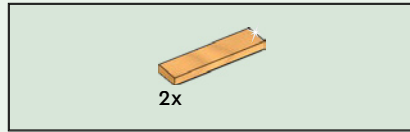
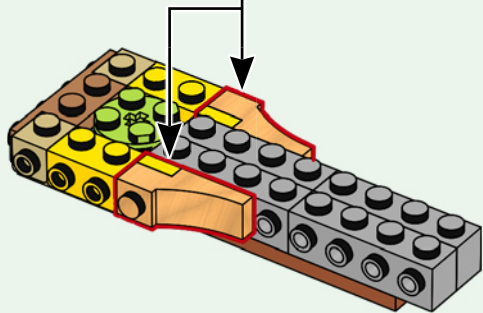
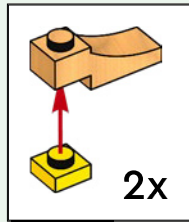

83

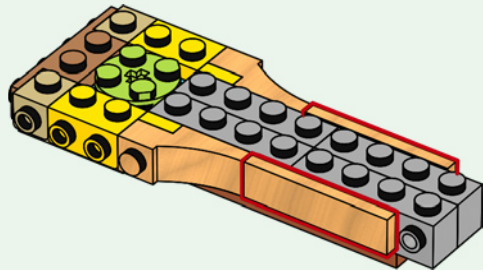

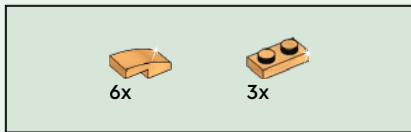

84

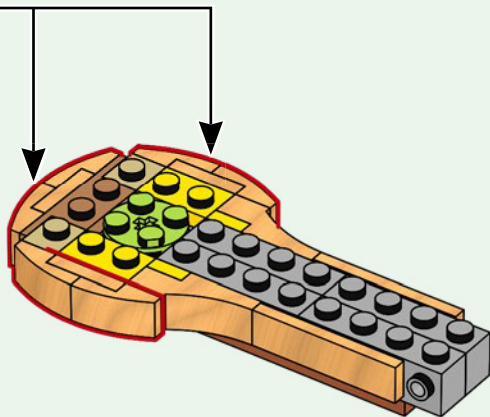
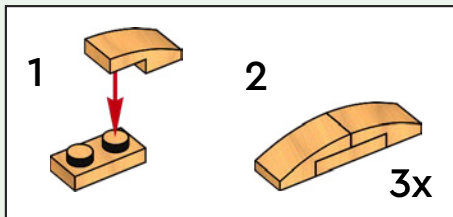

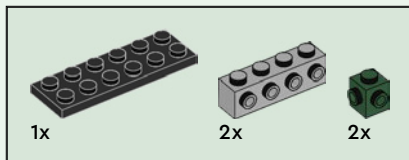

85

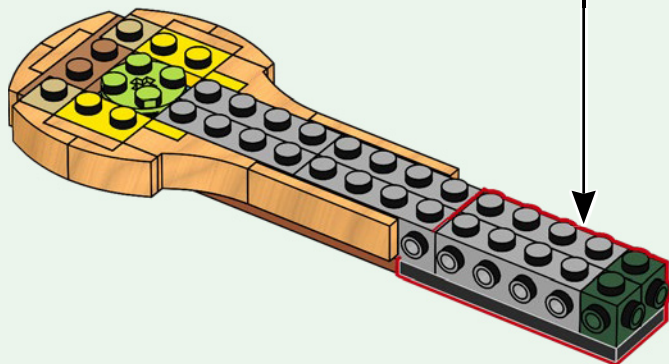
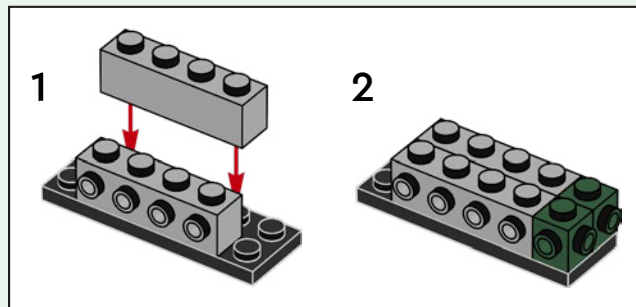

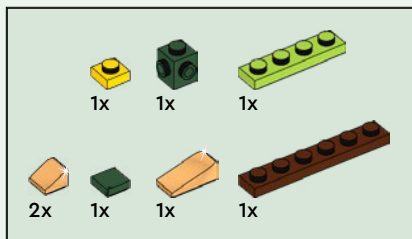

86

1

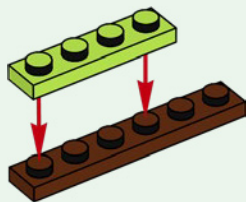

2

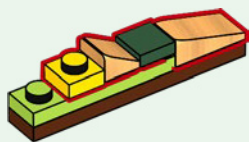

3

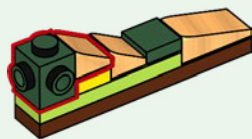

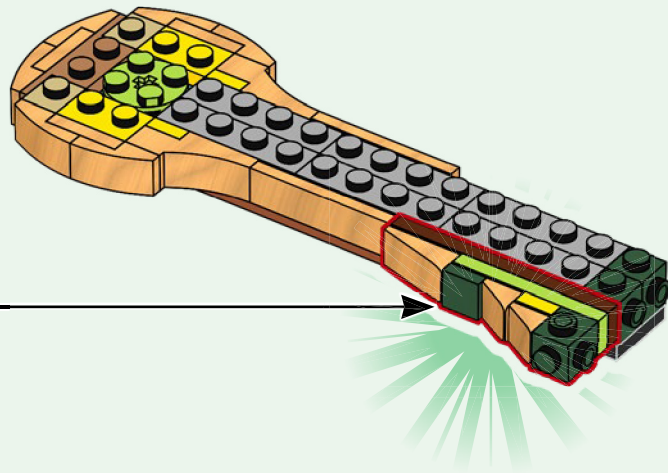

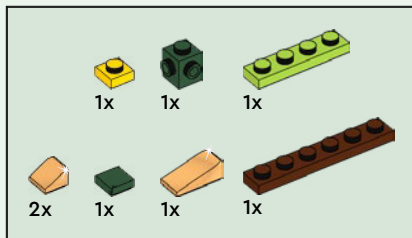

87

1

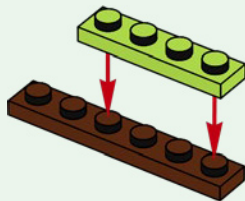

2

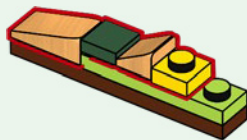

3

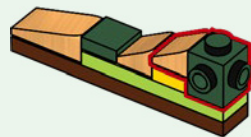

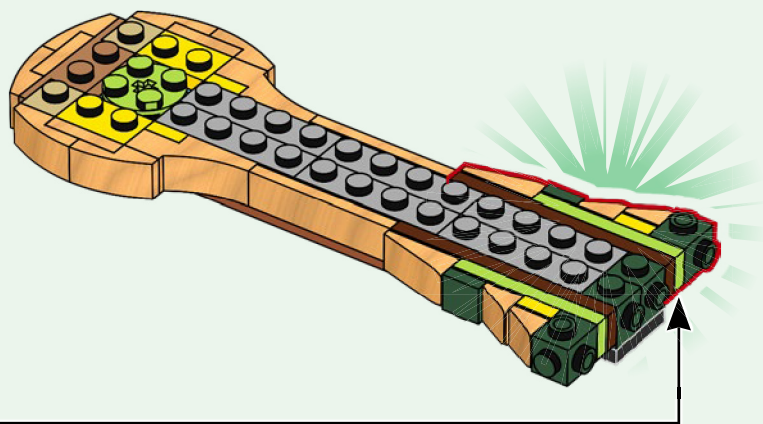

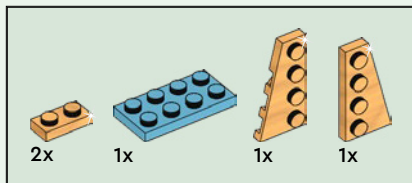

88

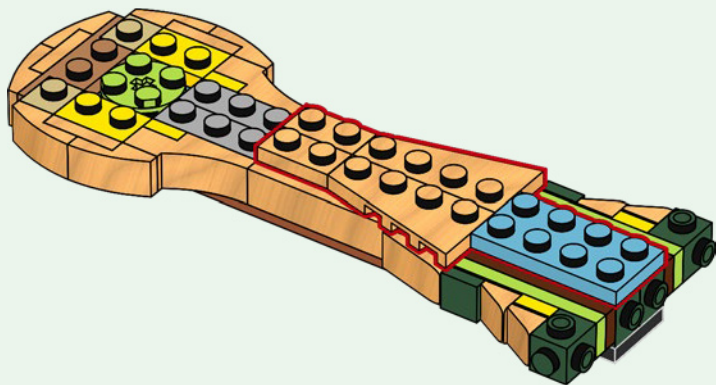

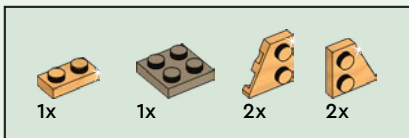

89

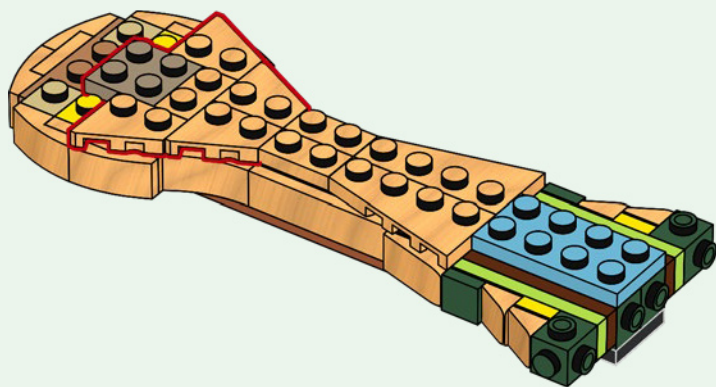

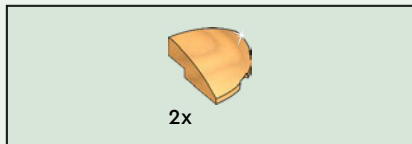

90

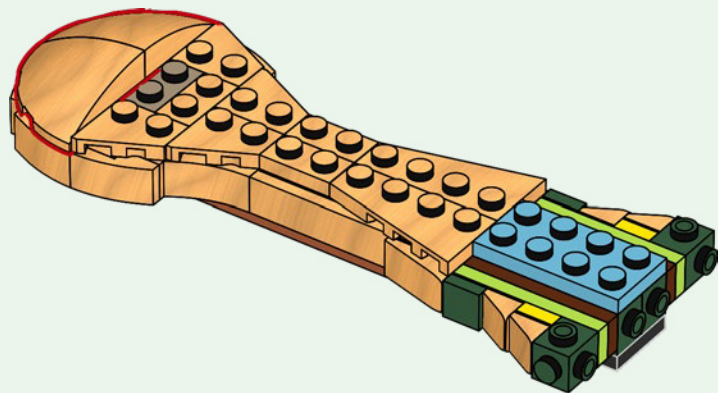

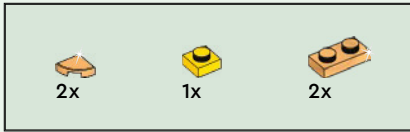

91

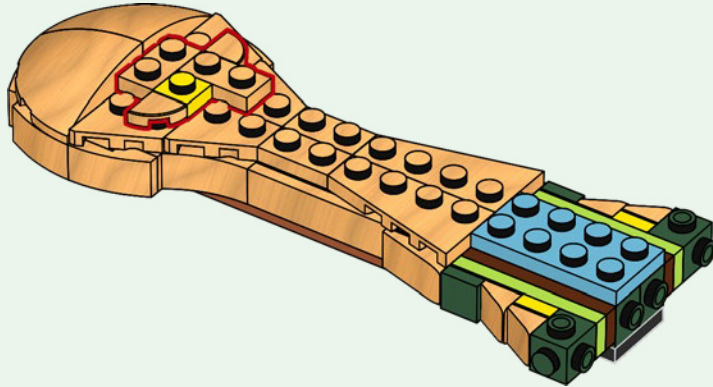

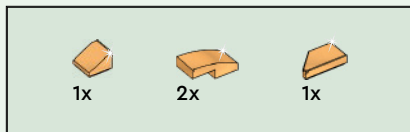

92

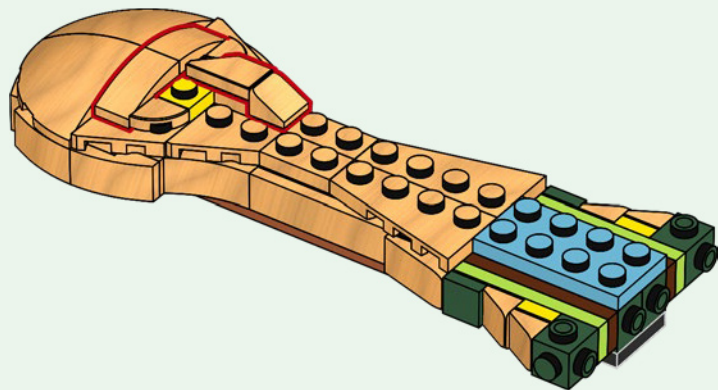

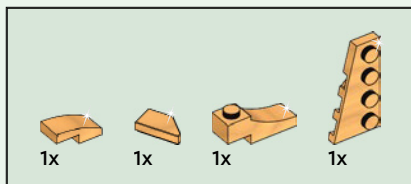

93

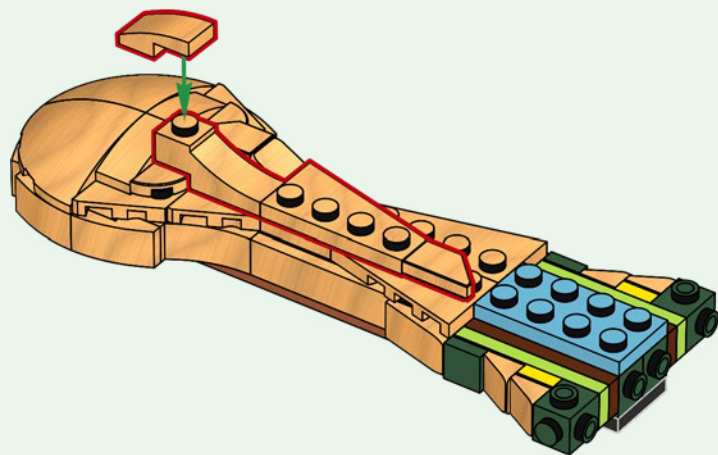

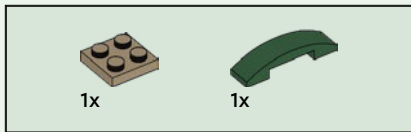

94

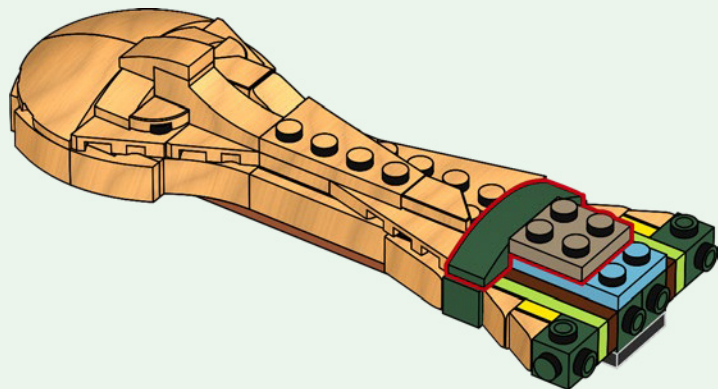

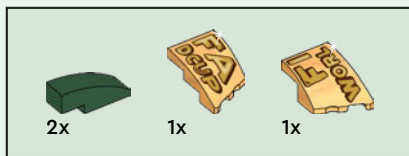

95

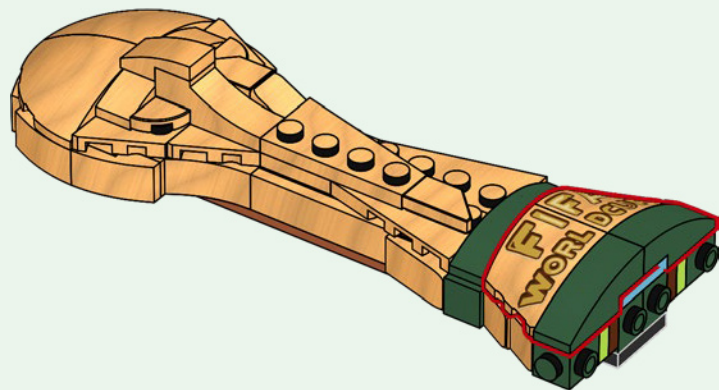

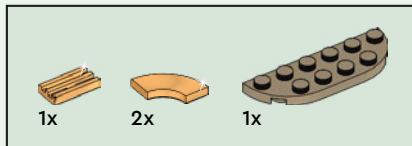

96

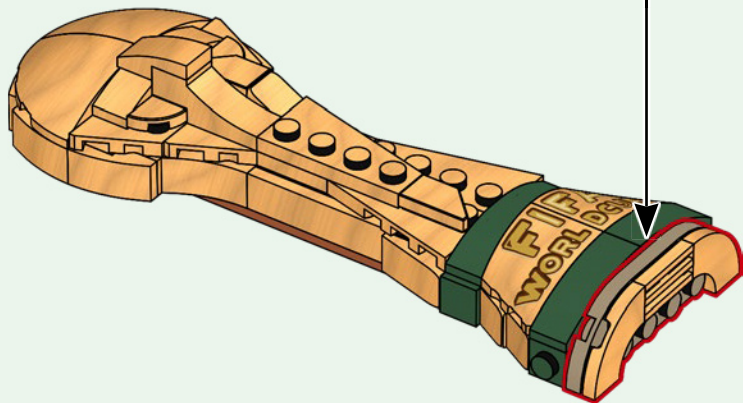
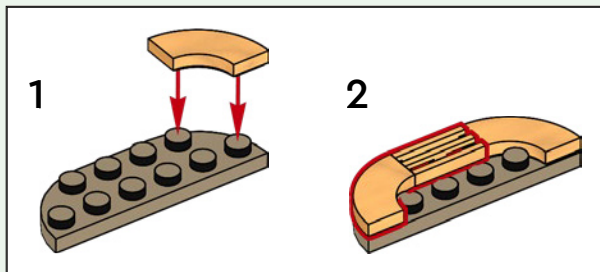



1x

97

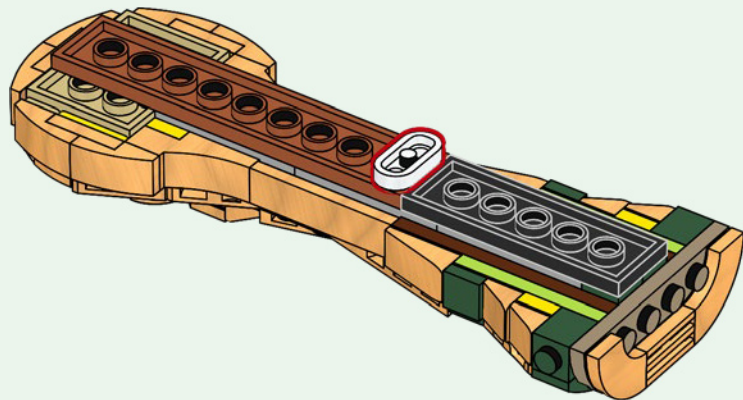

98

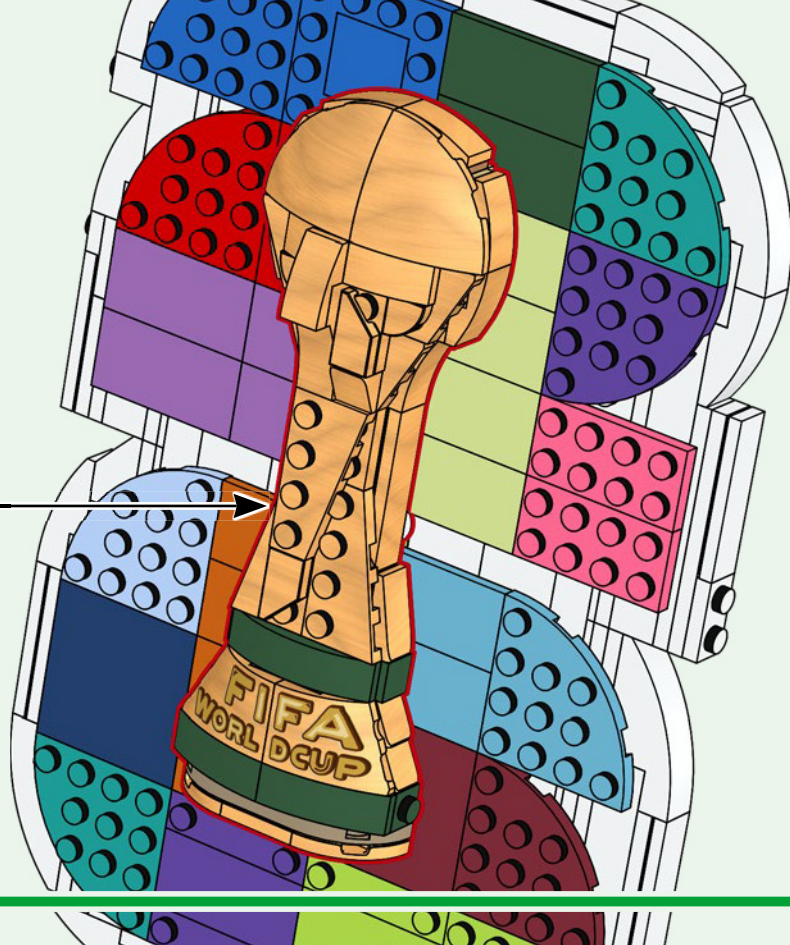



FIFA

1x

99







1x
300501



13x
302401



4x
6296132



1x
6210272



10x
302301



13x
306901



1x
4121932



3x
6347287



4x
6218822



7x
4249112



3x
362301



18x
6168618



5x
6508109



4x
301001



4x
243101



4x
371001



3x
366601



4x
300901



1x
6605648



2x
416201



7x
447701



2x
6374192



2x
4118790



4x
4124067



1x
6588367



1x
6297811



4x
383221



1x
306823



1x
6307924



1x
6339313



1x
6146306



4x
383223



5x
302424



2x
6185994



3x
241226



2x
6347310



6x
6267487



1x
6302094



1x
379526



3x
6318582



1x
346026



7x
6314224



6x
302926



1x
6001494



3x
383228



1x
6351327



2x
6591524



3x
4187743



2x
6257597



1x
6212989



1x
4504705



2x
6047415



1x
6167854



1x
6549659



2x
6055171



4x
6618248



2x
4267850



1x
6252623

2x
6440430



1x
6173167



1x
6525479



1x
4286050

2x
4221590



2x
6276848



6x
4211636



1x
6383102



4x
6146321

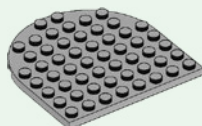

1x
6474254



1x
4211002



2x
6133611



1x
4211067



2x
6253191



1x
6167472



2x
6305455



1x
6584946



5x
4587002



2x
6508110



1x
6508086



1x
6508101



2x
6498728



2x
6498729



2x
6493273



1x
6493272

8x
6218047



9x
6132827



2x
6533889



1x
4490599



2x
6173654



1x
6605646



2x
6618249



3x
6600733



1x
6605647



2x
6478933

1x
6292914



2x
6102986



2x
6097042



2x
4655256



1x
6481835



2x
6423273



4x
4651902



4x
6405559



4x
6626488



 [LEGO.com/service](https://www.lego.com/service)

YOU COULD
WIN

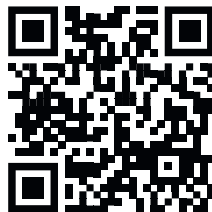

Scan this QR code or go to
LEGO.COM/PRODUCTFEEDBACK and give us
your short feedback about this LEGO® set
for a chance to win a cool LEGO prize.

Terms and Conditions apply*

EN: YOU COULD WIN. Terms and Conditions apply* **DE: Du könntest GEWINNEN.** Es gelten die Teilnahmebedingungen* **FR: TU POURRAIS GAGNER.** Des conditions s'appliquent* **IT: Potresti VINCERE tu.** Termini e condizioni sono applicabili* **ES: PUEDES GANAR.** Aplican términos y condiciones* **PT: PODERÁ GANHAR.** Aplicam-se Termos e Condições* **ZH: 轻松获奖.** 条款和条件适用* **PL: Szansa na WYGRANĄ.** Obowiązuje regulamin* **CS: Máte šanci VYHRÁT.** Platí všeobecné smluvní podmínky* **SK: Máte šancu VYHRAŤ.** Platia všeobecné zmluvné podmienky* **HU: TE IS NYERHETSZ!** Felhasználási feltételek érvényesek* **UA: ВИ МОЖЕТЕ ВИГРАТИ.** Застосовуються загальні положення та умови* **RO: Ai putea CÂȘTIGA.** Se aplică termenii și condiții* **BG: Можете да СПЕЧЕЛИТЕ.** Има определени правила и условия* **LV: Tu vari LAIMĒT.** Ir spēkā noteikumi un nosacījumi.* **ET: Sul on võimalus VÕITA.** Kehtivad tingimused* **LT: Jūs galite LAIMĖTI.** Taikomos sąlygos* **TR: KAZANABİLİRSİN.** Şartlar ve Koşullar geçerlidir*

*[LEGO.com/productfeedback-terms](https://www.lego.com/productfeedback/terms)

Editions[™]

LEGO, the LEGO logo and the Editions logo are trademarks of the LEGO Group. ©2026 The LEGO Group

© FIFA, FIFA's Official Licensed Product Logos, and all brand elements, designs and trade names of FIFA and FIFAe tournaments, events and products are copyrights and / or trademarks of FIFA.

 6647412