

10469



Available in English
In deutscher Sprache verfügbar
Disponibles en français
Disponibile in italiano
Disponibile en español

Disponível em português
提供中文版本
Treść dostępna w języku polskim
K dispozici v češtině

Dostupné v slovenčine
Elérhető magyar nyelven
Доступно українською
Disponibilă în limba română

Pieejams latviešu valodā
Saadaval eesti keeles
Lietuviškai skaitykite
Türkçe mevcuttur

[LEGO.com/service/buildinginstructions](https://www.lego.com/service/buildinginstructions)



LEGO.com/sustainable-packaging



FR
DONNEZ
OU
RECYCLEZ



OU



OU



ASSOCIATION

MAGASIN

DÉCHÈTERIE

Adresses sur quefairedemesdechets.fr

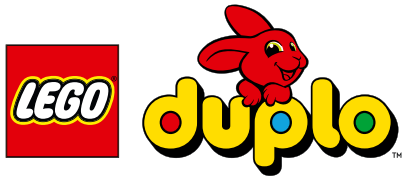

Rebuild
the
world™

Building the Big Skills Toddlers Need



We believe in big starts. Our big bricks are designed for little hands to master. When toddlers' creativity is set free, their opportunities to learn become endless. We call it Learning Through Play. And it inspires every LEGO® DUPLO® set. Based on thorough scientific research, each set helps young minds develop both IQ skills (cognitive, physical, creative) and EQ skills (social, emotional). Let all toddlers Start Off Big.

LEGO DUPLO sets are categorised into benefit territories that match toddlers' ages and developmental stages.



**PLAY
IDEAS**



LOGICAL THINKING  +  EXPRESSING YOURSELF

LEGO® DUPLO® sets in the blue territory can help toddlers master essential skills like caring for others and understanding emotions. Aimed at children aged 18 months and over, these sets also encourage comparing, matching and sorting skills through delightful, familiar play scenarios. With a little gentle guidance from grown-ups, children's early skills can flourish in a safe and creative space. As toddlers engage in storytelling and role play, they can enhance their logical thinking (IQ) and emotional expression (EQ), building self-confidence and empathy along the way!







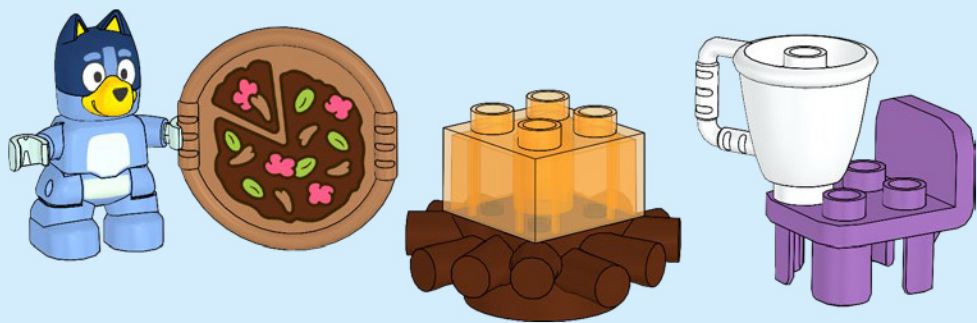
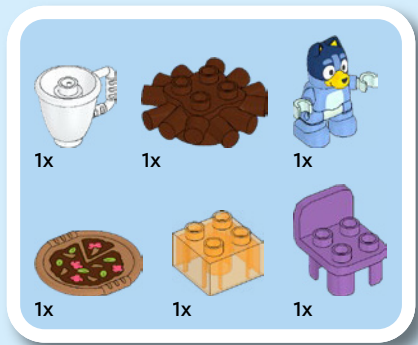

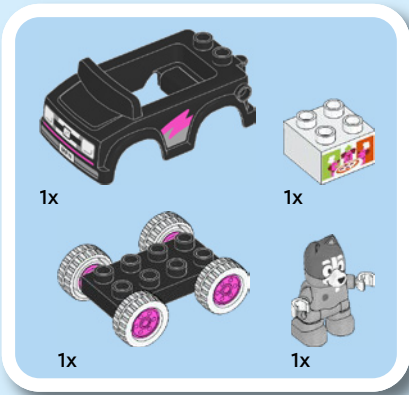

1

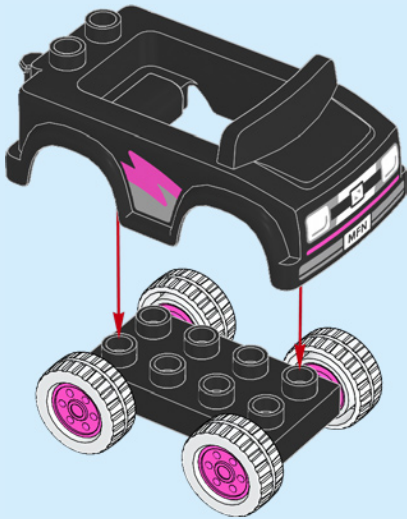

2

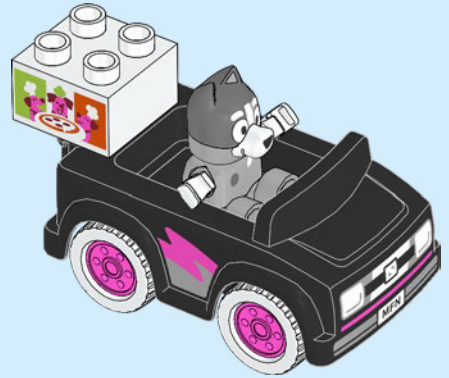

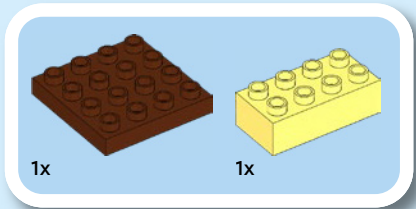
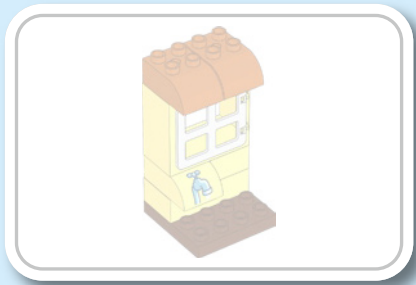

1

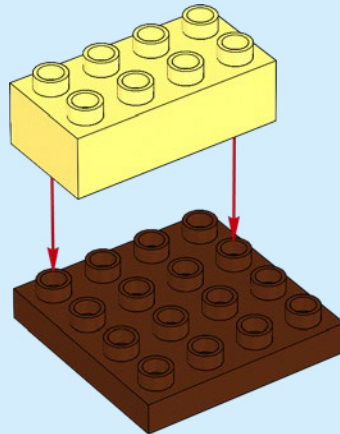

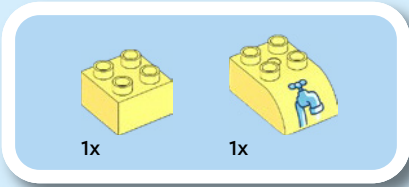

2

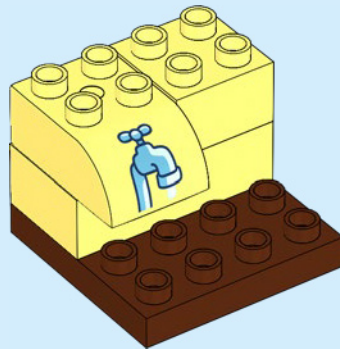

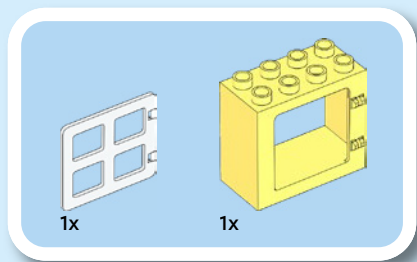

3

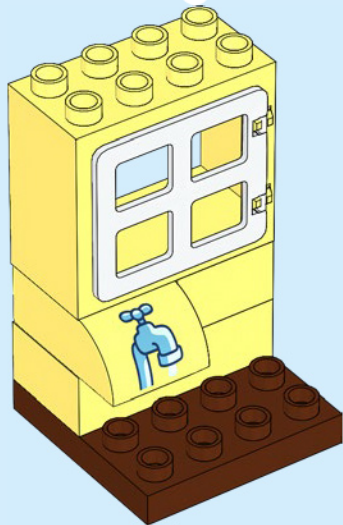
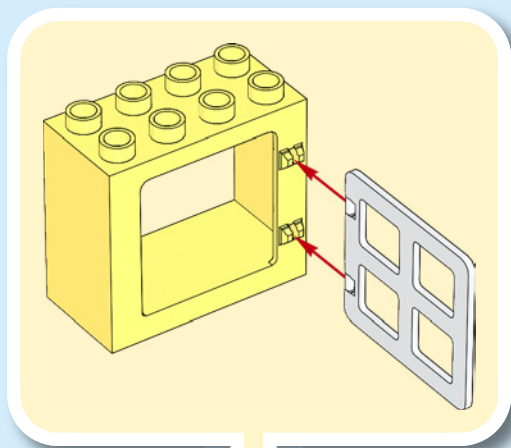

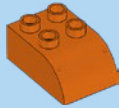

2x

4



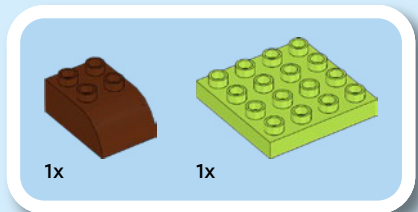
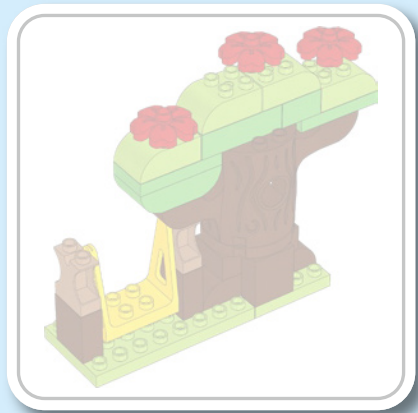

1

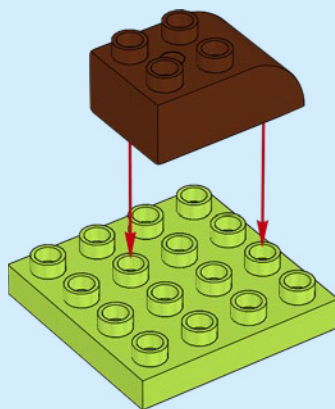

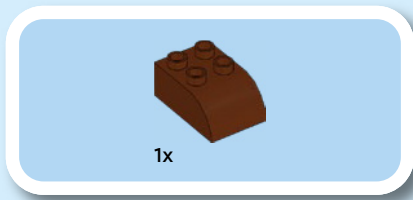

2

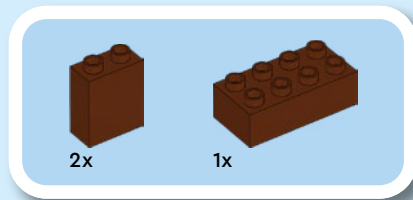
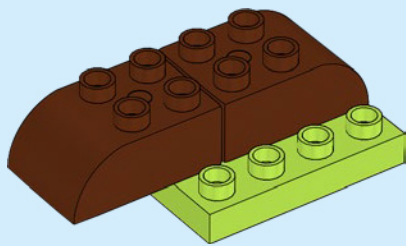

3

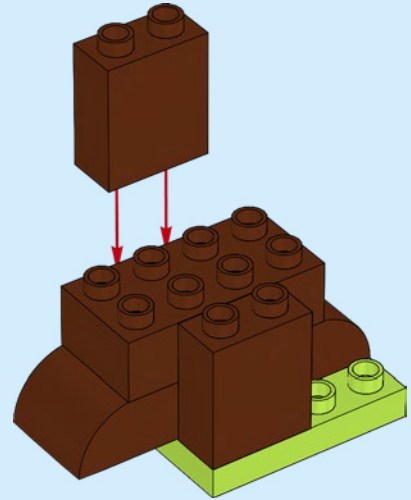

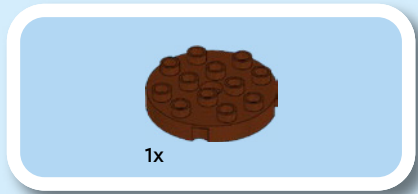

4

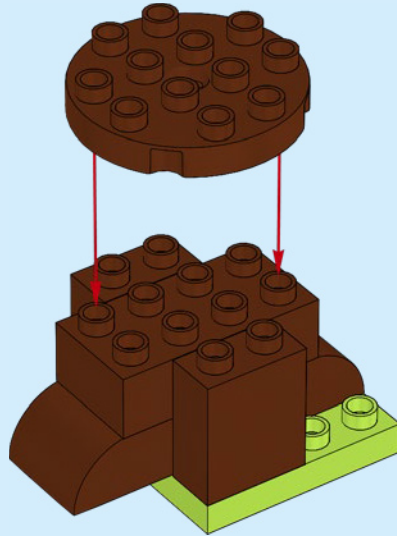

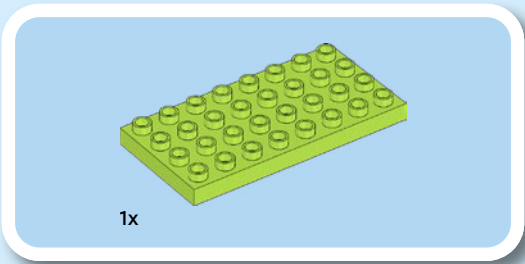

5

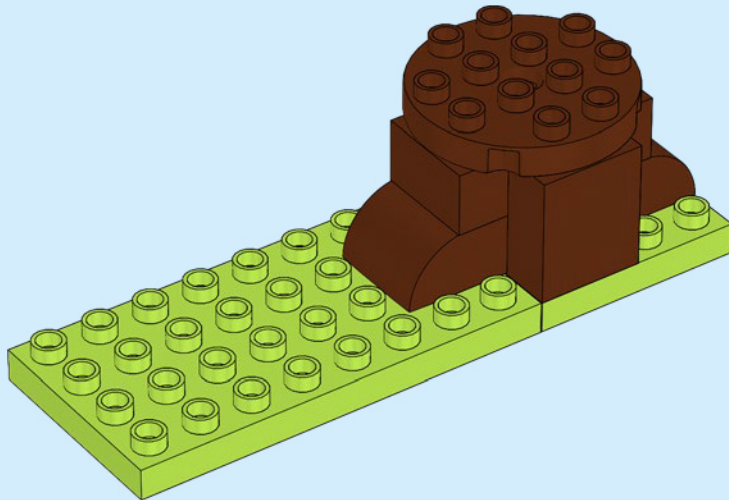

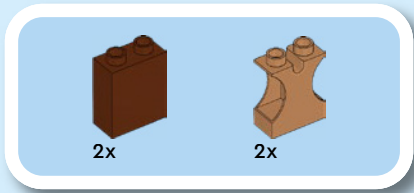

6

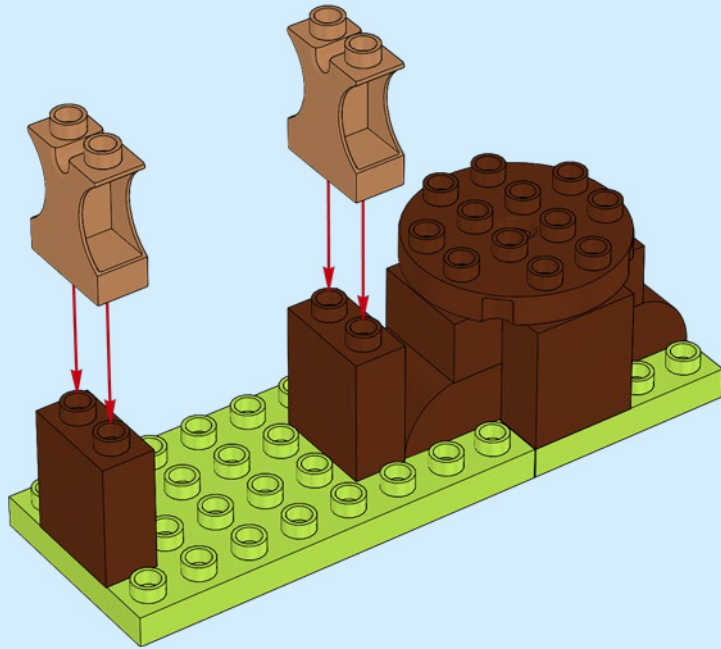

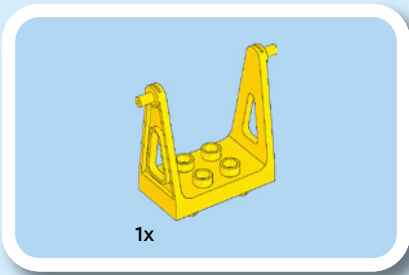

7

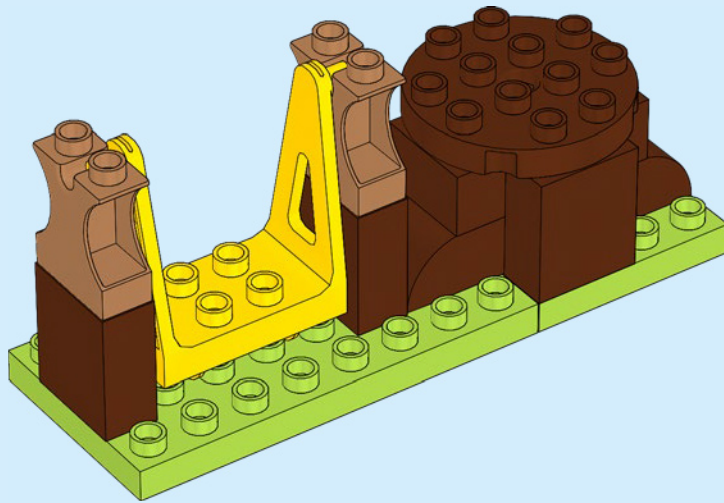

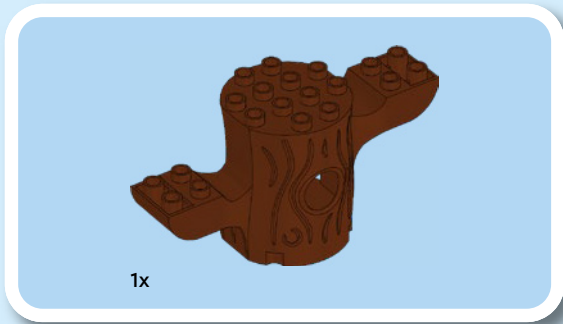

8

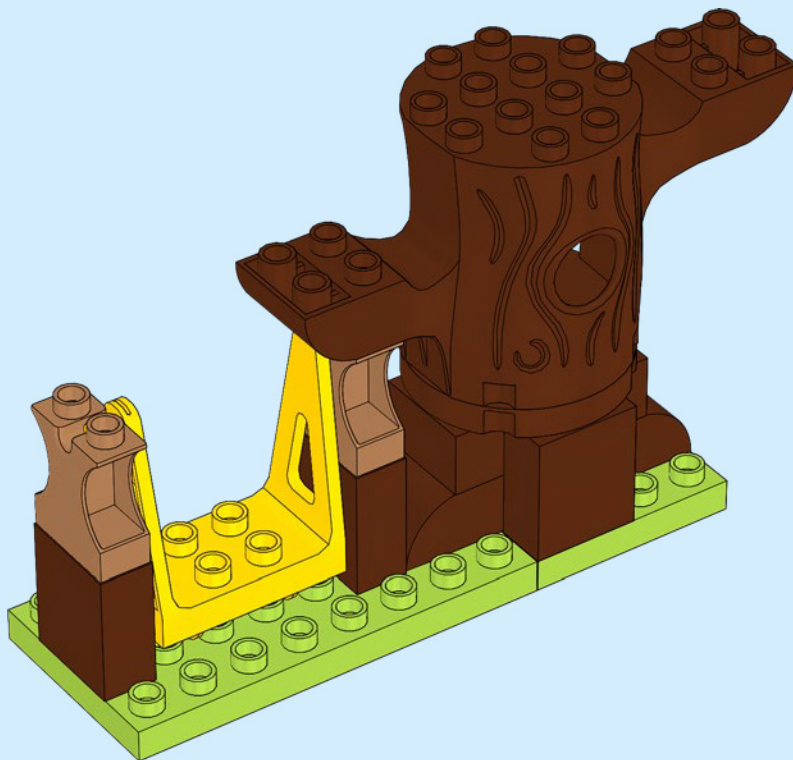

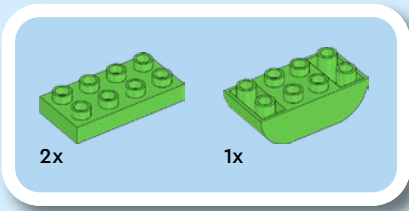

9



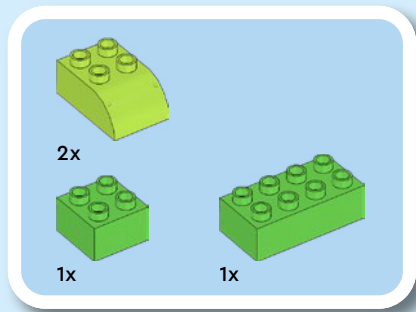

10

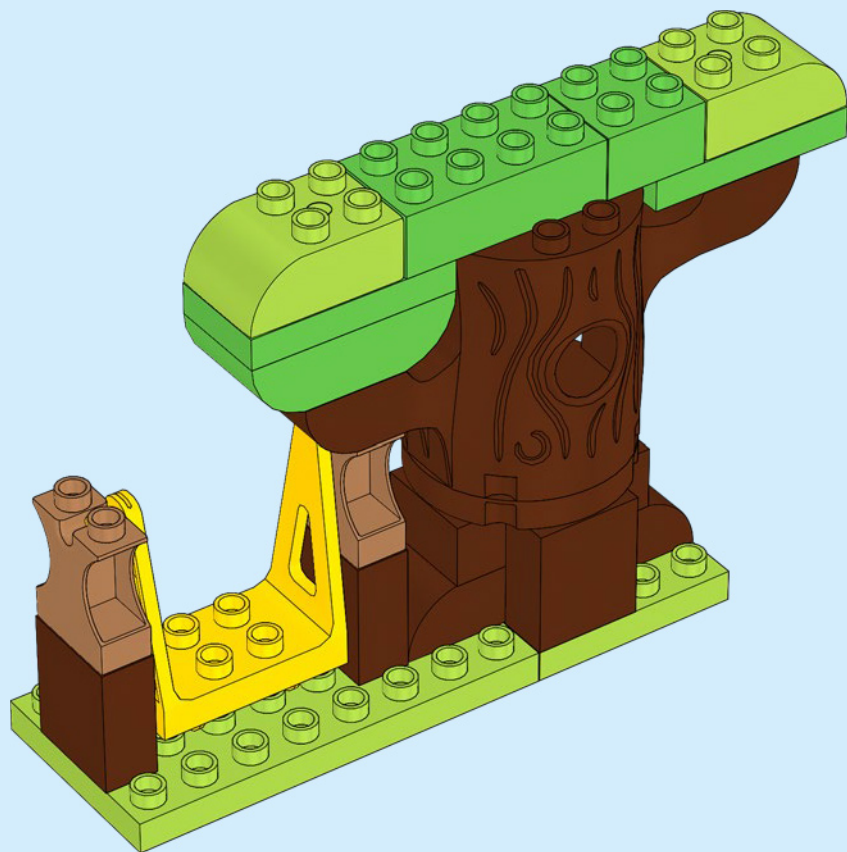

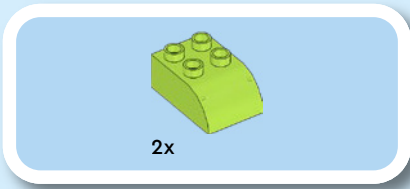

11





3x

12





EXPLORE LEGO® DUPLO® DIGITAL GAMES



Download on the
App Store

GET IT ON
Google Play

Apple and the Apple logo are trademarks of Apple Inc., registered in the U.S. and other countries and regions. App Store is a service mark of Apple Inc. Google Play and the Google Play logo are trademarks of Google LLC.



1x
6210049



1x
6601327

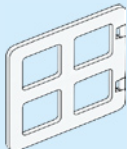

1x
4586178



3x
6387973

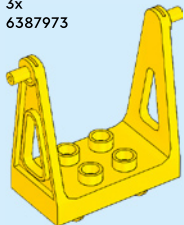

1x
6606049



1x
6536995



1x
6592657



2x
6535352

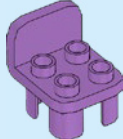

1x
6594061

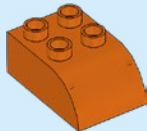

2x
6490877

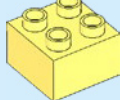

1x
4648231



1x
6601325

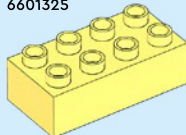

1x
6294939

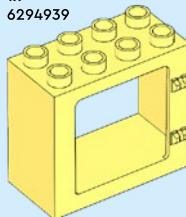

1x
6294401



1x
6601326

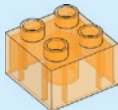

1x
6606051



4x
6333510



2x
6484348

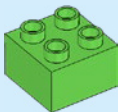

1x
4168579

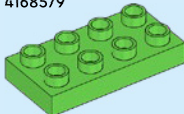

2x
4170795

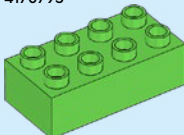

1x
4166924

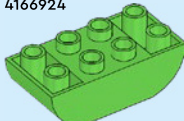

1x
4652748

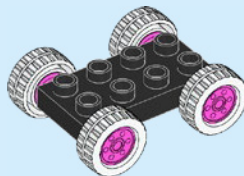

1x
6593177



1x
6252069



1x
6529034



1x
6224248

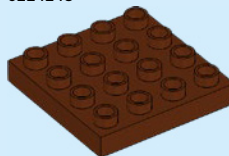

1x
6256693

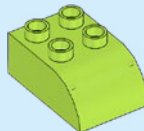

4x
6020068

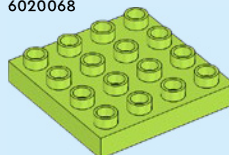

1x
6327077

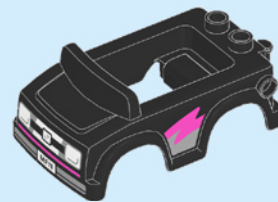

1x
6601320

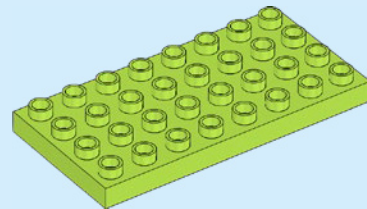

1x
6208491

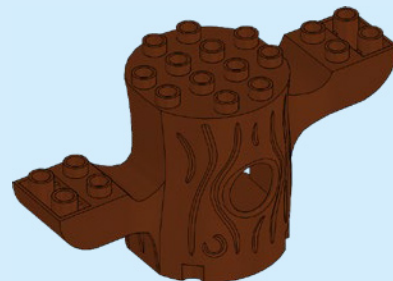

1x
6393601



[LEGO.com/service](https://www.LEGO.com/service)

YOU COULD **WIN**



Scan this QR code or go to **LEGO.COM/PRODUCTFEEDBACK** and give us your short feedback about this LEGO® set for a chance to win a cool LEGO prize.

Terms and Conditions apply*

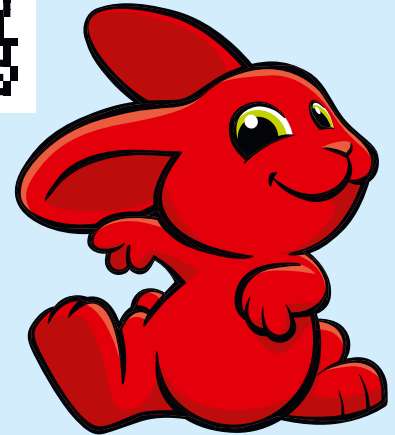

EN: YOU COULD WIN. Terms and Conditions apply* **DE: Du könntest GEWINNEN.** Es gelten die Teilnahmebedingungen* **FR: TU POURRAIS GAGNER.** Des conditions s'appliquent* **IT: Potresti VINCERE tu.** Termini e condizioni sono applicabili* **ES: PUEDES GANAR.** Aplican términos y condiciones* **PT: PODERÁ GANHAR.** Aplicam-se Termos e Condições* **ZH: 轻松获奖. 条款和条件适用*** **PL: Szansa na WYGRANĄ.** Obowiązuje regulamin* **CS: Máte šanci VYHRÁT.** Platí všeobecné smluvní podmínky* **SK: Máte šancu VYHRAŤ.** Platia všeobecné zmluvné podmienky* **HU: TE IS NYERHETSZ!** Felhasználási feltételek érvényesek* **UA: ВИ МОЖЕТЕ ВИГРАТИ.** Застосовуються загальні положення та умови* **RO: Ai putea CÂȘTIGA.** Se aplică termeni și condiții* **BG: Можете да СПЕЧЕЛИТЕ.** Има определени правила и условия* **LV: Tu vari LAIMĒT.** Ir spēkā noteikumi un nosacījumi.* **ET: Sul on võimalus VÕITA.** Kehtivad tingimused* **LT: Jūs galite LAIMĖTI.** Taikomos sąlygos* **TR: KAZANABİLİRSİN.** Şartlar ve Koşullar geçerlidir*

*[LEGO.com/productfeedback-terms](https://www.lego.com/productfeedback-terms)

LEGO, the LEGO logo and DUPLO are trademarks of the LEGO Group. ©2026 The LEGO Group

BLUEY (word mark and character logos) are trade marks of Ludo Studio Pty Limited and are used under license. BLUEY logo © Ludo Studio Pty Limited 2018. Licensed by BBC Studios. BBC is a trade mark of the British Broadcasting Corporation and is used under licence. BBC logo © BBC 1996.