A small, stylized red rabbit character with long ears and a smiling face, perched on top of the word "duplo".
duplo™

10464





Get excited about our new packaging!

We're switching from plastic to paper-based packaging. That's why you might find a mix of paper and plastic in our boxes!

Nos nouveaux emballages vous emballeront !

Nous passons des emballages en plastique aux emballages à base de papier. C'est pourquoi vous pourriez trouver un mélange de papier et de plastique dans nos boîtes !

¡Te presentamos nuestros nuevos empaques!

Estamos sustituyendo las bolsas de plástico por bolsas con base de papel. ¡Por eso, puedes encontrar una mezcla de papel y de plástico en nuestras cajas!

[LEGO.com/sustainable-packaging](https://www.lego.com/sustainable-packaging)

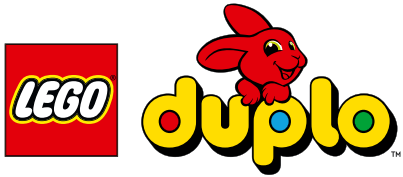

Rebuild
the
world™



Building the Big Skills Toddlers Need

We believe in big starts. Our big bricks are designed for little hands to master. When toddlers' creativity is set free, their opportunities to learn become endless. We call it Learning Through Play. And it inspires every LEGO® DUPLO® set. Based on thorough scientific research, each set helps young minds develop both IQ skills (cognitive, physical, creative) and EQ skills (social, emotional). Let all toddlers Start Off Big.

LEGO DUPLO sets are categorized into benefit territories that match toddlers' ages and developmental stages.

Développer les grandes compétences dont les tout-petits ont besoin

Nous croyons aux grands départs. Nos grandes briques sont conçues pour être manipulées par les petites mains. Lorsque la créativité des tout-petits est libérée, les possibilités d'apprentissage deviennent infinies. C'est ce que nous appelons apprendre par le jeu. Et c'est ce qui inspire chaque ensemble LEGO® DUPLO®. Basé sur des recherches scientifiques approfondies, chaque ensemble aide les jeunes esprits à développer à la fois les compétences QI (cognitives, physiques, créatives) et les compétences QE (sociales, émotionnelles). Permettez à tous les enfants en bas âge de commencer en beauté.

Les ensembles LEGO DUPLO sont classés en catégories d'avantages qui correspondent à l'âge et au stade de développement des tout-petits.

Desarrollamos las grandes habilidades que necesitan los peques

Creemos en los grandes comienzos. Nuestros bricks más grandes están diseñados para que una manita pueda manejarlos con facilidad. Cuando la creatividad de los peques fluye libremente, las oportunidades de aprender se vuelven infinitas. A eso lo llamamos "aprendizaje mediante el juego". Y es la fuente que inspira cada set LEGO® DUPLO®. Basados en rigurosos estudios científicos, estos sets contribuyen al desarrollo del cociente intelectual (CI, resultante de las habilidades cognitivas, físicas y creativas) y el cociente emocional (CE, que depende de las habilidades sociales y emocionales) de las mentes más jóvenes. Todos los niños y niñas merecen un gran comienzo.

Los sets LEGO DUPLO se clasifican en campos de aprovechamiento acordes con las edades y etapas de desarrollo de los niños y niñas.

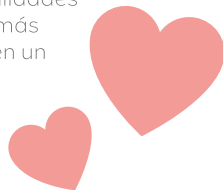

LOGICAL
THINKING



EXPRESSING
YOURSELF

LEGO® DUPLO® sets in the blue territory can help toddlers master essential skills like caring for others and understanding emotions. Aimed at children aged 18 months and up, these sets also encourage comparing, matching and sorting skills through delightful, familiar play scenarios. With a little gentle guidance from grown-ups, children's early skills can flourish in a safe and creative space. As toddlers engage in storytelling and role-play, they can enhance their logical thinking (IQ) and emotional expression (EQ), building self-confidence and empathy along the way!

PENSÉE
LOGIQUE



EXPRESSION
DE SOI

Les ensembles LEGO® DUPLO® du territoire bleu peuvent aider les tout-petits à maîtriser des compétences essentielles telles que l'attention portée aux autres et la compréhension des émotions. Destinés aux enfants âgés de 18 mois et plus, ces ensembles encouragent également les capacités de comparaison, d'association et de tri à travers des scénarios de jeu délicieux et familiers. Avec un peu d'encadrement de la part des adultes, les enfants peuvent acquérir leurs premières aptitudes dans un espace sûr et créatif. En racontant des histoires et en jouant des rôles, les tout-petits peuvent améliorer leur raisonnement logique (QI) et leur expression émotionnelle (QE) tout en développant leur confiance en soi et leur empathie!

PENSAMIENTO
LÓGICO



EXPRESATE

Los sets LEGO® DUPLO® de la zona azul pueden ayudar a tu bebé a dominar habilidades esenciales como cuidar de los demás y entender las emociones. Dirigidos a niños y niñas a partir de 18 meses, estos sets también fomentan las habilidades de comparación, emparejamiento y clasificación a través de escenarios de juego divertidos y familiares. Con un poco de orientación por parte de los adultos, las habilidades tempranas de tu peque pueden florecer en un espacio seguro y creativo. Participando en juegos de interpretación y narración de historias, tu bebé podrá mejorar su pensamiento lógico (CI) y su expresión emocional (CE) al tiempo que desarrolla confianza en sí mismo y empatía.



PLAY
IDEAS

IDÉES
DE JEU

IDEAS
DE JUEGO



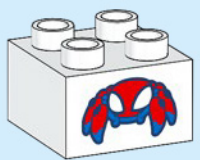
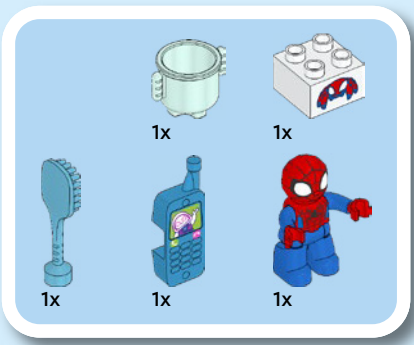

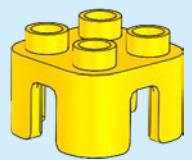
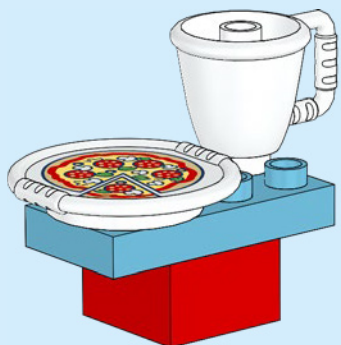

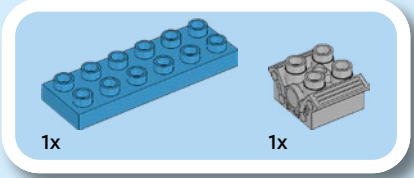
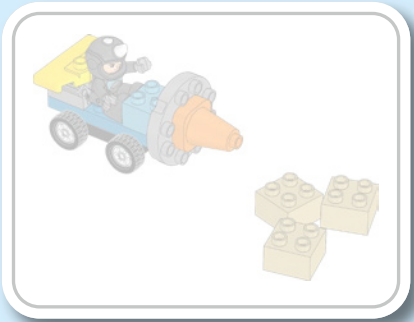

1

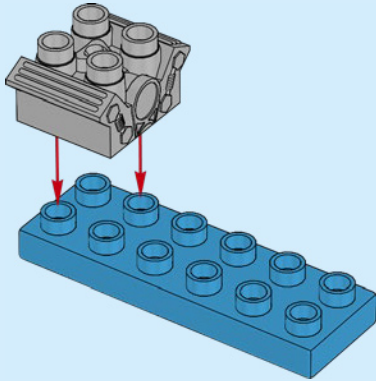

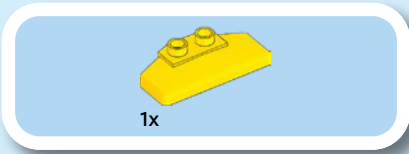

2

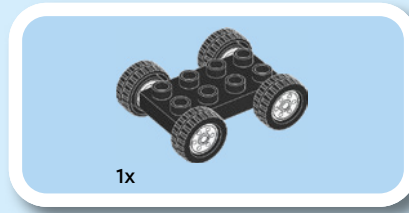
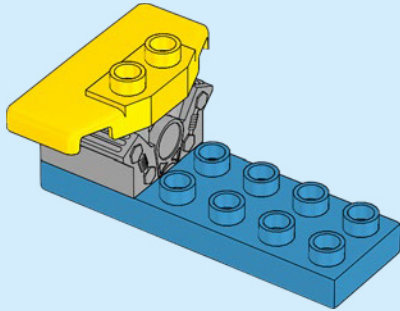

3

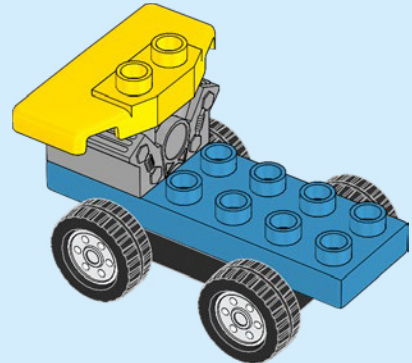

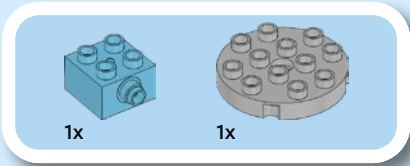

4

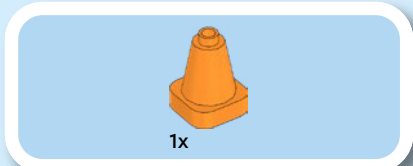
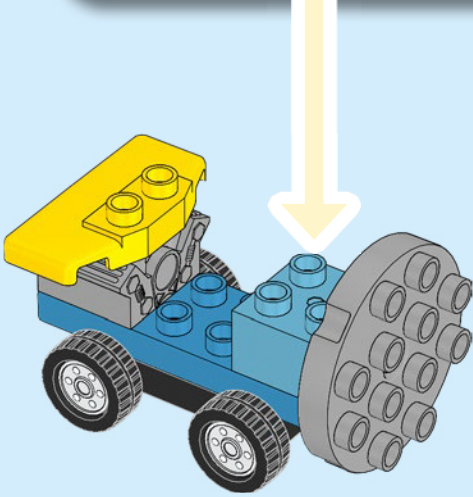
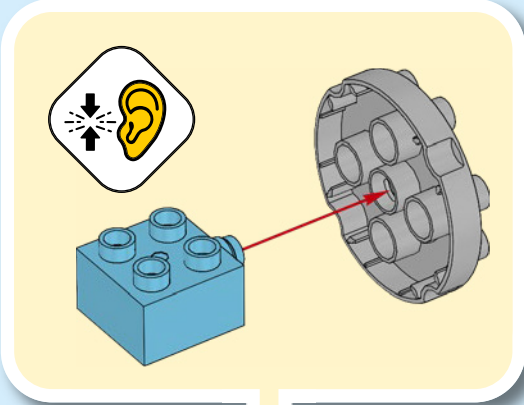

5

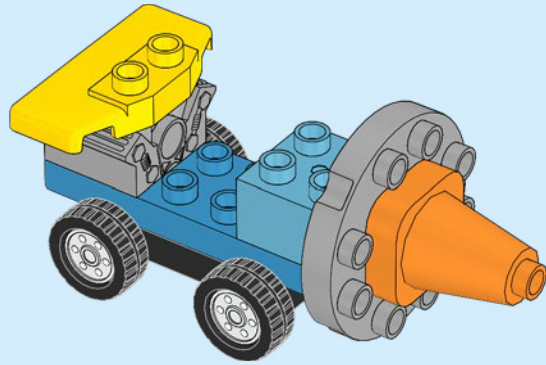



6

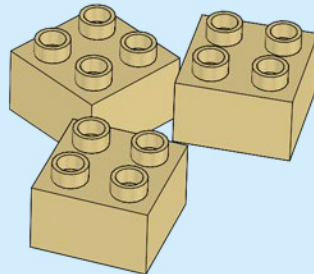
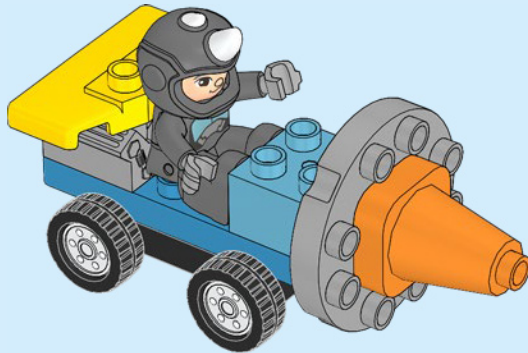

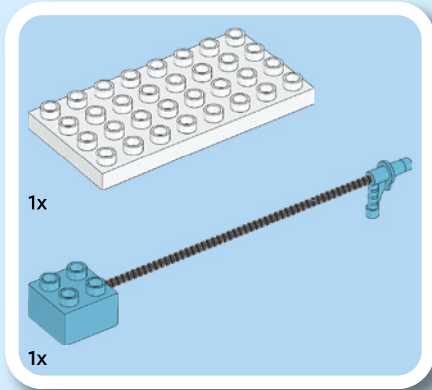

1

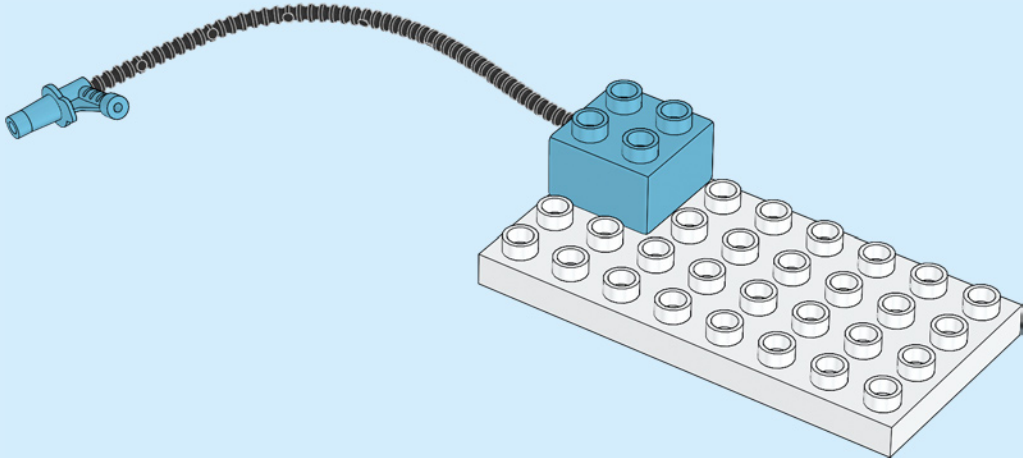

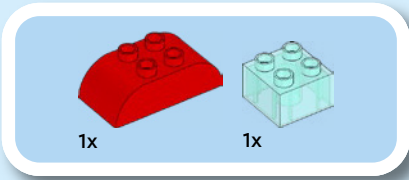

2

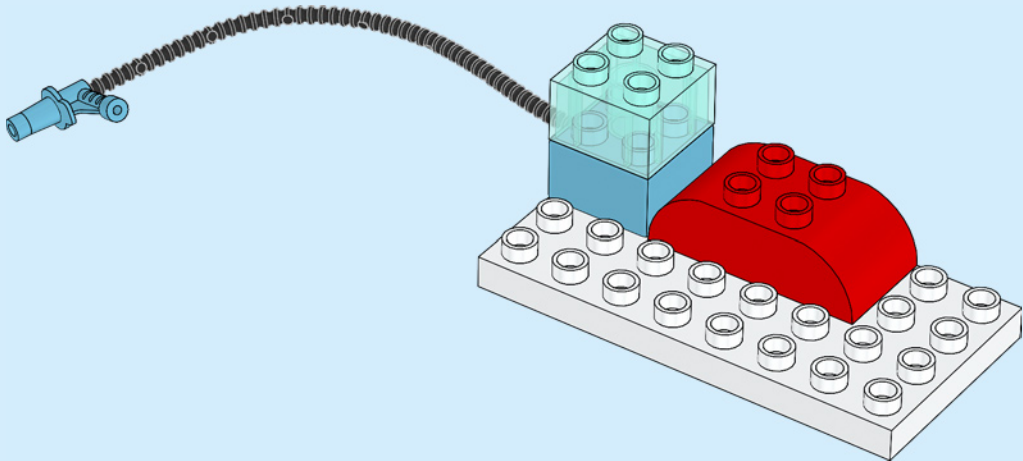

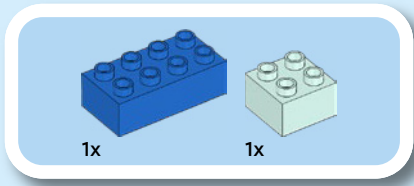

3

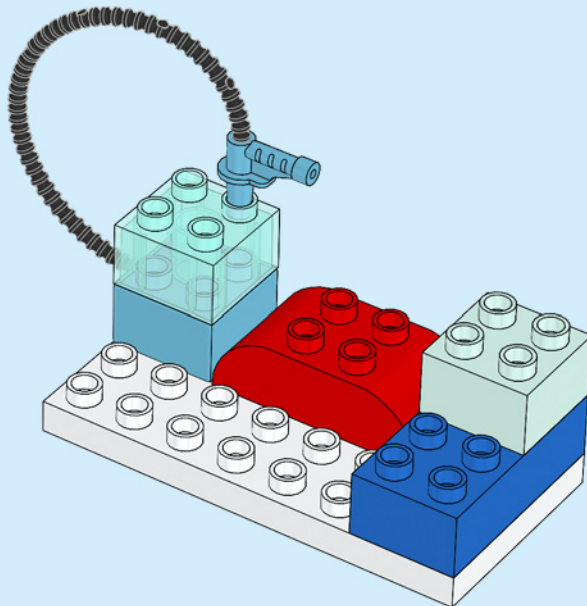

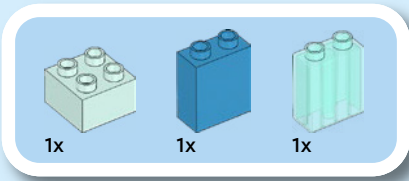

4

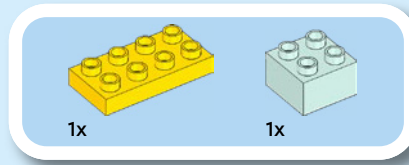
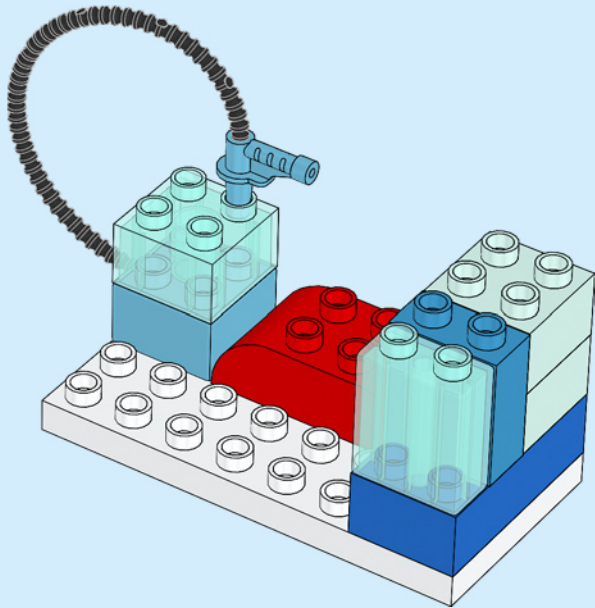

5

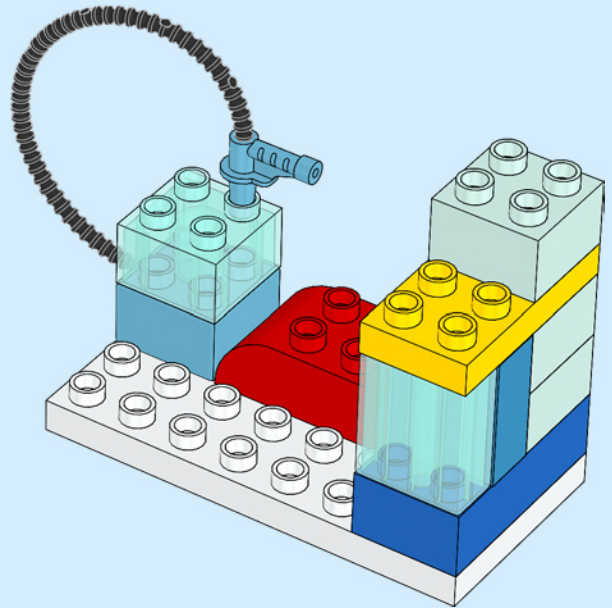

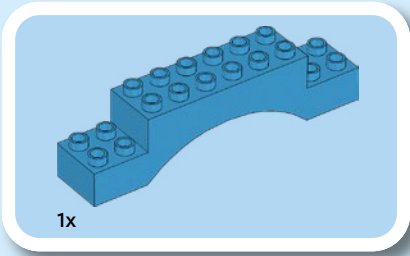

6

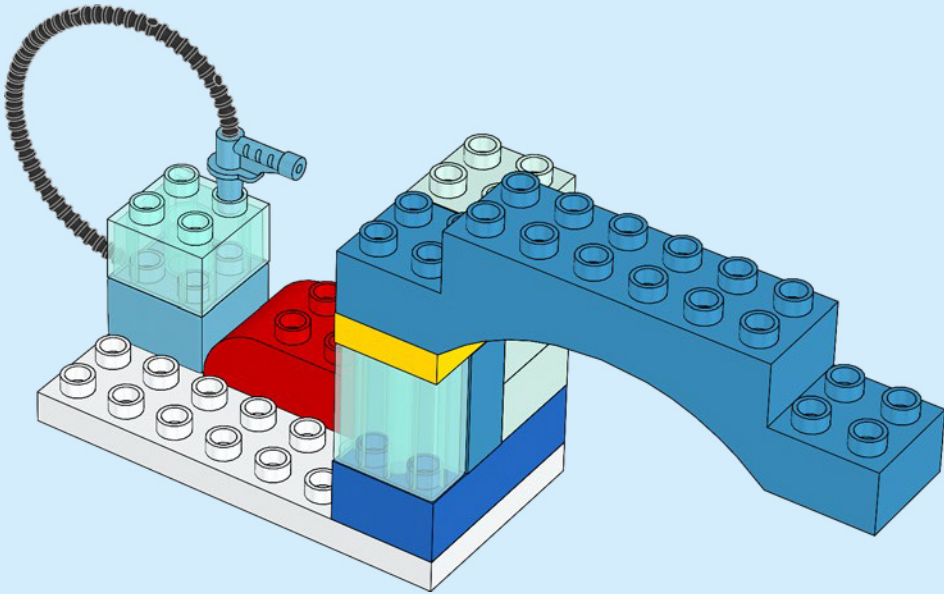

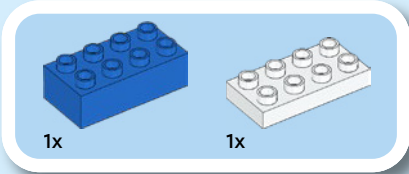
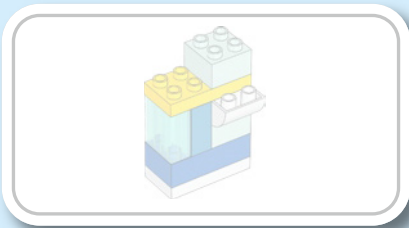

7

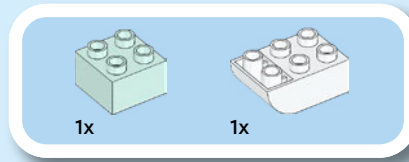
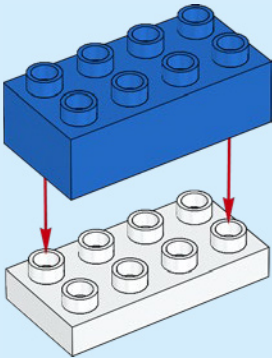

8

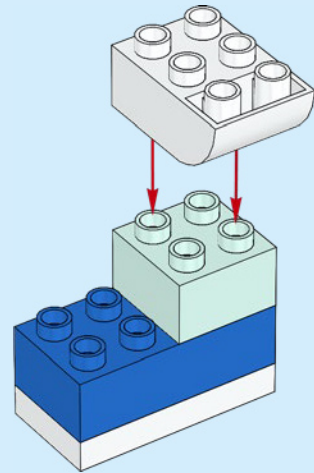

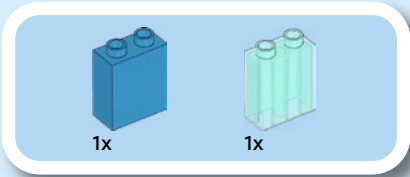

9

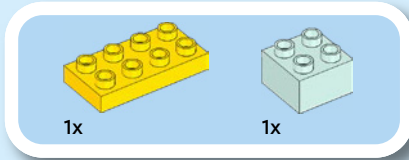
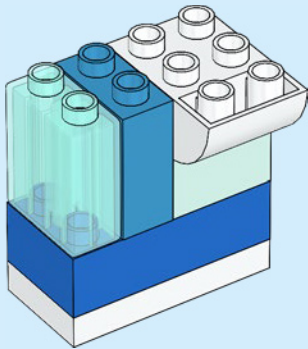

10

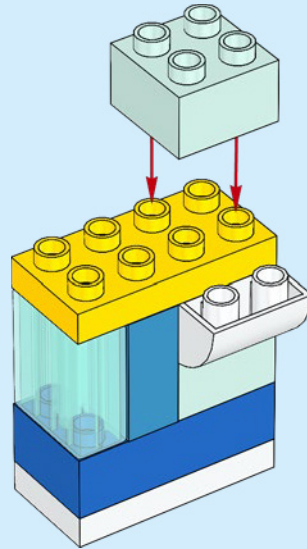

11

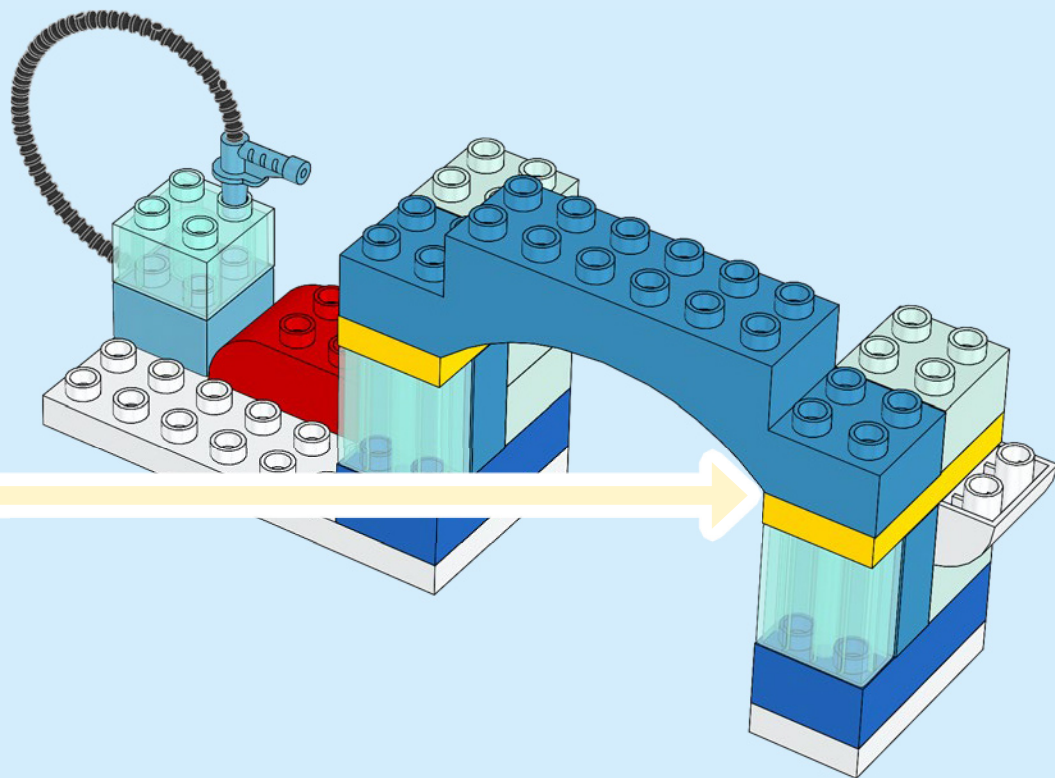

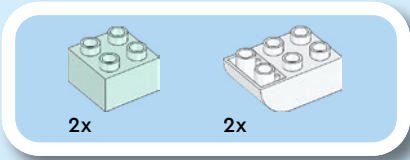

12

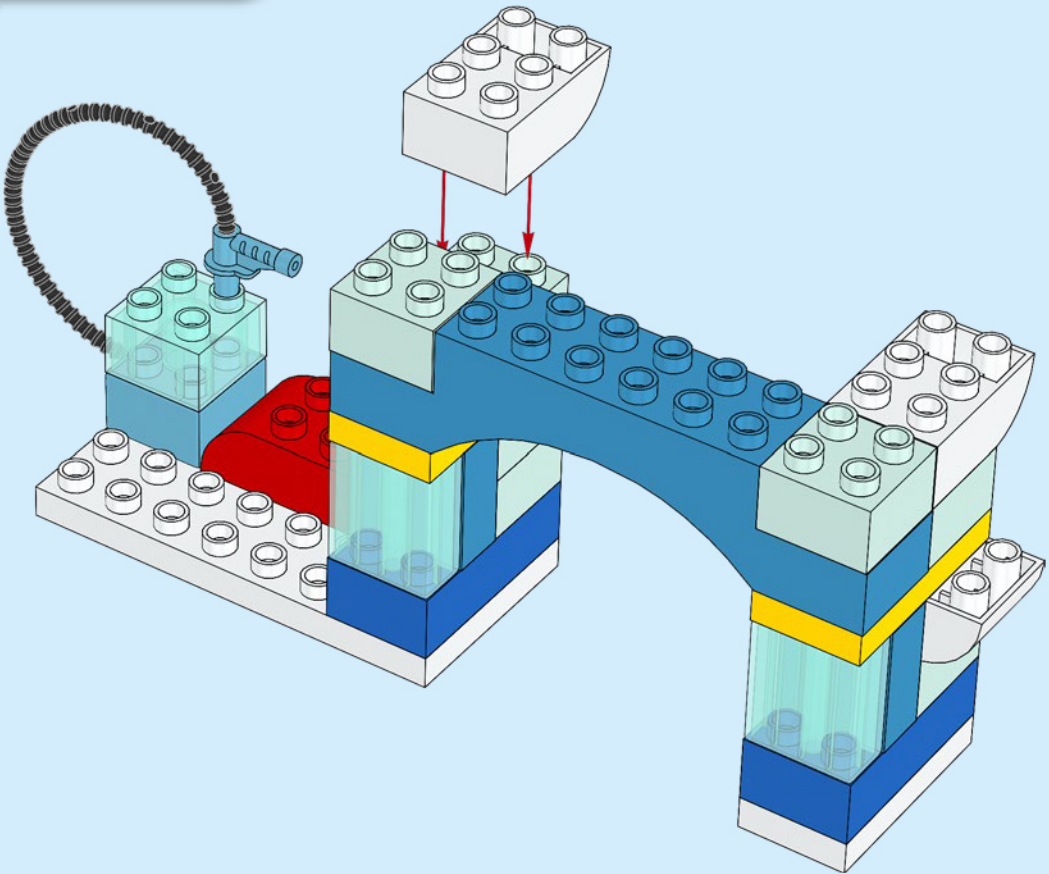

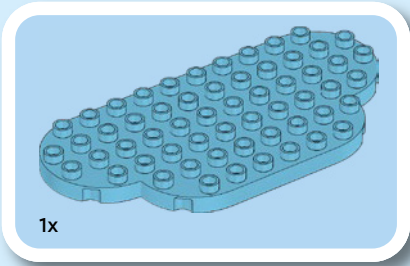

14

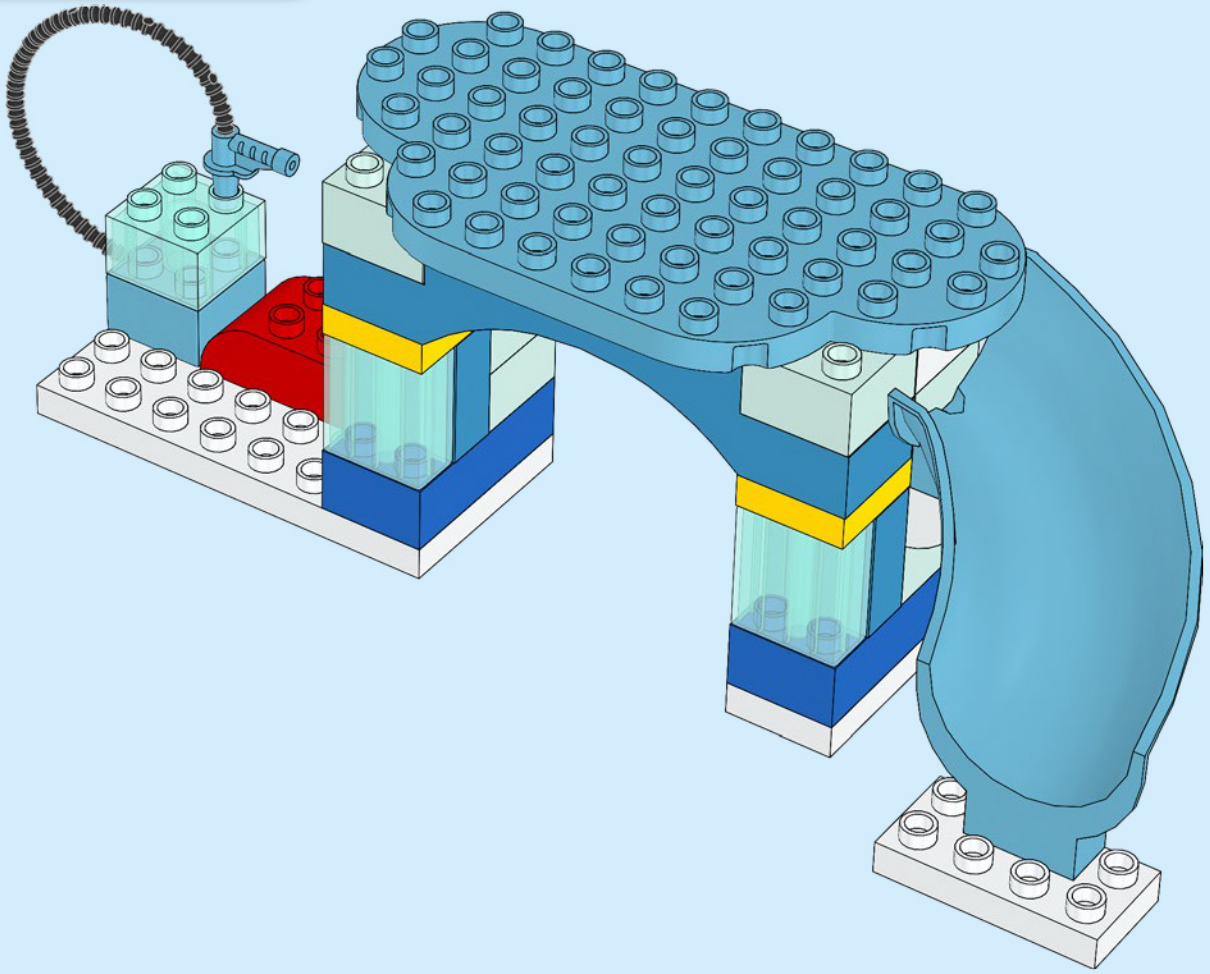

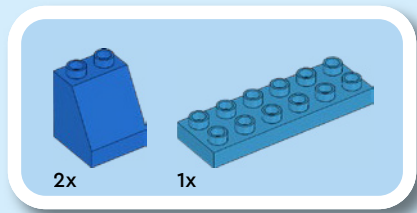

16

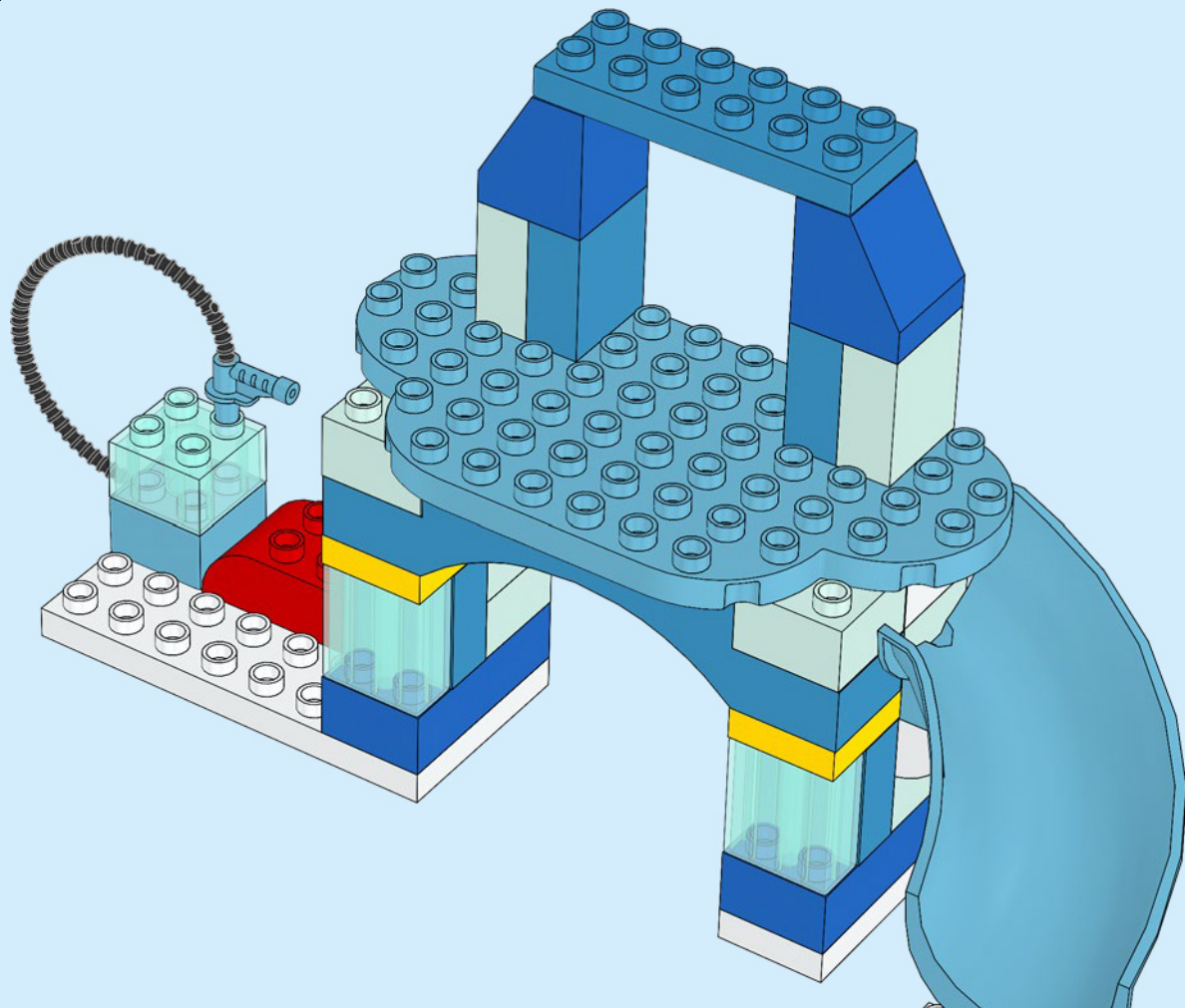

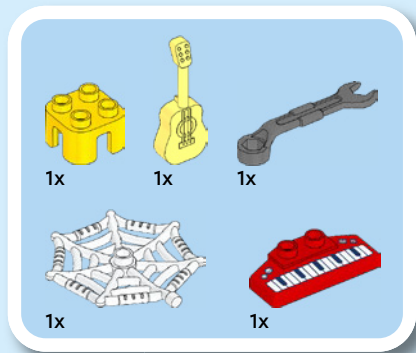

18

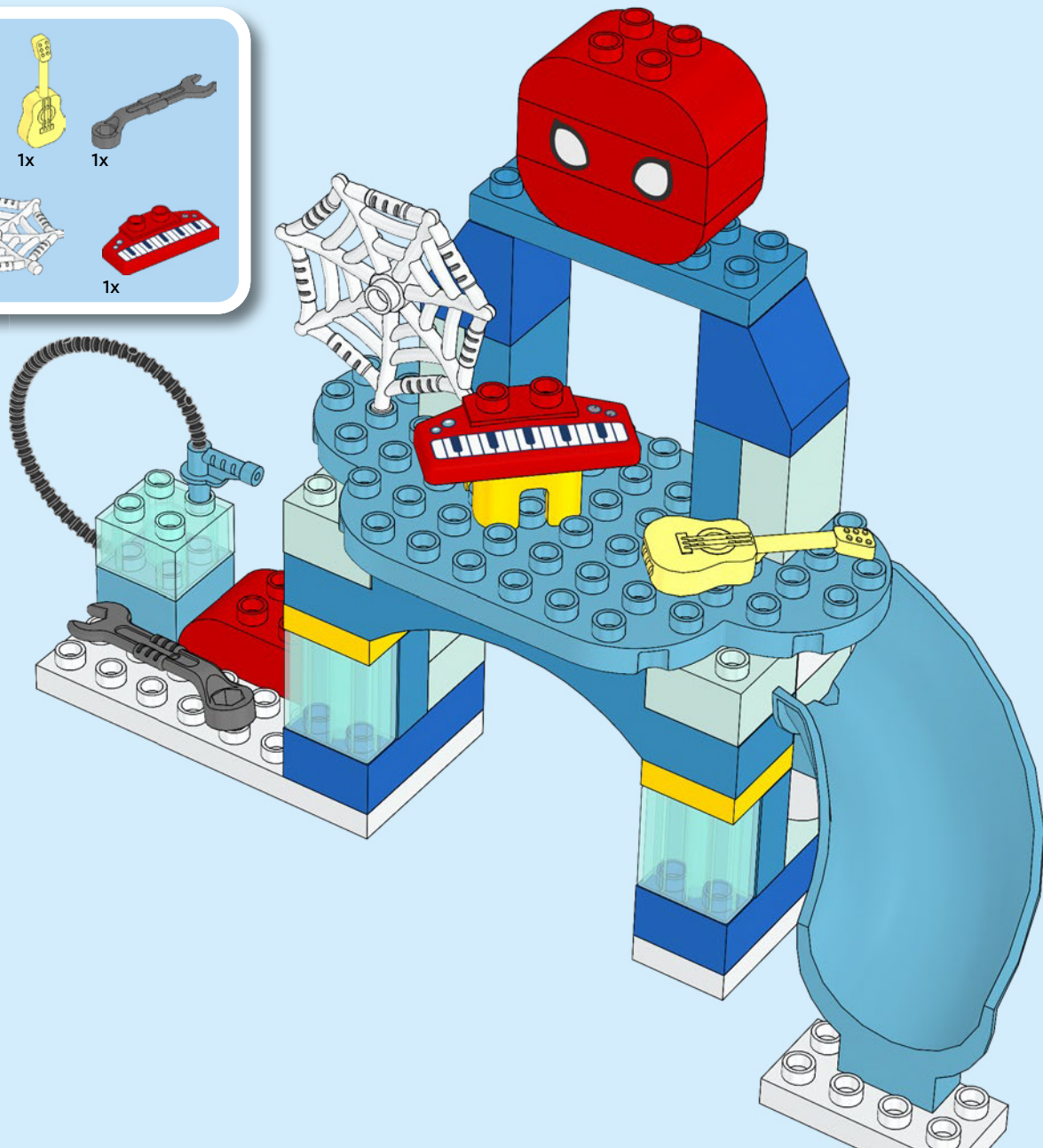



EXPLORE
LEGO® DUPLO®
DIGITAL GAMES

DES JEUX NUMÉRIQUES
LEGO® DUPLO®
À DÉCOUVRIR

EXPLORA LOS
JUEGOS DIGITALES
LEGO® DUPLO®



Download on the
 **App Store**

GET IT ON
 **Google Play**

 **腾讯应用宝**
安卓应用商店

Apple and the Apple logo are trademarks of Apple Inc., registered in the U.S. and other countries and regions. App Store is a service mark of Apple Inc. Google Play and the Google Play logo are trademarks of Google LLC. Tencent and the Tencent logo are trademarks of Tencent Inc.



10465

Disney
MICKEY MOUSE CLUBHOUSE

Disney
FROZEN

10462



10463

MARVEL
SPIDEY AND HIS AMAZING FRIENDS



10464

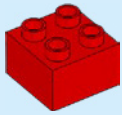

1x
343721

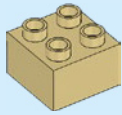

3x
4166963

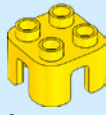

2x
6287579



1x
6210049



1x
6605231



1x
6057566

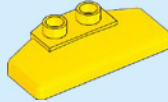

1x
6601070

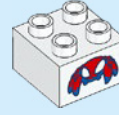

1x
6605233

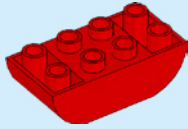

1x
4651503



1x
6602960

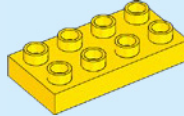

2x
4160152



1x
6605232



1x
6485604

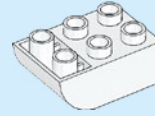

3x
6534145

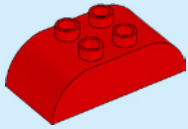

2x
4648243

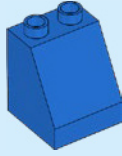

2x
6601061

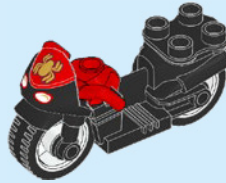

1x
6484346

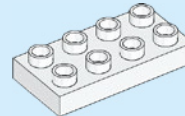

2x
4250172

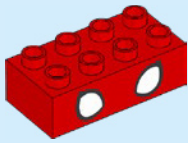

1x
6484341

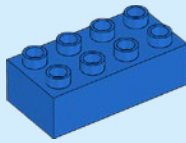

2x
301123

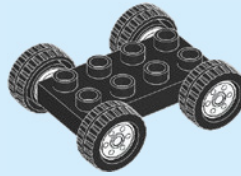

1x
6246965

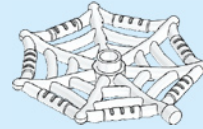

1x
6601063

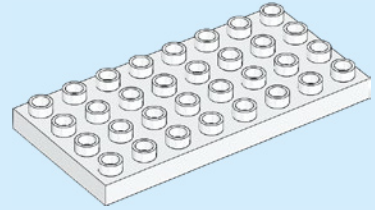

1x
6109109



1x
6294549



1x
6523008



1x
6464781

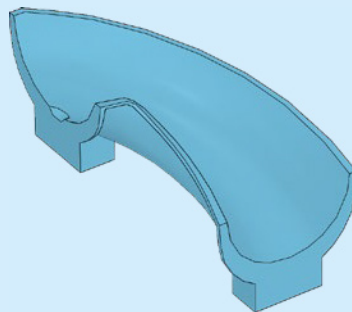

1x
6443794



1x
6605226

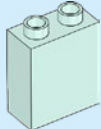

2x
6294211

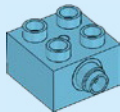

1x
6531639

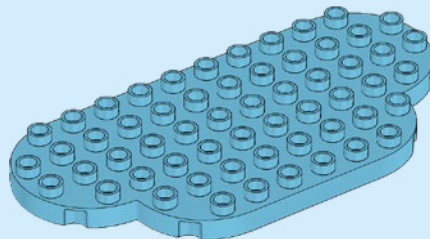

1x
6528792

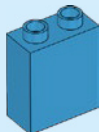

4x
6296049

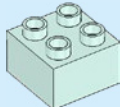

7x
6294237

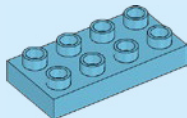

1x
6211342

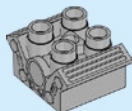

1x
6475209



1x
6563752



2x
6514047

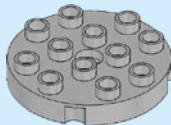

1x
6603681

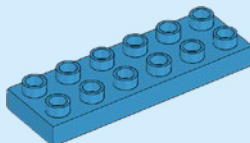

2x
6167685



1x
6580424

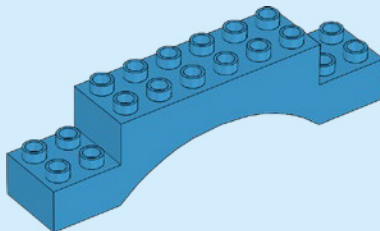

1x
6528793

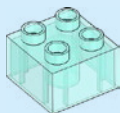

1x
6507900



1x
6464779



 [LEGO.com/service](https://www.LEGO.com/service)

YOU COULD **WIN**

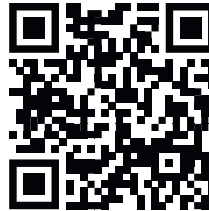

Scan this QR code or go to **LEGO.COM/PRODUCTFEEDBACK** and give us your short feedback about this LEGO® set for a chance to win a cool LEGO prize.

Terms and Conditions apply*

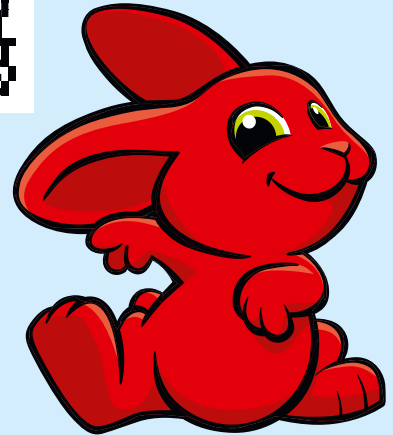

EN: YOU COULD WIN. Terms and Conditions apply* **DE: Du könntest GEWINNEN.** Es gelten die Teilnahmebedingungen* **FR: TU POURRAIS GAGNER.** Des conditions s'appliquent* **IT: Potresti VINCERE tu.** Termini e condizioni sono applicabili* **ES: PUEDES GANAR.** Aplican términos y condiciones* **PT: PODERÁ GANHAR.** Aplicam-se Termos e Condições* **ZH: 轻松获奖. 条款和条件适用*** **PL: Szansa na WYGRANĄ.** Obowiązuje regulamin* **CS: Máte šanci VYHRÁT.** Platí všeobecné smluvní podmínky* **SK: Máte šancu VYHRAŤ.** Platia všeobecné zmluvné podmienky* **HU: TE IS NYERHETSZ!** Felhasználási feltételek érvényesek* **UA: ВИ МОЖЕТЕ ВИГРАТИ.** Застосовуються загальні положення та умови* **RO: Ai putea CÂȘTIGA.** Se aplică termenii și condiții* **BG: Можете да СПЕЧЕЛИТЕ.** Има определени правила и условия* **LV: Tu vari LAIMĒT.** Ir spēkā noteikumi un nosacījumi.* **ET: Sul on võimalus VÕITA.** Kehtivad tingimused* **LT: Jūs galite LAIMĖTI.** Taikomos sąlygos* **TR: KAZANABİLİRSİN.** Şartlar ve Koşullar geçerlidir*

*[LEGO.com/productfeedback-terms](https://www.lego.com/productfeedback-terms)

LEGO, the LEGO logo, DUPLO and the DUPLO logo are trademarks of the/son des marques de commerce du/son marcas registradas de LEGO Group. ©2026 The LEGO Group.

© 2026 MARVEL

 6645866