

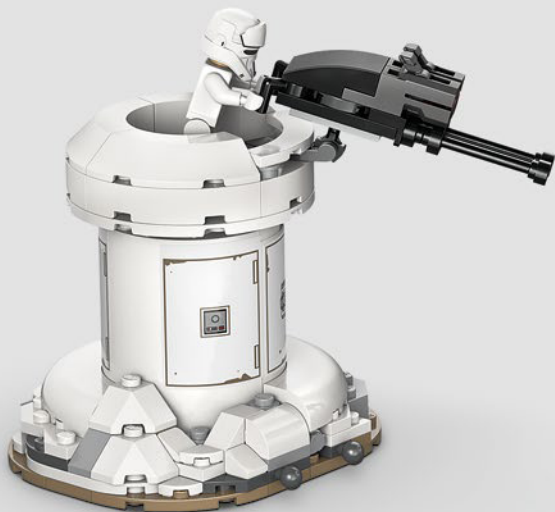

# STAR WARS™

75444



1



LEGO® Builder



### **Get excited about our new packaging!**

We're switching from plastic to paper-based packaging. That's why you might find a mix of paper and plastic in our boxes!

### **Nos nouveaux emballages vous emballeront !**

Nous passons des emballages en plastique aux emballages à base de papier. C'est pourquoi vous pourriez trouver un mélange de papier et de plastique dans nos boîtes !

### **¡Te presentamos nuestros nuevos empaques!**

Estamos sustituyendo las bolsas de plástico por bolsas con base de papel. ¡Por eso, puedes encontrar una mezcla de papel y de plástico en nuestras cajas!

**[LEGO.com/sustainable-packaging](https://www.lego.com/sustainable-packaging)**

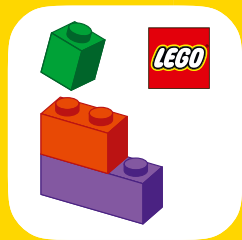

LEGO® Builder



# BUILDER



Apple and the Apple logo are trademarks of Apple Inc., registered in the U.S. and other countries and regions. App Store is a service mark of Apple Inc. Google Play and the Google Play logo are trademarks of Google LLC. Tencent and the Tencent logo are trademarks of Tencent Inc.

[LEGO.com/devicecheck](http://LEGO.com/devicecheck)

EN Ask parents' permission before going online | DE Eltern um Erlaubnis bitten, bevor du online gehst | FR Demande l'autorisation d'un parent avant d'aller en ligne | IT Chiedi il permesso ai tuoi genitori prima di andare online | ES Pídeles permiso a tus papás antes de conectarte a Internet | PT Pede autorização aos teus pais antes de ficares online | ZH 上网前应先征得父母的同意 | PL Poproś rodziców o zgodę, zanim wejdiesz do Internetu | CS Než půjdeš na internet, požádej rodiče o svolení | SK Skôr než pôjdeš na internet, vypýtaj si povolenie od rodičov | HU Kérj szülői engedélyt, mielőtt online csatlakoznál! | UA Запитуйте дозволу батьків, перш ніж користуватися інтернетом | RO cere permisiunea părinților înainte de a te conecta online | BG Поискайте разрешение от родител, преди да влезете онлайн | LV Pirms došanās tiešsaistē palūdz atļauju vecākiem | ET Enne Interneti kasutamist küsi vanematelt luba | LT Prieš prisijungdami prie interneto, atsiklauskite tėvų | TR İnternete girmeden önce anne babandan izin iste



1

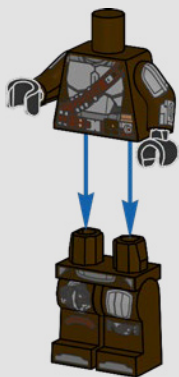

2

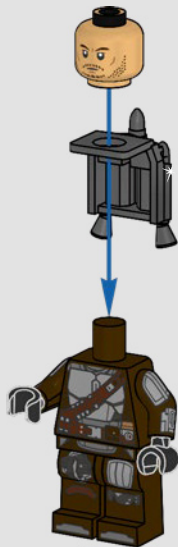

3





1x



1x

1

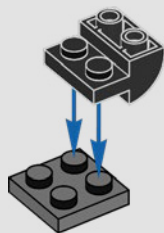

6



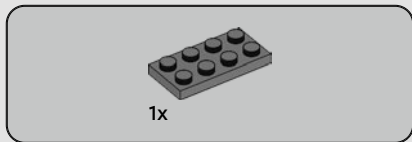

2

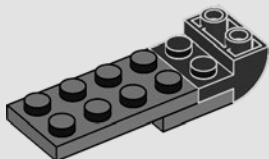

3

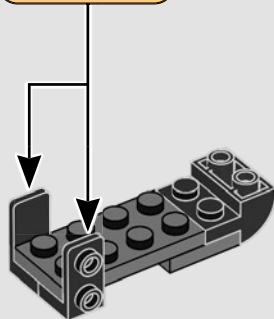

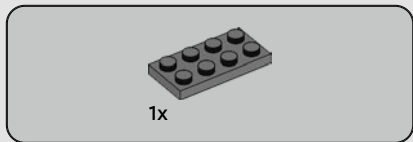

4

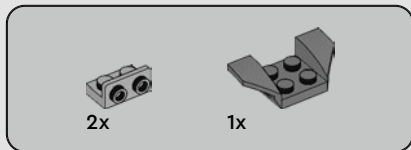
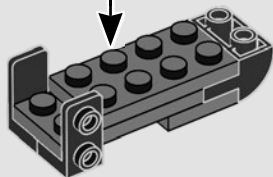
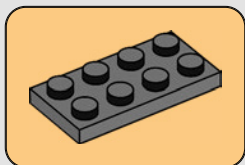

5

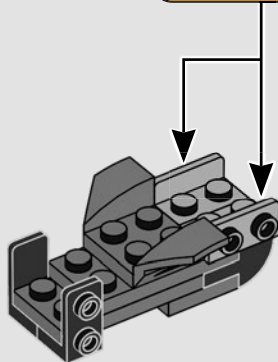
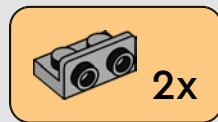



2x

6

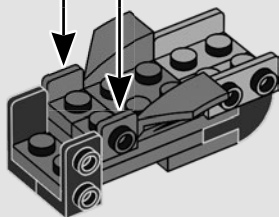

1x



1x

7

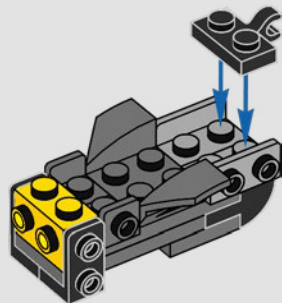

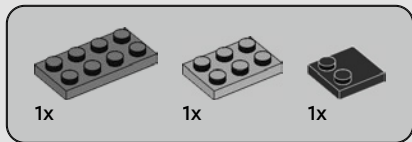

8

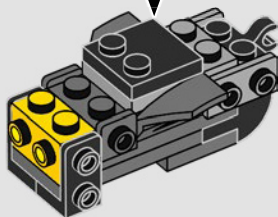
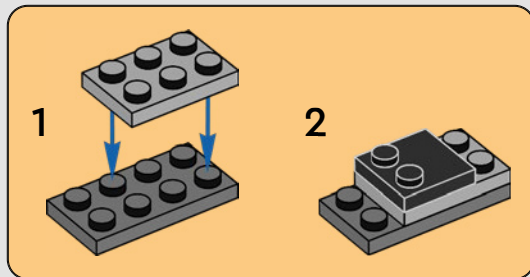



2x

9

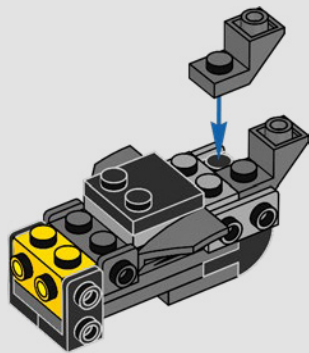

1x

10

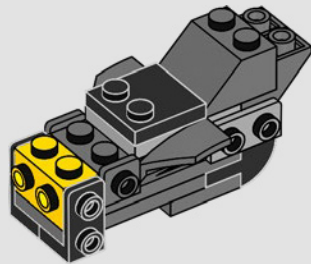



1x

11

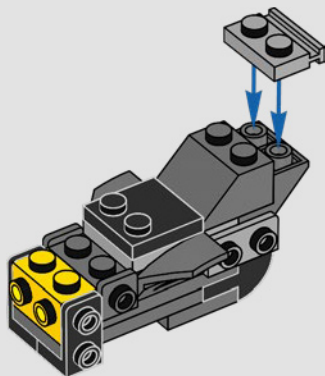

12





2x

12

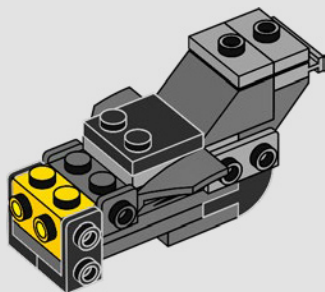

1x

13

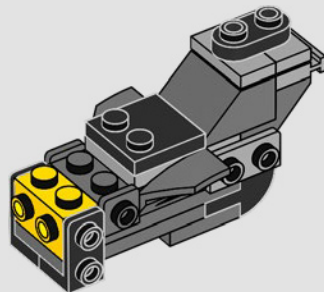



1x



1x

14

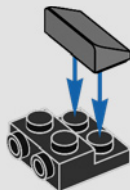

2x

15

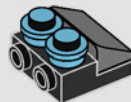



1x

16



2x

17

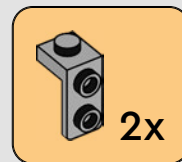

2x

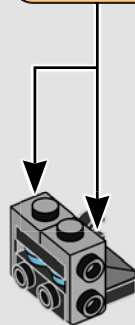



1x

18



16



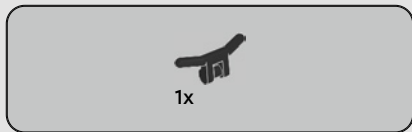

19

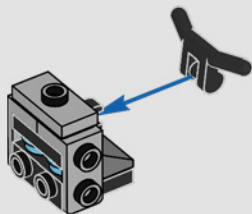

20

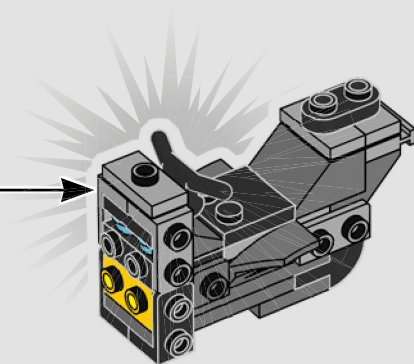



1x



1x

# 21

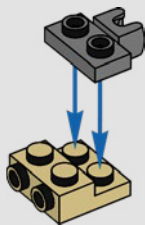

2x

# 22

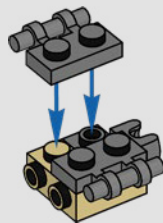



1x

# 23

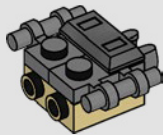

1x

# 24

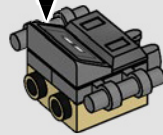
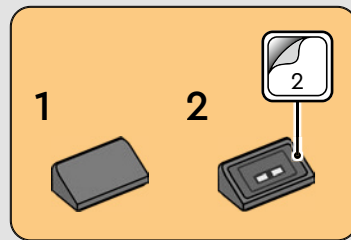



2x

25

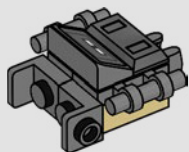

20





1x



1x

# 26

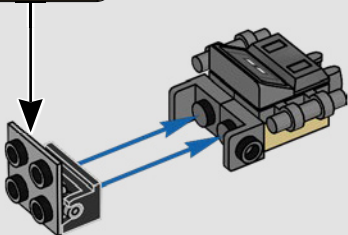
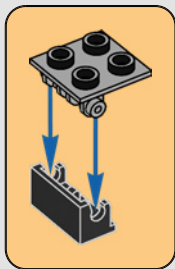

# 27

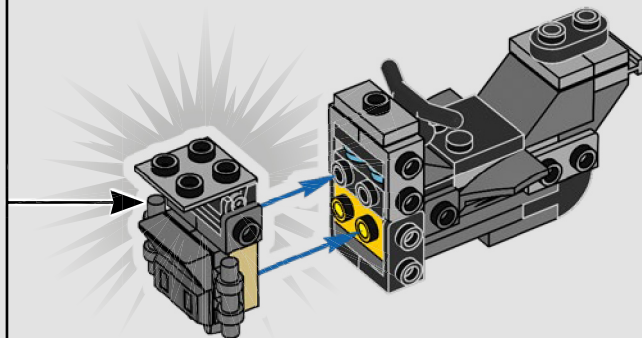

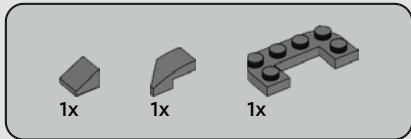

28

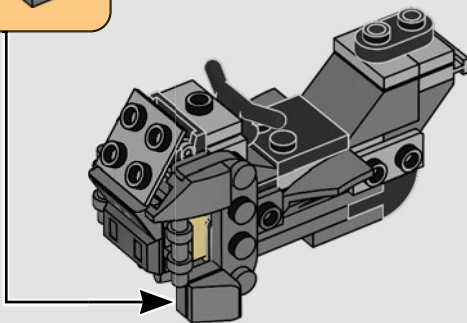
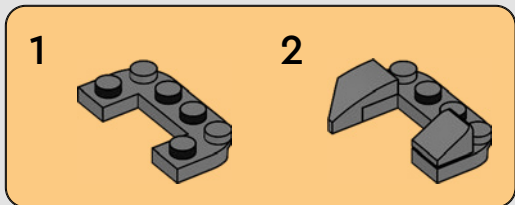



29

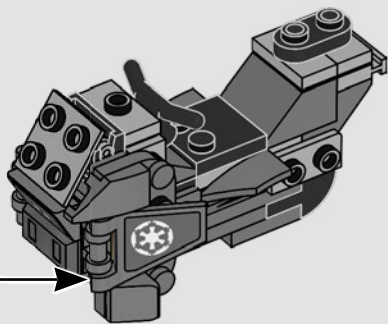
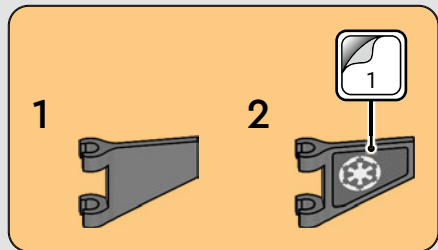

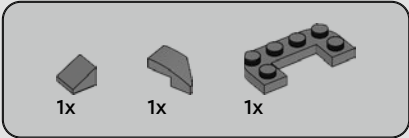

# 30

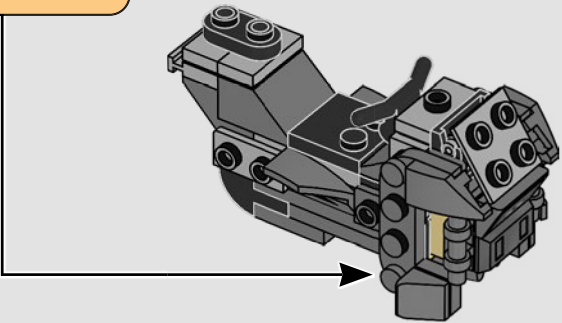
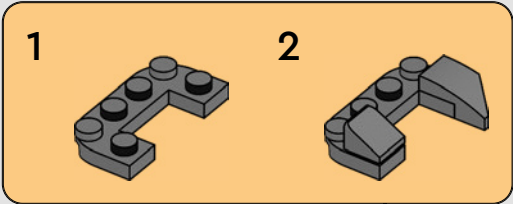

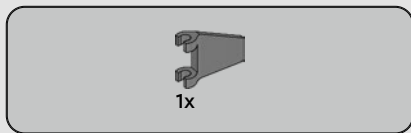

# 31

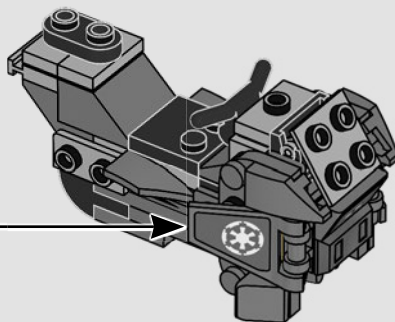
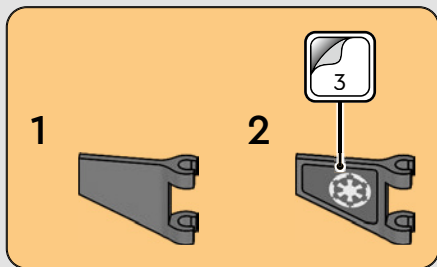

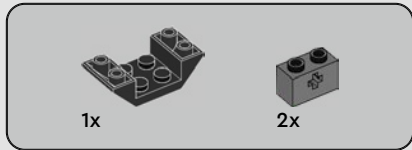

32

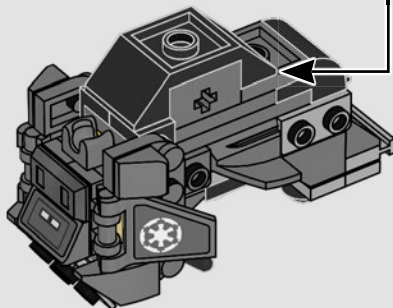
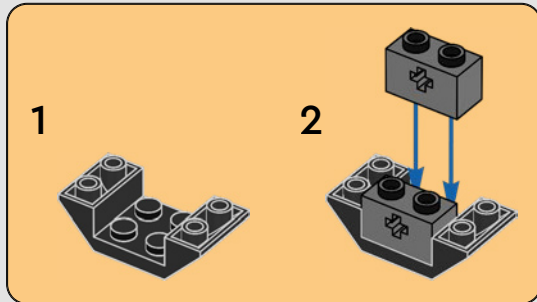

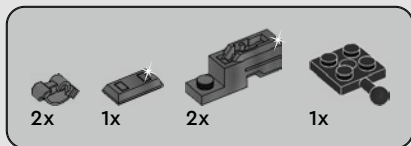

33

1

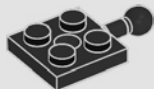

2



3

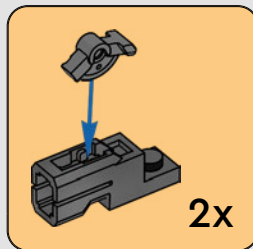
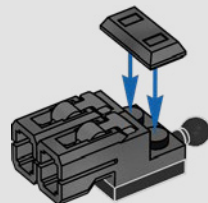

2x



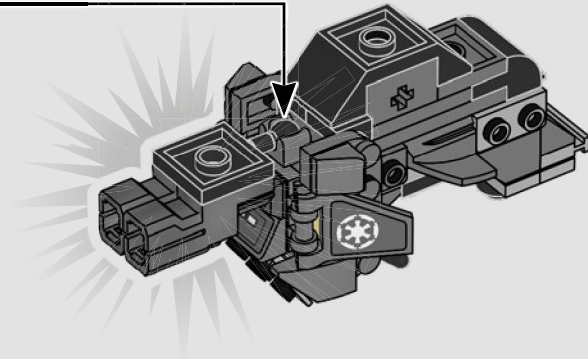

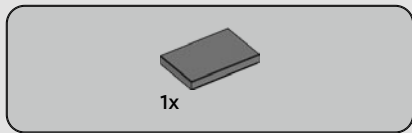

34

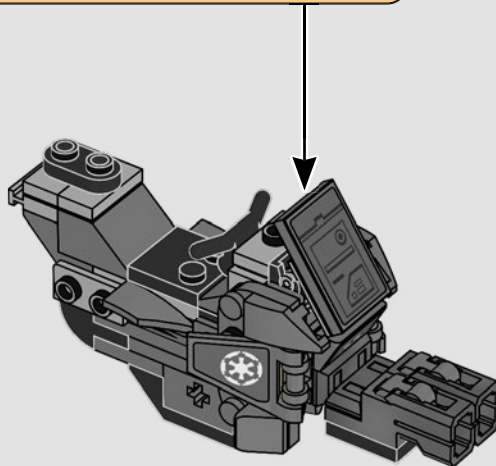
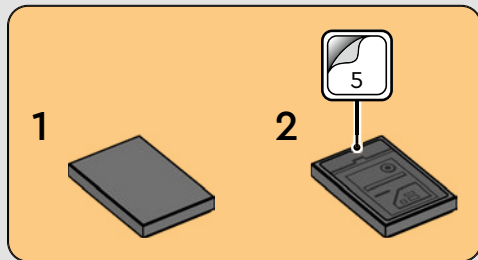

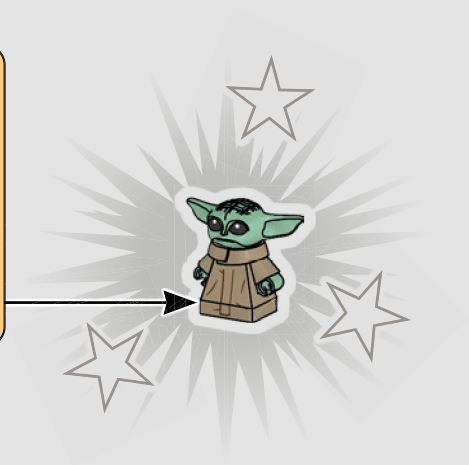
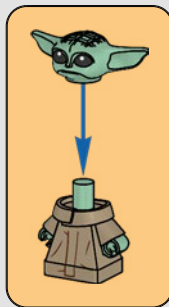



1x



1x

# 35

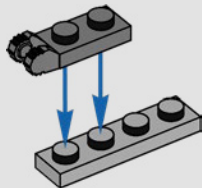

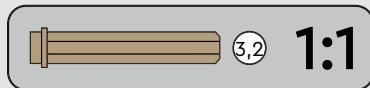
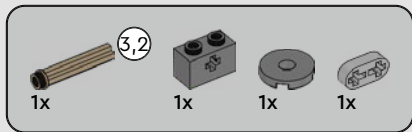

36

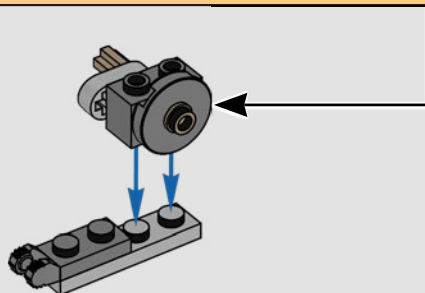
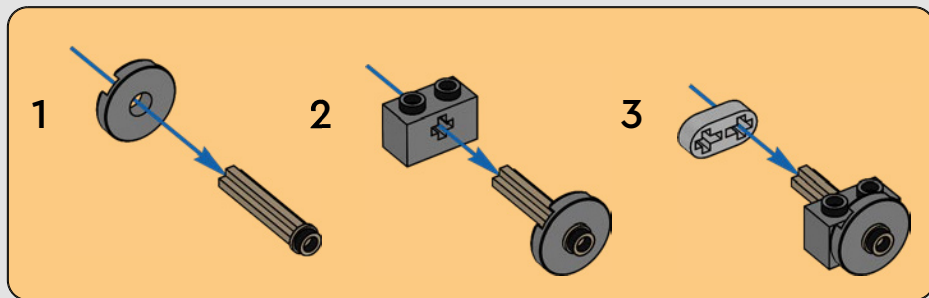



1x



1x

# 37

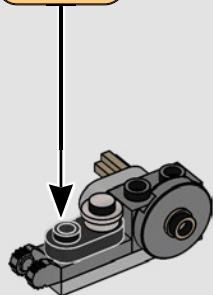
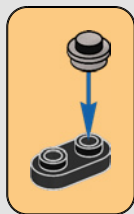

1x

# 38

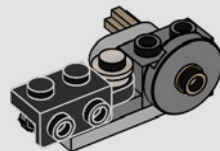

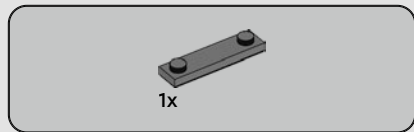

39

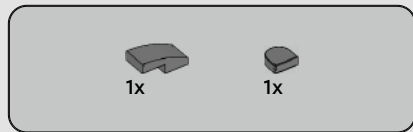
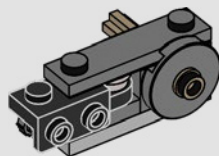

40

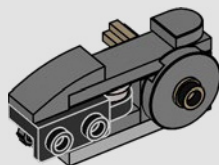



1x



1x

41

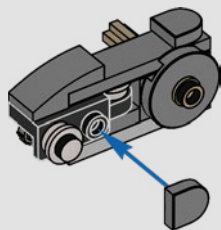

1x

42

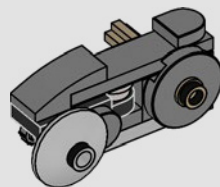

43

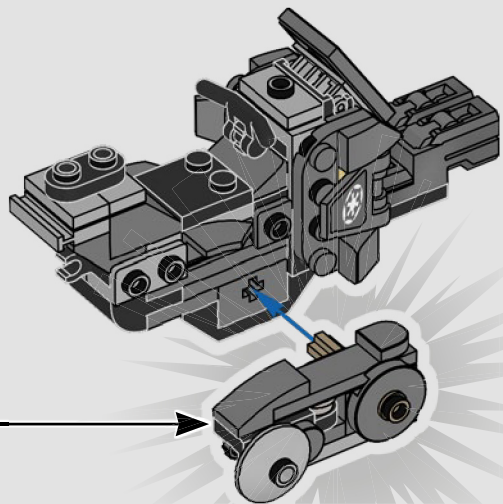

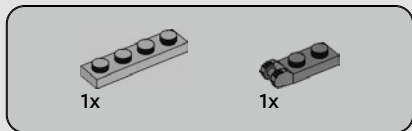
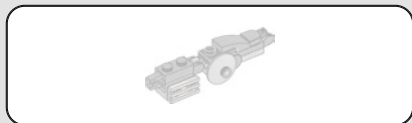

44

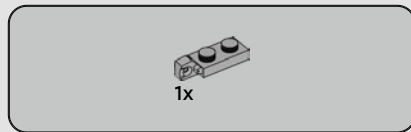
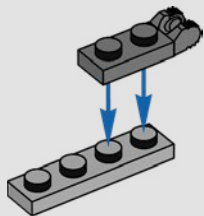

45

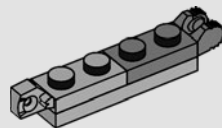



1x

46

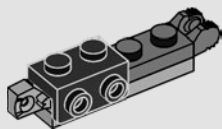

1x



1x

47

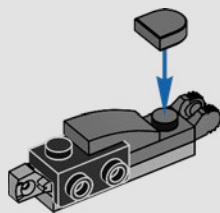



1x



1x

# 48

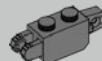
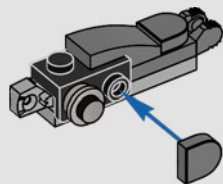

1x

# 49

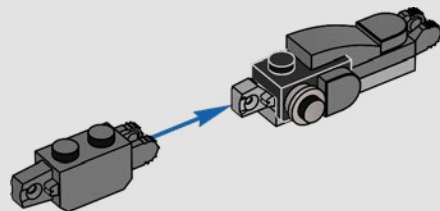



1x



1x

# 50

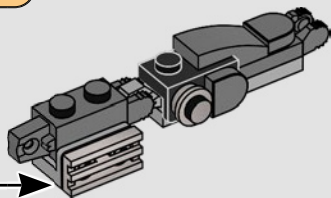
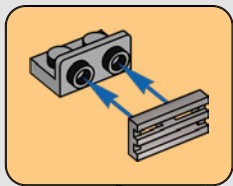

1x

# 51

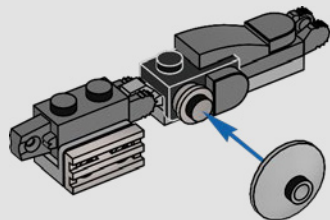

52

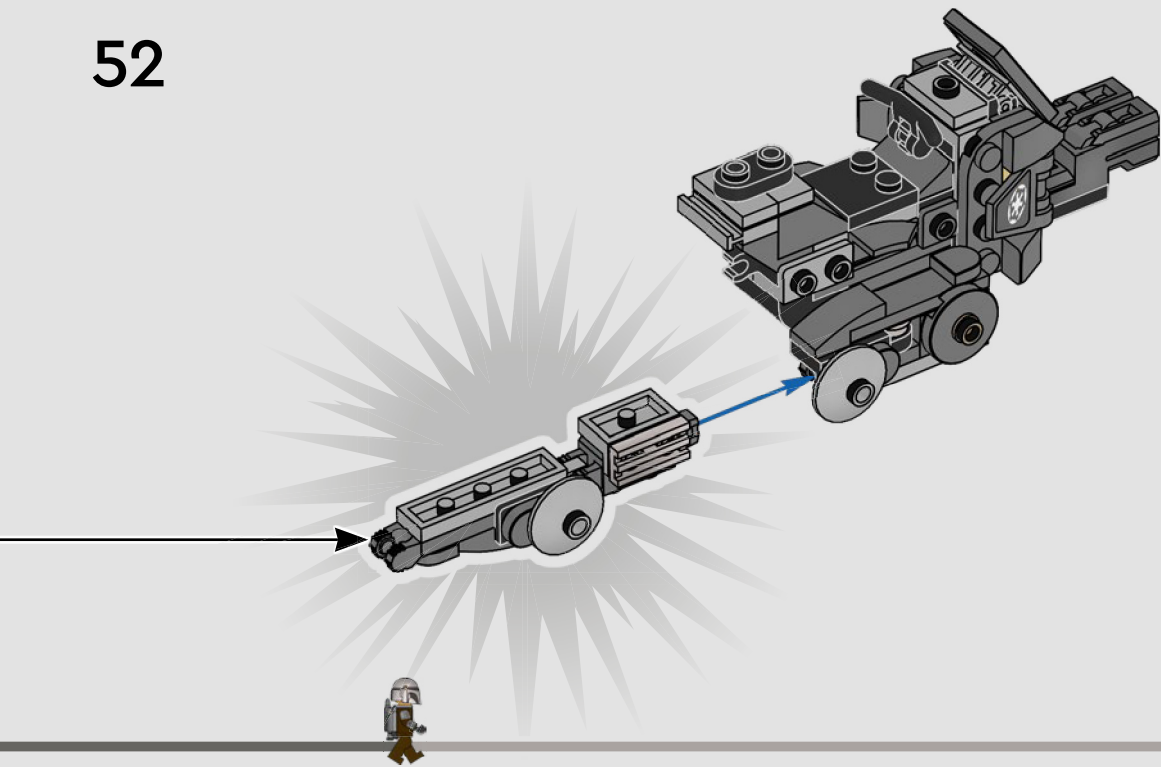



1x



1x

# 53

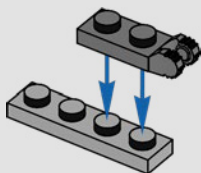

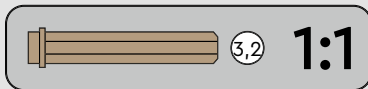
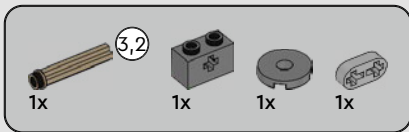

54

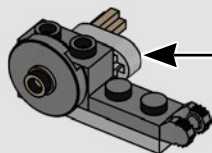
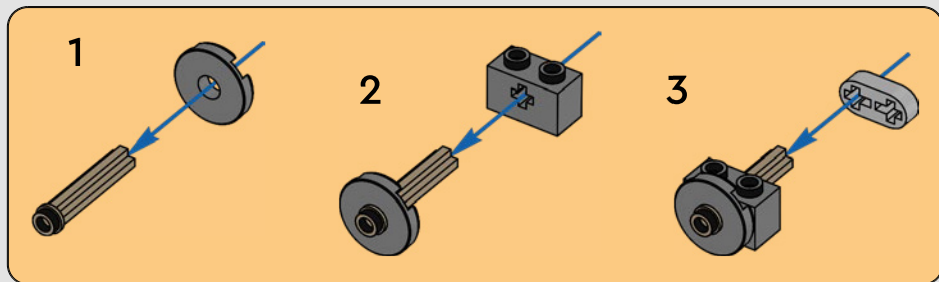



1x



1x

55

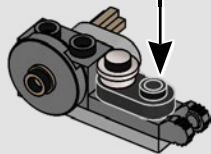
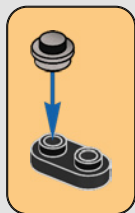

1x

56

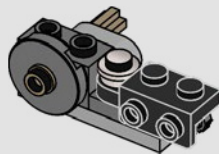

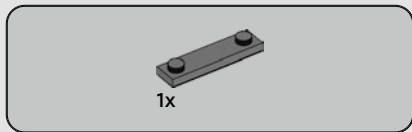

57

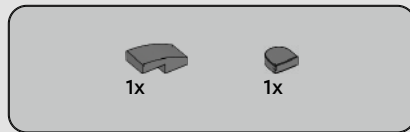
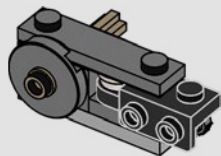

58

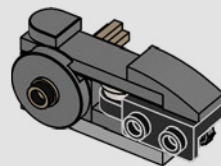



1x



1x

59

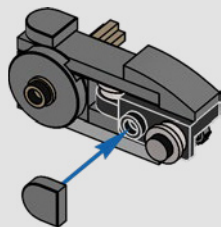

1x

60

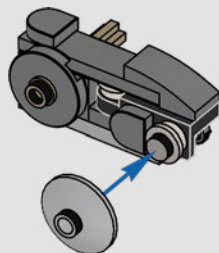

61

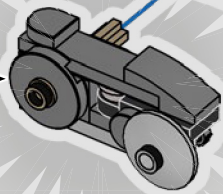
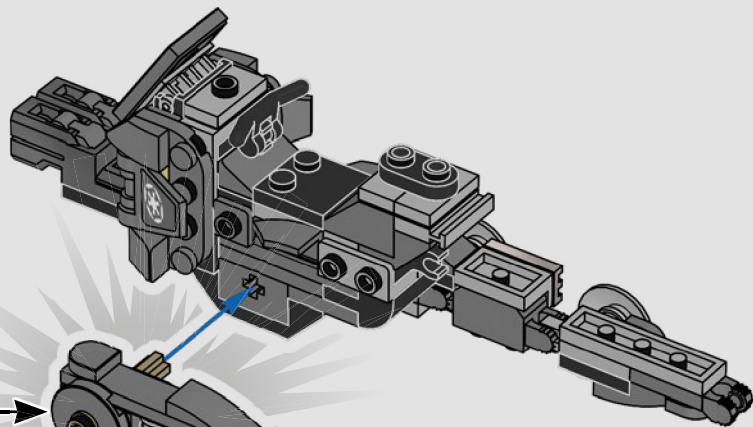

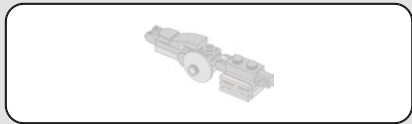

62

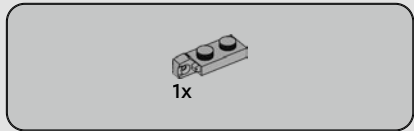
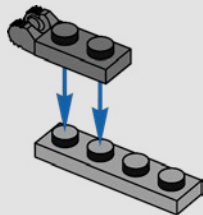

63

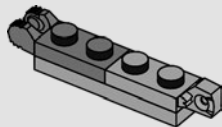



1x

64

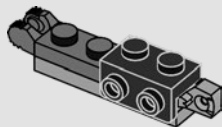

1x



1x

65

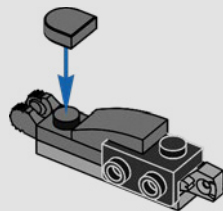



1x



1x

66

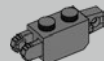
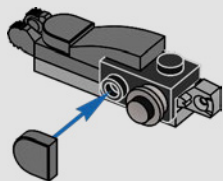

1x

67

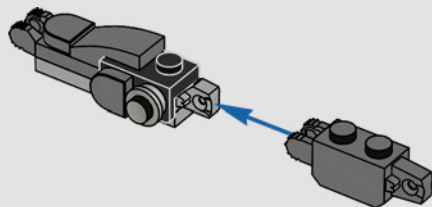



1x



1x

# 68

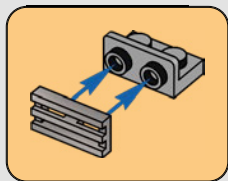
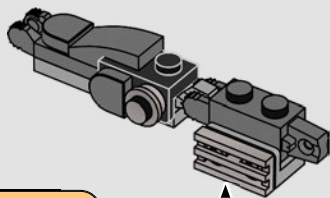

1x

# 69

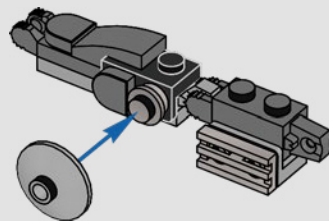

70

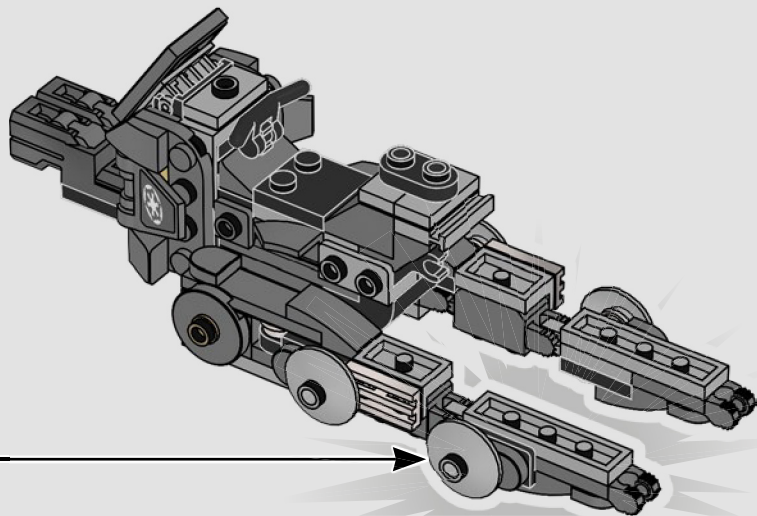



2x



1x



1x

71



1x

72





1x

73

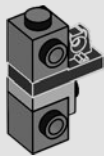

1x

74





75

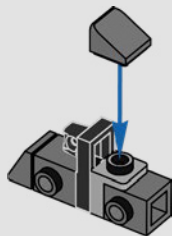

76

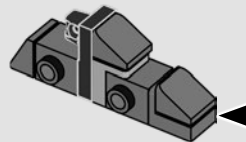
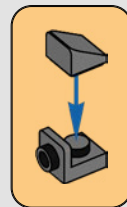

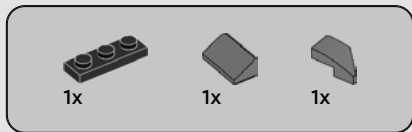

77

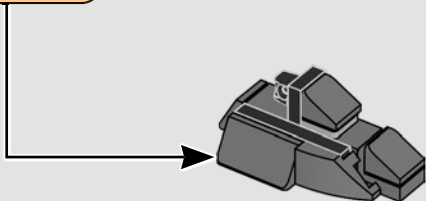
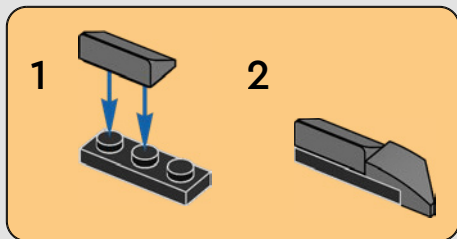

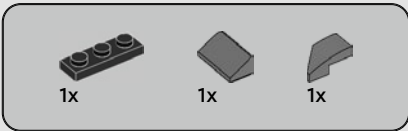

78

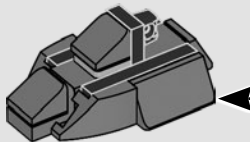
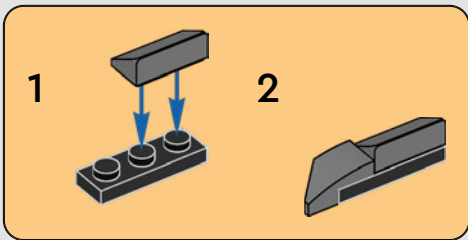

2x



79

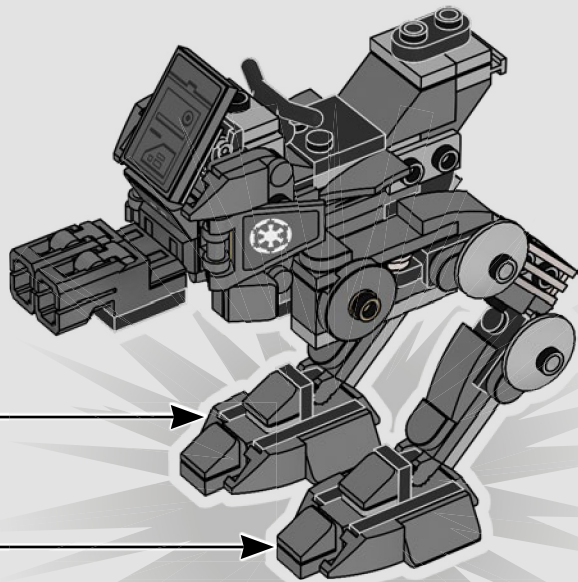



2x



2x



6x

# 80

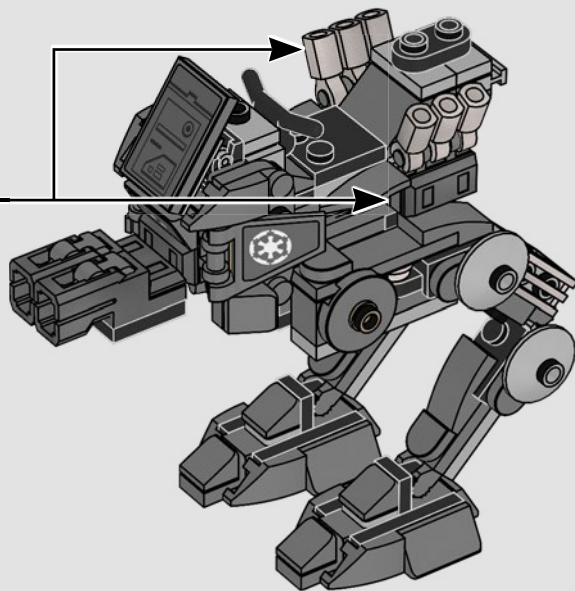
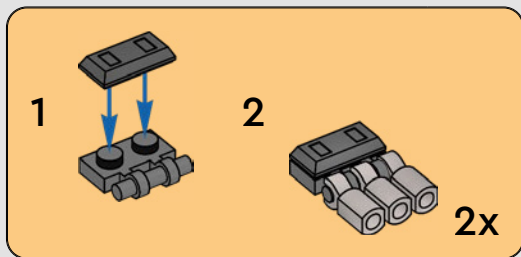

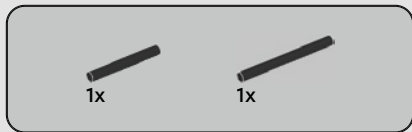

81

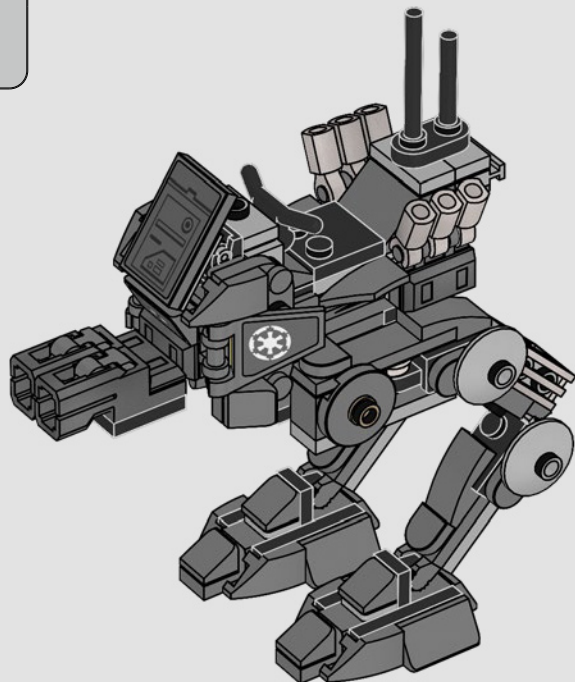

4x

82

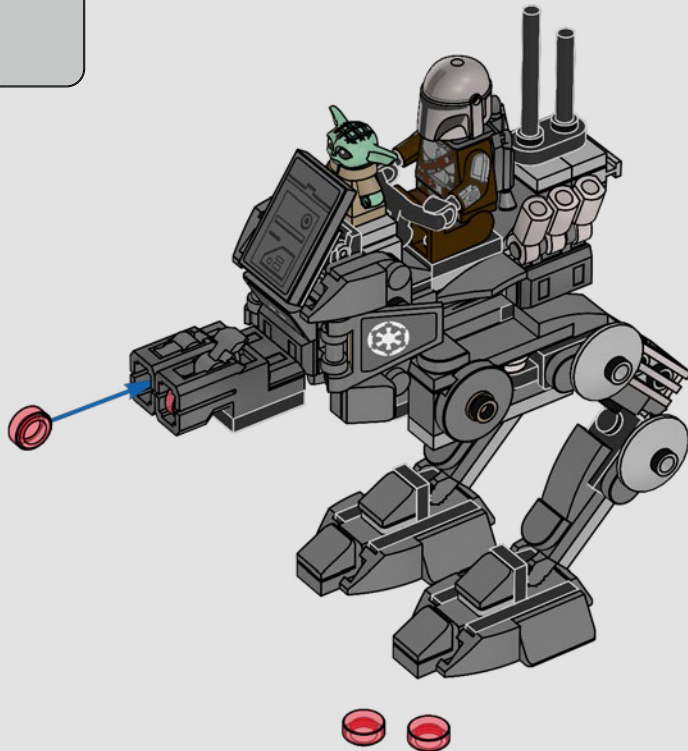

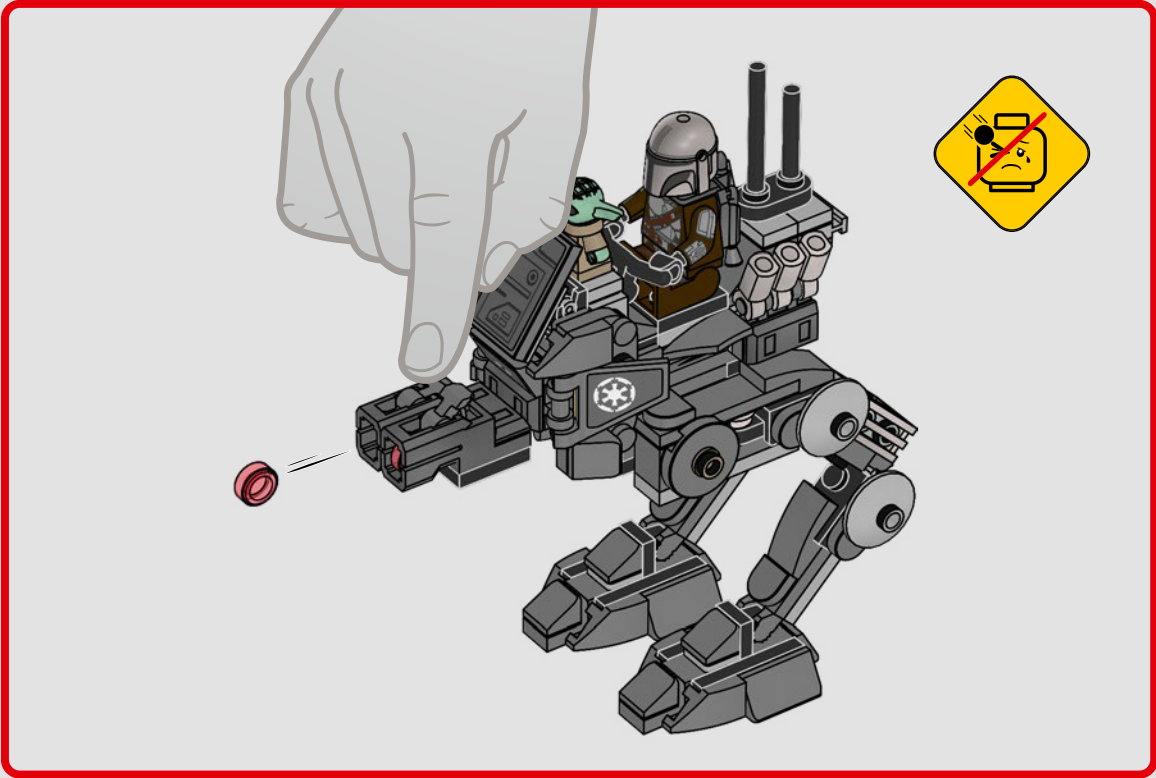

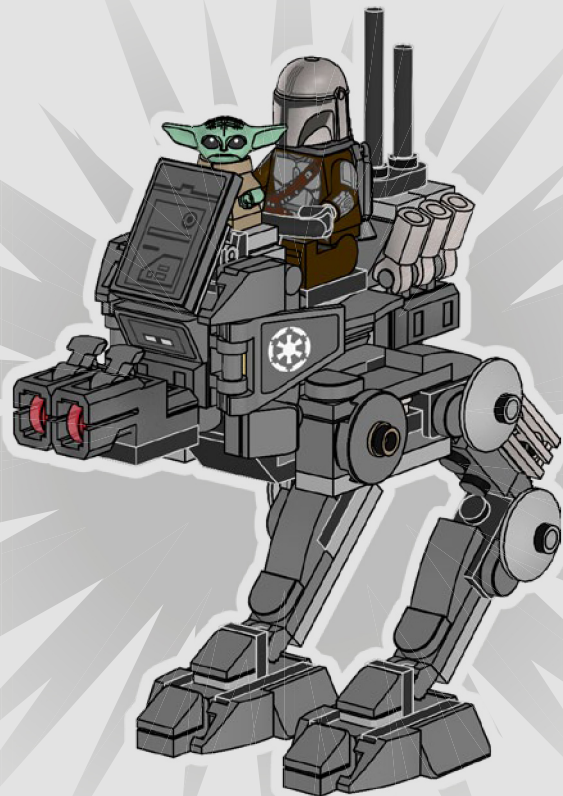



LEGO and the LEGO logo are trademarks of the/son des marques de commerce du/son marcas registradas de LEGO Group. ©2026 The LEGO Group.  
© & ™ Lucasfilm Ltd.



6643272