



CREATOR™

40954



LEGO® Builder



Get excited about our new packaging!

We're switching from plastic to paper-based packaging. That's why you might find a mix of paper and plastic in our boxes!

Nos nouveaux emballages vous emballeront !

Nous passons des emballages en plastique aux emballages à base de papier. C'est pourquoi vous pourriez trouver un mélange de papier et de plastique dans nos boîtes !

¡Te presentamos nuestros nuevos empaques!

Estamos sustituyendo las bolsas de plástico por bolsas con base de papel. ¡Por eso, puedes encontrar una mezcla de papel y de plástico en nuestras cajas!

[LEGO.com/sustainable-packaging](https://www.lego.com/sustainable-packaging)



LEGO® Builder

BUILDER



Apple and the Apple logo are trademarks of Apple Inc., registered in the U.S. and other countries and regions. App Store is a service mark of Apple Inc. Google Play and the Google Play logo are trademarks of Google LLC. Tencent and the Tencent logo are trademarks of Tencent Inc.

[LEGO.com/devicecheck](https://www.lego.com/devicecheck)

EN Ask parents' permission before going online | **DE** Eltern um Erlaubnis bitten, bevor du online gehst | **FR** Demande l'autorisation d'un parent avant d'aller en ligne | **IT** Chiedi il permesso ai tuoi genitori prima di andare online | **ES** Pídeles permiso a tus papás antes de conectarte a Internet | **PT** Pede autorização aos teus pais antes de ficares online | **ZH** 上网前应先征得父母的同意 | **PL** Poproś rodziców o zgodę, zanim wejdiesz do Internetu | **CS** Než půjdeš na internet, požádej rodiče o svolení | **SK** Skôr než pôjdeš na internet, vypýtaj si povolenie od rodičov | **HU** Kérj szülői engedélyt, mielőtt online csatlakoznál! | **UA** Запитуйте дозволу батьків, перш ніж користуватися інтернетом | **RO** Cere permisiunea părinților înainte de a te conecta online | **BG** Поискайте разрешение от родител, преди да влезете онлайн | **LV** Pirms došanās tiešaistē palūdz atļauju vecākiem | **ET** Enne Interneti kasutamist küsi vanematelt luba | **LT** Prieš prisijungdami prie interneto, atsiklauskite tėvų | **TR** İnternete girmeden önce anne babandan izin iste



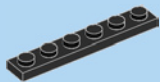

1x



1x

1

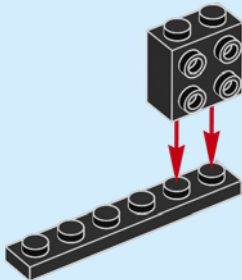

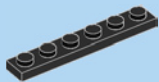

1x



1x

2

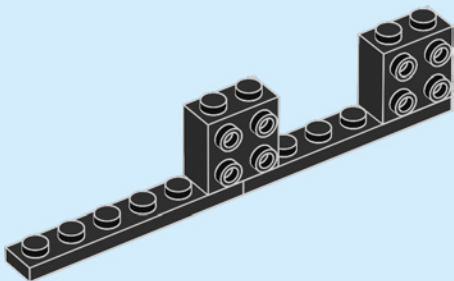

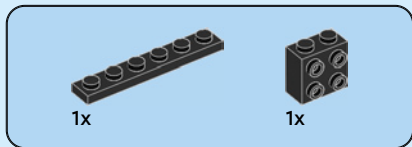

3

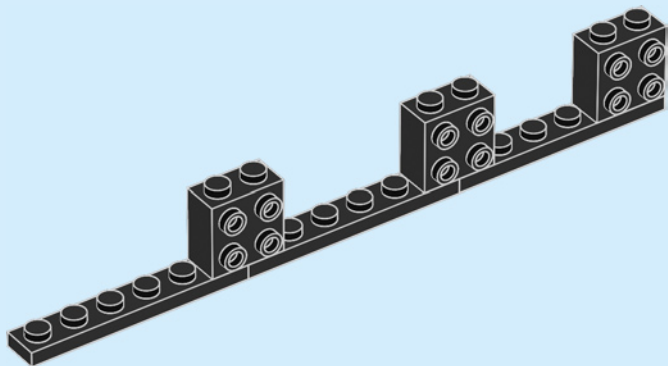



1x

4

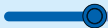
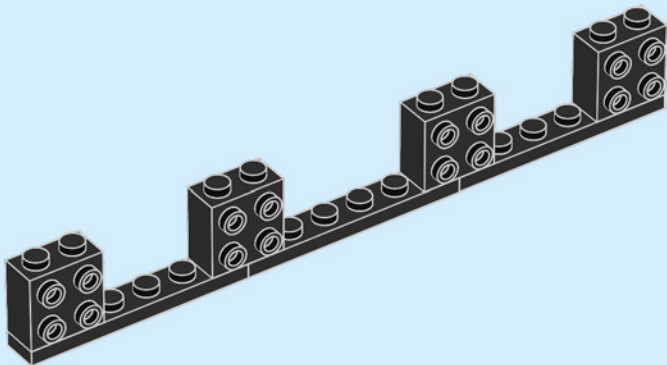



4x

5

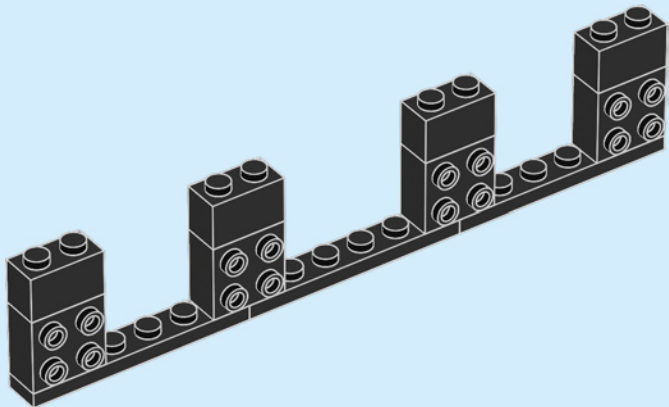

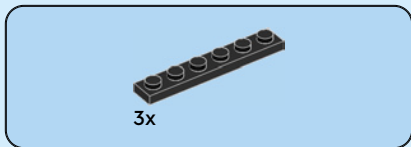

6

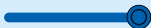
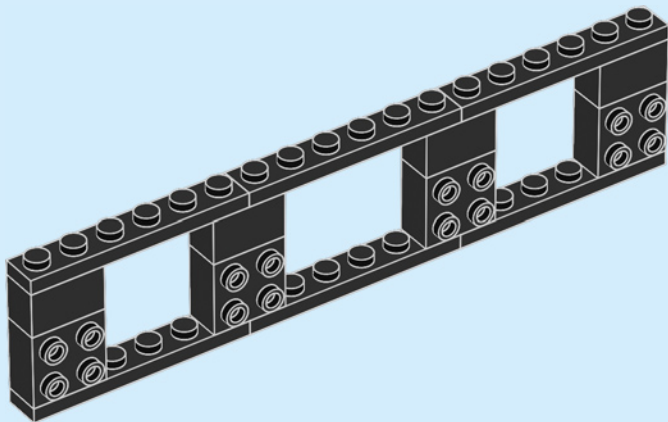

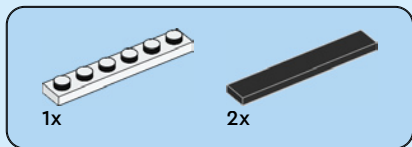

7

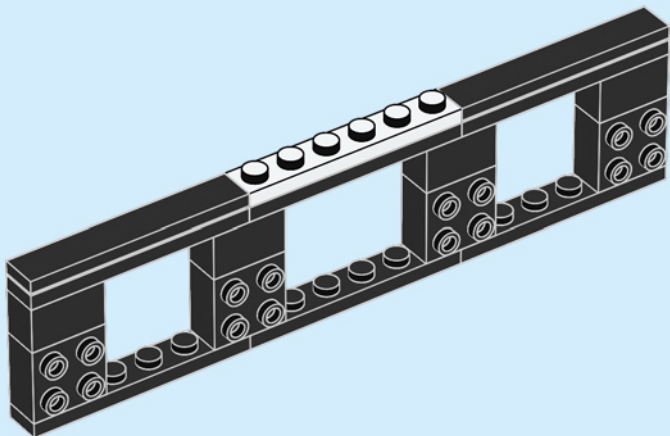

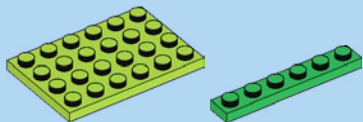

1x

1x

8

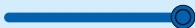
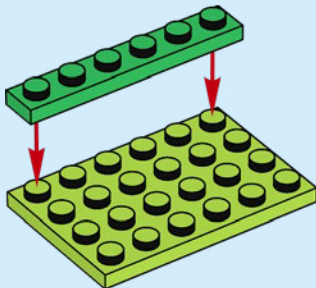



2x



1x

9

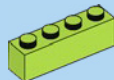
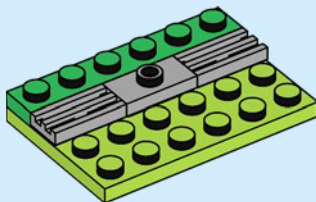

2x



1x

10

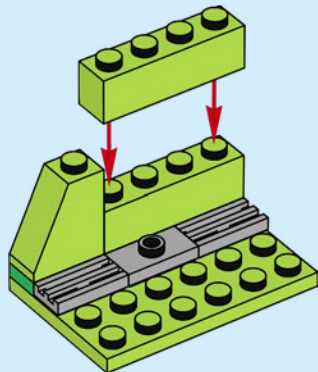



1x



1x



1x



1x



2x

11

1

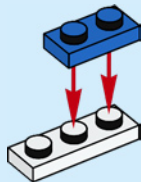

2

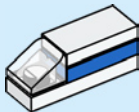

3

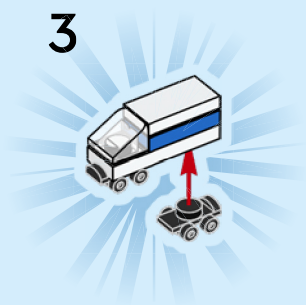

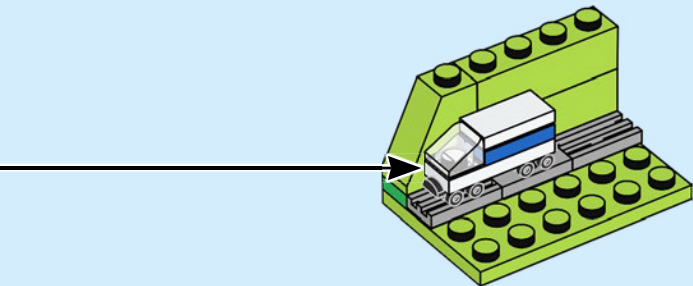

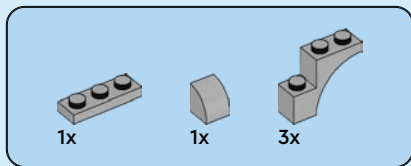

12

1

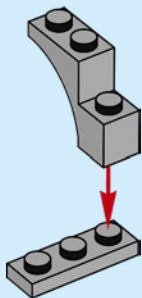

2

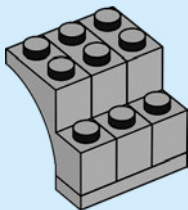

3

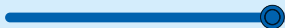
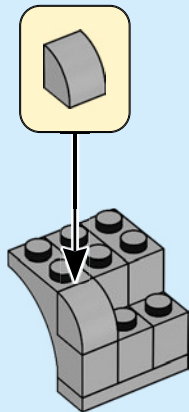

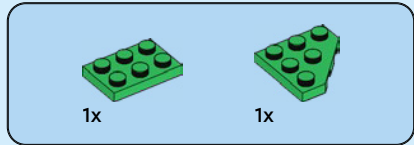
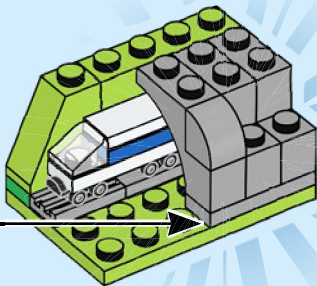

13

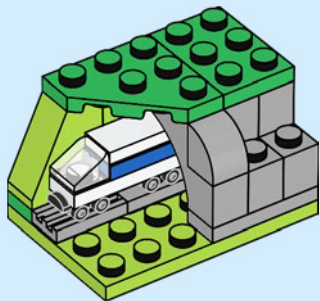



3x



2x

14

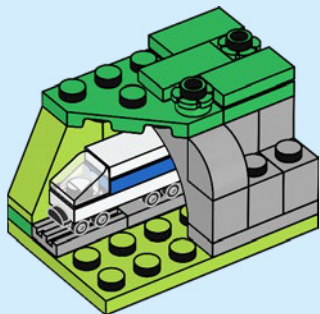

2x



2x

15

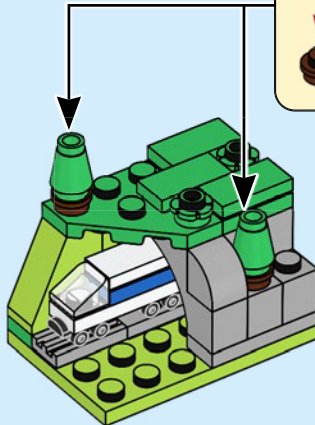

2x

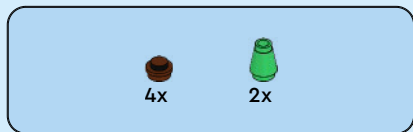

16

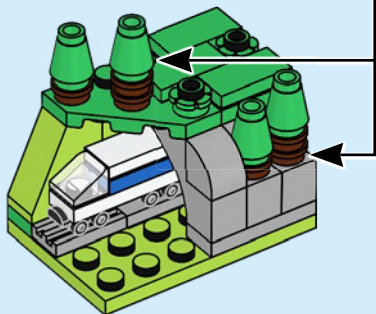
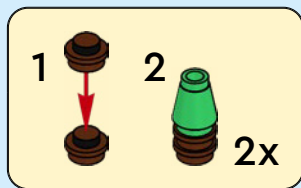



1x



1x



1x

17

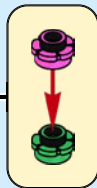
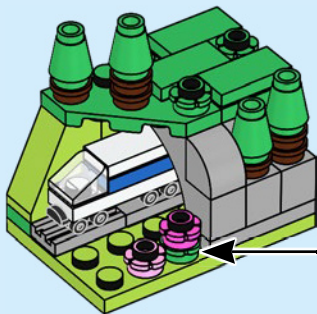

18

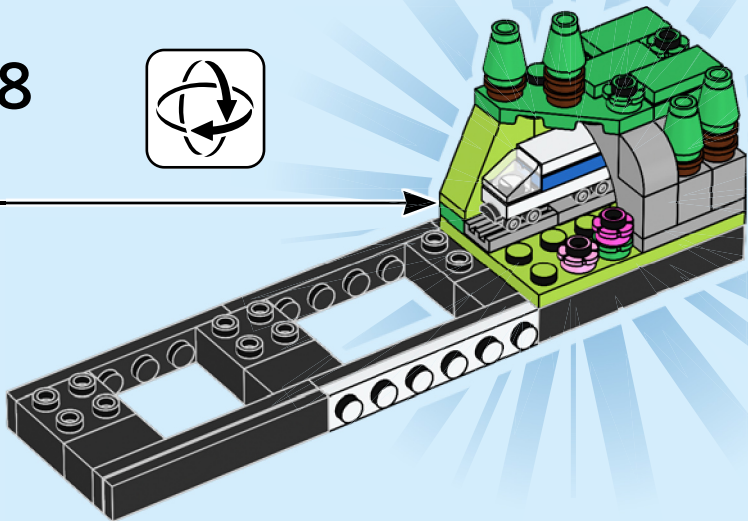



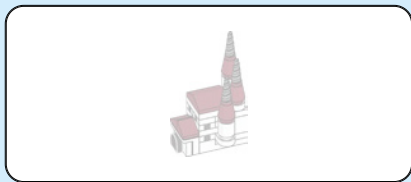

1x



1x

19

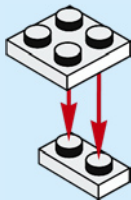



1x

20

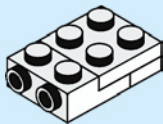

1x

21

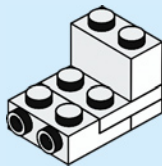



1x



1x



1x

22

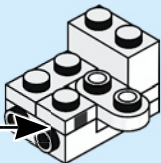

23



1x

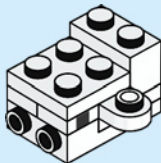



1x



1x

24

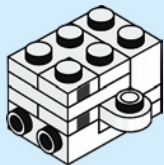



1x



2x

25

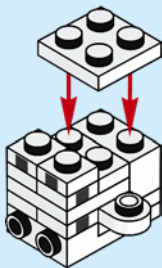

1x



1x

26

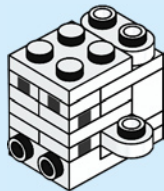



1x



1x



1x

27

1



2

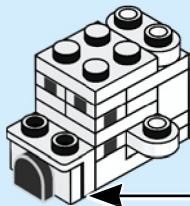



2x

28

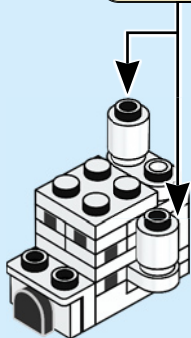
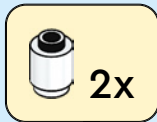

2x



1x

29

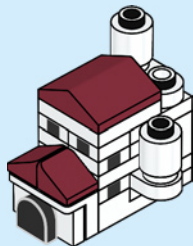



3x



3x

30



3x

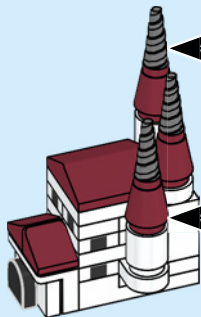

31

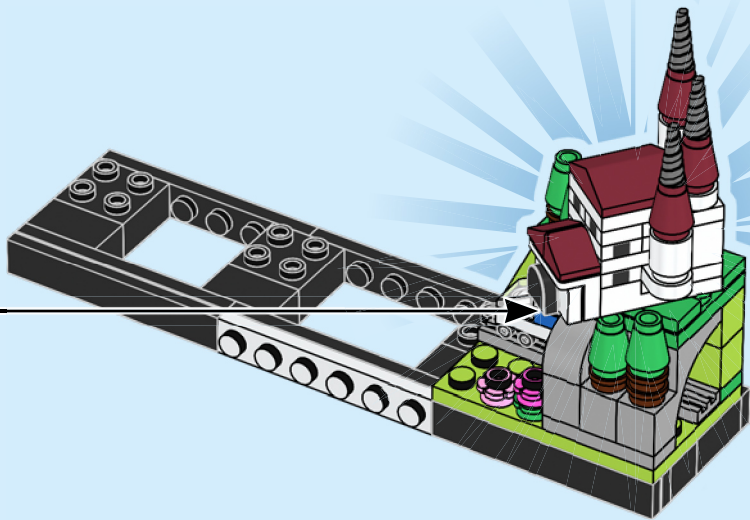

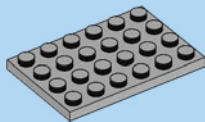
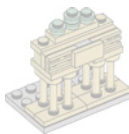

1x



1x

32

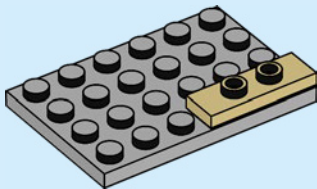



3x

33

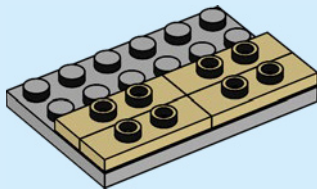

8x

34

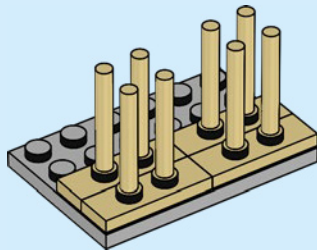

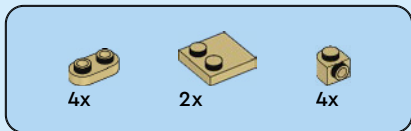

35

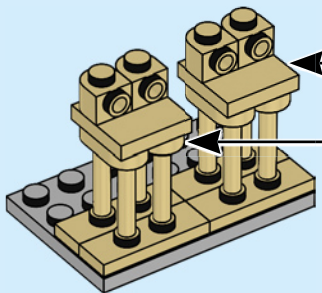
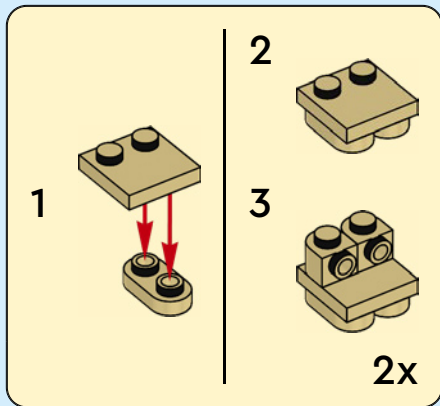

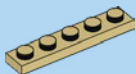

1x

36

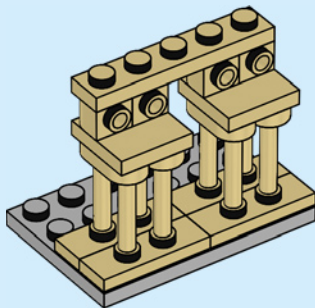

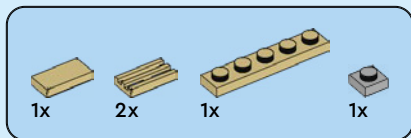

37

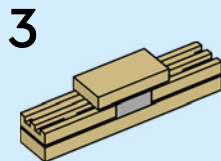
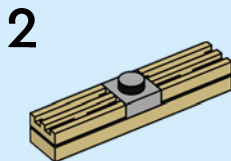
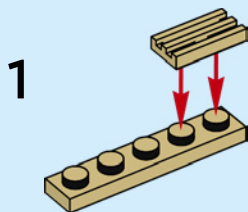

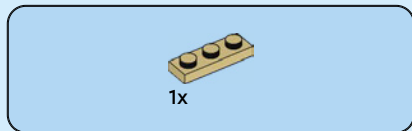
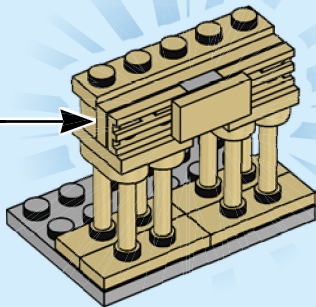

38

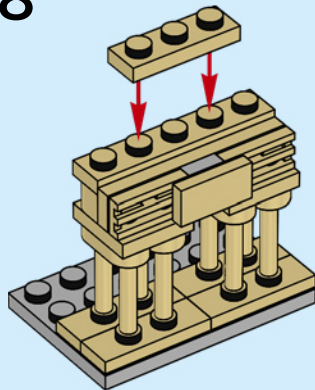



4x

39

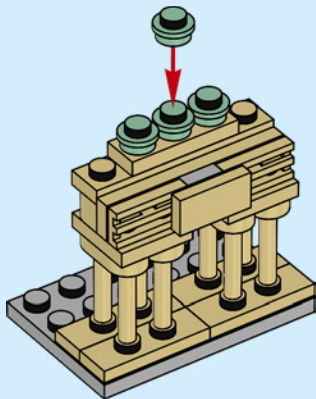

40

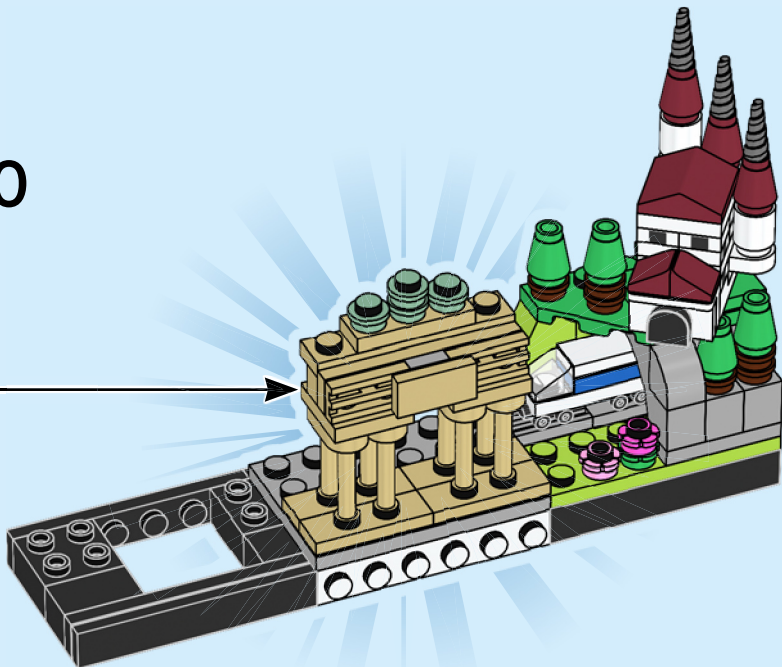

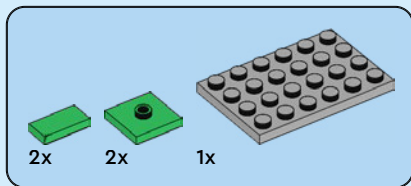

41

1

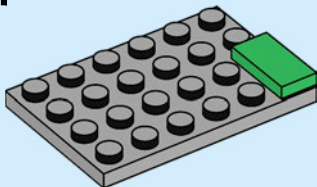

2

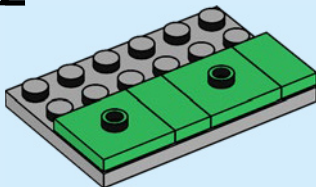

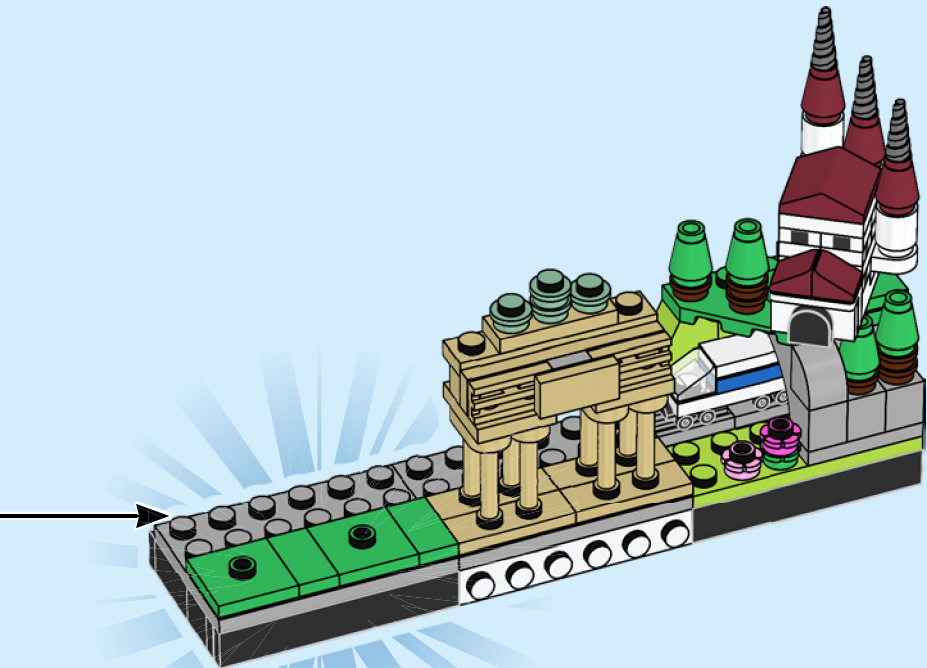

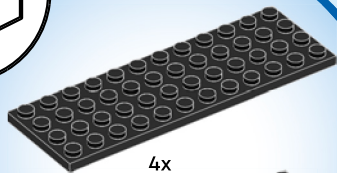
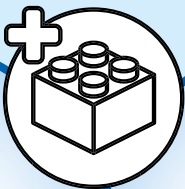

4x

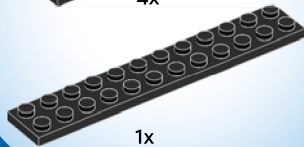

1x

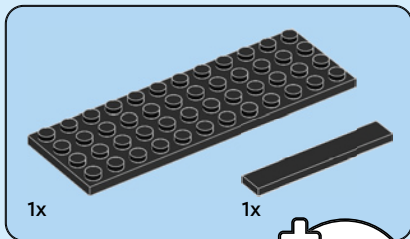
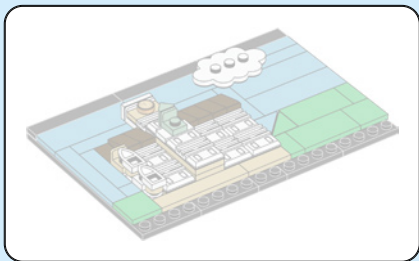

42

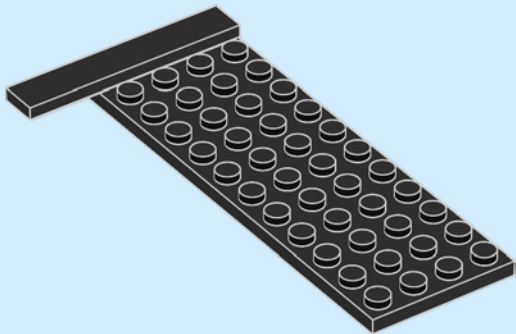
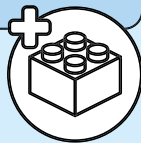

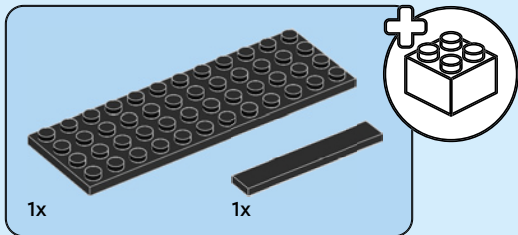

43

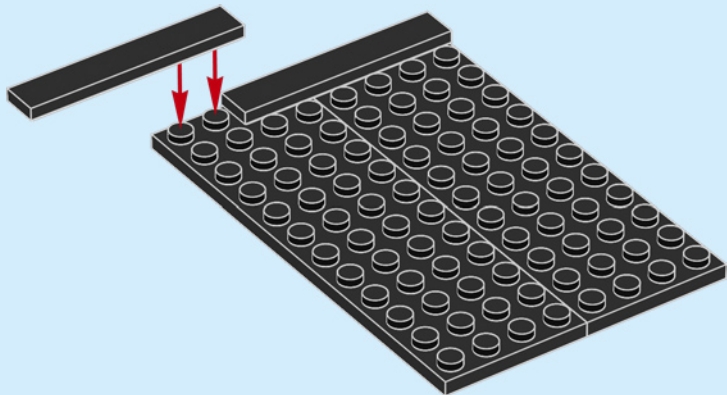

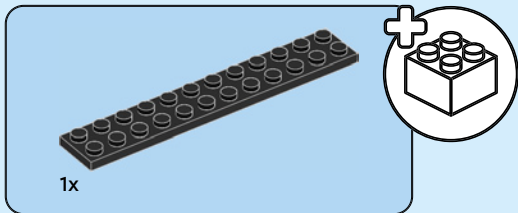

44

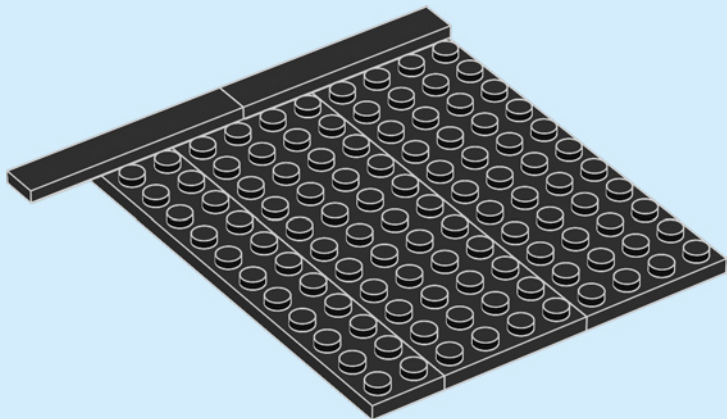

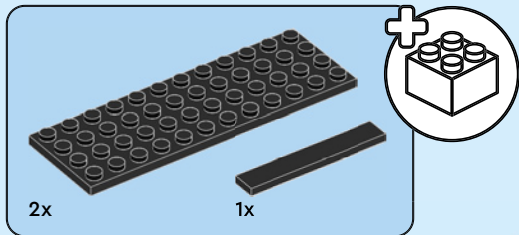

45

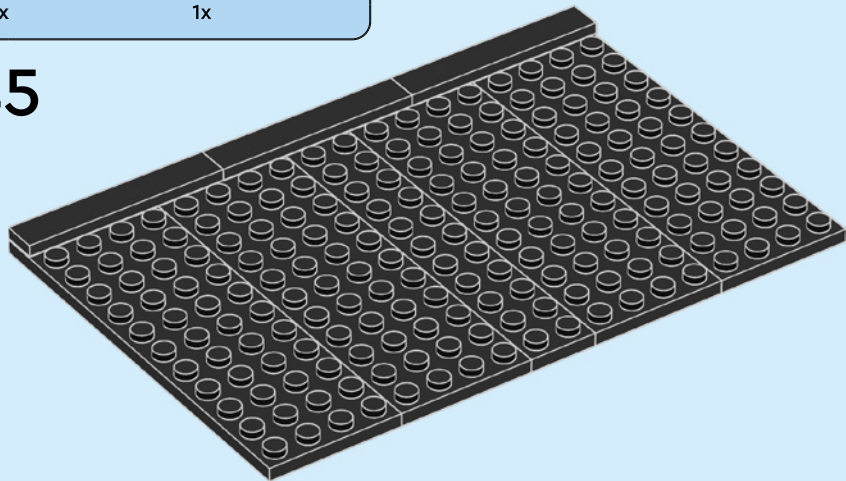

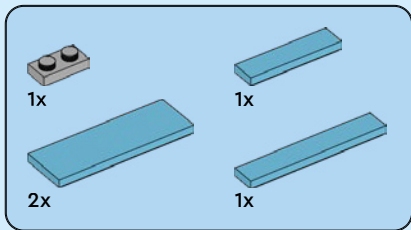

46

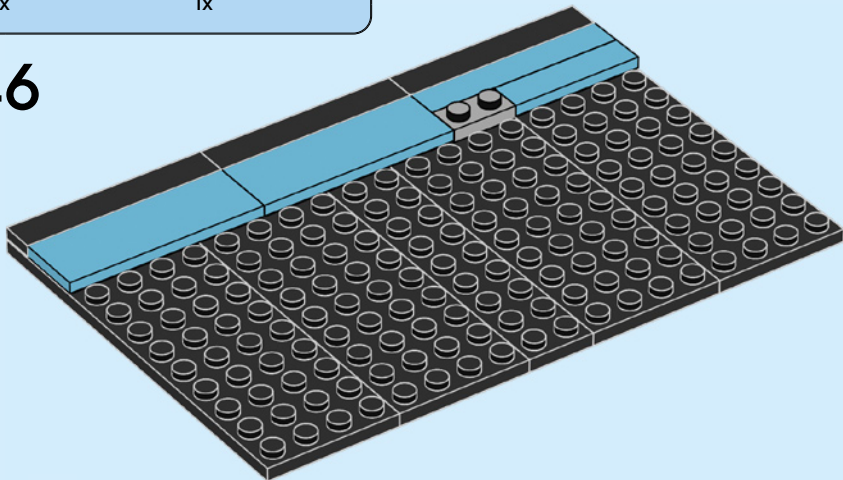

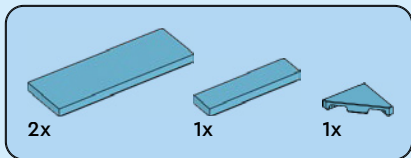

47

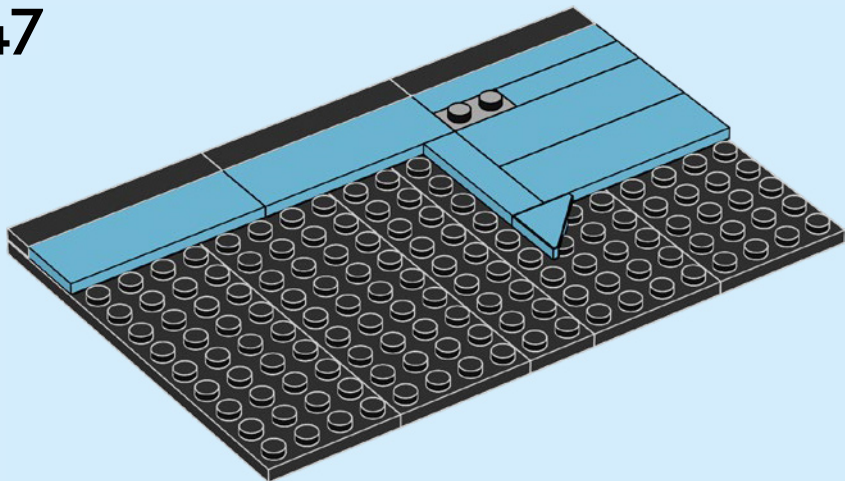

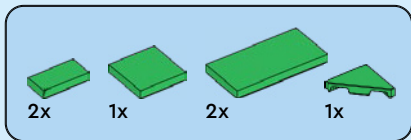

48

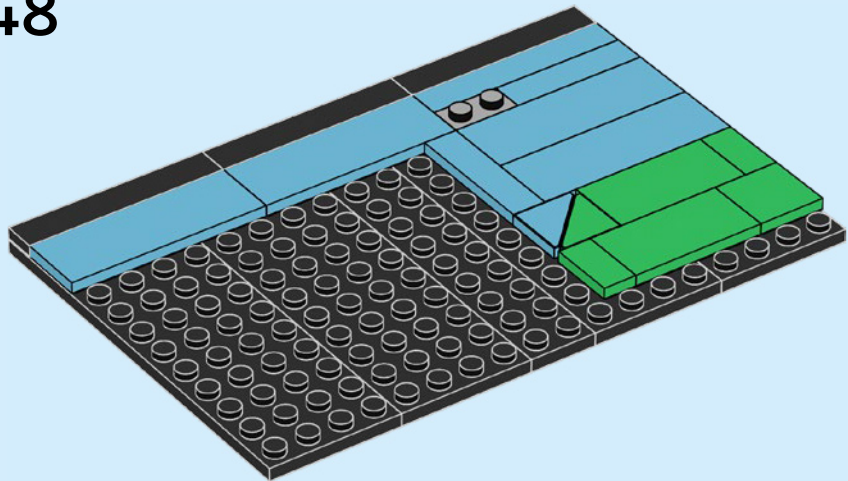

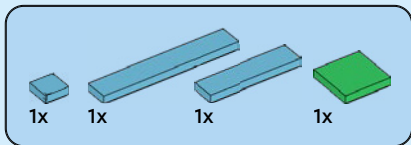

50

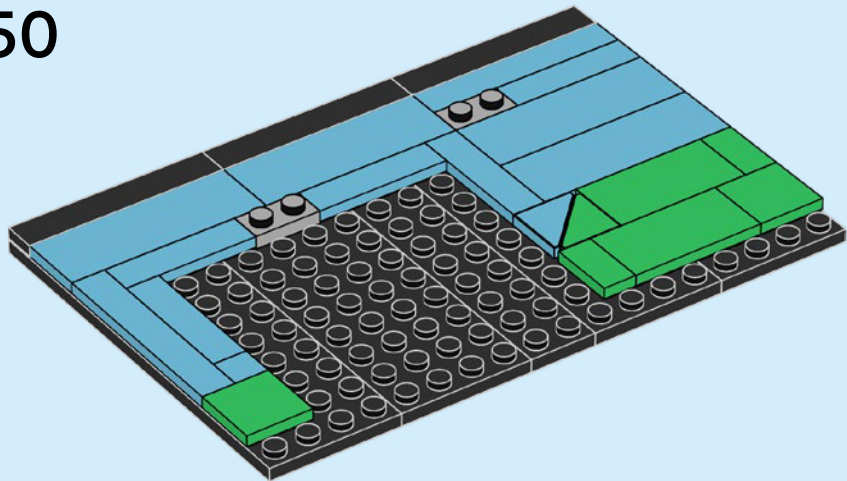

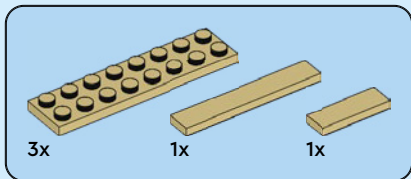

51

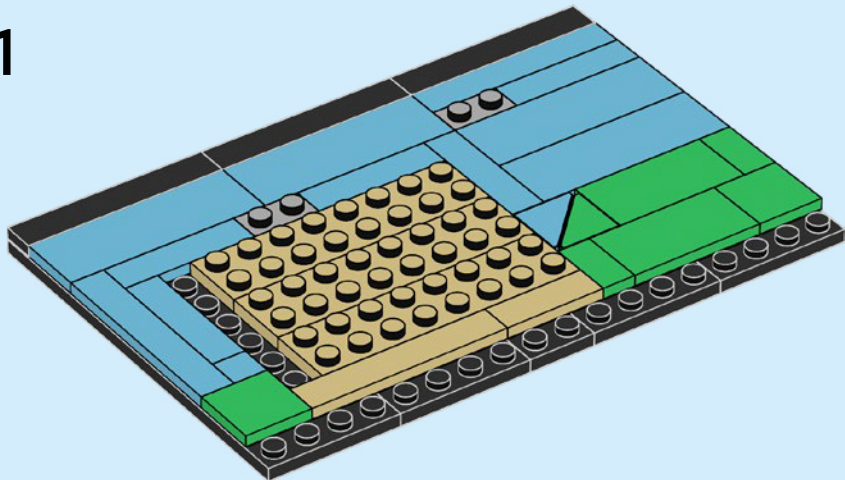



1x



1x



1x

52

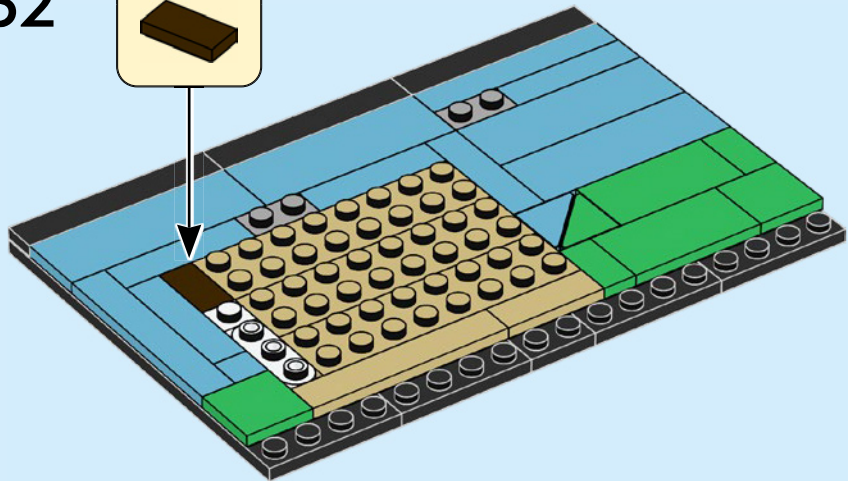



2x



2x



2x

53

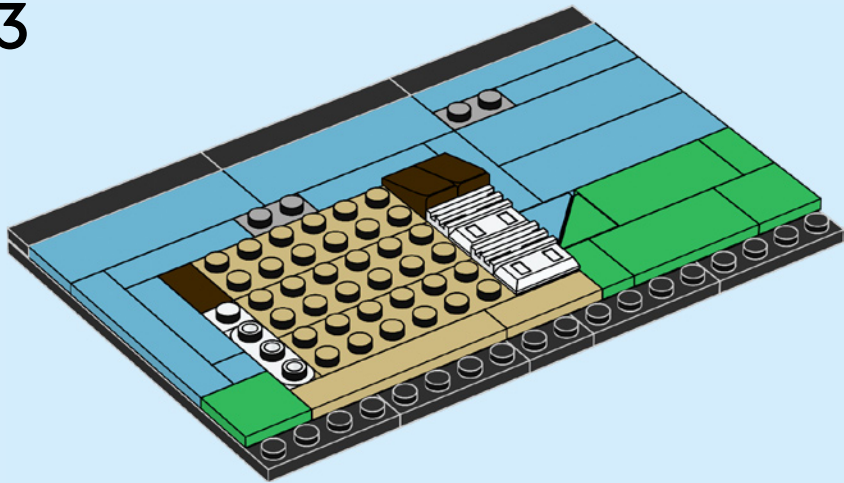



2x



2x



2x

54

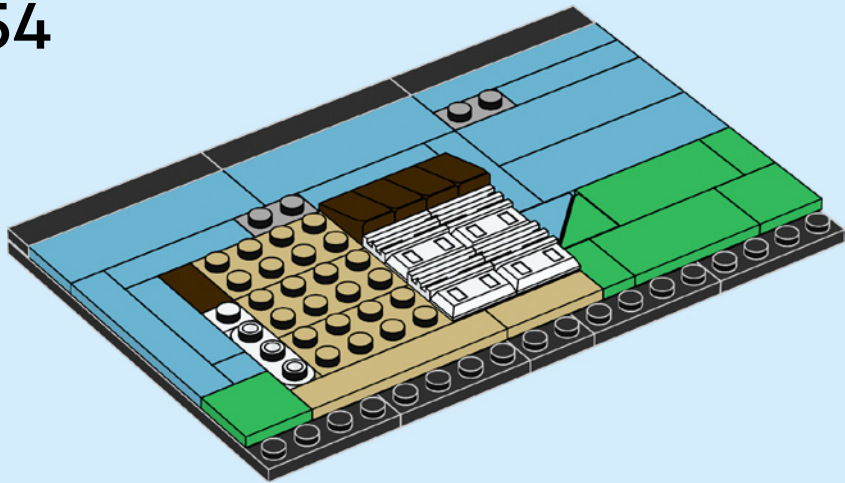



1x



1x



1x



1x

55

1

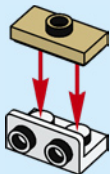

2

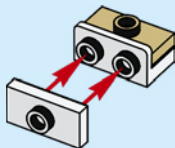

3



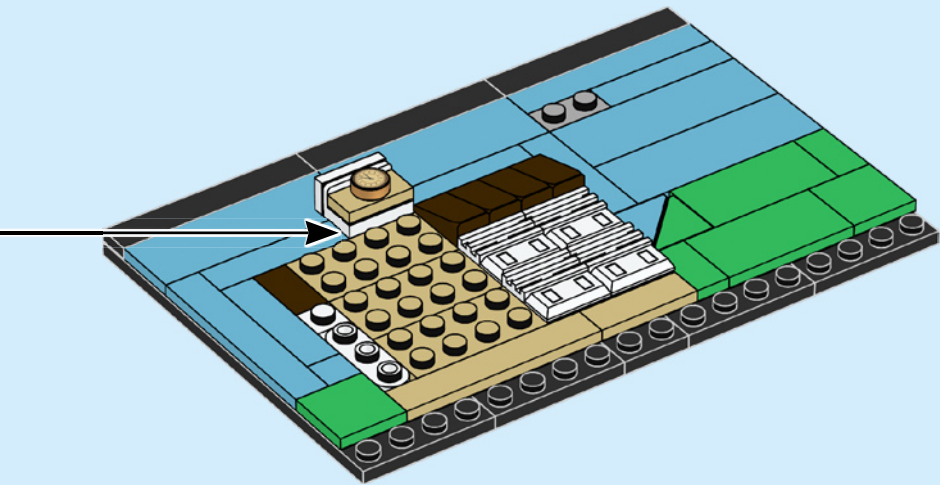

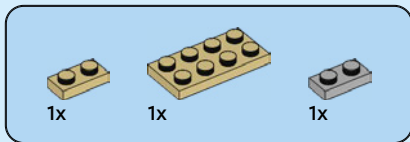

56

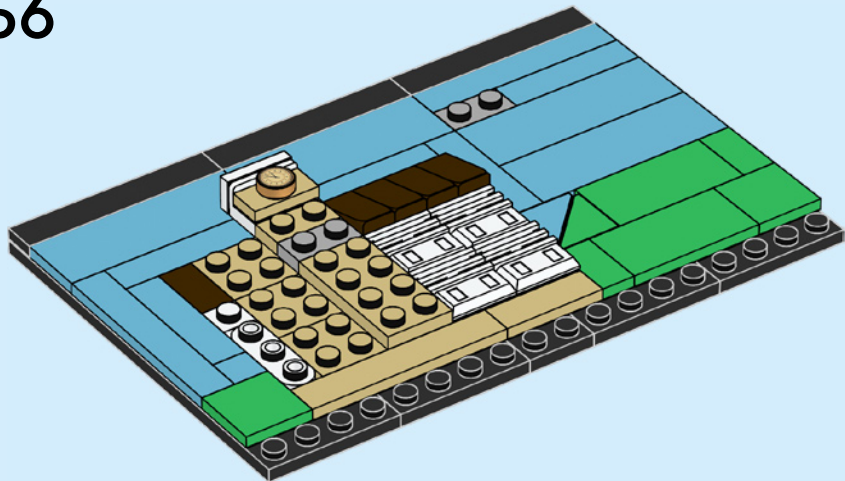



1x

57

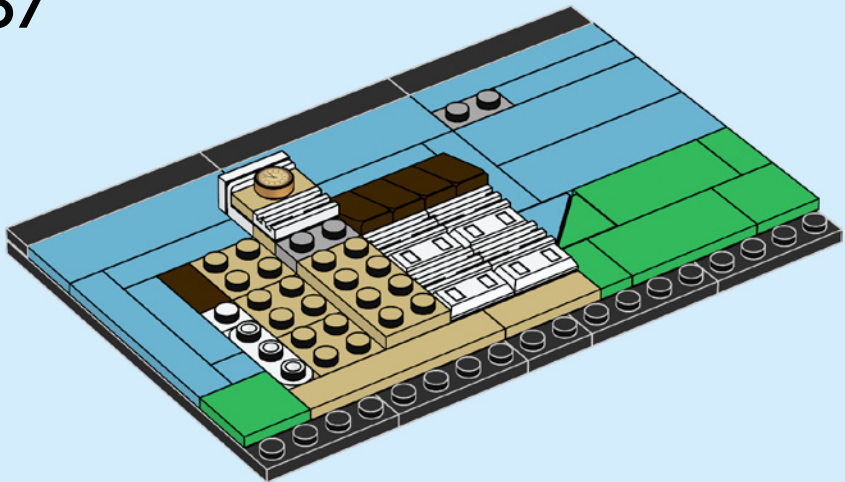



1x



1x

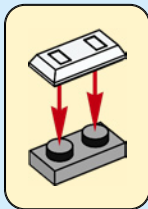

58

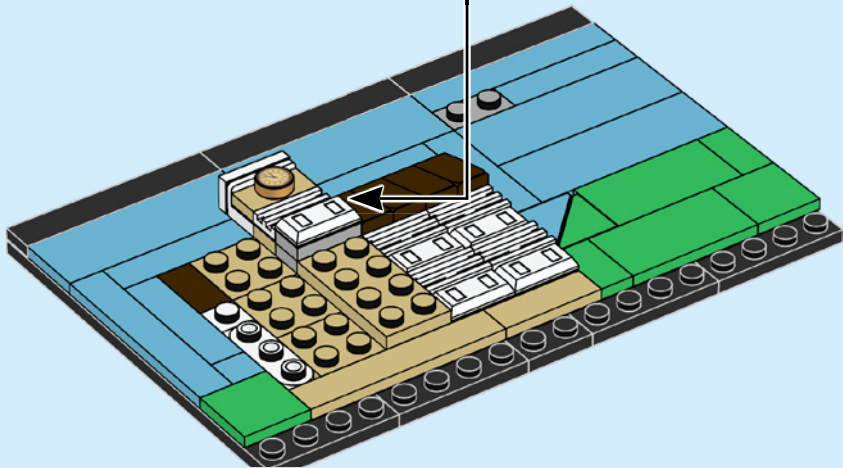



1x



1x

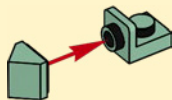

60

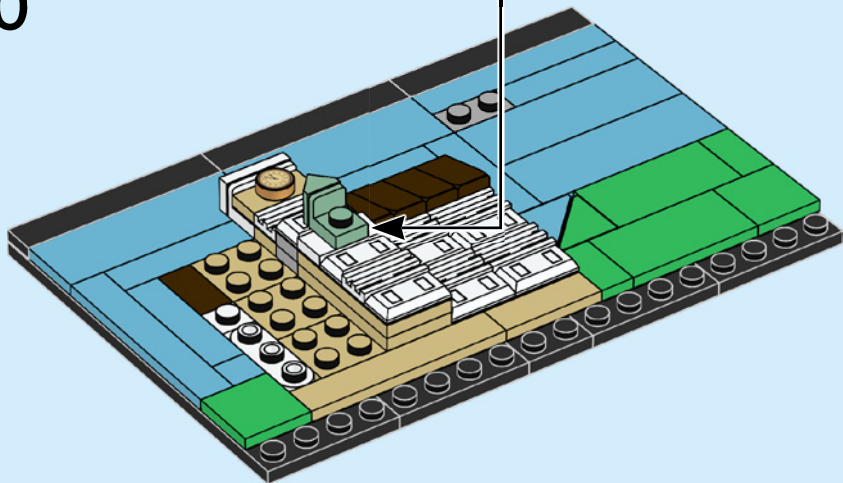



2x



2x



2x

61

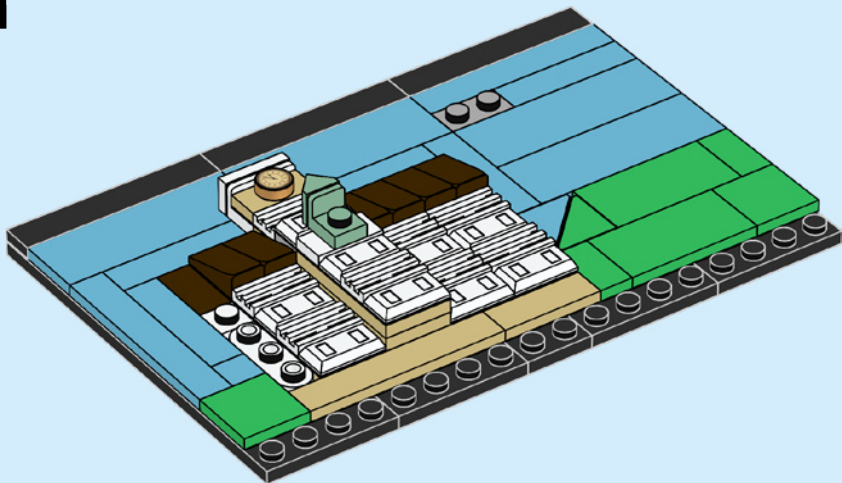



1x



1x



2x

62

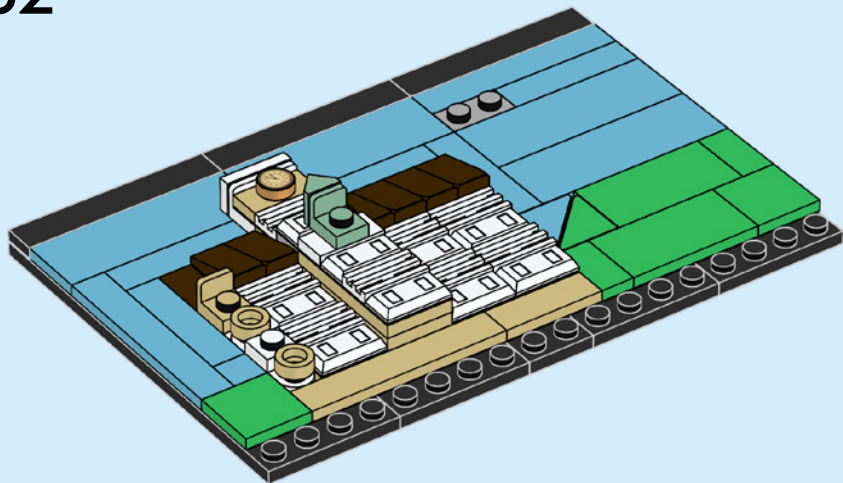



2x

63

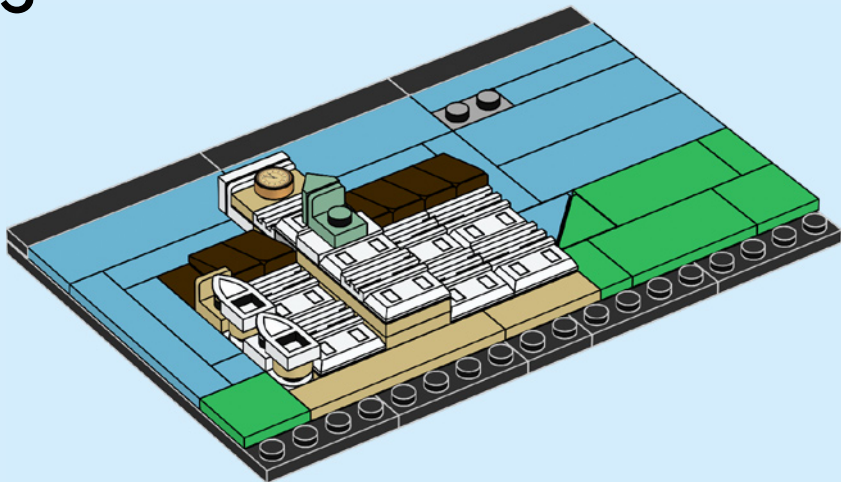



1x

64

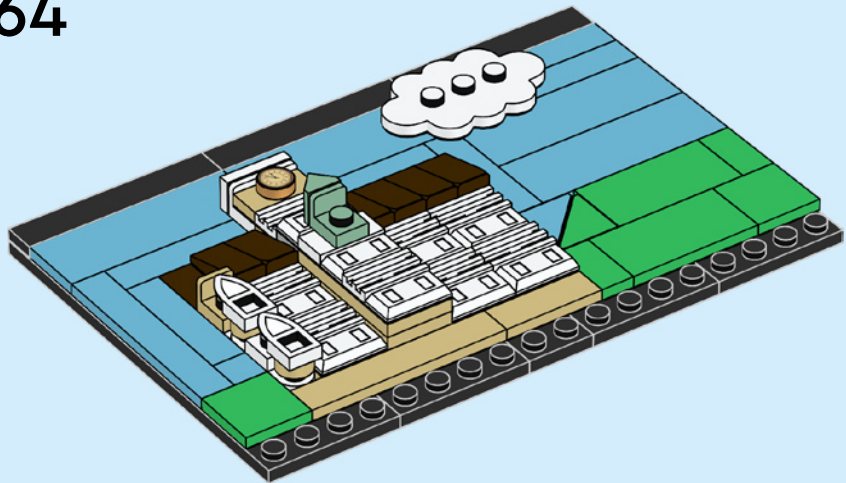

65

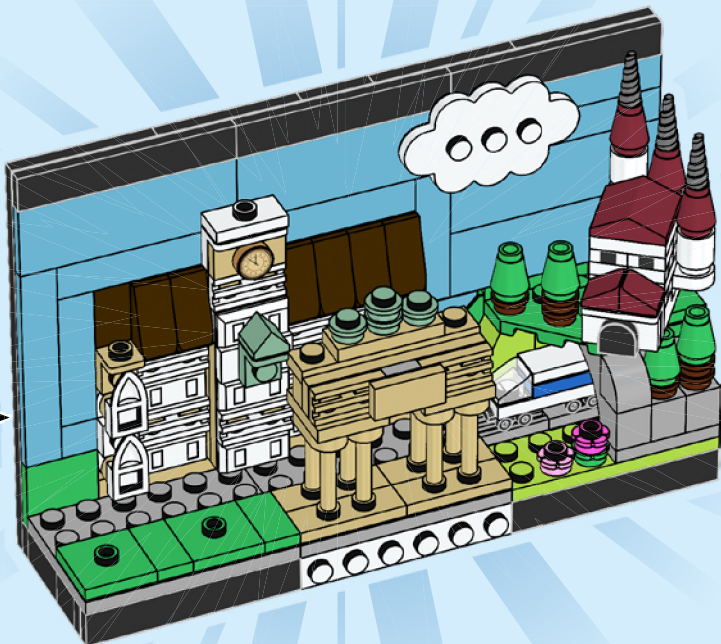



3x



1x

66

1

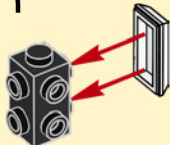

2

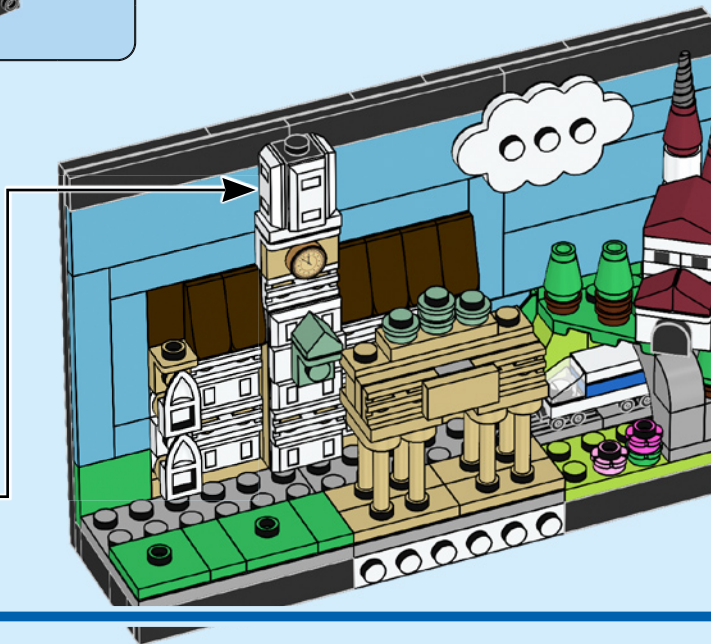



2x



2x

67



2x





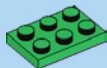

1x



1x

68

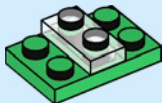

4x

69

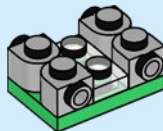



2x

70

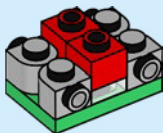

2x

71

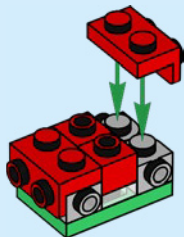



2x



1x

72

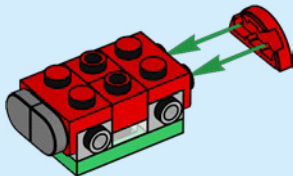



1x



1x

73

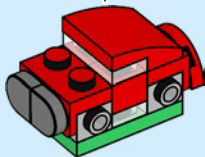
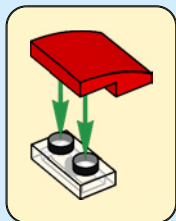

4x

74

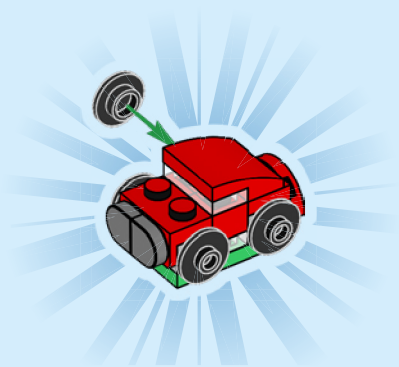

75

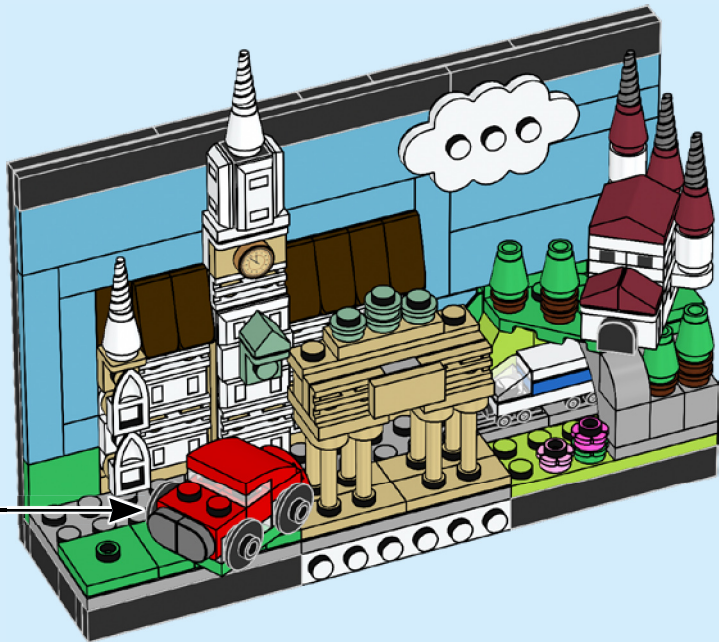

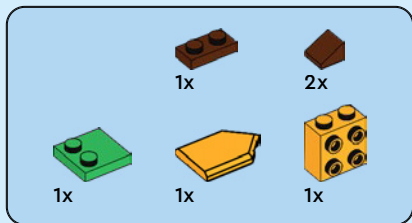

76

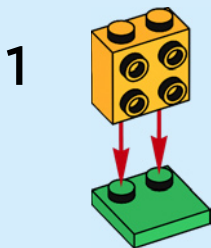

2



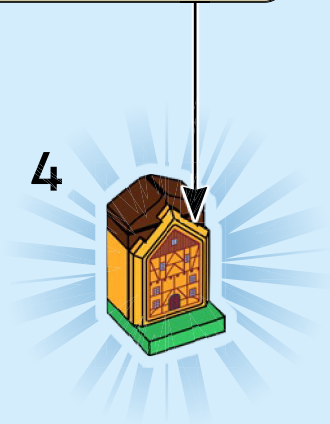
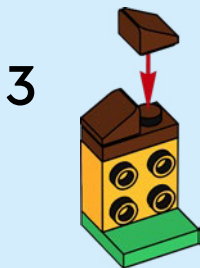
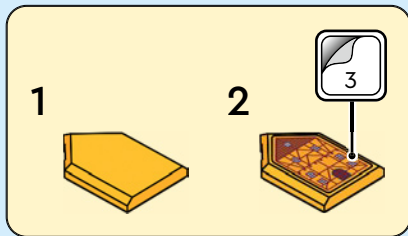

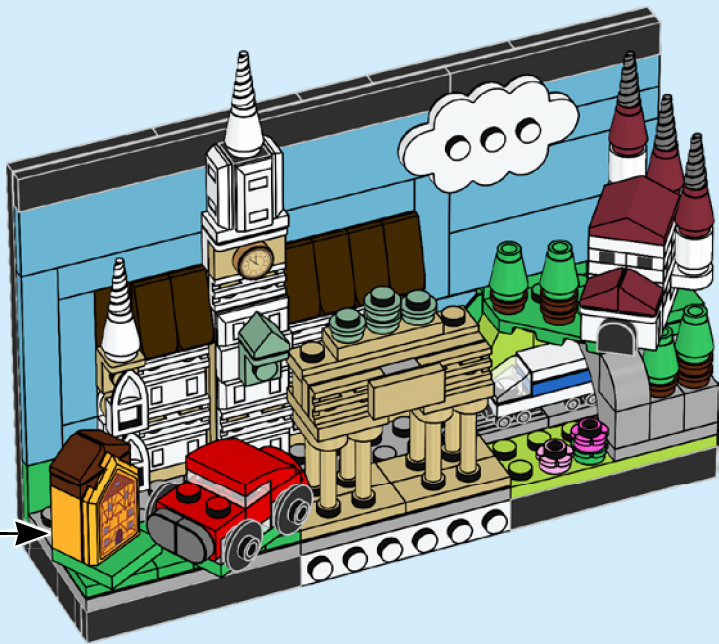

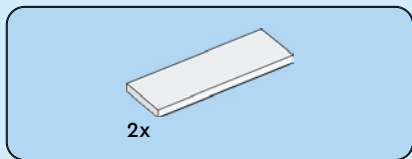

77

1

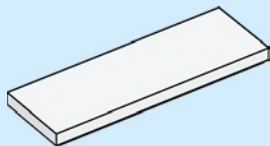

2



1

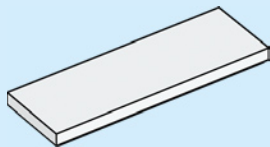

2



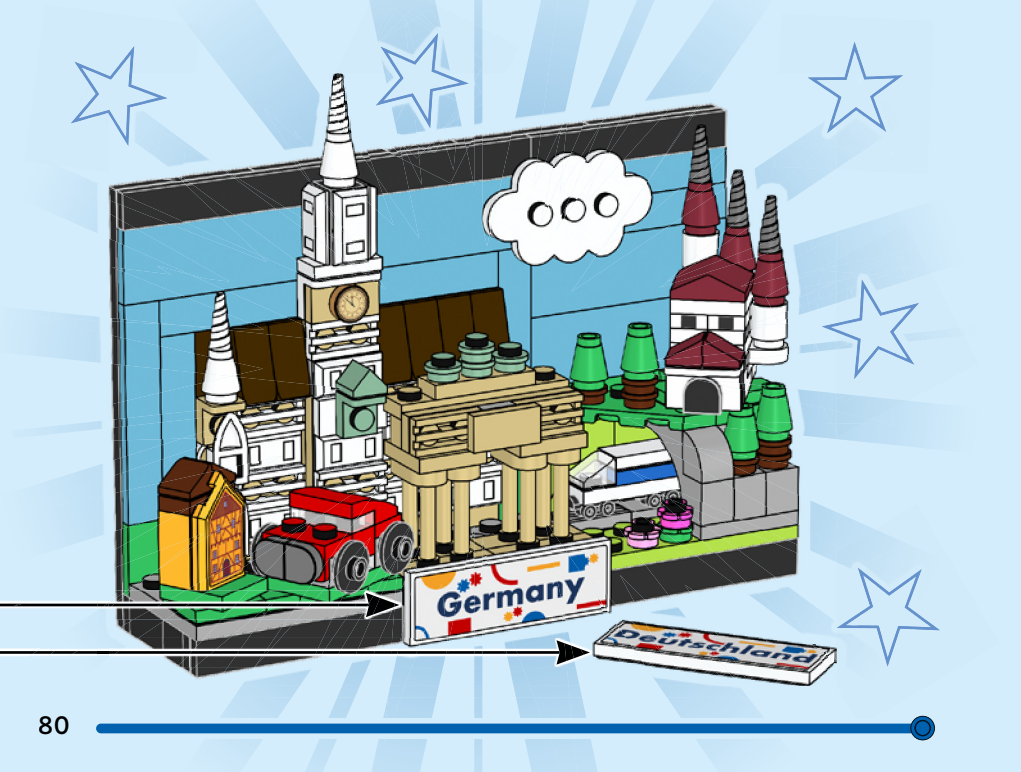



2x
6192793



2x
306201



2x
4518400



4x
6202501



2x
302401



2x
4224792



2x
6210272



8x
241201



12x
6210076



1x
300401



2x
302301



3x
6051511



1x
306901



2x
6070698



1x
6450820



4x
302201



1x
242001



1x
6469441



1x
362301



1x
6223667



1x
366601

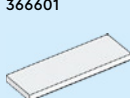

2x
6332042



2x
6463667



4x
6454934



1x
6365720



4x
6212758



1x
4113917



1x
6092587



2x
4124456



1x
4114026



8x
6443062



2x
6221467



4x
6211966



1x
6131896



1x
4121921



2x
4114309



2x
6351905



1x
4157277

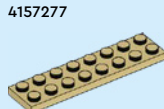

3x
4113988



2x
6397571



1x
6516544



2x
6319330



1x
6105976



1x
302323



1x
6256435



2x
6088585



4x
6508152



1x
6602161



4x
6275806



4x
300426



5x
663626



6x
366626

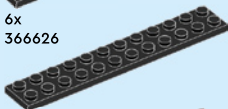

1x
244526

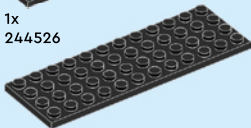

4x
302926



3x
6135287



4x
4529239



7x
306928



1x
6385265



2x
6389692



2x
4107762



1x
6505153



1x
6529282



2x
302128



2x
4566179



1x
366628



1x
6245250



2x
6514001



1x
6534880



2x
4234716

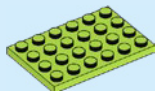

1x
6060848



4x
6403175



1x
6579025



1x
6390504



3x
4541498



2x
4531415



1x
6407992



1x
6523916



1x
6340721



6x
4216581



2x
4504376



1x
4211150



4x
6448793



1x
4211399



1x
6522869



4x
4211398



2x
4211350



1x
6066097



1x
4211429



3x
6585102

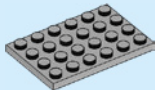

2x
4211404



2x
6362252



3x
6445056



1x
6209679



1x
6212501



1x
6372427



6x
6509391



1x
4566688



1x
4655243



1x
6347670



5x
4624705

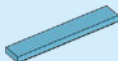

2x
6185309

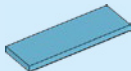

4x
6472014



[LEGO.com/service](https://www.lego.com/service)

YOU COULD **WIN**



Scan this QR code or go to **LEGO.COM/PRODUCTFEEDBACK** and give us your short feedback about this LEGO® set for a chance to win a cool LEGO prize.

Terms and Conditions apply*

EN: YOU COULD WIN. Terms and Conditions apply* **DE: Du könntest GEWINNEN.** Es gelten die Teilnahmebedingungen* **FR: TU POURRAIS GAGNER.** Des conditions s'appliquent* **IT: Potresti VINCERE tu.** Termini e condizioni sono applicabili* **ES: PUEDES GANAR.** Aplican términos y condiciones* **PT: PODERÁ GANHAR.** Aplicam-se Termos e Condições* **ZH: 轻松获奖.** 条款和条件适用* **PL: Szansa na WYGRANA.** Obowiązuje regulamin* **CS: Máte šanci VYHRÁT.** Platí všeobecné smluvní podmínky* **SK: Máte šancu VYHRÁŤ.** Platia všeobecné zmluvné podmienky* **HU: TE IS NYERHETSZ!** Felhasználási feltételek érvényesek* **UA: ВИ МОЖЕТЕ ВИГРАТИ.** Застосовуються загальні положення та умови* **RO: Ai putea CÂȘTIGA.** Se aplică termenii și condițiile* **BG: Можете да СПЕЧЕЛИТЕ.** Има определени правила и условия* **LV: Tu vari LAIMĒT.** Ir spēkā noteikumi un nosacījumi.* **ET: Sul on võimalus VÕITA.** Kehtivad tingimused* **LT: Jūs galite LAIMĖTI.** Taikomos sąlygos* **TR: KAZANABİLİRSİN.** Şartlar ve Koşullar geçerlidir*

*[LEGO.com/productfeedback-terms](https://www.lego.com/productfeedback-terms)

LEGO and the LEGO logo are trademarks of the/sonnt des marques de commerce du/son marcas registradas de LEGO Group. 2026 The LEGO Group.

 6640729