



40890



LEGO® Builder



### **Get excited about our new packaging!**

We're switching from plastic to paper-based packaging. That's why you might find a mix of paper and plastic in our boxes!

### **Nos nouveaux emballages vous emballeront !**

Nous passons des emballages en plastique aux emballages à base de papier. C'est pourquoi vous pourriez trouver un mélange de papier et de plastique dans nos boîtes !

### **¡Te presentamos nuestros nuevos empaques!**

Estamos sustituyendo las bolsas de plástico por bolsas con base de papel. ¡Por eso, puedes encontrar una mezcla de papel y de plástico en nuestras cajas!

**[LEGO.com/sustainable-packaging](https://www.lego.com/sustainable-packaging)**



Q LEGO® Builder

# BUILDER



Apple and the Apple logo are trademarks of Apple Inc., registered in the U.S. and other countries and regions. App Store is a service mark of Apple Inc. Google Play and the Google Play logo are trademarks of Google LLC. Tencent and the Tencent logo are trademarks of Tencent Inc.

Q [LEGO.com/devicecheck](https://www.lego.com/devicecheck)

**EN** Ask parents' permission before going online | **DE** Eltern um Erlaubnis bitten, bevor du online gehst | **FR** Demande l'autorisation d'un parent avant d'aller en ligne | **IT** Chiedi il permesso ai tuoi genitori prima di andare online | **ES** Pídeles permiso a tus papás antes de conectarte a Internet | **PT** Pede autorização aos pais antes de acederes online | **ZH** 上网前应先征得父母的同意 | **PL** Poproś rodziców o zgodę, zanim wejdiesz do Internetu | **CS** Než půjdeš na internet, požádej rodiče o svolení | **SK** Skôr než pôjdeš na internet, vypýtaj si povolenie od rodičov | **HU** Kérj szülői engedélyt, mielőtt online csatlakoznál! | **UA** Запитуйте дозволу батьків, перш ніж користуватися інтернетом | **RO** Cere permisiunea părinților înainte de a te conecta online | **BG** Поискайте разрешение от родител, преди да влезете онлайн | **LV** Pirms došanās tiešsaistē palūdz atļauju vecākiem | **ET** Enne Interneti kasutamist küsi vanematelt luba | **LT** Prieš prisijungdami prie interneto, atsiklauskite tėvų





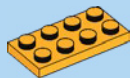

1x



1x

1

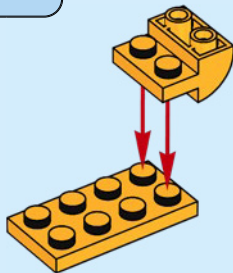



1x



1x

2

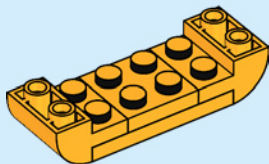

3

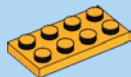

1x

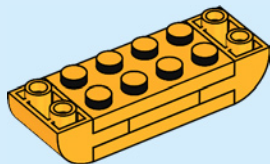

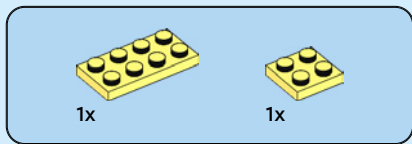

4

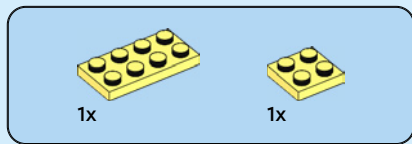
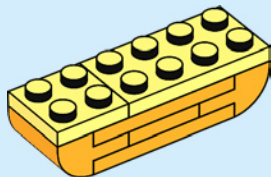

5

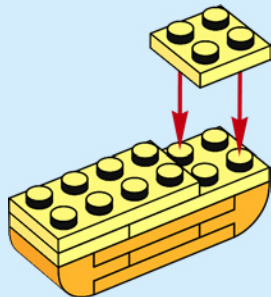

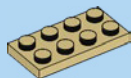

1x

6

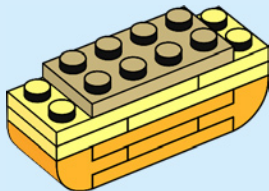

2x

7

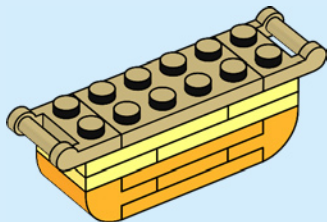

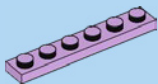

1x

8

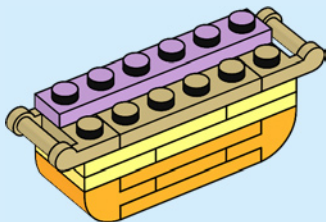

2x

9

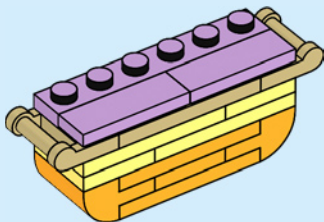



2x



1x

# 10

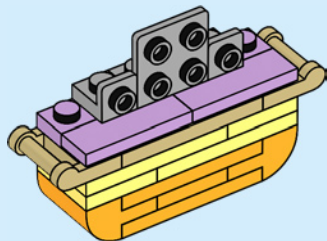

2x

# 11

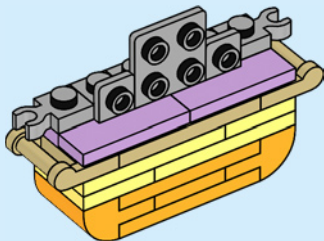

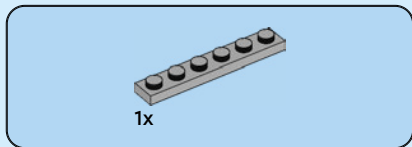

12

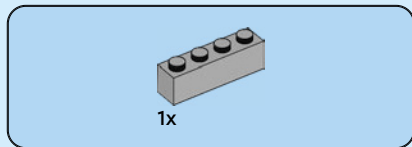
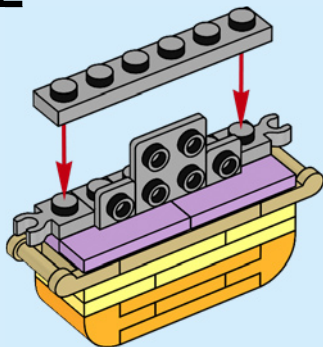

13

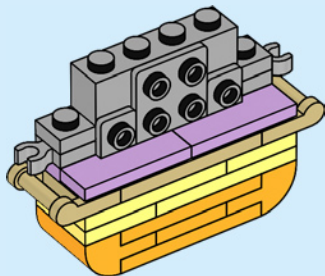



1x

14

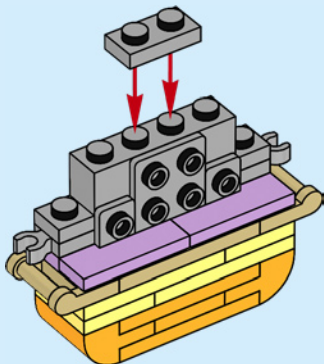



2x

15

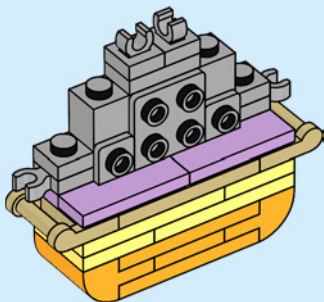

2x

16

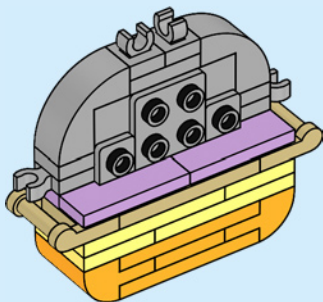

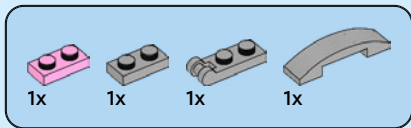

17

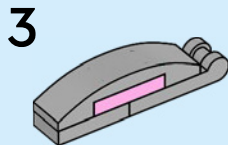
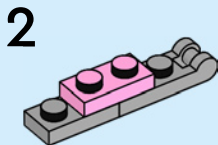
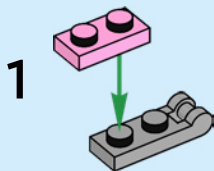

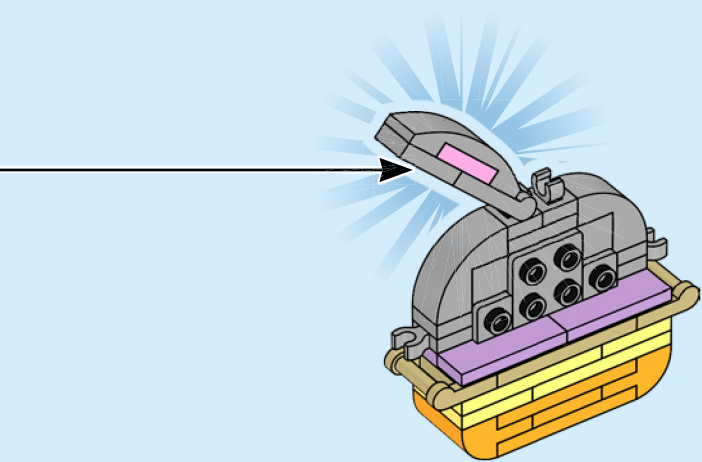

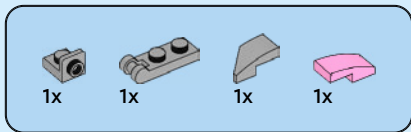

# 18

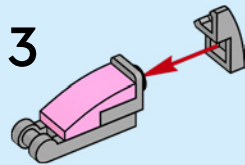
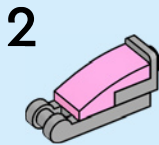
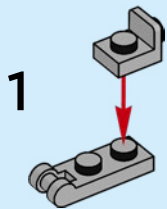

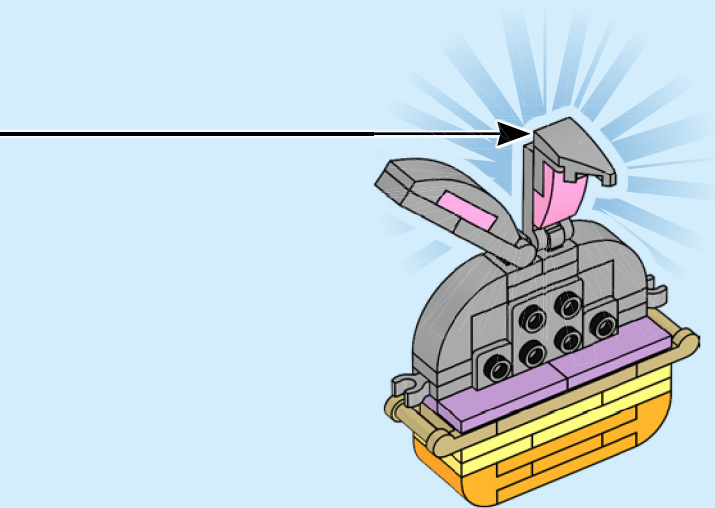



2x



1x

# 19

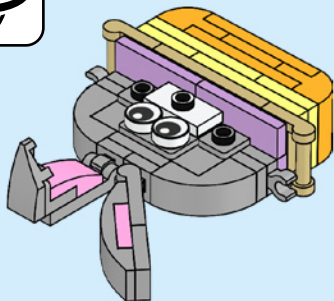
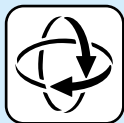

1x



2x

# 20

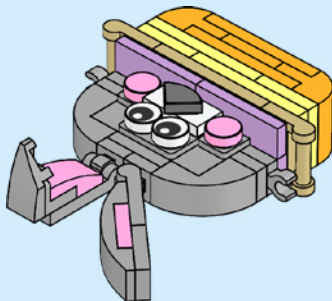



2x



2x

21

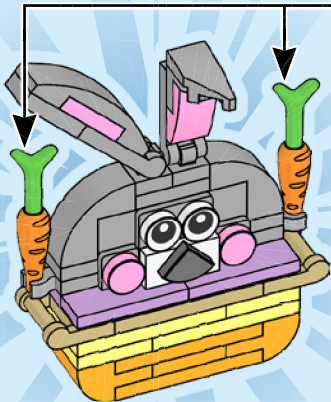

2x

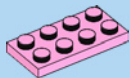

1x



1x

1

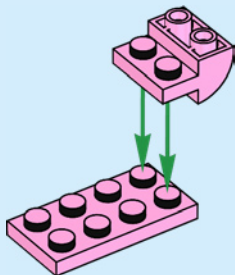

1x



1x

2

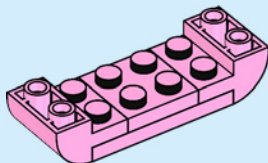

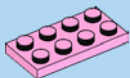

1x

3

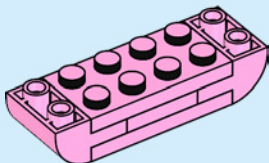

1x

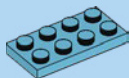

1x

4

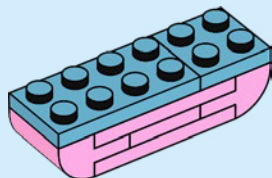



1x

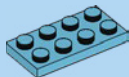

1x

5

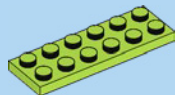
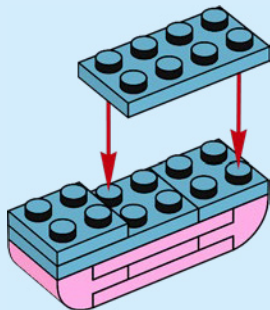

1x

6

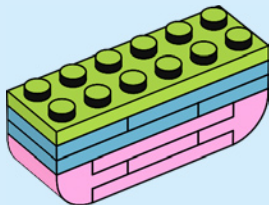



3x

7

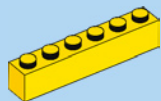
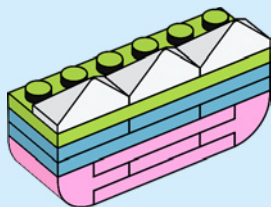

1x

8

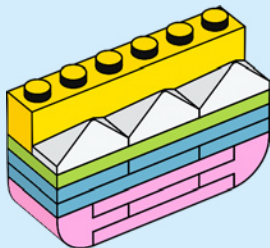



2x



1x

9

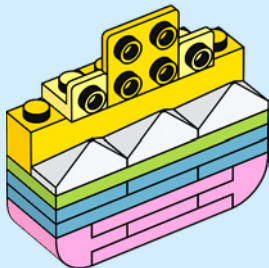



2x

10

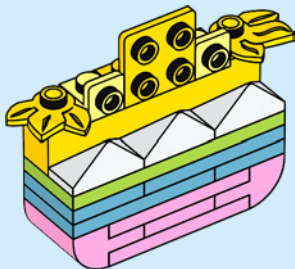

1x

11

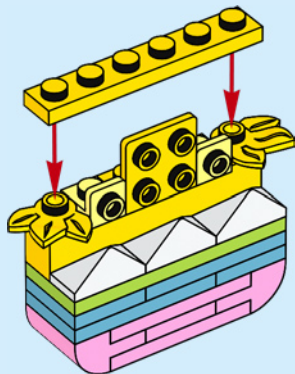

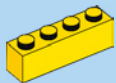

1x

12

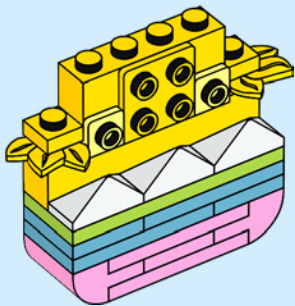



2x

13

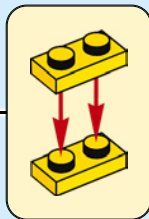
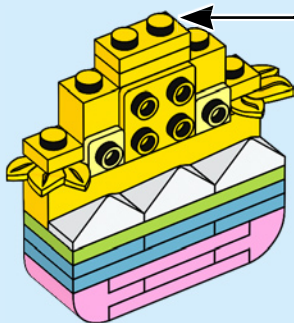



2x

14

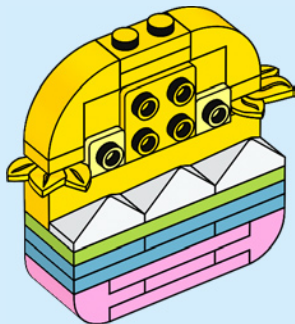



15

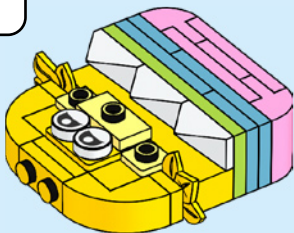

16

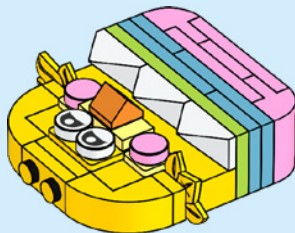



1x

17

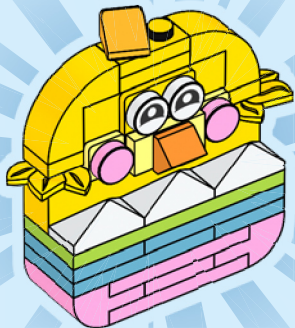

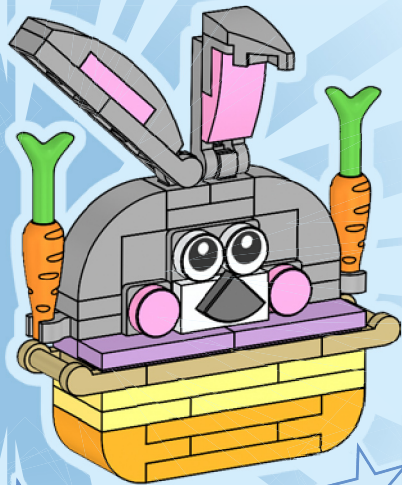
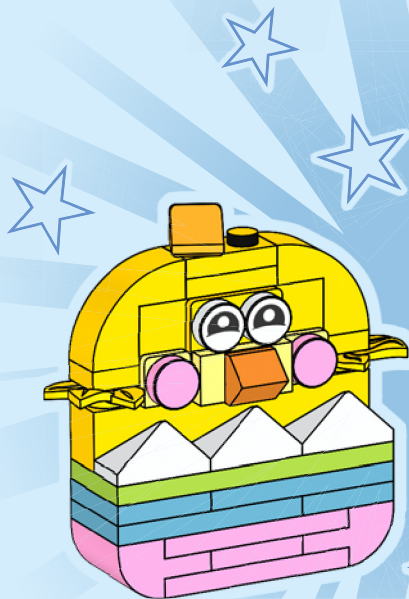



LEGO and the LEGO logo are trademarks of the/son des marques de commerce du/  
son marcas registradas de LEGO Group. ©2026 The LEGO Group.



6633645